

# ENDF/B-VII.1 PU-244

## Principal cross sections

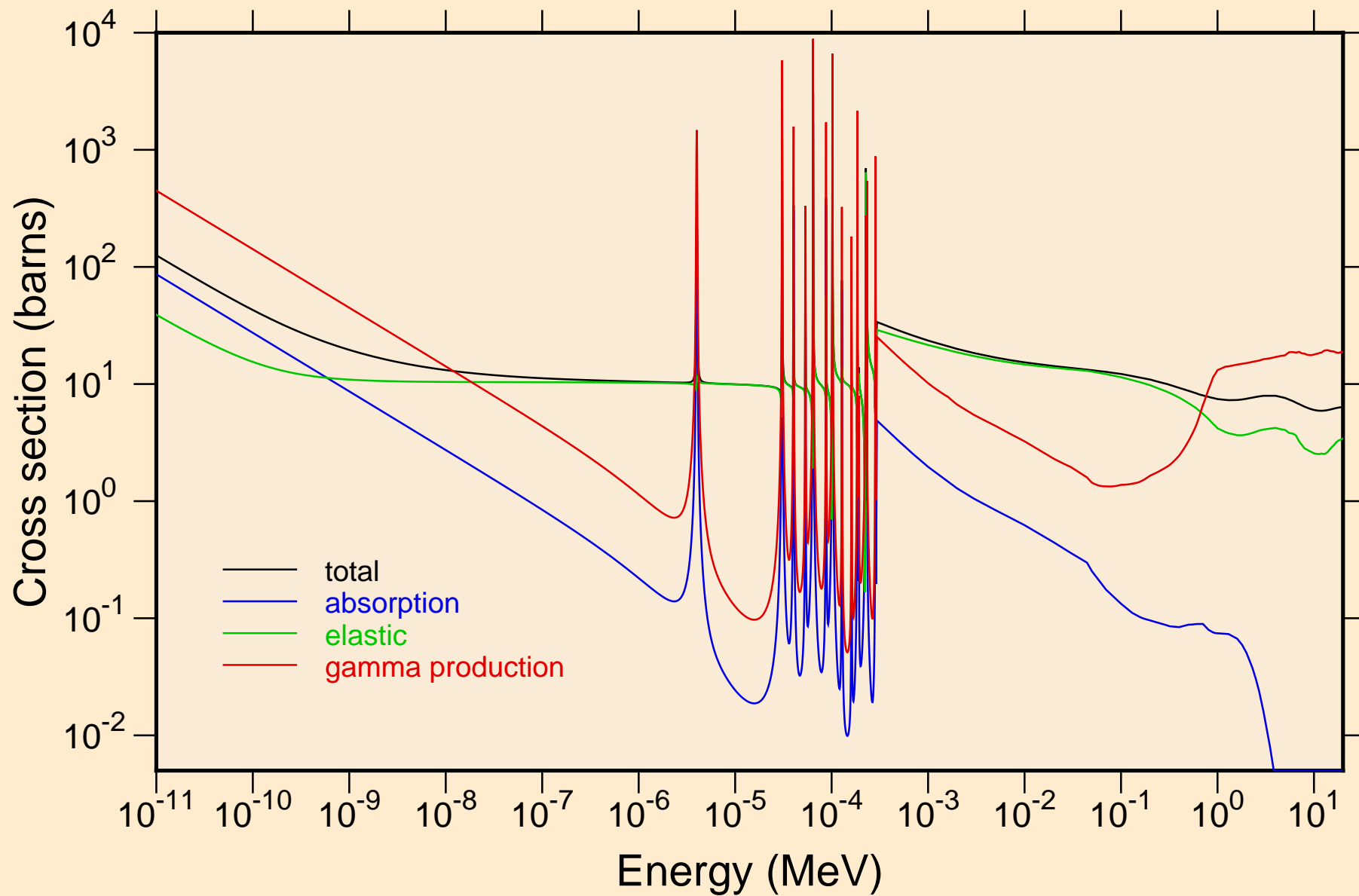

ENDF/B-VII.1 PU-244  
resonance total cross section

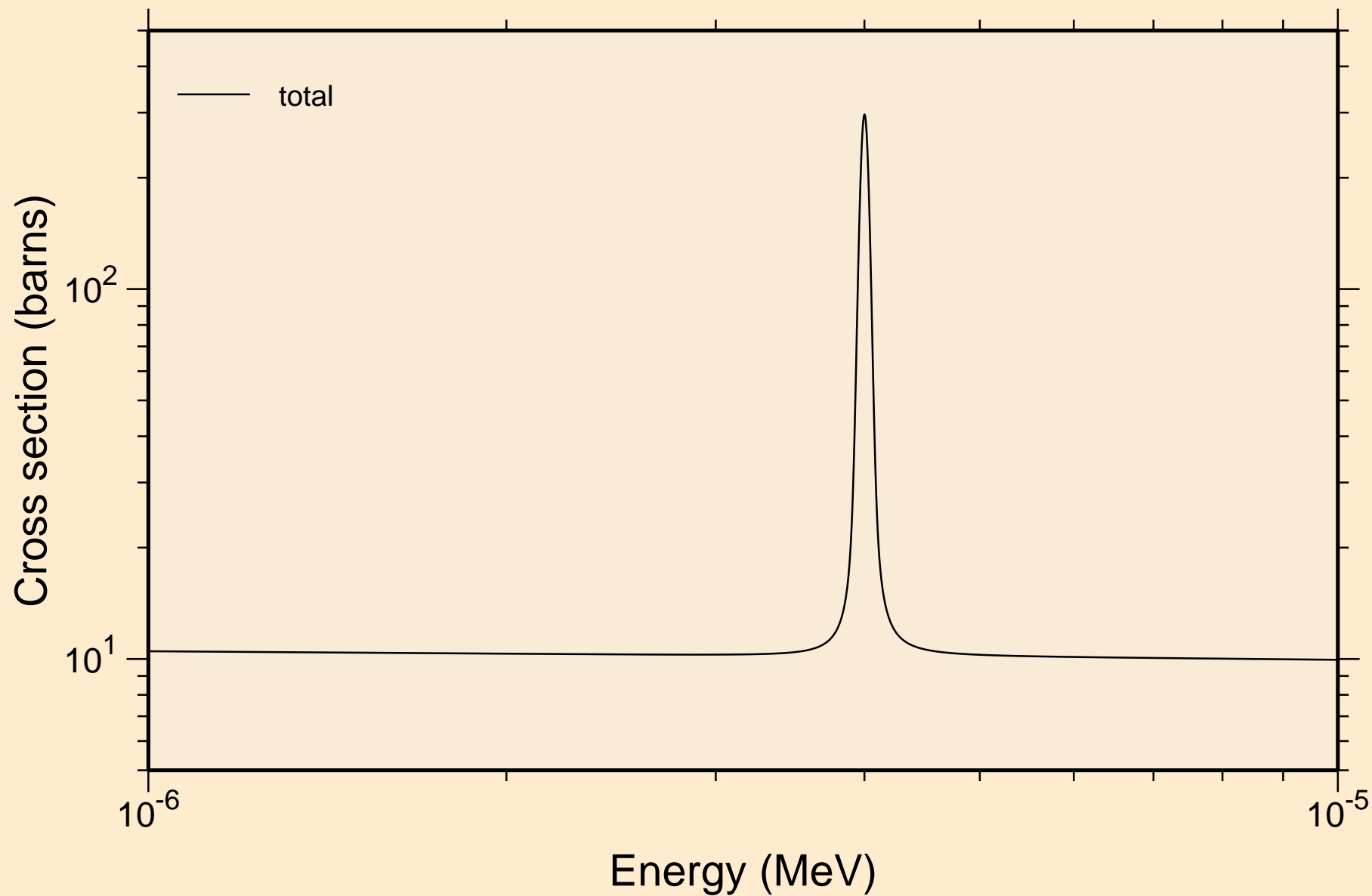

ENDF/B-VII.1 PU-244  
resonance total cross section

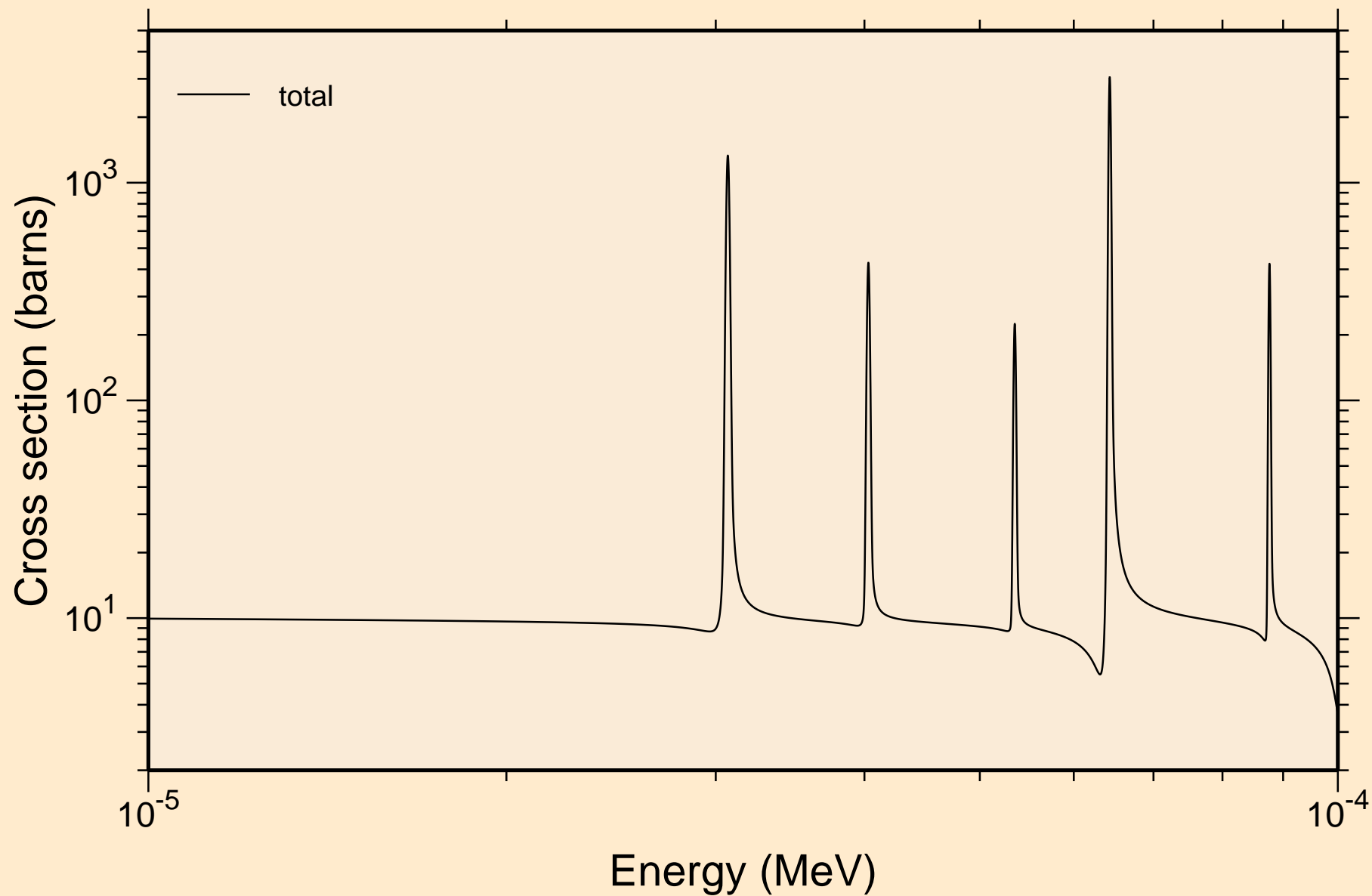

ENDF/B-VII.1 PU-244  
resonance total cross section

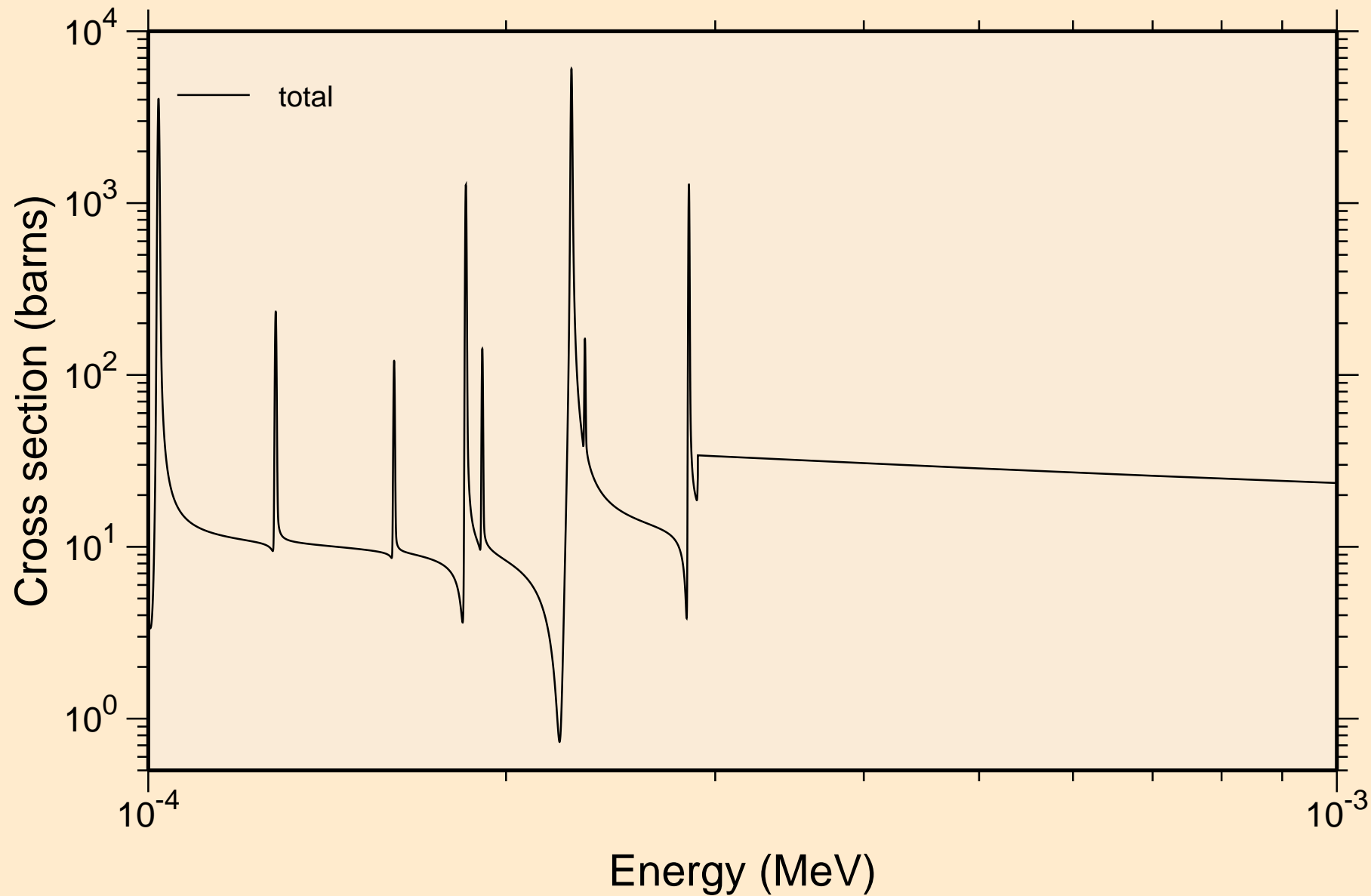

# ENDF/B-VII.1 PU-244 resonance absorption cross sections

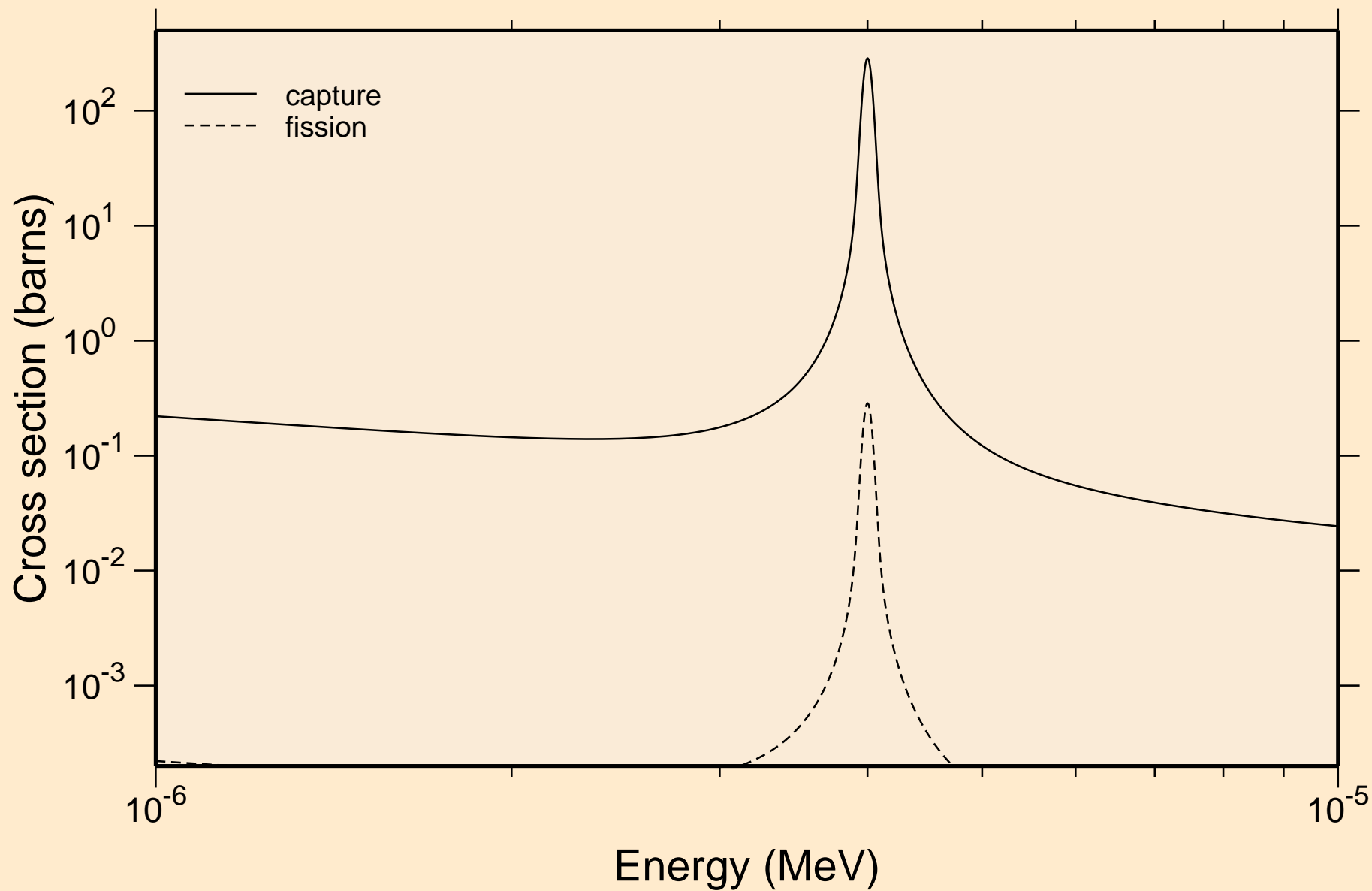

# ENDF/B-VII.1 PU-244 resonance absorption cross sections

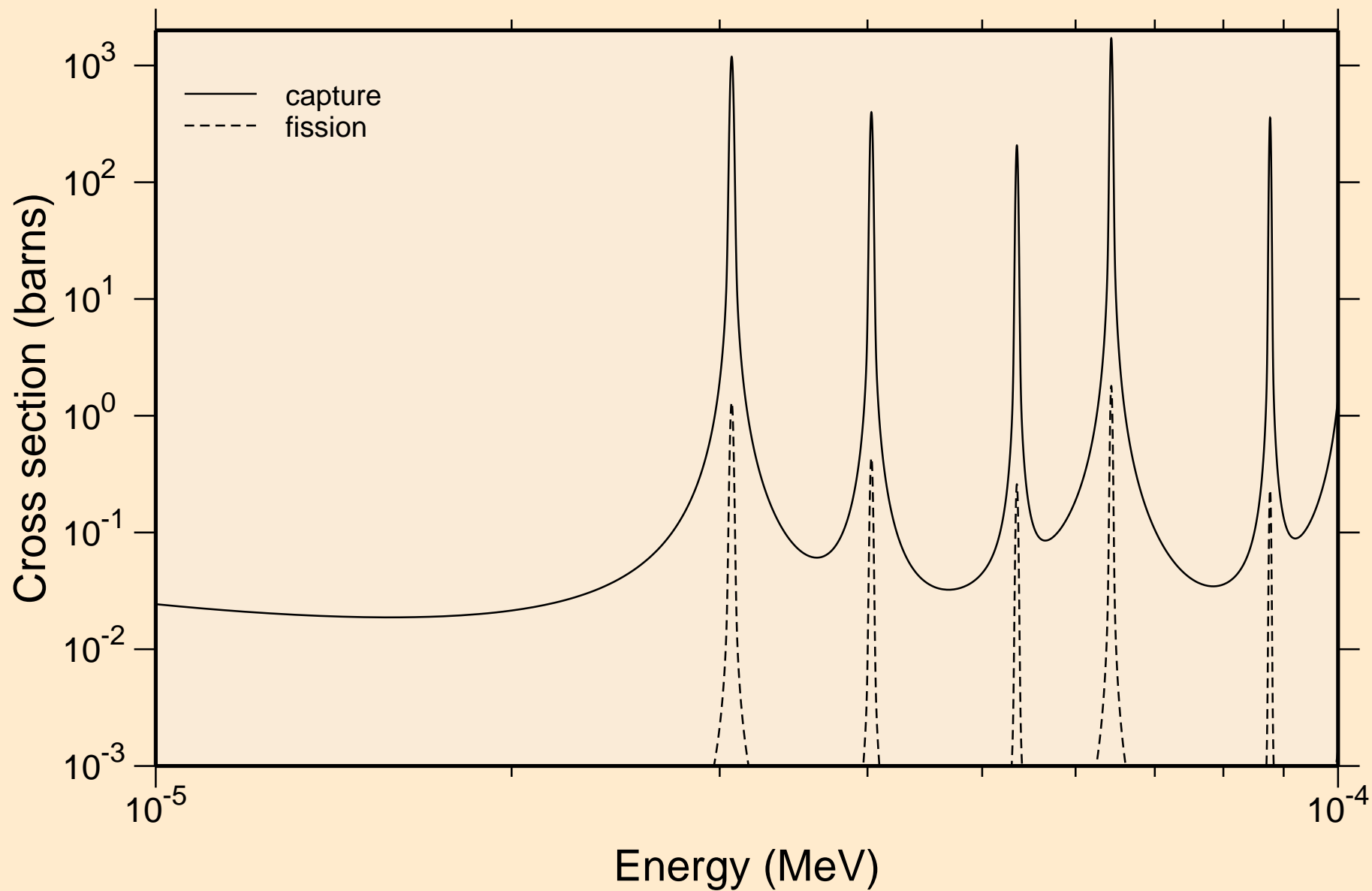

# ENDF/B-VII.1 PU-244 resonance absorption cross sections

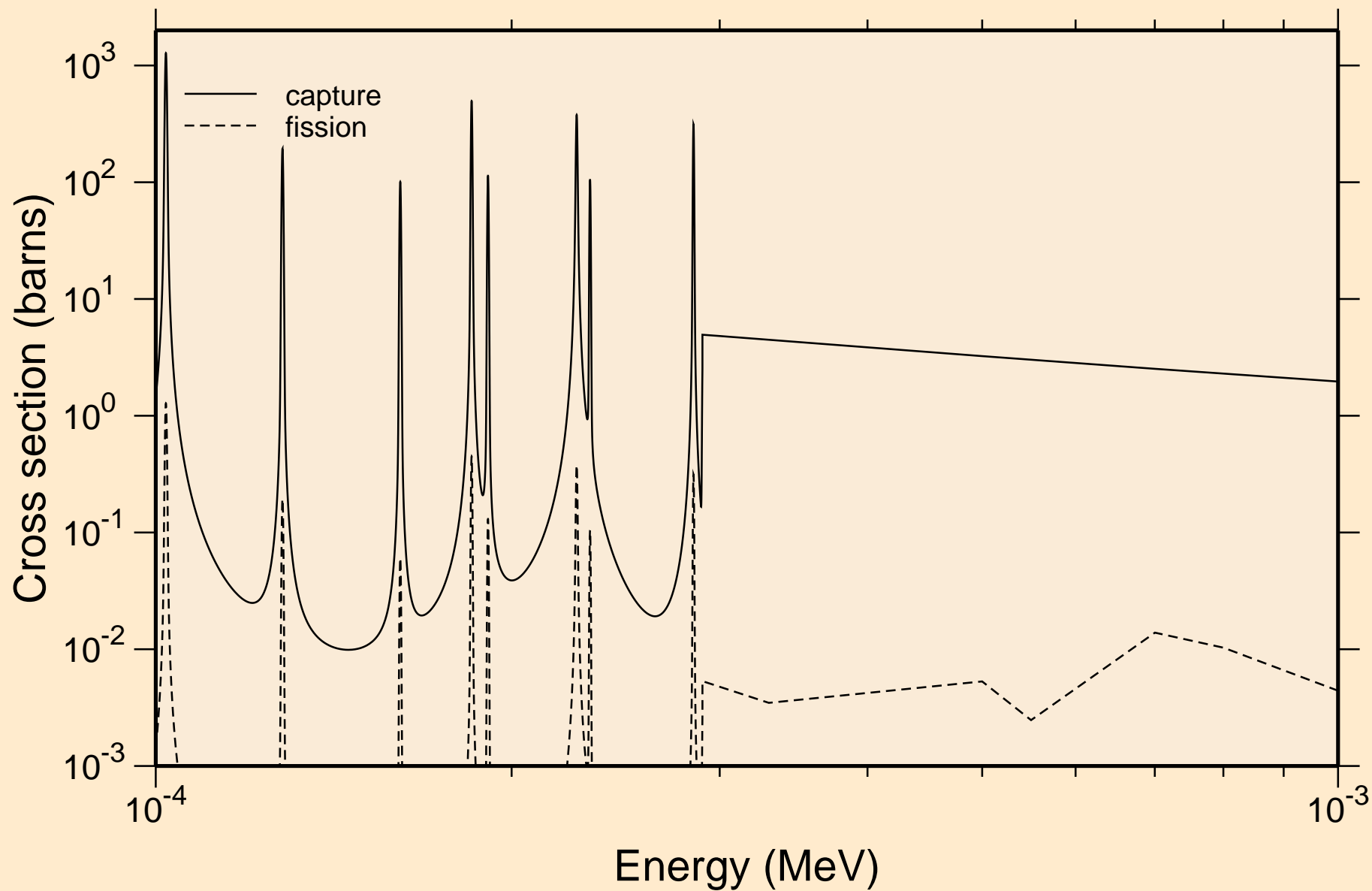

# ENDF/B-VII.1 PU-244 resonance absorption cross sections

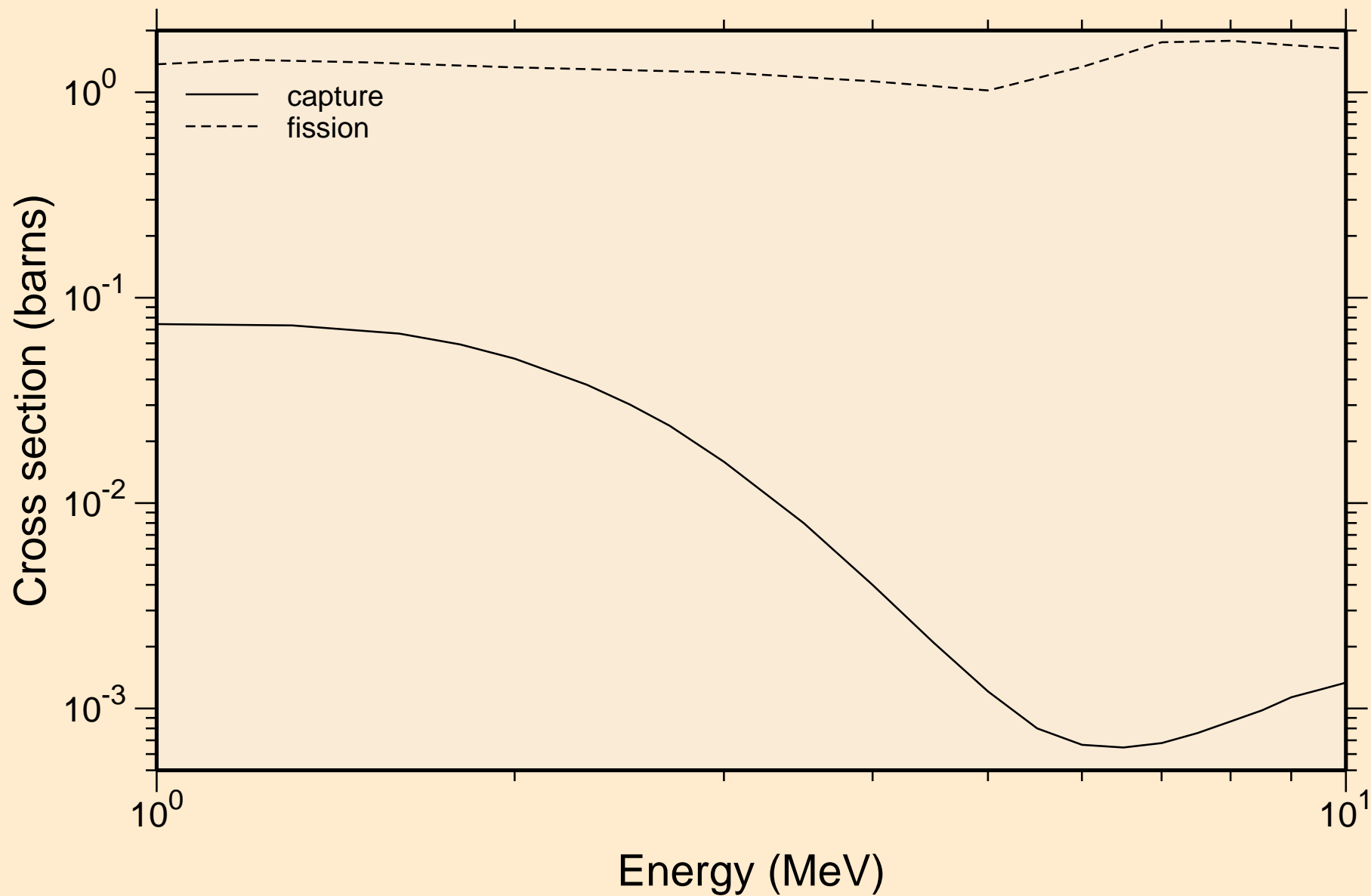



ENDF/B-VII.1 PU-244  
UR total cross section

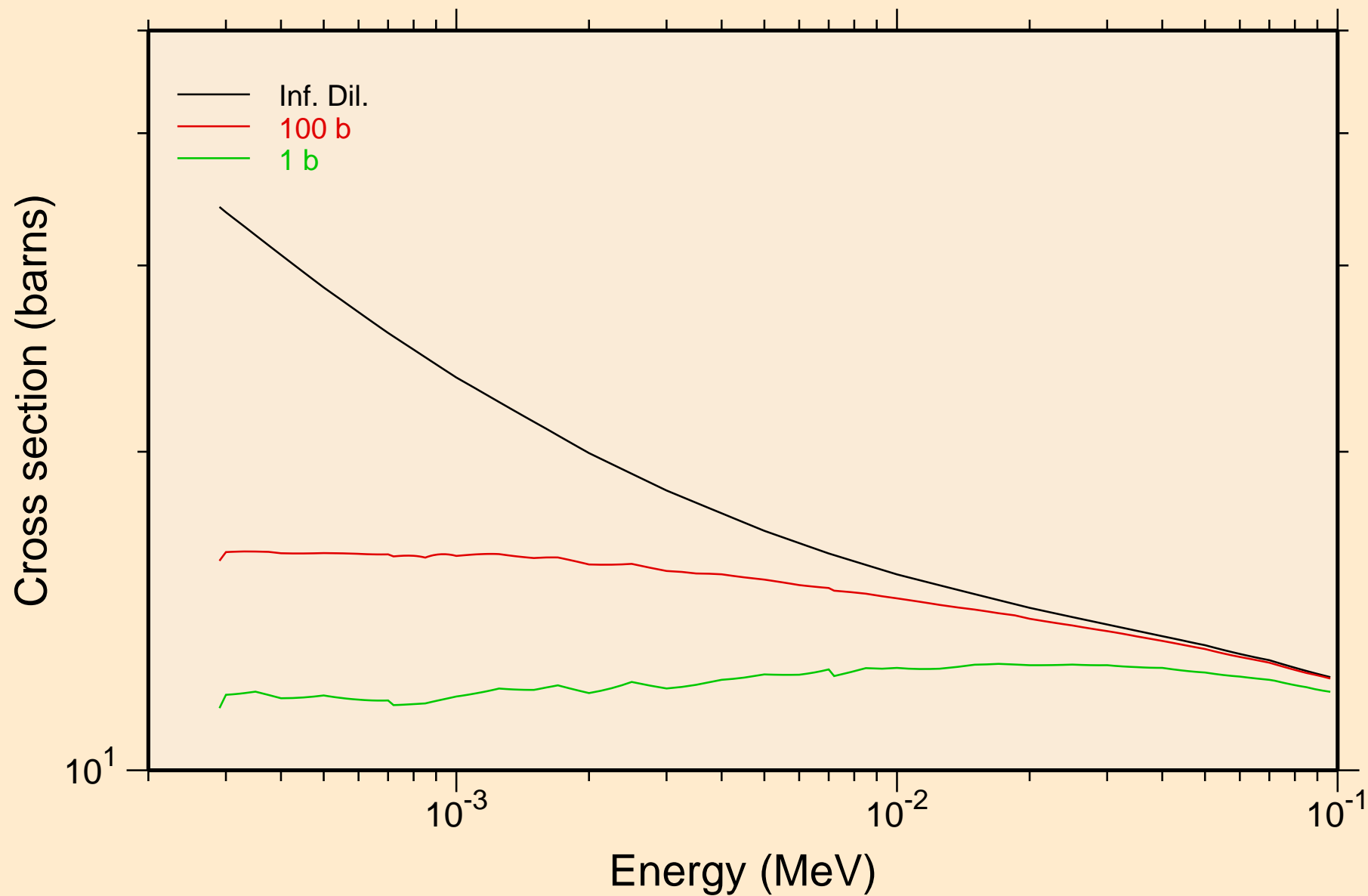

ENDF/B-VII.1 PU-244  
UR elastic cross section

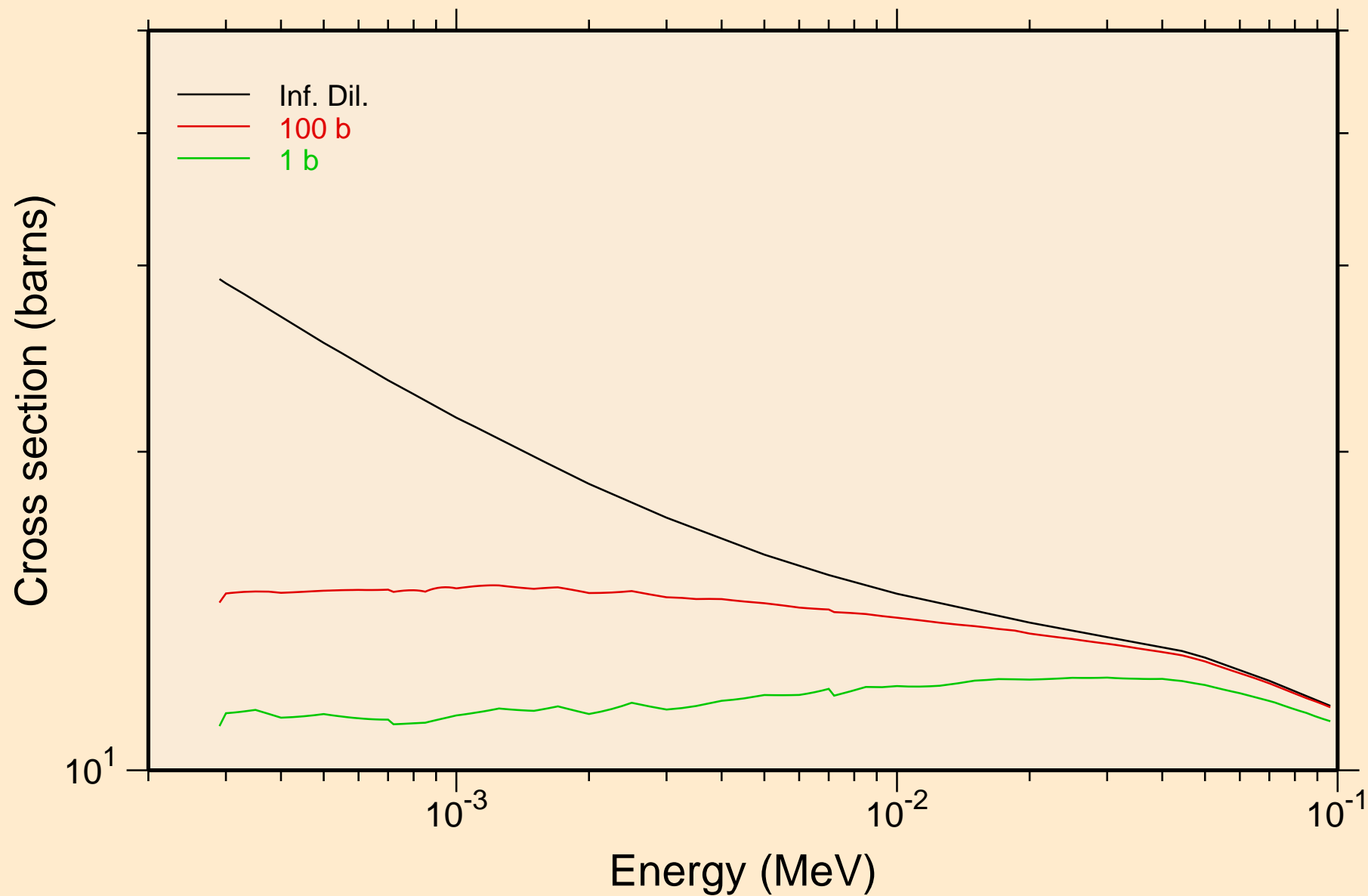

# ENDF/B-VII.1 PU-244

## UR fission cross section

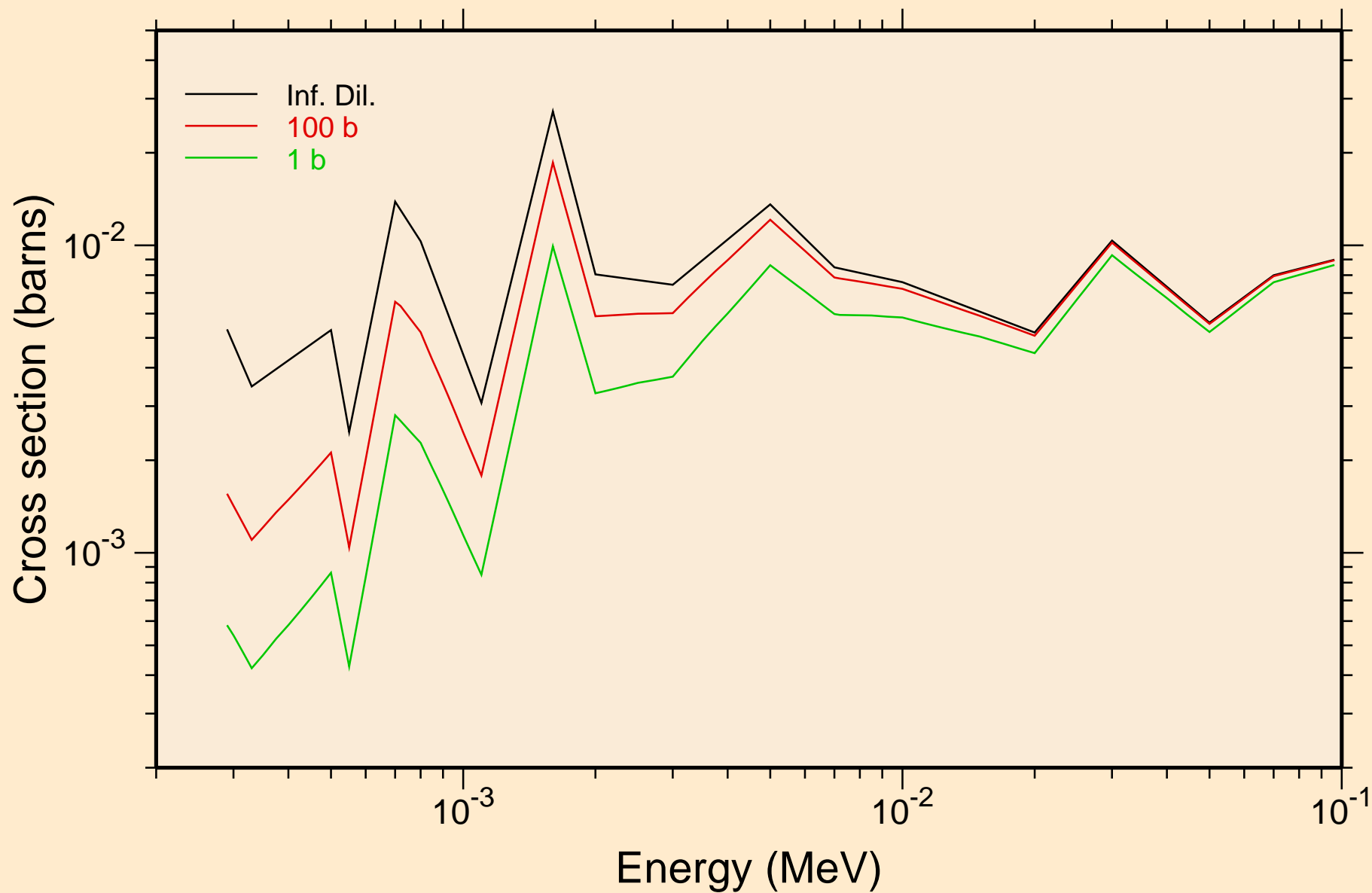

# ENDF/B-VII.1 PU-244

## UR capture cross section

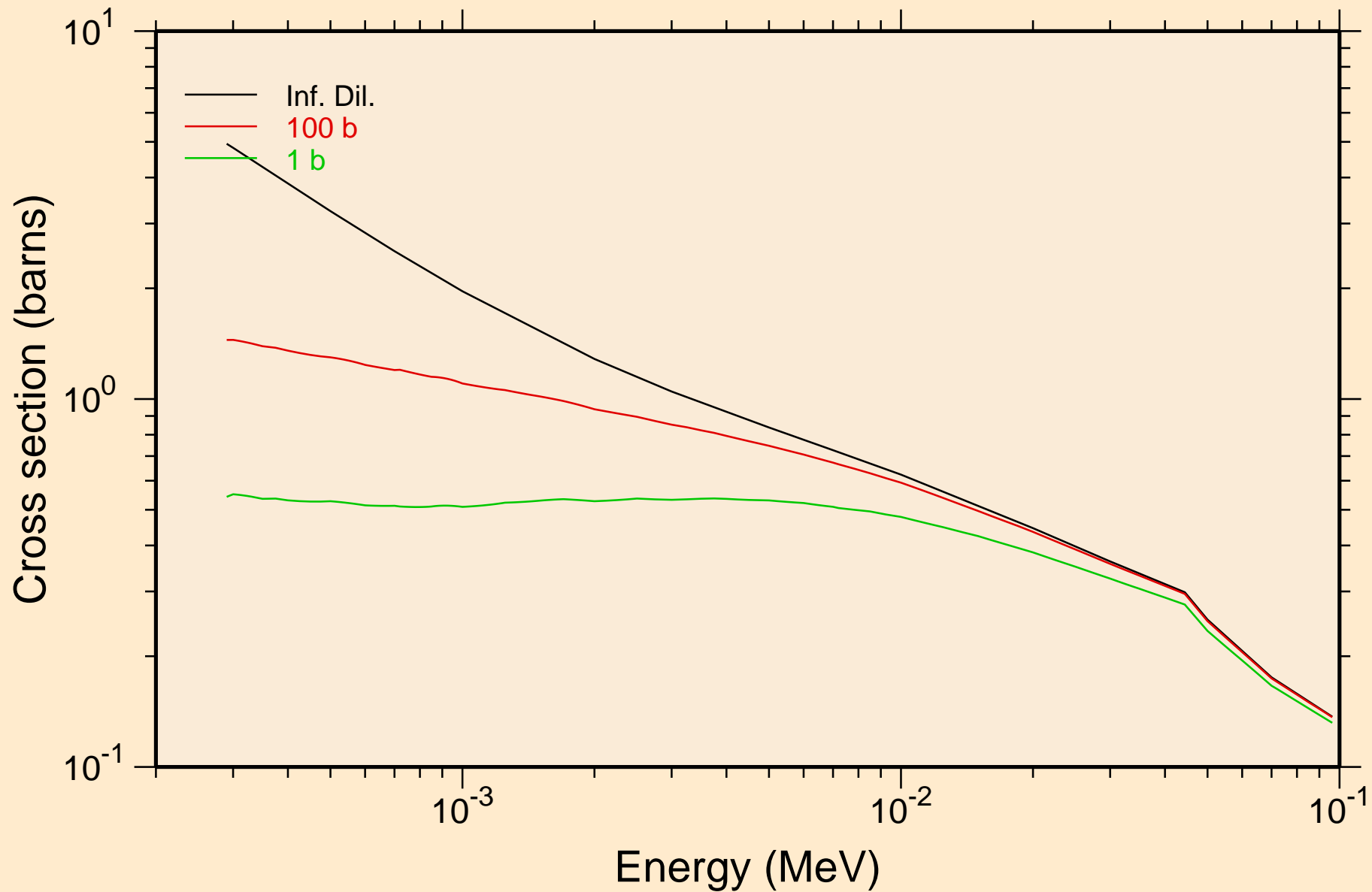

# ENDF/B-VII.1 PU-244

## Heating

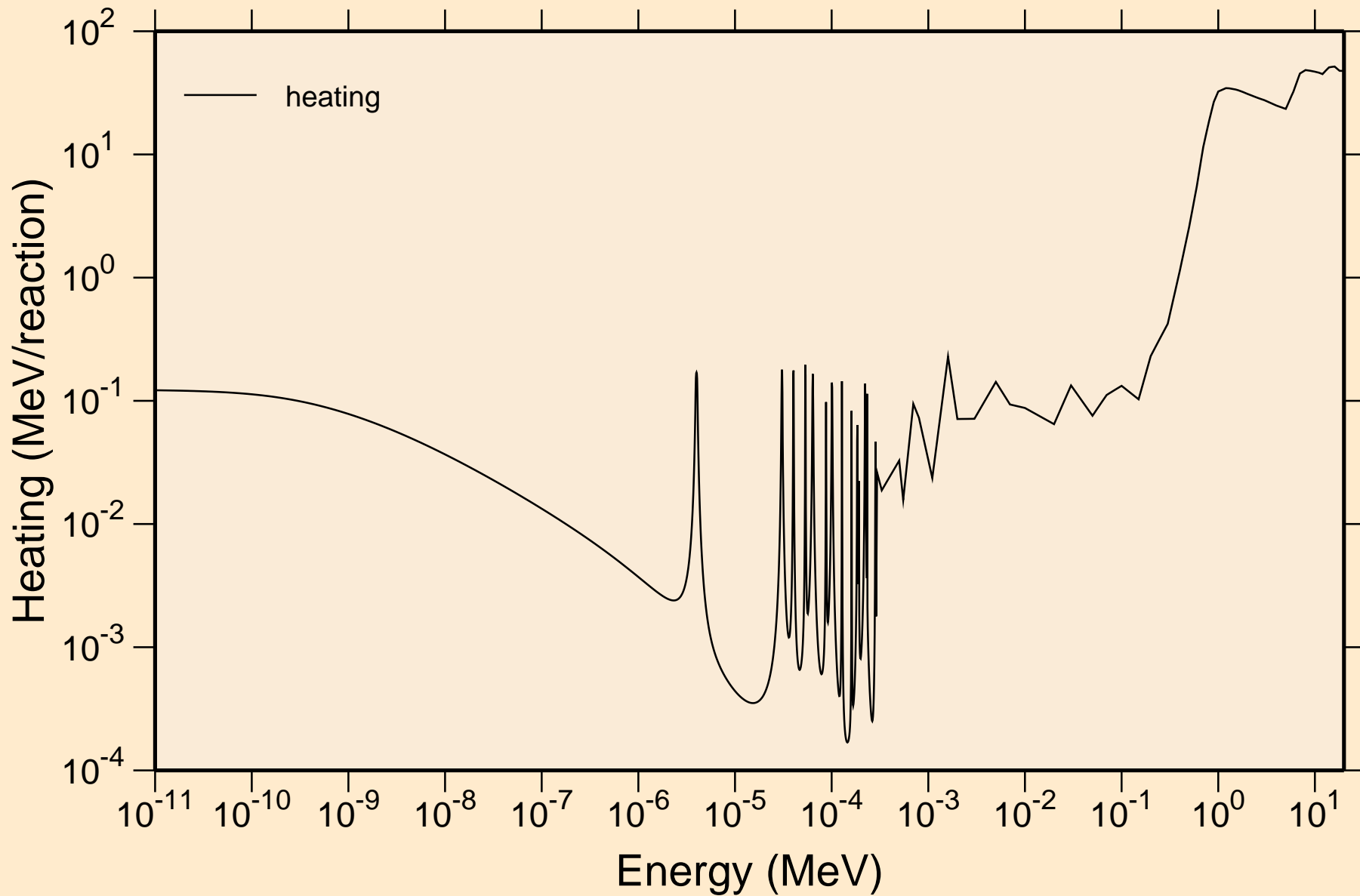

# ENDF/B-VII.1 PU-244 Damage

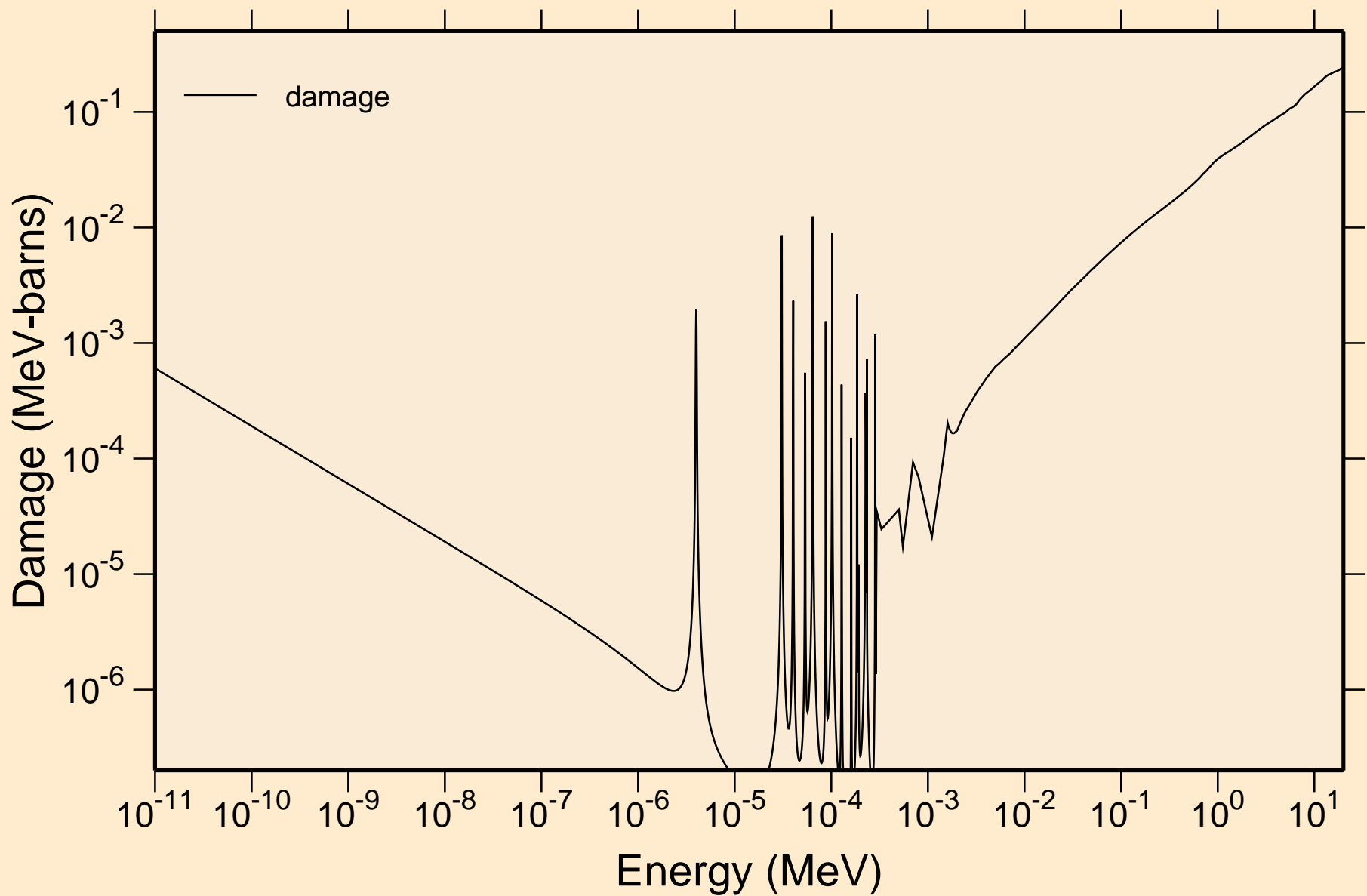

# ENDF/B-VII.1 PU-244

## Non-threshold reactions

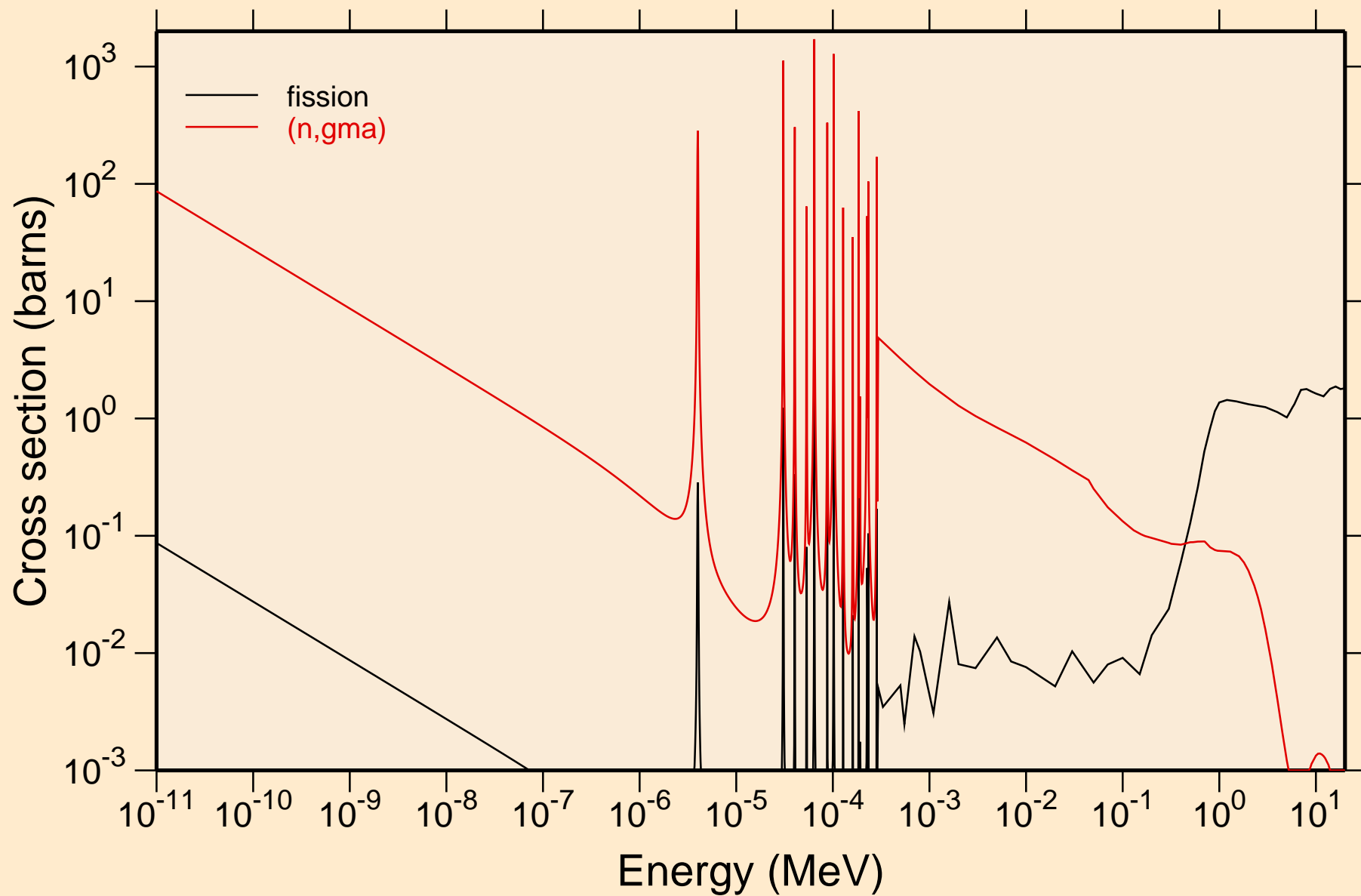

# ENDF/B-VII.1 PU-244

## Principal cross sections

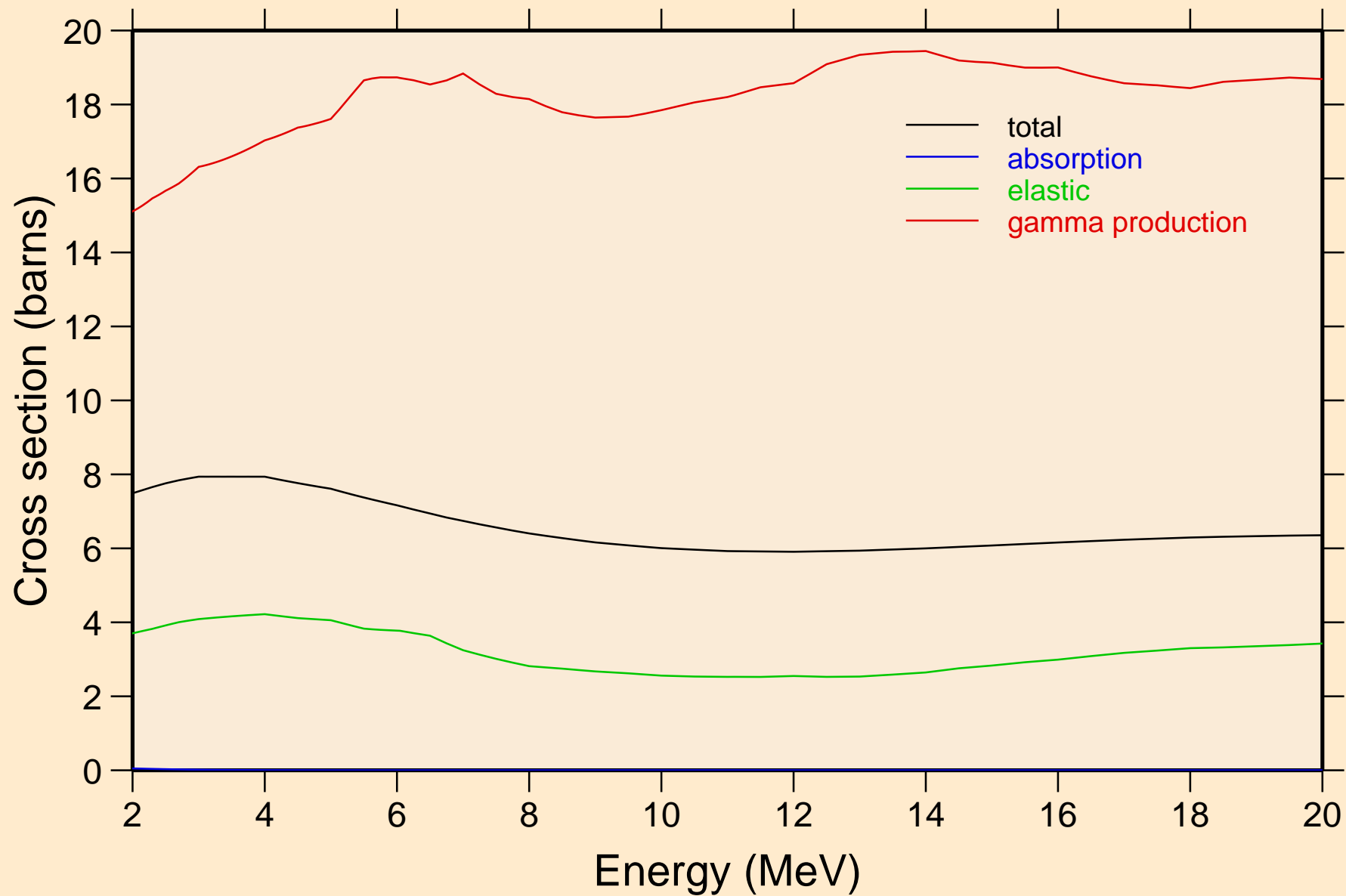



# ENDF/B-VII.1 PU-244

## Heating

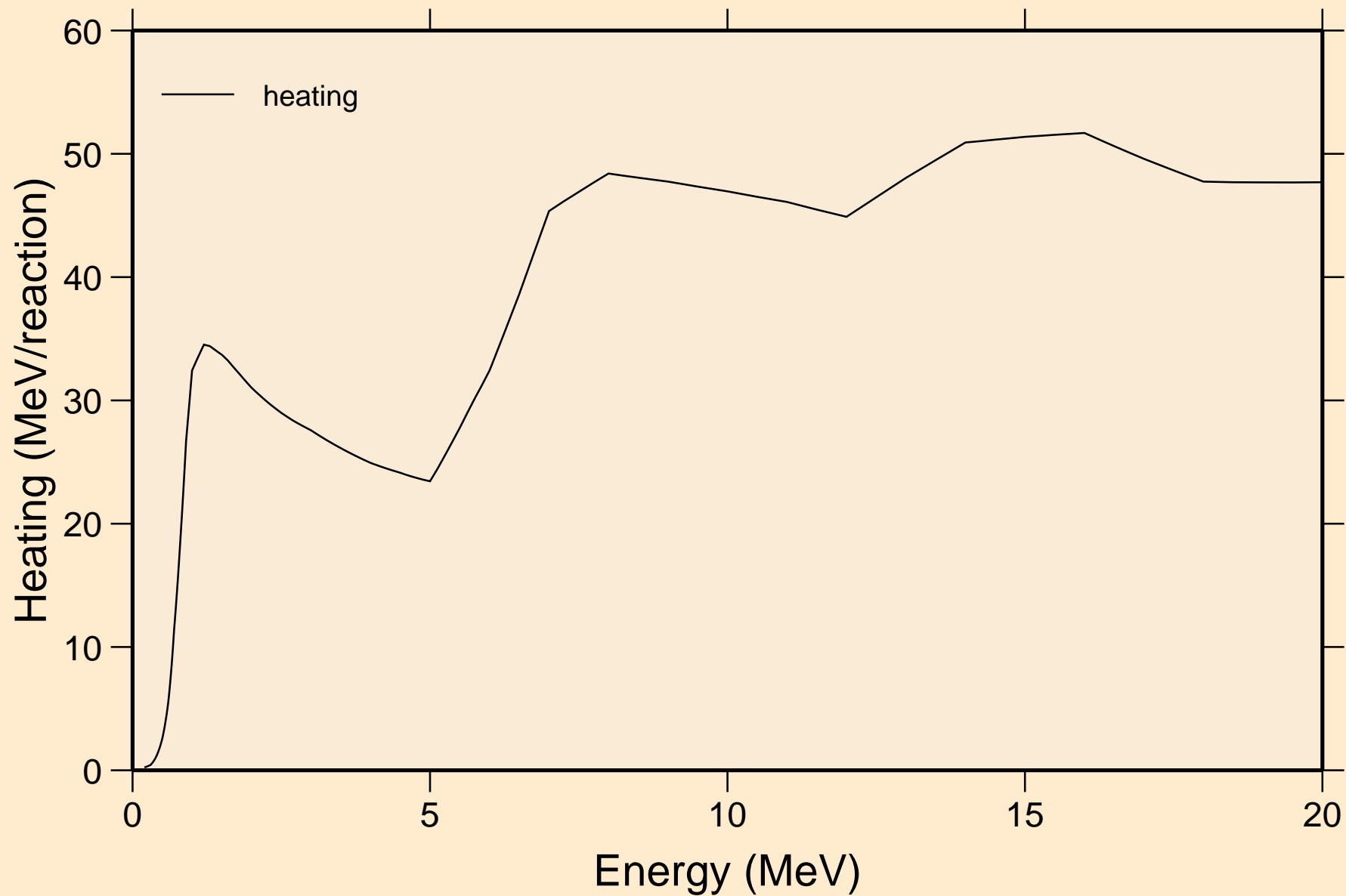

# ENDF/B-VII.1 PU-244

## Damage

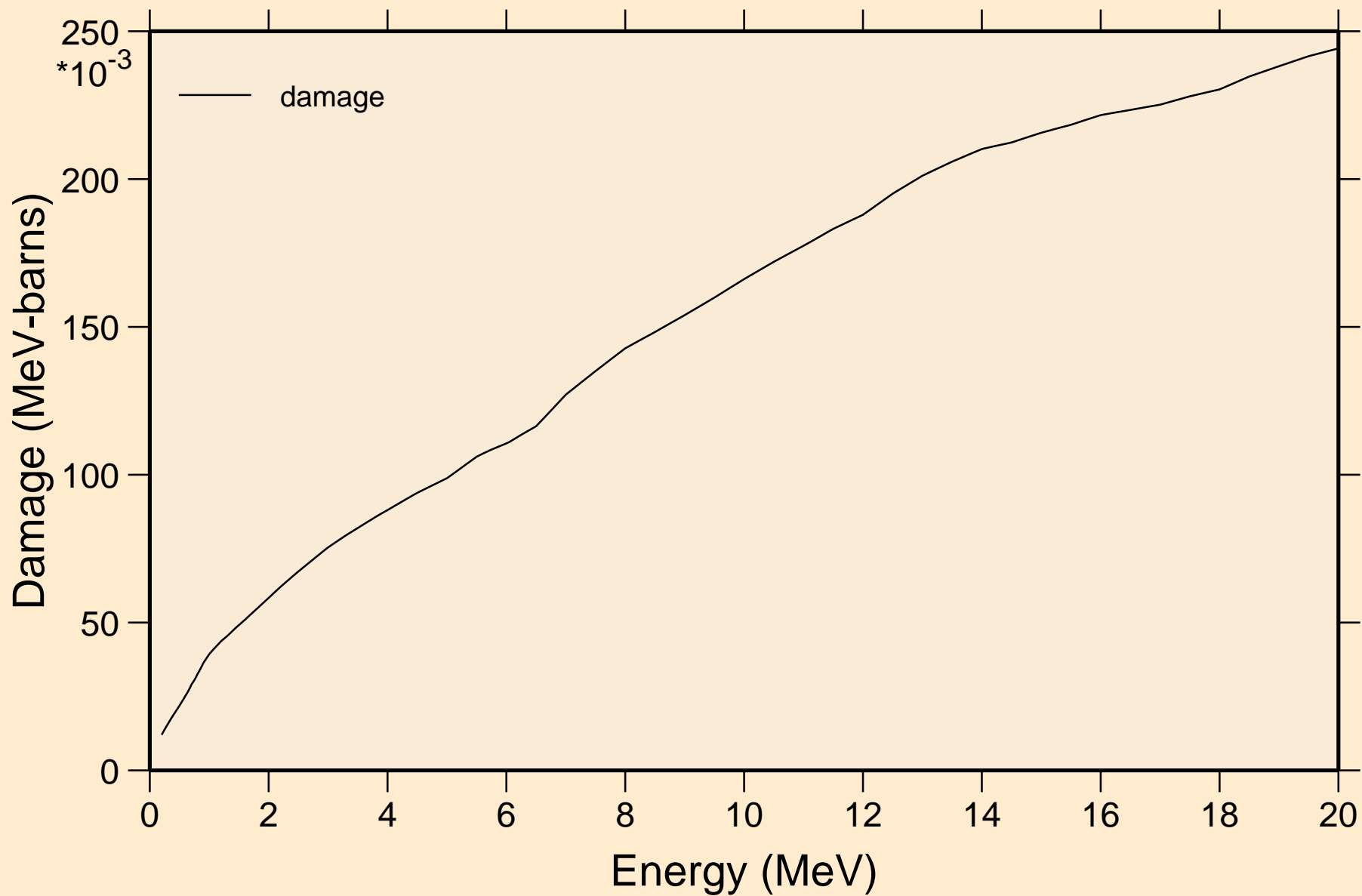

ENDF/B-VII.1 PU-244  
Non-threshold reactions

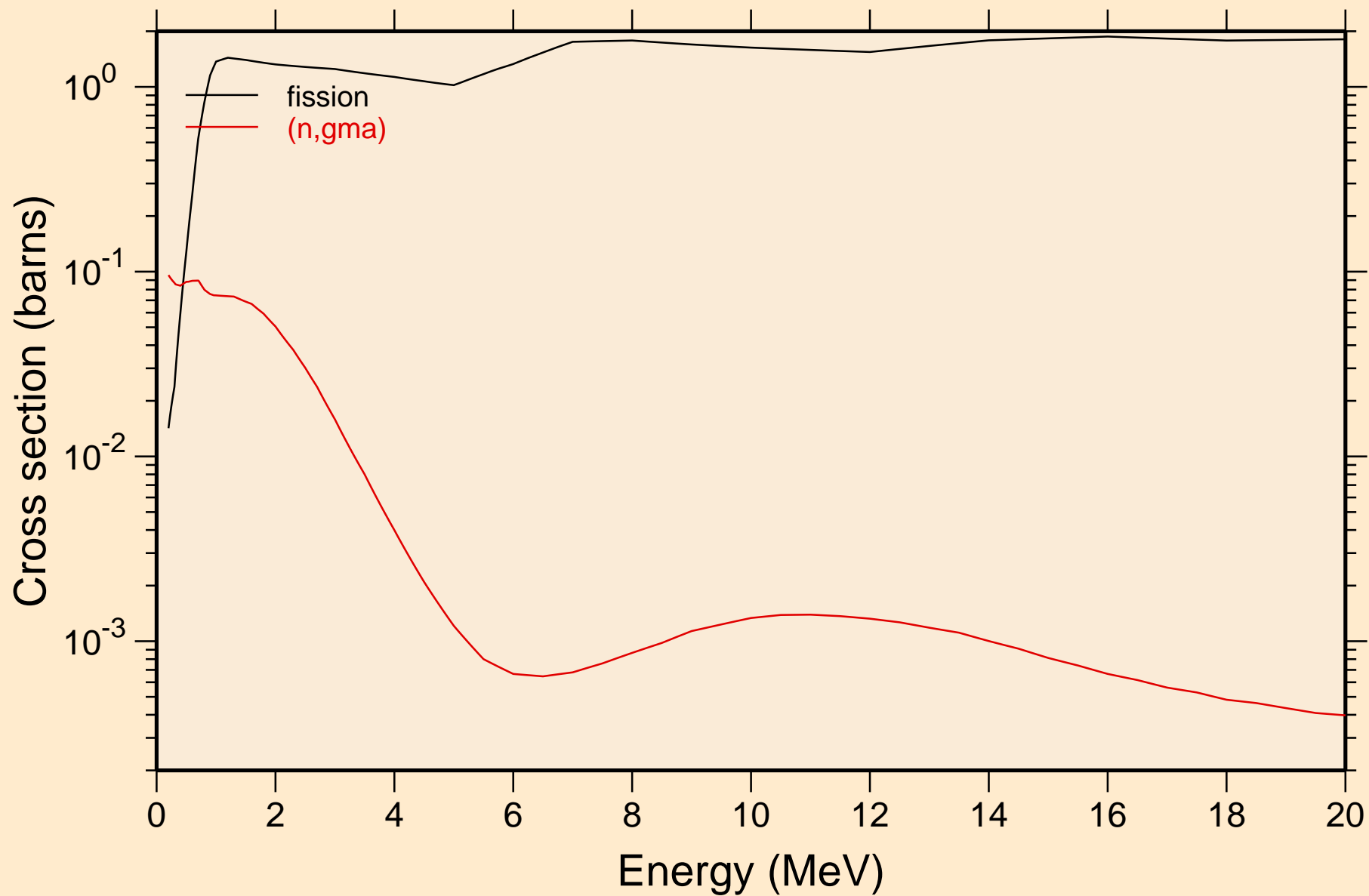

# ENDF/B-VII.1 PU-244

## Inelastic levels

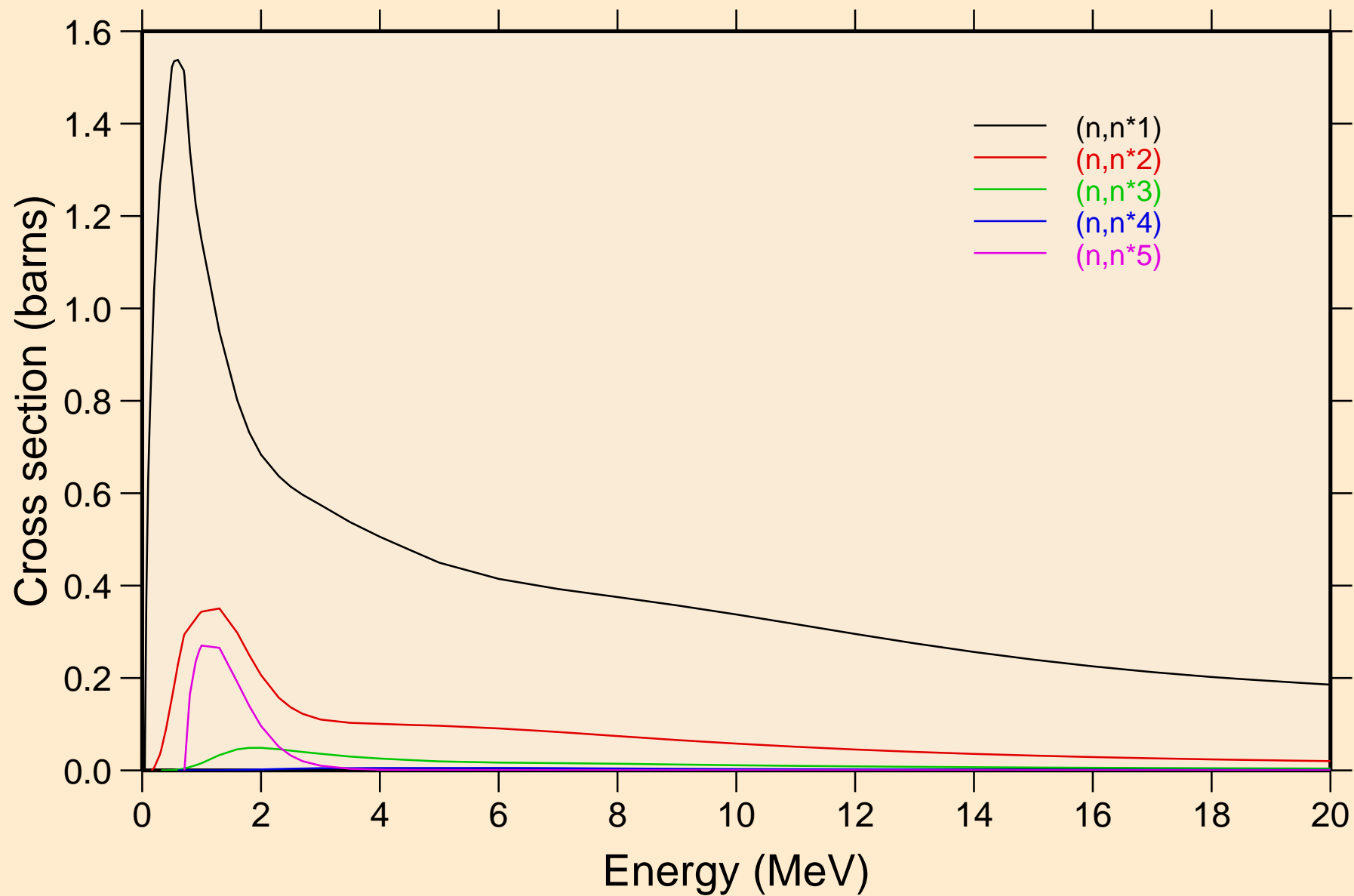

# ENDF/B-VII.1 PU-244

## Inelastic levels

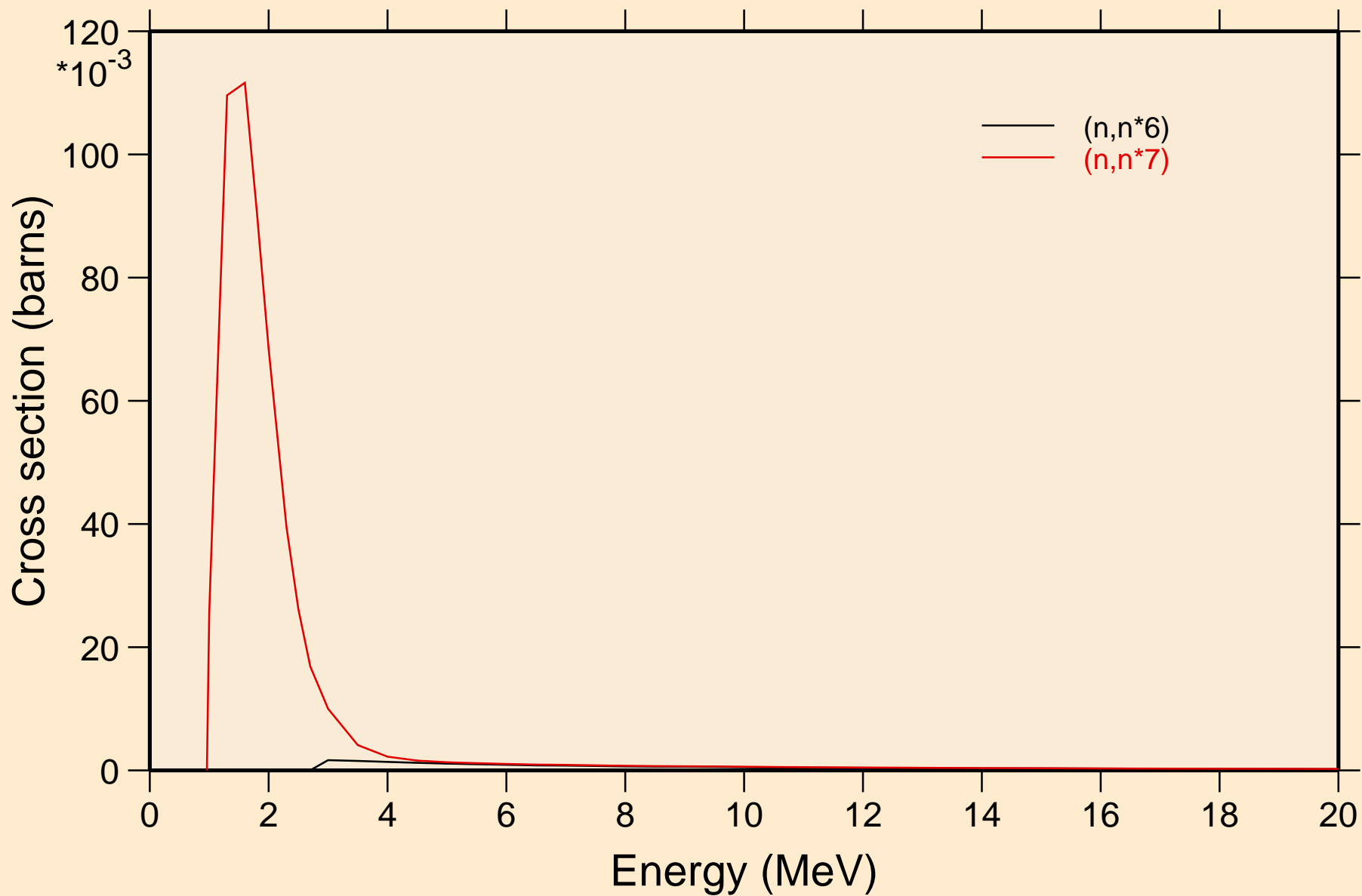

# ENDF/B-VII.1 PU-244

## Threshold reactions

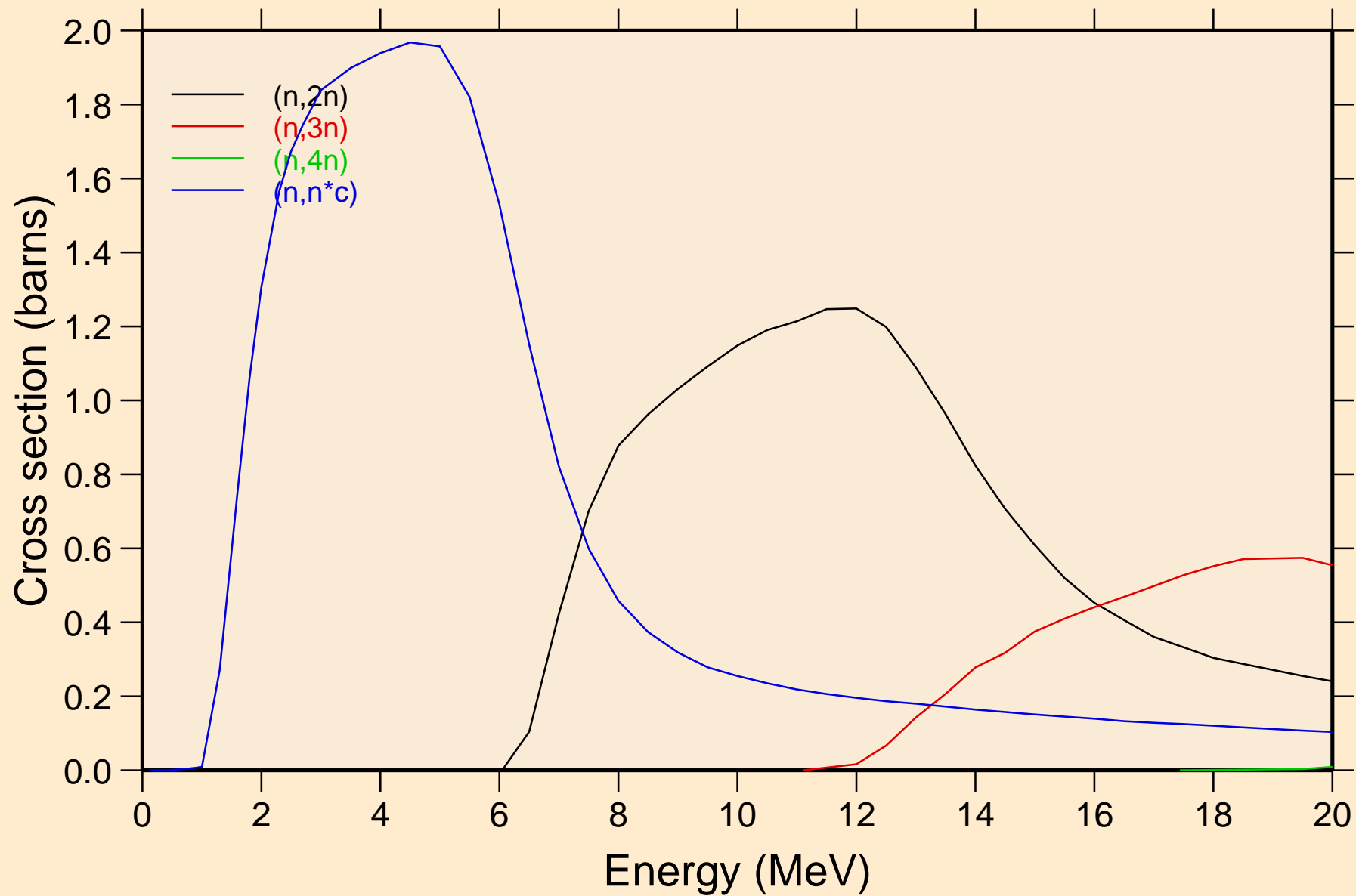

ENDF/B-VII.1 PU-244  
angular distribution for elastic

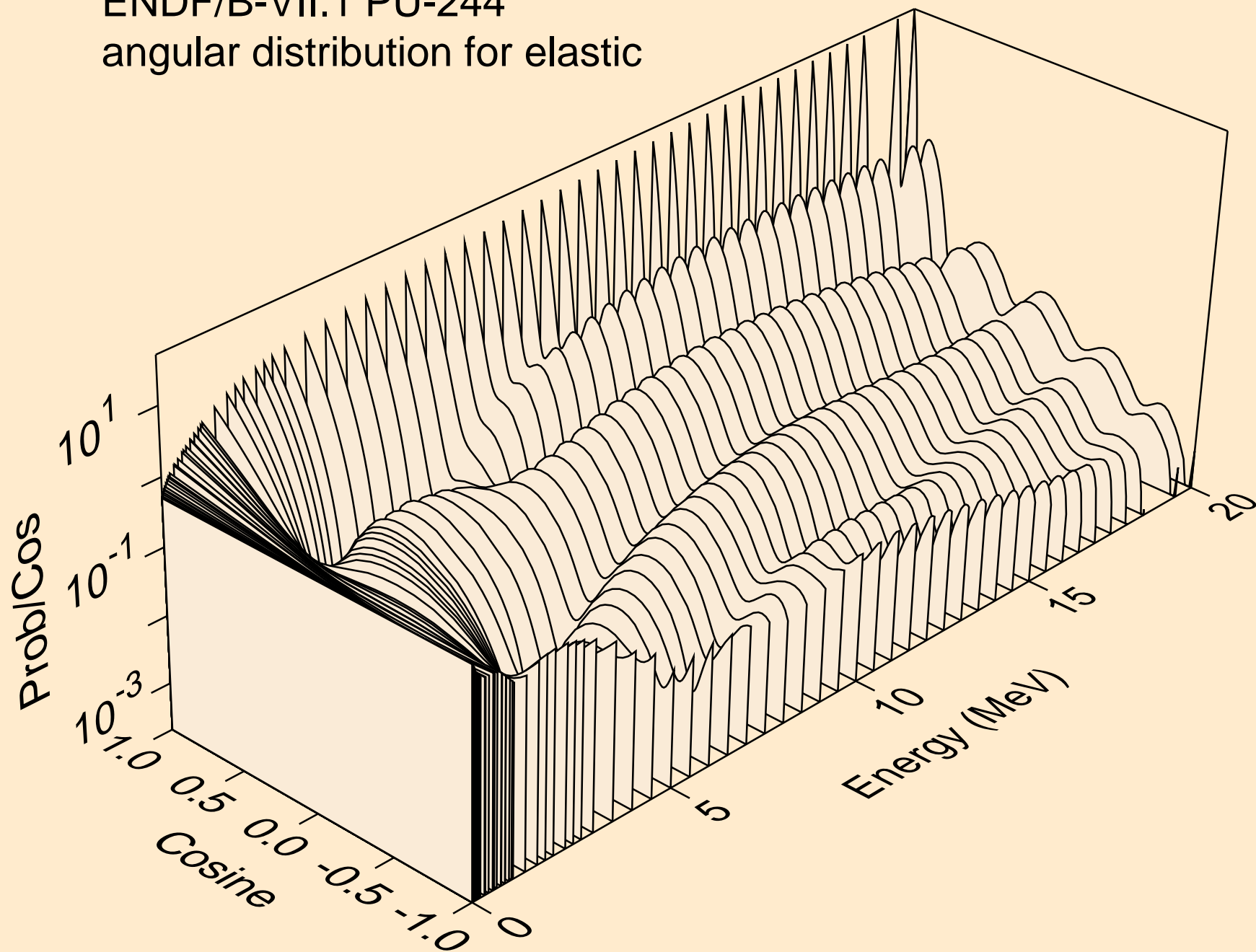

ENDF/B-VII.1 PU-244  
angular distribution for (n,n\*1)

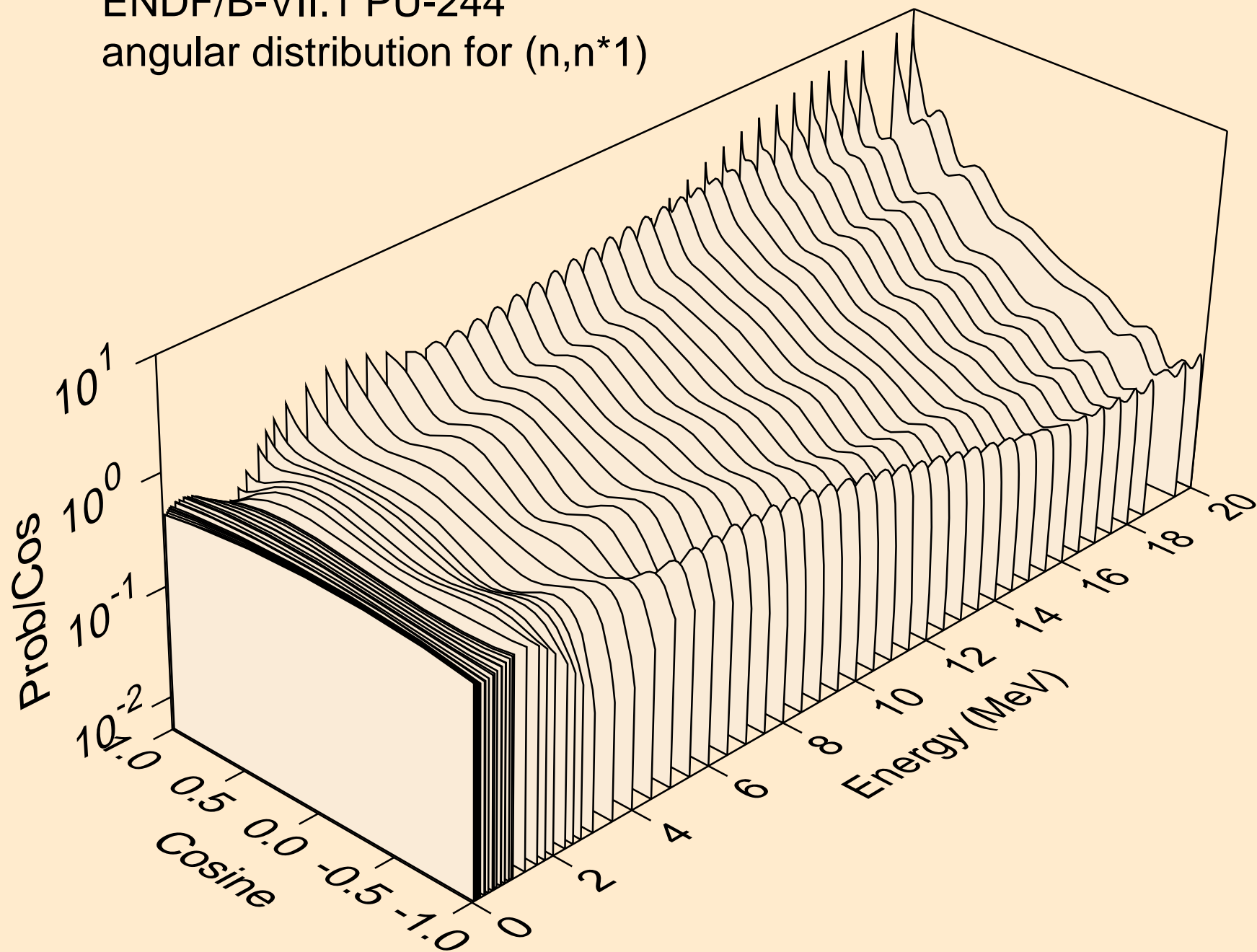



ENDF/B-VII.1 PU-244  
angular distribution for (n,n\*2)

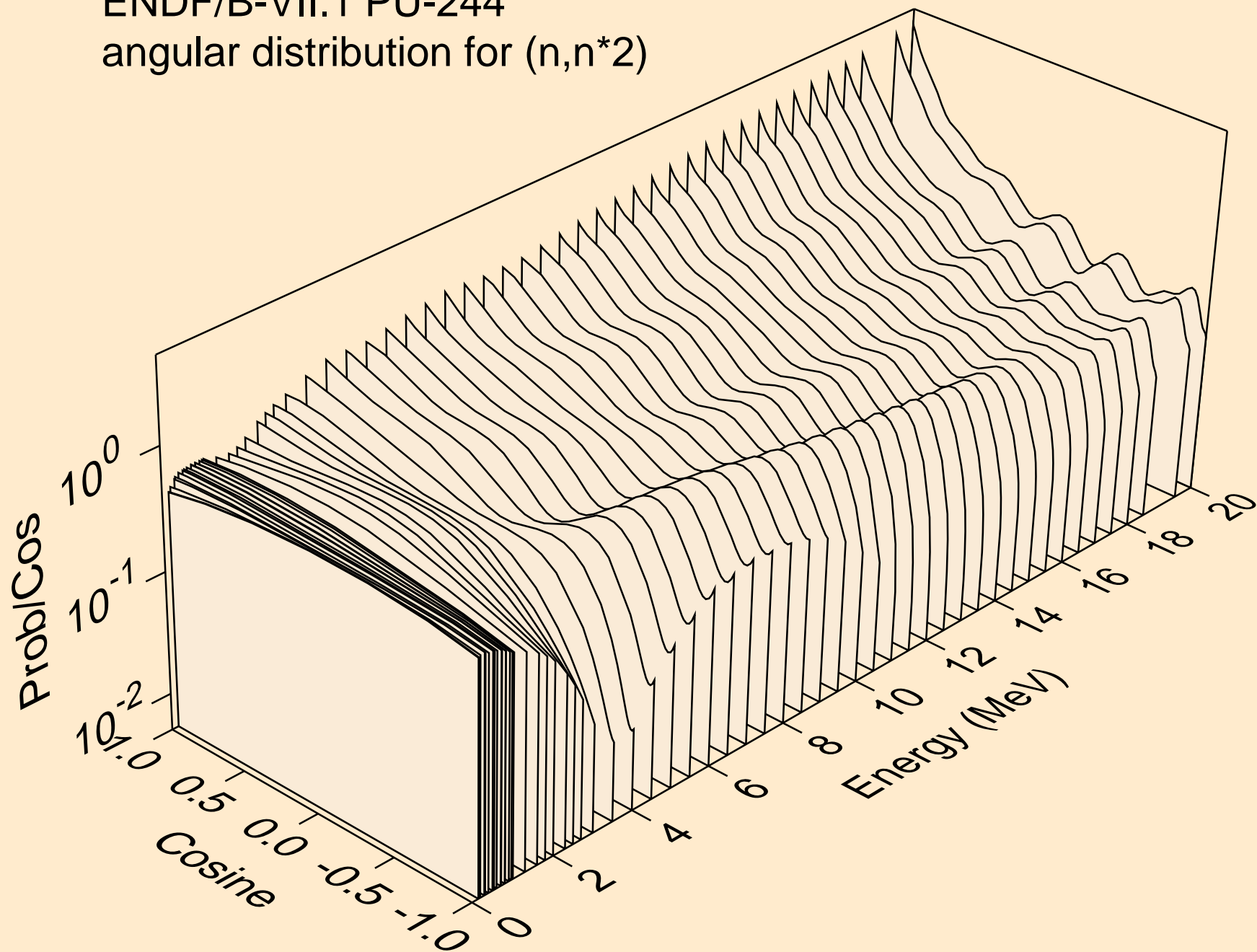

ENDF/B-VII.1 PU-244  
angular distribution for (n,n\*3)

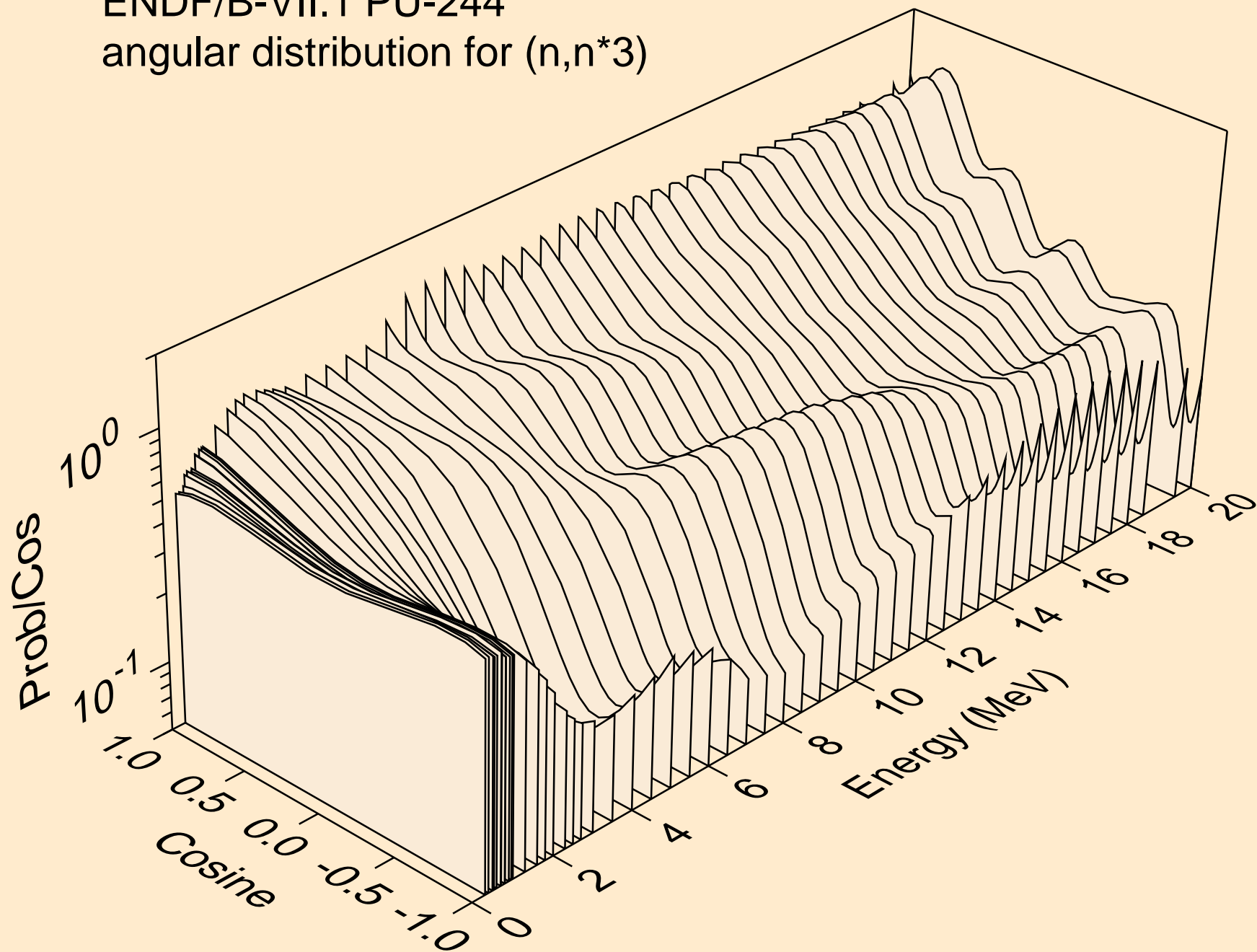

ENDF/B-VII.1 PU-244  
angular distribution for (n,n\*4)

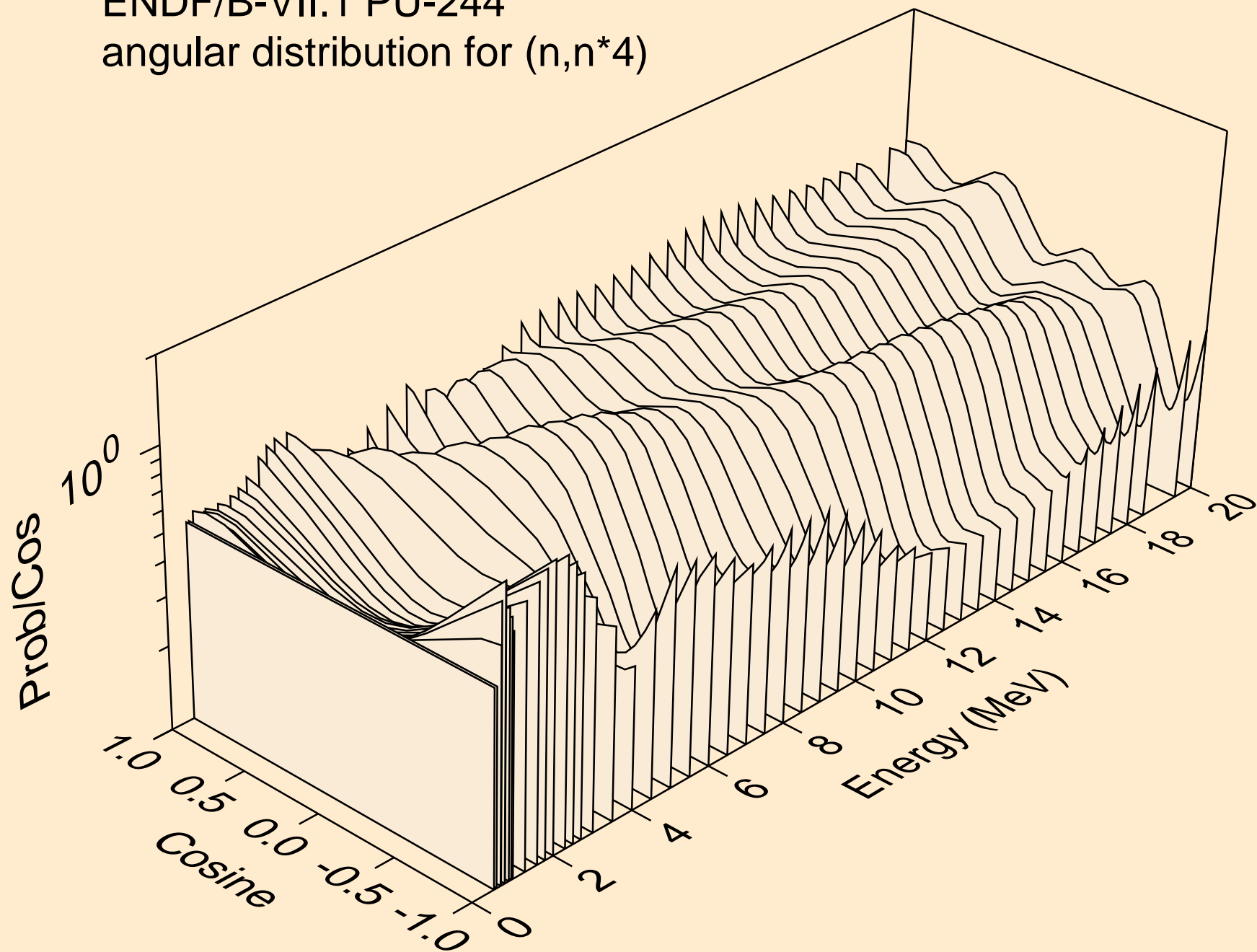

ENDF/B-VII.1 PU-244  
angular distribution for (n,n\*5)

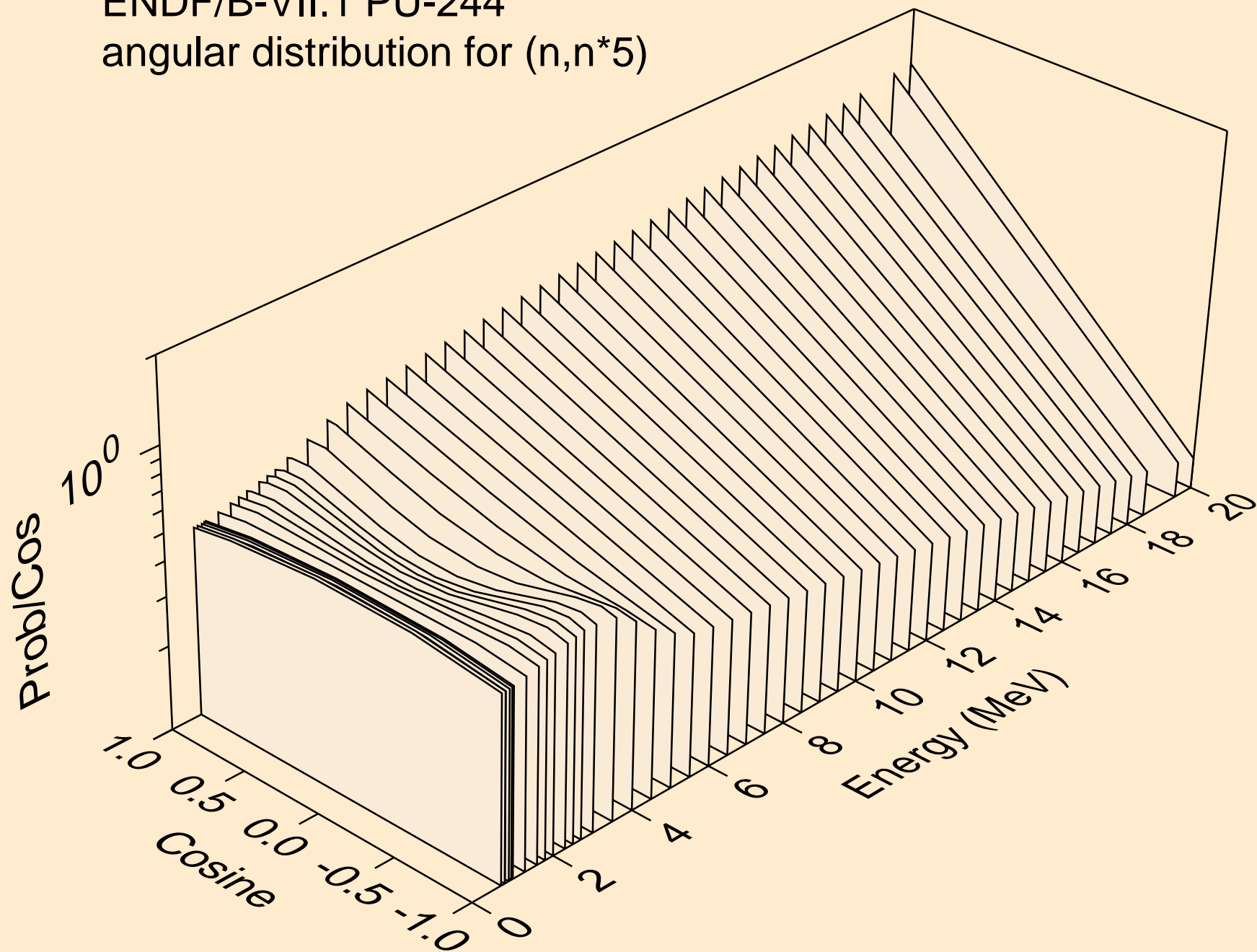

ENDF/B-VII.1 PU-244  
angular distribution for (n,n\*6)

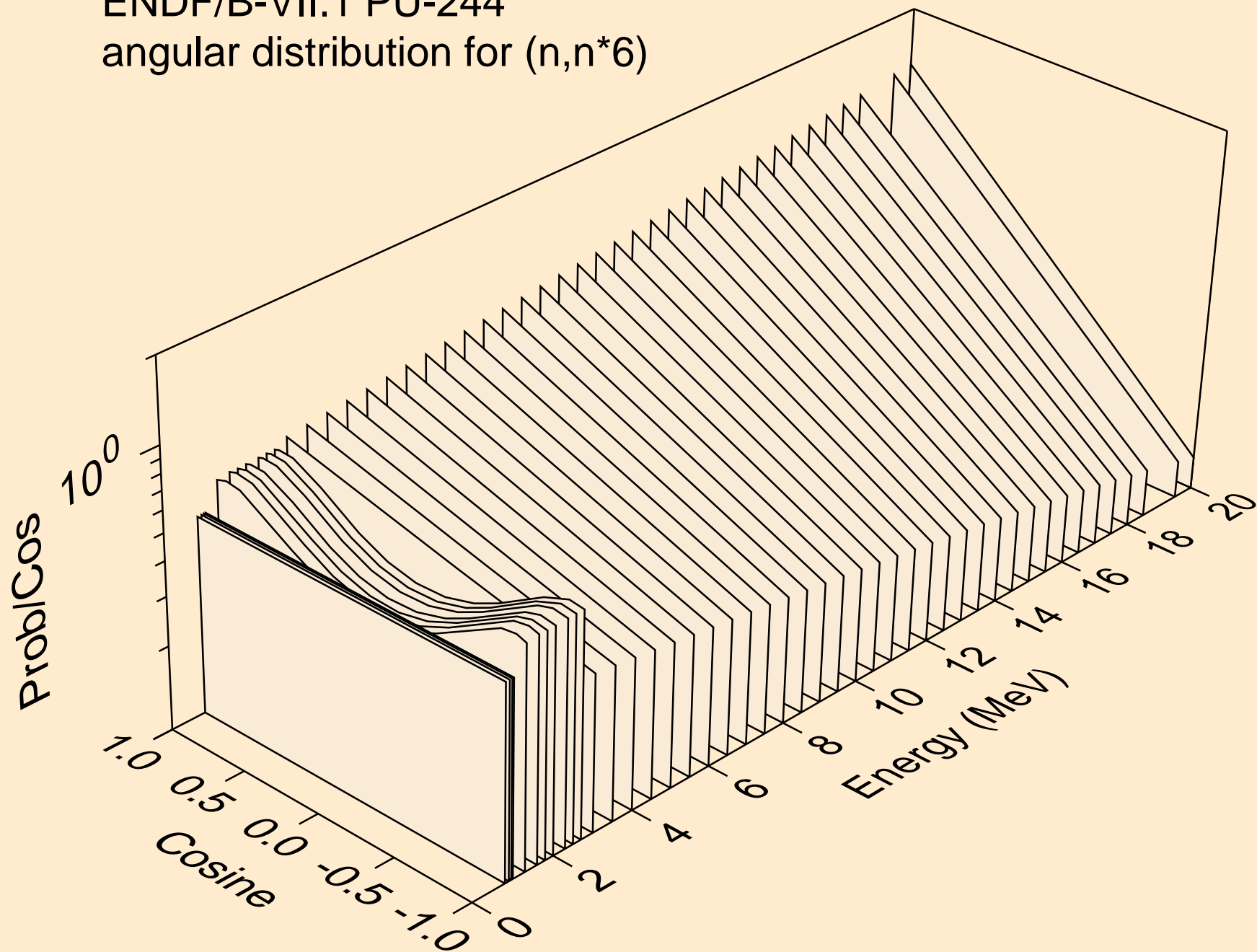

ENDF/B-VII.1 PU-244  
angular distribution for (n,n\*7)

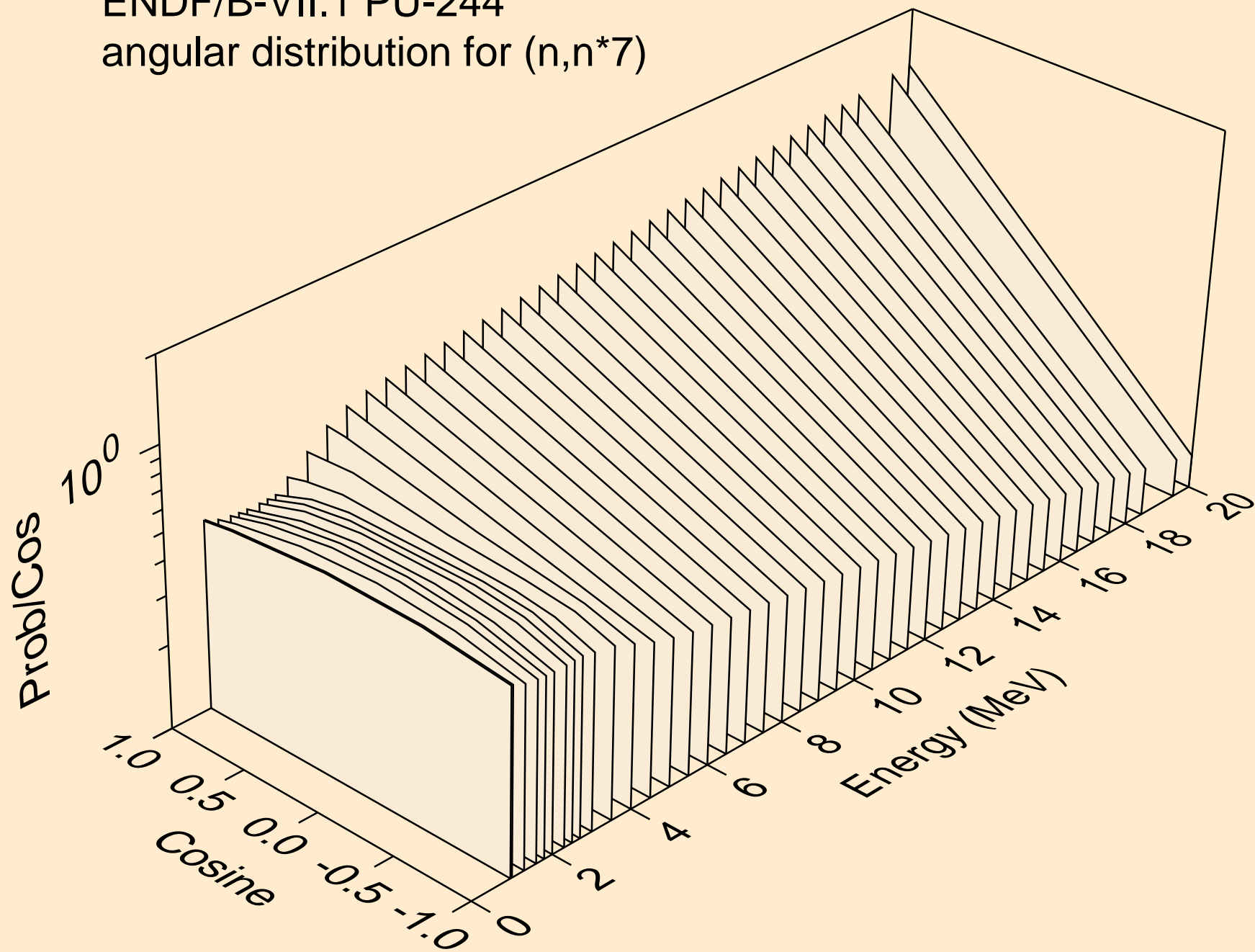

ENDF/B-VII.1 PU-244

Total fission nubar

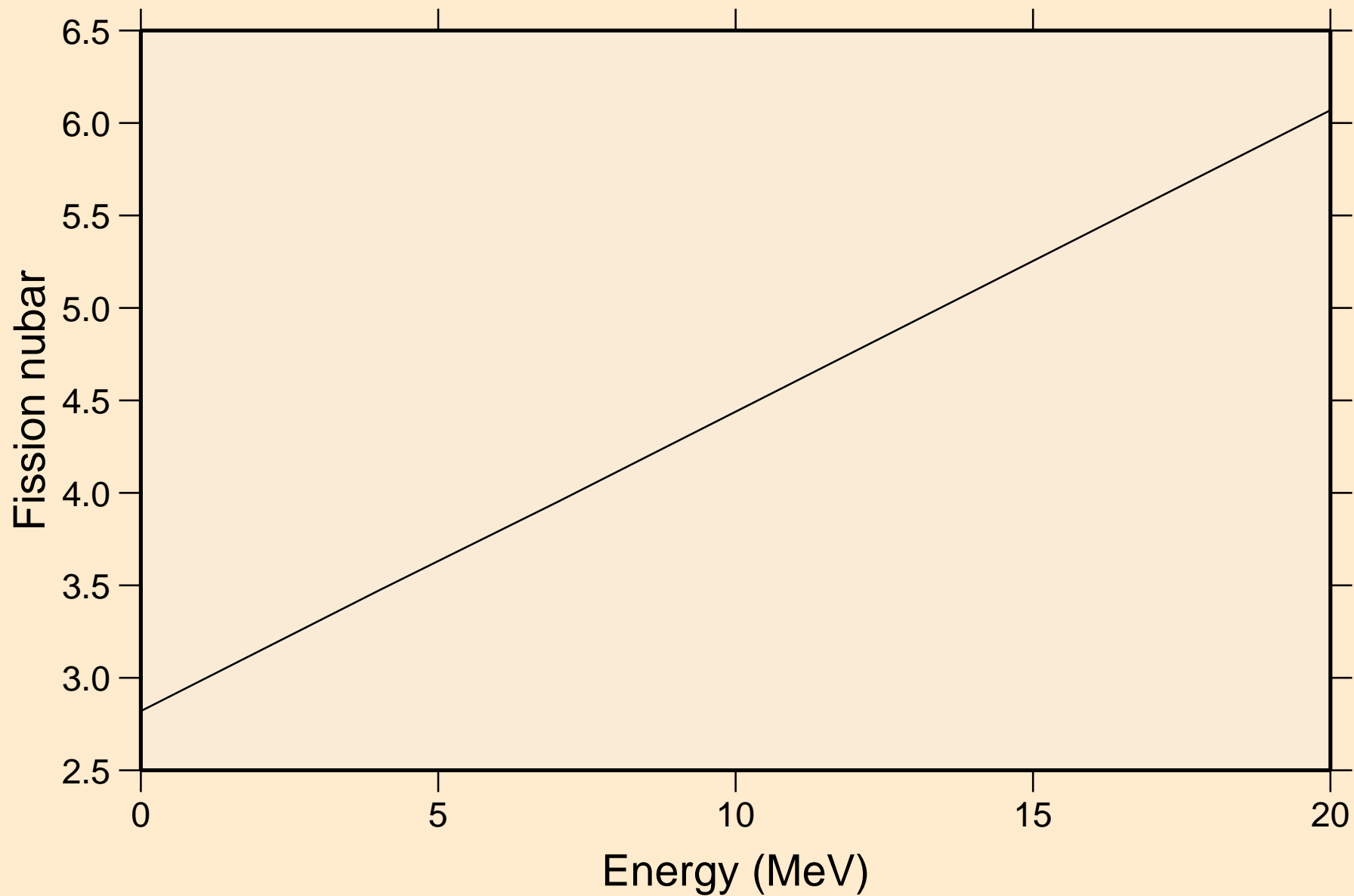

ENDF/B-VII.1 PU-244  
Neutron emission for (n,2n)

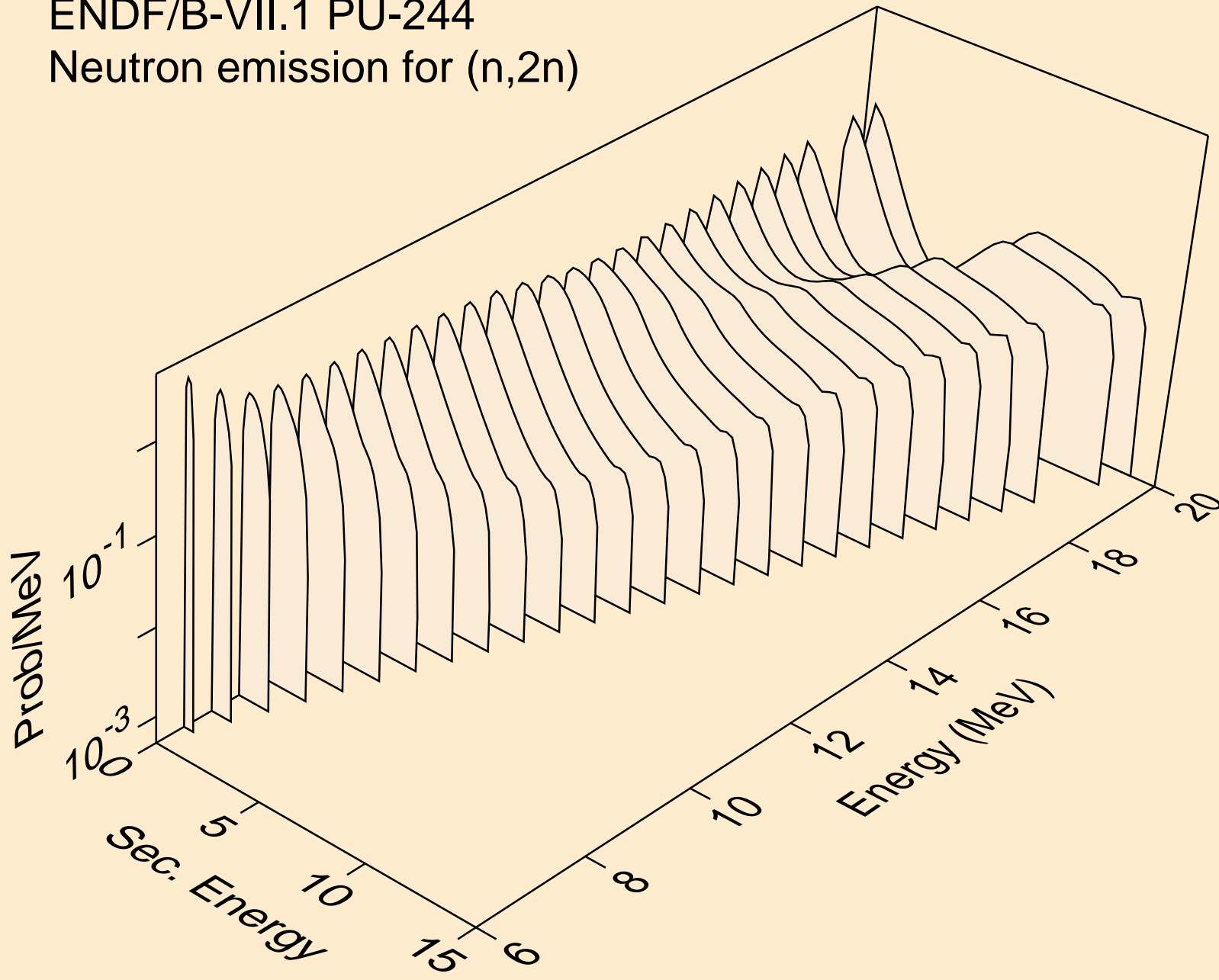



ENDF/B-VII.1 PU-244  
Neutron emission for (n,3n)

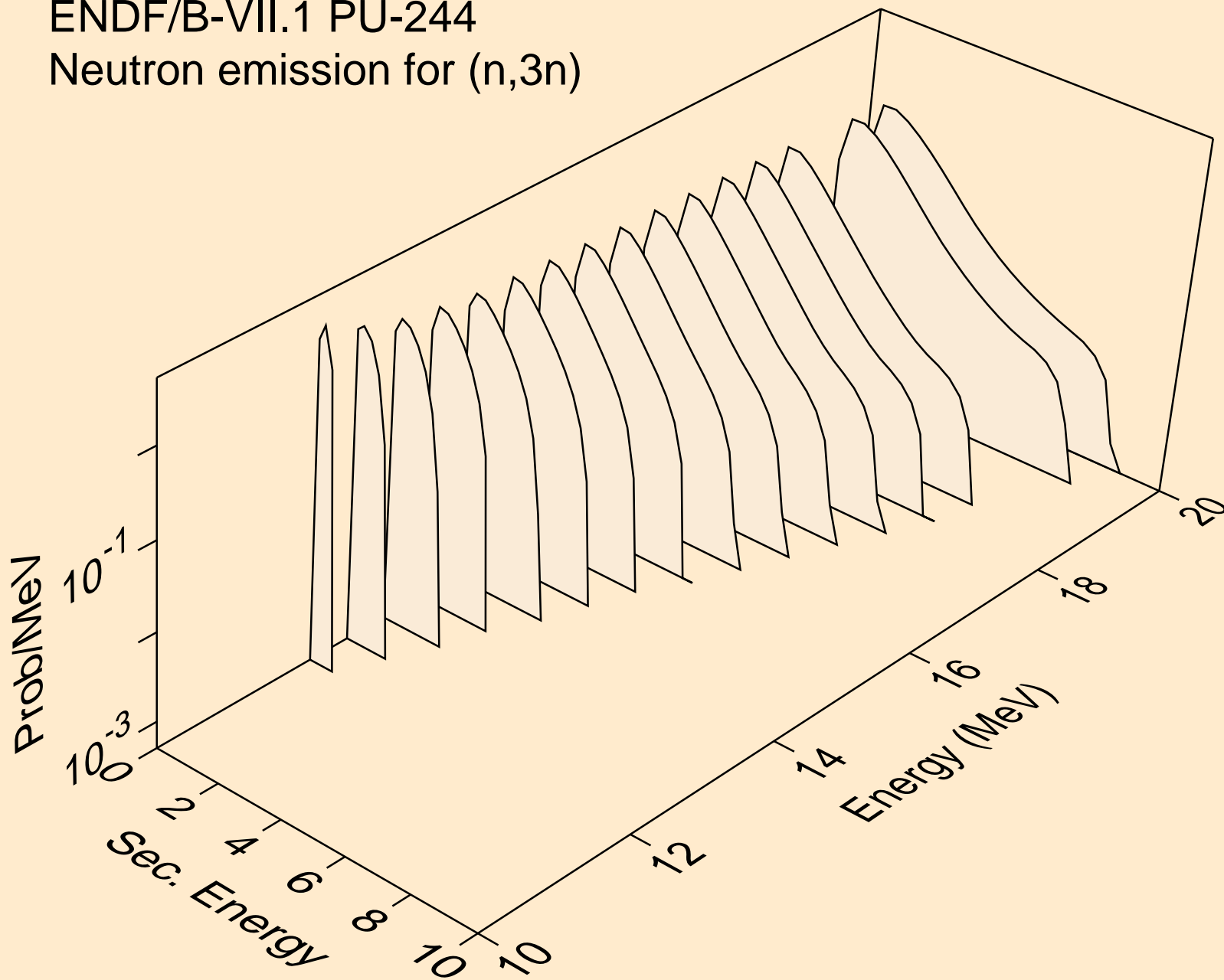

ENDF/B-VII.1 PU-244  
Neutron emission for fission

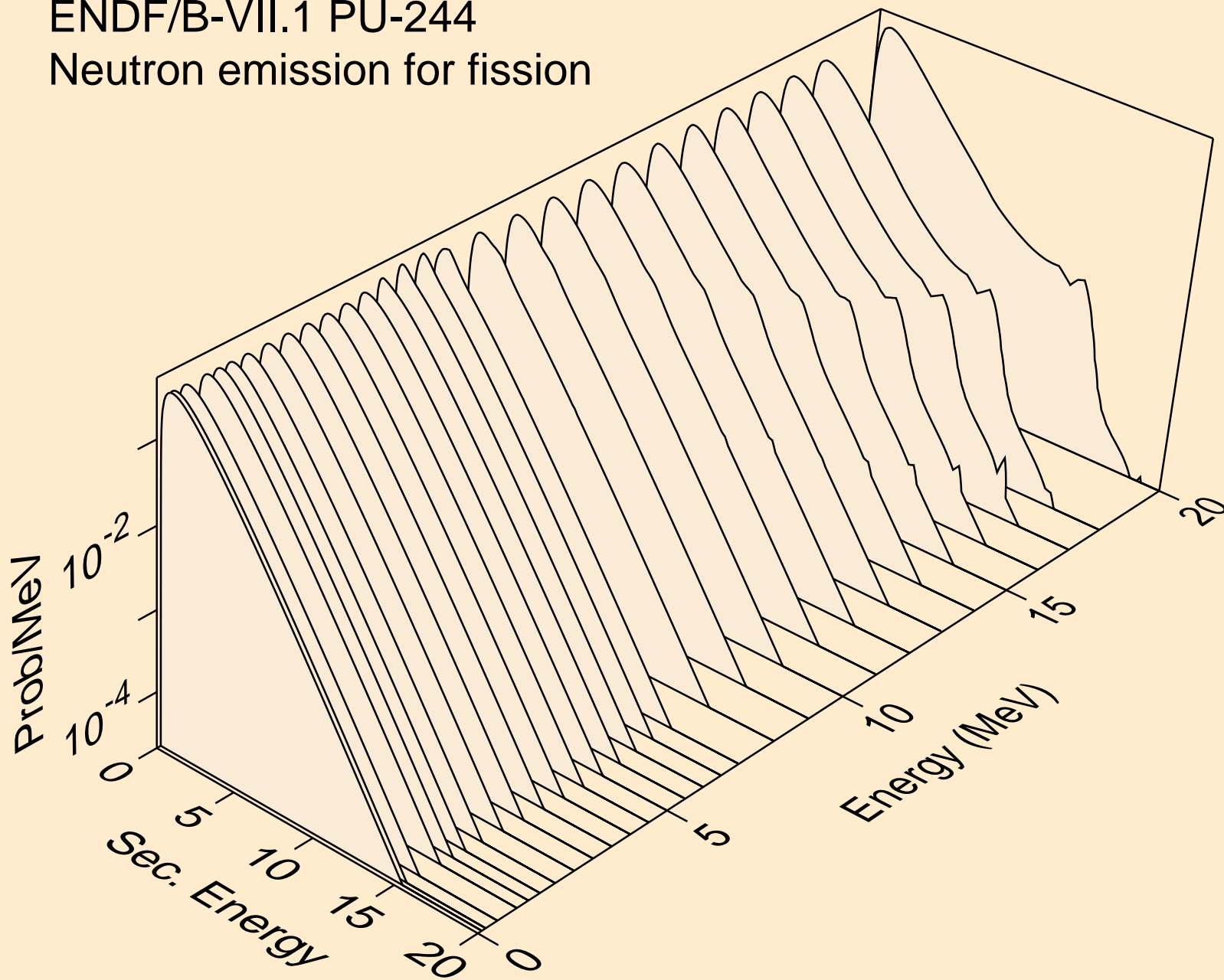

ENDF/B-VII.1 PU-244  
Neutron emission for (n,4n)

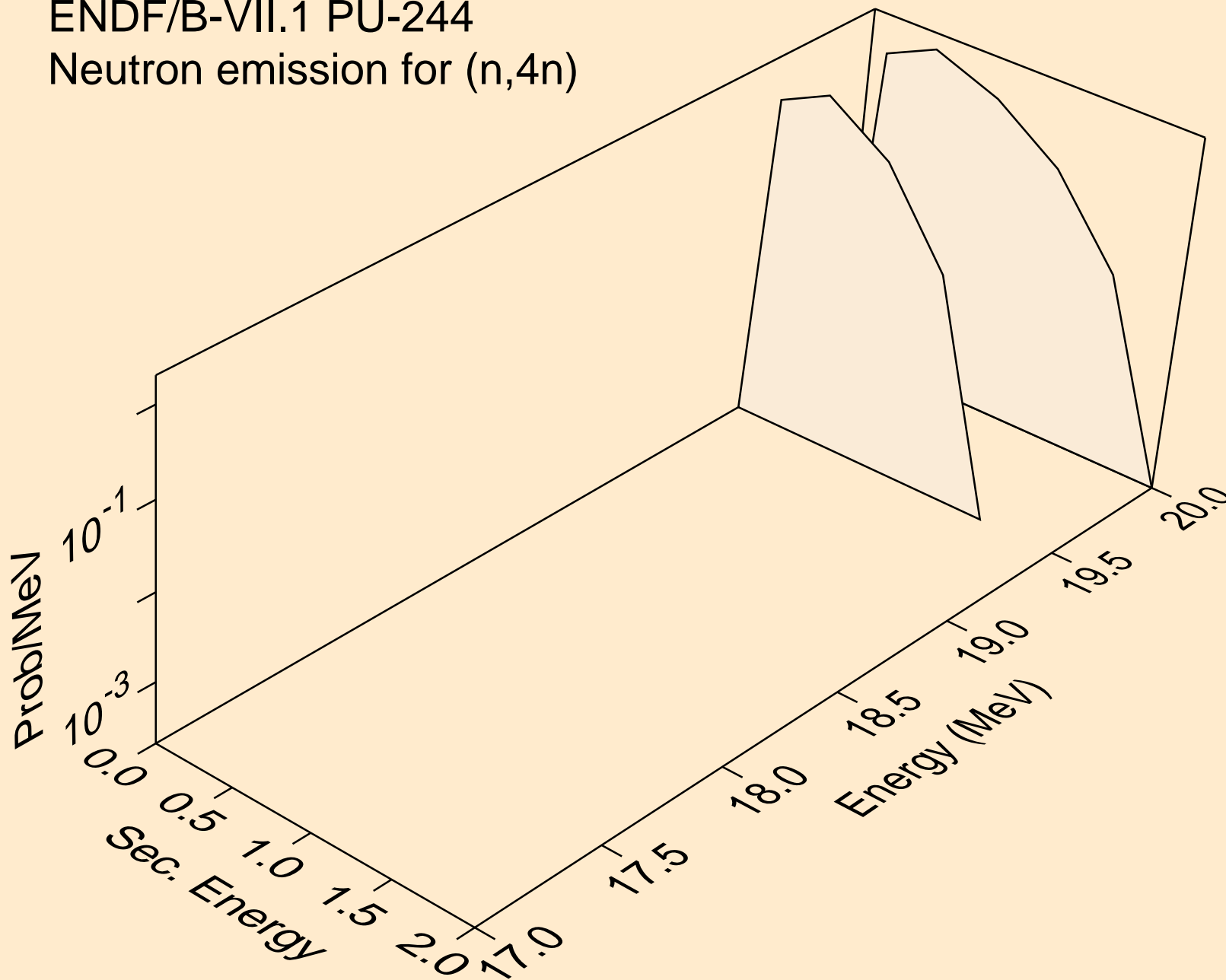

ENDF/B-VII.1 PU-244  
Neutron emission for (n,n\*c)

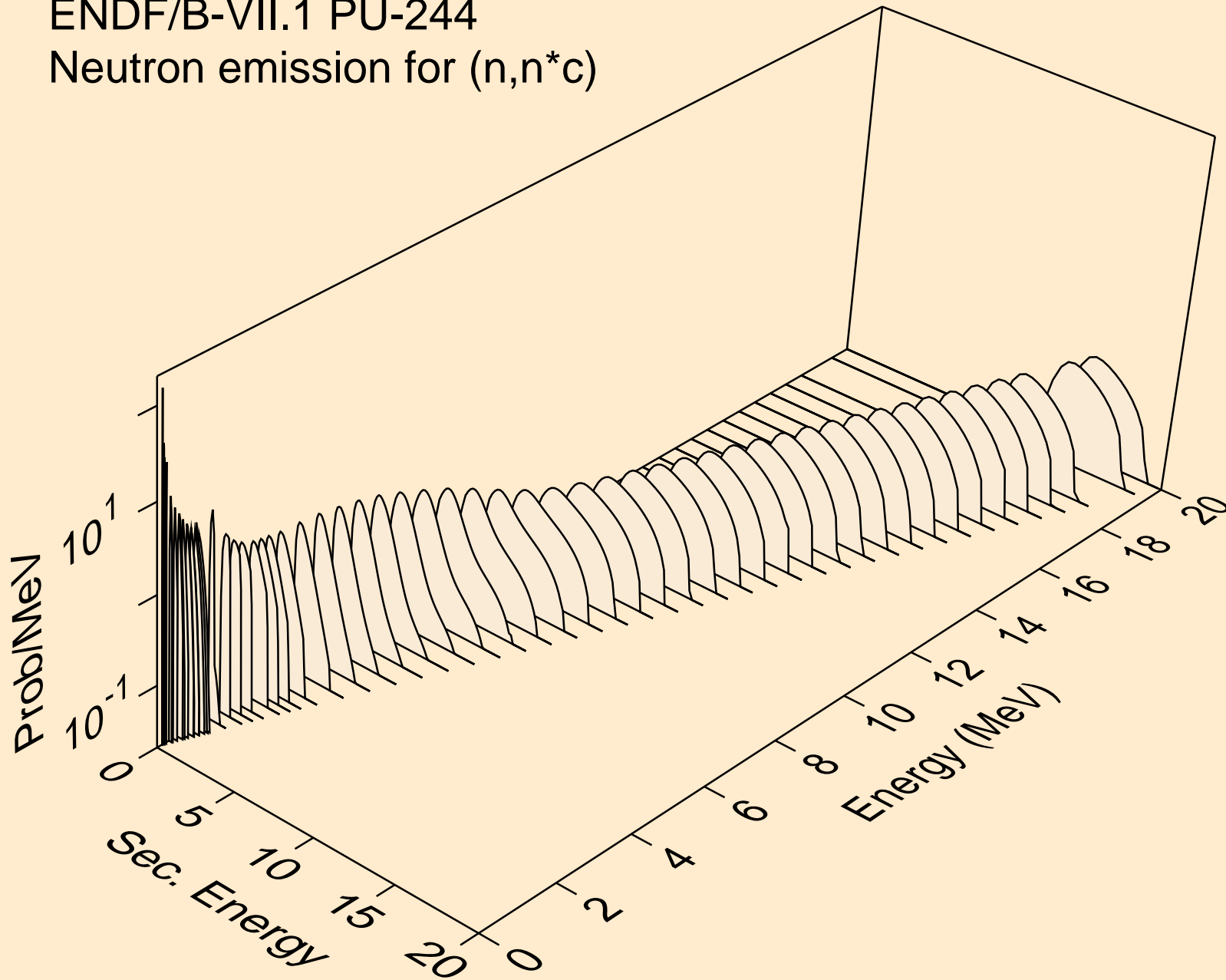

ENDF/B-VII.1 PU-244  
Photon emission for fission

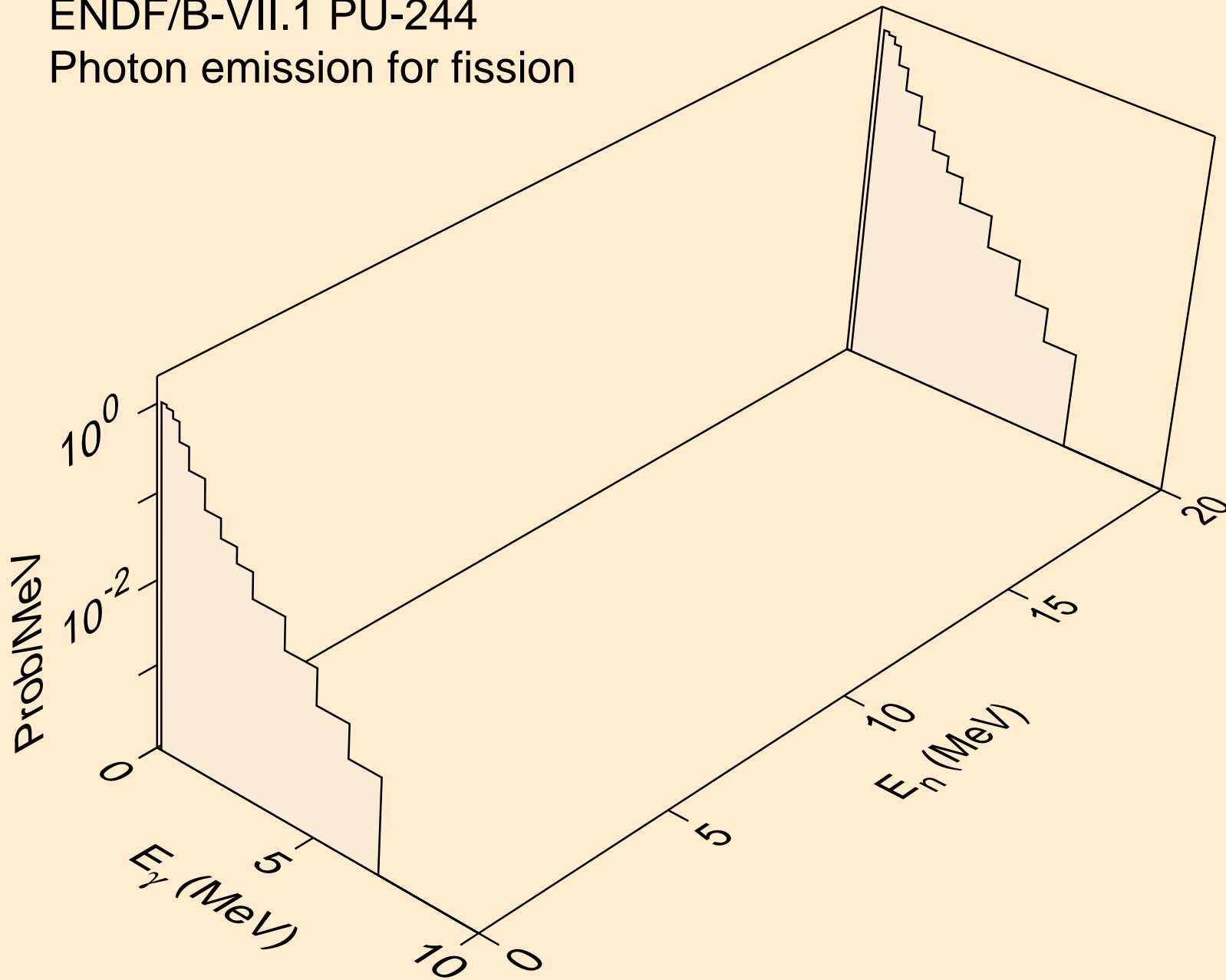

ENDF/B-VII.1 PU-244  
Photon emission for (n,2n)

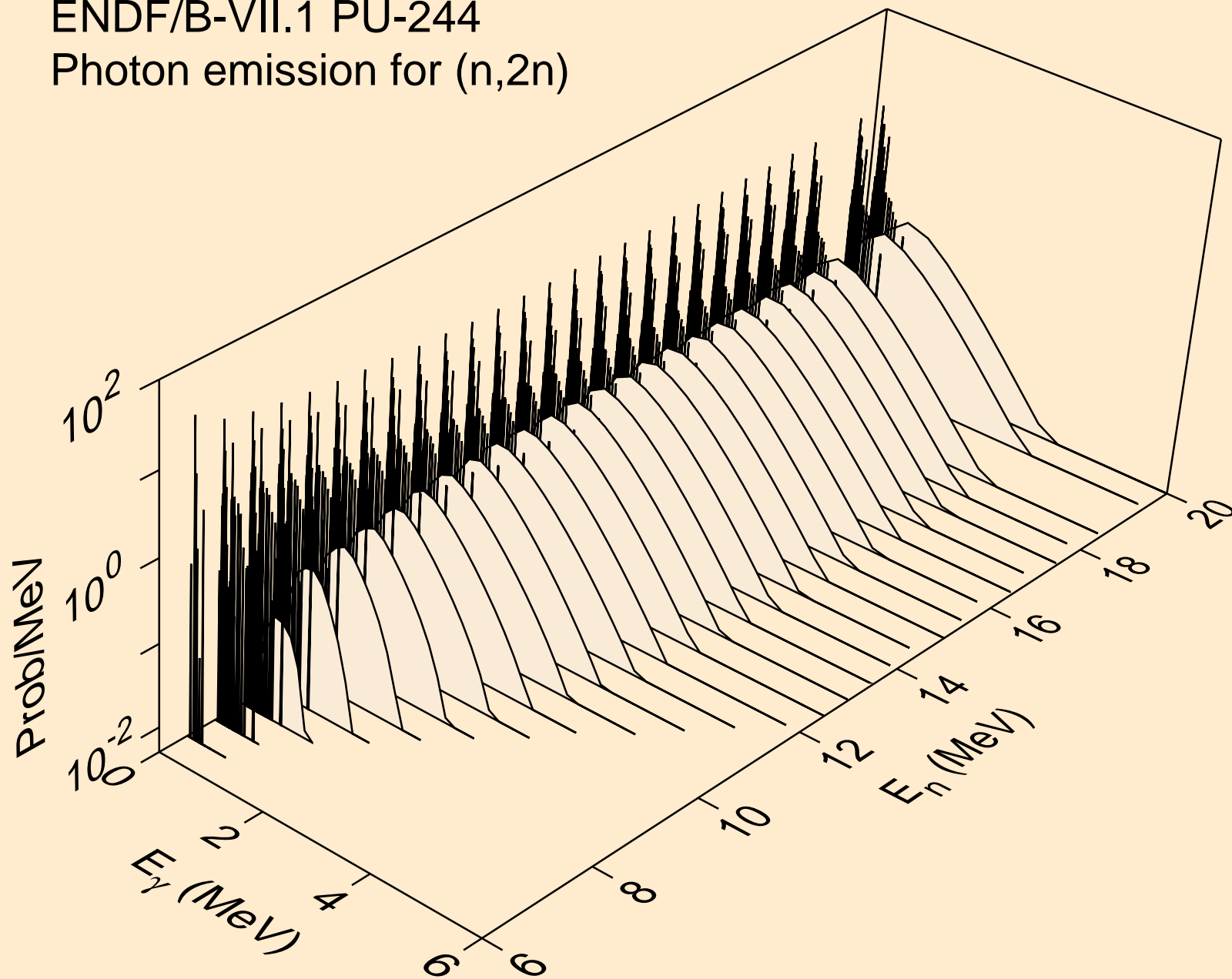

ENDF/B-VII.1 PU-244  
Photon emission for (n,3n)

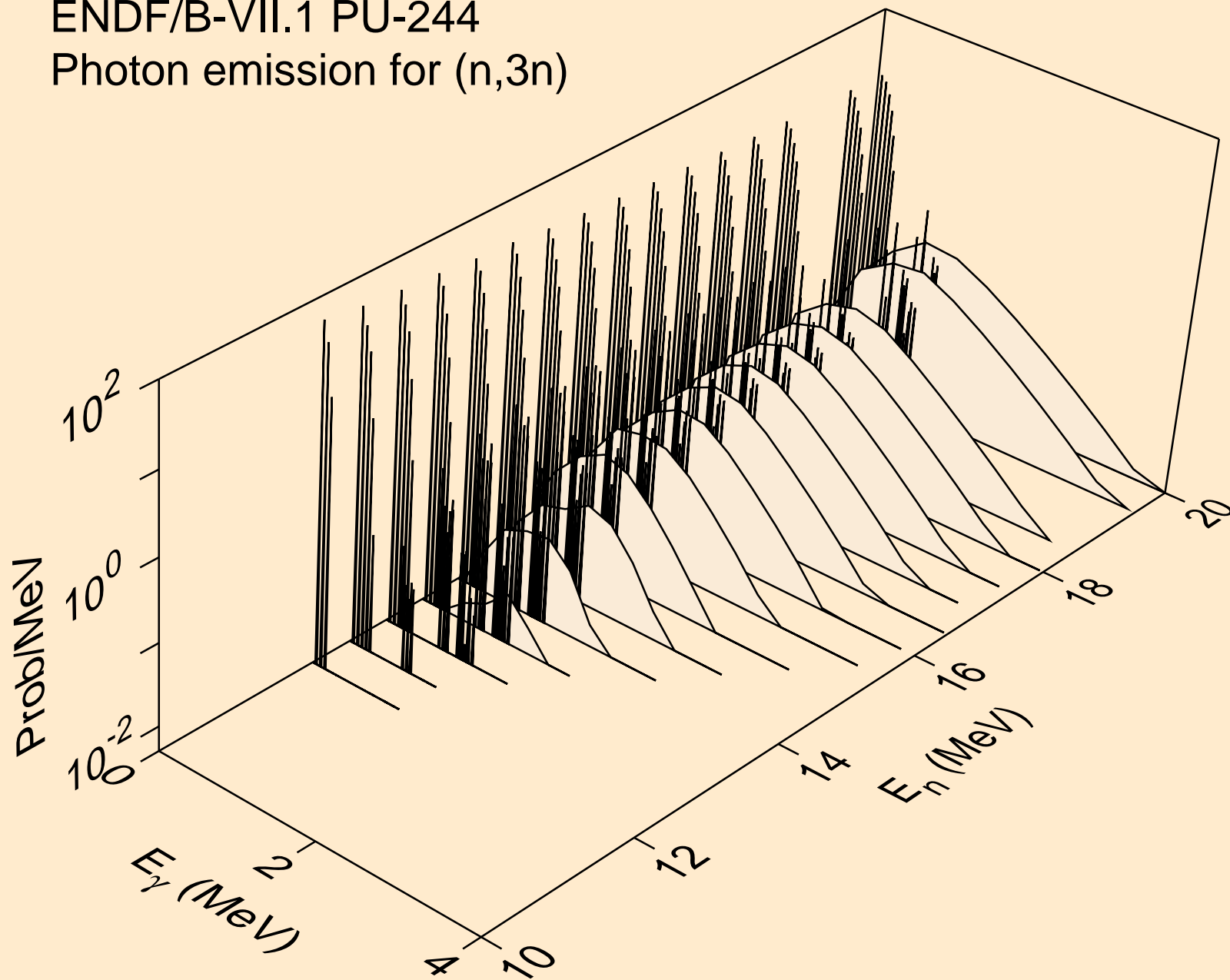

ENDF/B-VII.1 PU-244  
Photon emission for (n,4n)

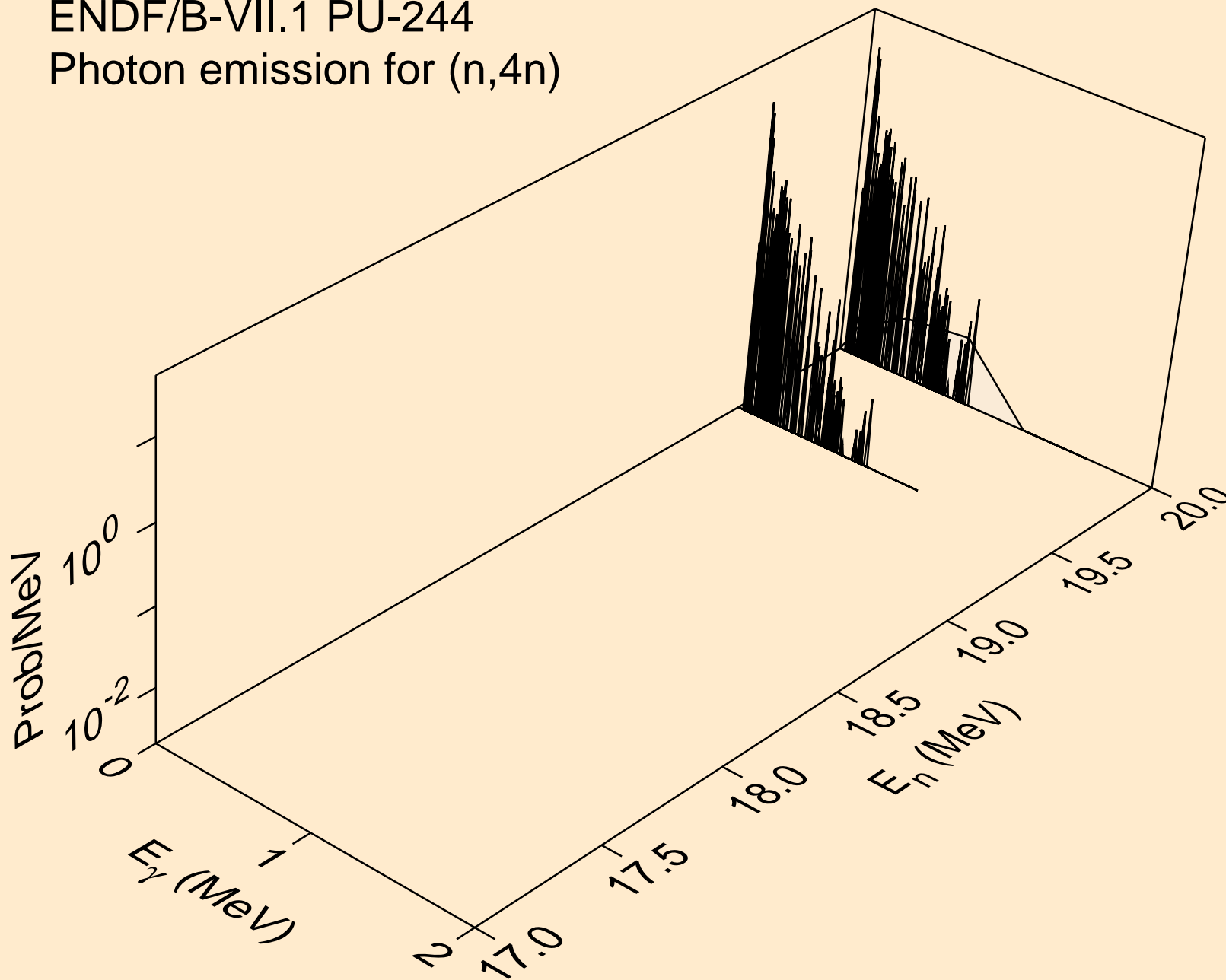



ENDF/B-VII.1 PU-244  
Photon emission for (n,n\*1)

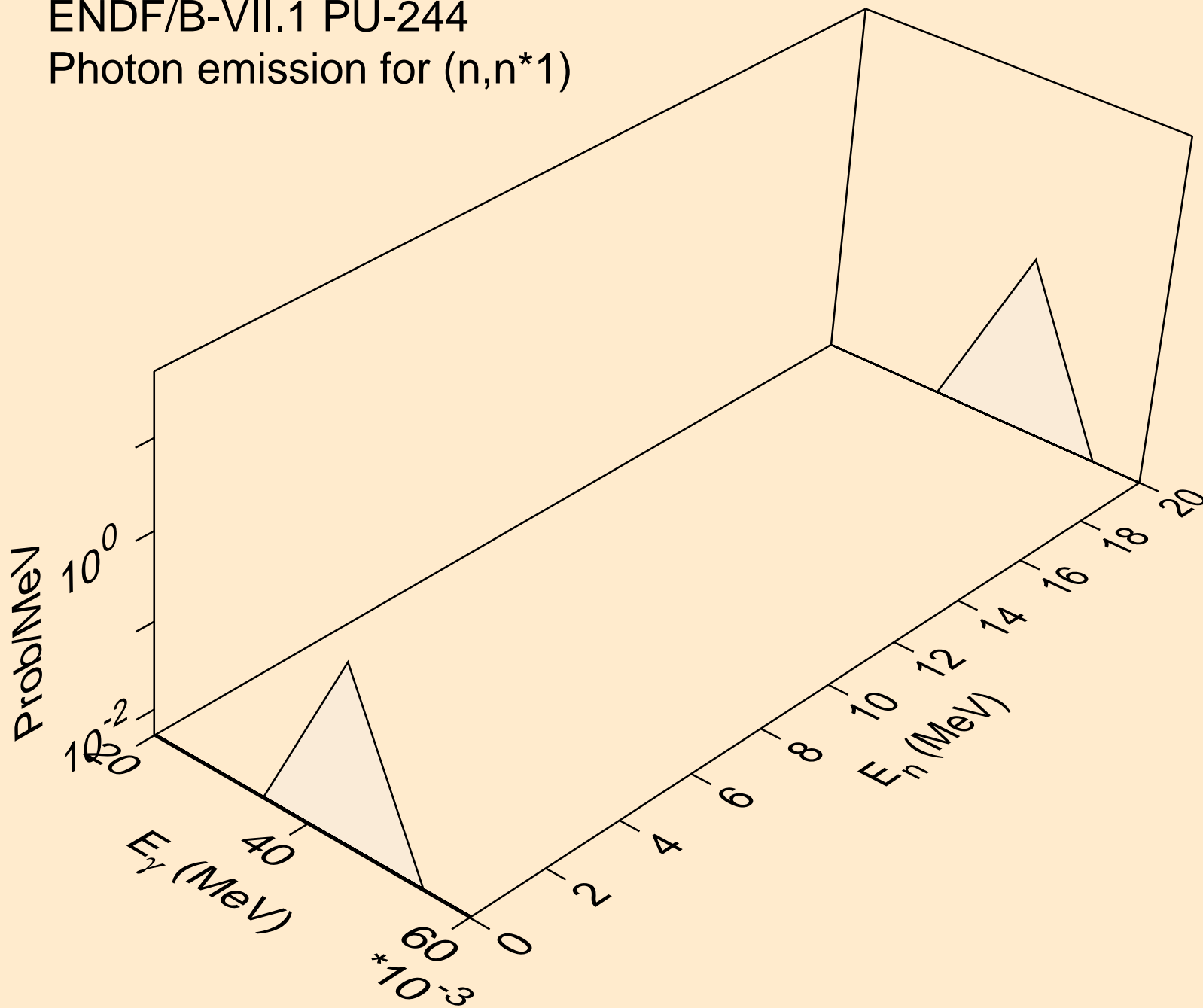

ENDF/B-VII.1 PU-244  
Photon emission for (n,n\*2)

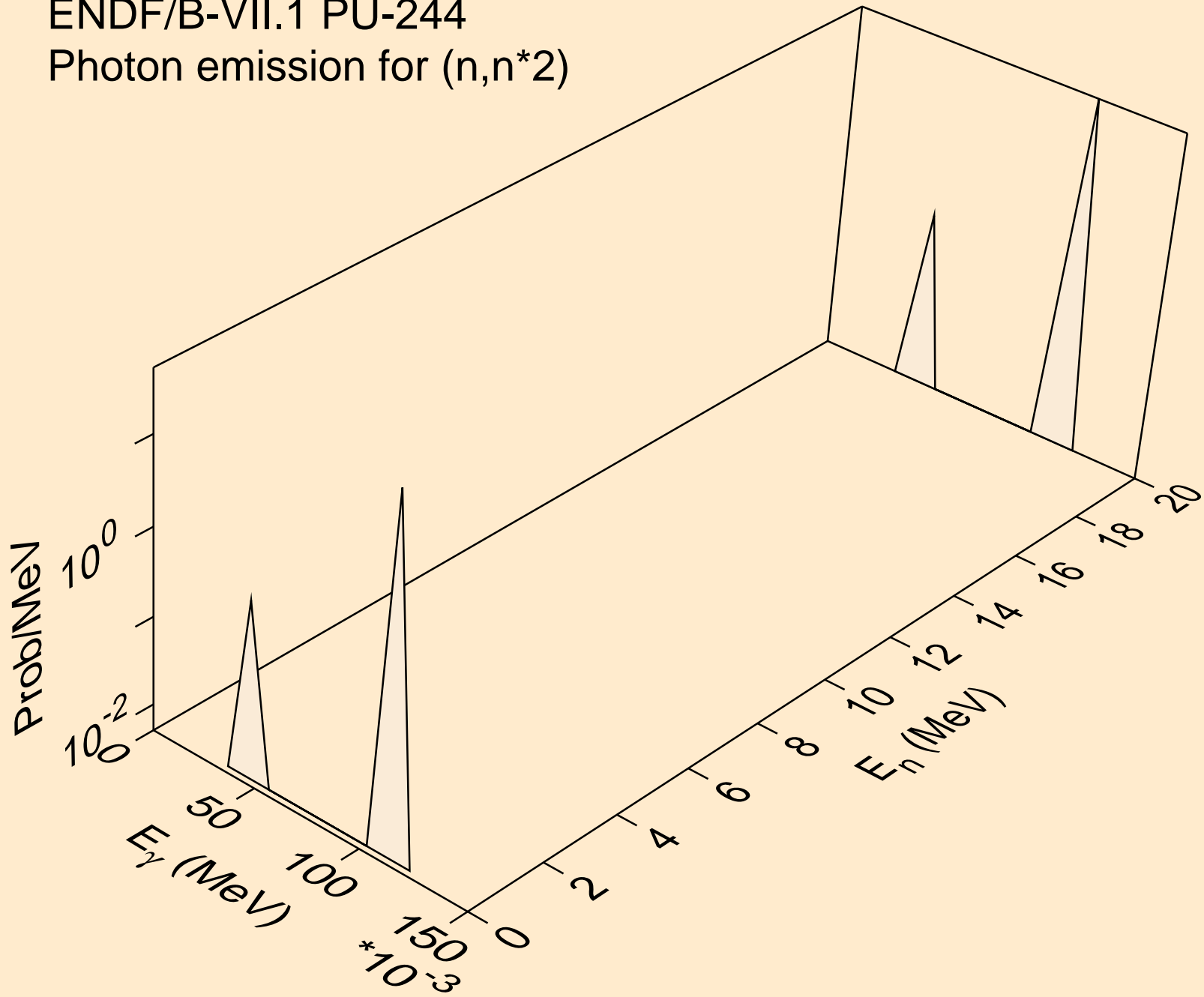

ENDF/B-VII.1 PU-244  
Photon emission for (n,n\*3)

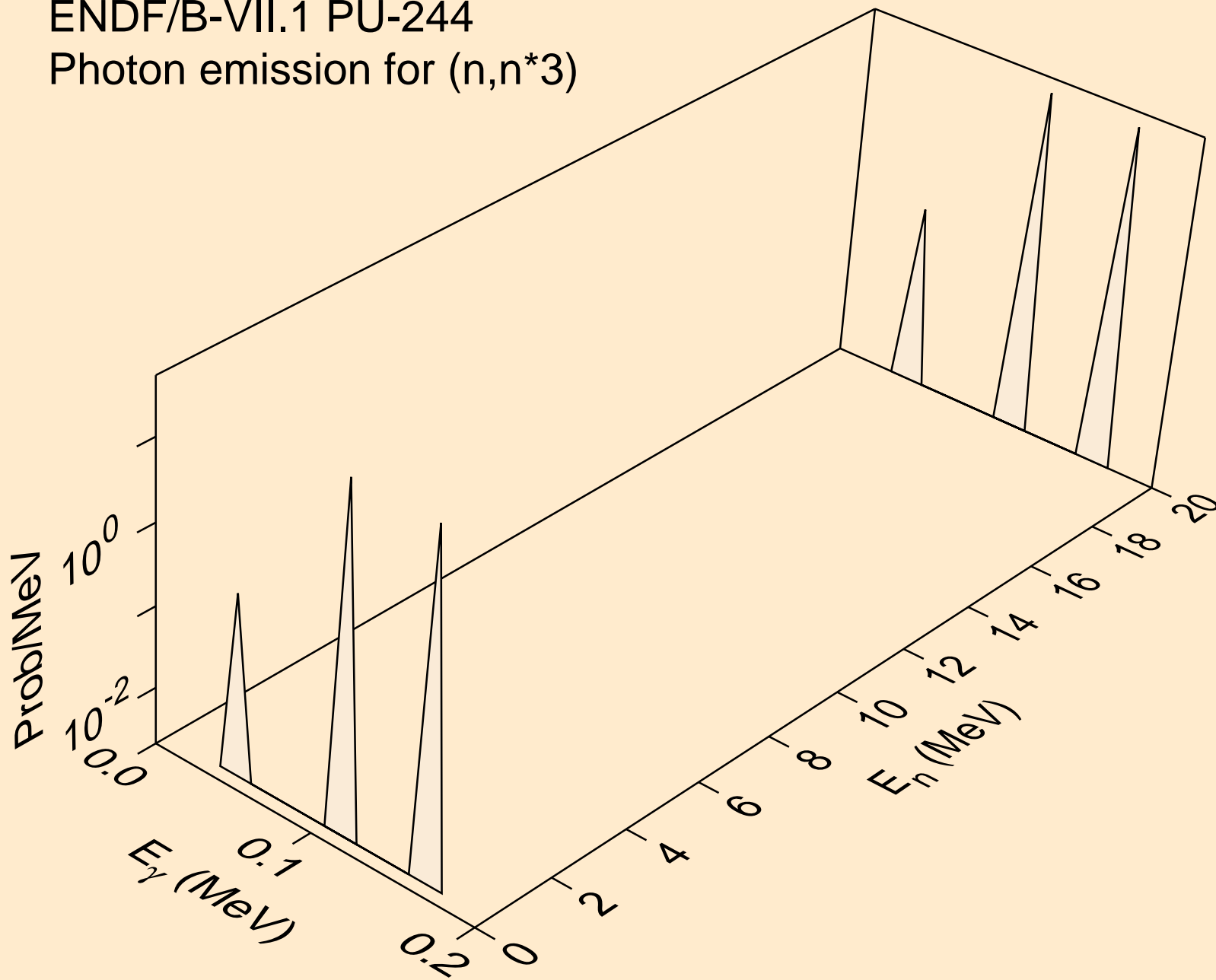

ENDF/B-VII.1 PU-244  
Photon emission for (n,n\*4)

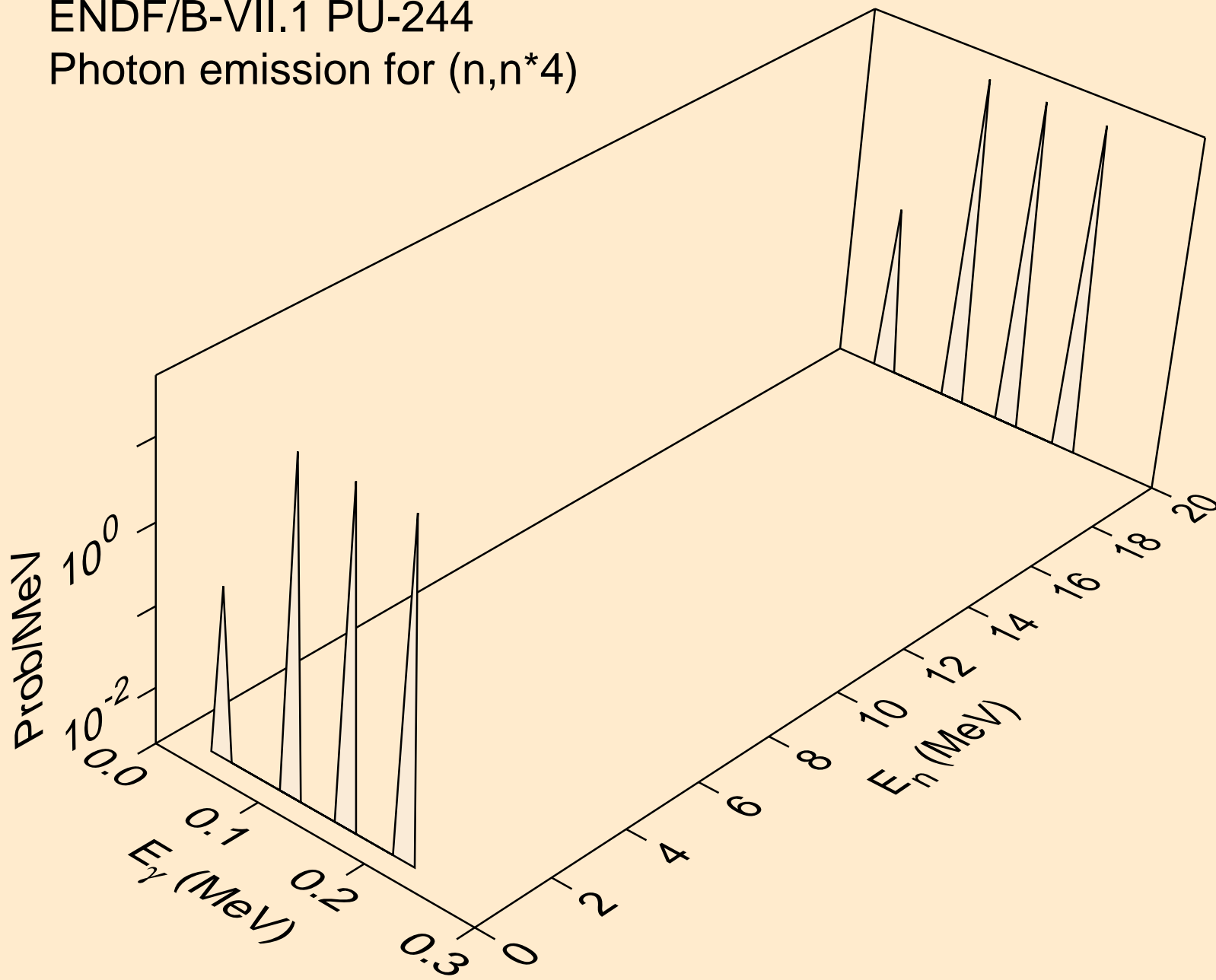

ENDF/B-VII.1 PU-244  
Photon emission for (n,n\*5)

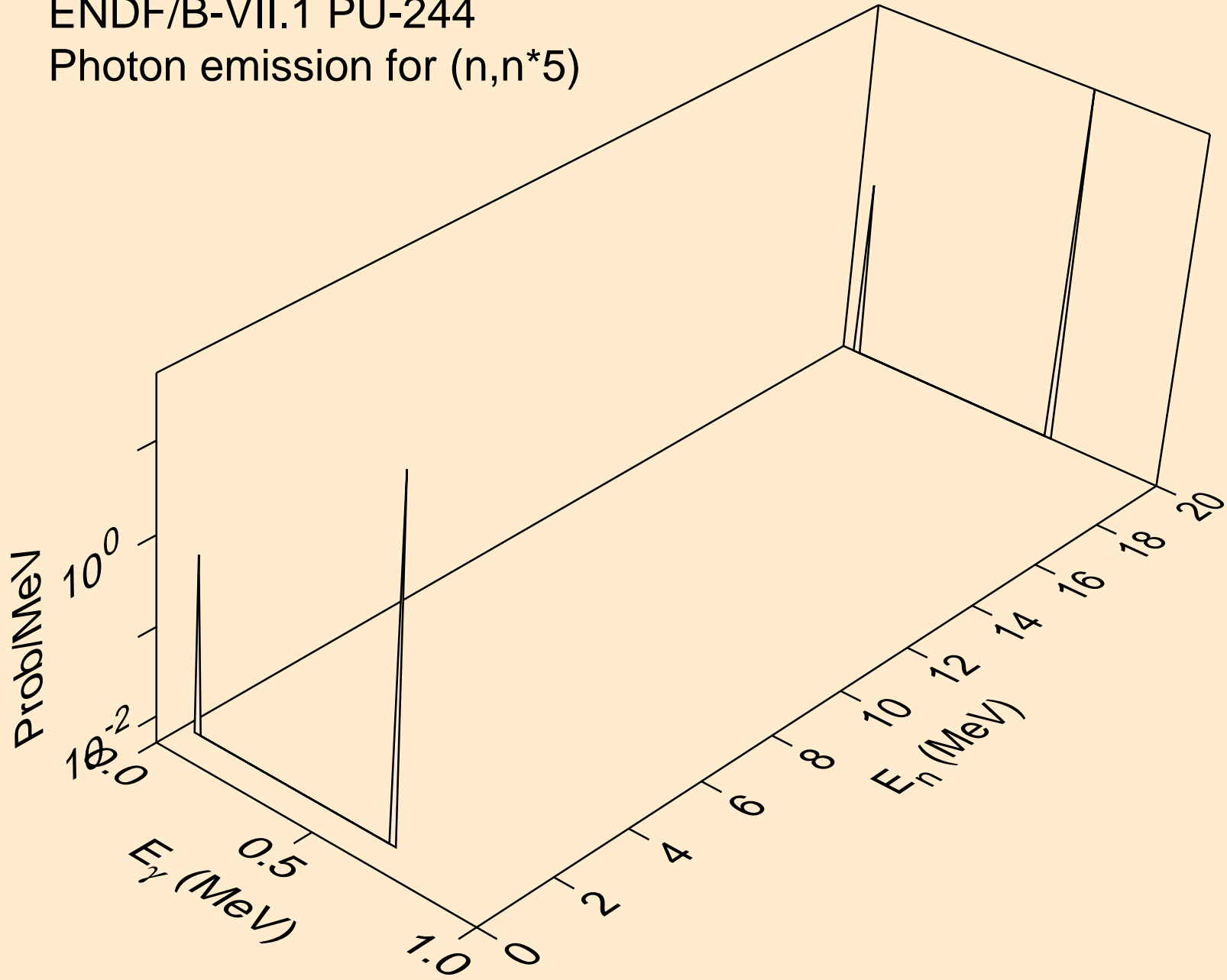

ENDF/B-VII.1 PU-244  
Photon emission for (n,n\*6)

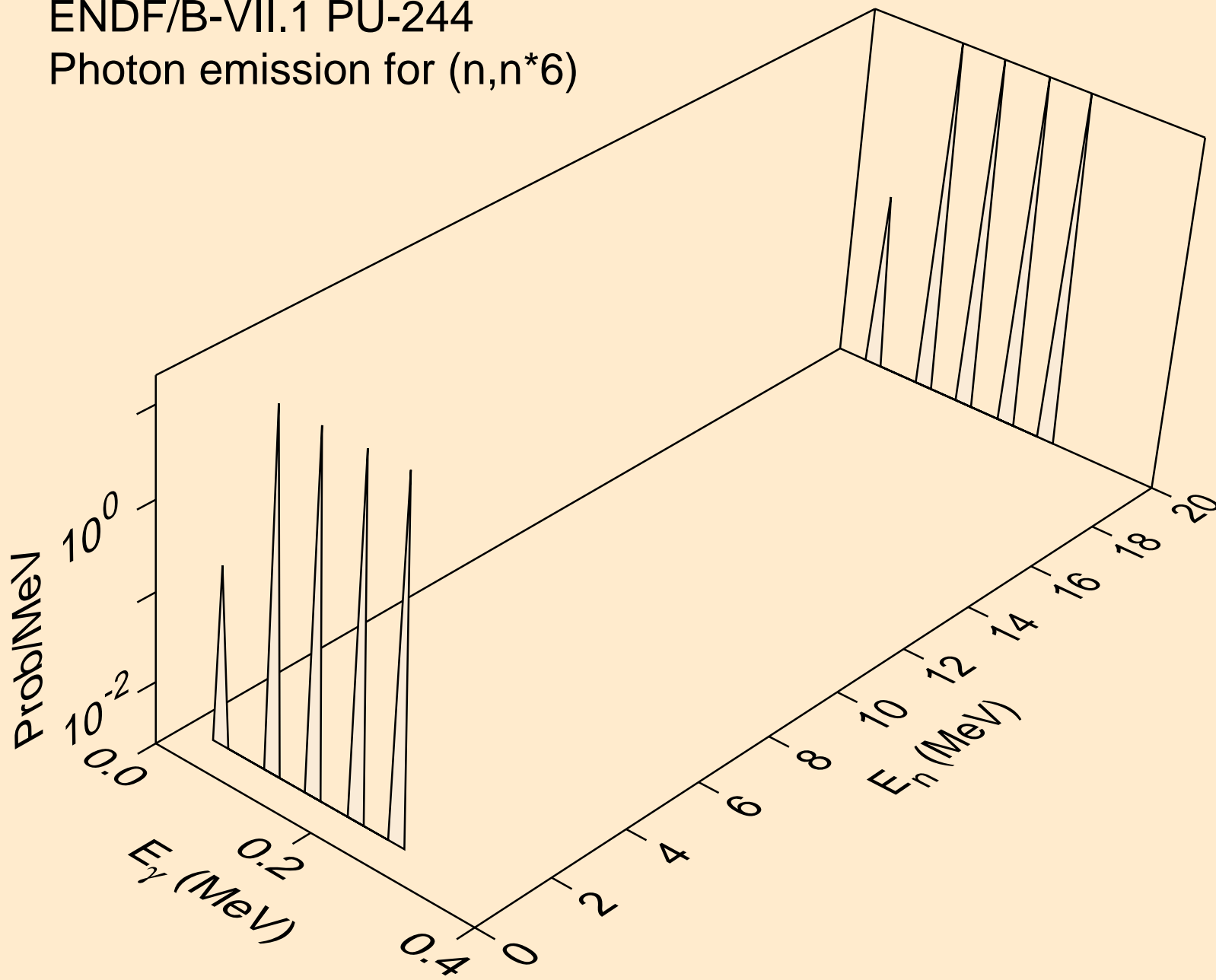

ENDF/B-VII.1 PU-244  
Photon emission for (n,n\*7)

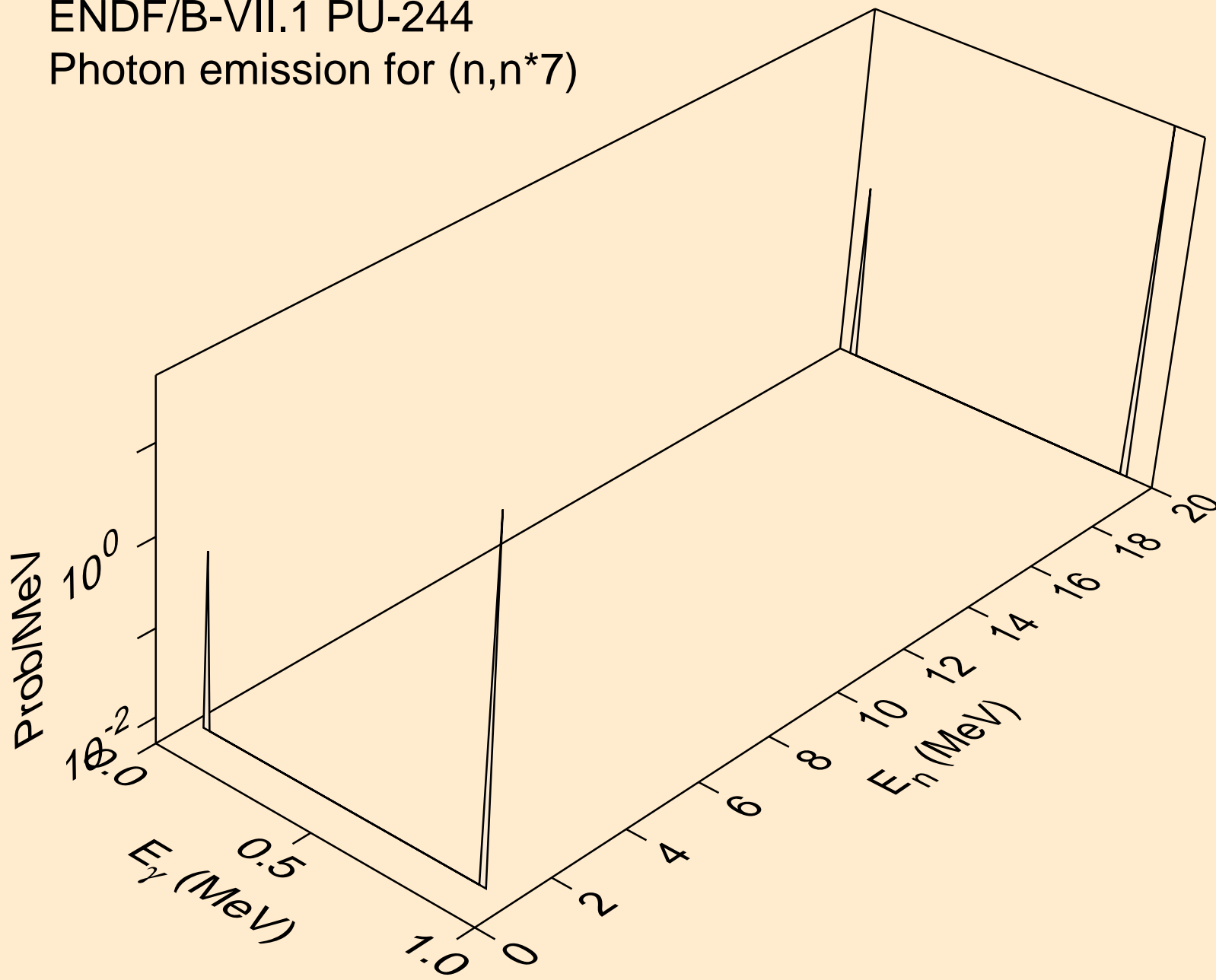

ENDF/B-VII.1 PU-244  
Photon emission for (n,n\*c)

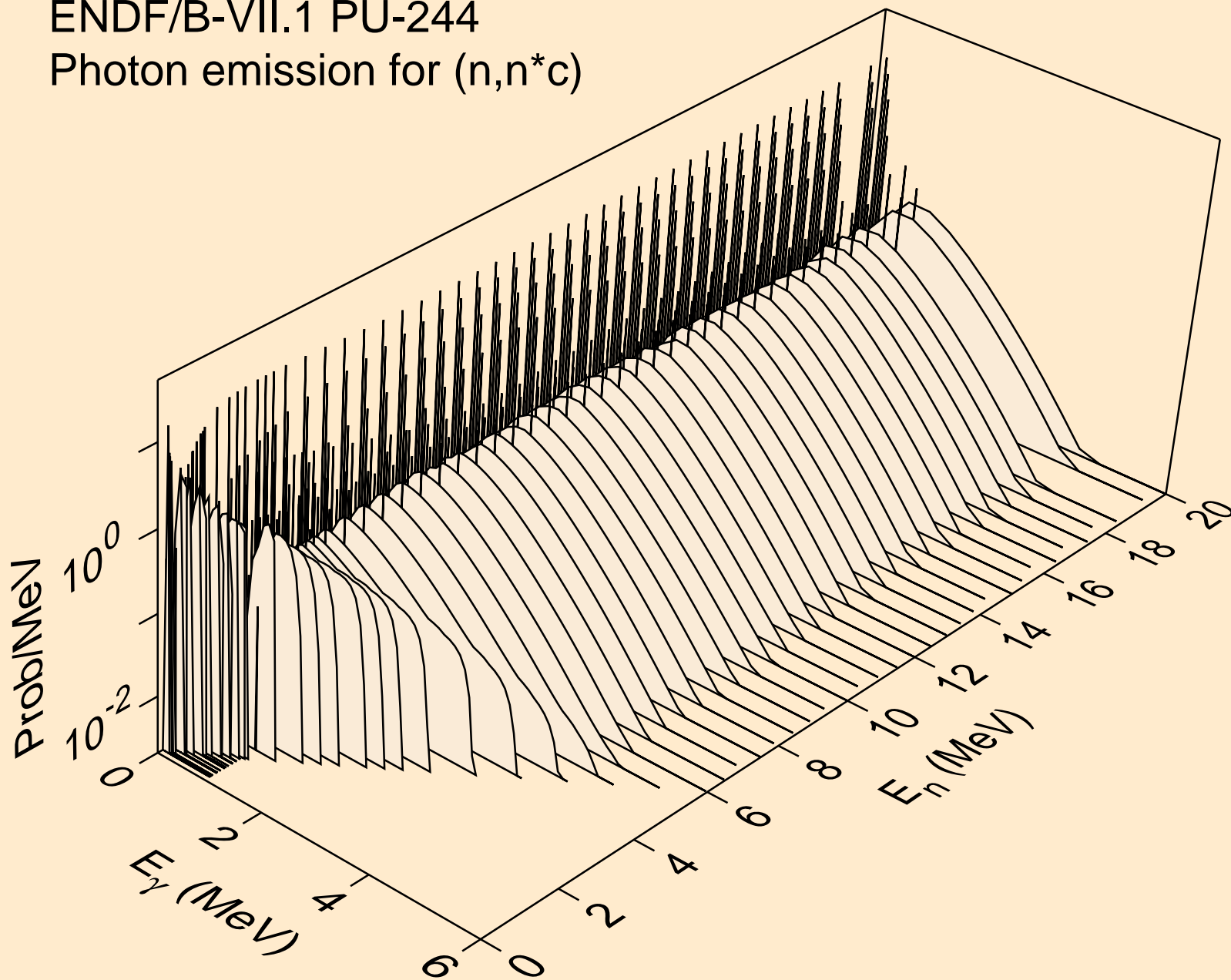



ENDF/B-VII.1 PU-244  
Photon emission for (n,gma)

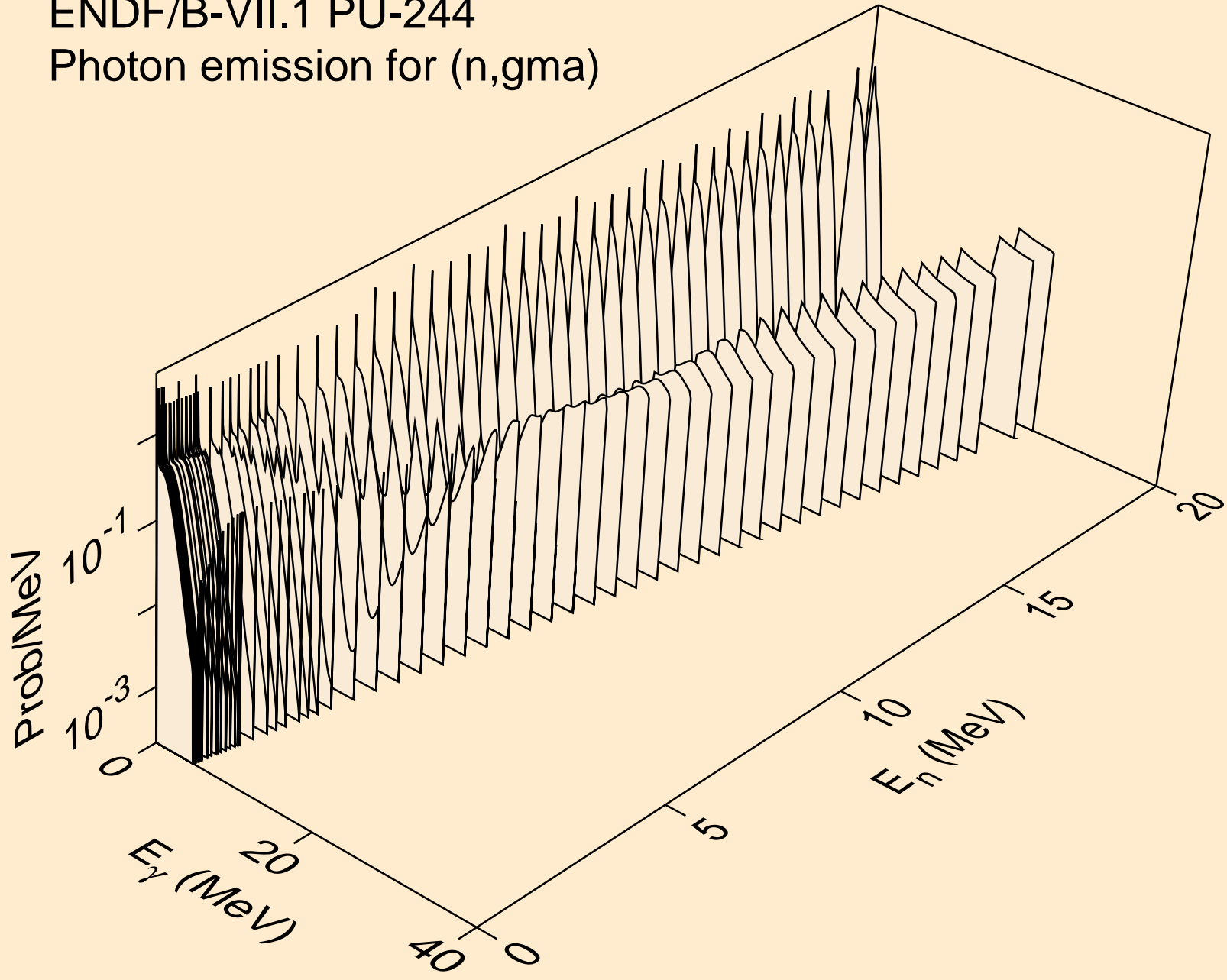

ENDF/B-VII.1 PU-244  
thermal capture photon spectrum

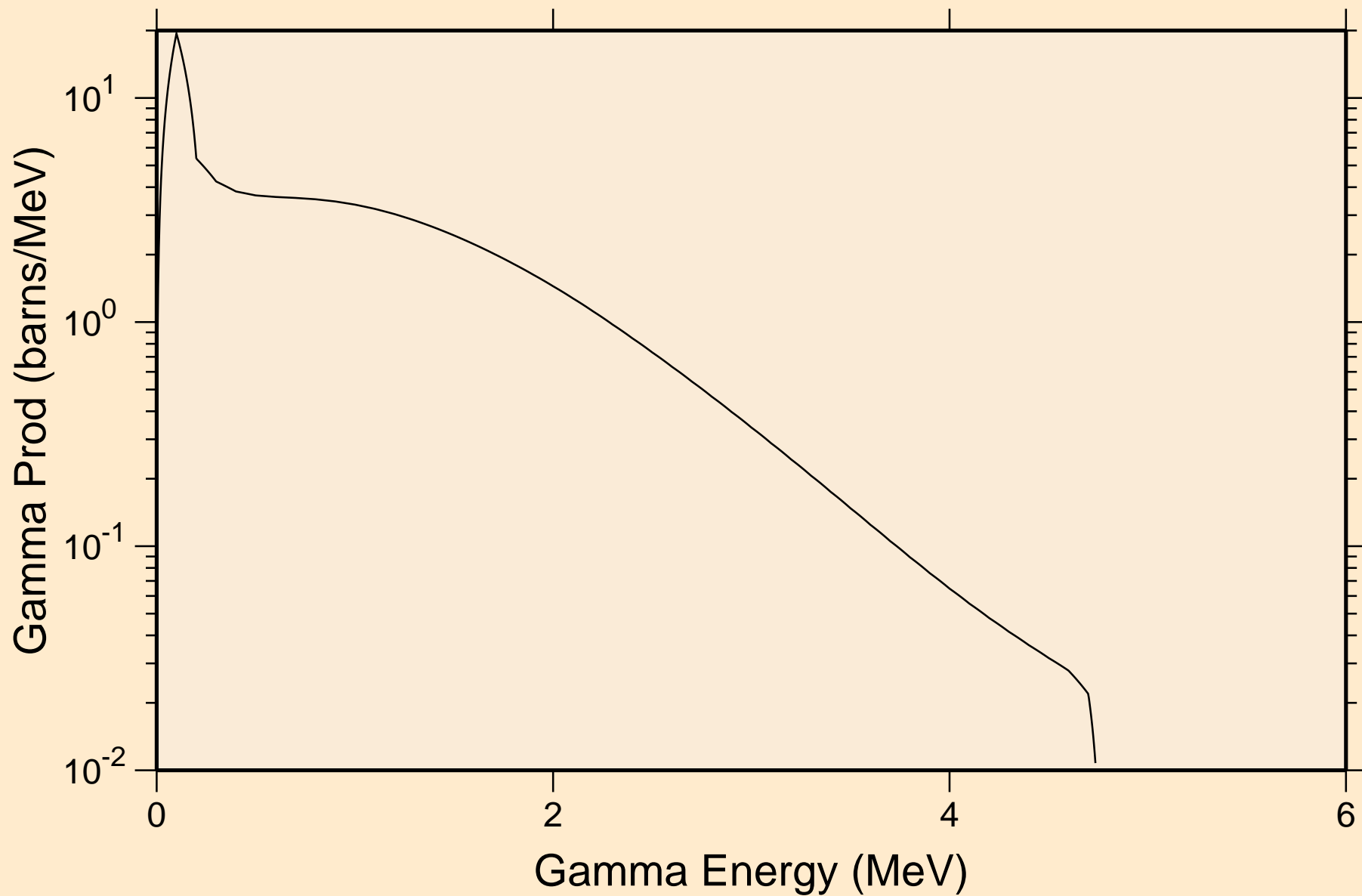

ENDF/B-VII.1 PU-244  
14 MeV photon spectrum

