

ENDF/B-VII.1 PA-233

Principal cross sections

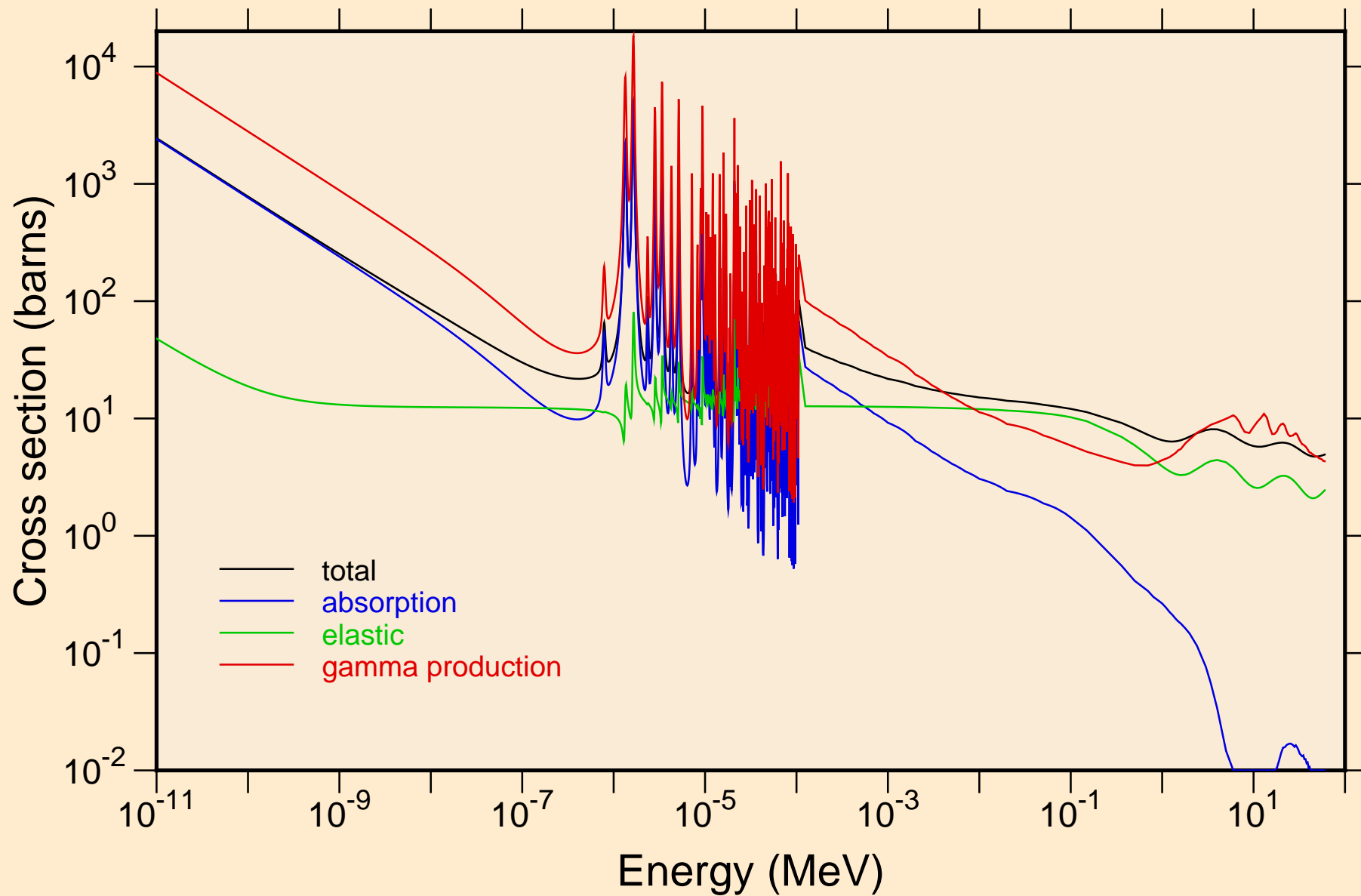

ENDF/B-VII.1 PA-233
resonance total cross section

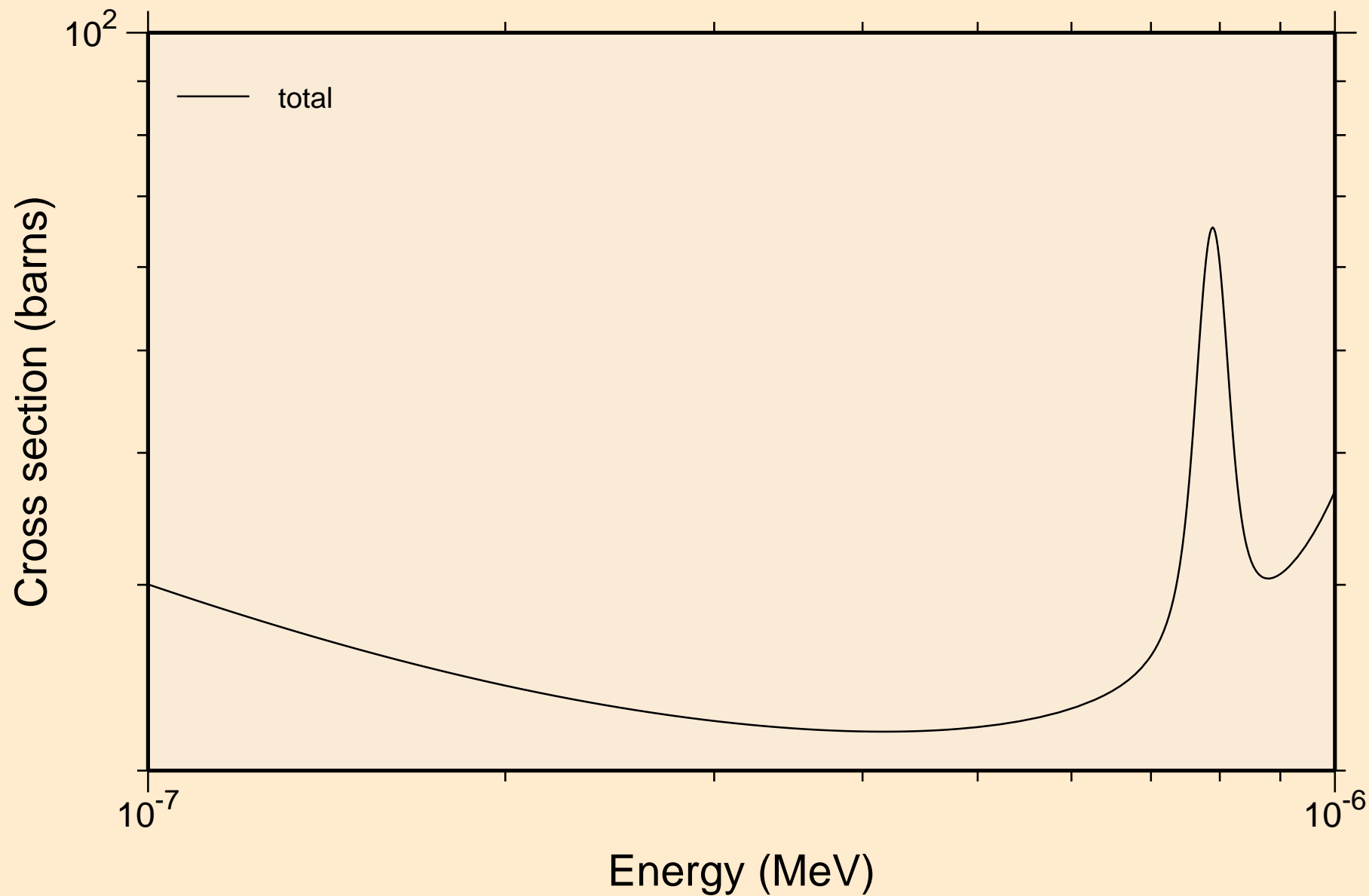

ENDF/B-VII.1 PA-233
resonance total cross section

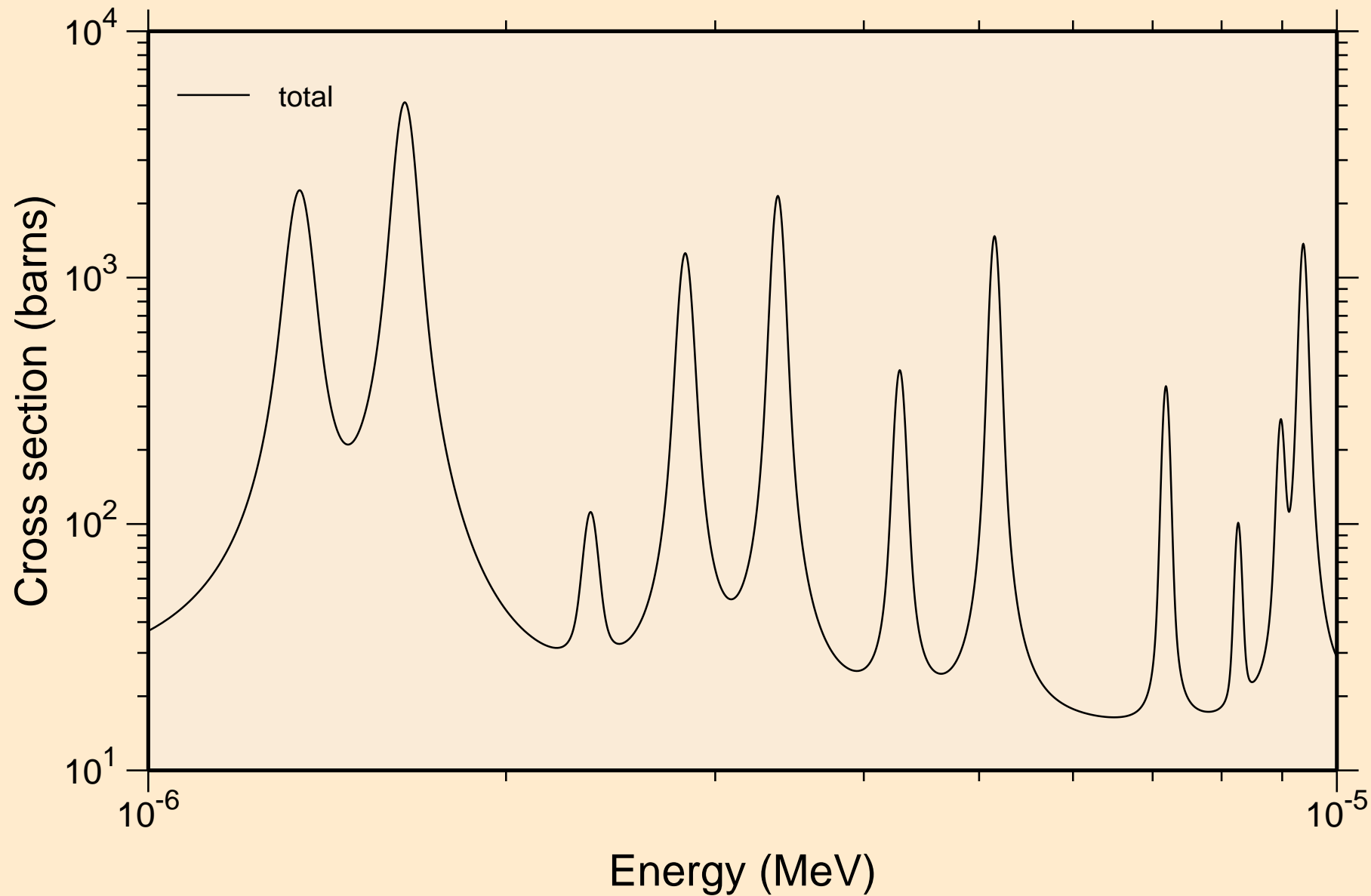

ENDF/B-VII.1 PA-233
resonance total cross section

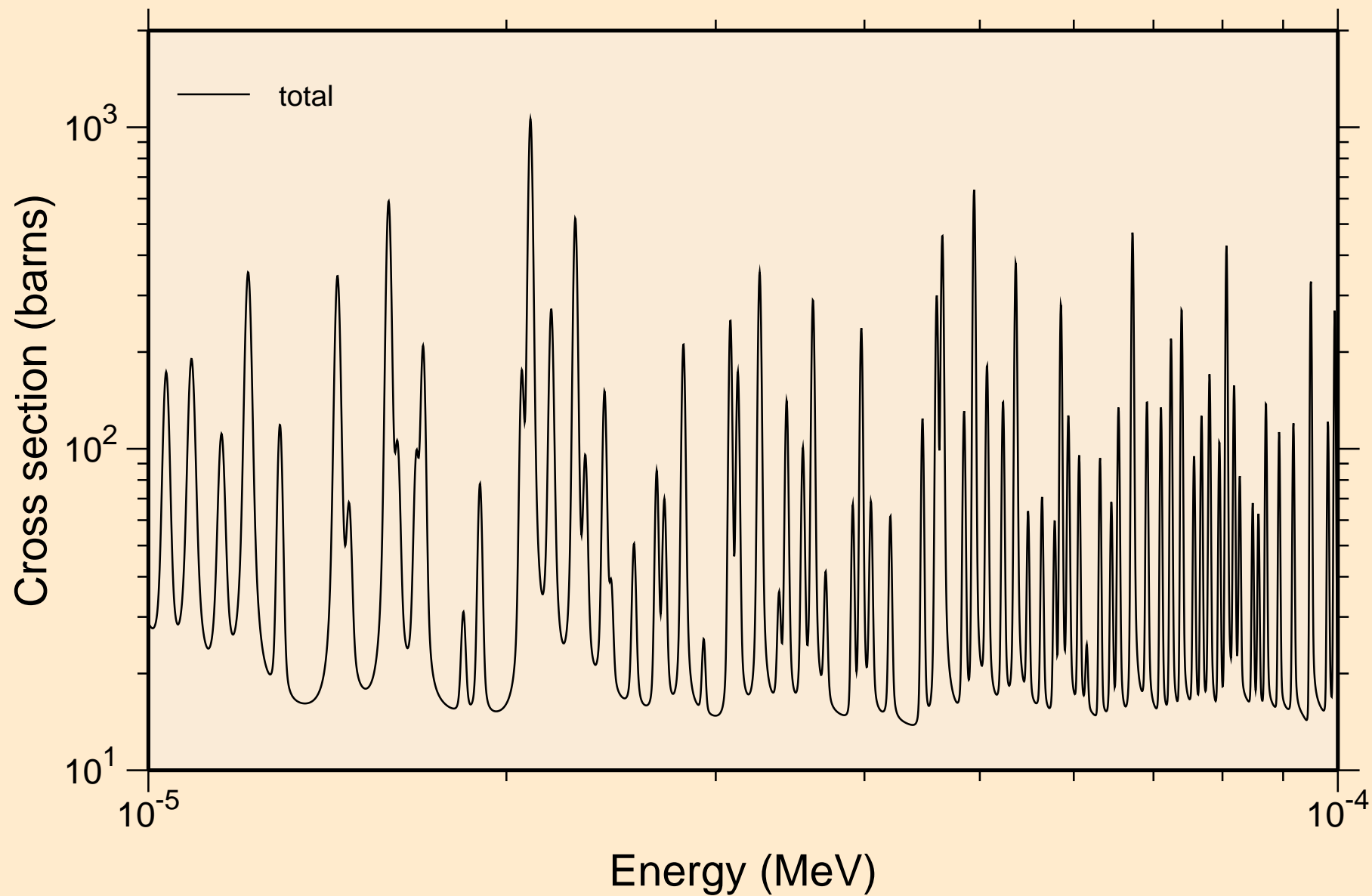

ENDF/B-VII.1 PA-233
resonance total cross section

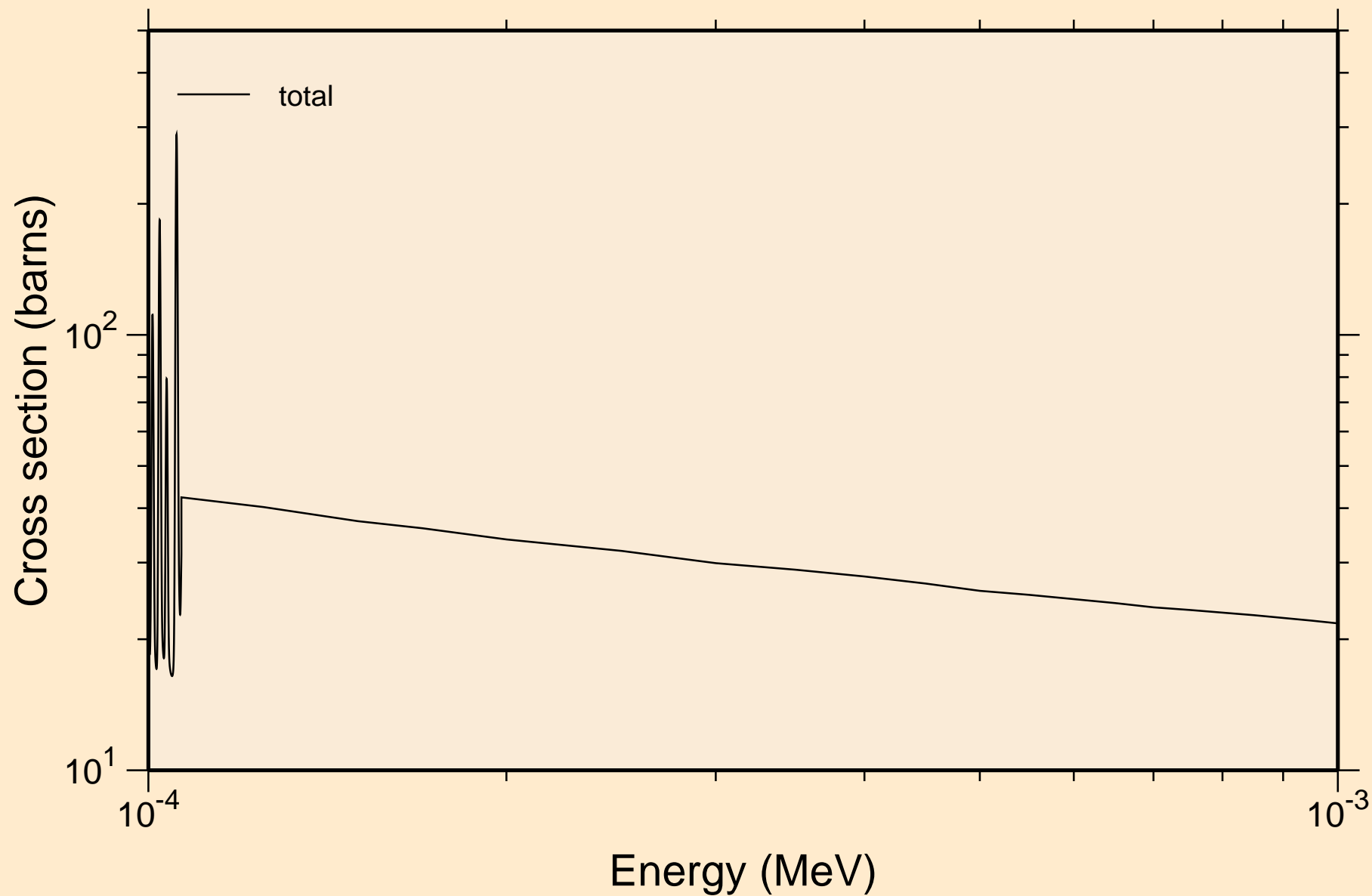

ENDF/B-VII.1 PA-233
resonance absorption cross sections

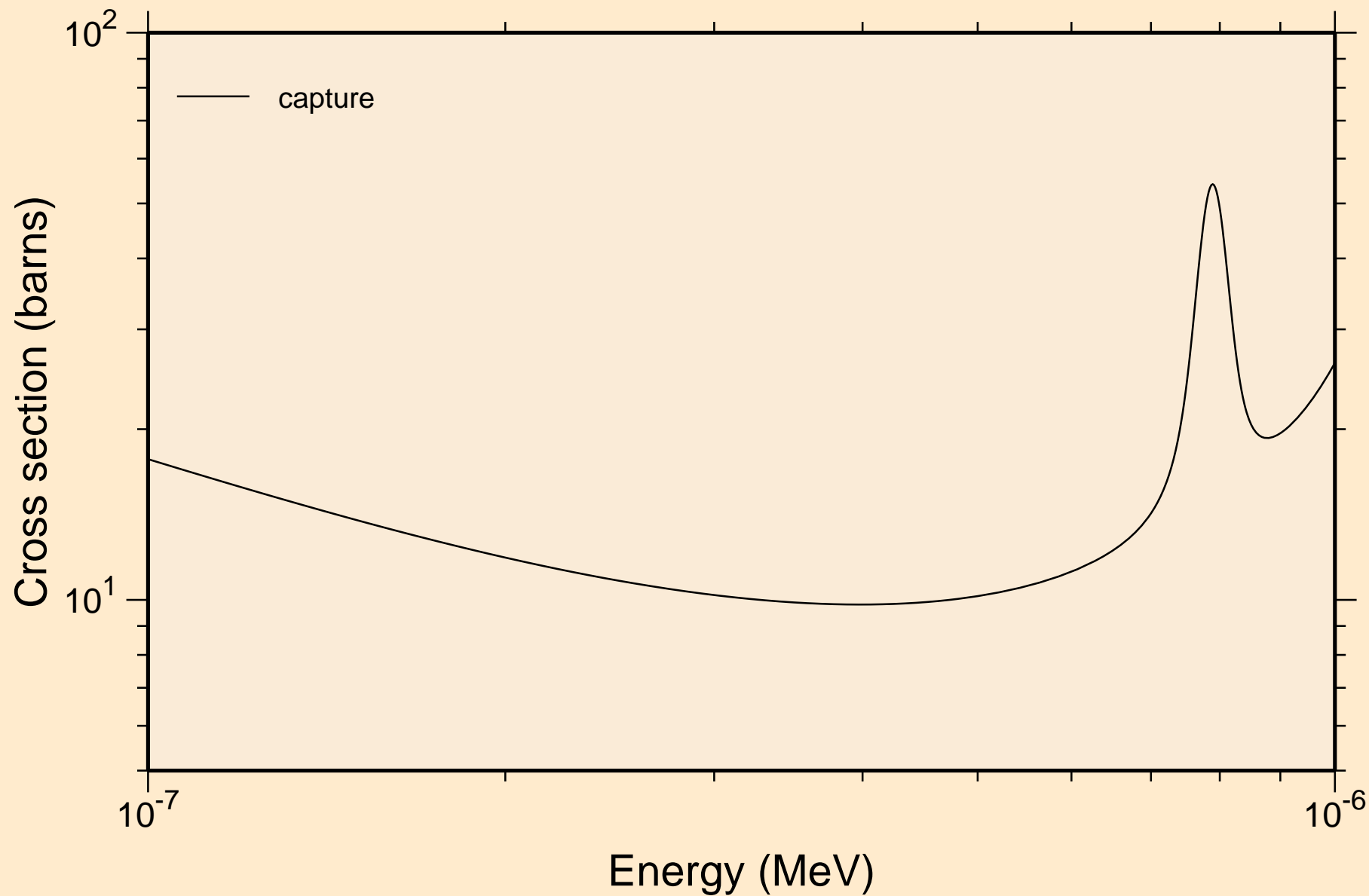

ENDF/B-VII.1 PA-233
resonance absorption cross sections

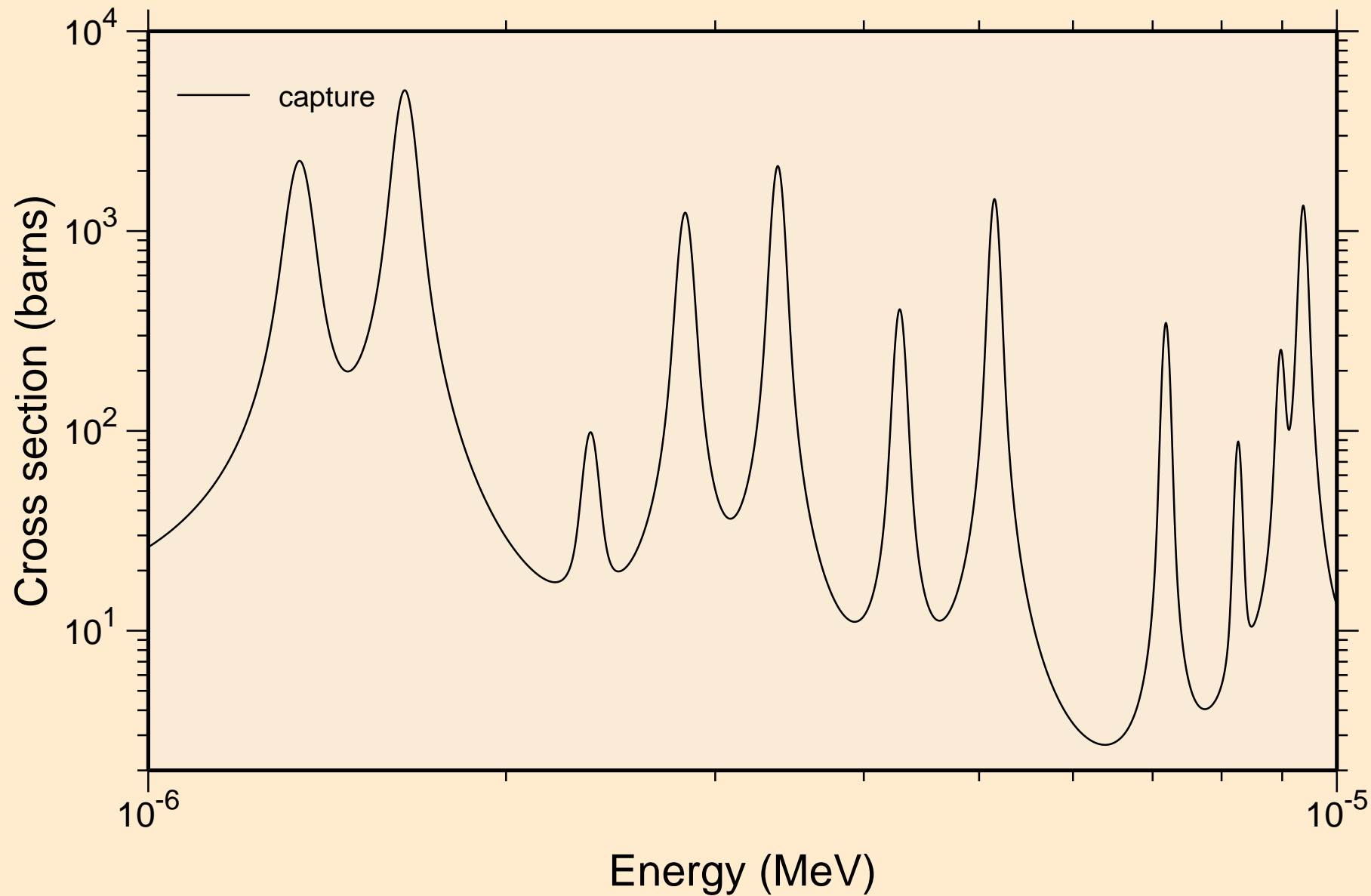

ENDF/B-VII.1 PA-233
resonance absorption cross sections

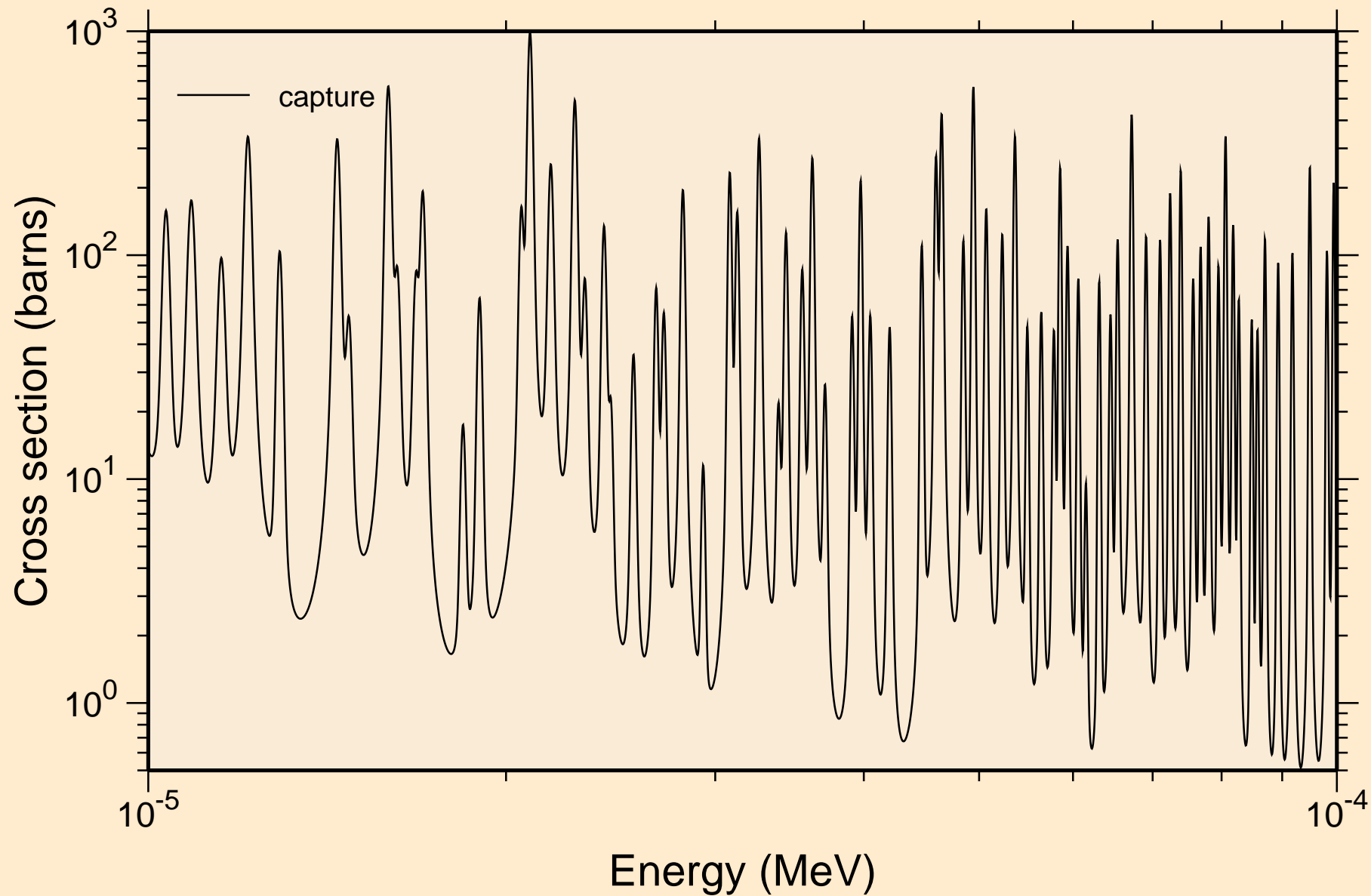

ENDF/B-VII.1 PA-233
resonance absorption cross sections

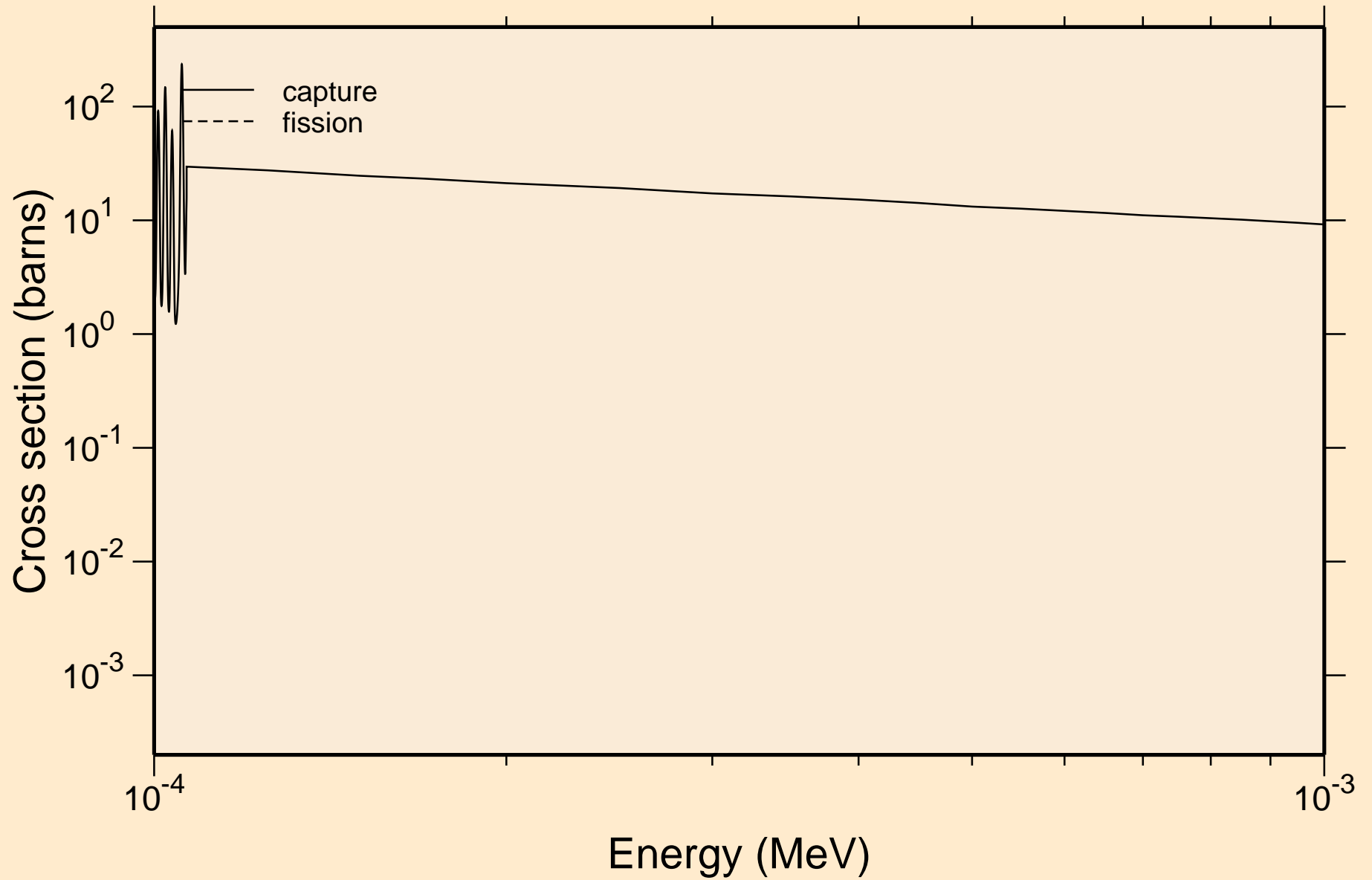

ENDF/B-VII.1 PA-233

UR total cross section

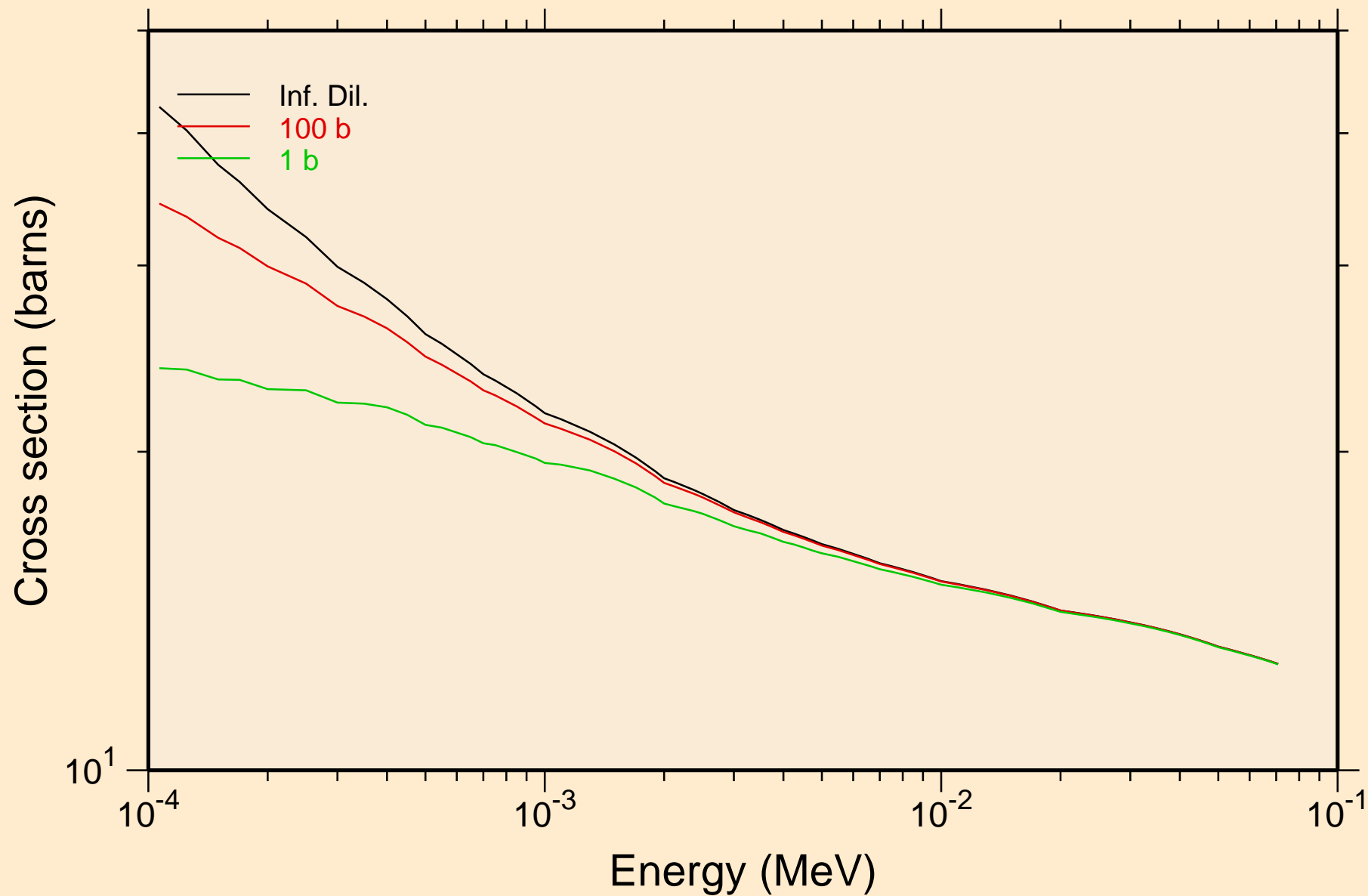

ENDF/B-VII.1 PA-233
UR elastic cross section

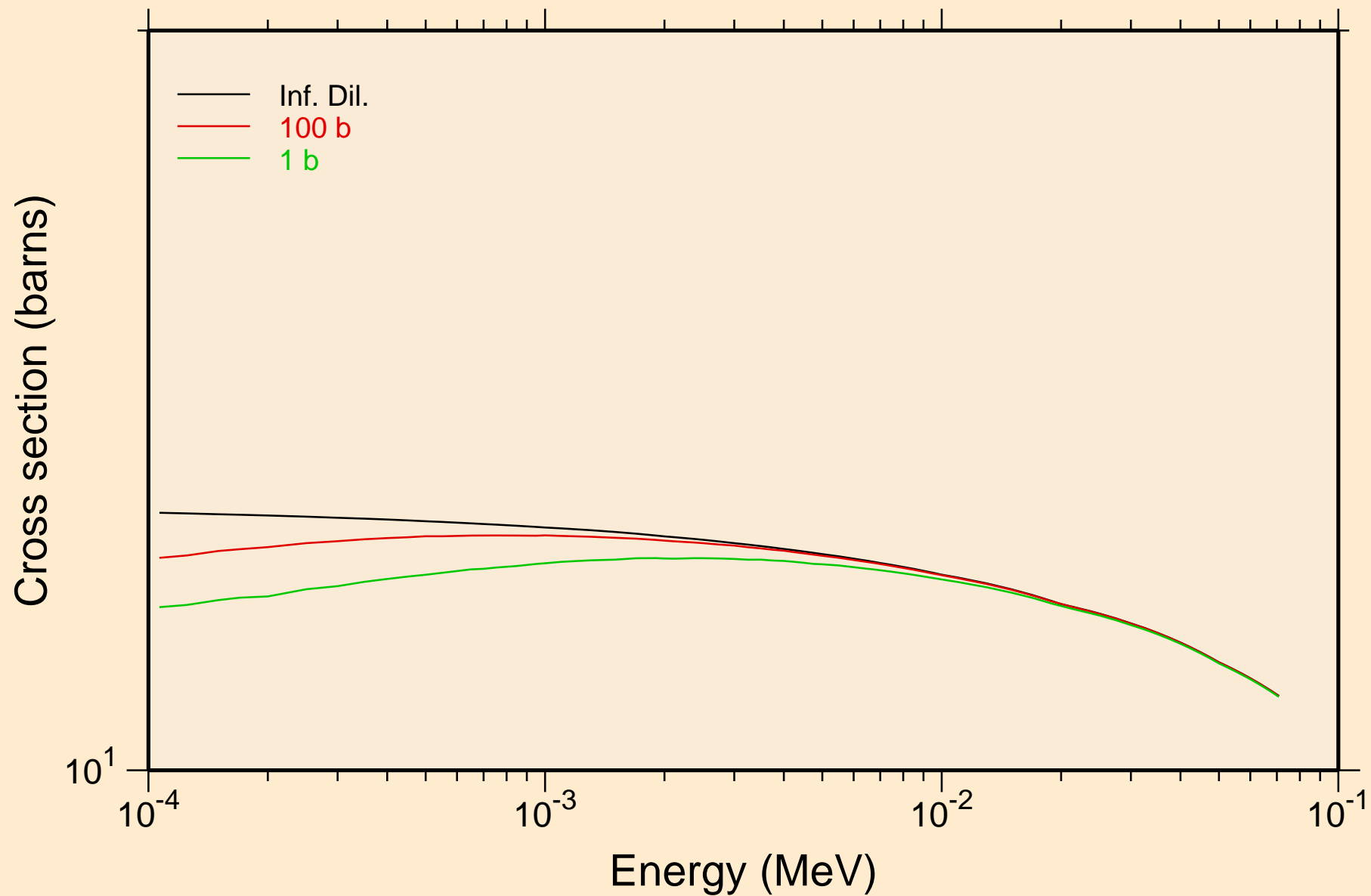

ENDF/B-VII.1 PA-233
UR fission cross section

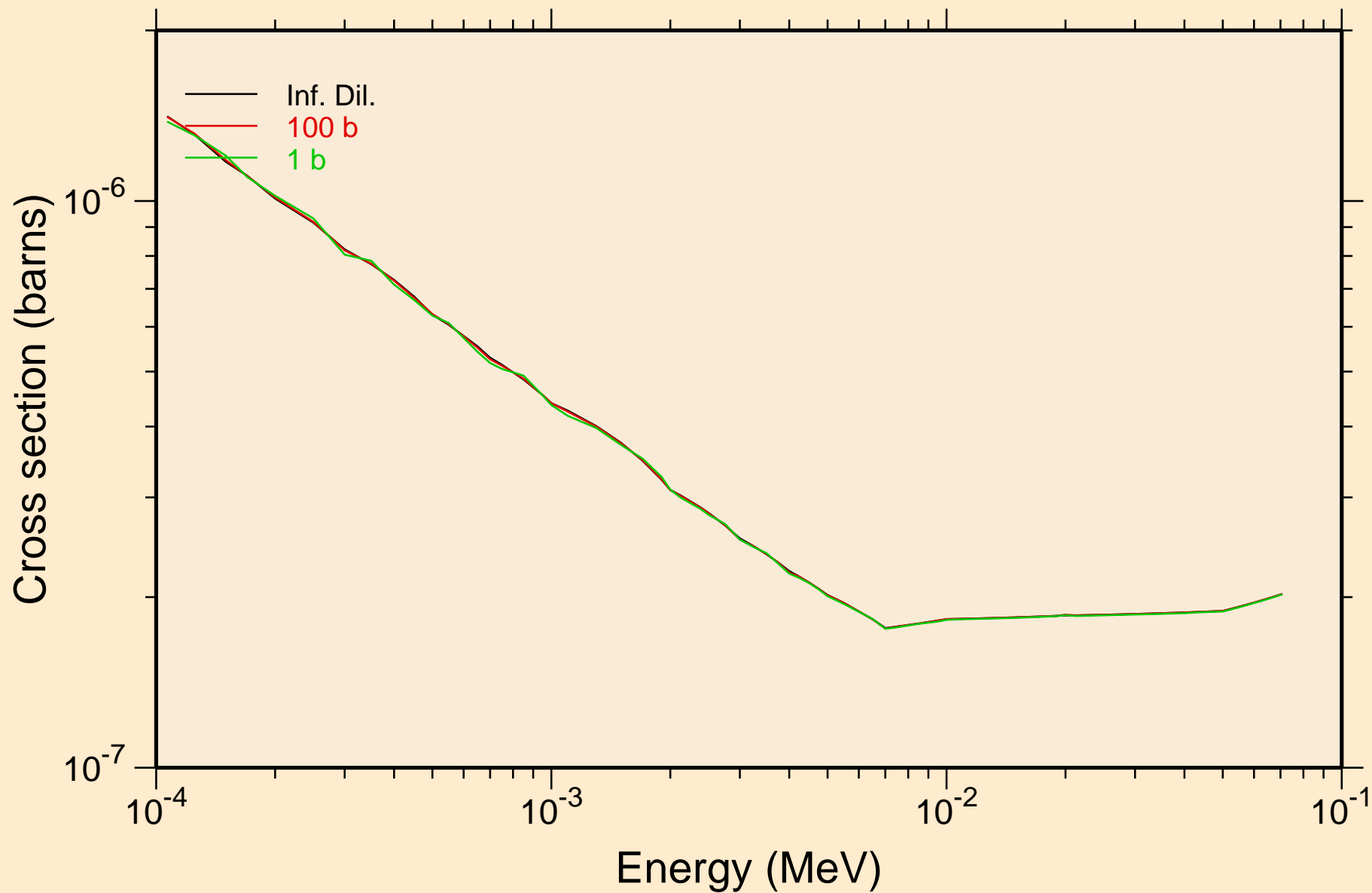

ENDF/B-VII.1 PA-233
UR capture cross section

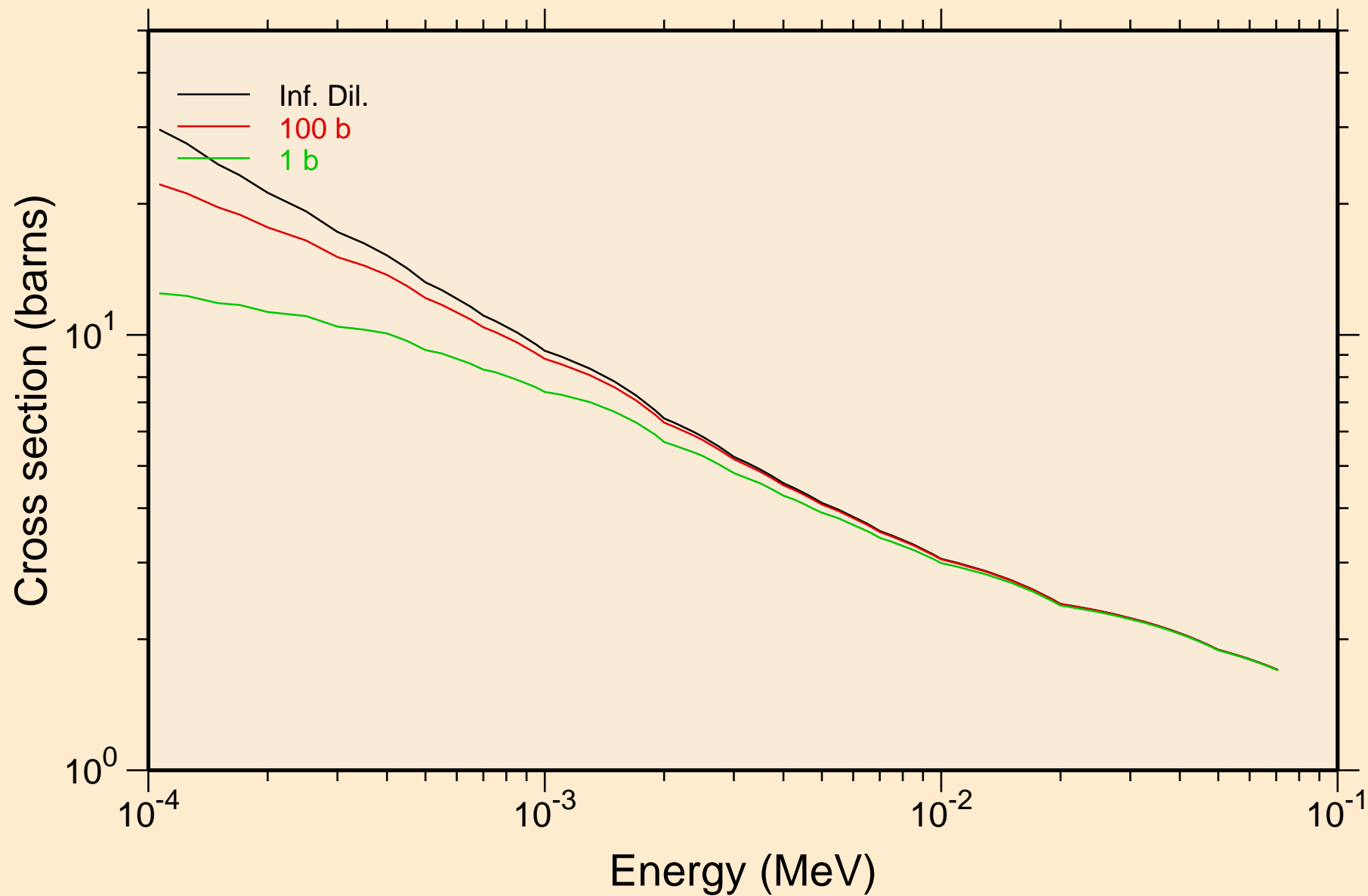

ENDF/B-VII.1 PA-233

Heating

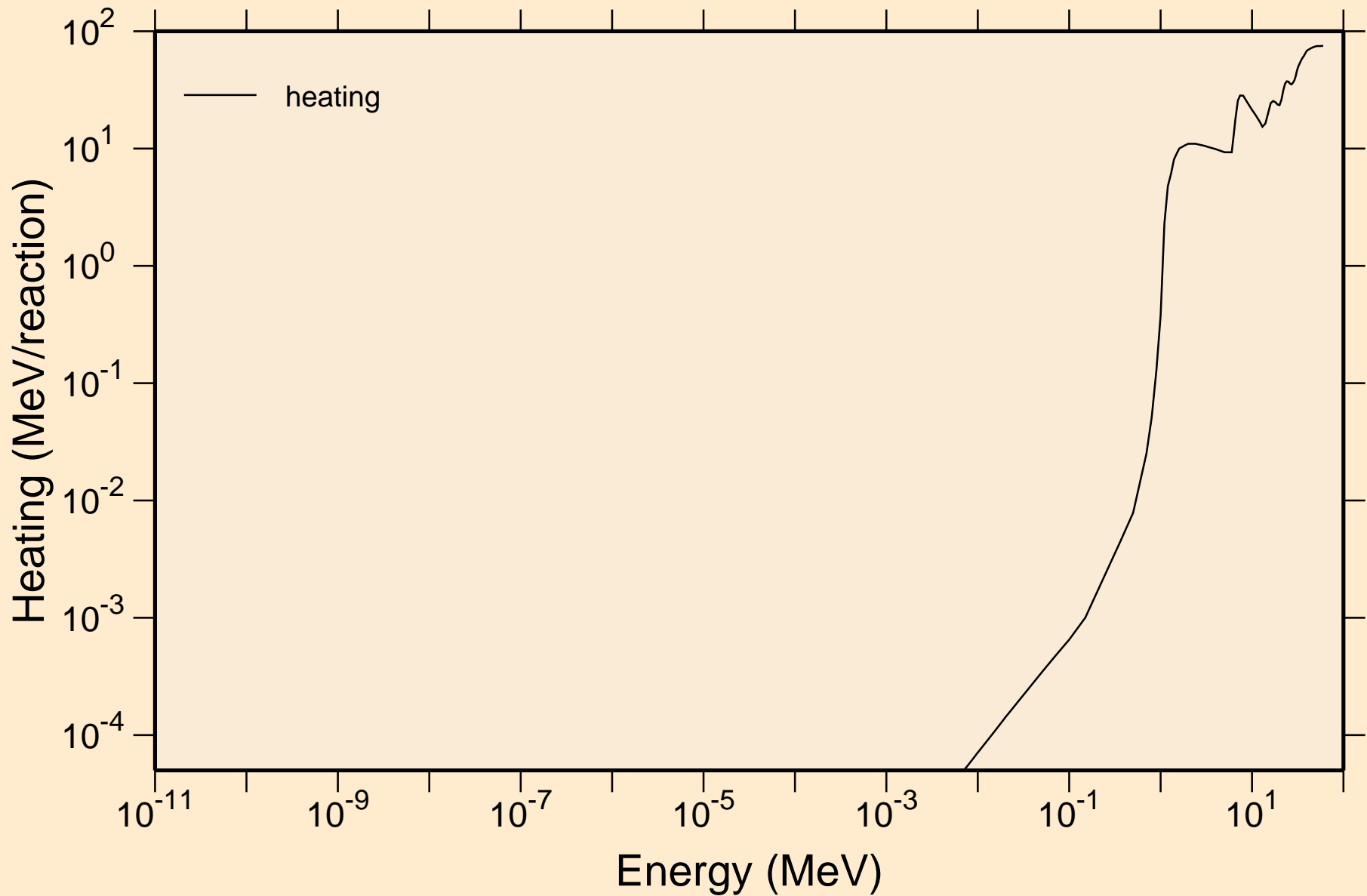

ENDF/B-VII.1 PA-233

Damage

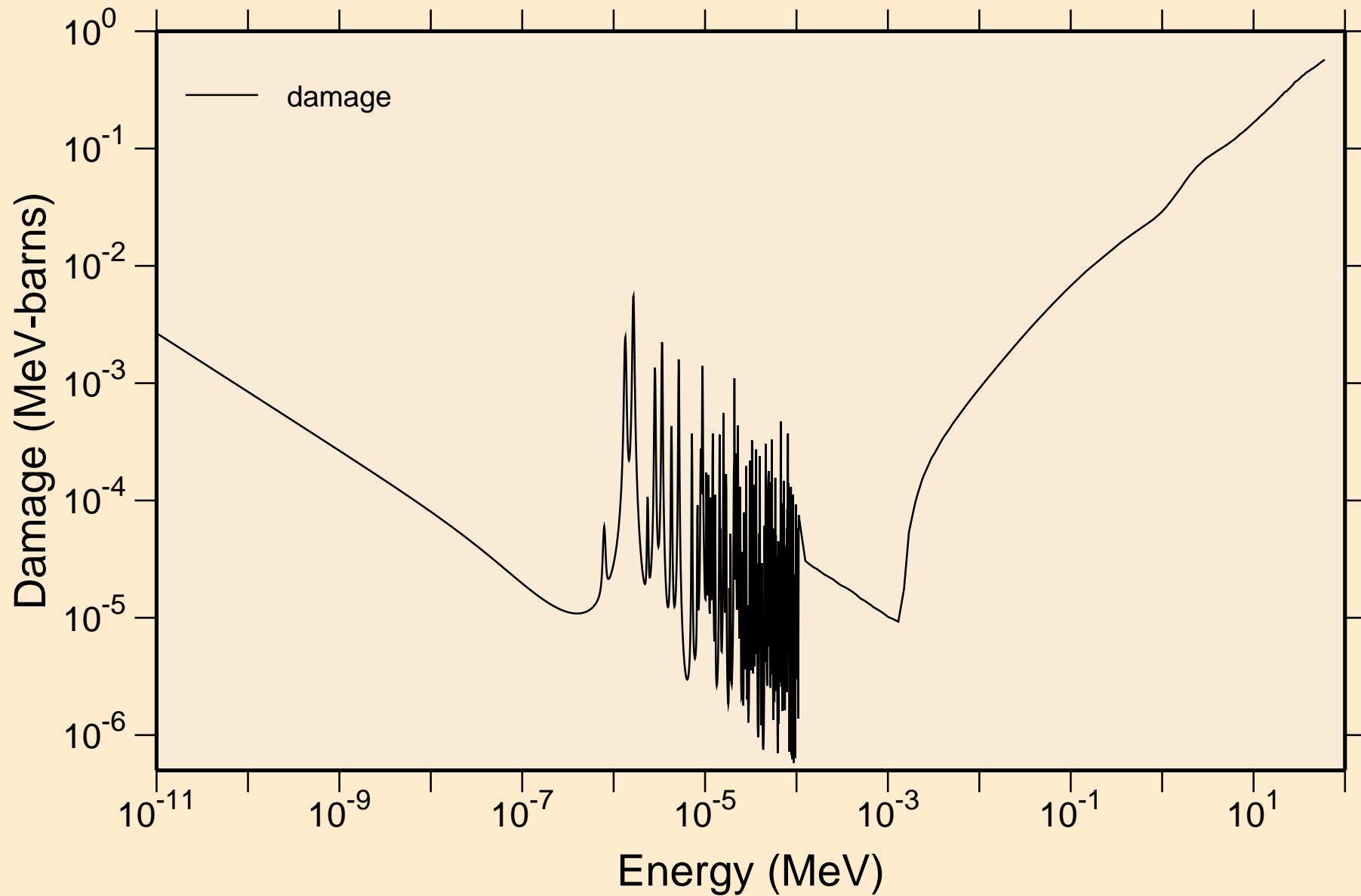

ENDF/B-VII.1 PA-233
Non-threshold reactions

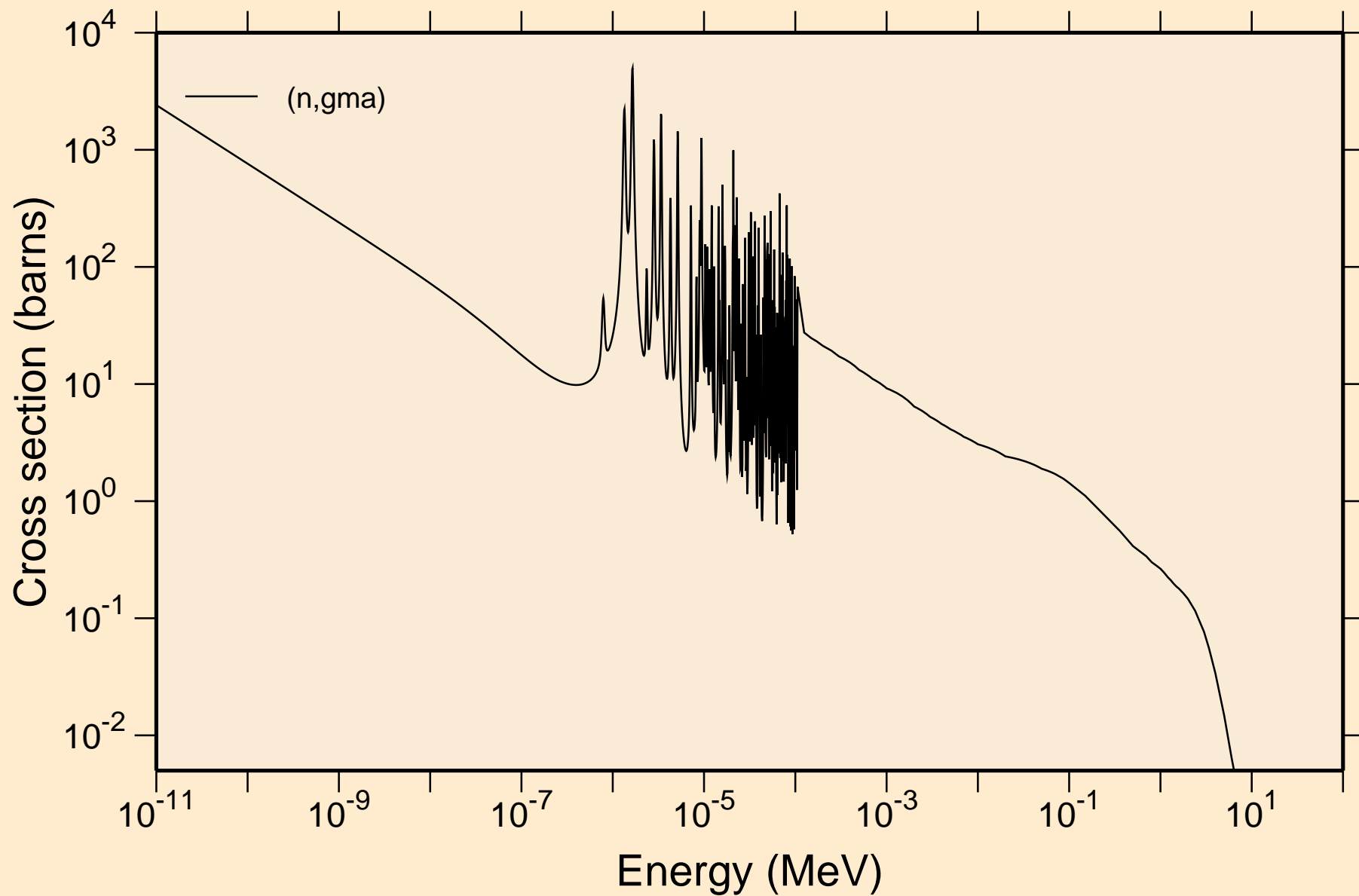

ENDF/B-VII.1 PA-233

Principal cross sections

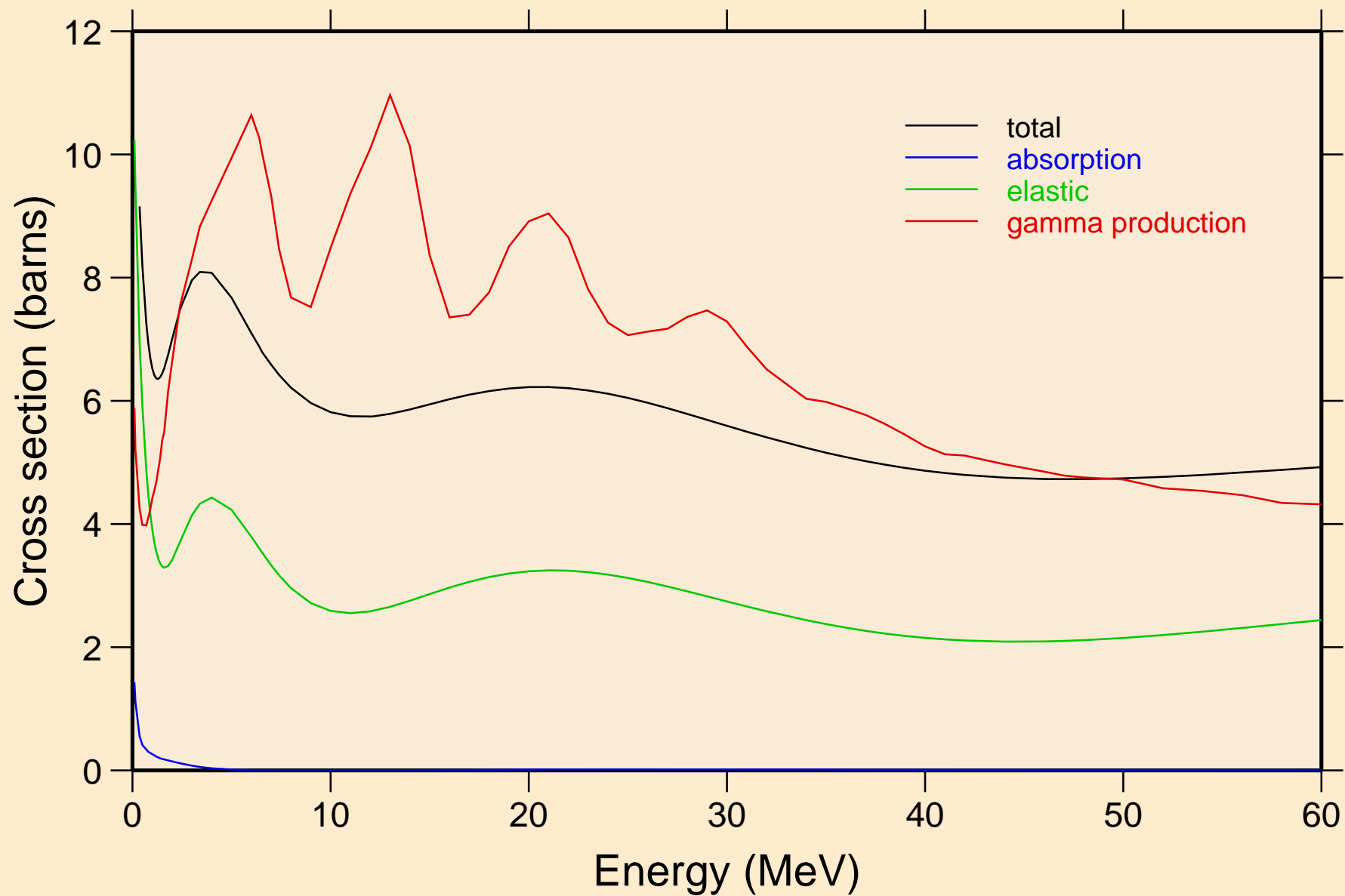

ENDF/B-VII.1 PA-233

Heating

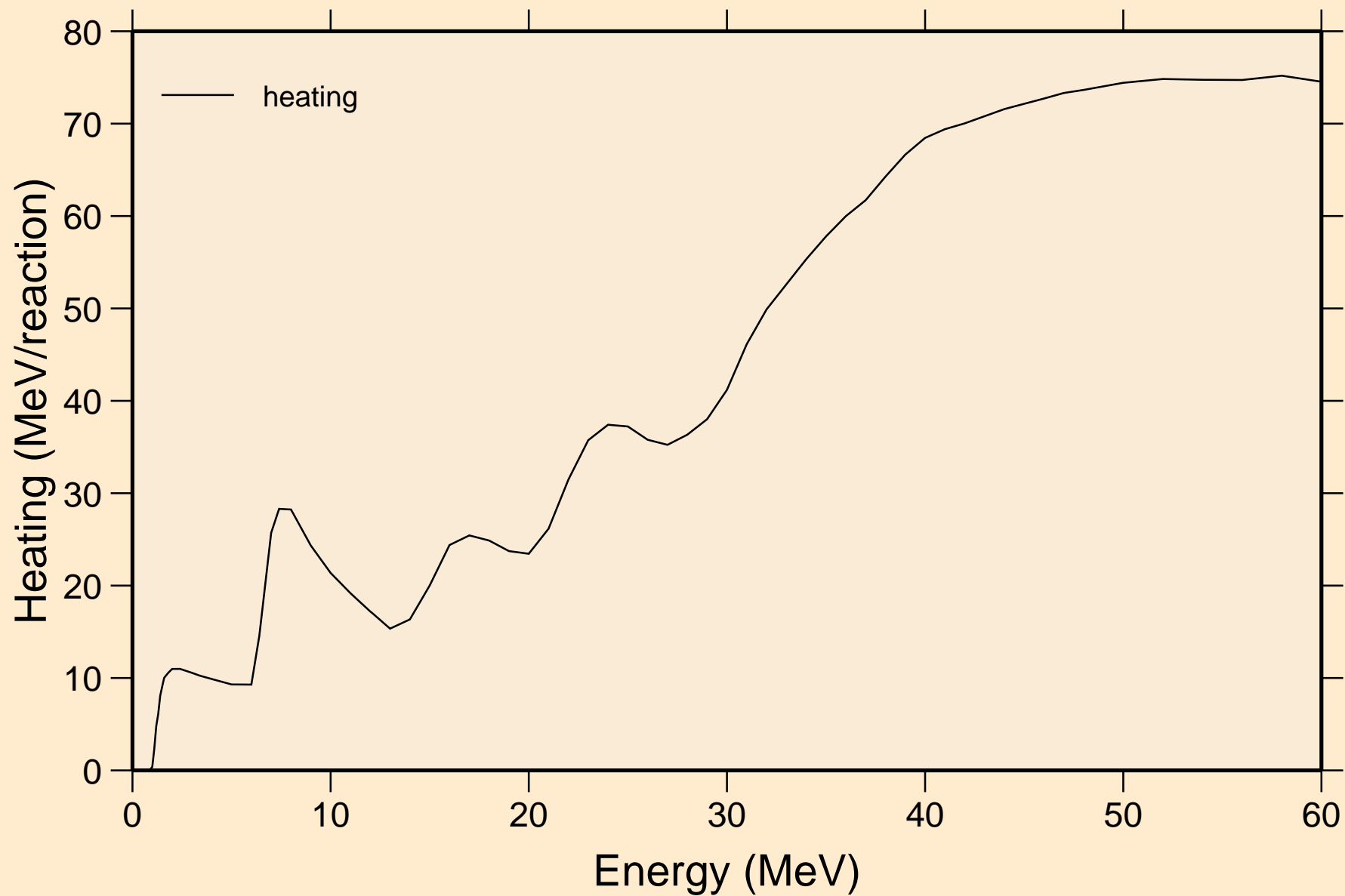

ENDF/B-VII.1 PA-233

Damage

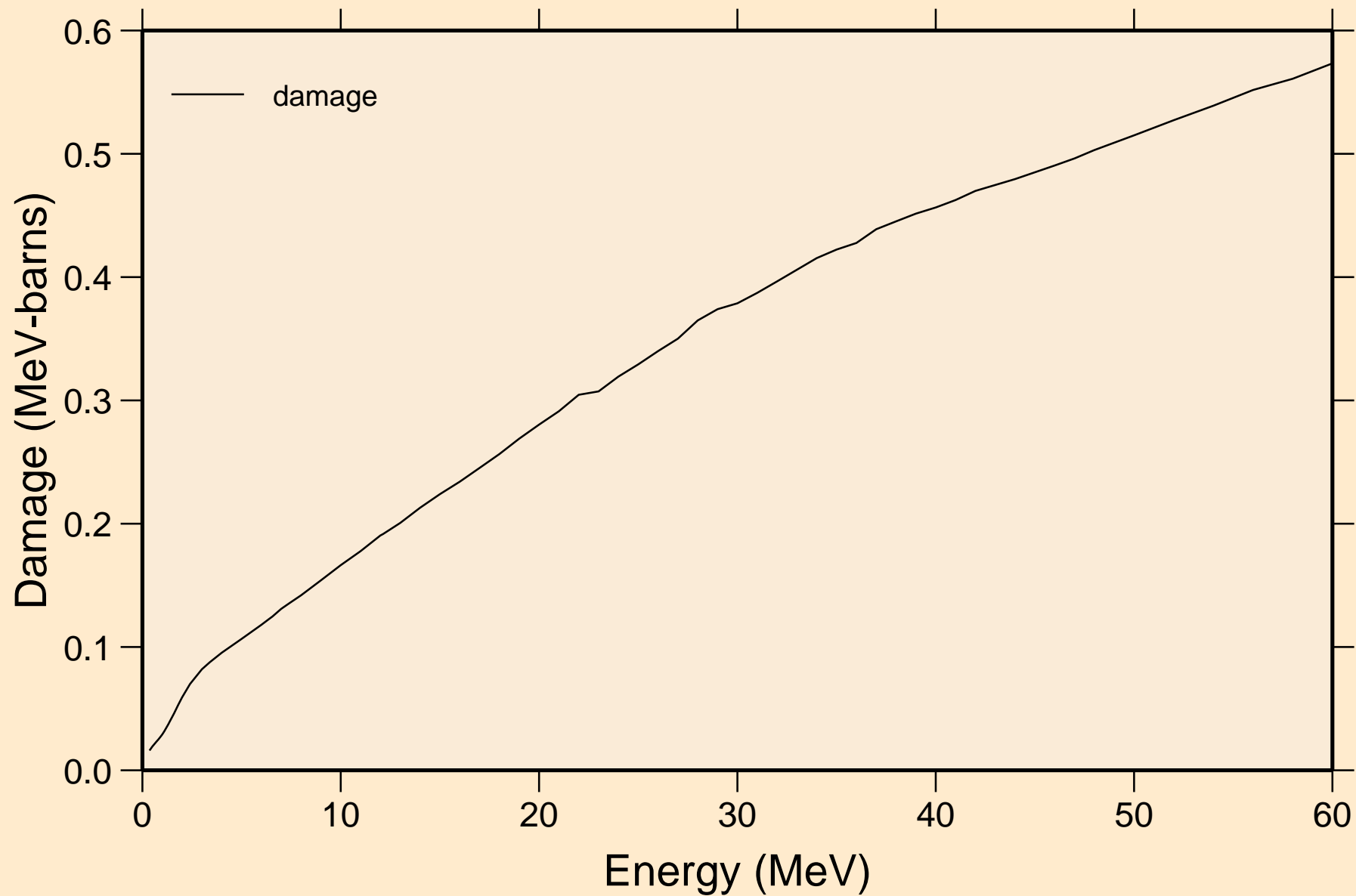

ENDF/B-VII.1 PA-233
Non-threshold reactions

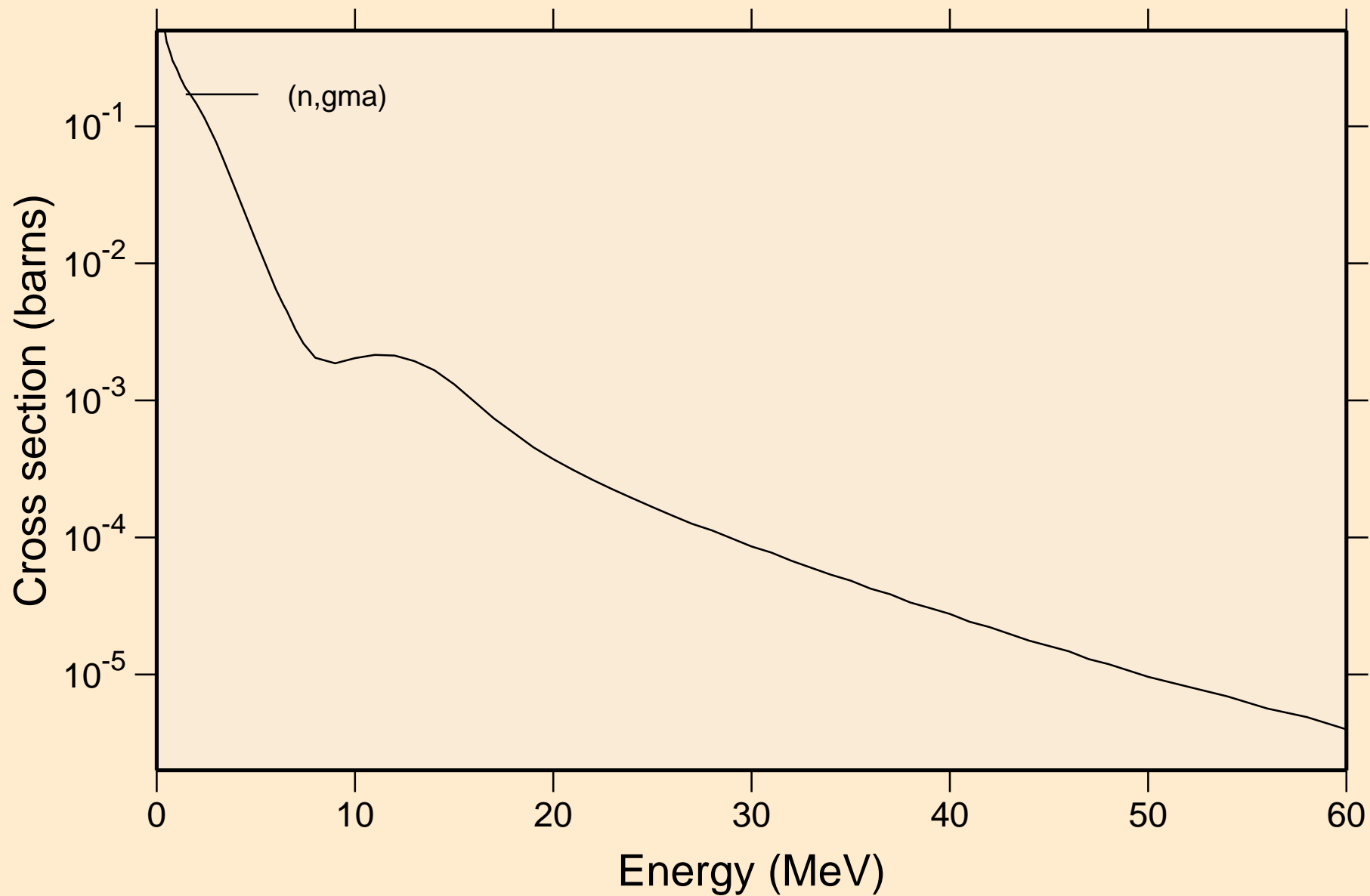

ENDF/B-VII.1 PA-233

Inelastic levels

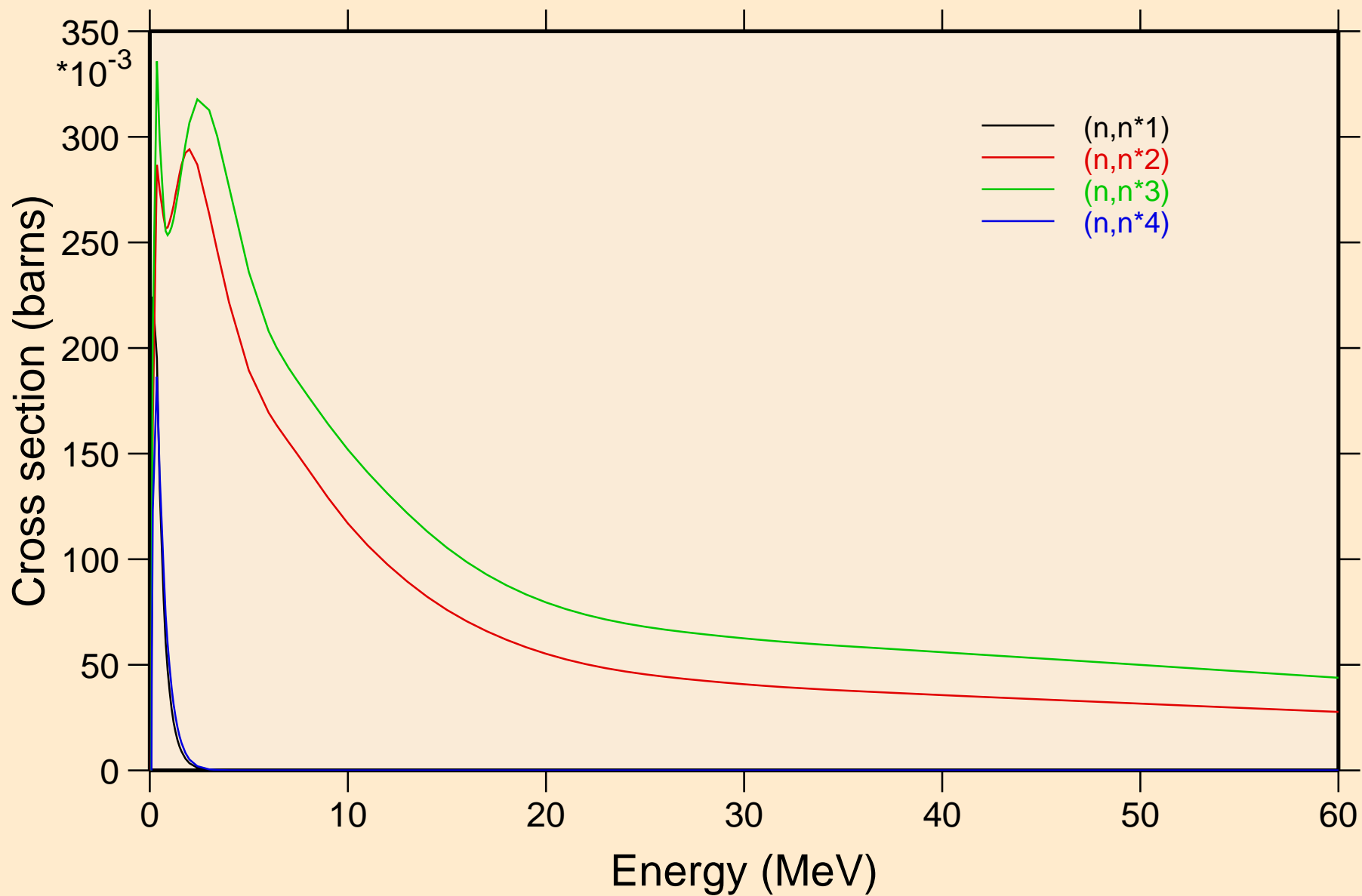

ENDF/B-VII.1 PA-233

Threshold reactions

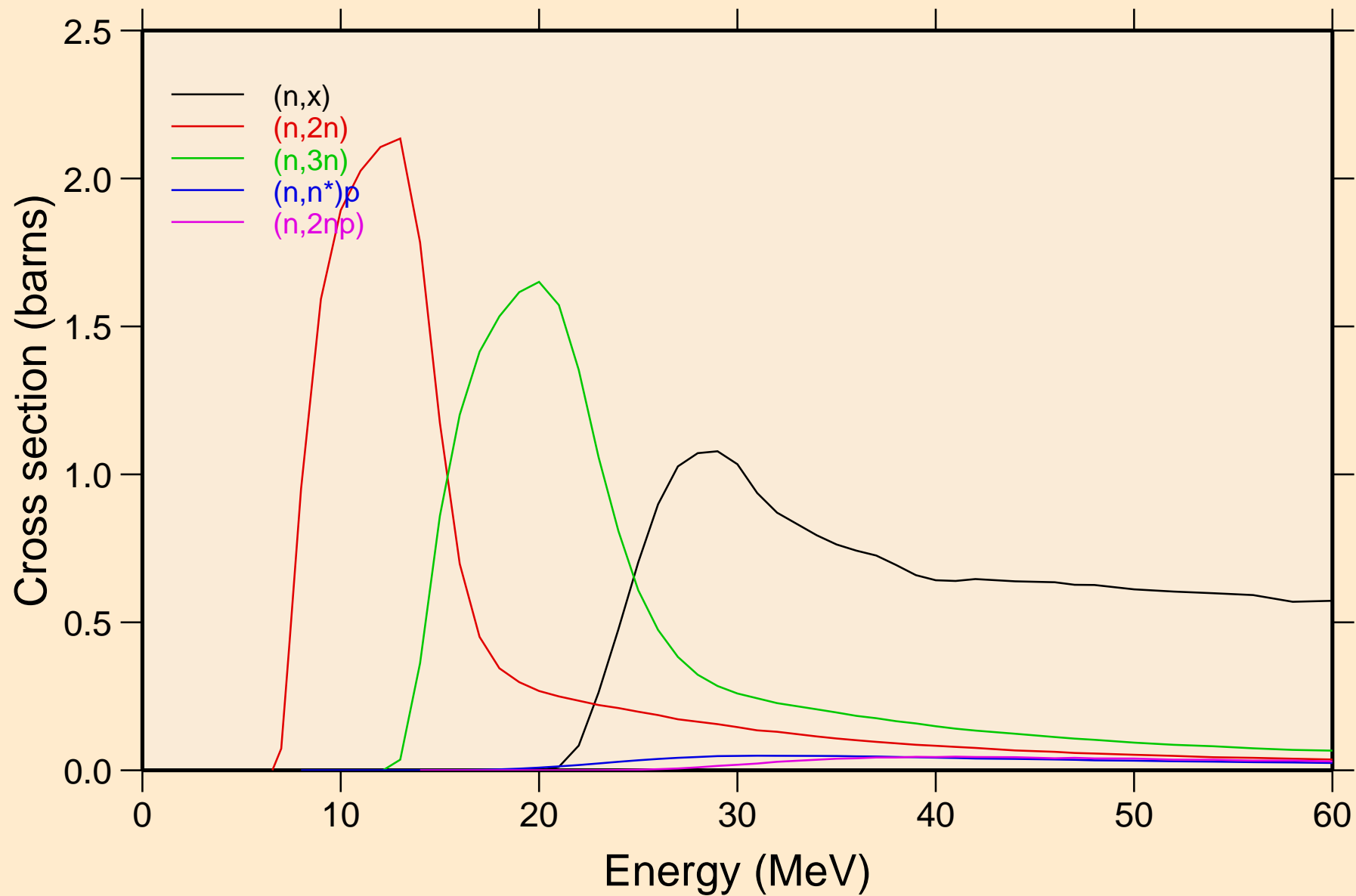

ENDF/B-VII.1 PA-233

Threshold reactions

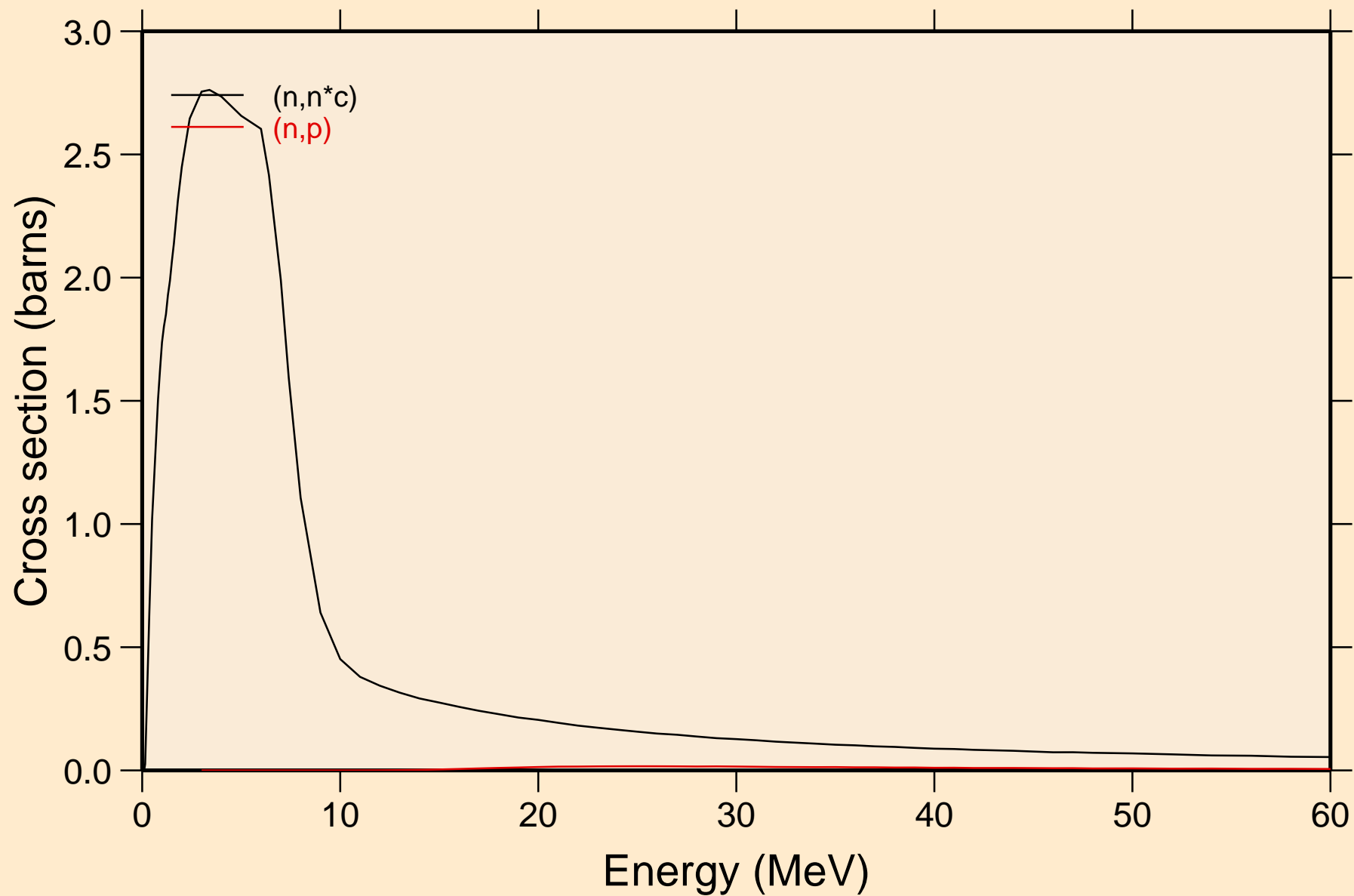

ENDF/B-VII.1 PA-233

Threshold reactions

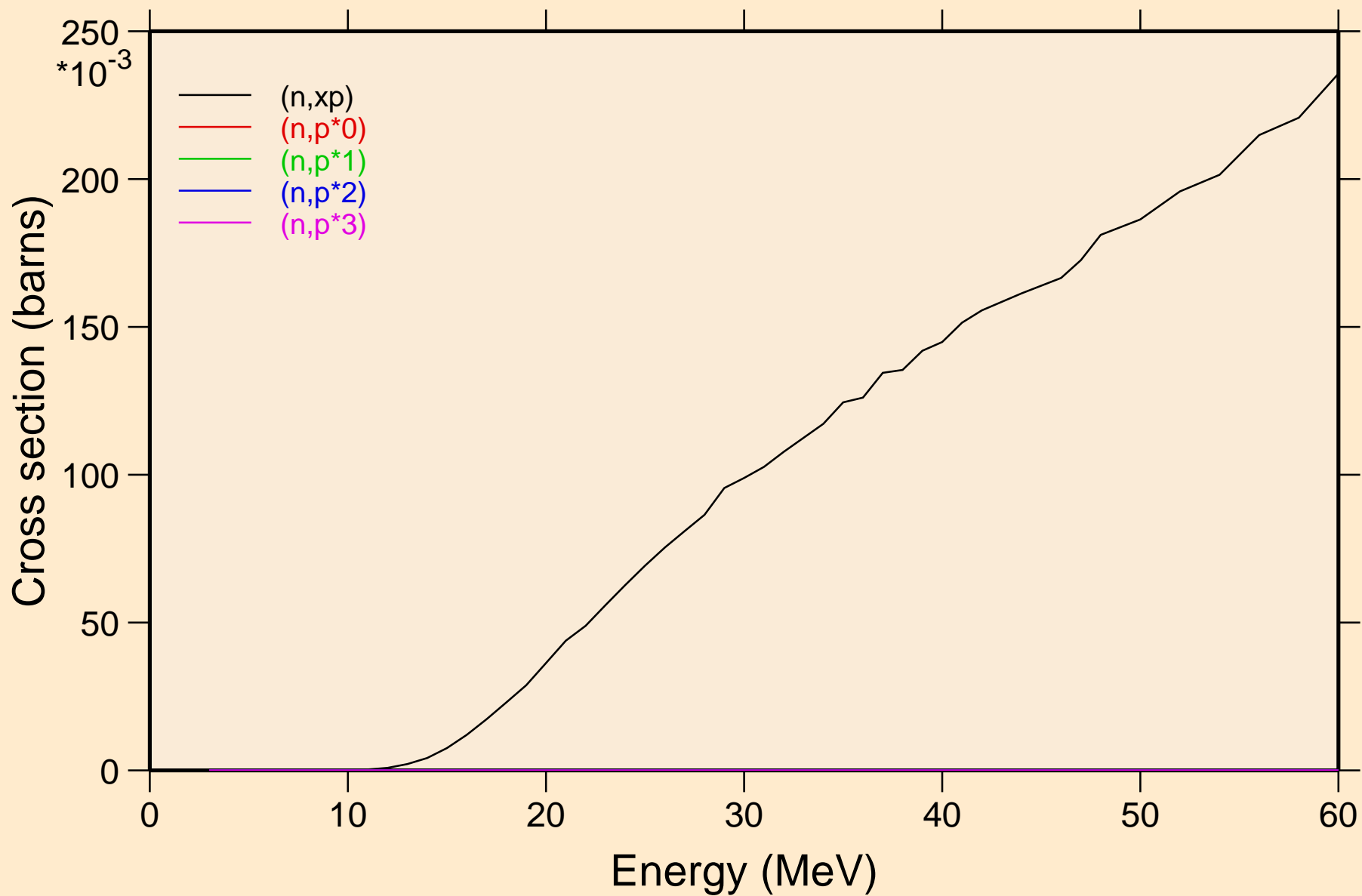

ENDF/B-VII.1 PA-233

Threshold reactions

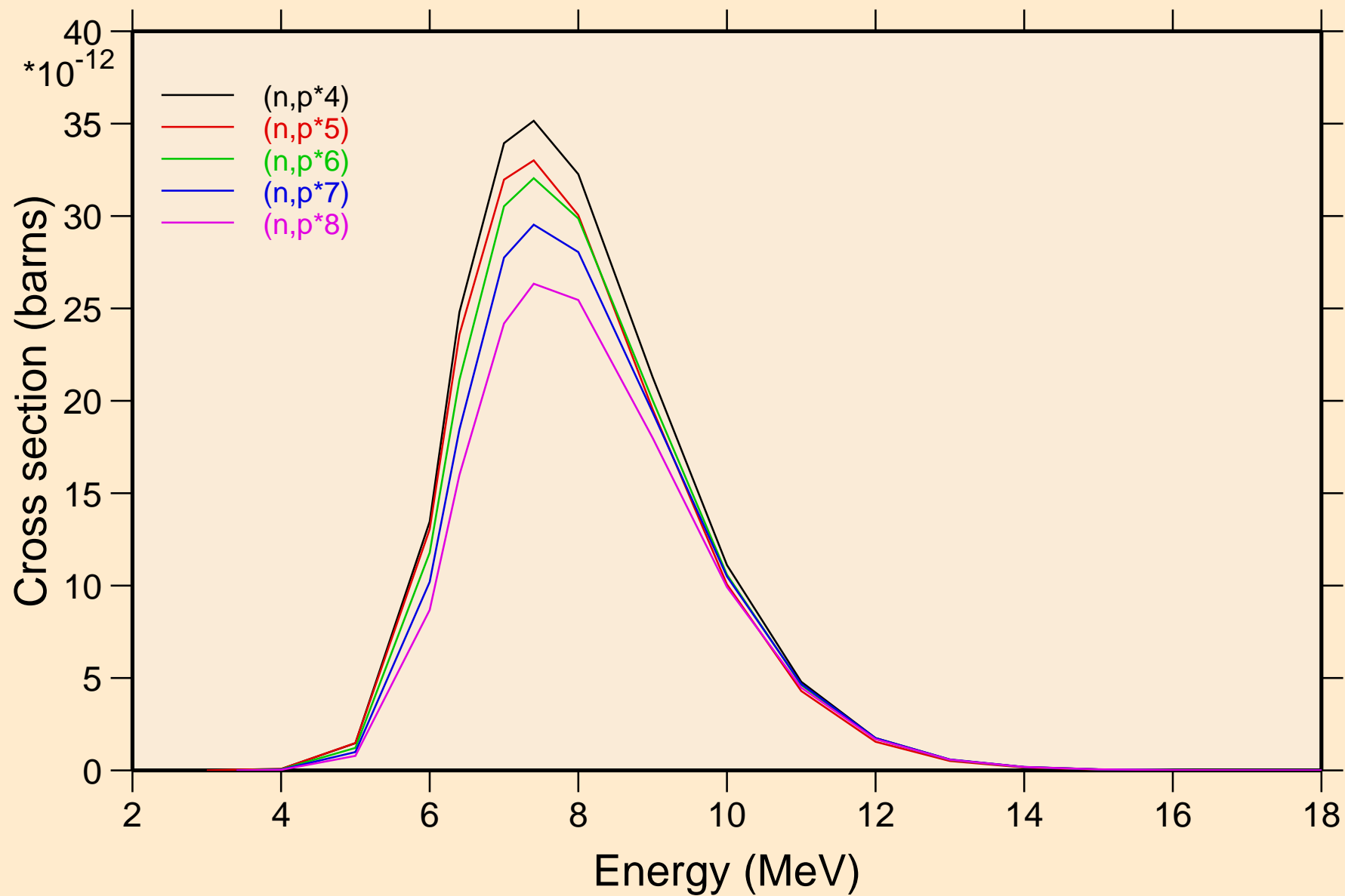

ENDF/B-VII.1 PA-233

Threshold reactions

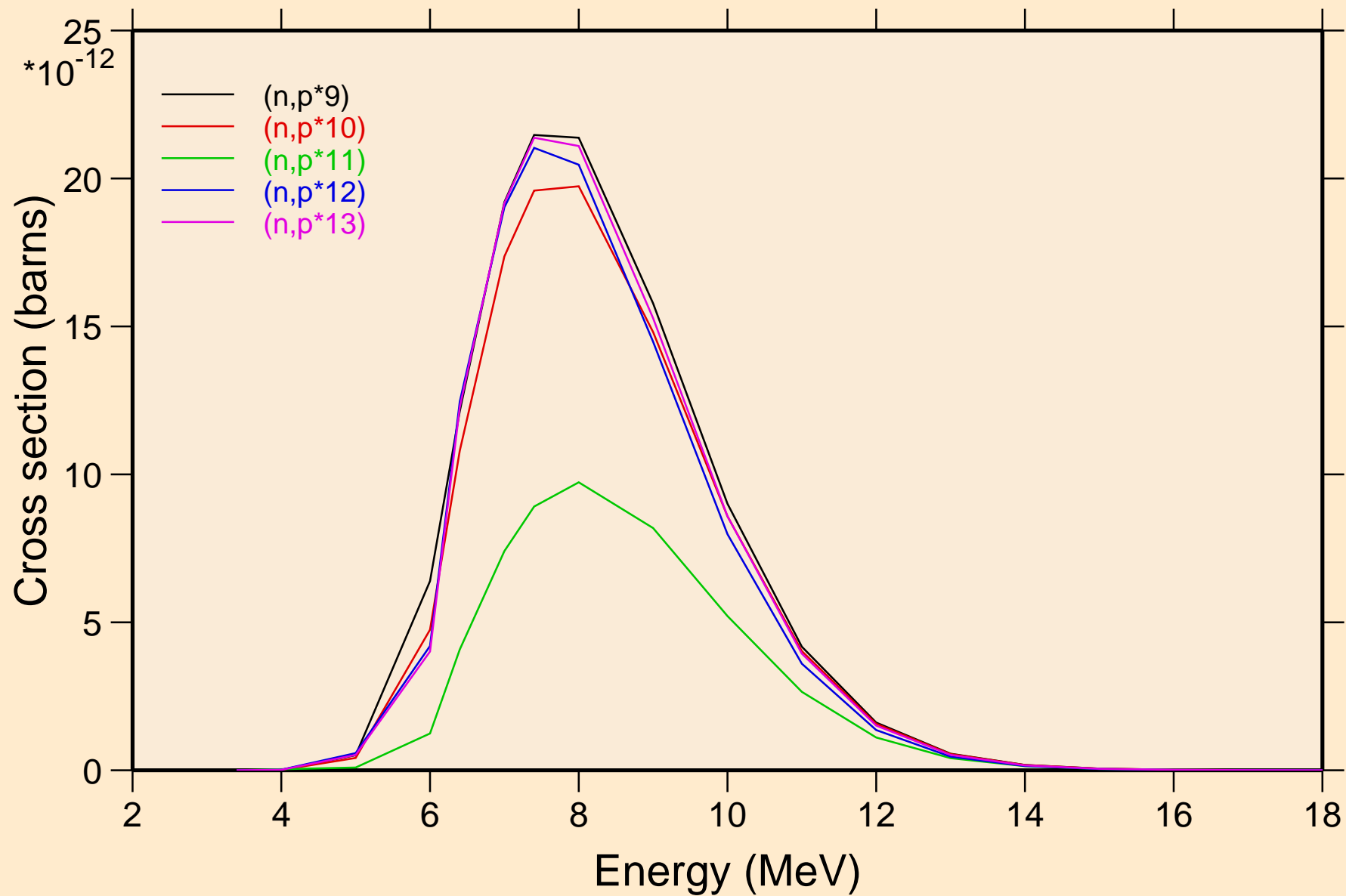

ENDF/B-VII.1 PA-233

Threshold reactions

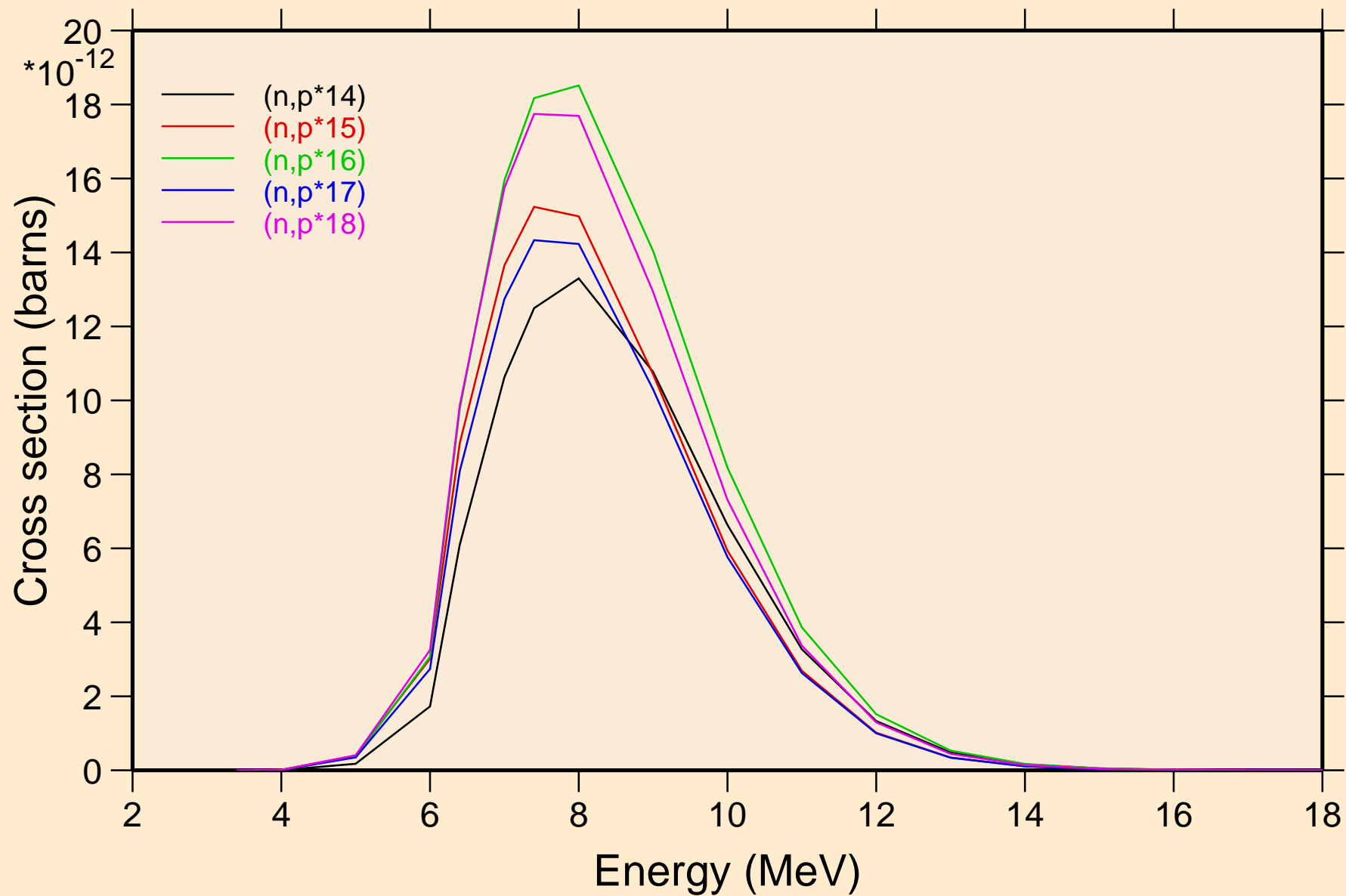

ENDF/B-VII.1 PA-233

Threshold reactions

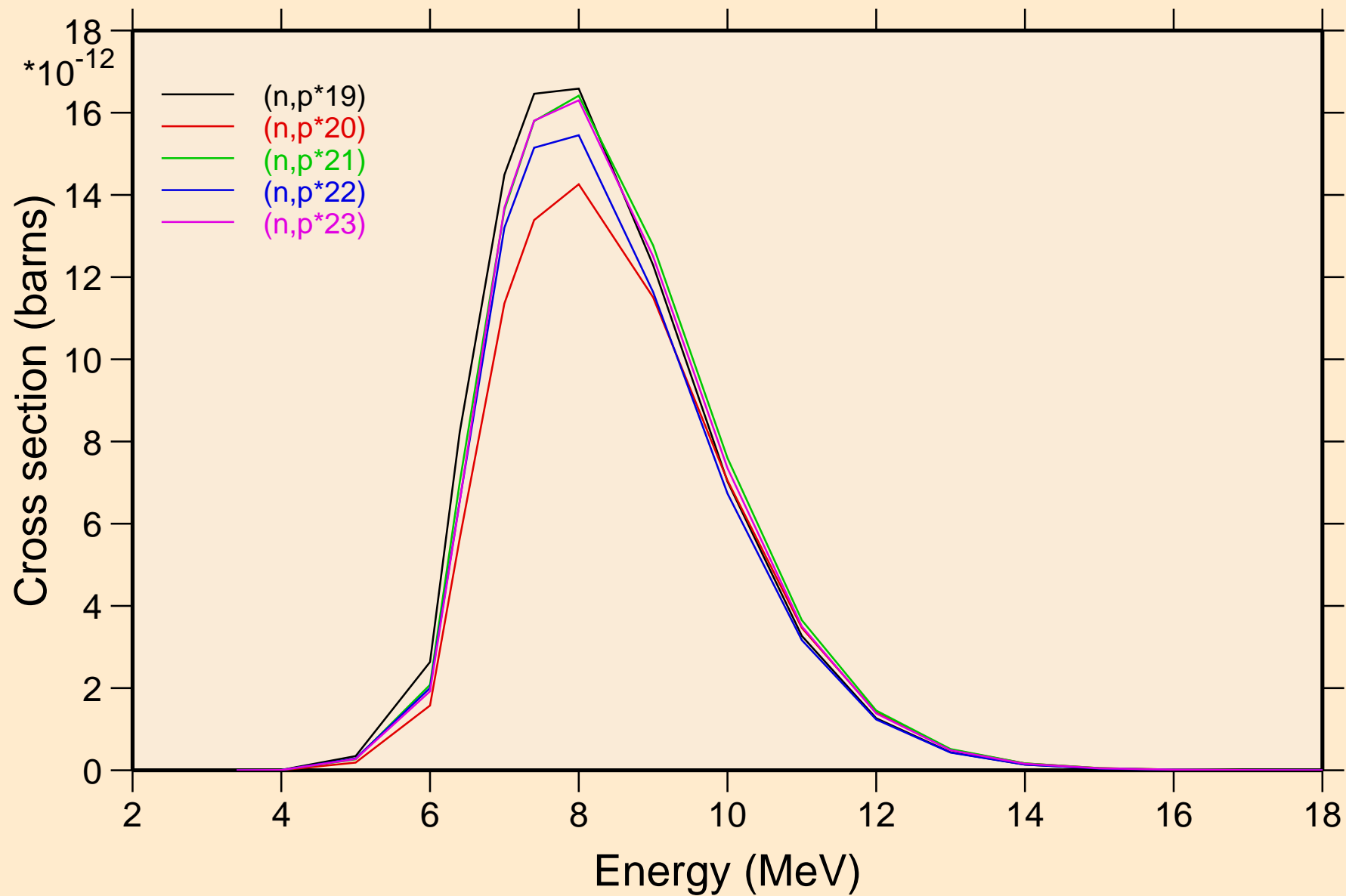

ENDF/B-VII.1 PA-233

Threshold reactions

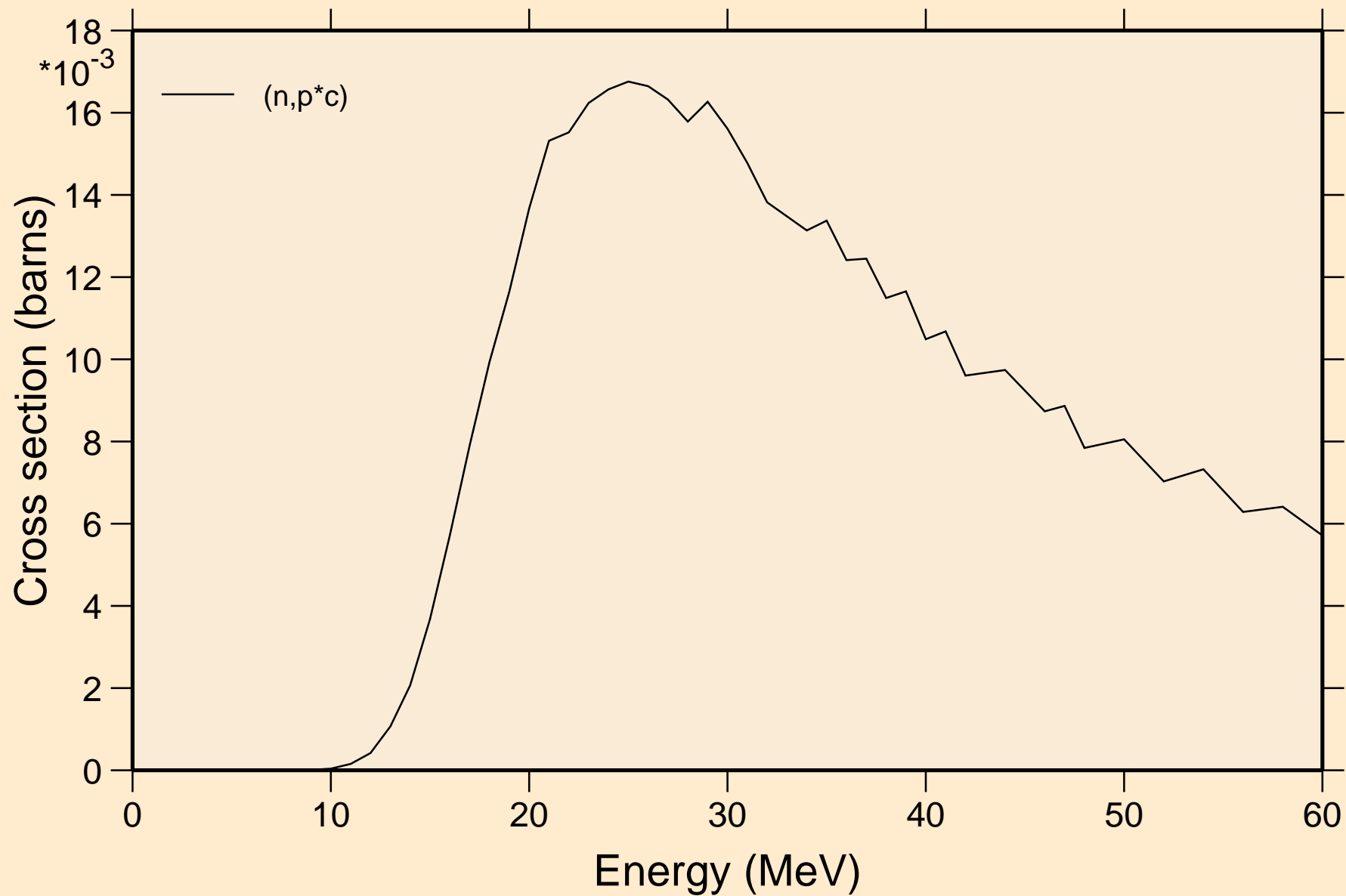

ENDF/B-VII.1 PA-233
angular distribution for elastic

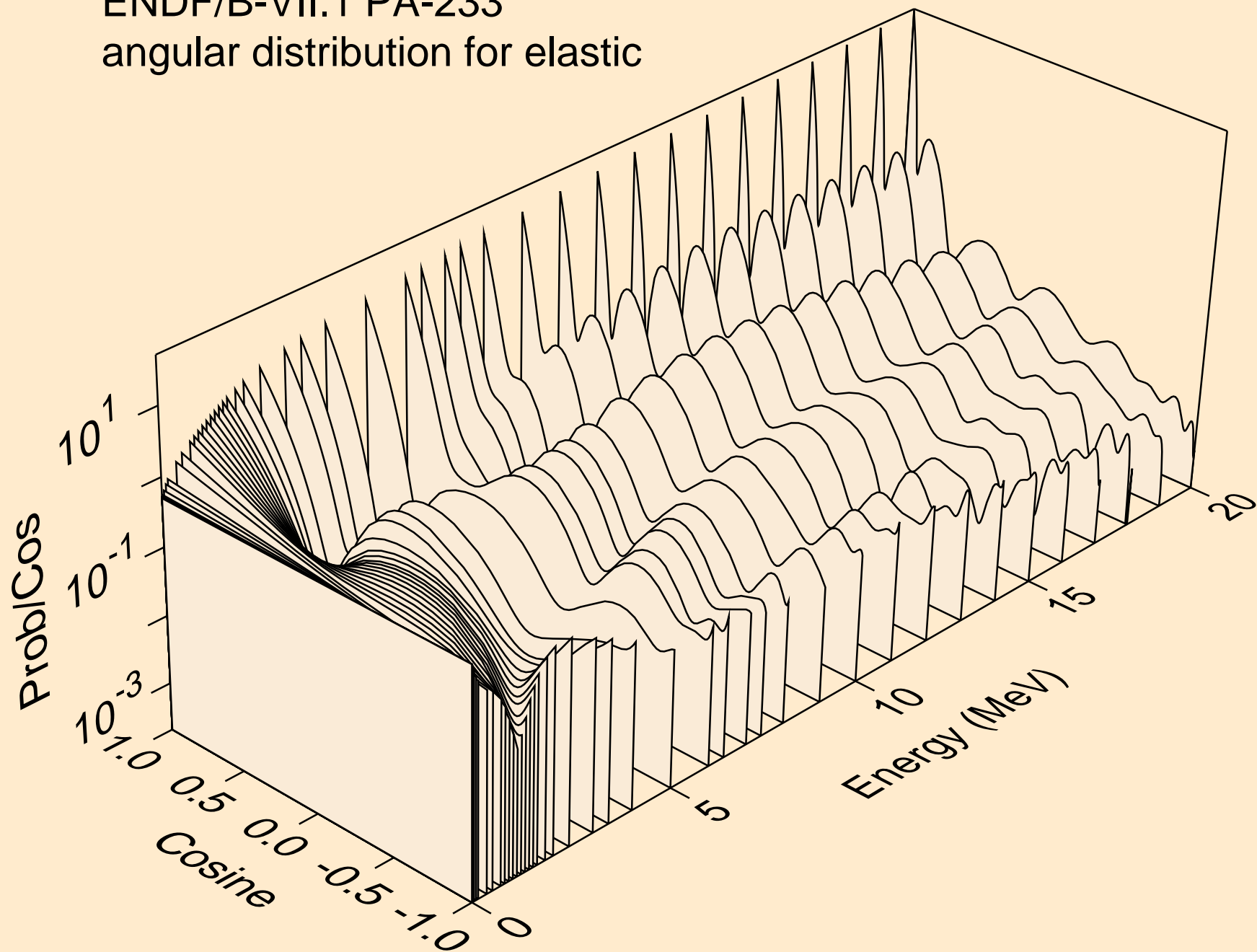

ENDF/B-VII.1 PA-233
angular distribution for elastic

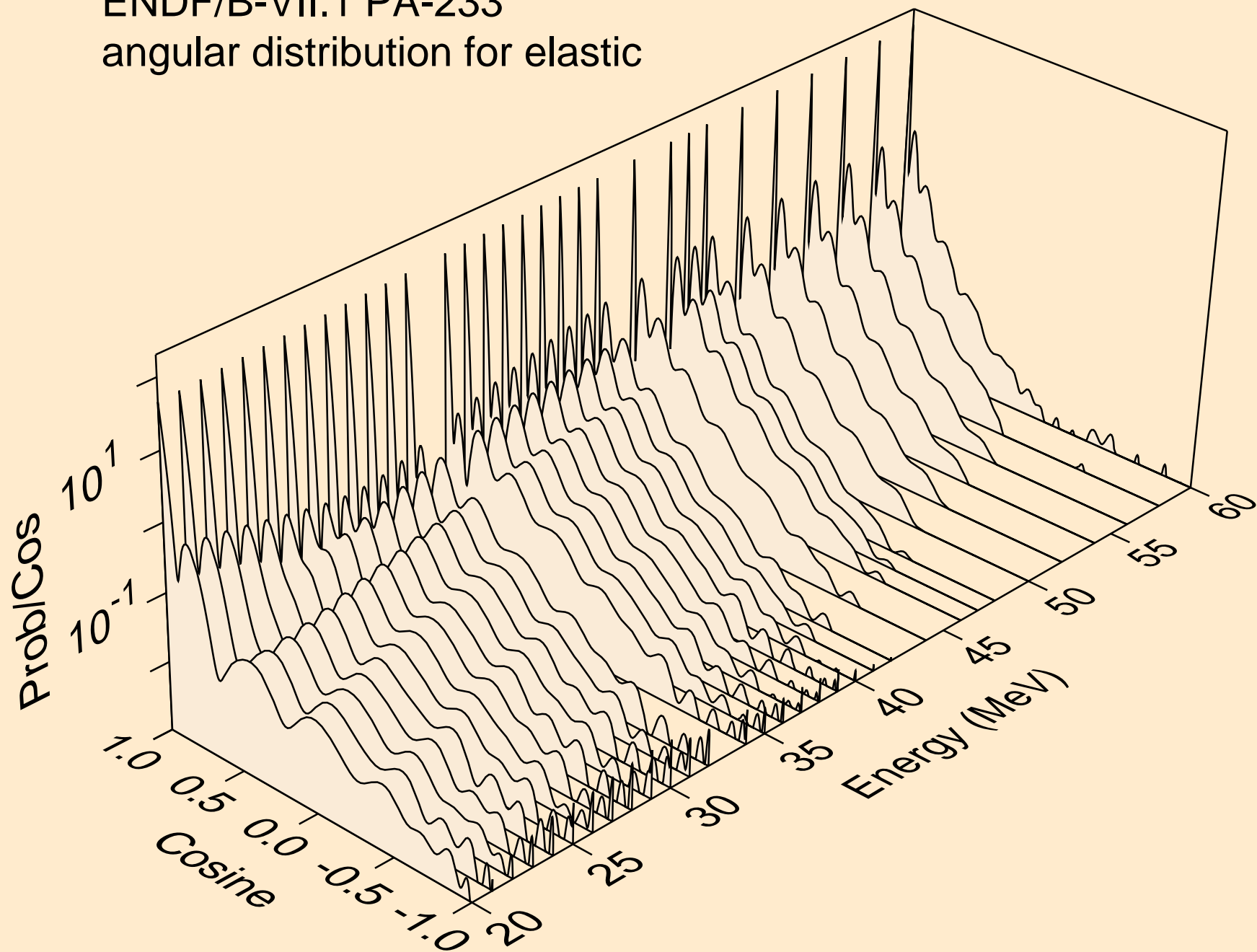

ENDF/B-VII.1 PA-233

Total fission nubar

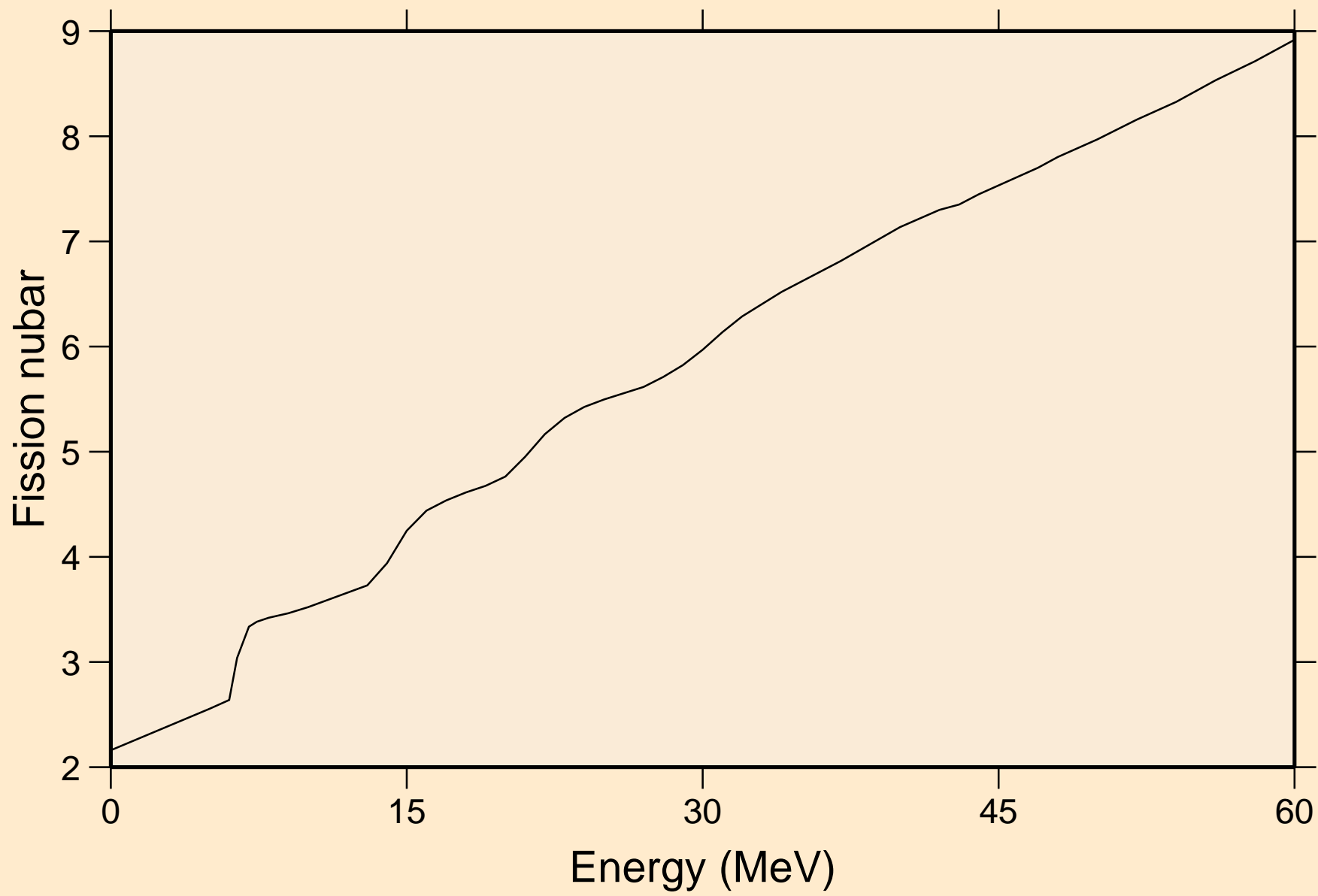

ENDF/B-VII.1 PA-233

Delayed nubar

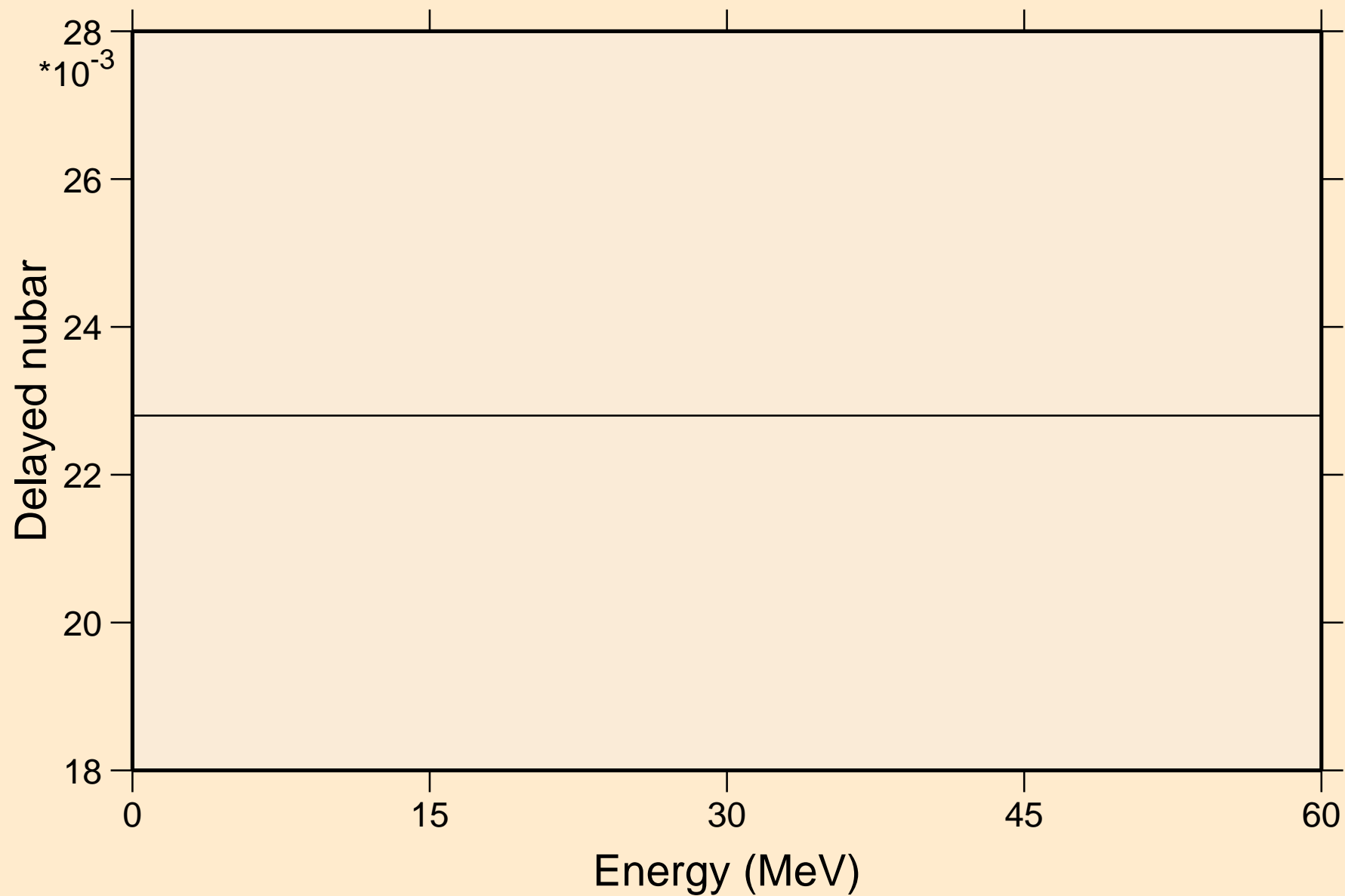

ENDF/B-VII.1 PA-233

Delayed neutron spectra

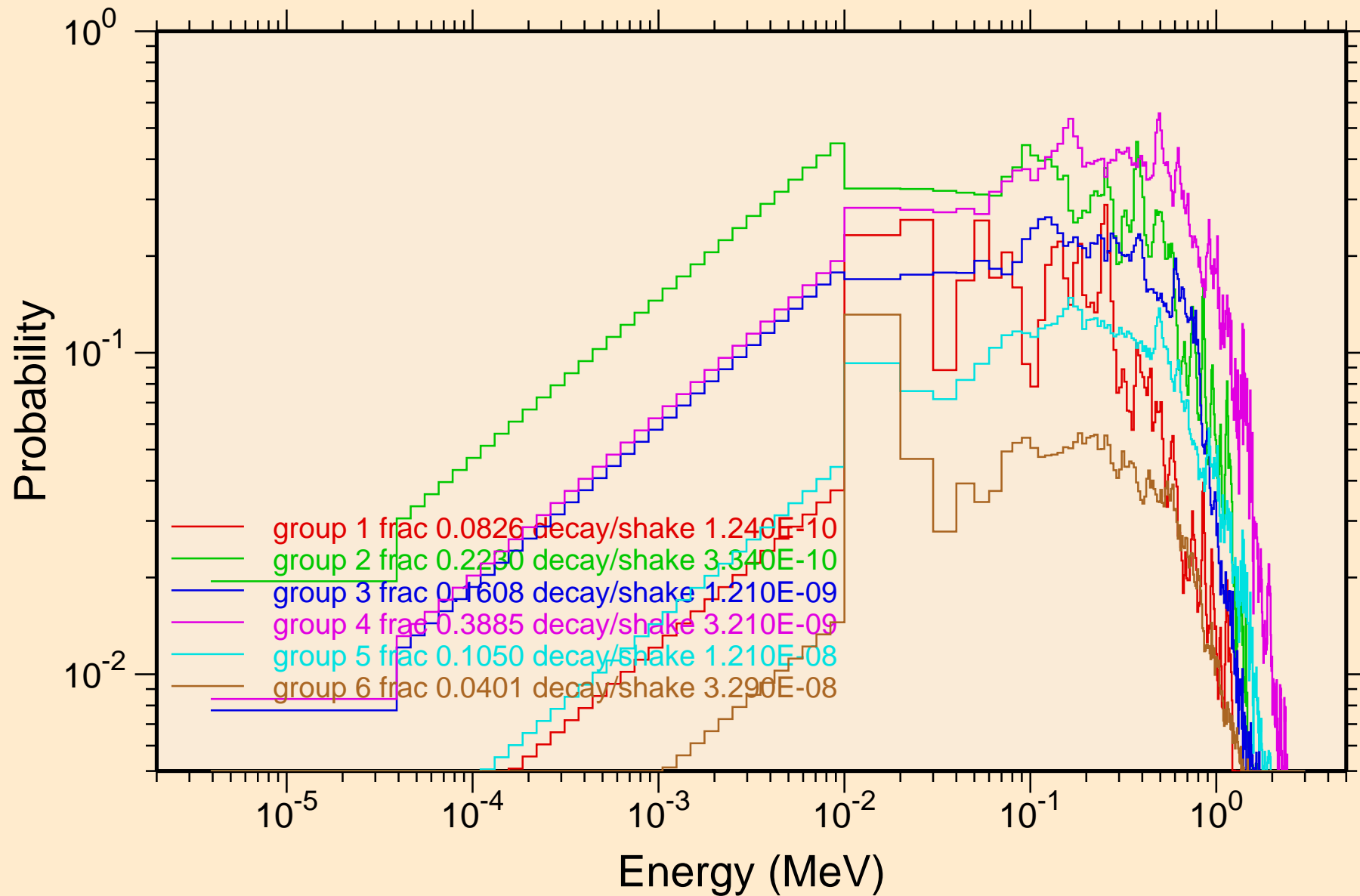

ENDF/B-VII.1 PA-233
Photon emission for (n,x)

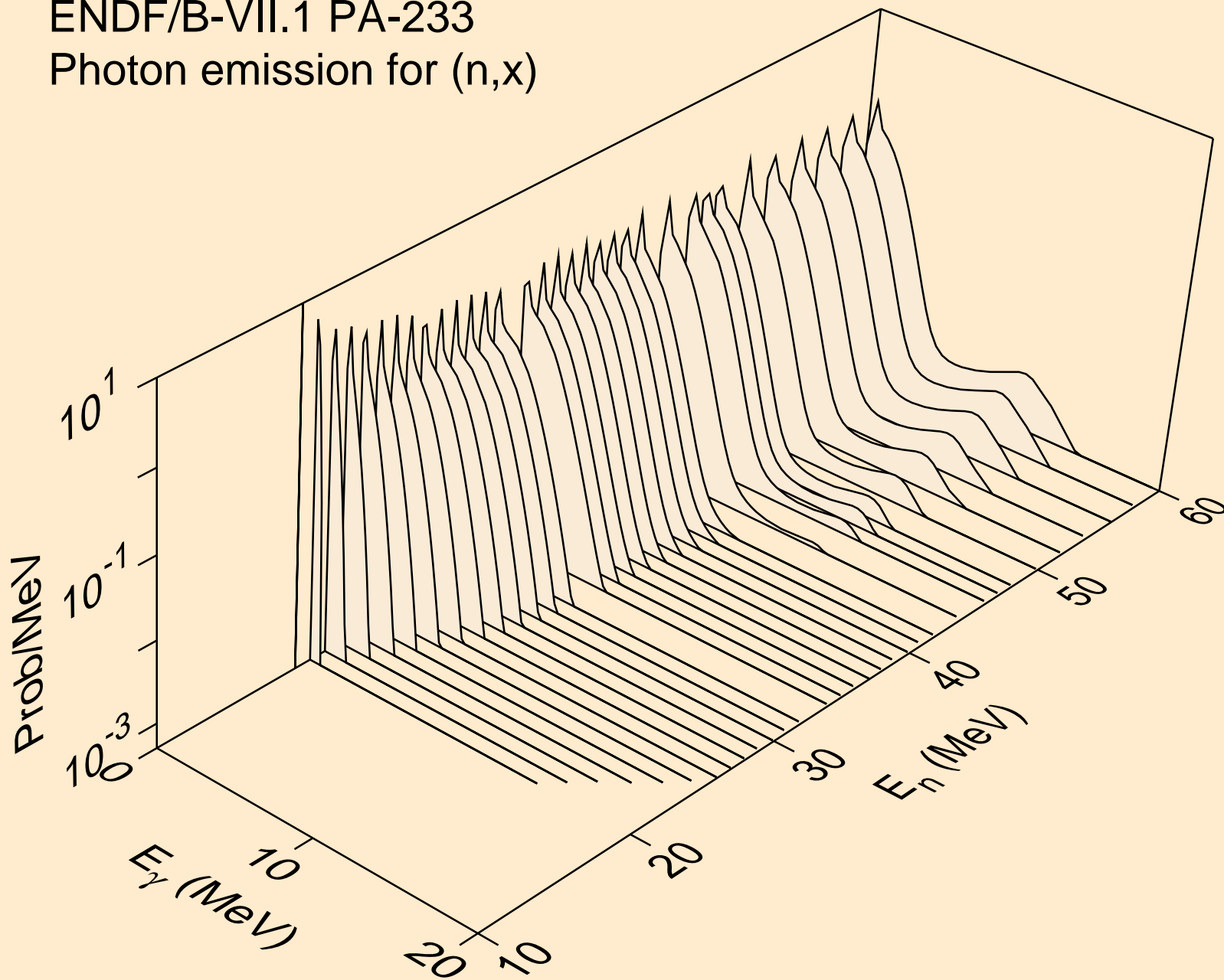

ENDF/B-VII.1 PA-233
Photon emission for (n,2n)

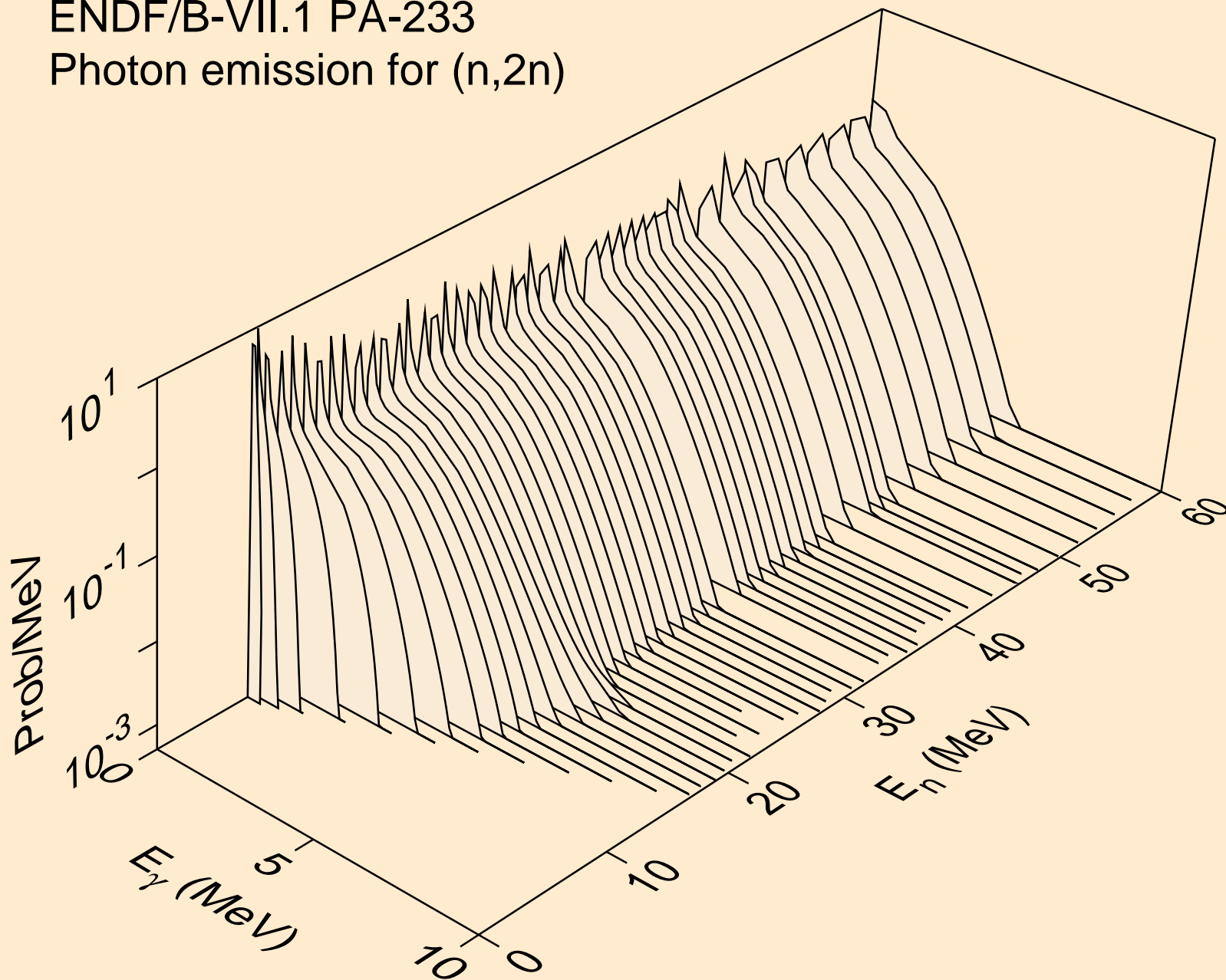

ENDF/B-VII.1 PA-233
Photon emission for (n,3n)

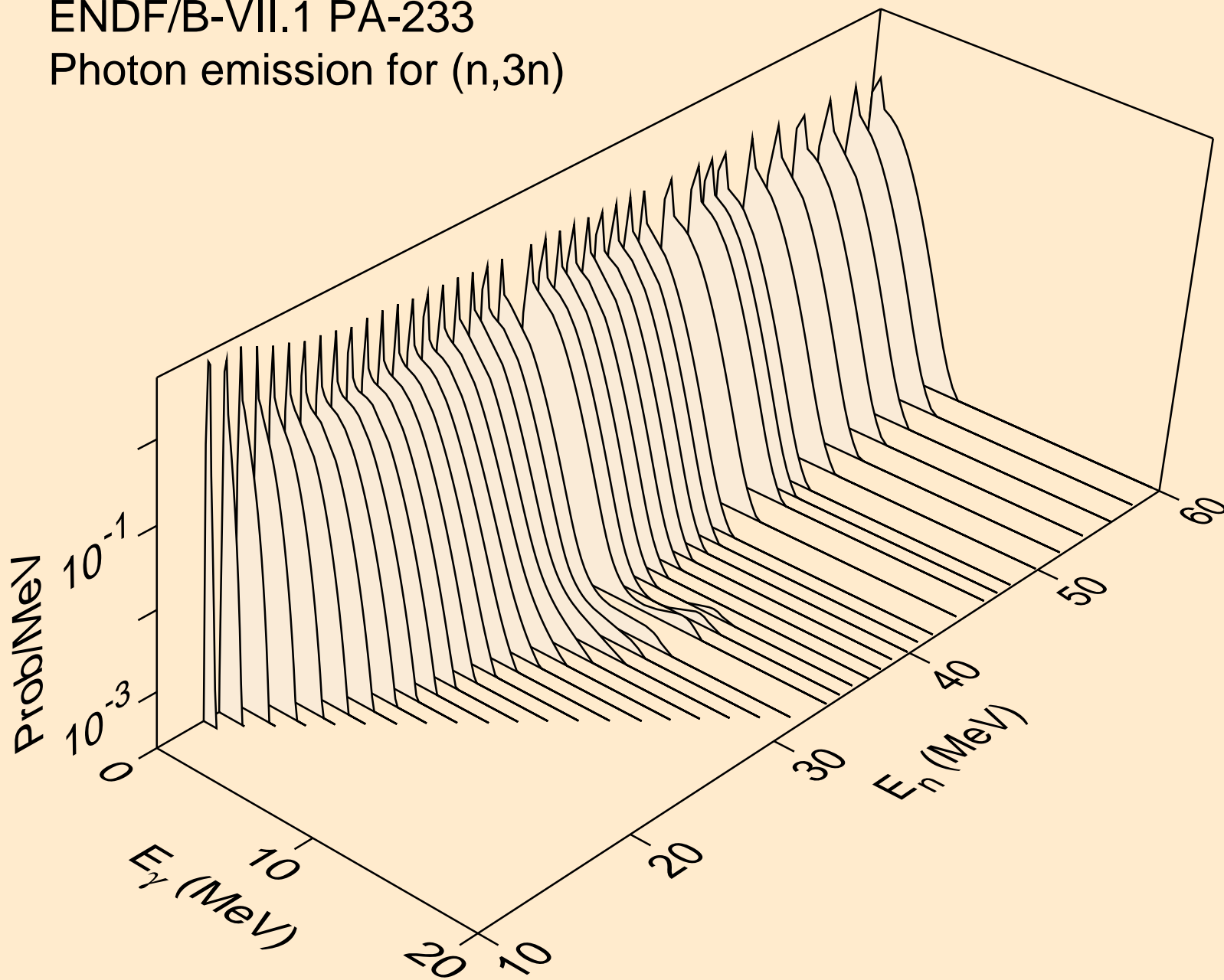

ENDF/B-VII.1 PA-233
Photon emission for fission

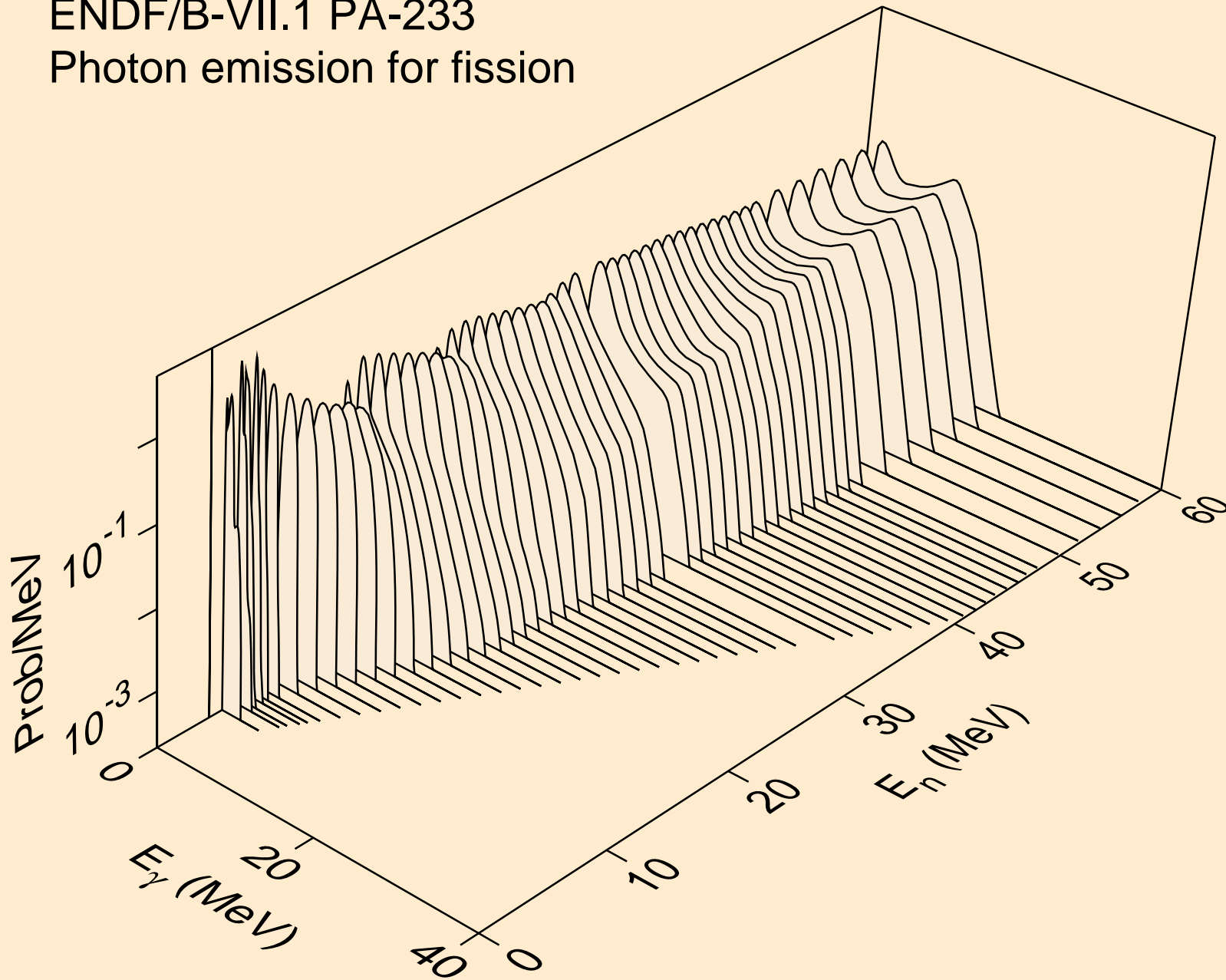

ENDF/B-VII.1 PA-233
Photon emission for (n,n*)p

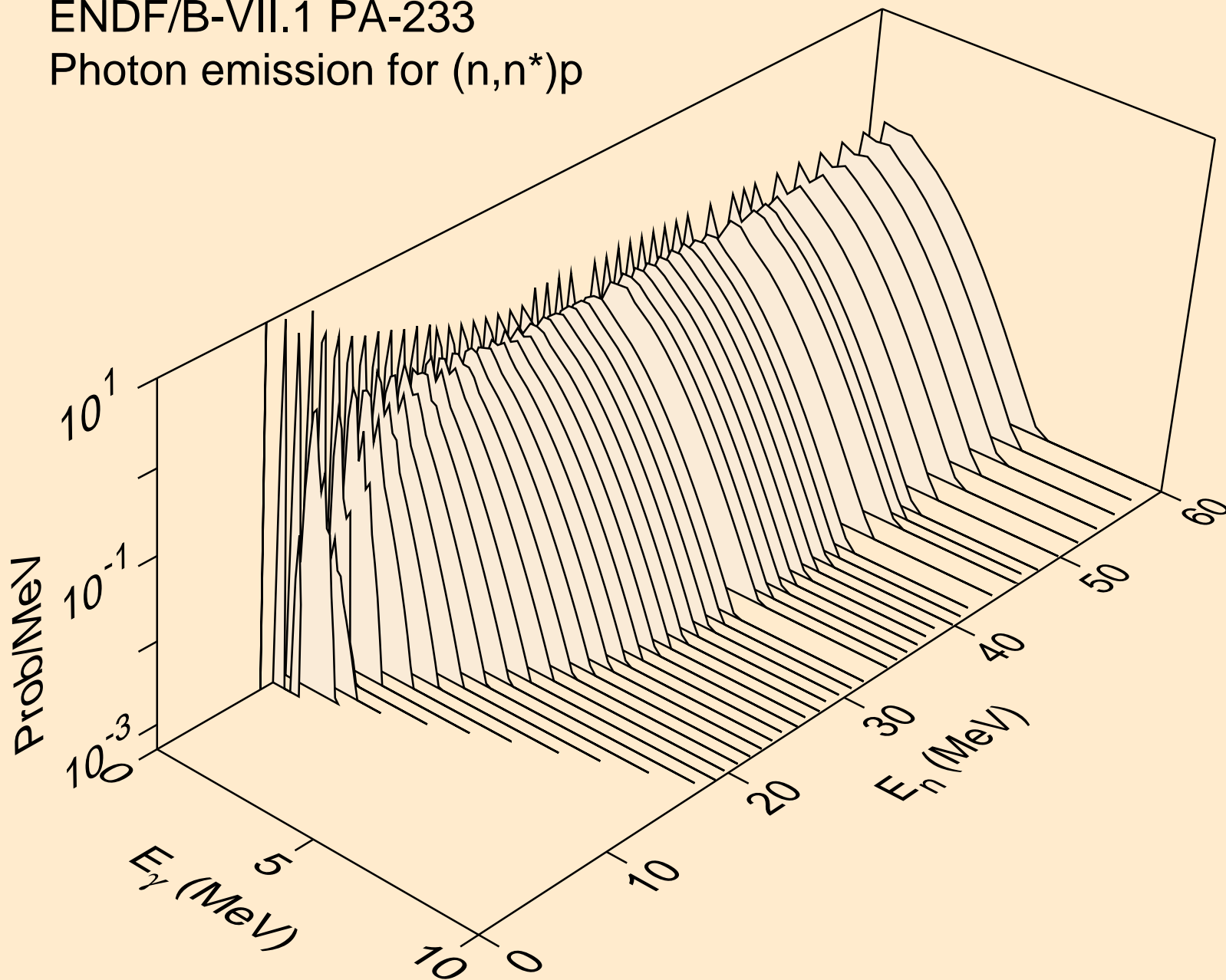

ENDF/B-VII.1 PA-233
Photon emission for (n,2np)

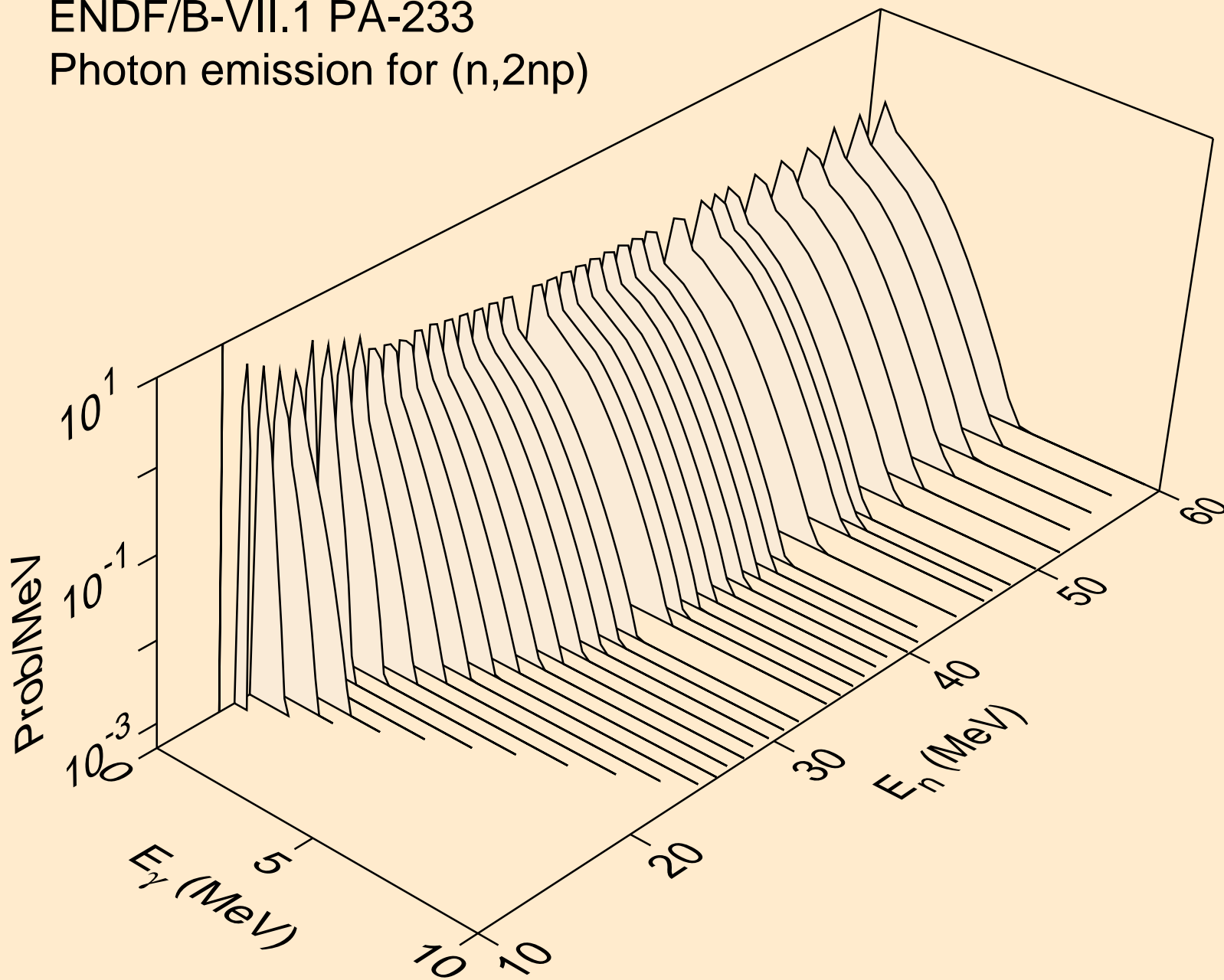

ENDF/B-VII.1 PA-233
Photon emission for (n,n*c)

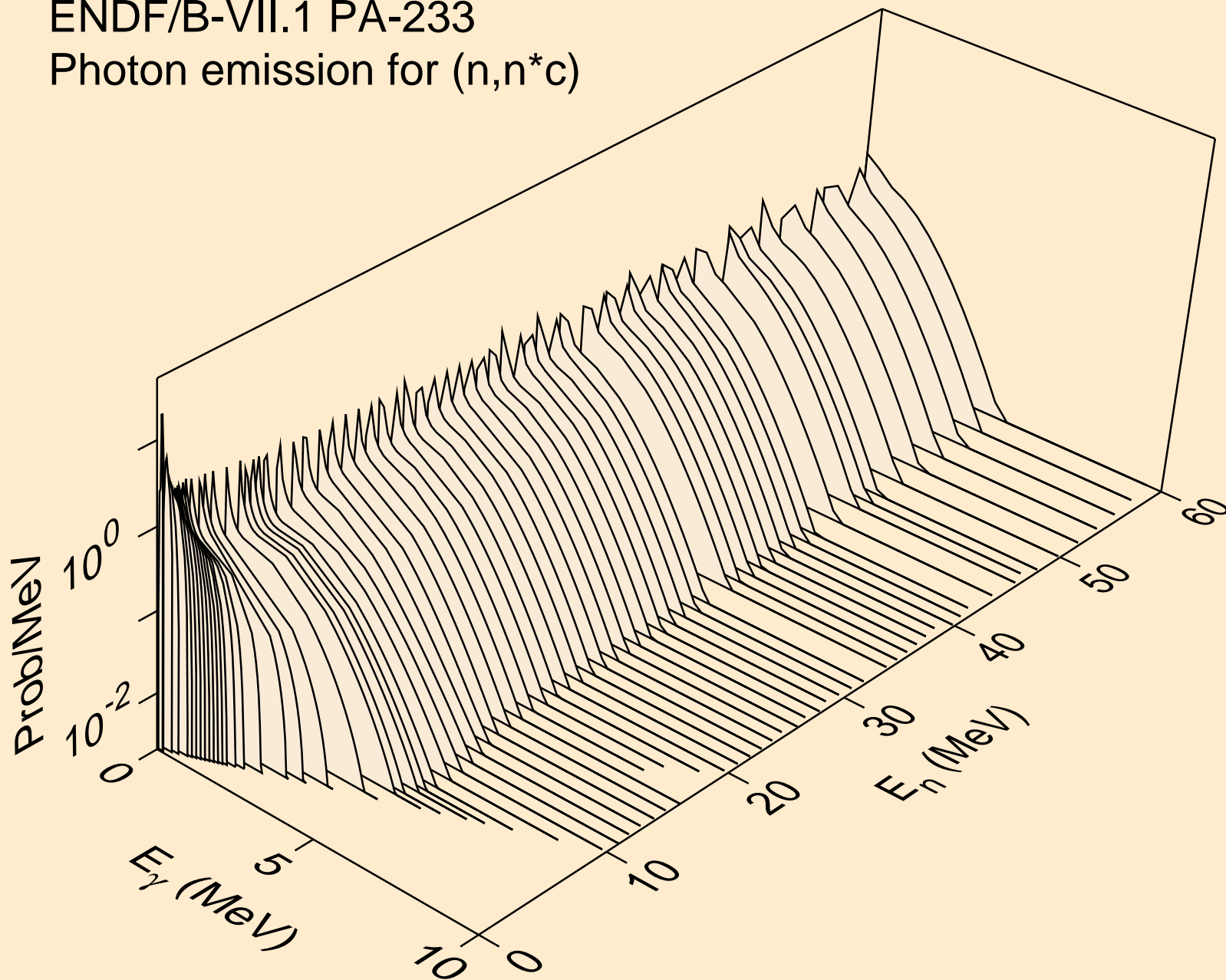

ENDF/B-VII.1 PA-233
Photon emission for (n,gma)

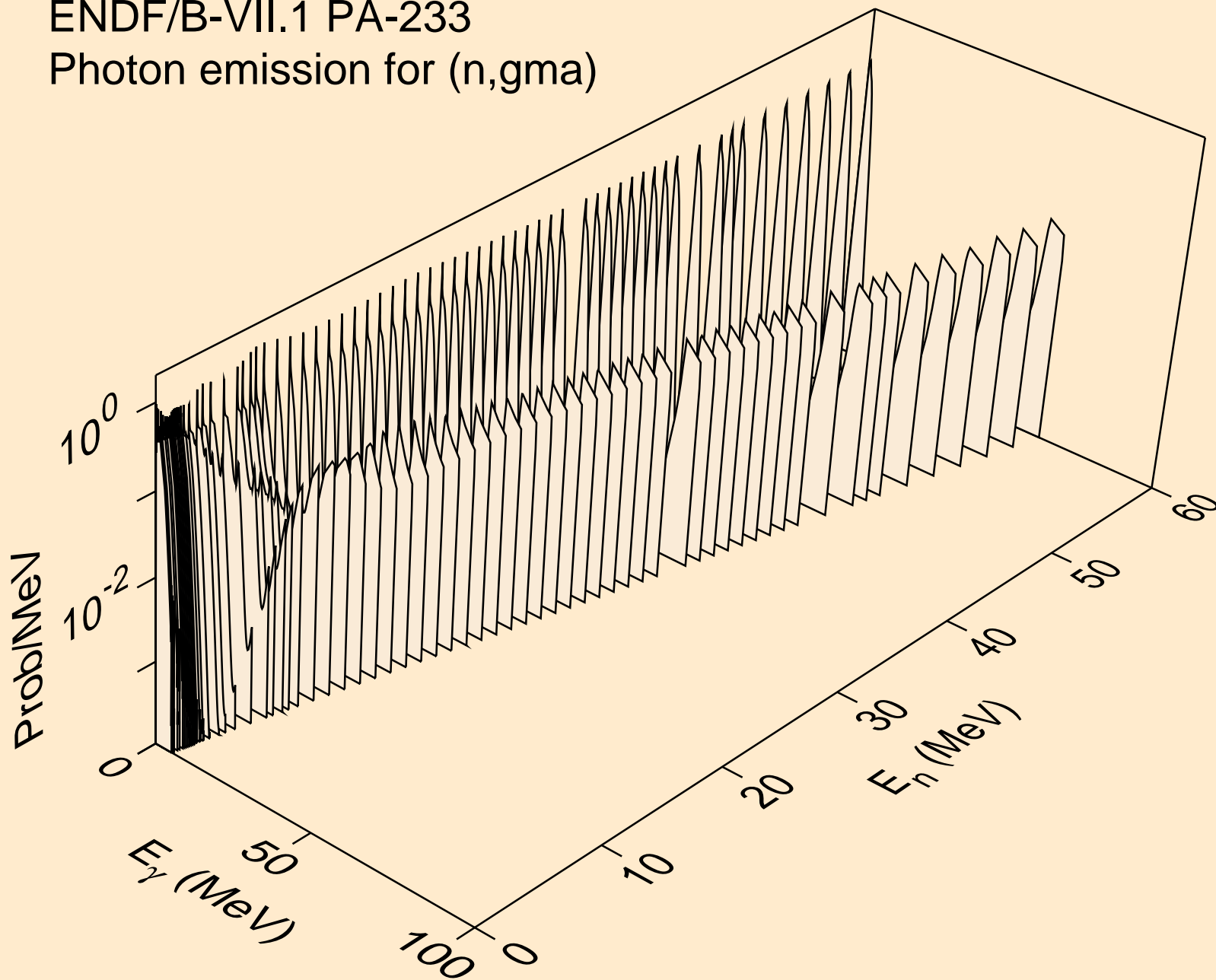

ENDF/B-VII.1 PA-233
Photon emission for (n,p*c)

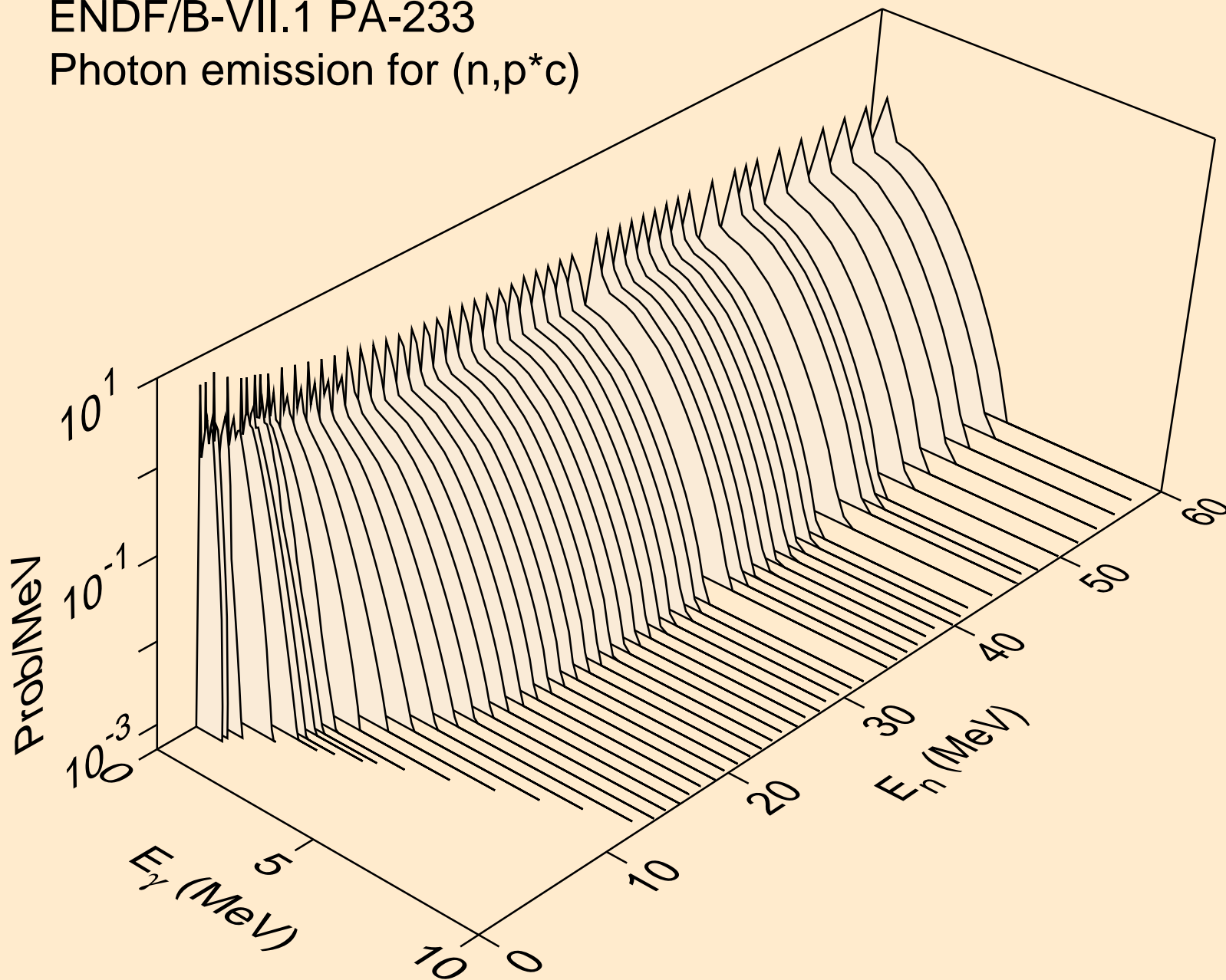

ENDF/B-VII.1 PA-233
thermal capture photon spectrum

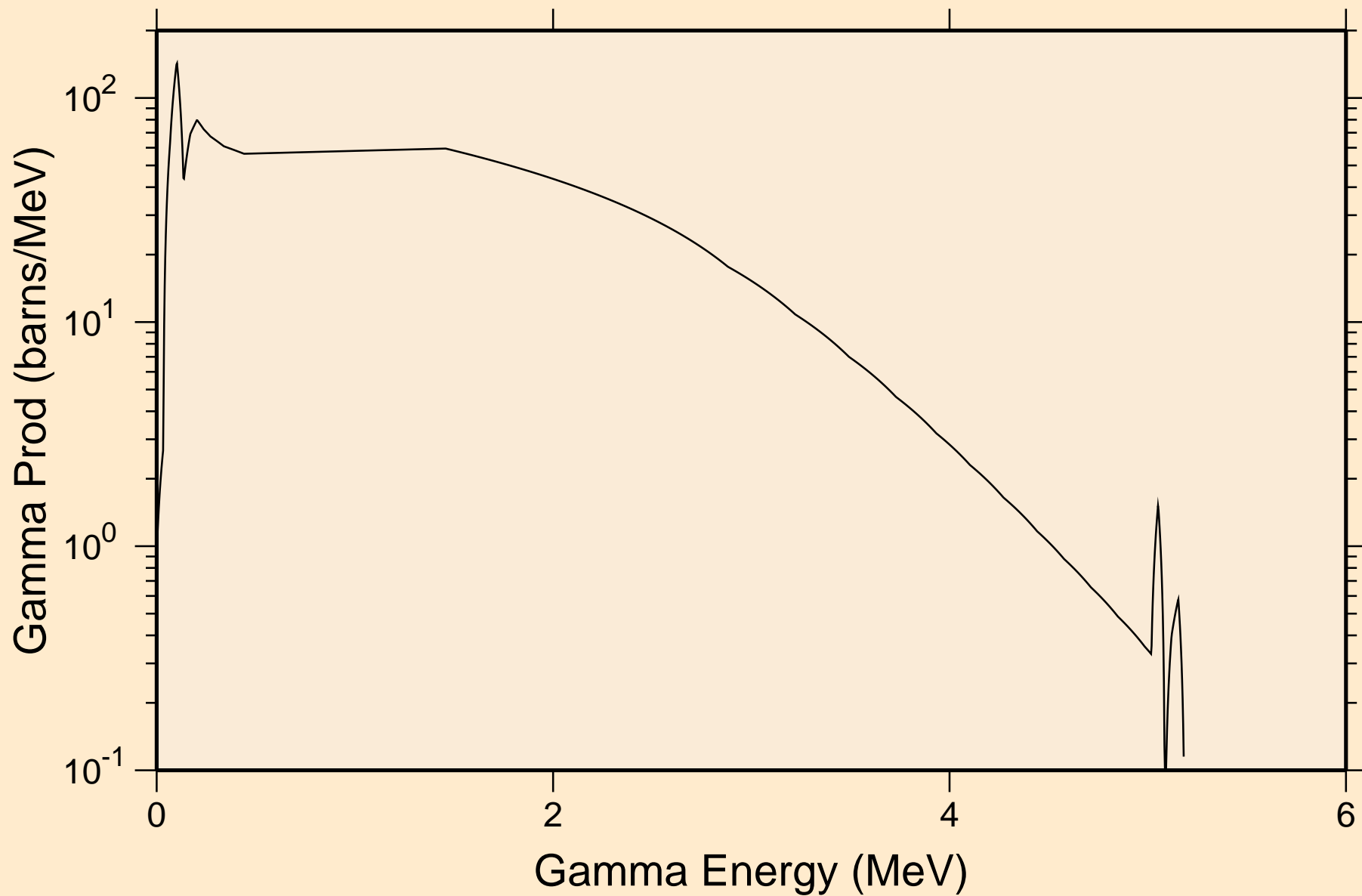

ENDF/B-VII.1 PA-233
14 MeV photon spectrum

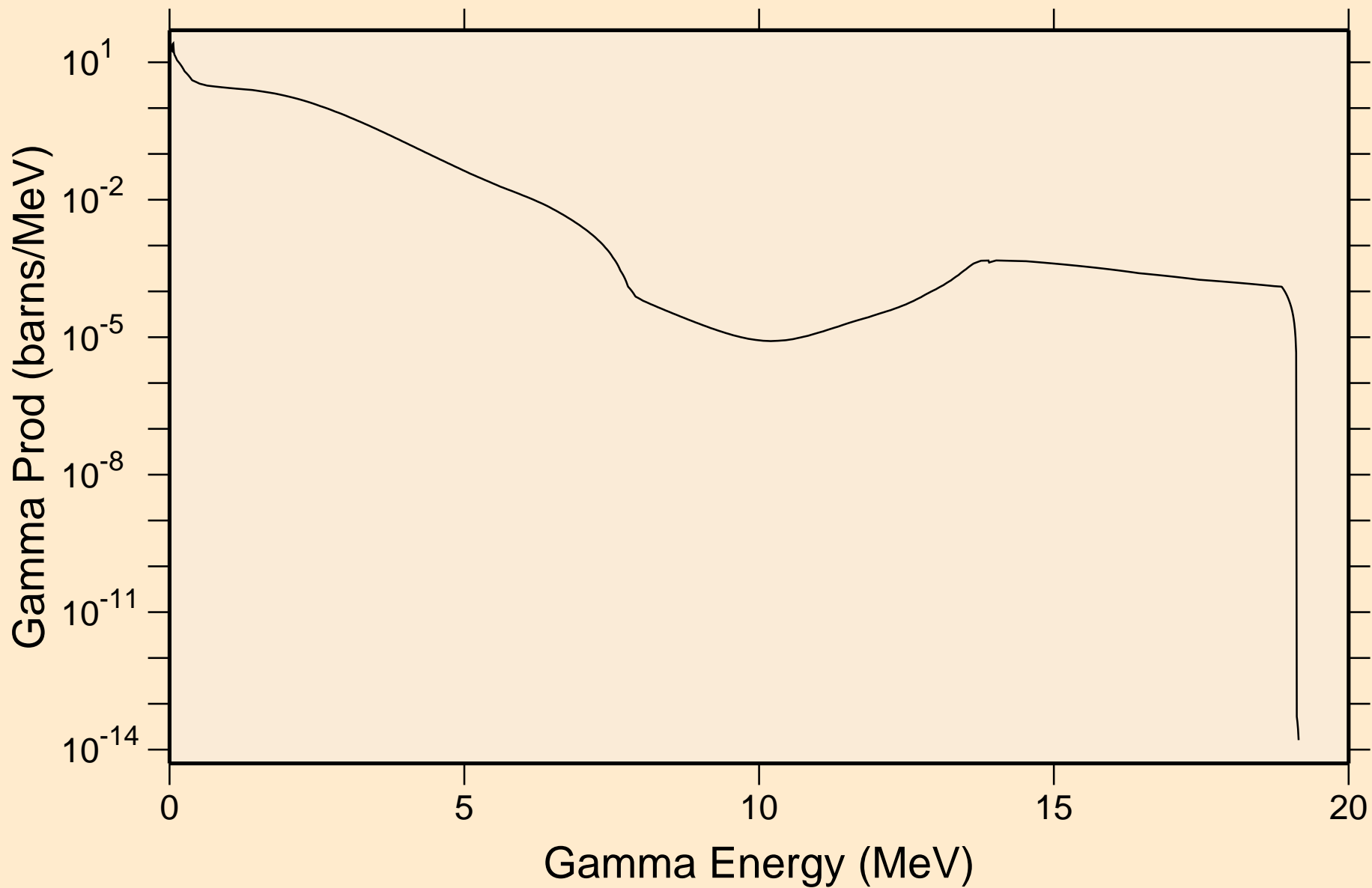

ENDF/B-VII.1 PA-233

Particle heating contributions

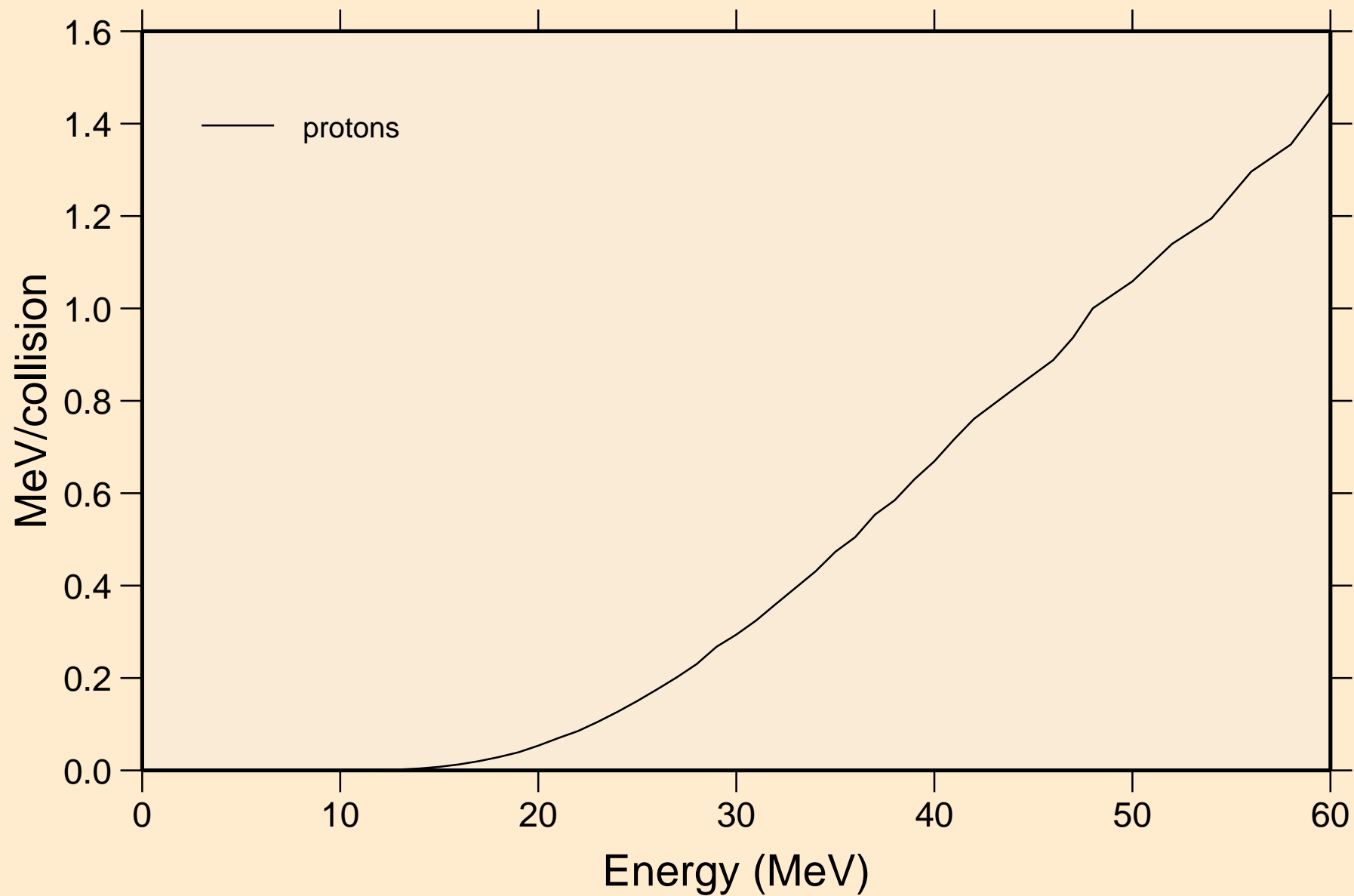

ENDF/B-VII.1 PA-233

Recoil Heating

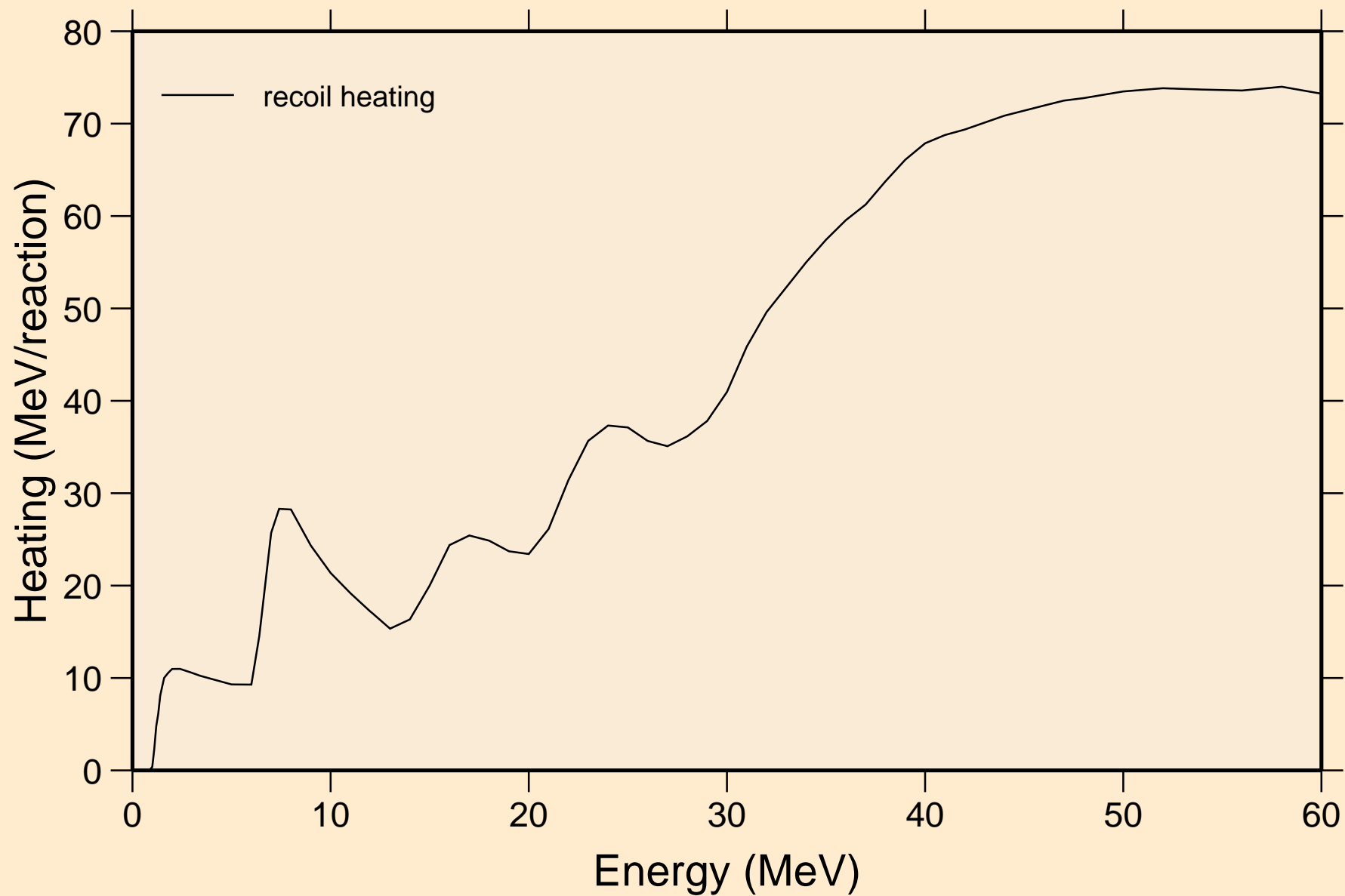

ENDF/B-VII.1 PA-233
Particle production cross sections

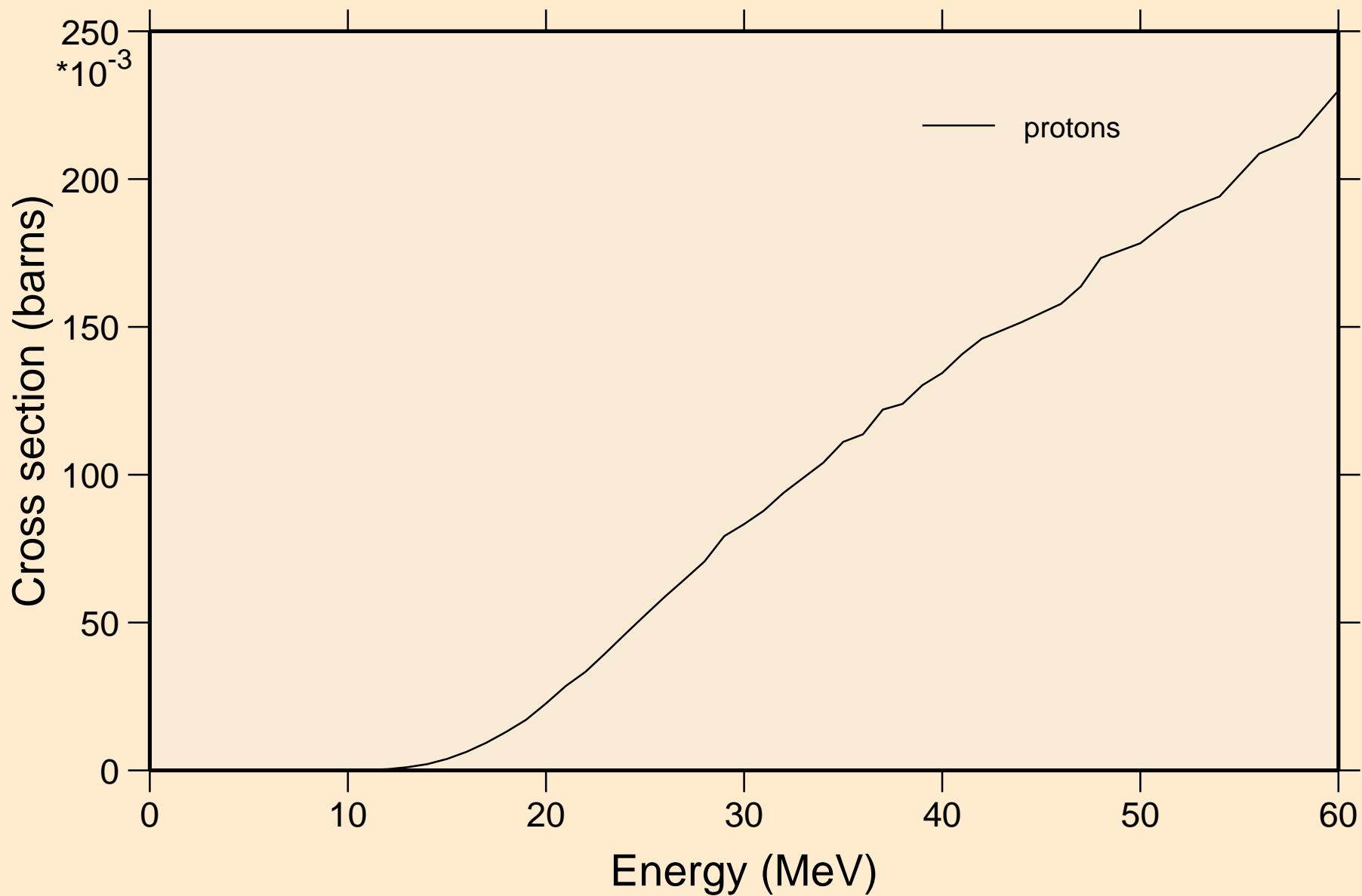

ENDF/B-VII.1 PA-233
protons from (n,x)

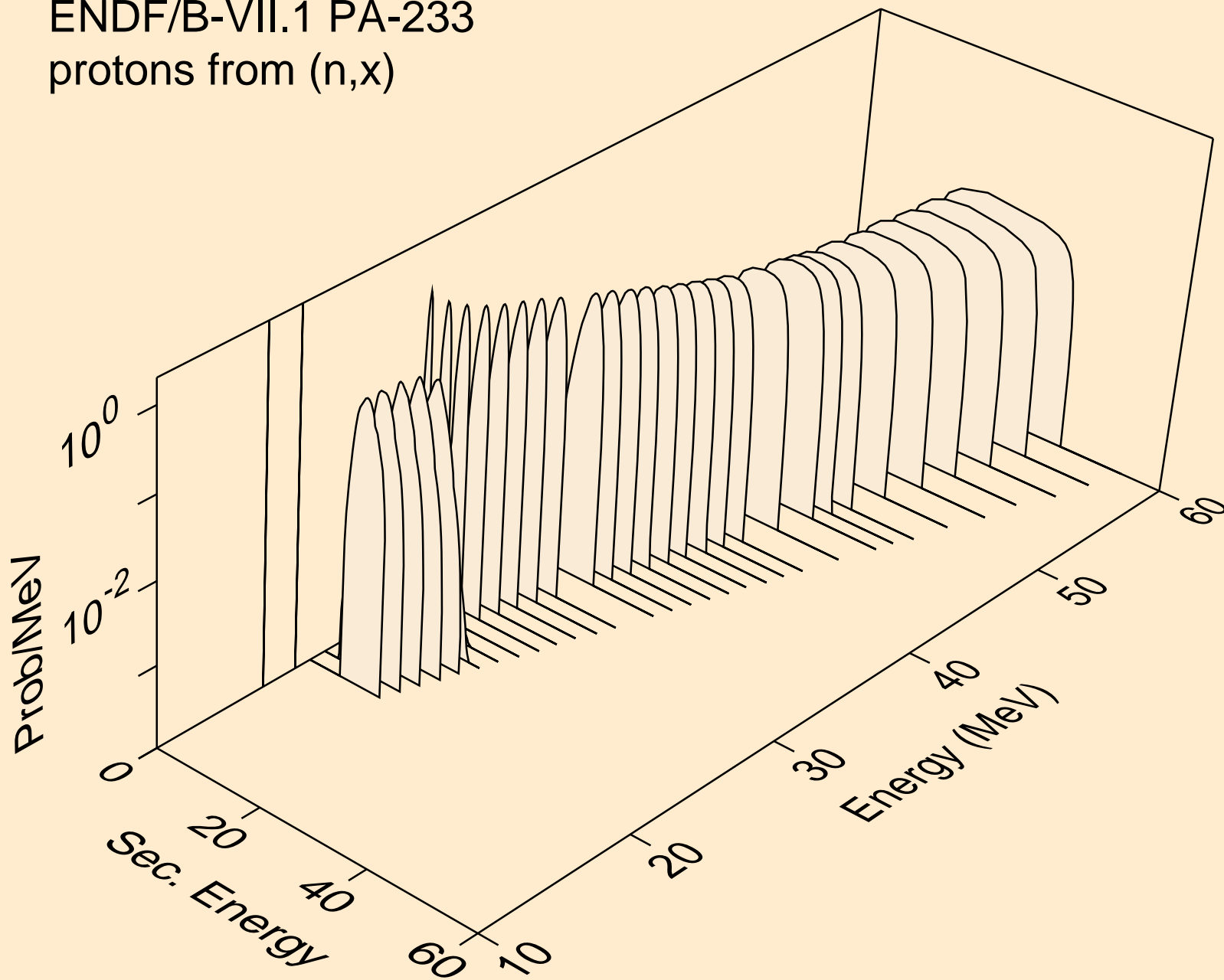

ENDF/B-VII.1 PA-233
protons from (n,n*)p

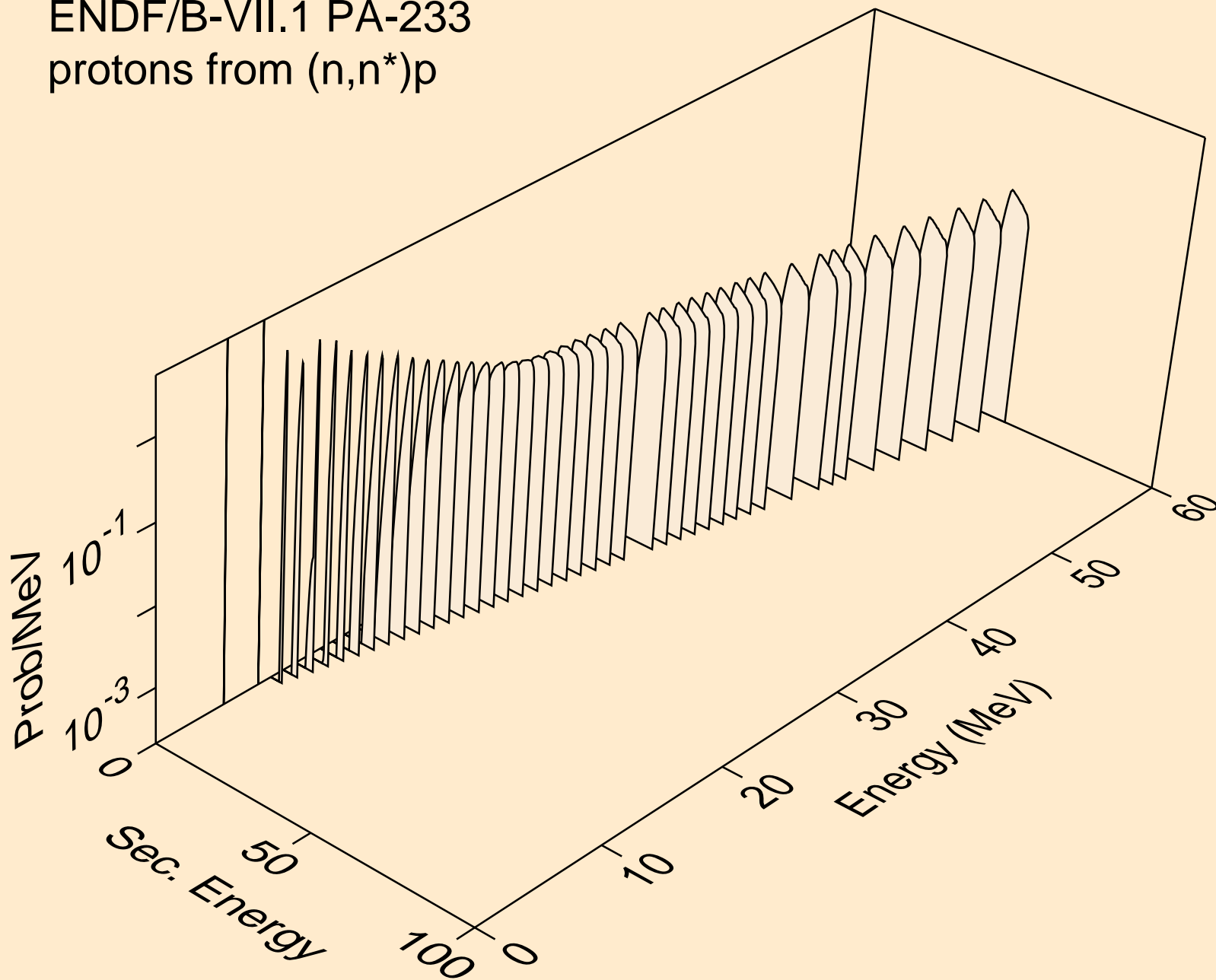

ENDF/B-VII.1 PA-233
protons from (n,2np)

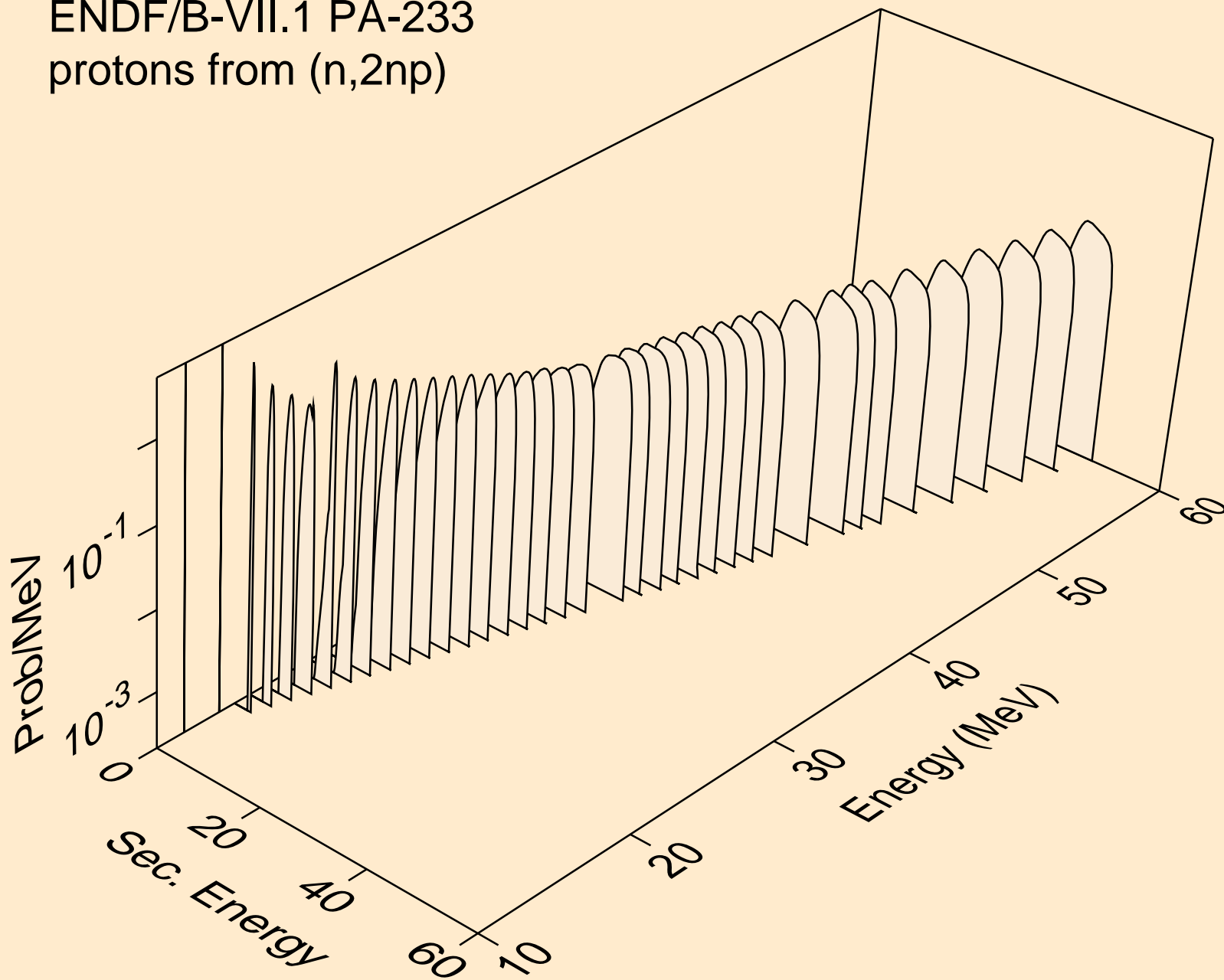

ENDF/B-VII.1 PA-233
angular distribution for (n,p*0) proton

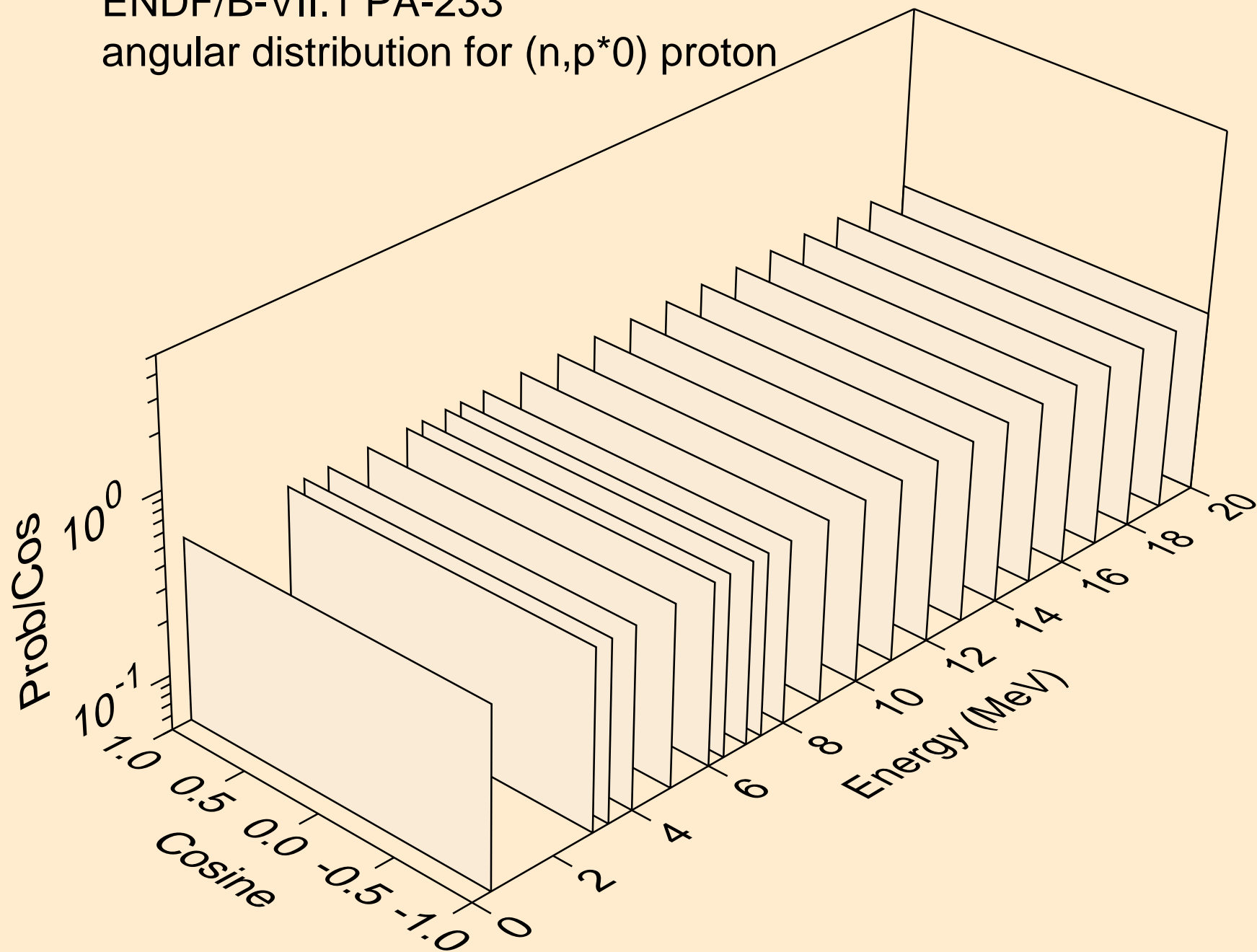

ENDF/B-VII.1 PA-233

angular distribution for (n,p*0) proton

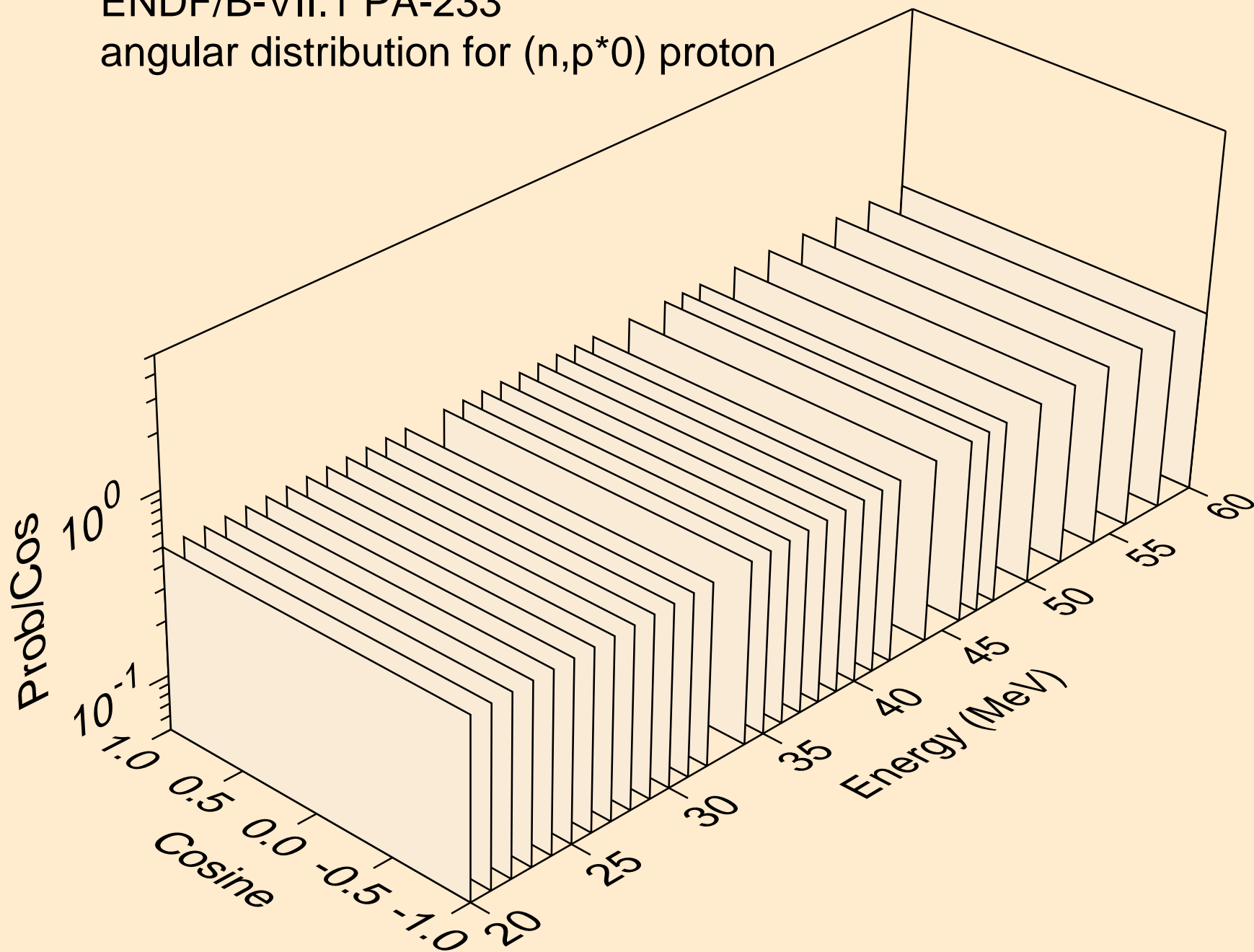

ENDF/B-VII.1 PA-233
angular distribution for (n,p*1) proton

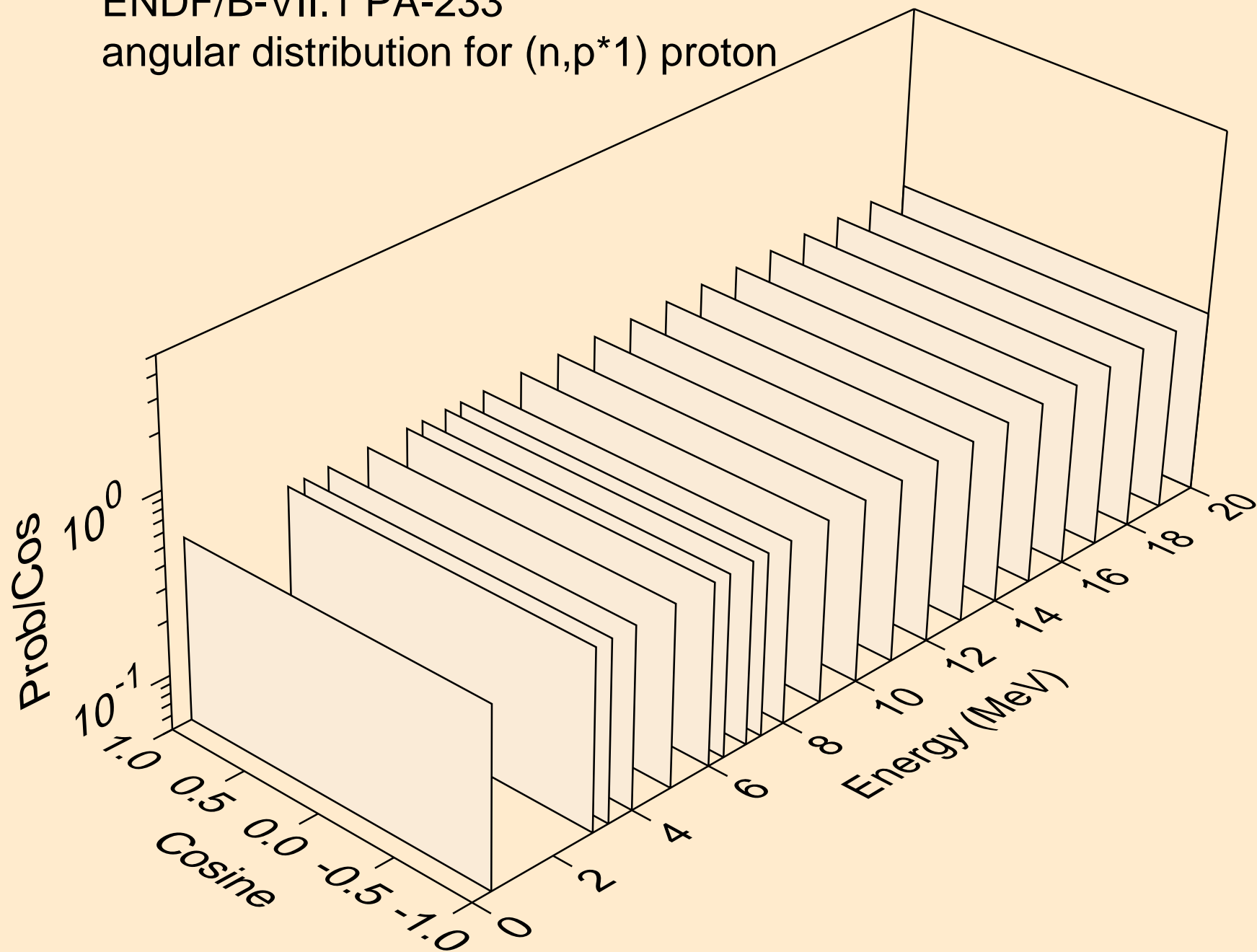

ENDF/B-VII.1 PA-233

angular distribution for (n,p*1) proton

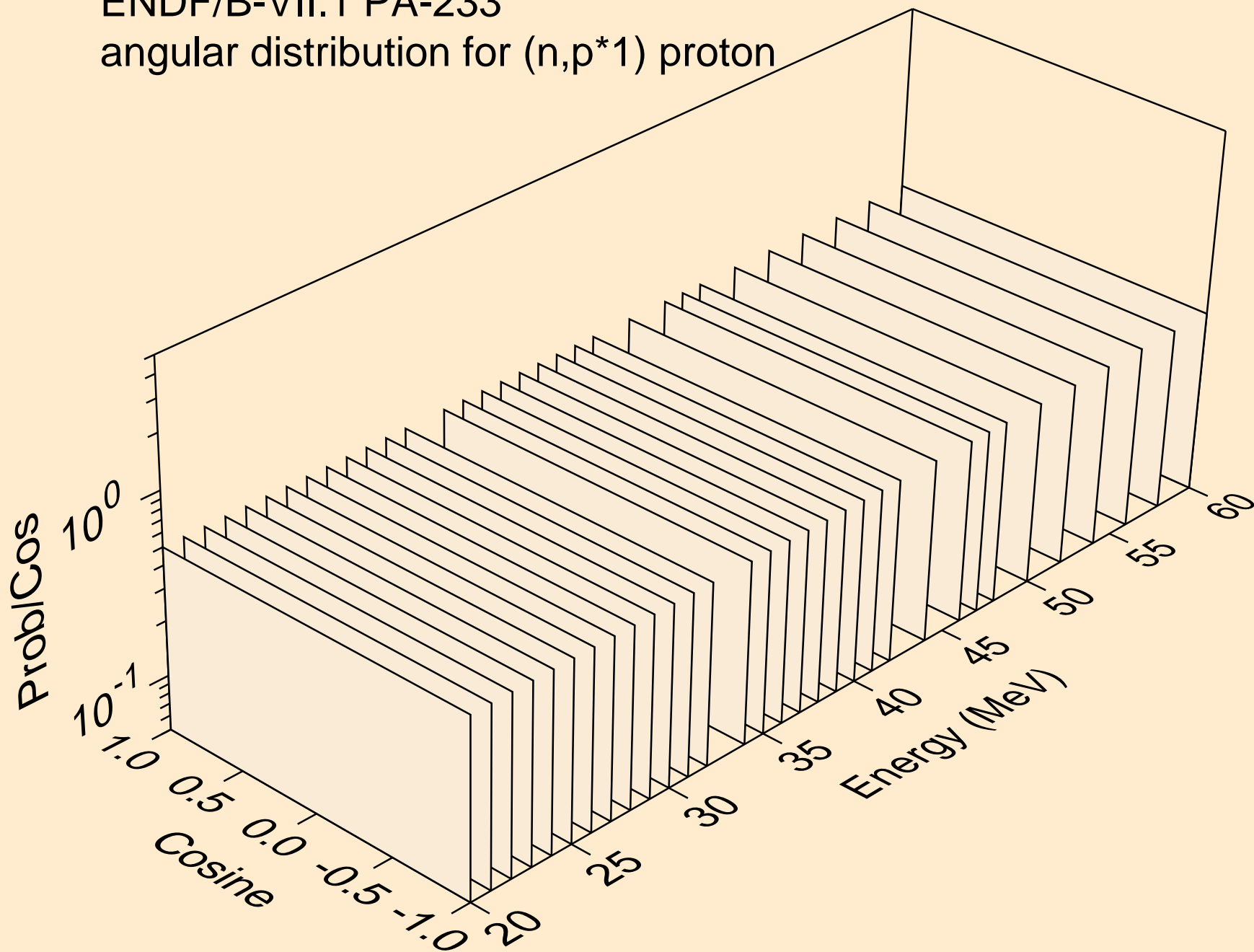

ENDF/B-VII.1 PA-233
angular distribution for (n,p*2) proton

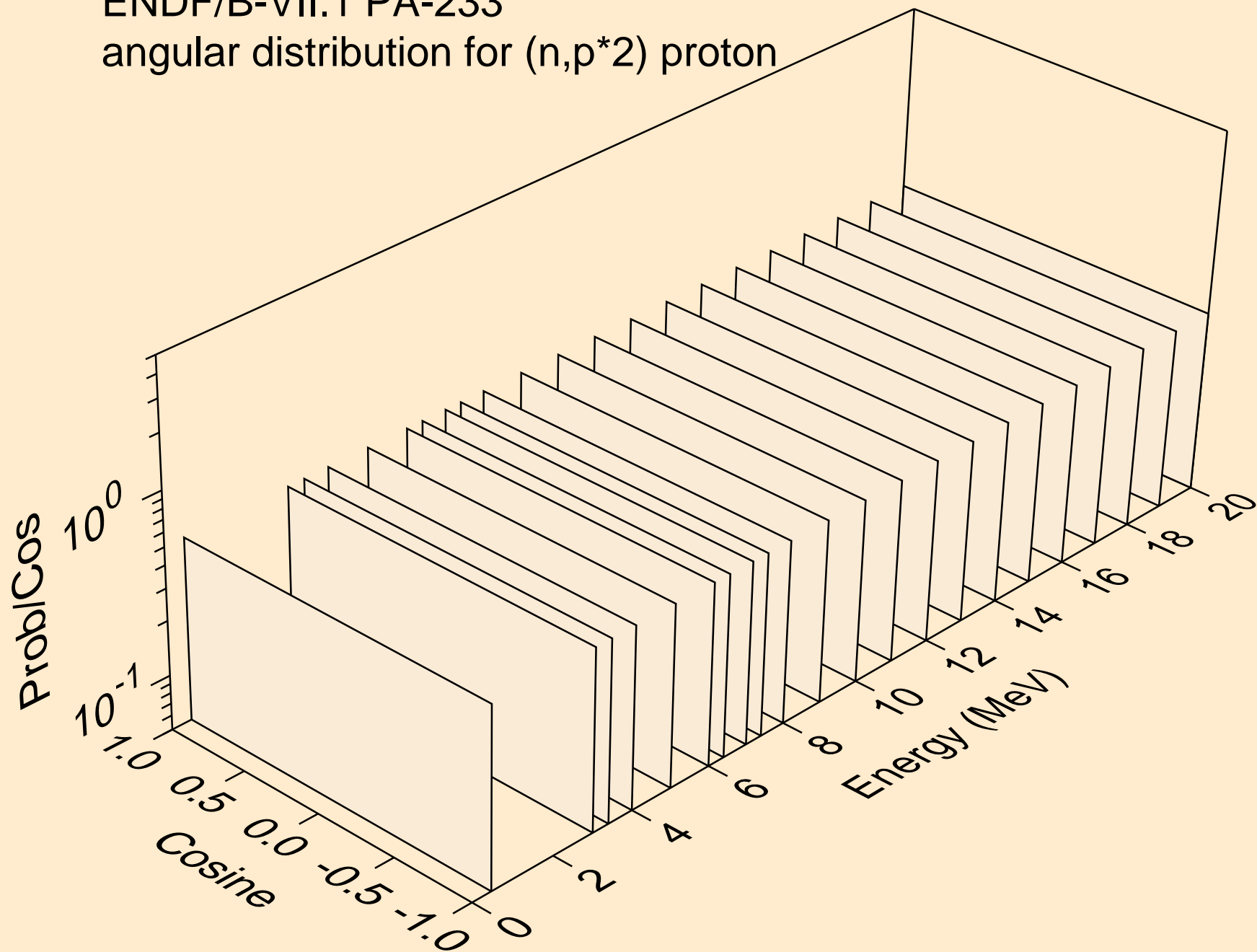

ENDF/B-VII.1 PA-233

angular distribution for (n,p*2) proton

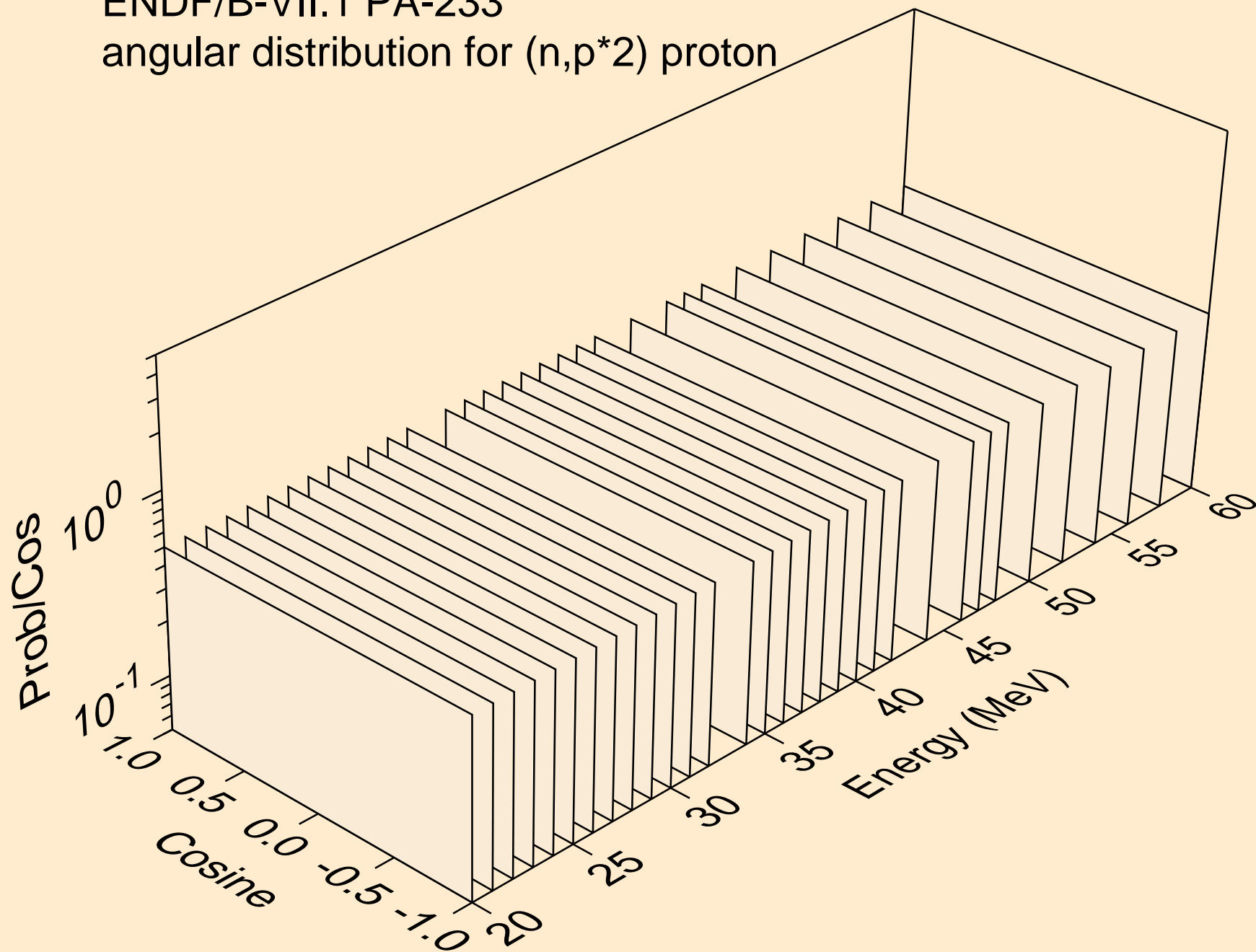

ENDF/B-VII.1 PA-233
angular distribution for (n,p*3) proton

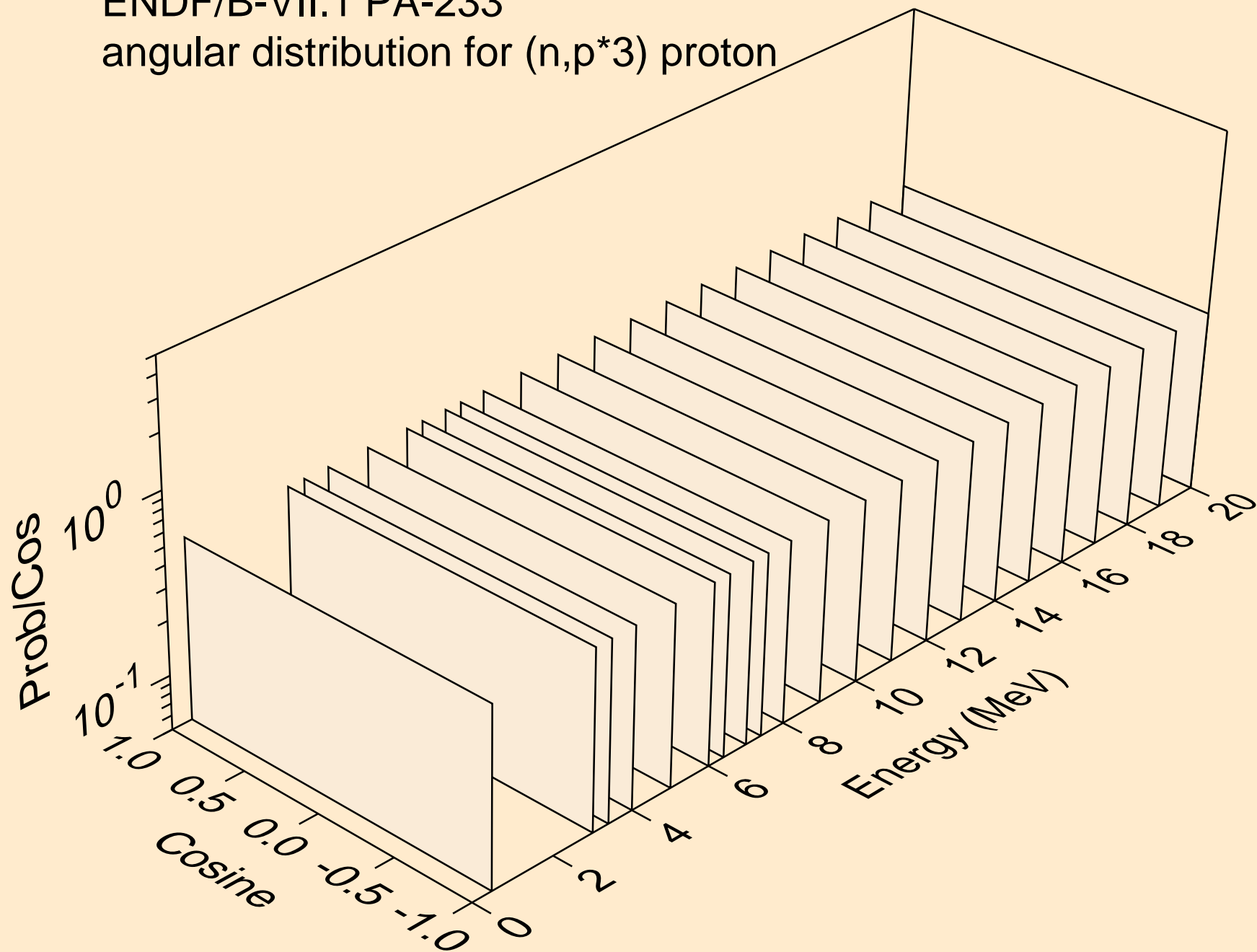

ENDF/B-VII.1 PA-233
angular distribution for (n,p*3) proton

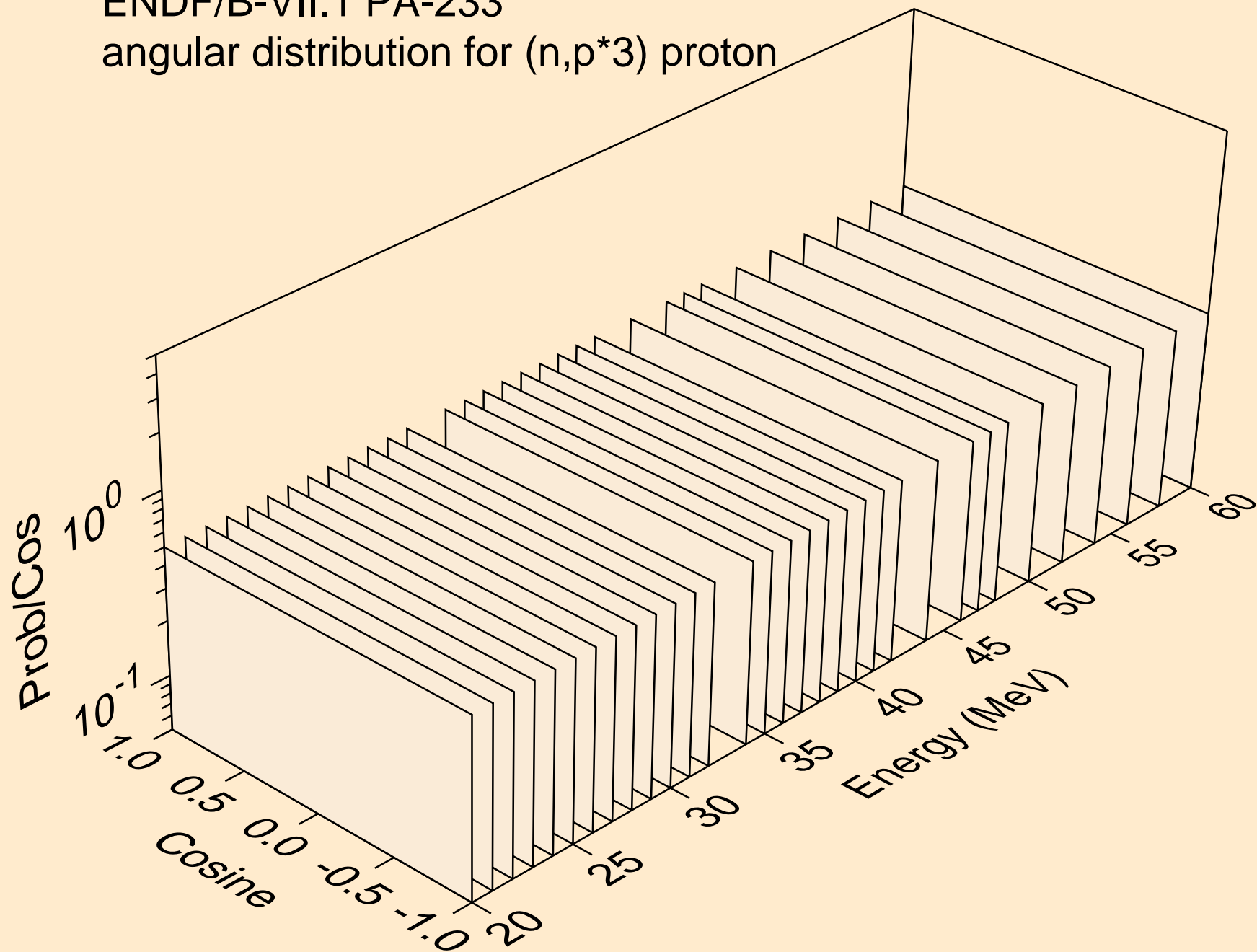

ENDF/B-VII.1 PA-233
angular distribution for (n,p*4) proton

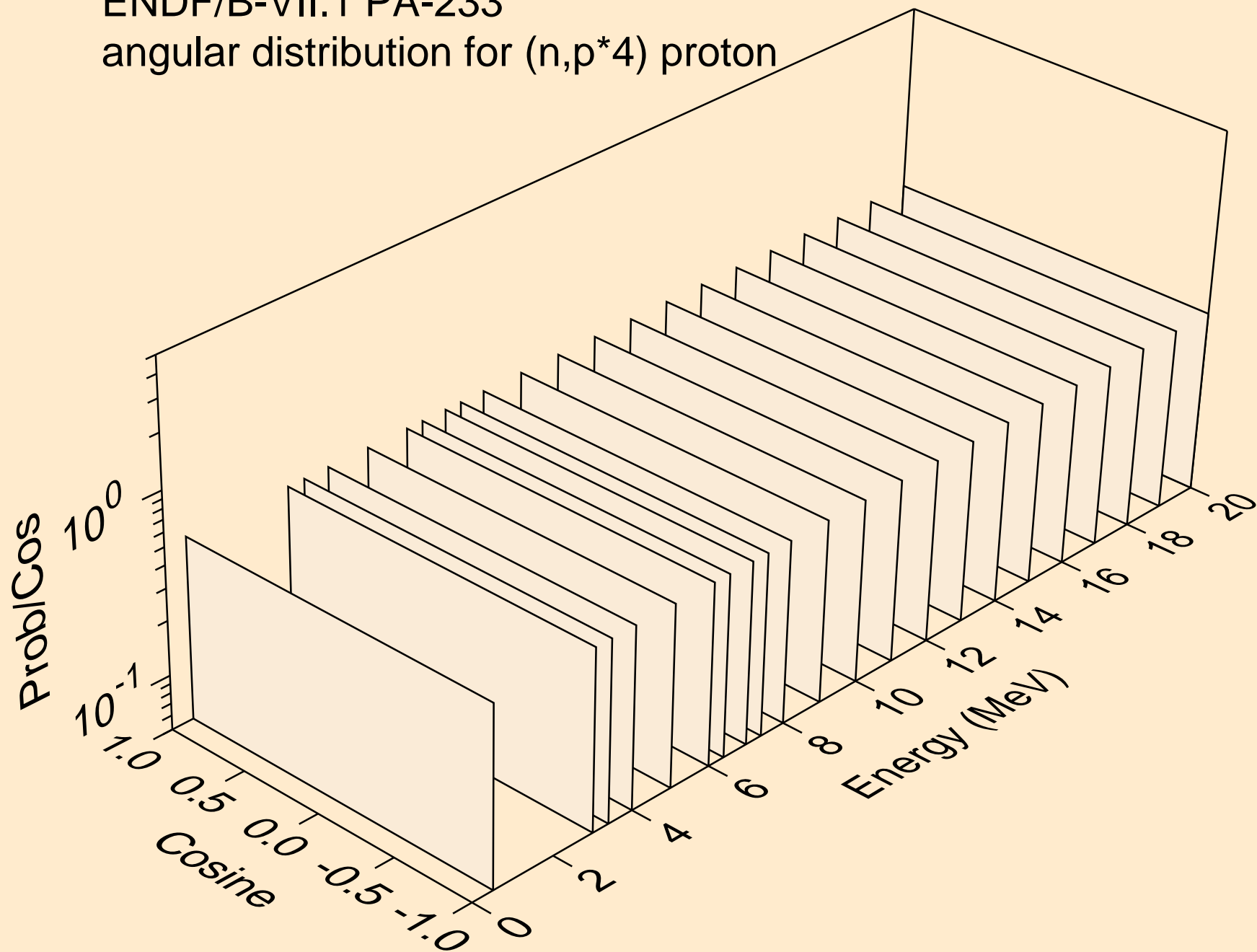

ENDF/B-VII.1 PA-233
angular distribution for (n,p*4) proton

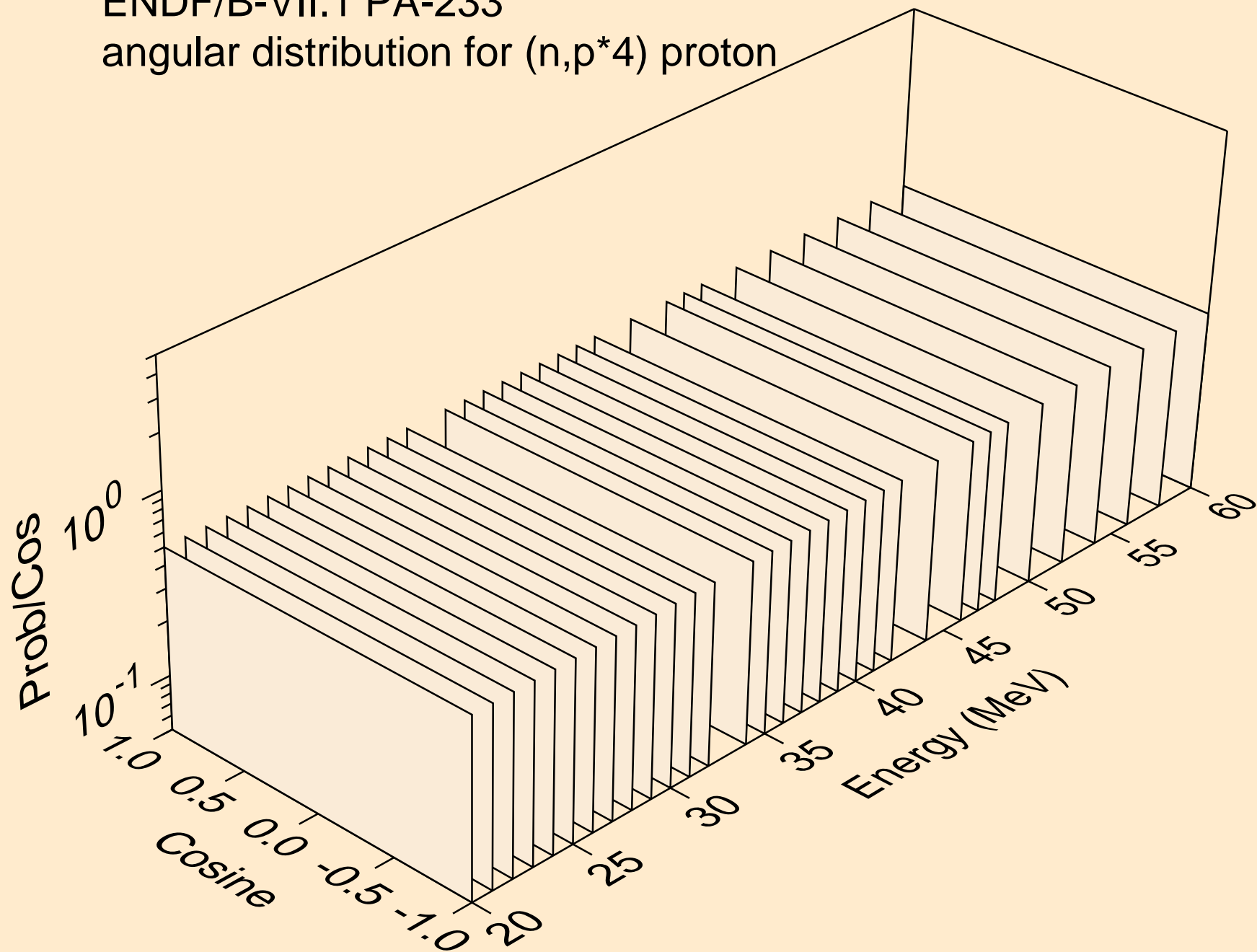

ENDF/B-VII.1 PA-233
angular distribution for (n,p*5) proton

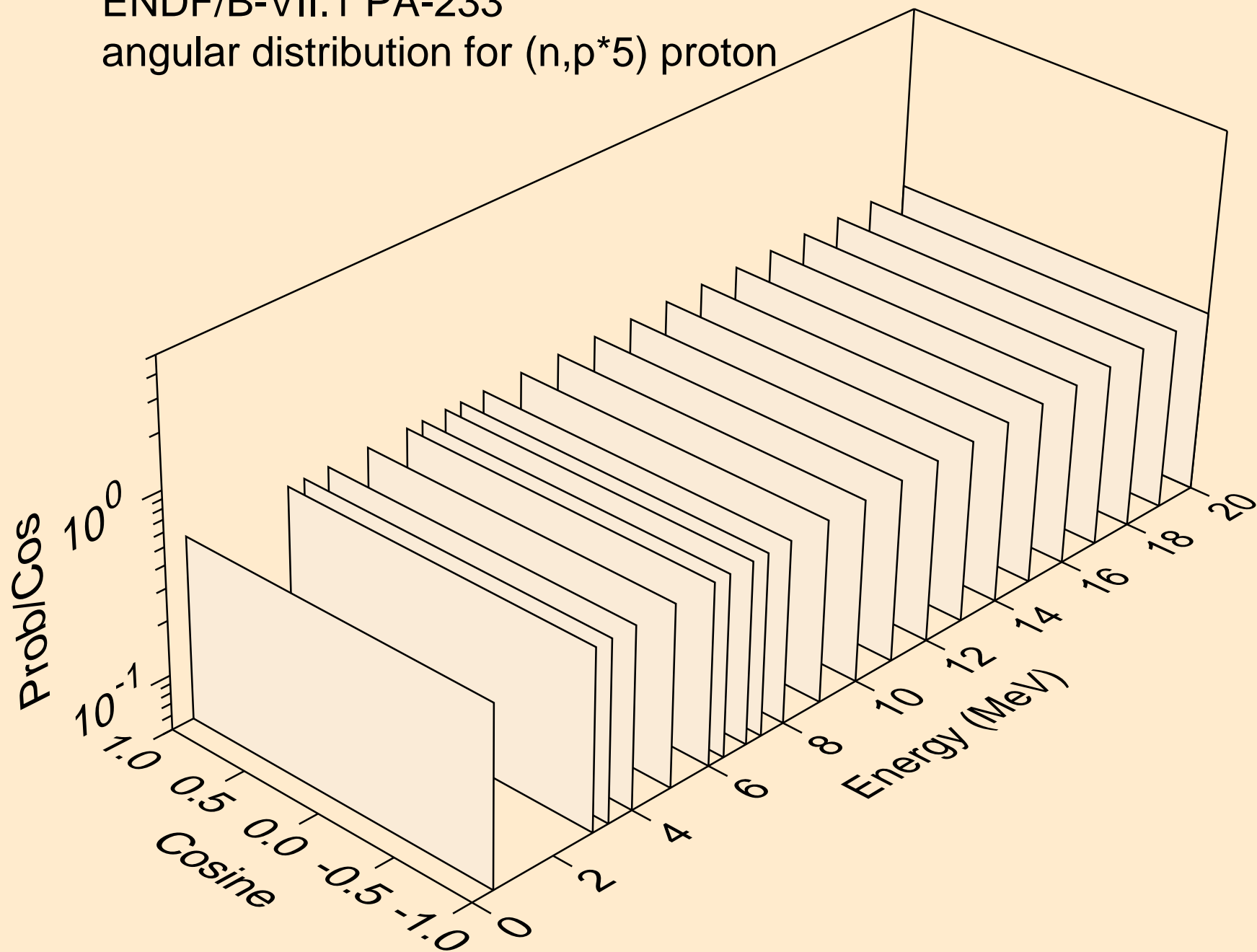

ENDF/B-VII.1 PA-233

angular distribution for (n,p*5) proton

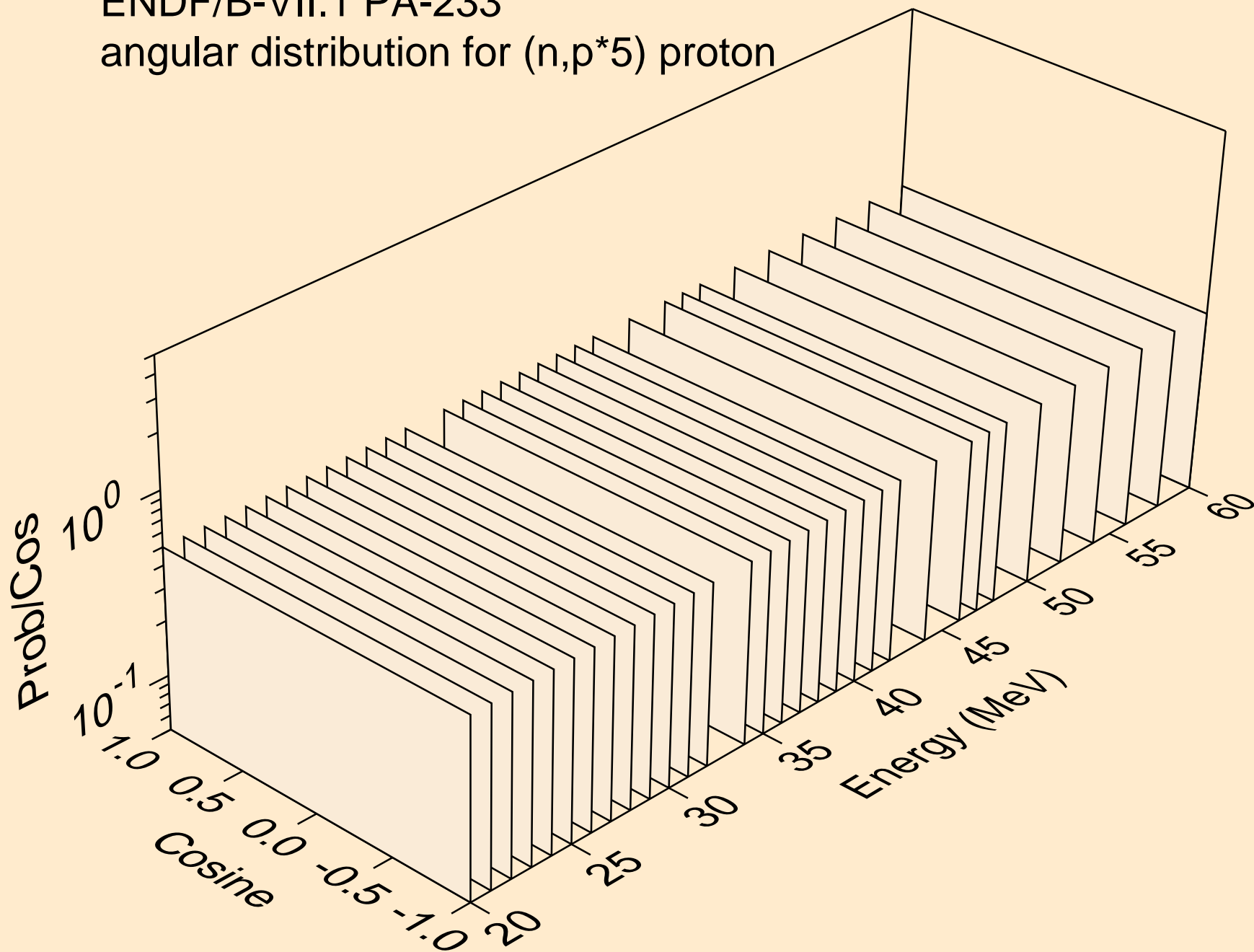

ENDF/B-VII.1 PA-233
angular distribution for (n,p*6) proton

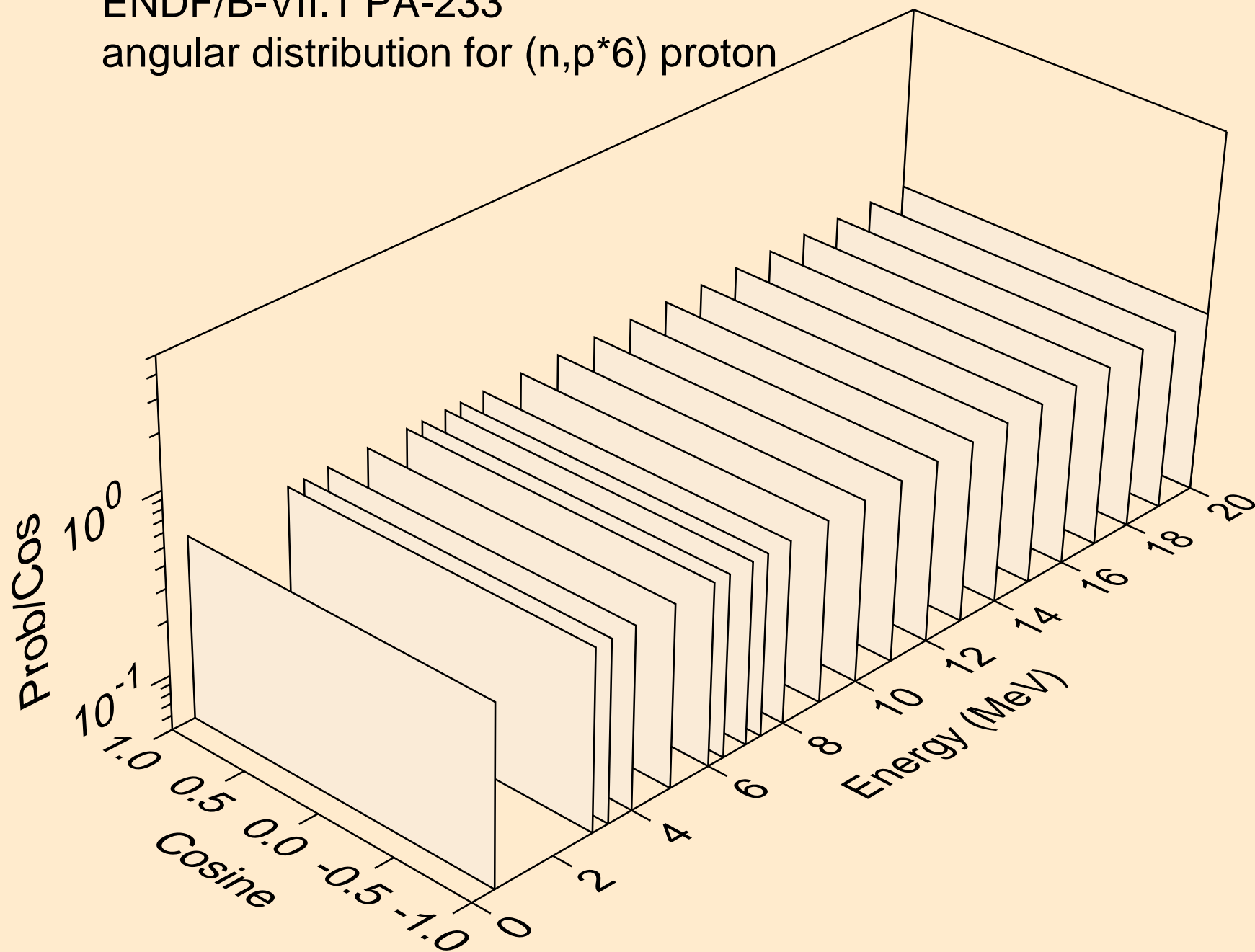

ENDF/B-VII.1 PA-233
angular distribution for (n,p*6) proton

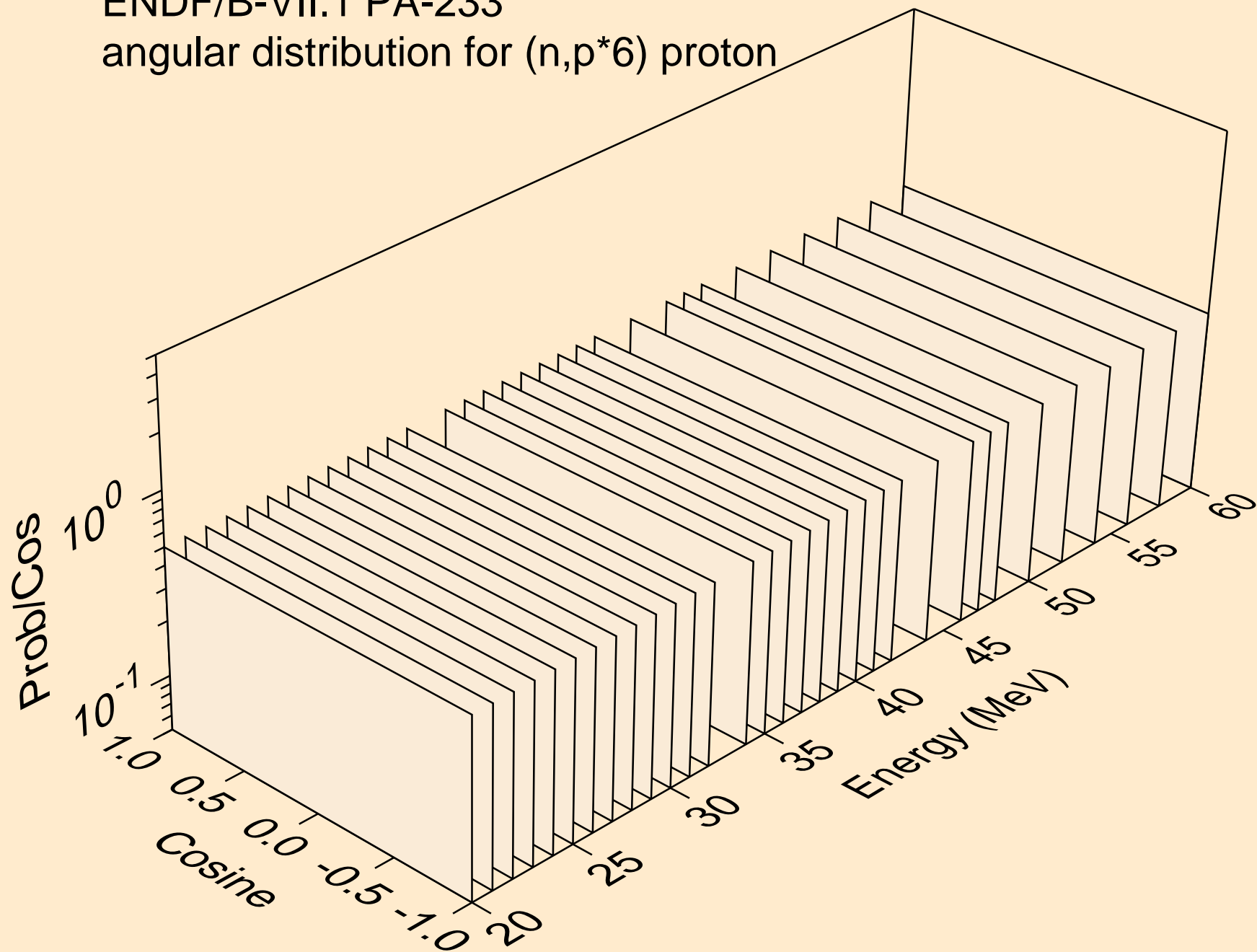

ENDF/B-VII.1 PA-233
angular distribution for (n,p*7) proton

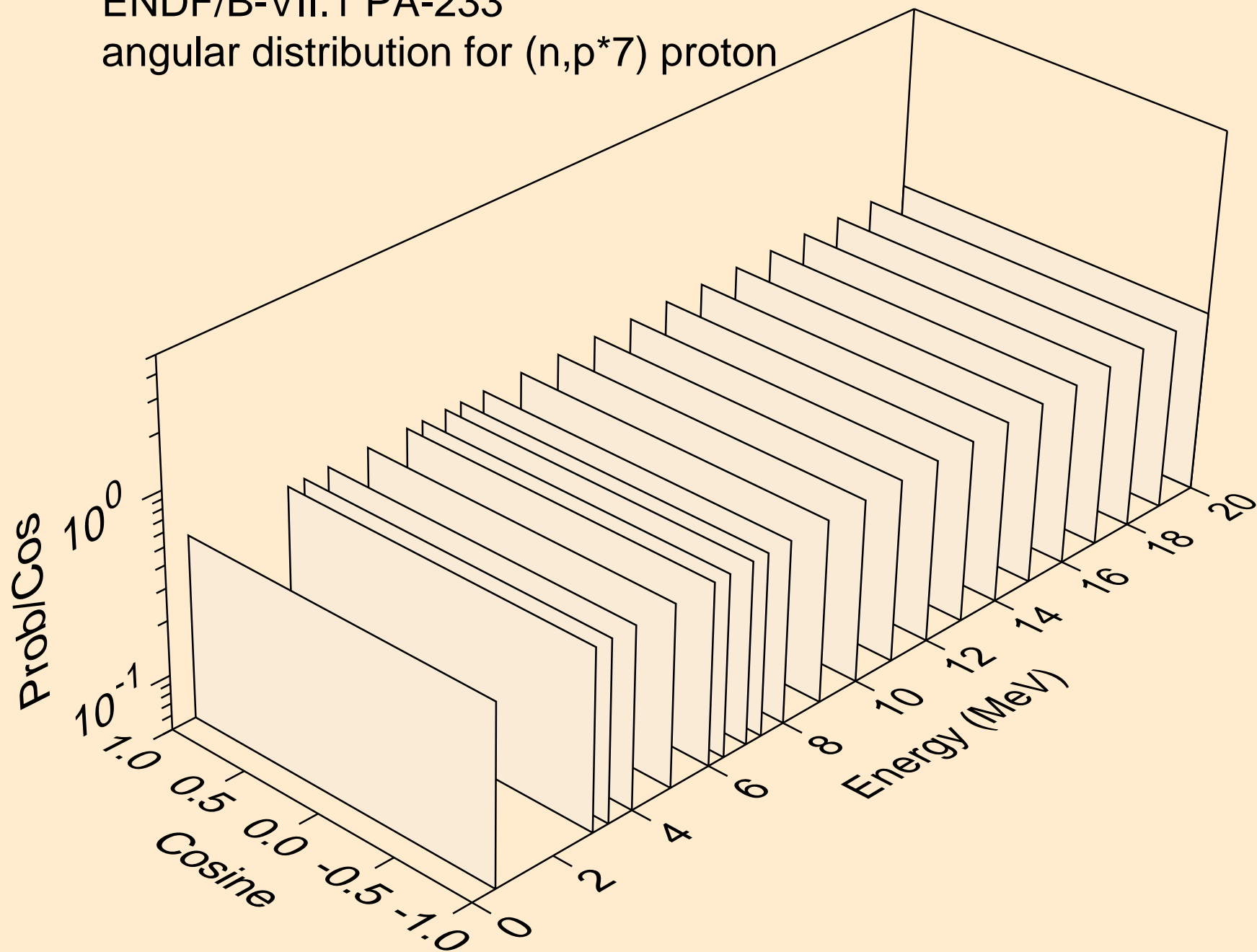

ENDF/B-VII.1 PA-233
angular distribution for (n,p*7) proton

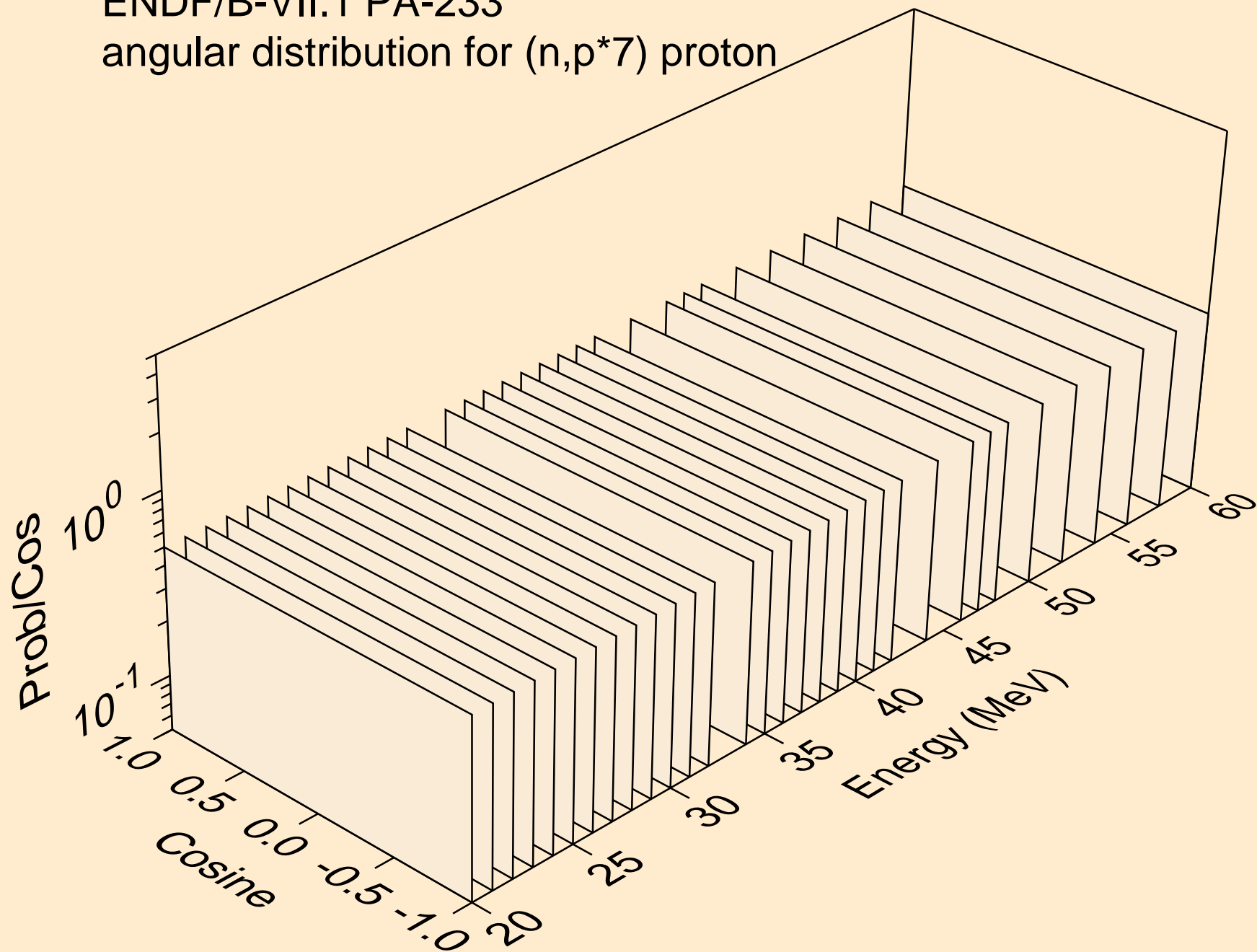

ENDF/B-VII.1 PA-233
angular distribution for (n,p*8) proton

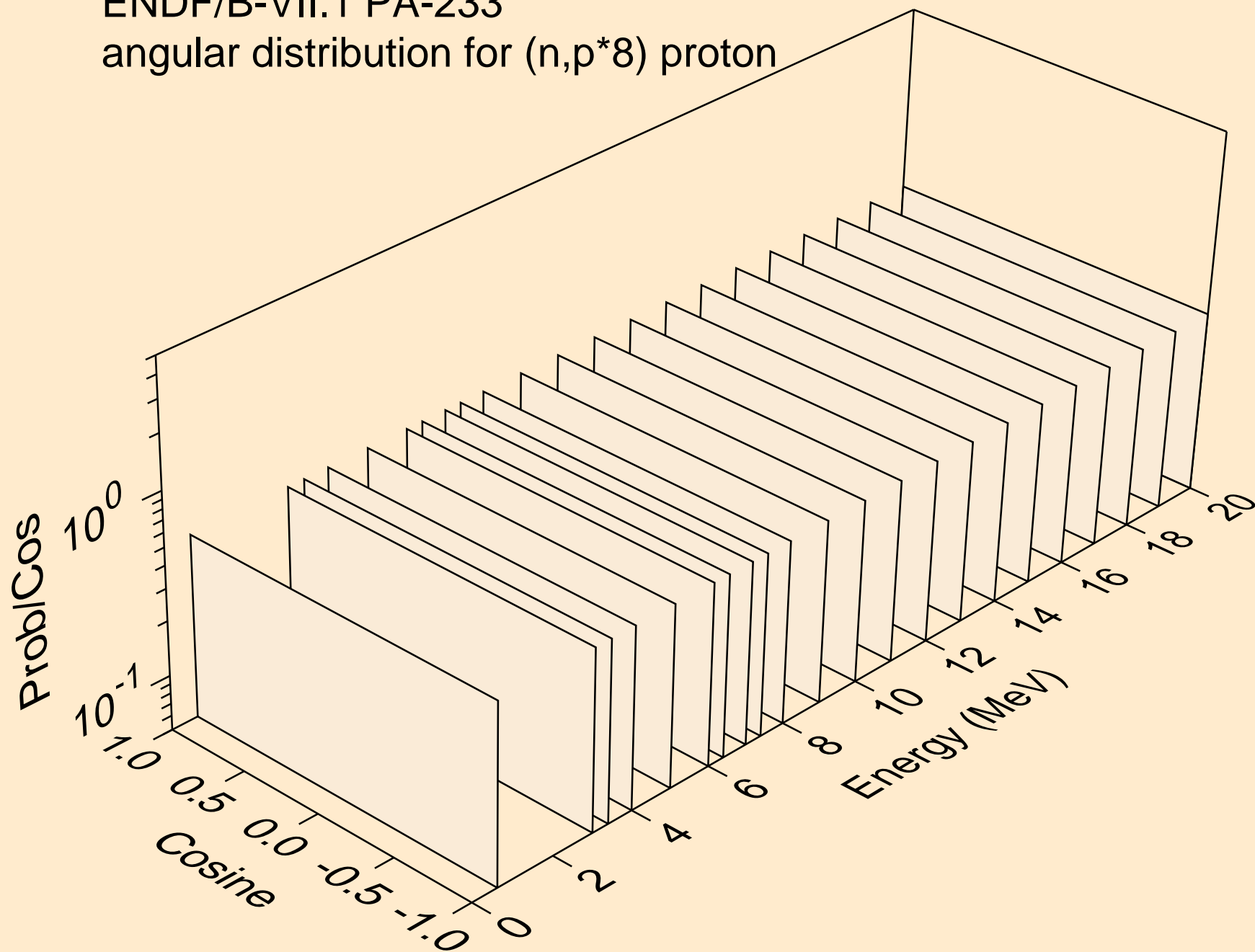

ENDF/B-VII.1 PA-233

angular distribution for (n,p*8) proton

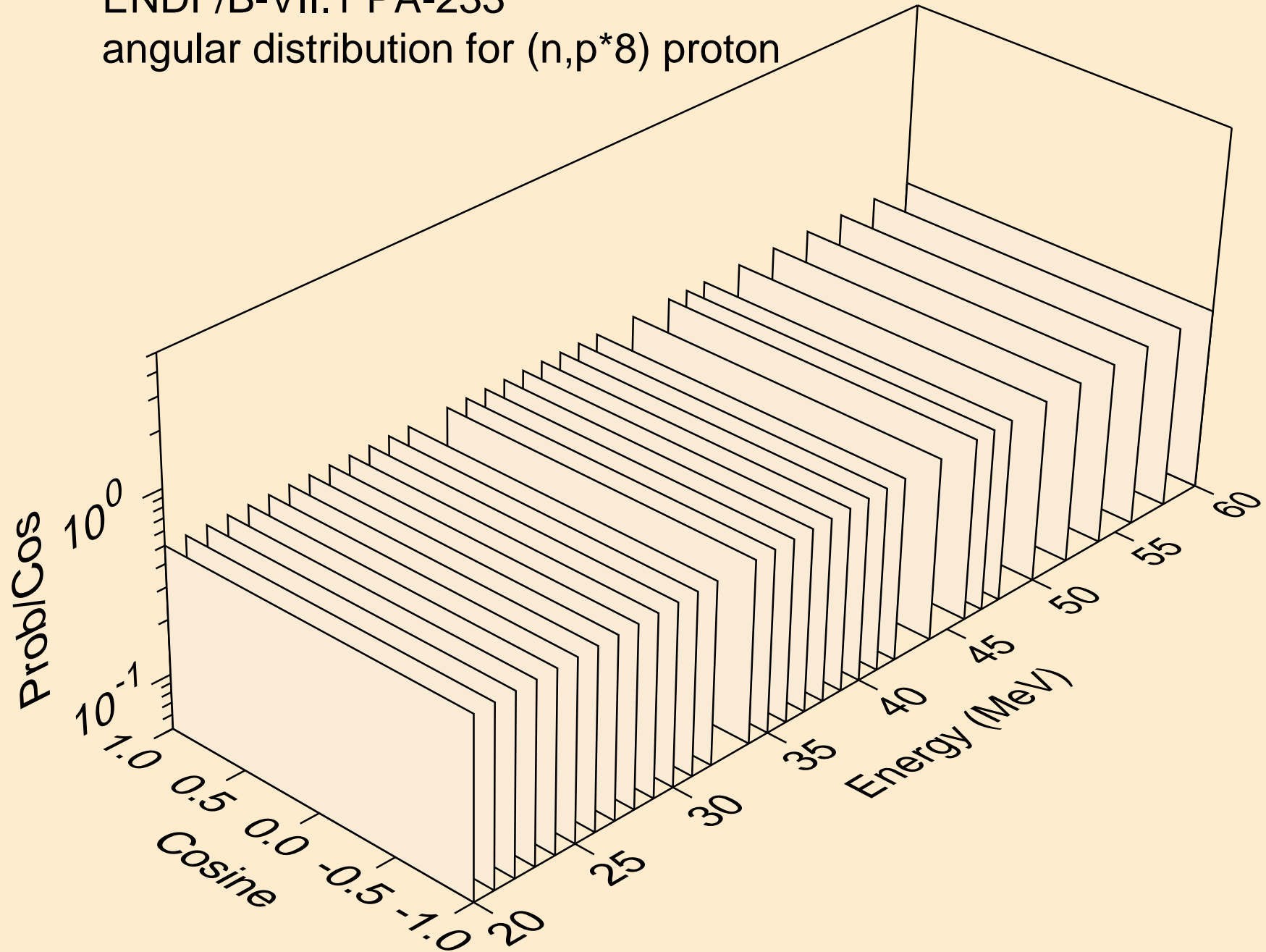

ENDF/B-VII.1 PA-233
angular distribution for (n,p*9) proton

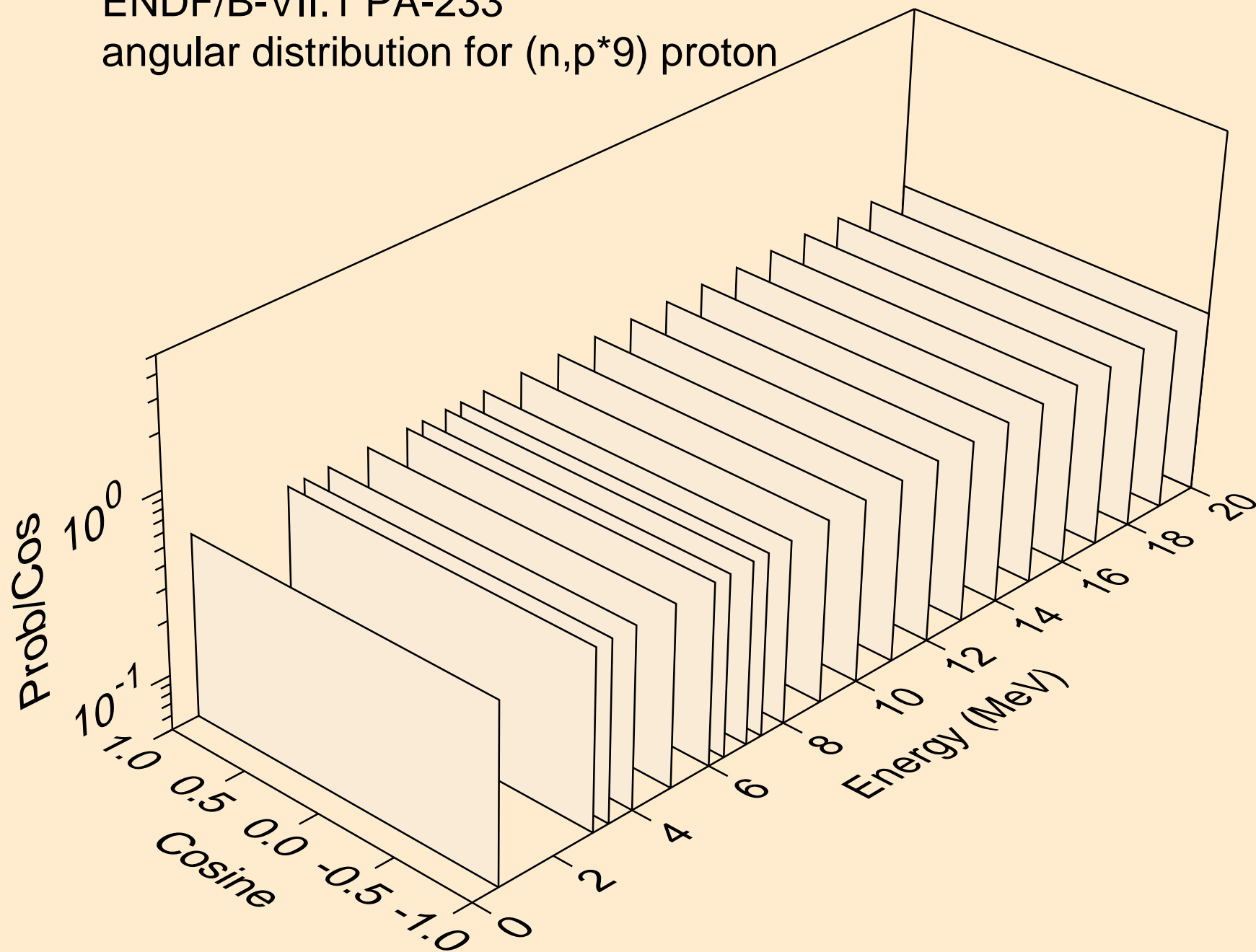

ENDF/B-VII.1 PA-233

angular distribution for (n,p*9) proton

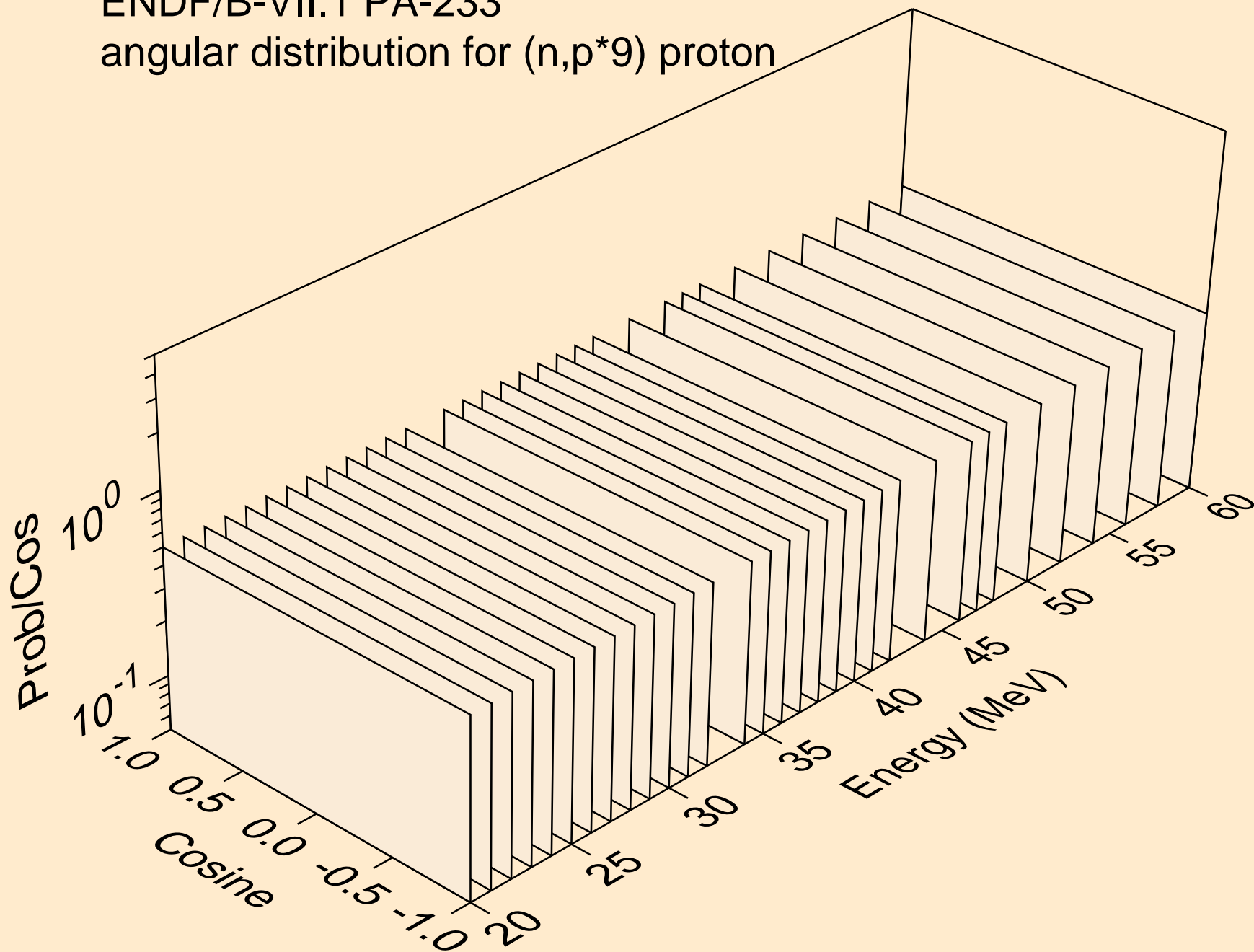

ENDF/B-VII.1 PA-233
angular distribution for (n,p*10) proton

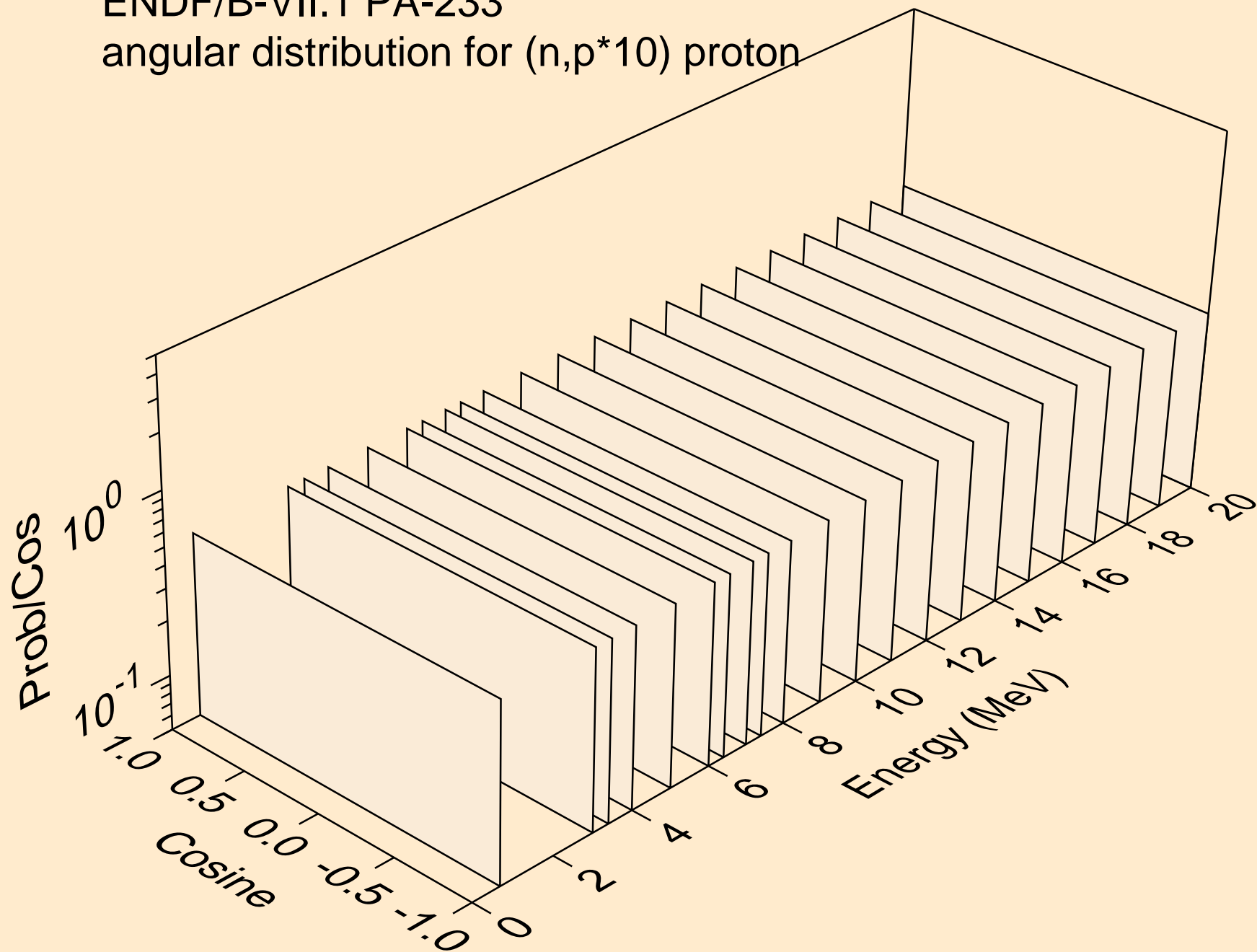

ENDF/B-VII.1 PA-233
angular distribution for (n,p*10) proton

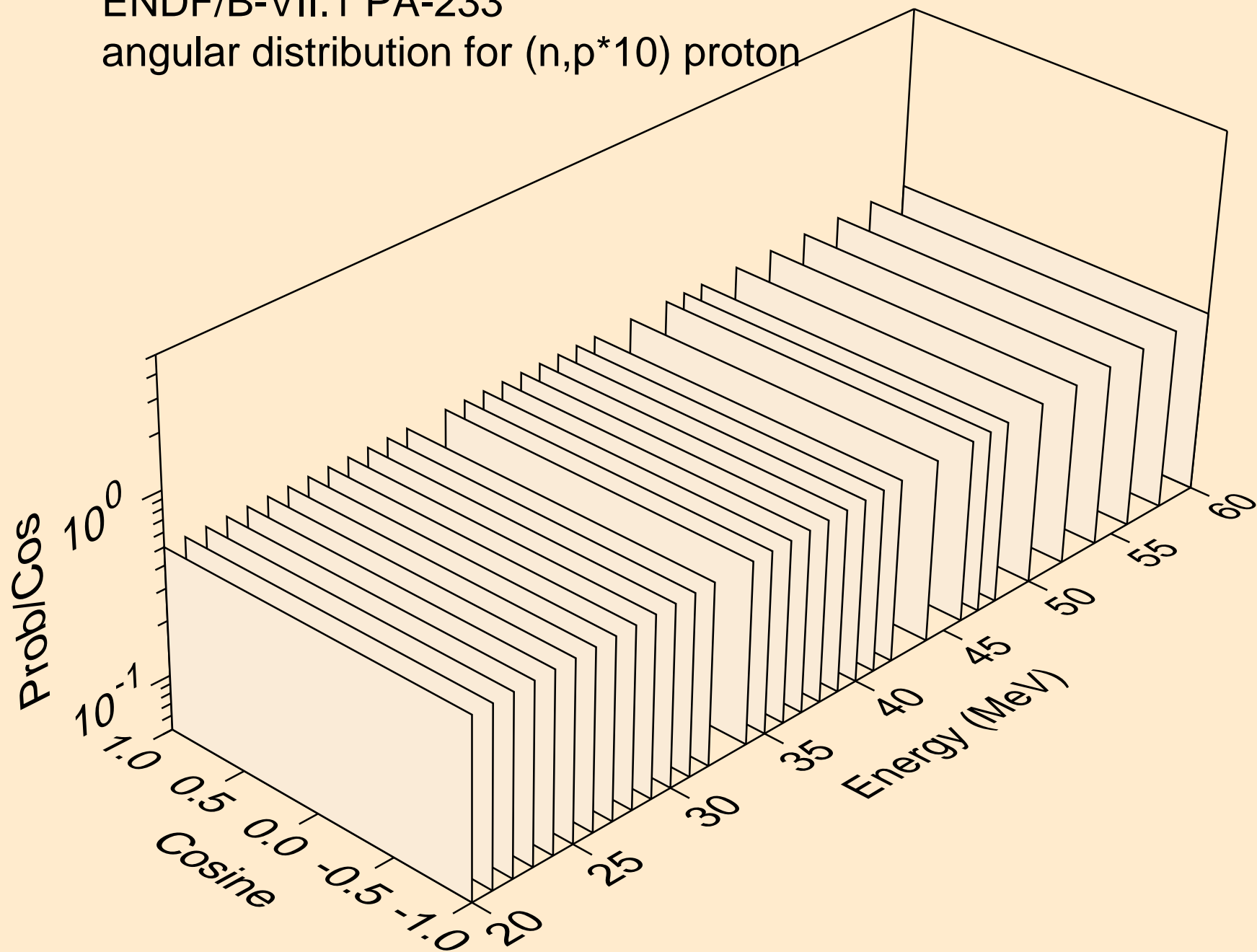

ENDF/B-VII.1 PA-233
angular distribution for (n,p*11) proton

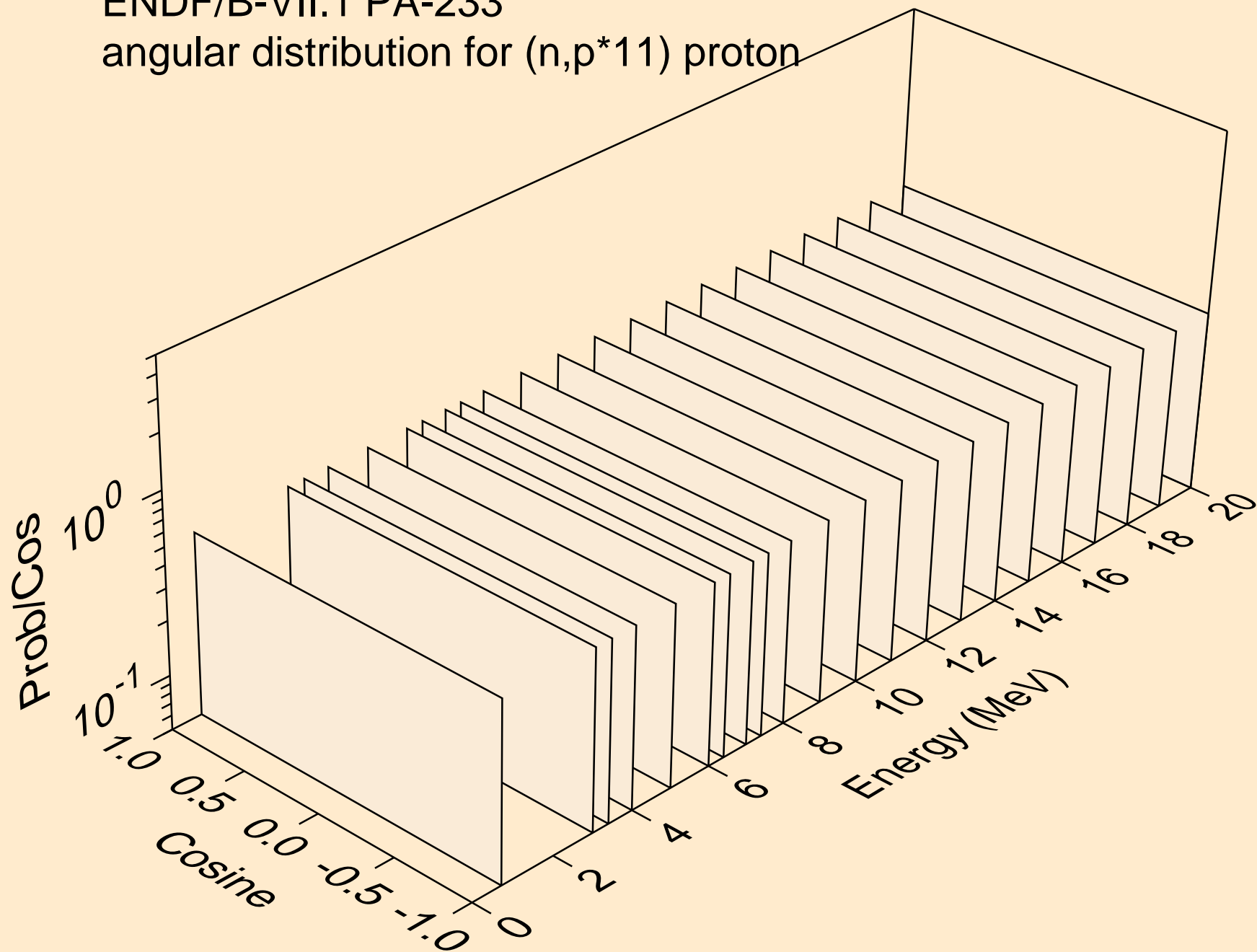

ENDF/B-VII.1 PA-233
angular distribution for (n,p*11) proton

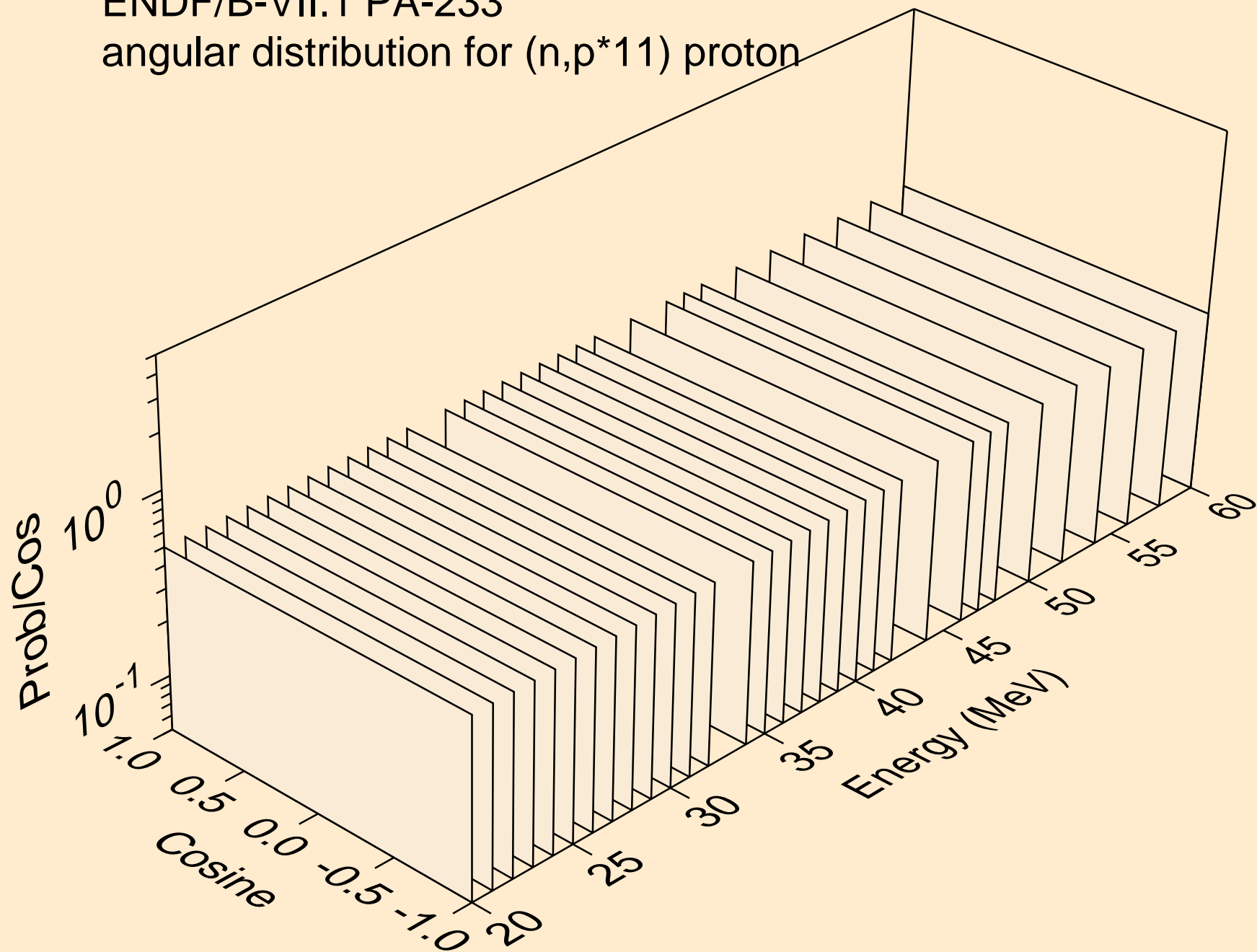

ENDF/B-VII.1 PA-233
angular distribution for (n,p*12) proton

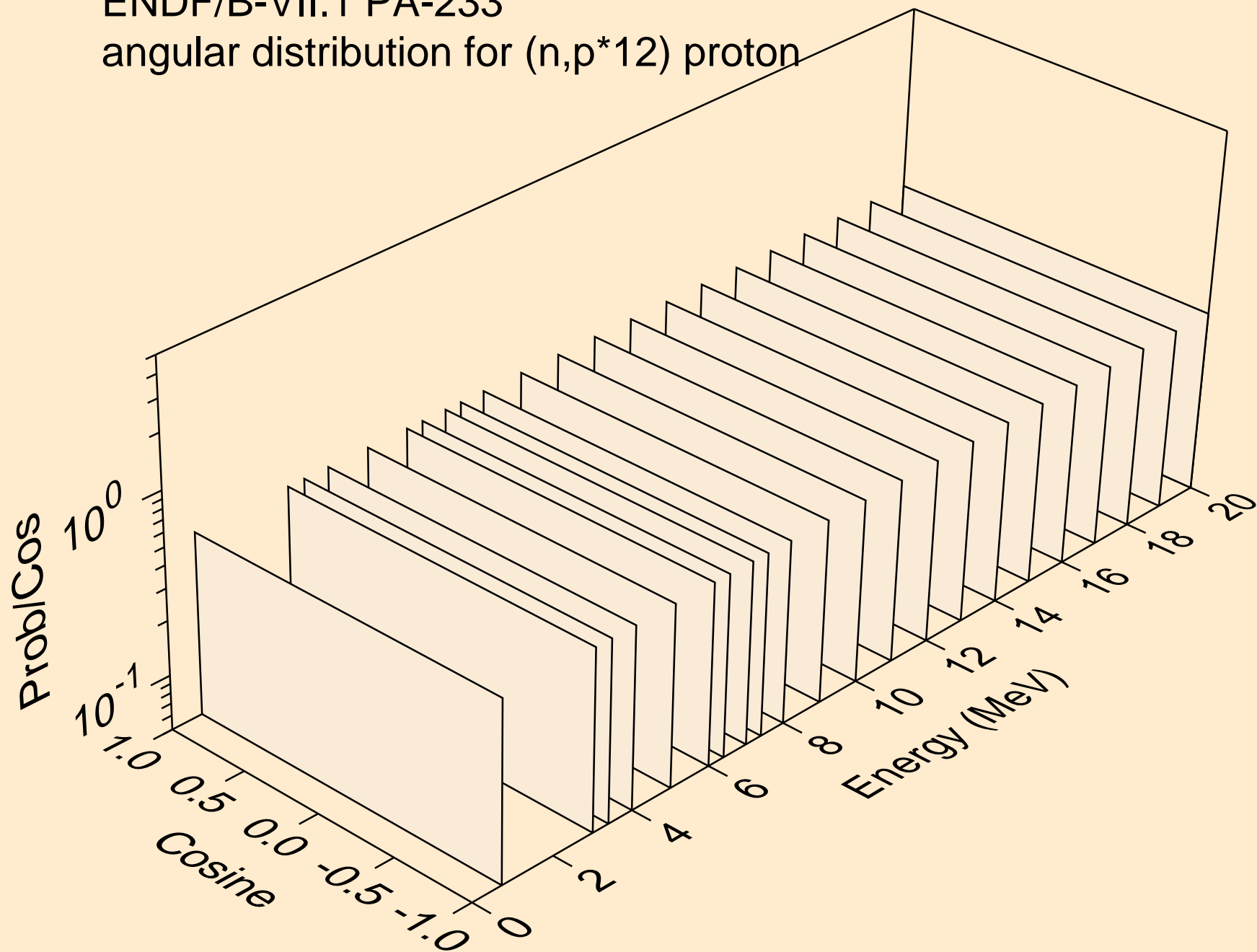

ENDF/B-VII.1 PA-233
angular distribution for (n,p*12) proton

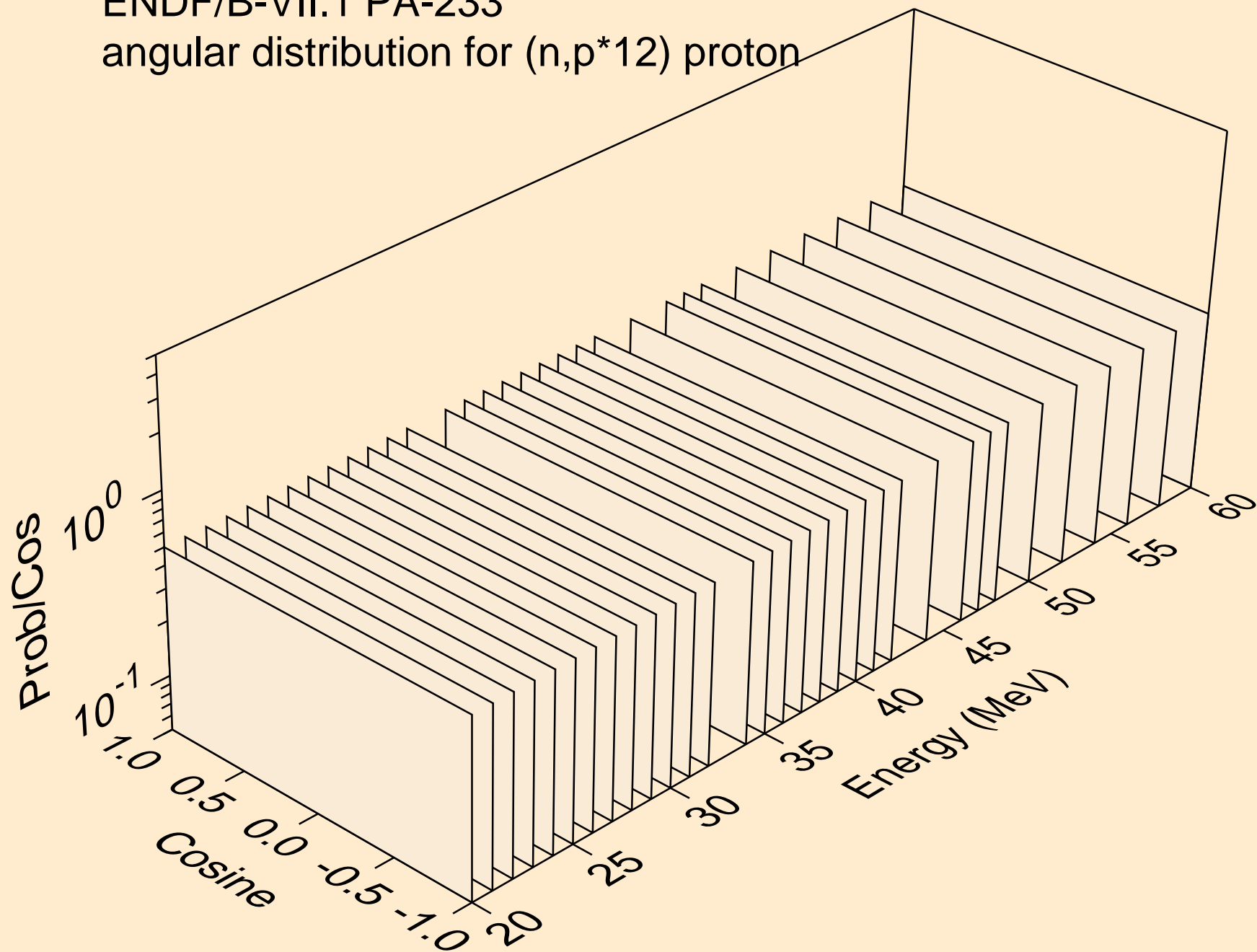

ENDF/B-VII.1 PA-233
angular distribution for (n,p*13) proton

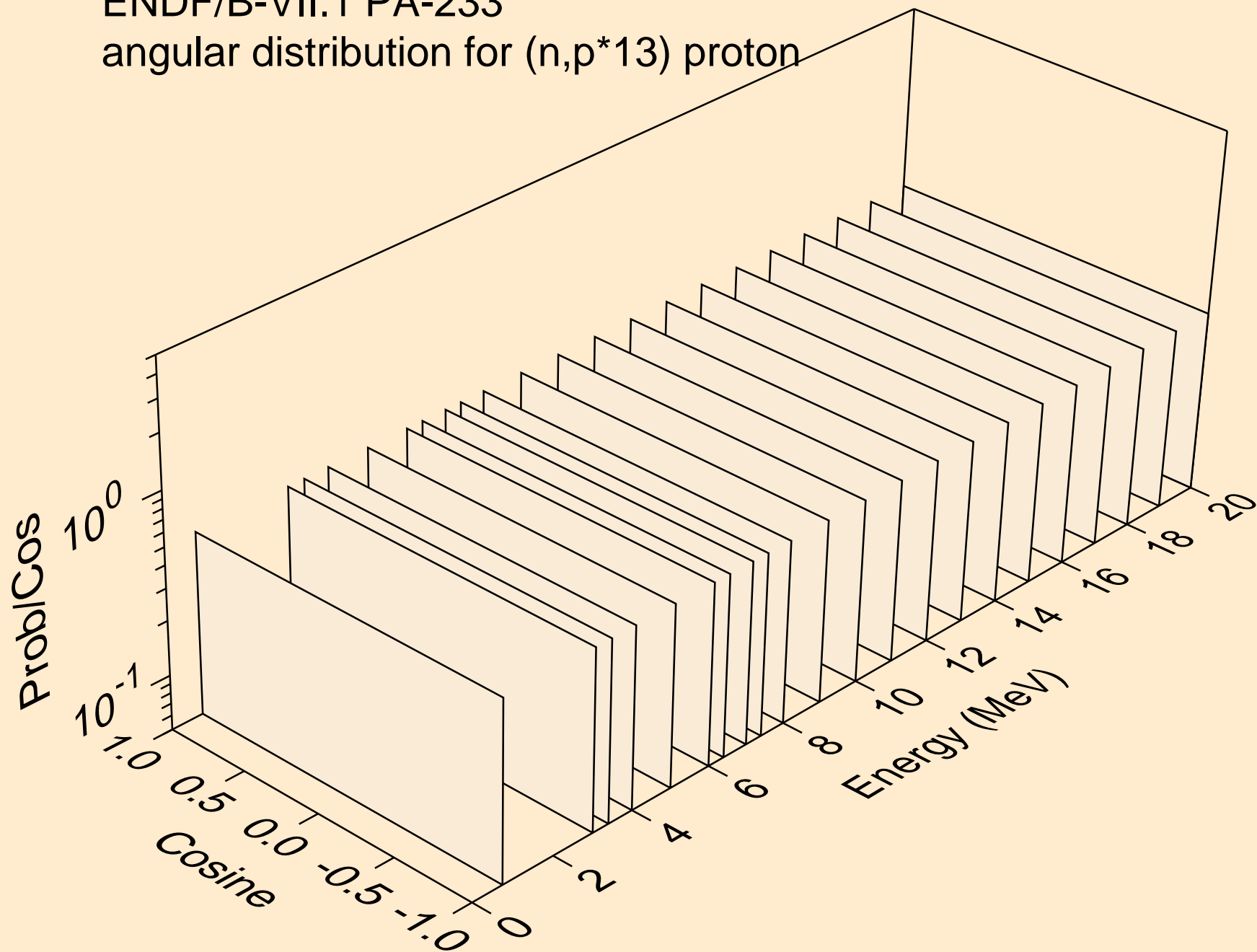

ENDF/B-VII.1 PA-233
angular distribution for (n,p*13) proton

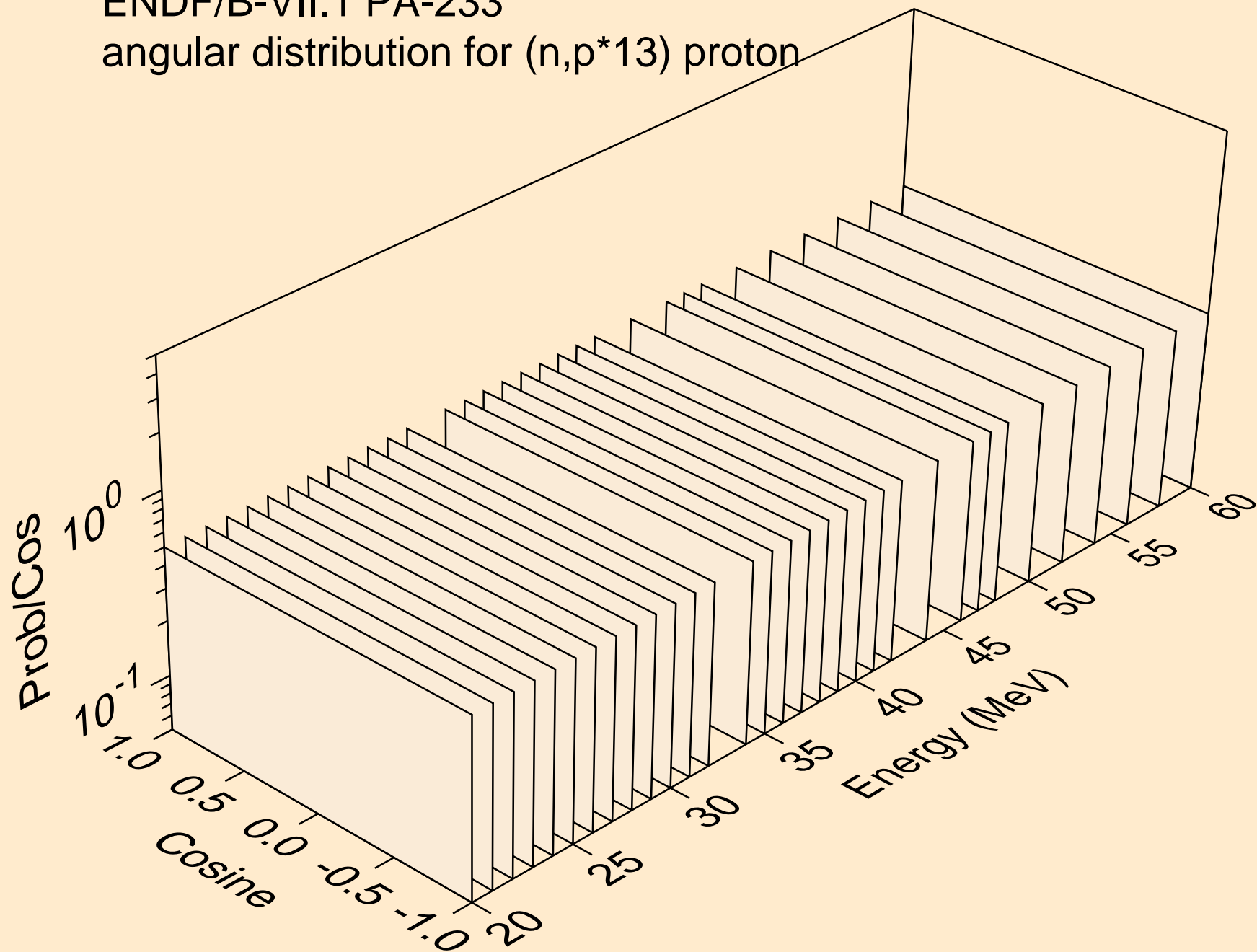

ENDF/B-VII.1 PA-233
angular distribution for (n,p*14) proton

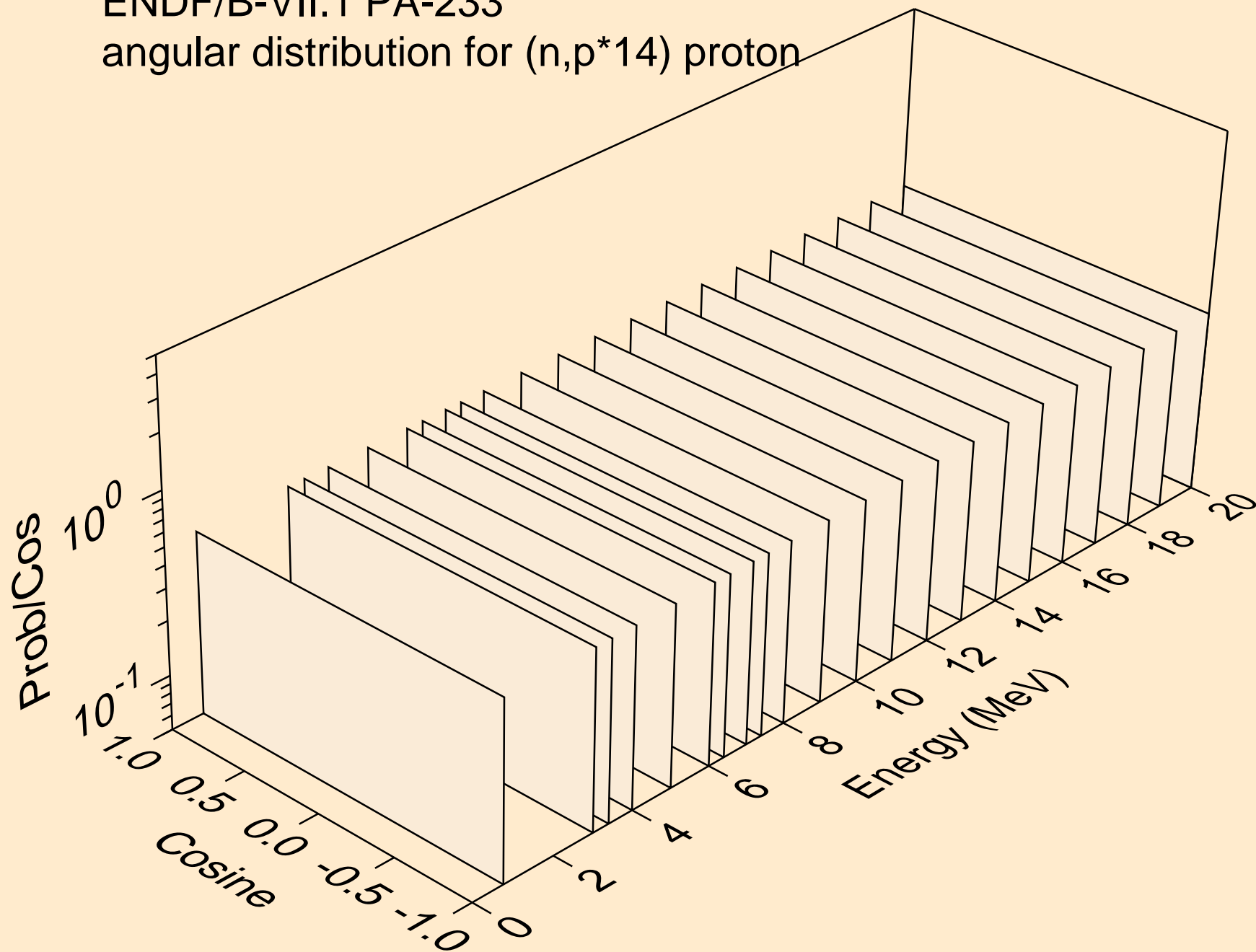

ENDF/B-VII.1 PA-233

angular distribution for (n,p*14) proton

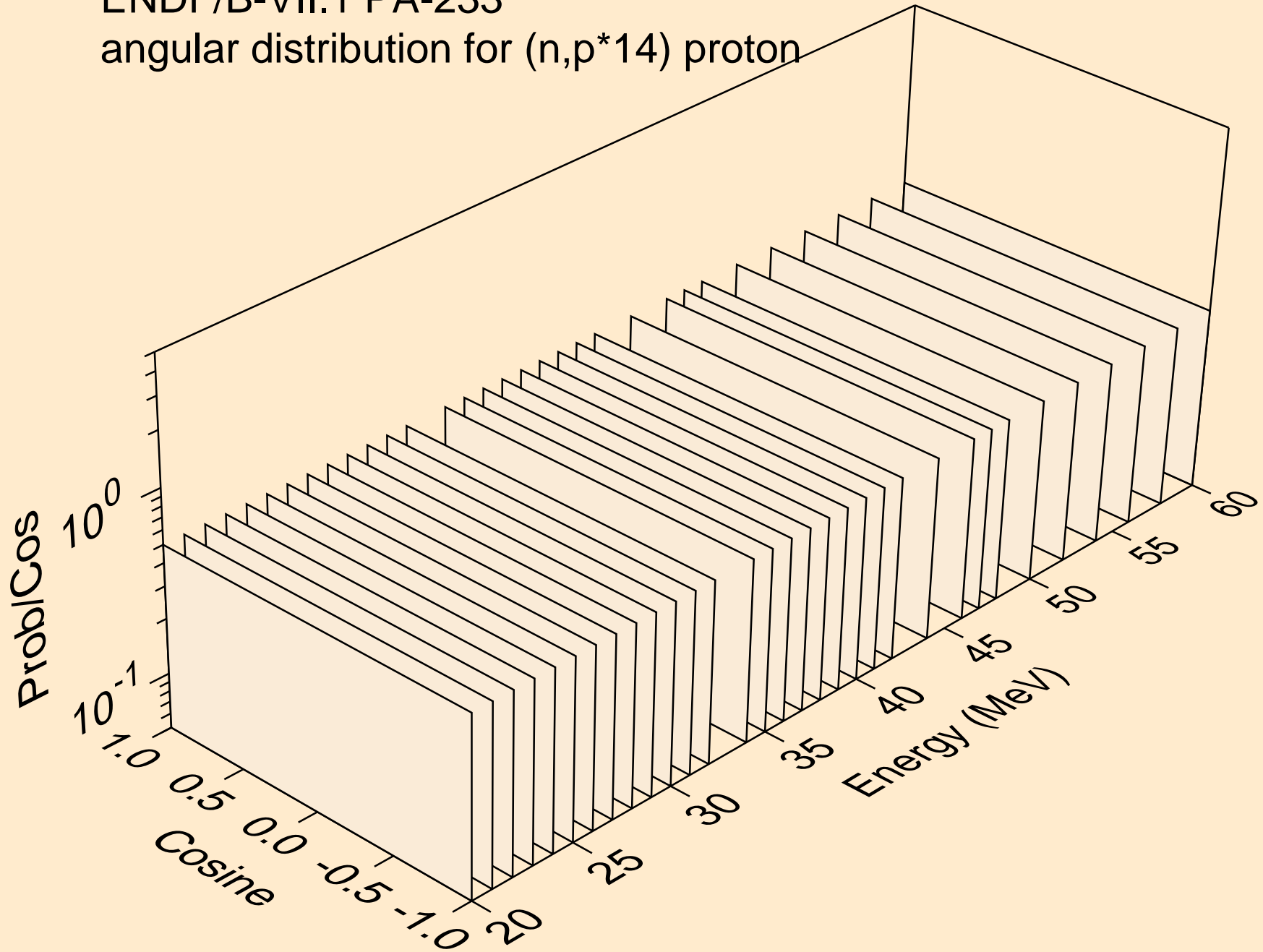

ENDF/B-VII.1 PA-233
angular distribution for (n,p*15) proton

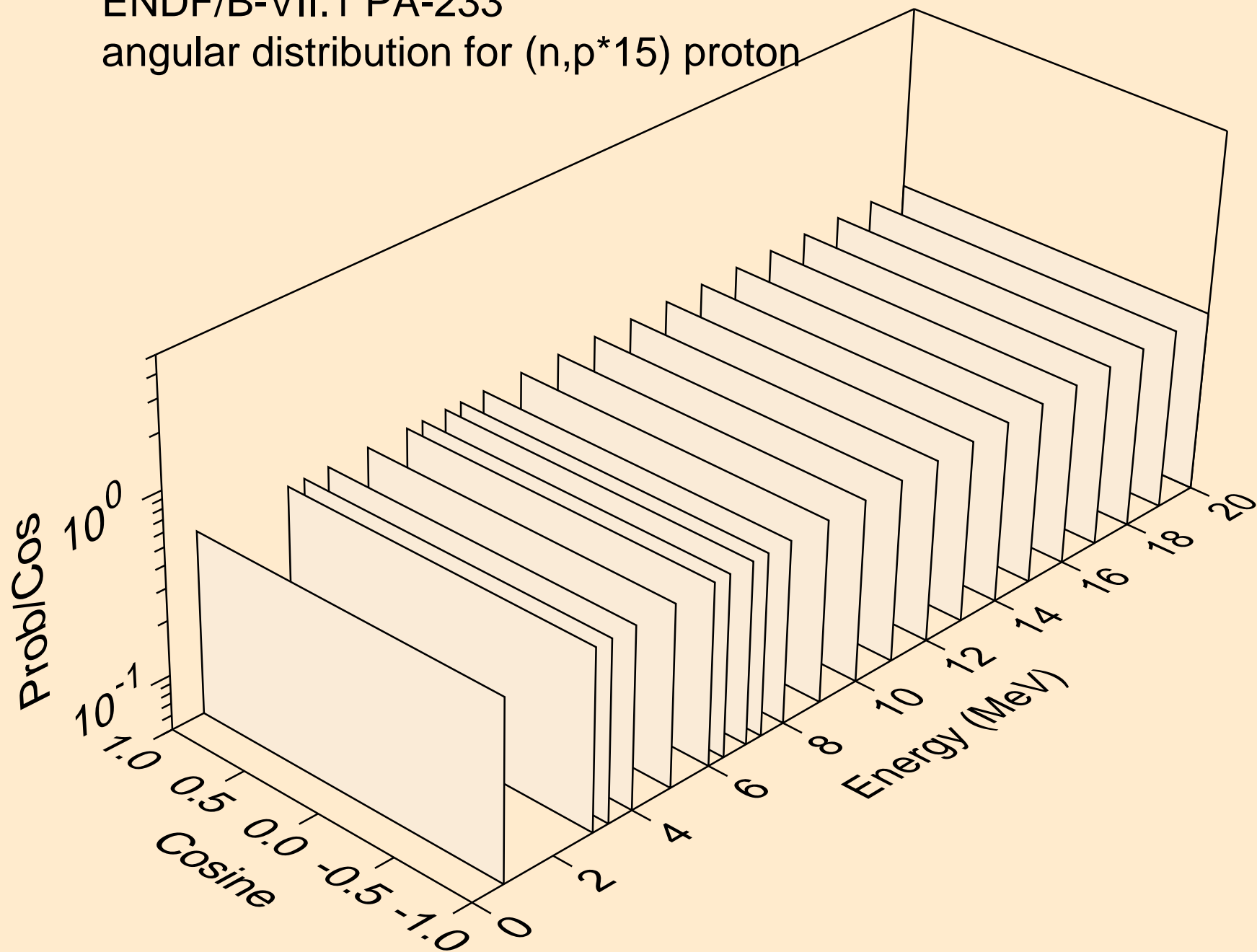

ENDF/B-VII.1 PA-233
angular distribution for (n,p*15) proton

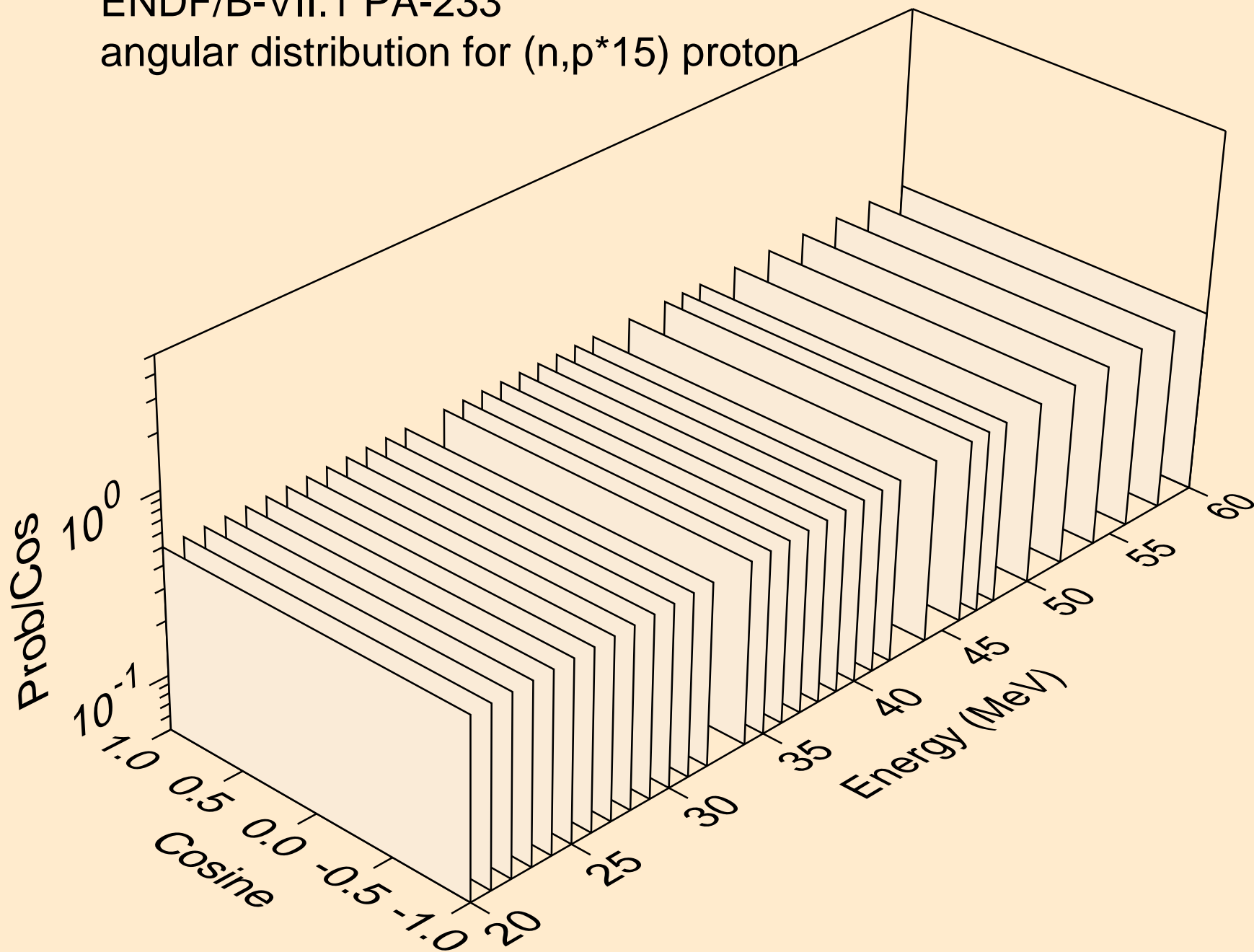

ENDF/B-VII.1 PA-233

angular distribution for (n,p*16) proton

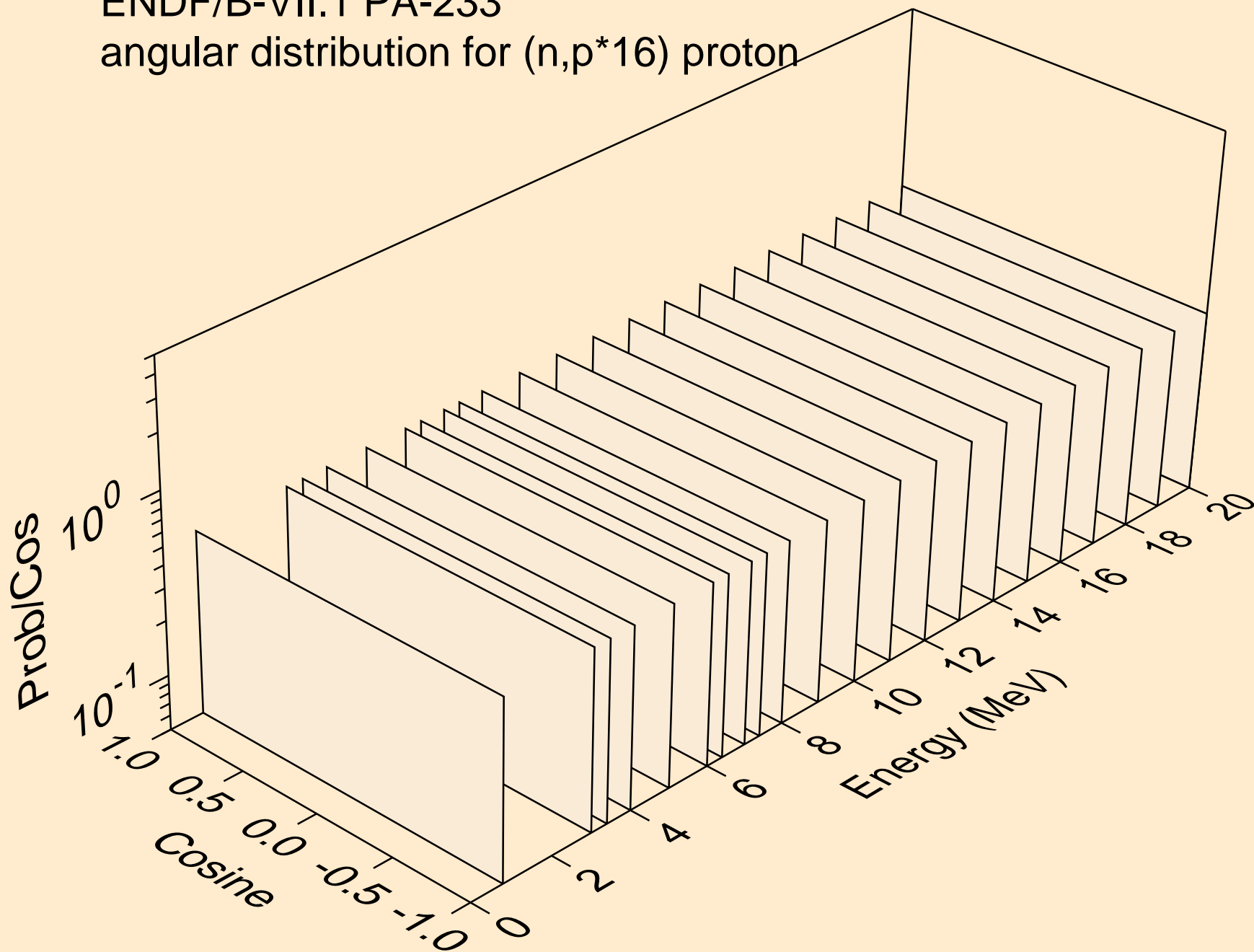

ENDF/B-VII.1 PA-233

angular distribution for (n,p*16) proton

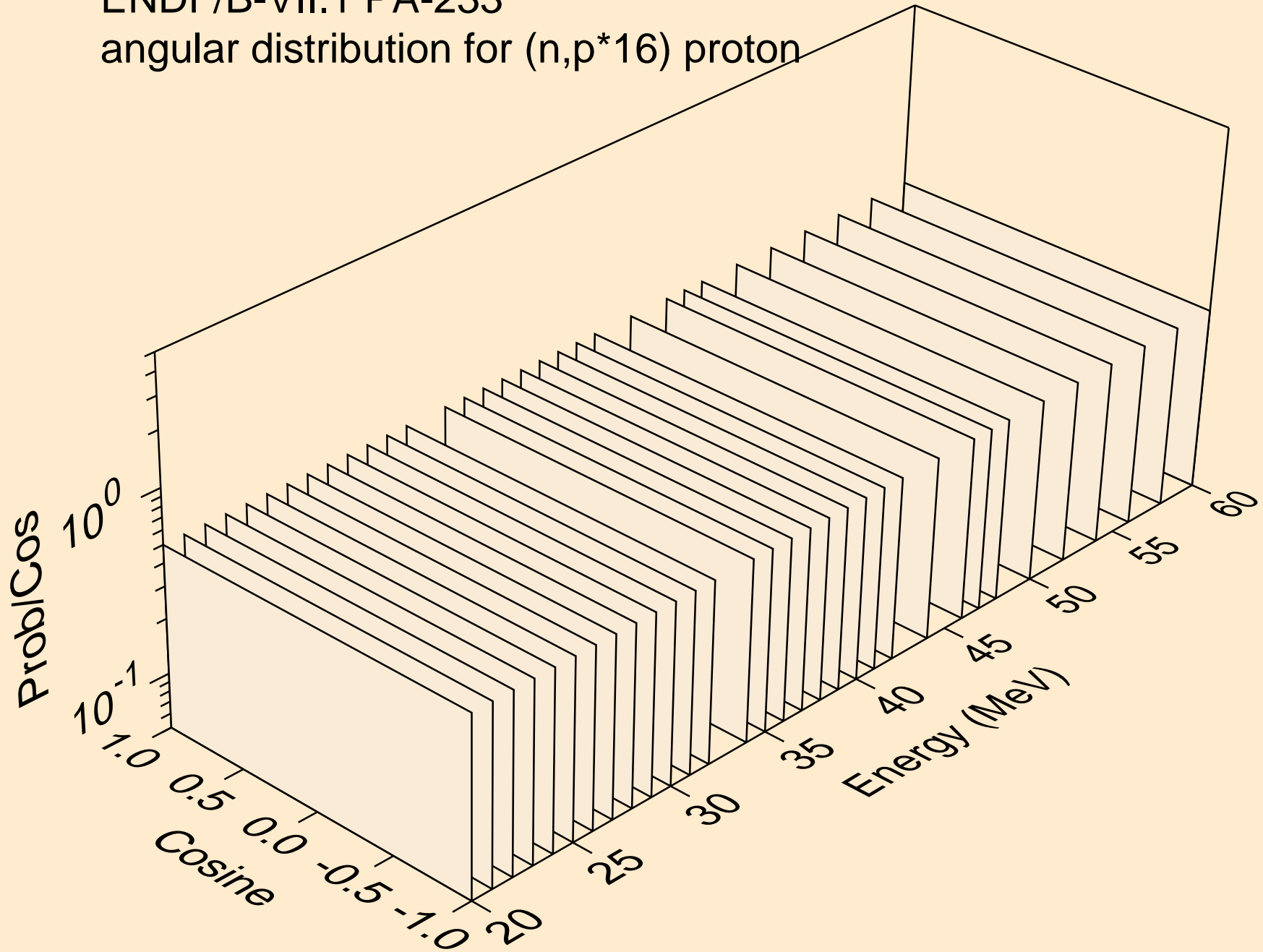

ENDF/B-VII.1 PA-233
angular distribution for (n,p*17) proton

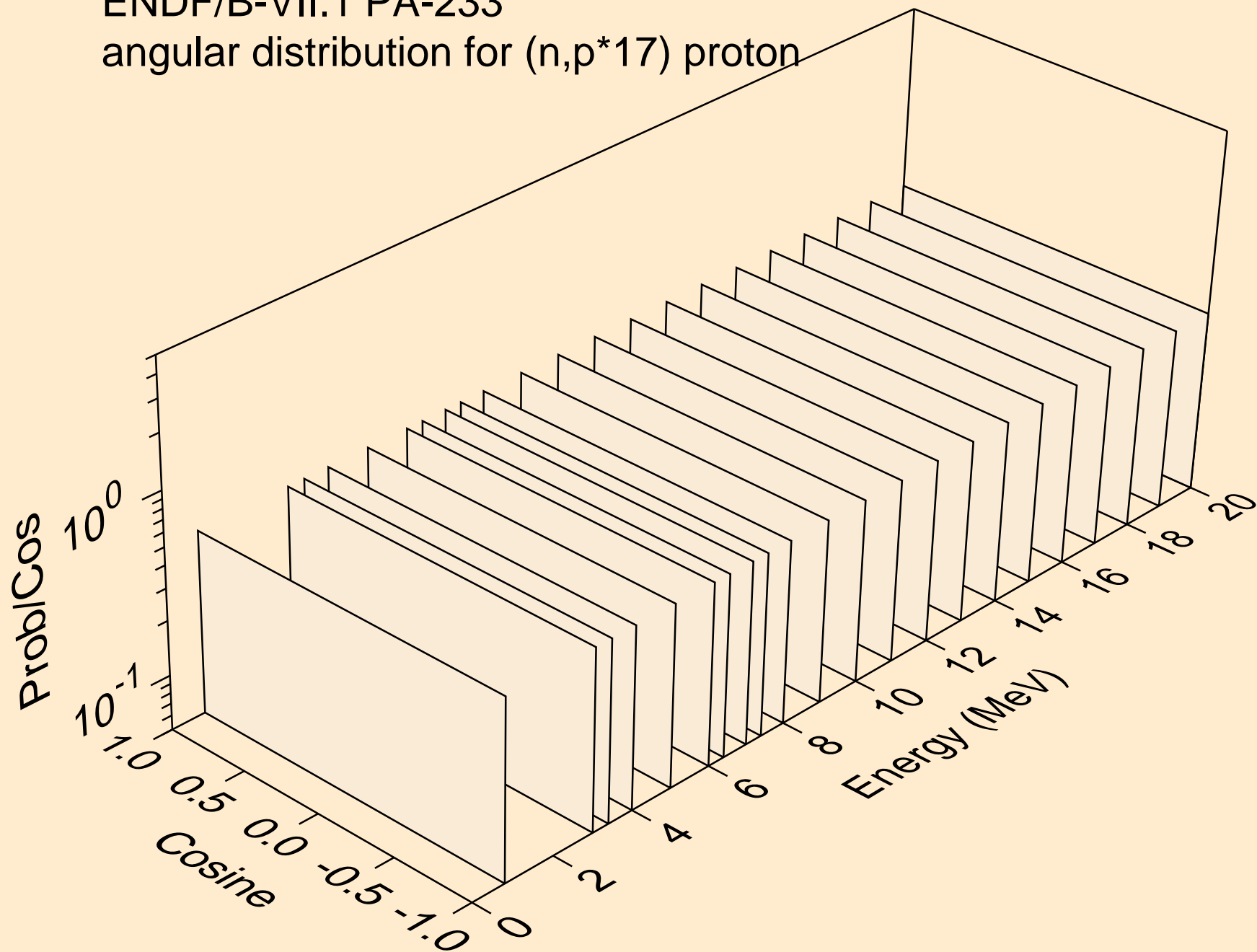

ENDF/B-VII.1 PA-233

angular distribution for (n,p*17) proton

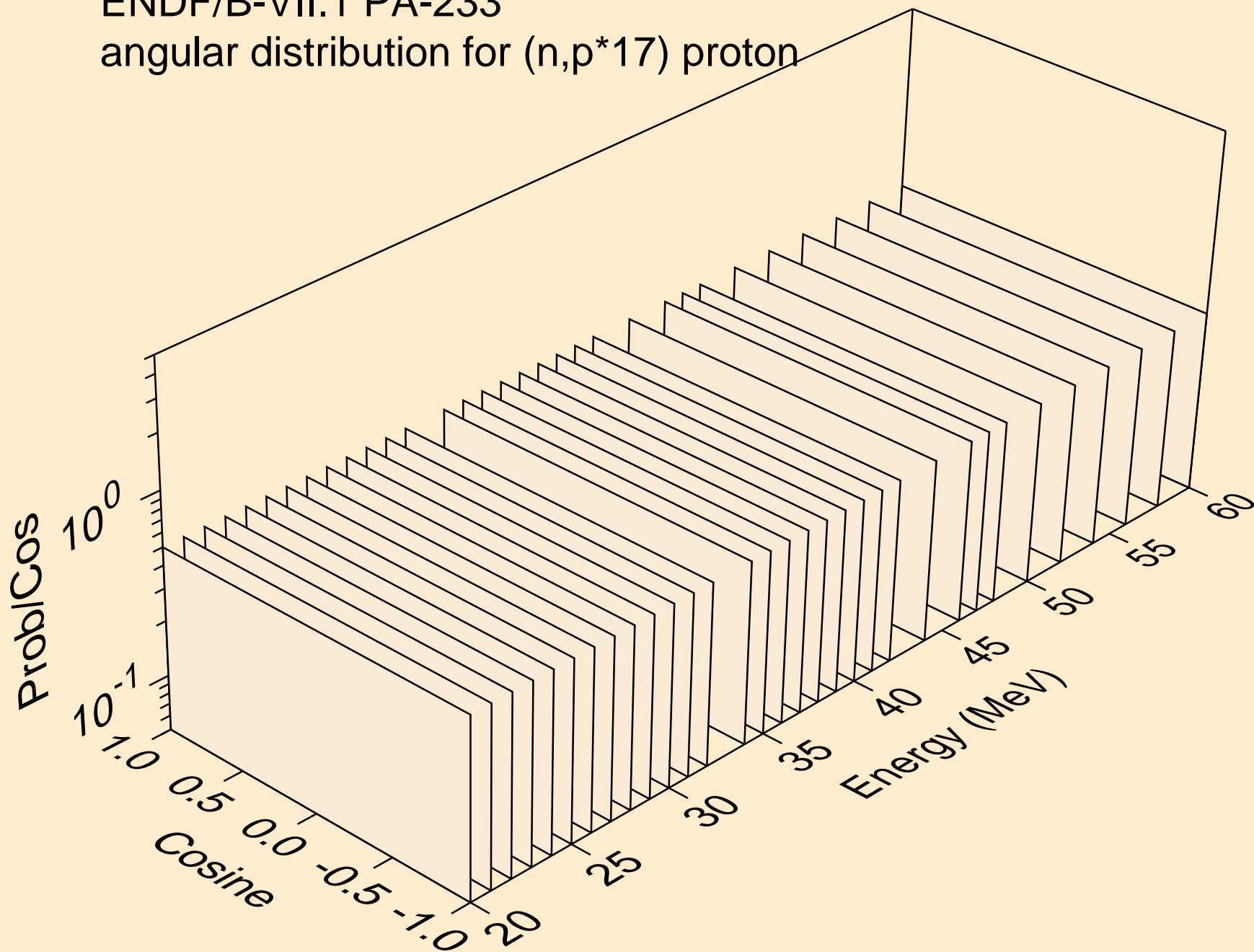

ENDF/B-VII.1 PA-233
angular distribution for (n,p*18) proton

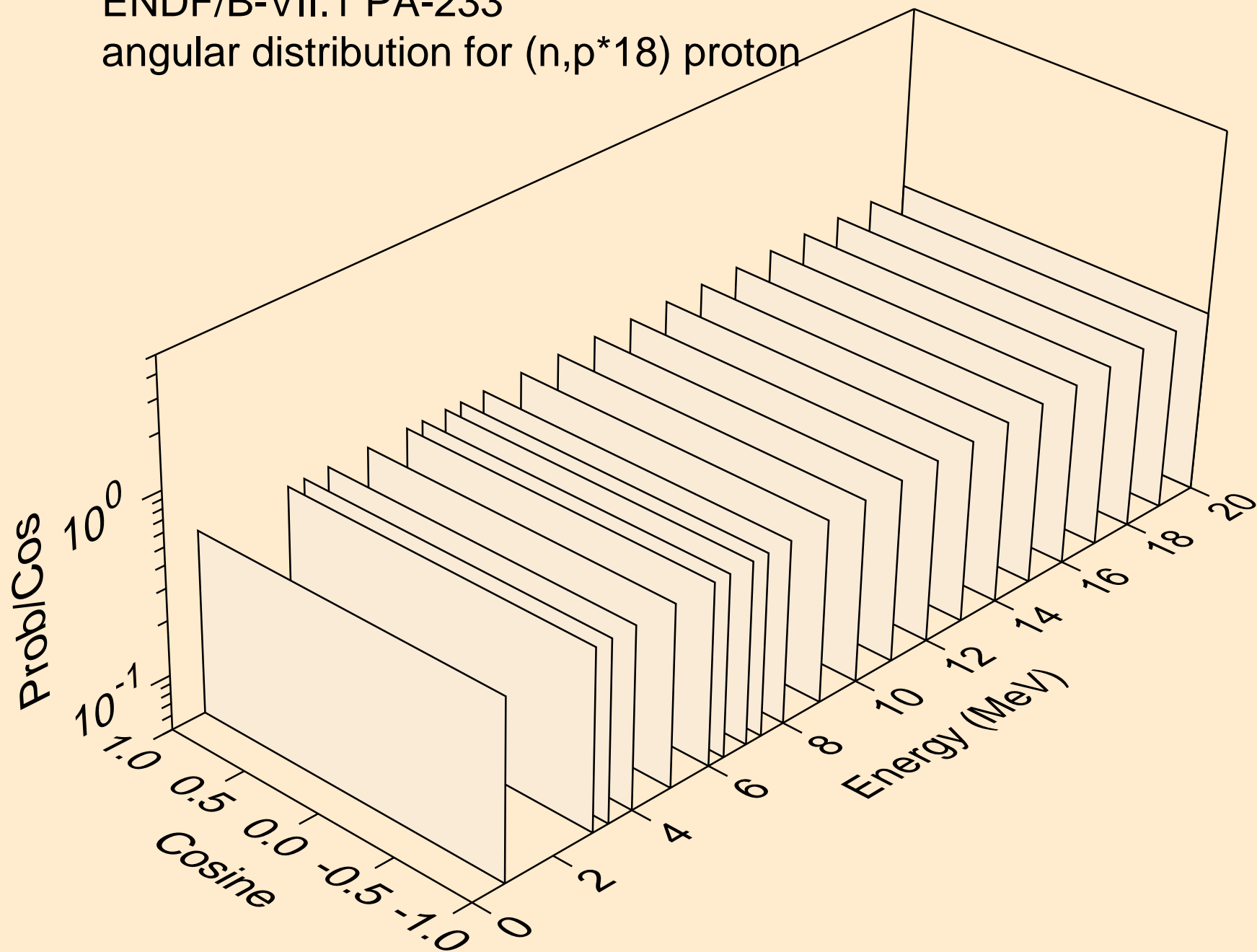

ENDF/B-VII.1 PA-233
angular distribution for (n,p*18) proton

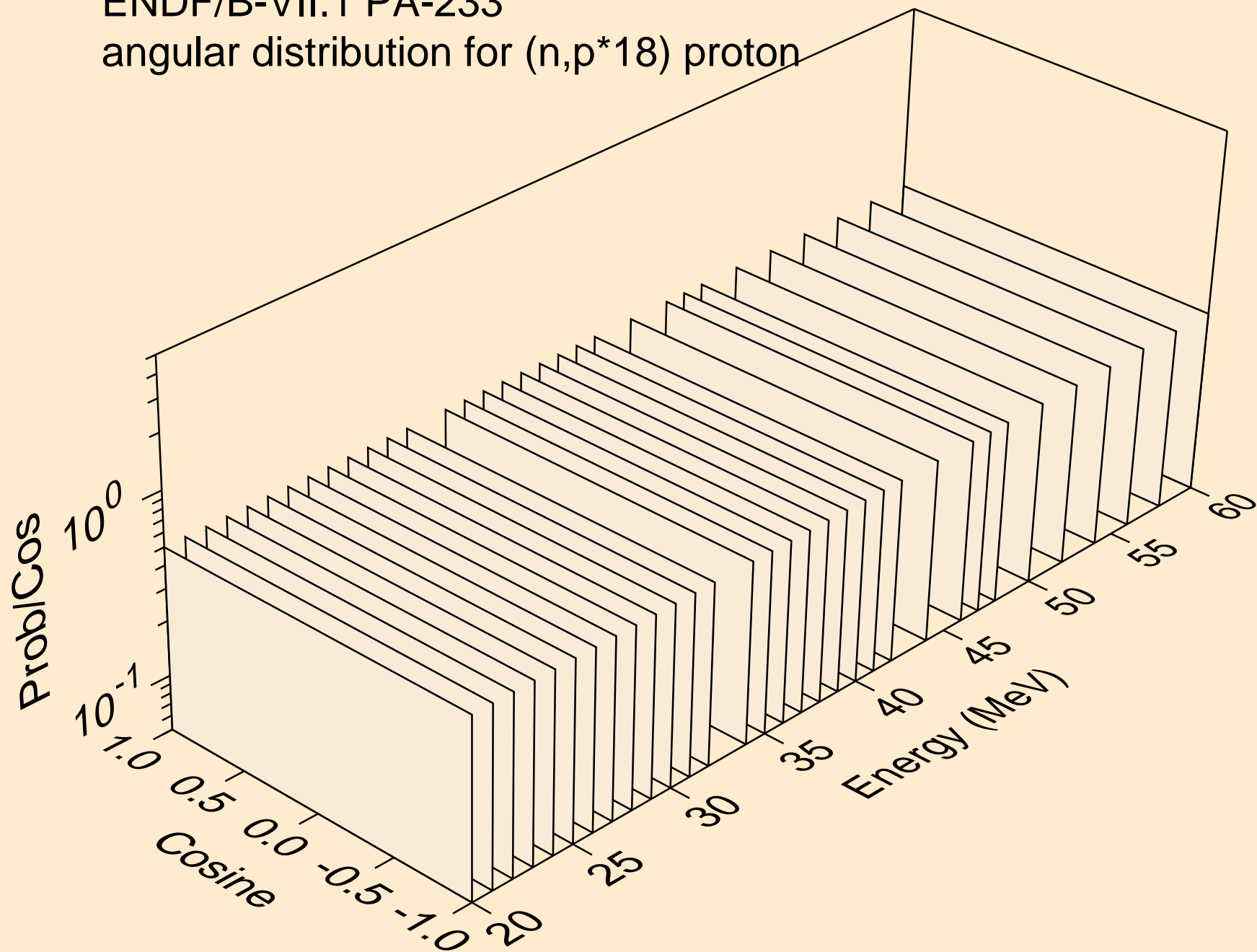

ENDF/B-VII.1 PA-233
angular distribution for (n,p*19) proton

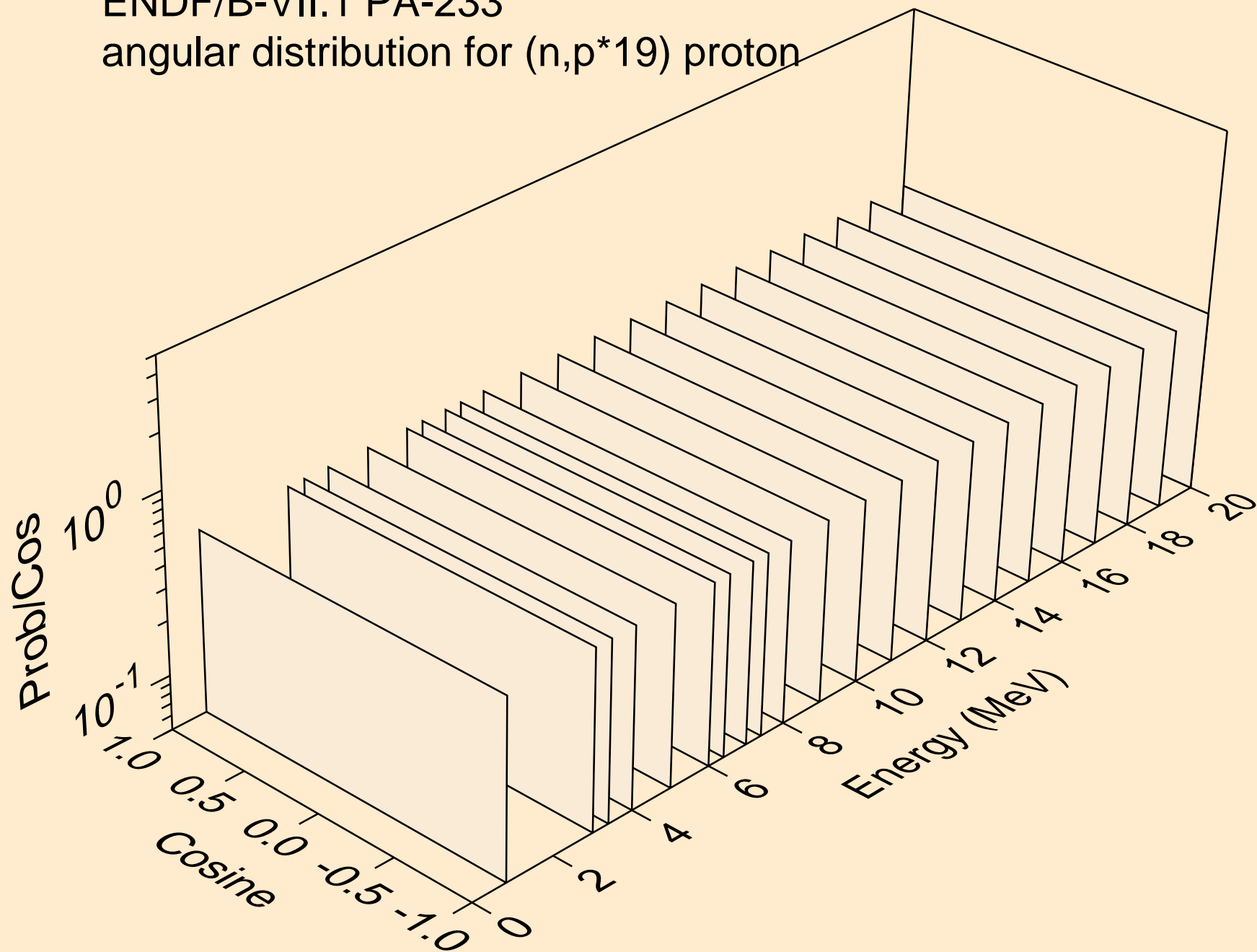

ENDF/B-VII.1 PA-233
angular distribution for (n,p*19) proton

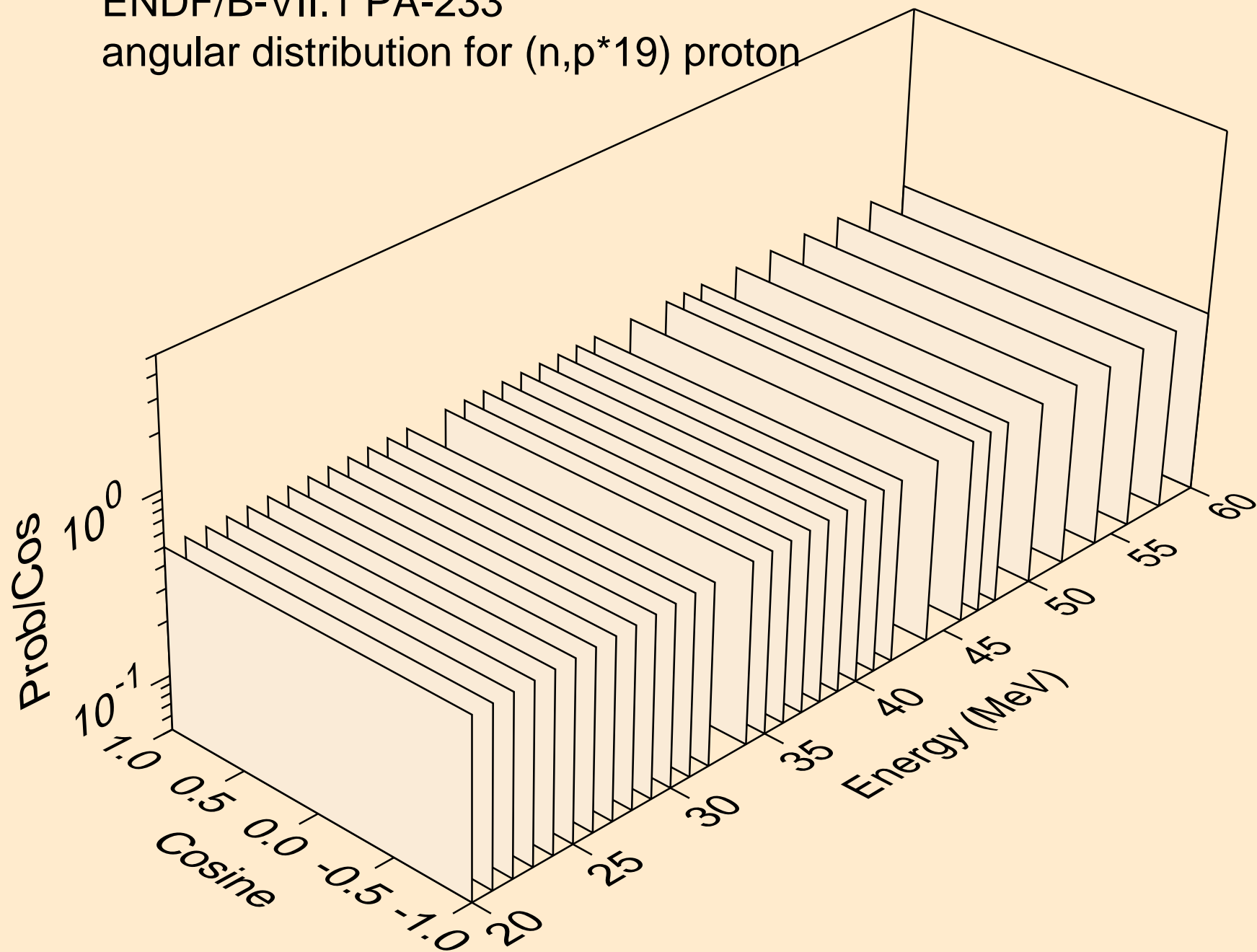

ENDF/B-VII.1 PA-233
angular distribution for (n,p*20) proton

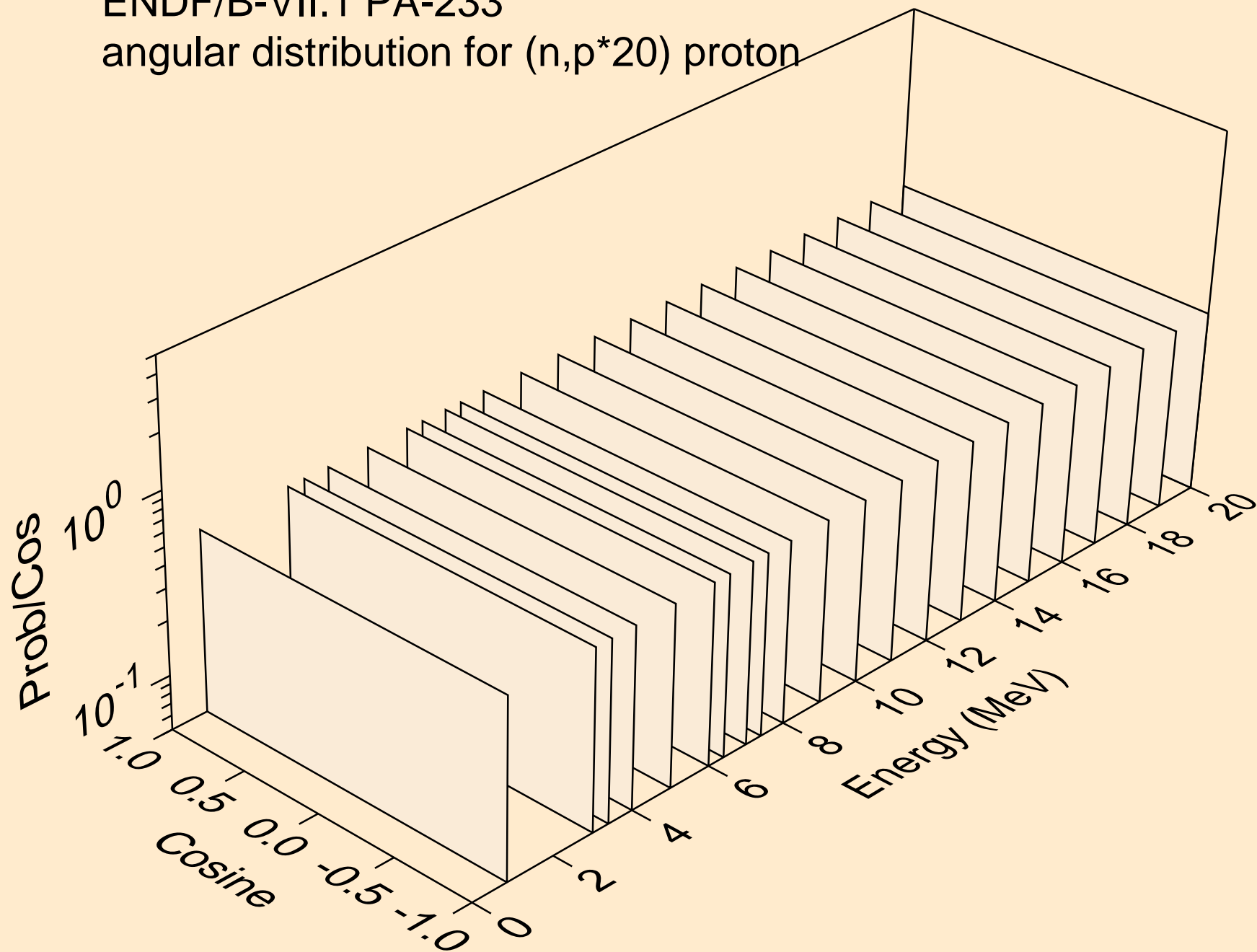

ENDF/B-VII.1 PA-233
angular distribution for (n,p*20) proton

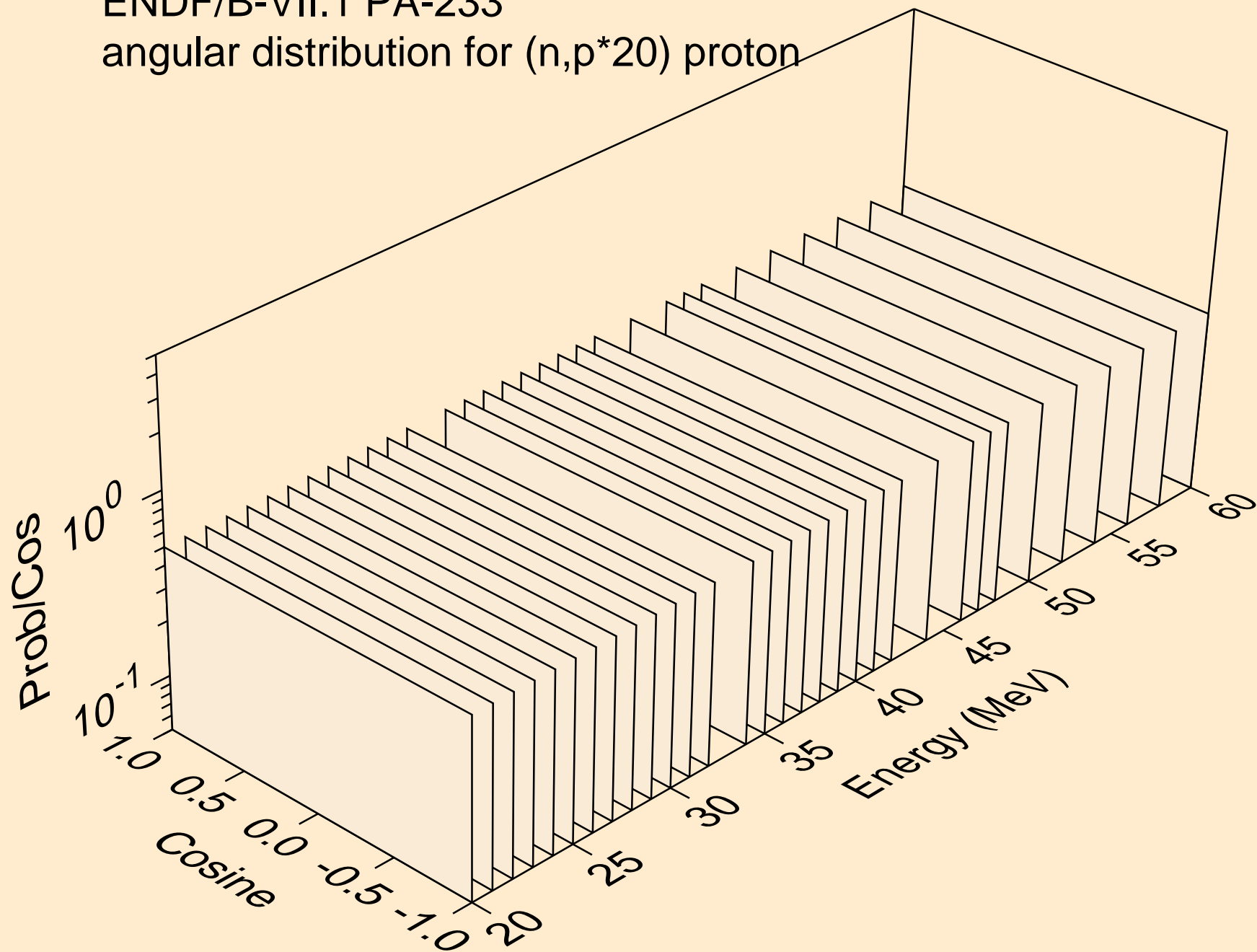

ENDF/B-VII.1 PA-233
angular distribution for (n,p*21) proton

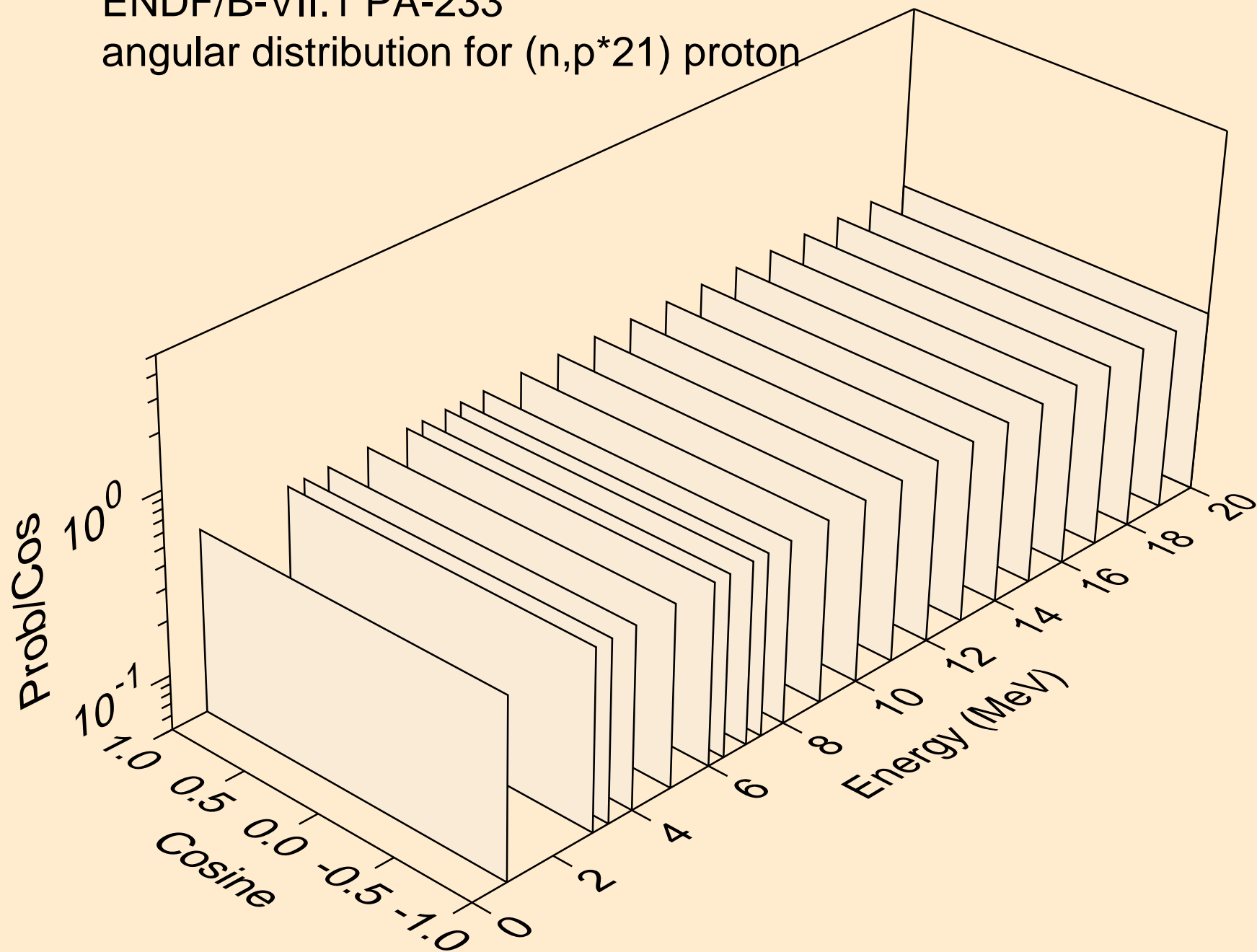

ENDF/B-VII.1 PA-233
angular distribution for (n,p*21) proton

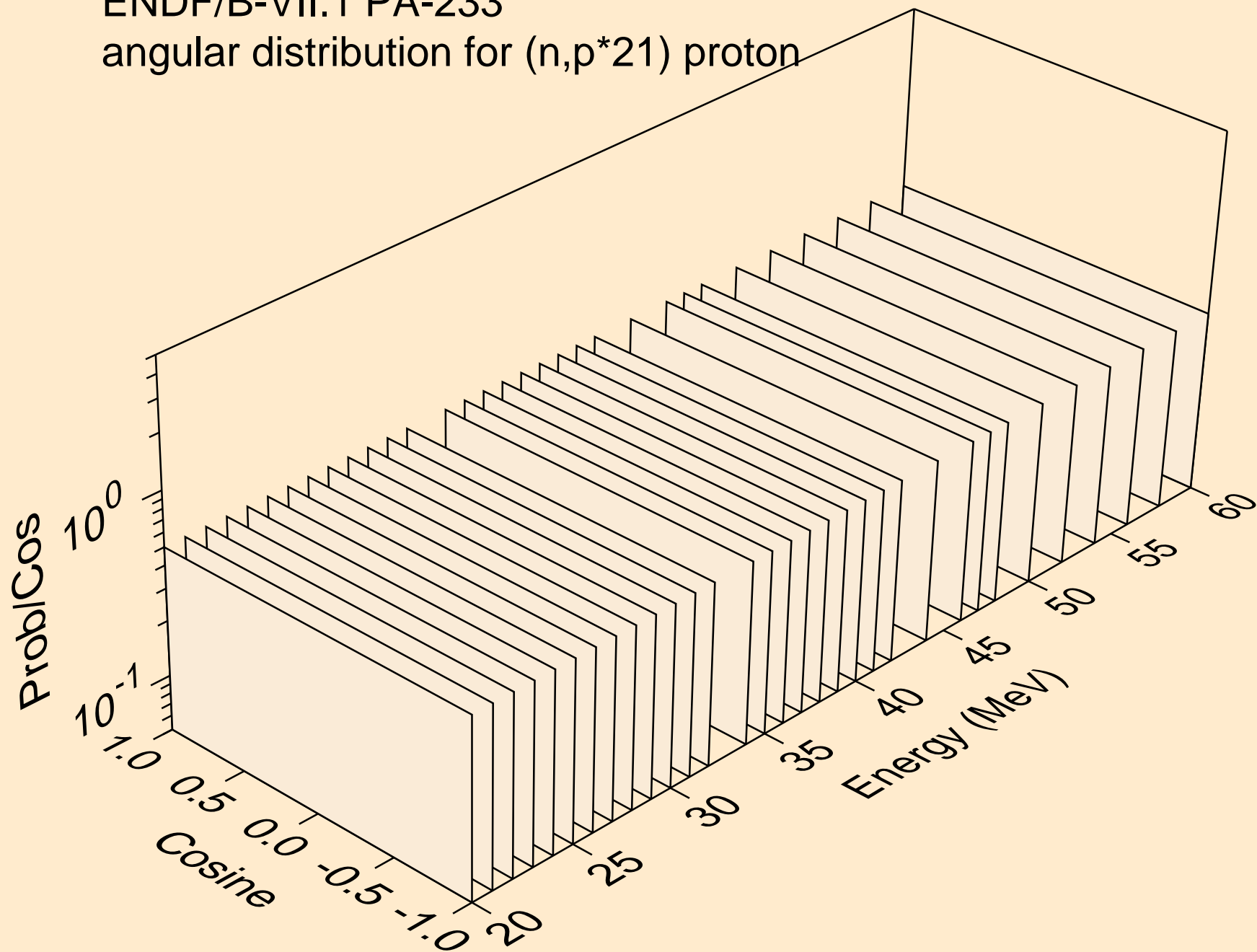

ENDF/B-VII.1 PA-233
angular distribution for (n,p*22) proton

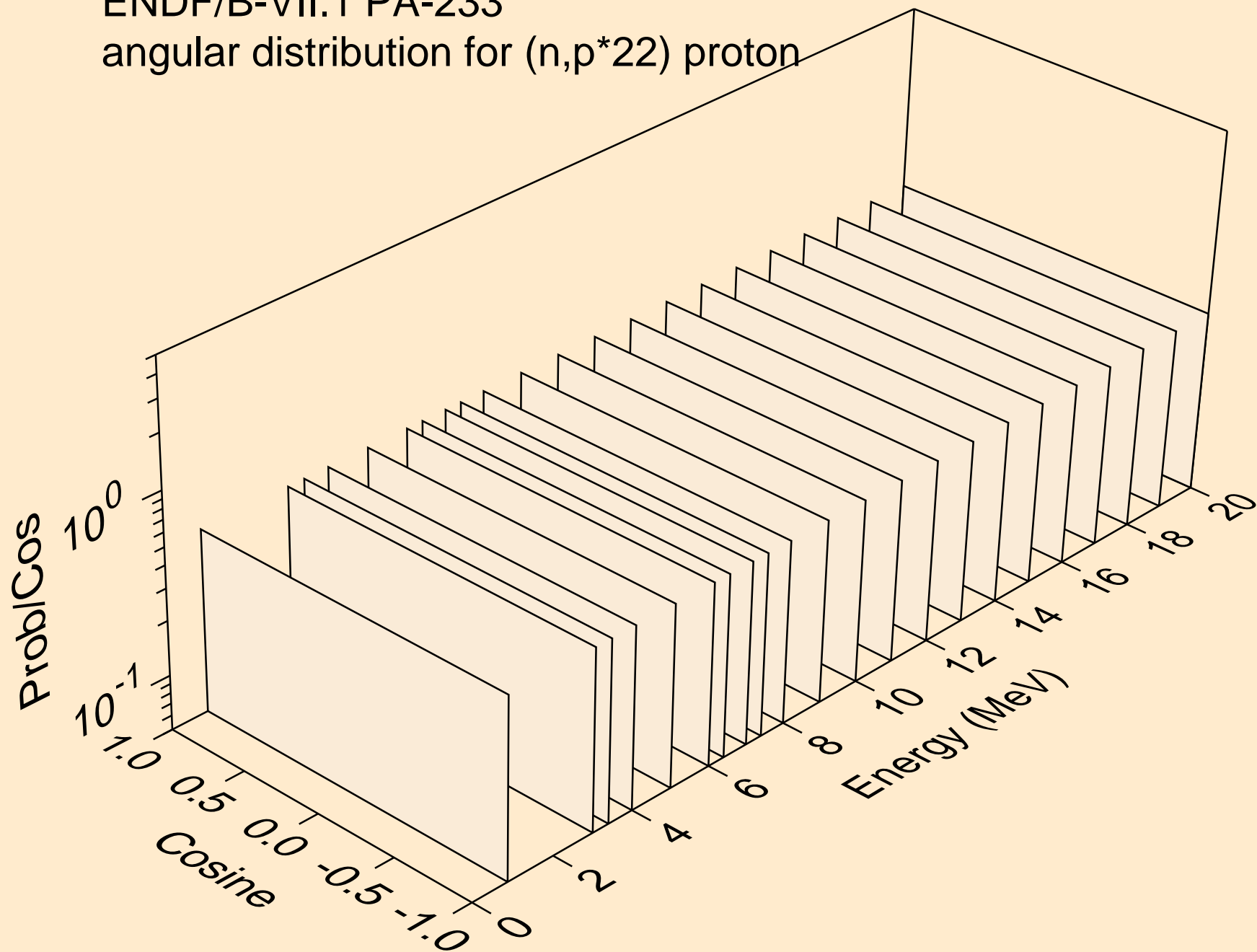

ENDF/B-VII.1 PA-233

angular distribution for (n,p*22) proton

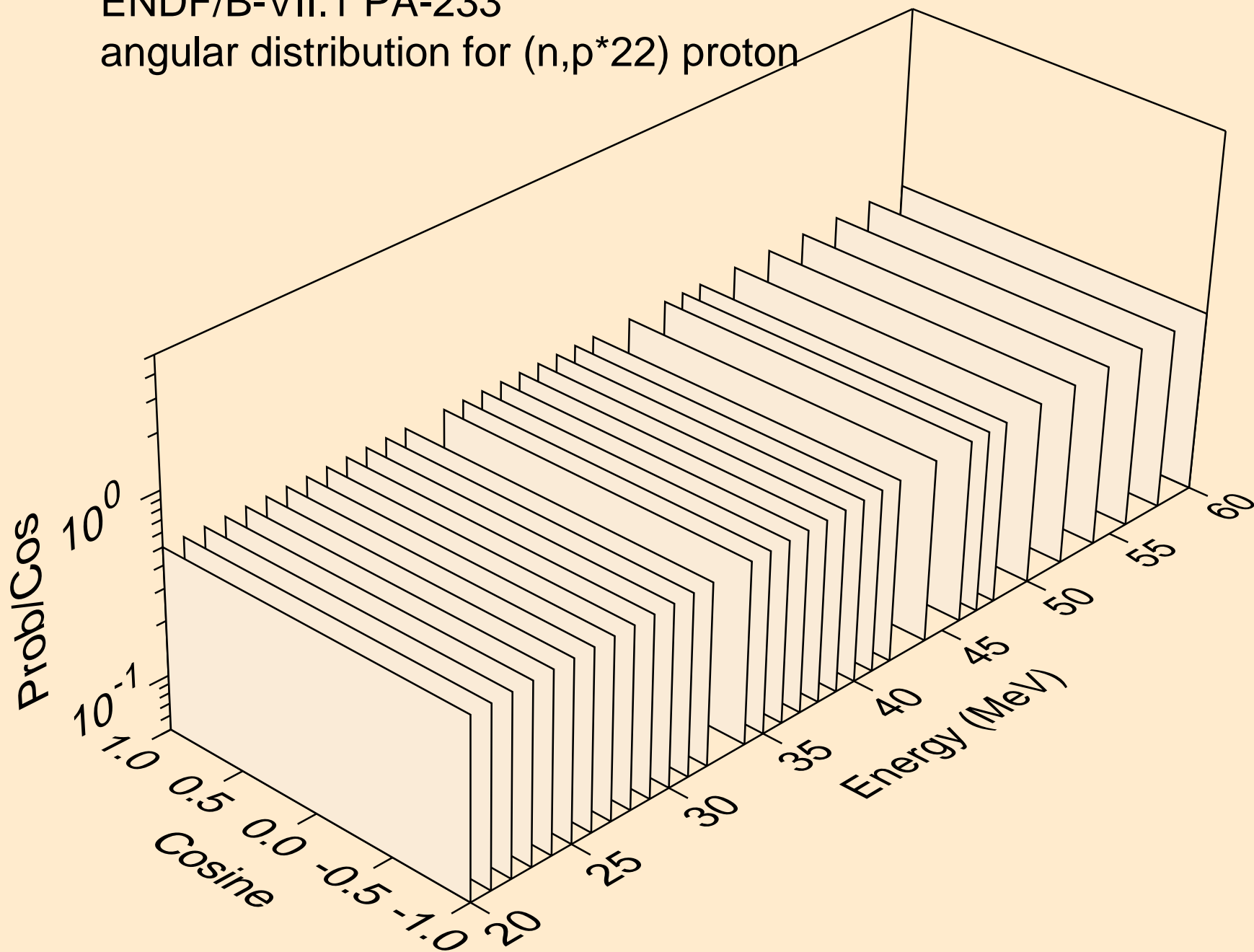

ENDF/B-VII.1 PA-233
angular distribution for (n,p*23) proton

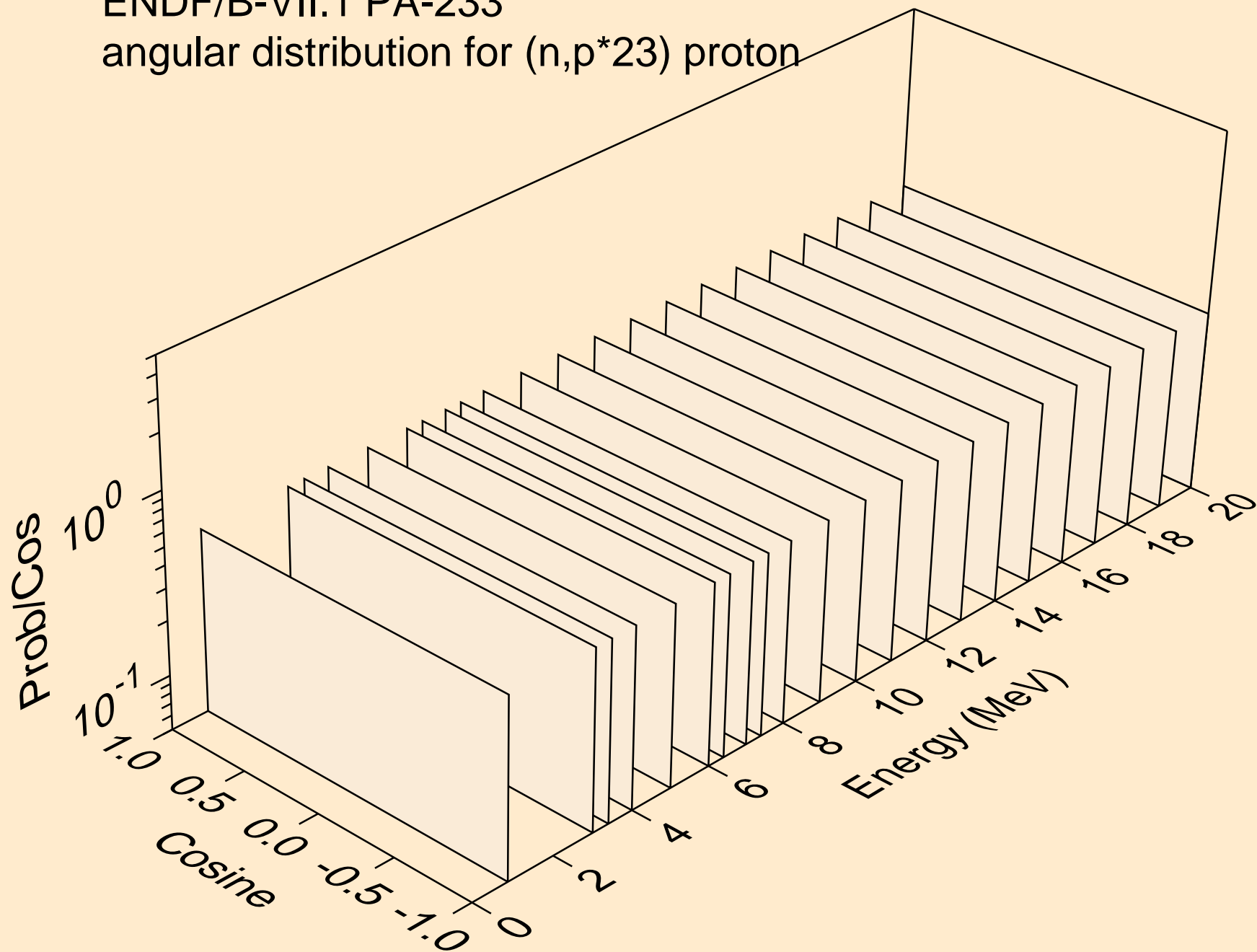

ENDF/B-VII.1 PA-233

angular distribution for (n,p*23) proton

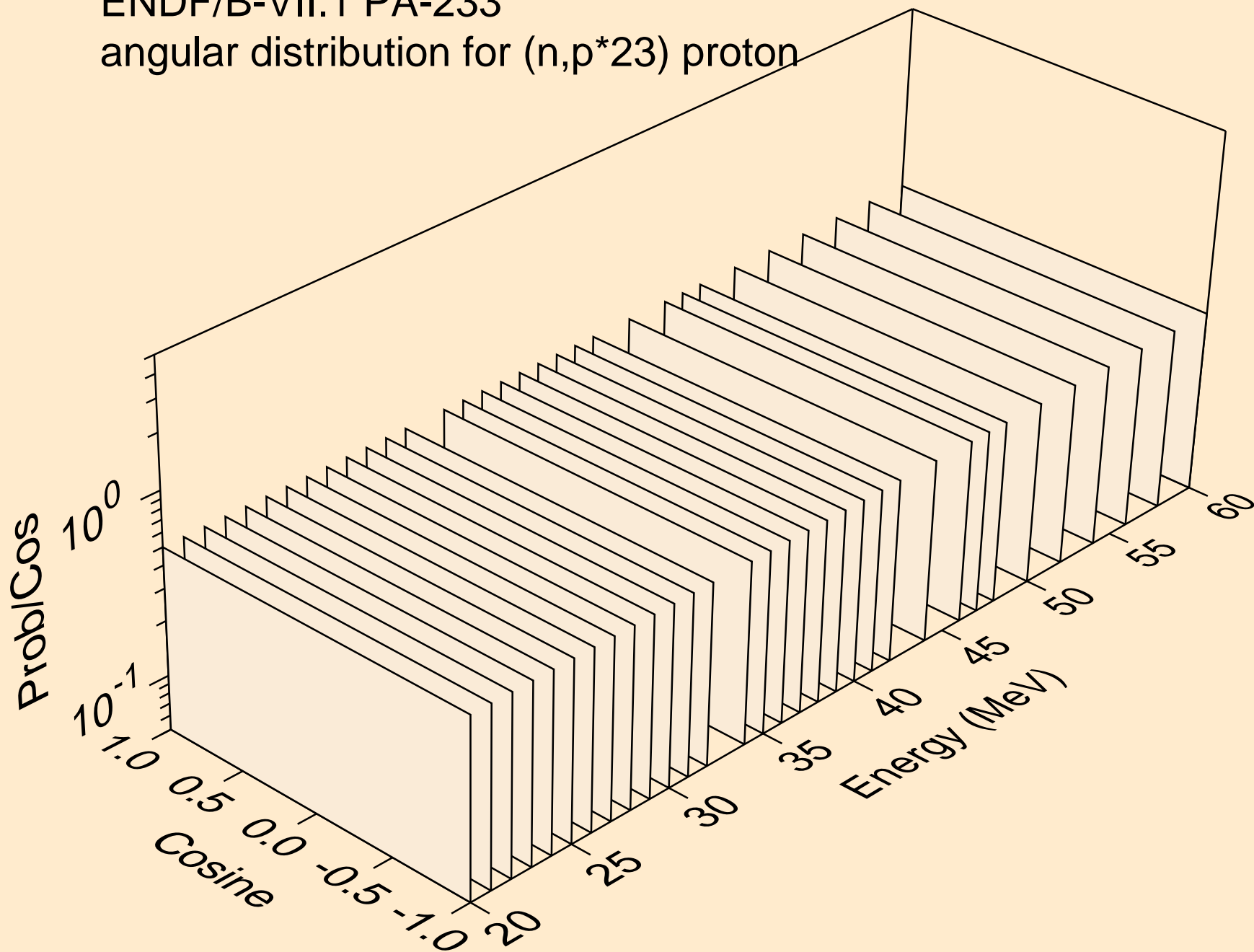

ENDF/B-VII.1 PA-233
protons from (n,p*c)

