

ENDF/B-VII.1 PA-231

Principal cross sections

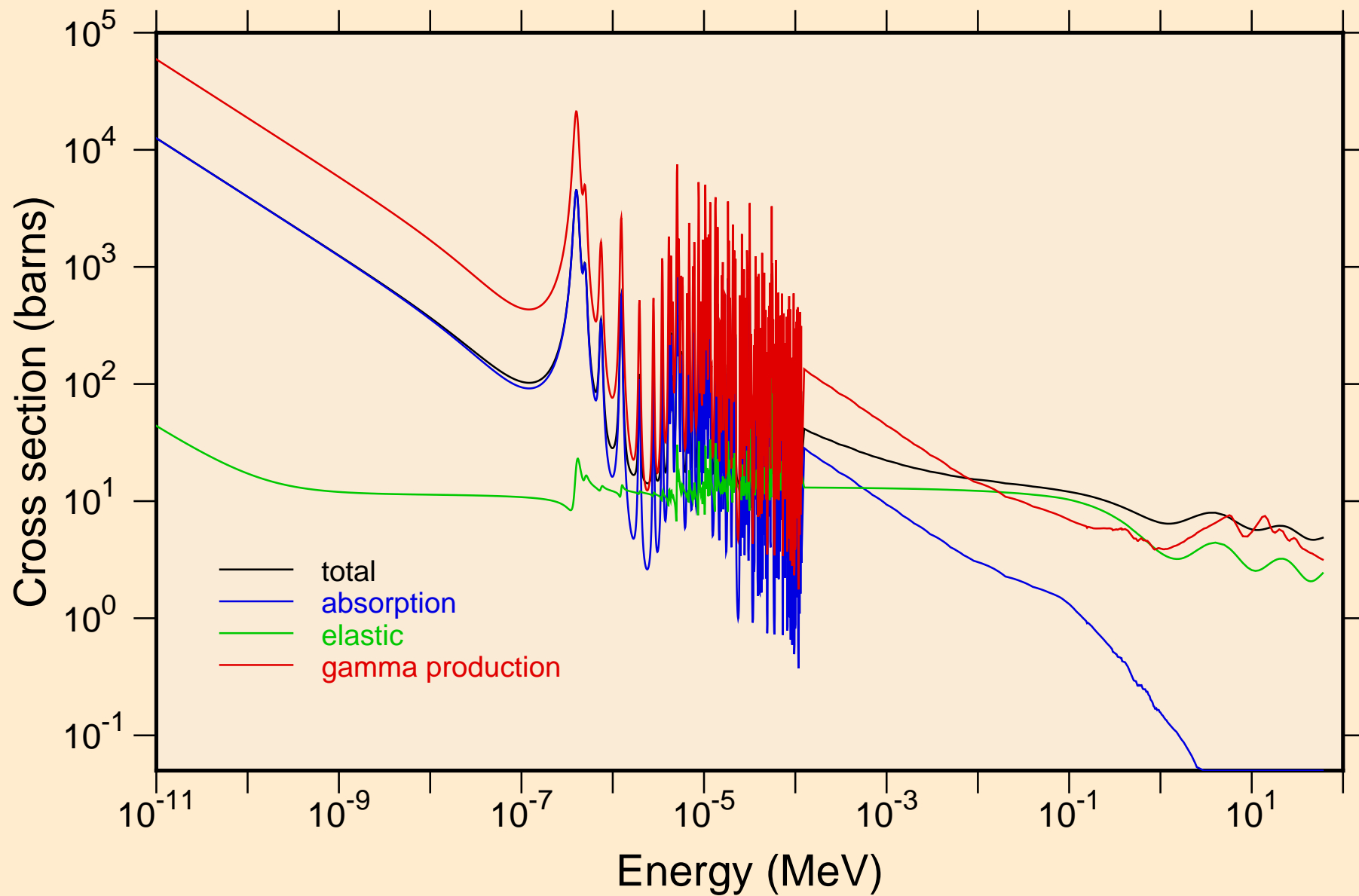

ENDF/B-VII.1 PA-231
resonance total cross section

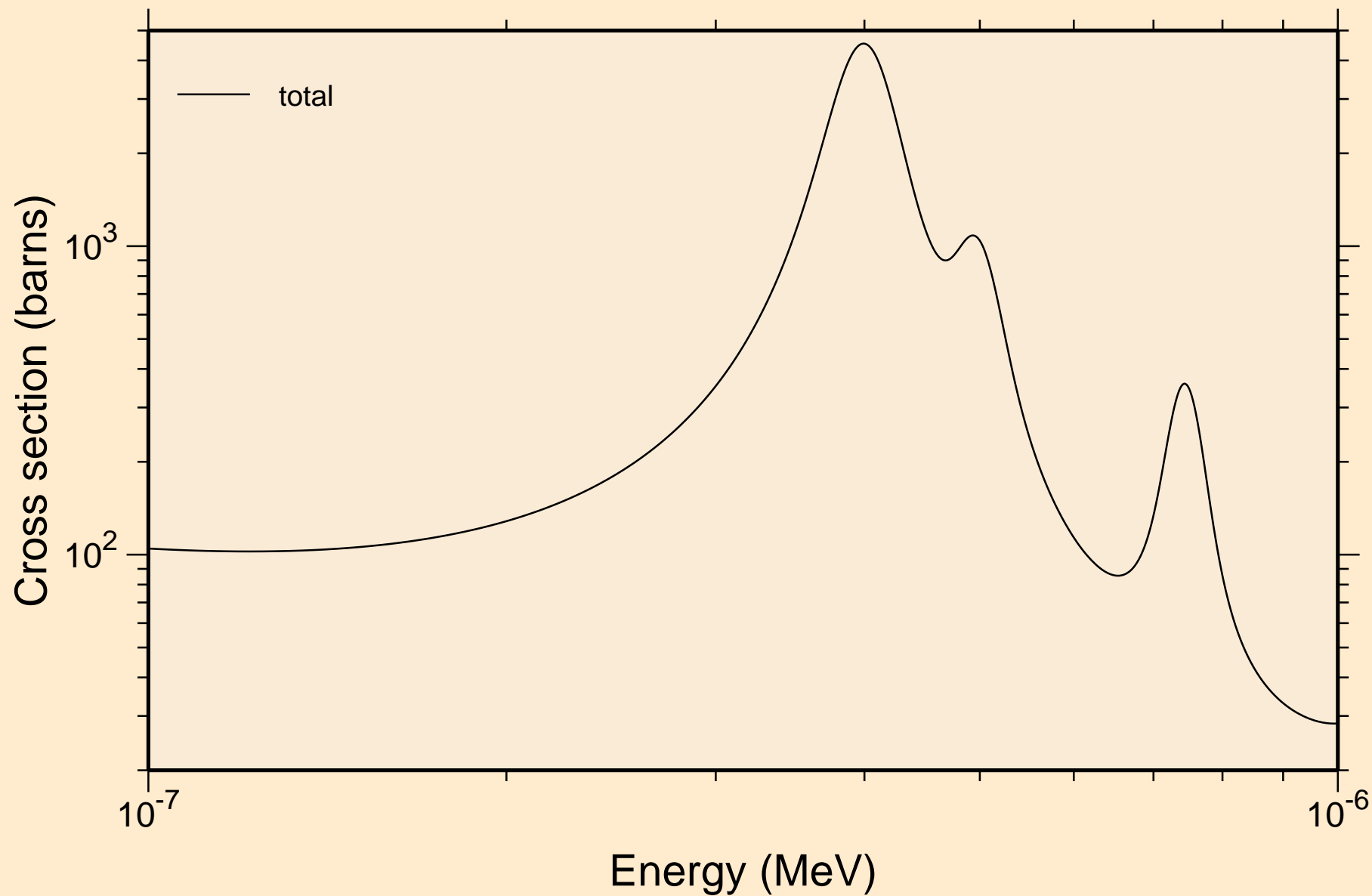

ENDF/B-VII.1 PA-231
resonance total cross section

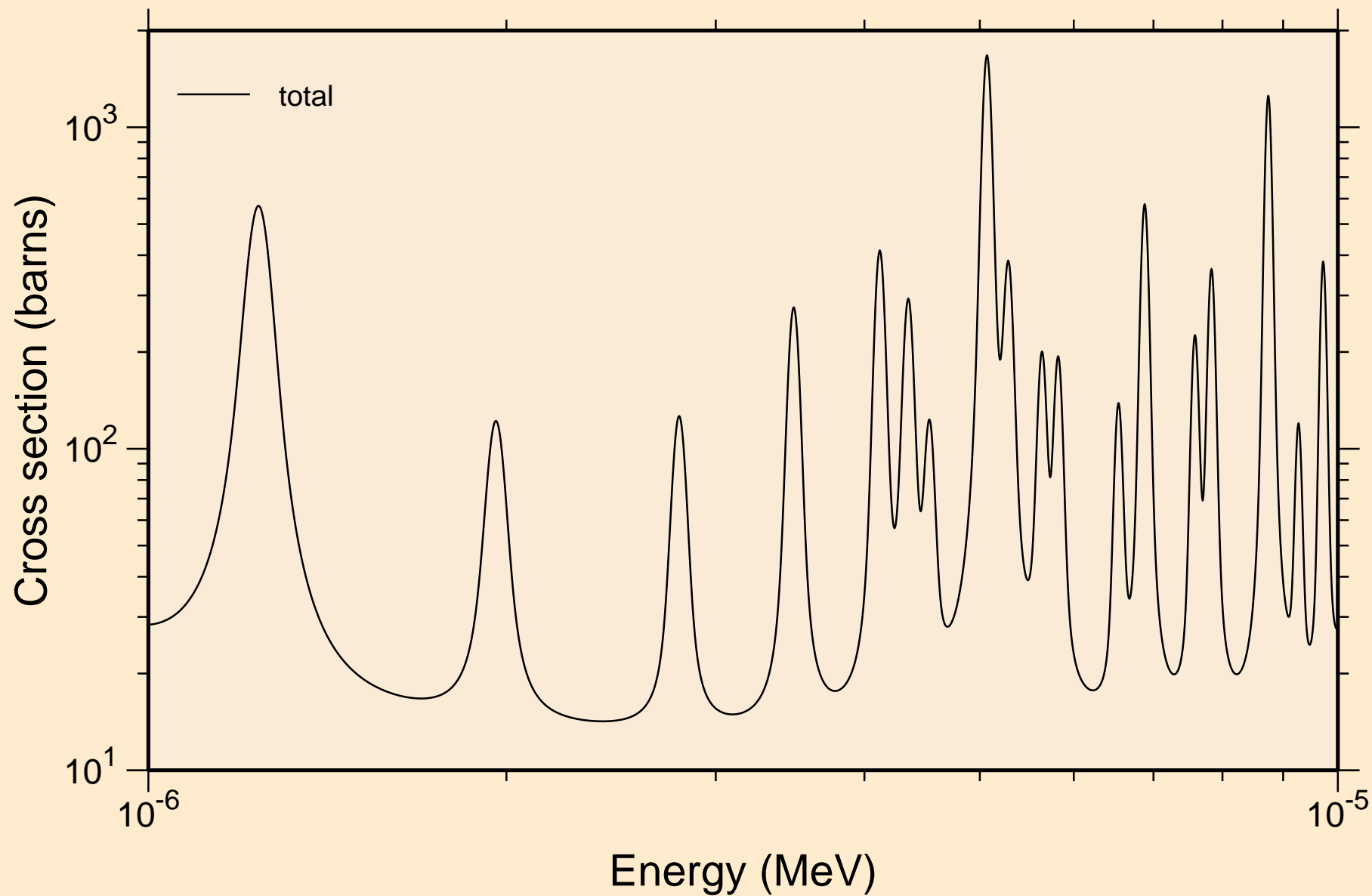

ENDF/B-VII.1 PA-231
resonance total cross section

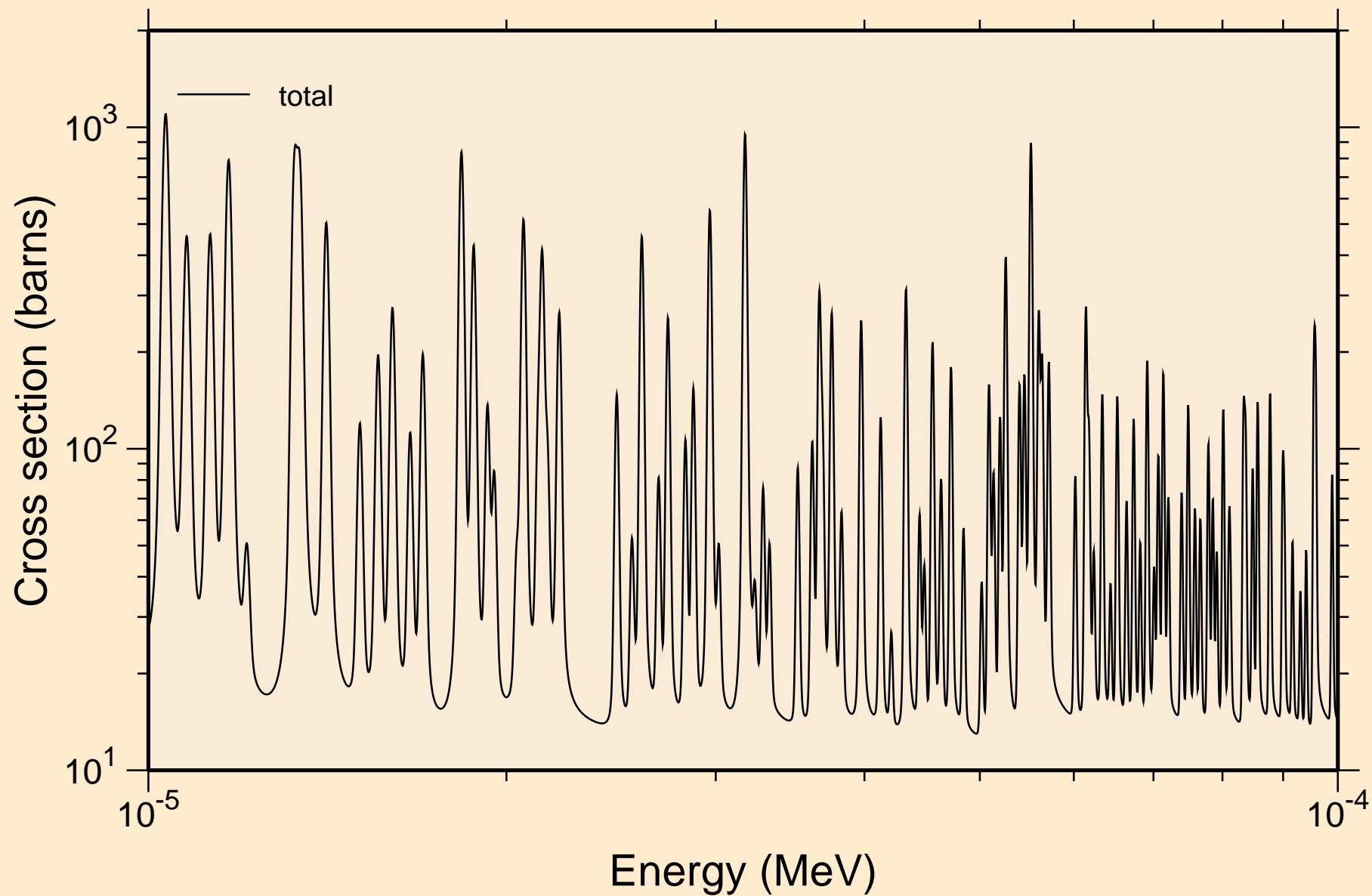

ENDF/B-VII.1 PA-231
resonance total cross section

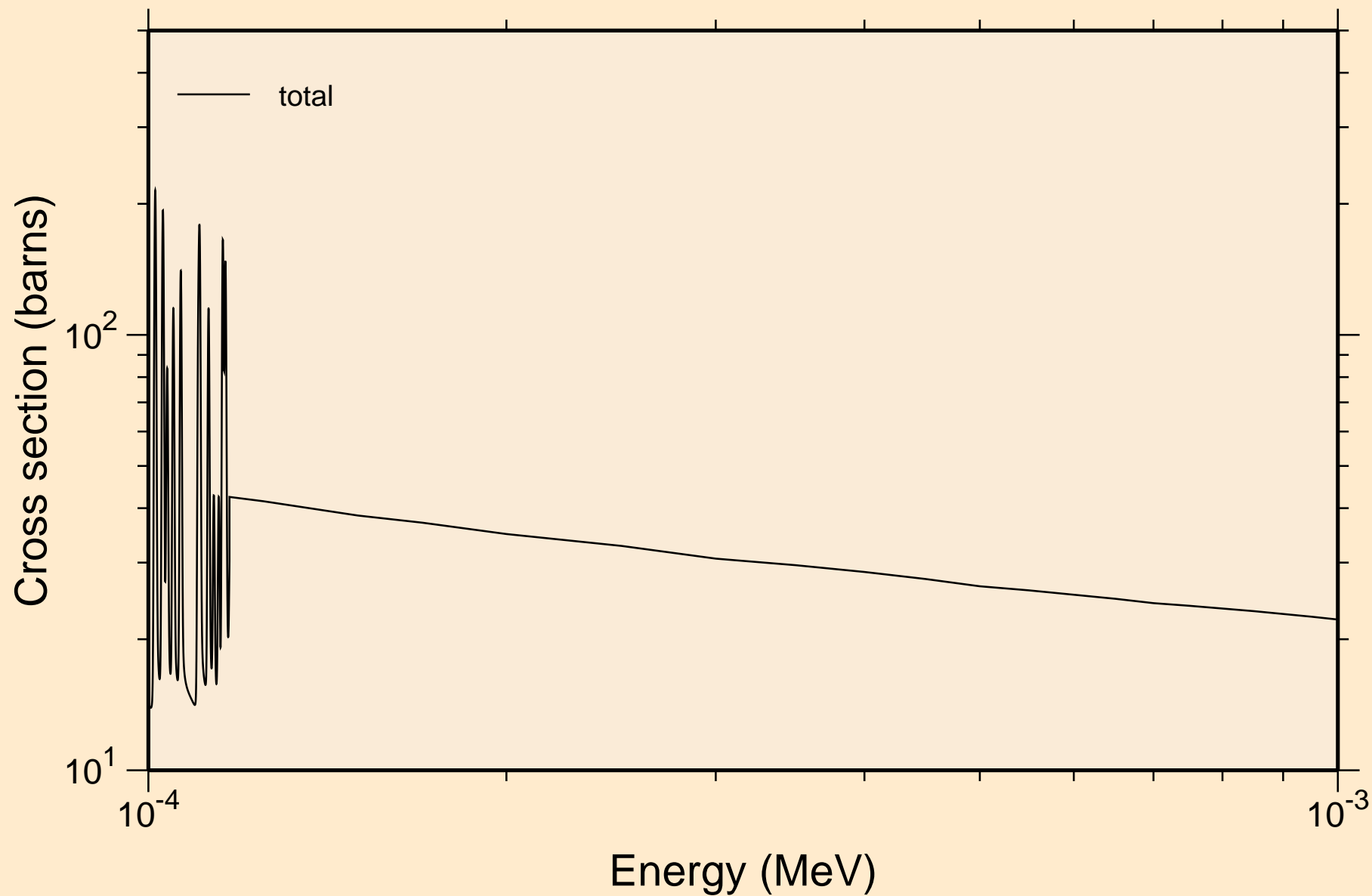

ENDF/B-VII.1 PA-231

resonance absorption cross sections

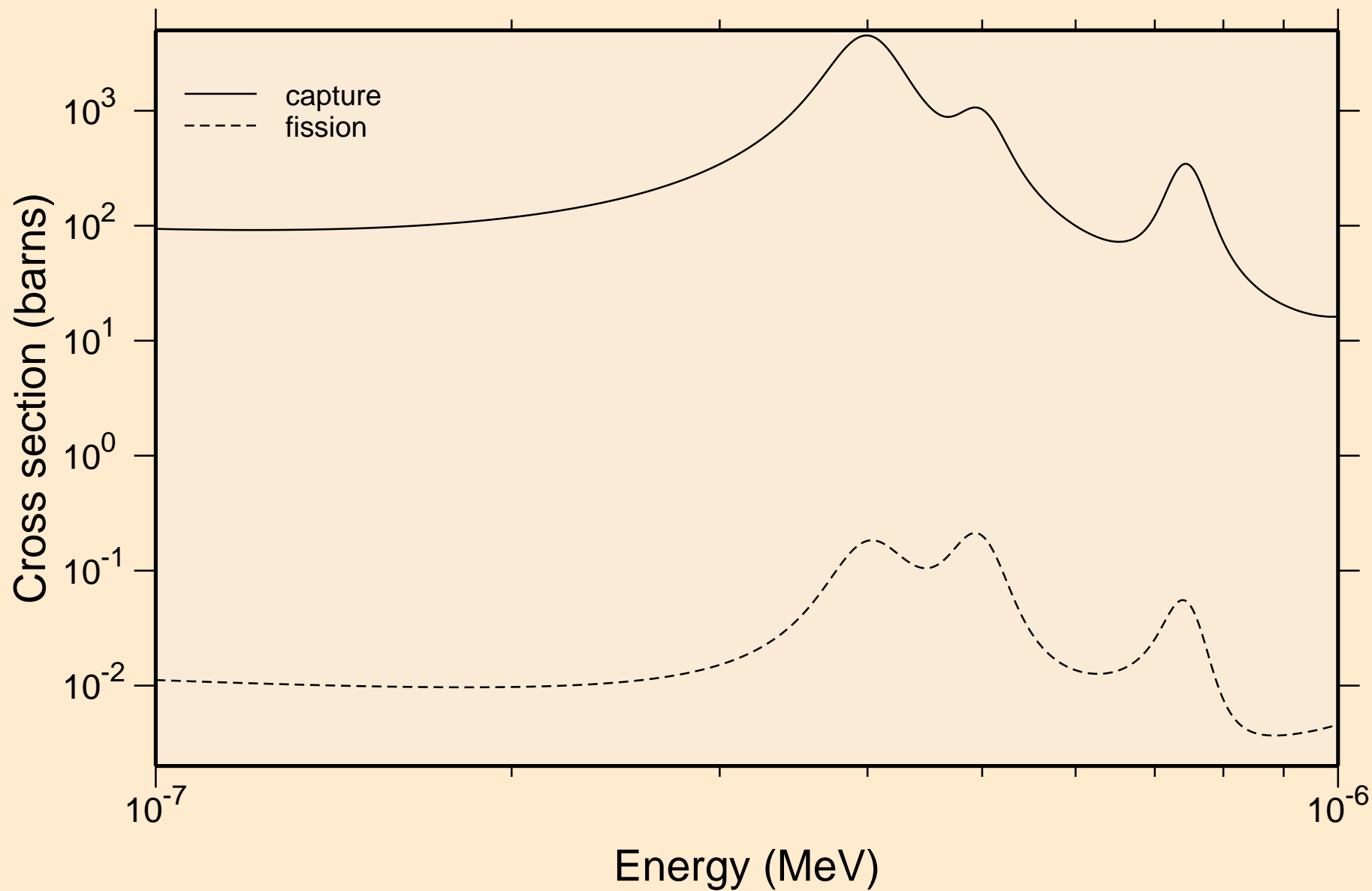

ENDF/B-VII.1 PA-231
resonance absorption cross sections

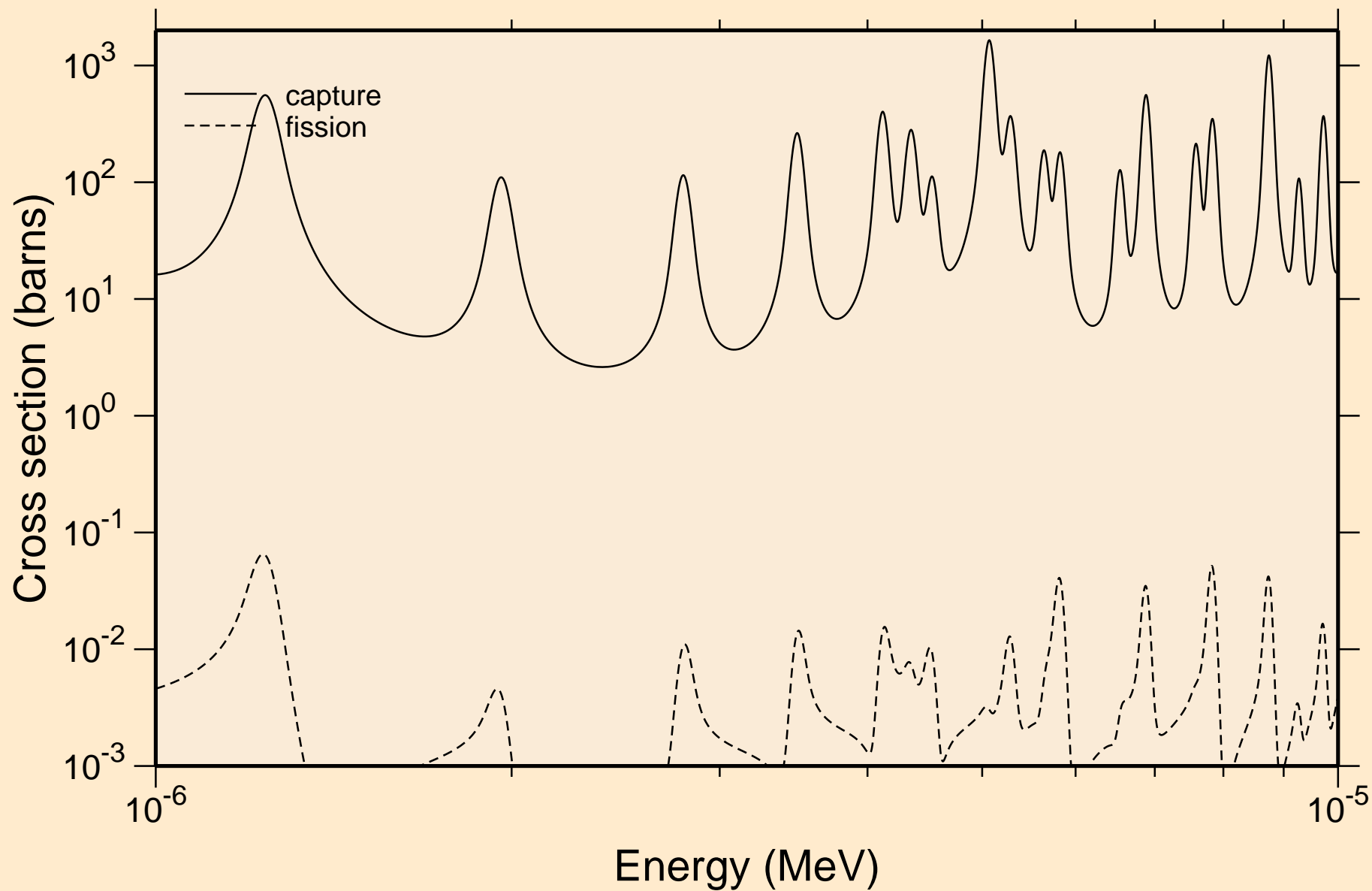

ENDF/B-VII.1 PA-231
resonance absorption cross sections

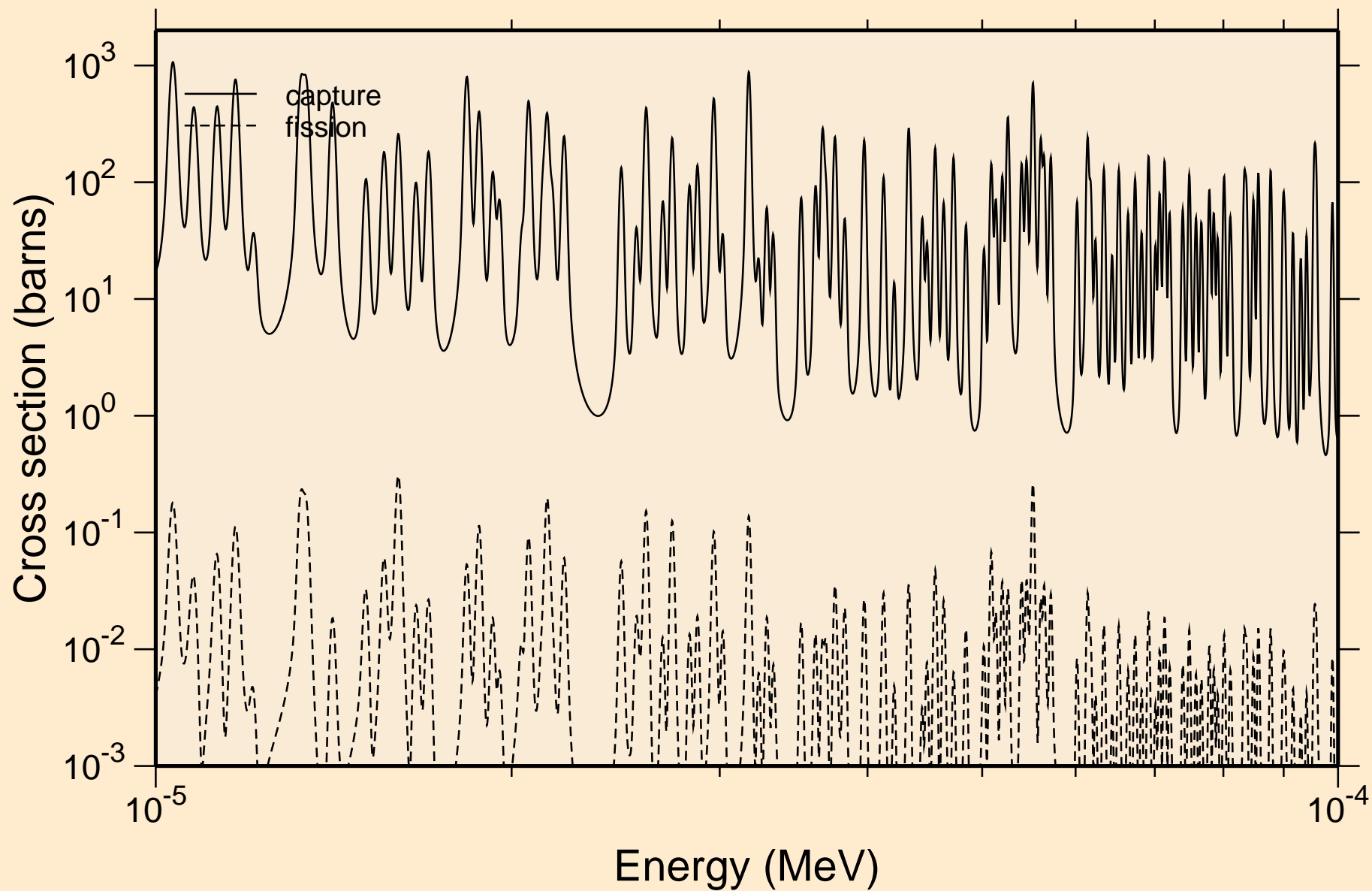

ENDF/B-VII.1 PA-231 resonance absorption cross sections

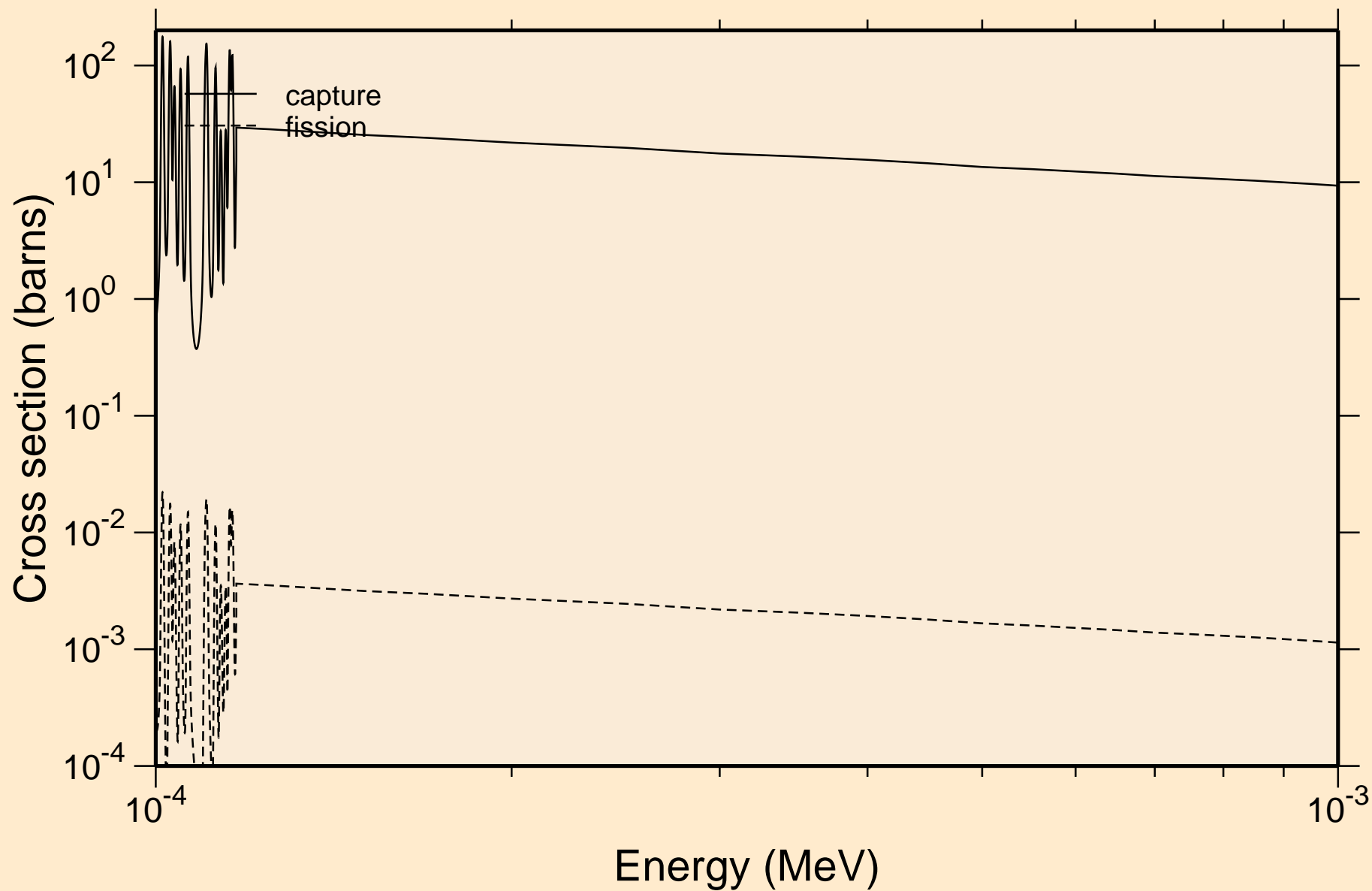

ENDF/B-VII.1 PA-231
UR total cross section

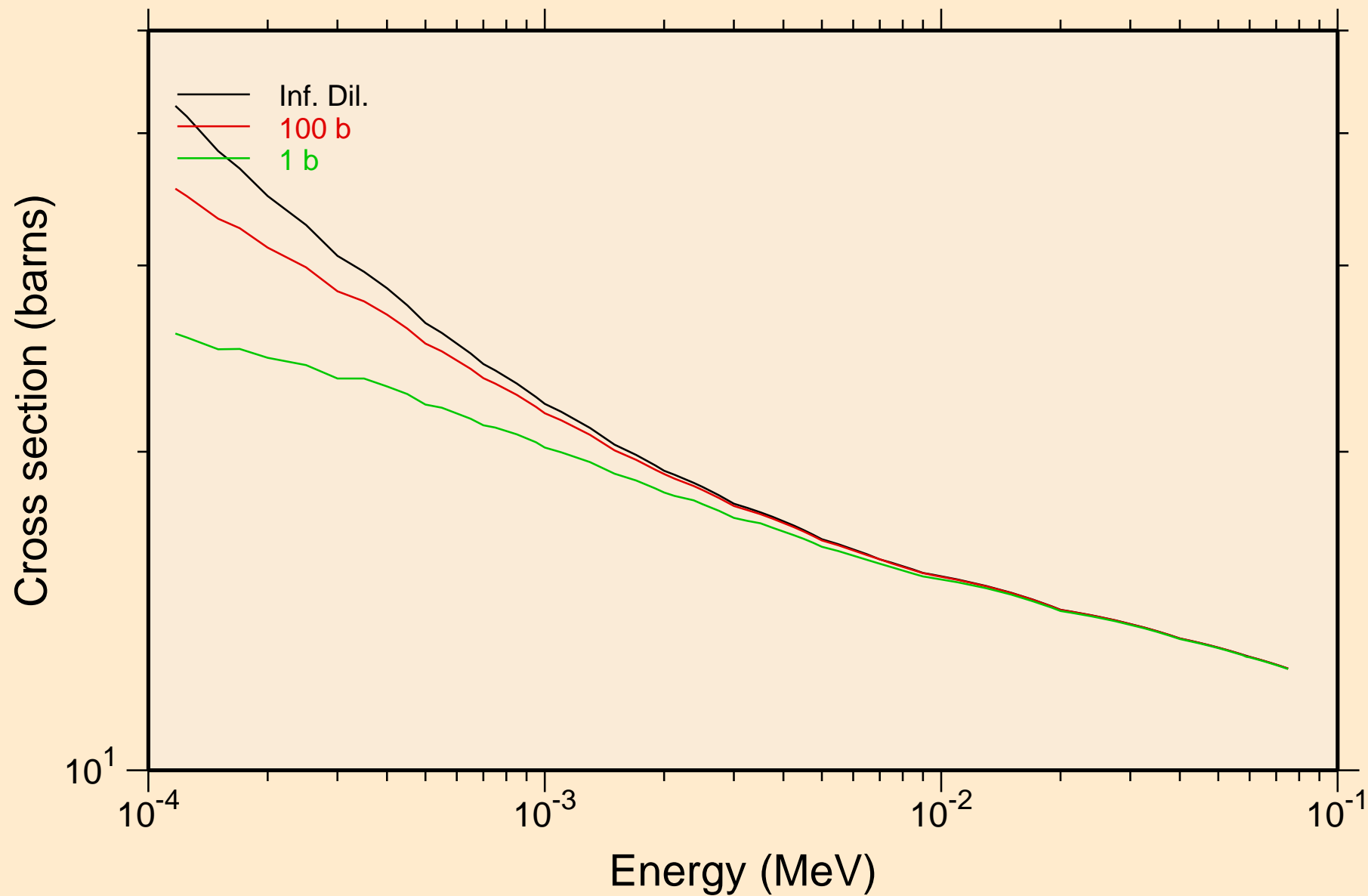

ENDF/B-VII.1 PA-231
UR elastic cross section

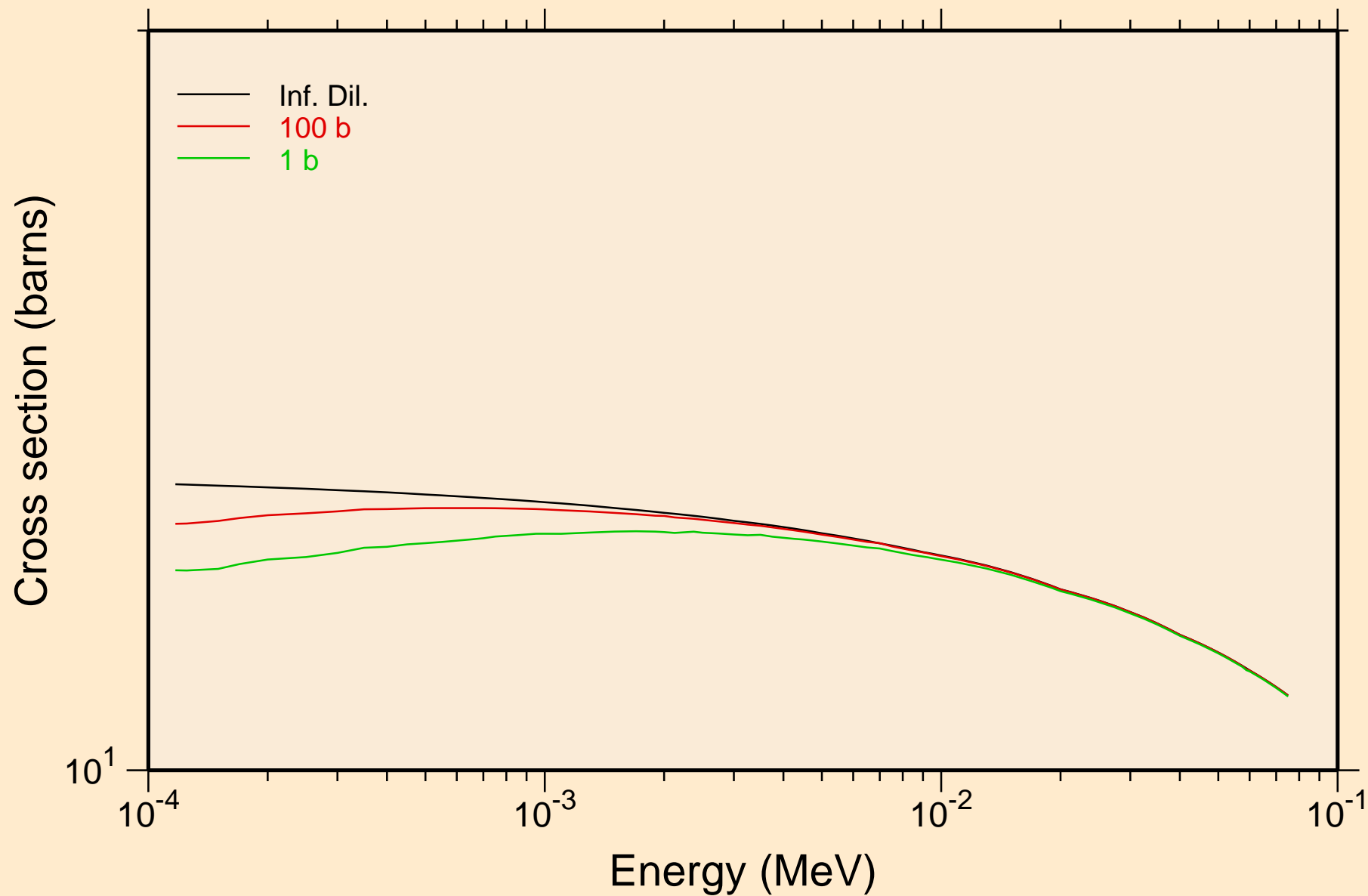

ENDF/B-VII.1 PA-231
UR fission cross section

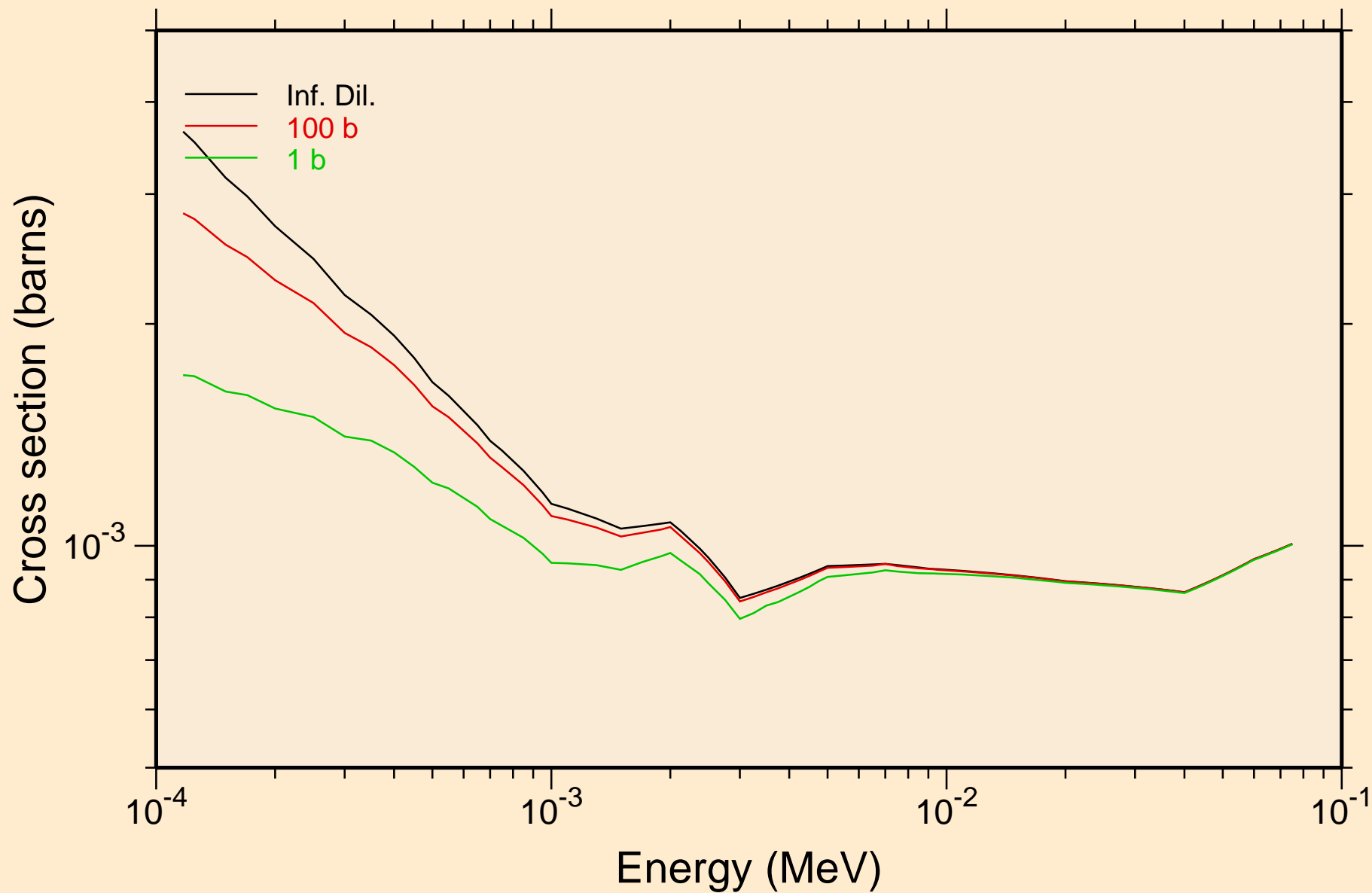

ENDF/B-VII.1 PA-231
UR capture cross section

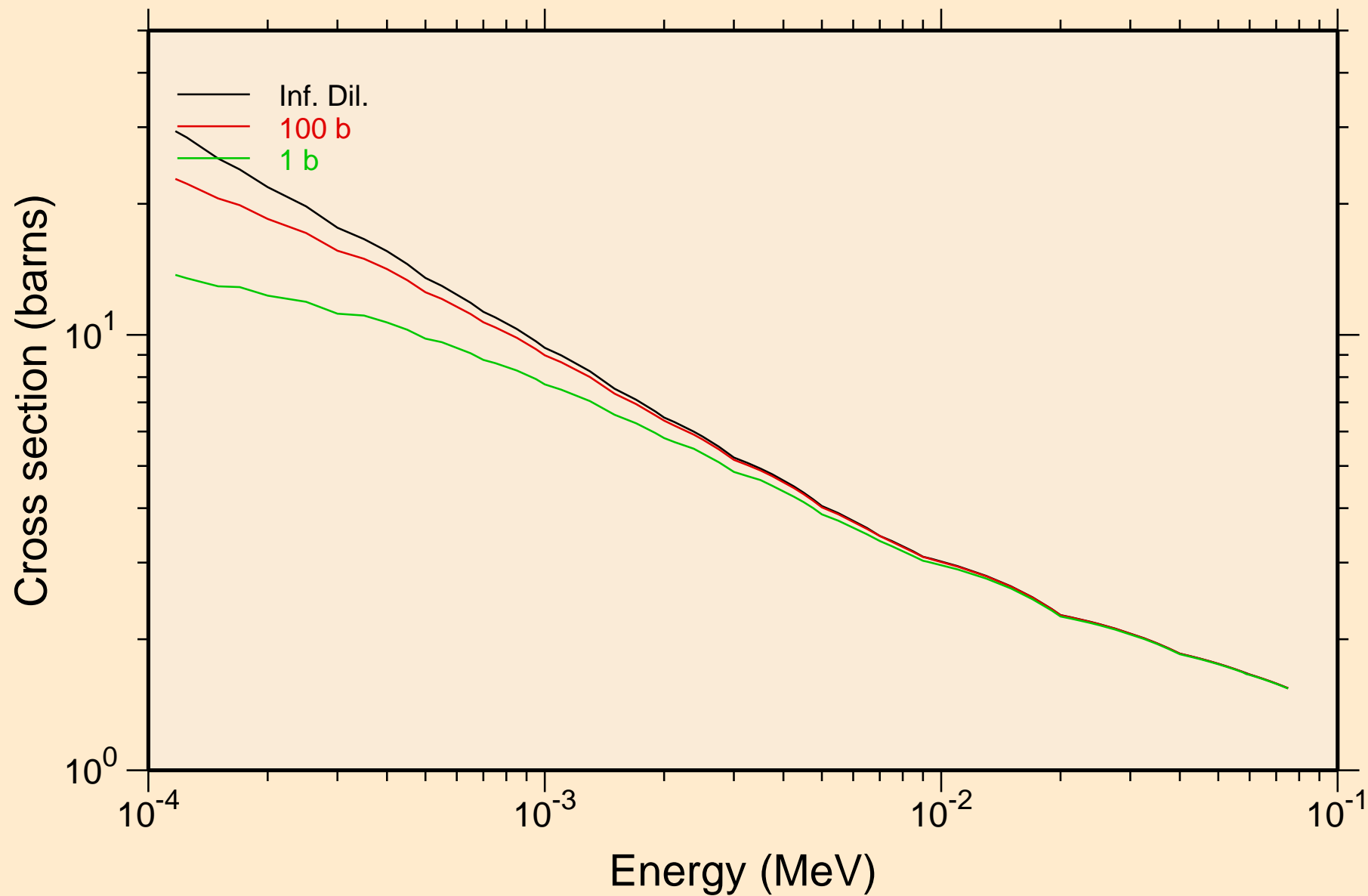

ENDF/B-VII.1 PA-231

Heating

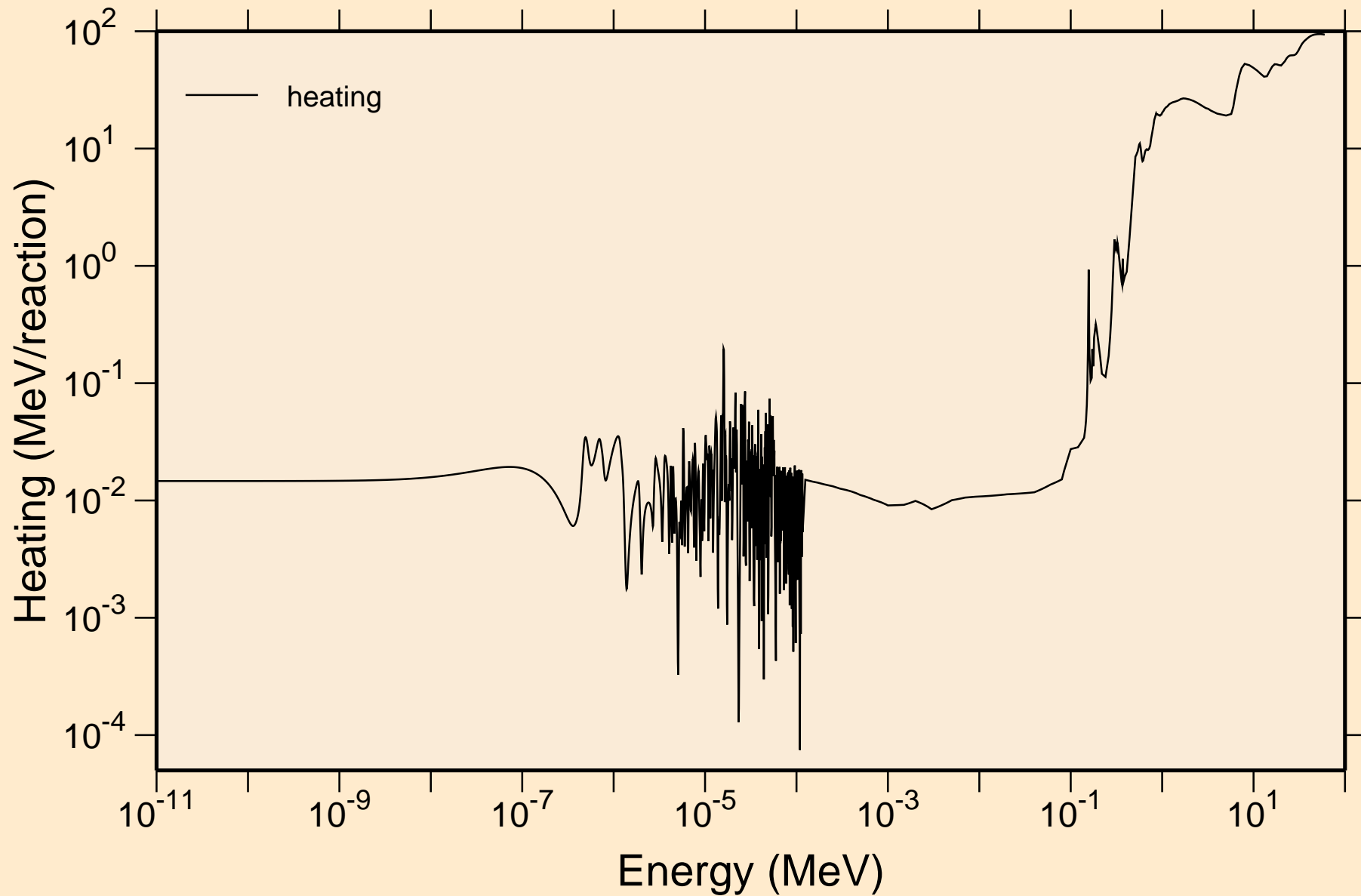

ENDF/B-VII.1 PA-231

Damage

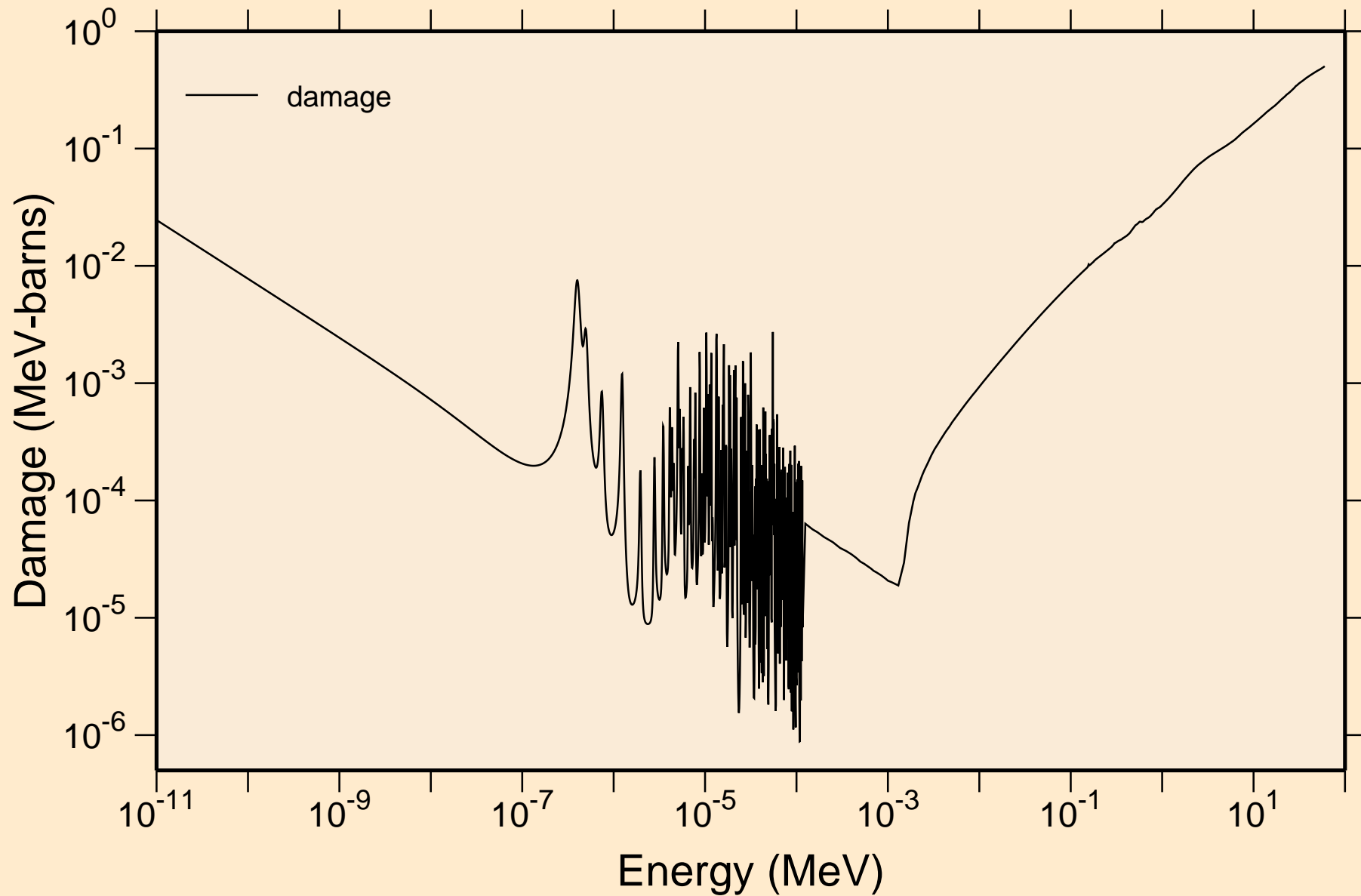

ENDF/B-VII.1 PA-231

Non-threshold reactions

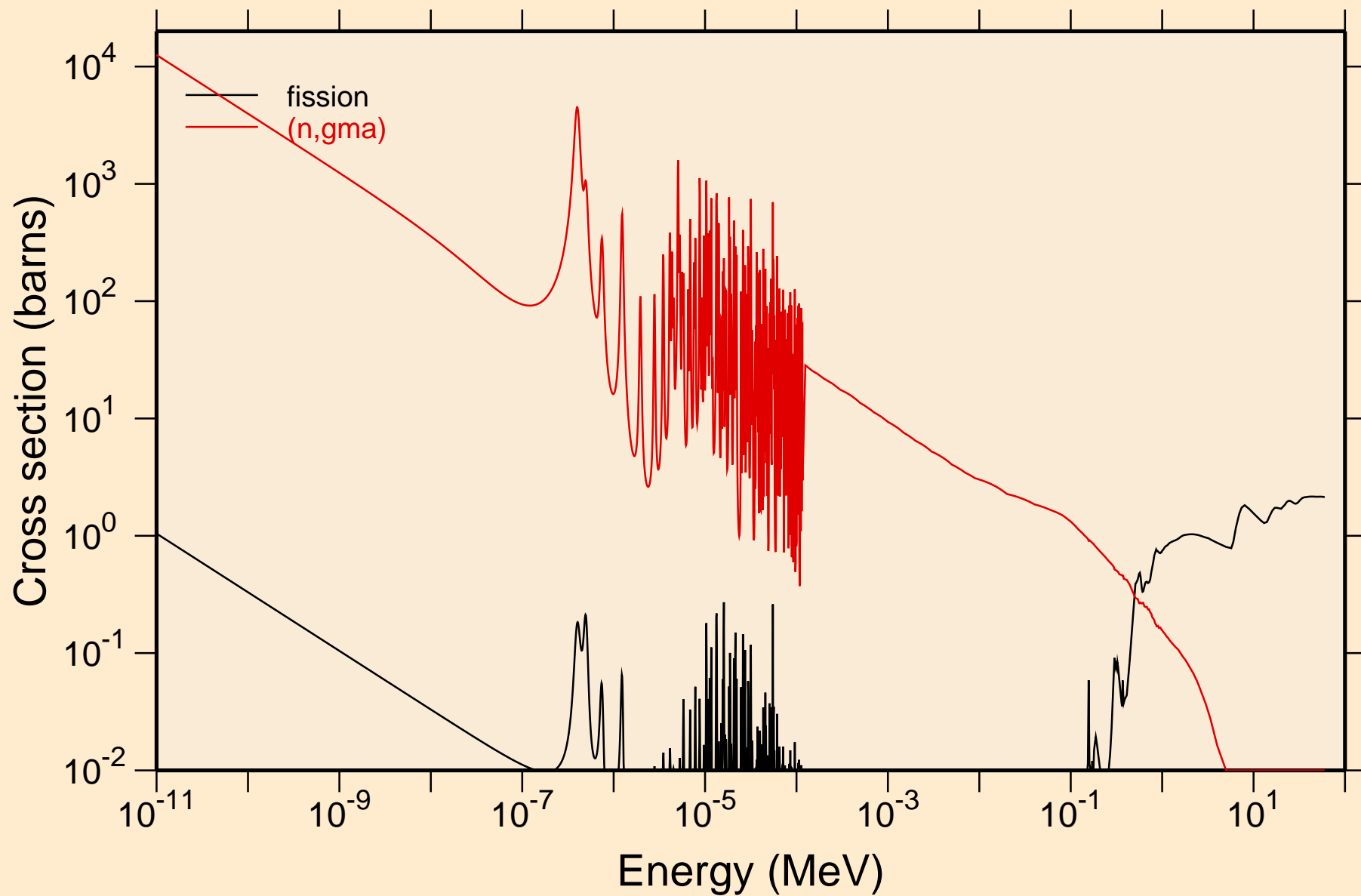

ENDF/B-VII.1 PA-231
Principal cross sections

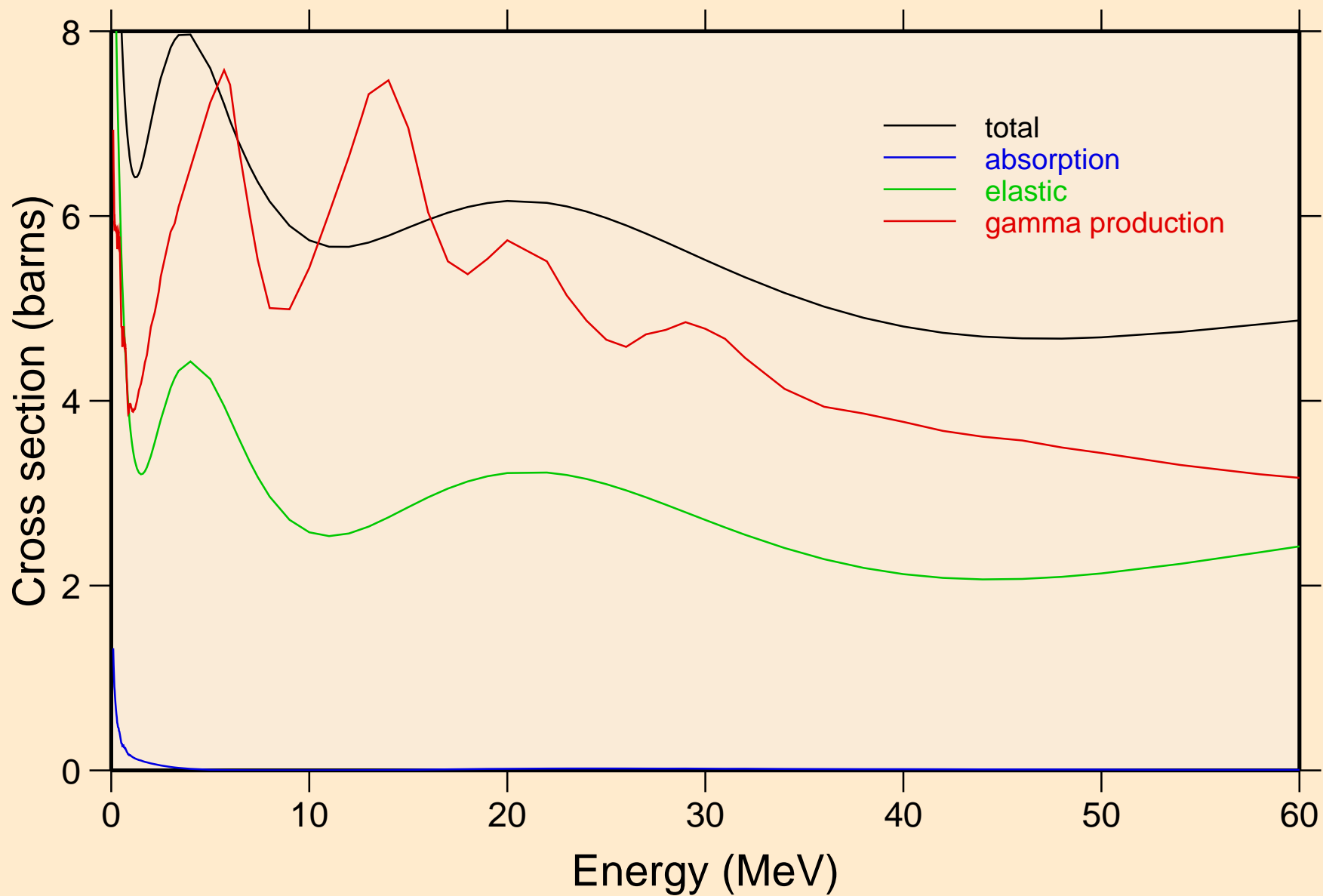

ENDF/B-VII.1 PA-231

Heating

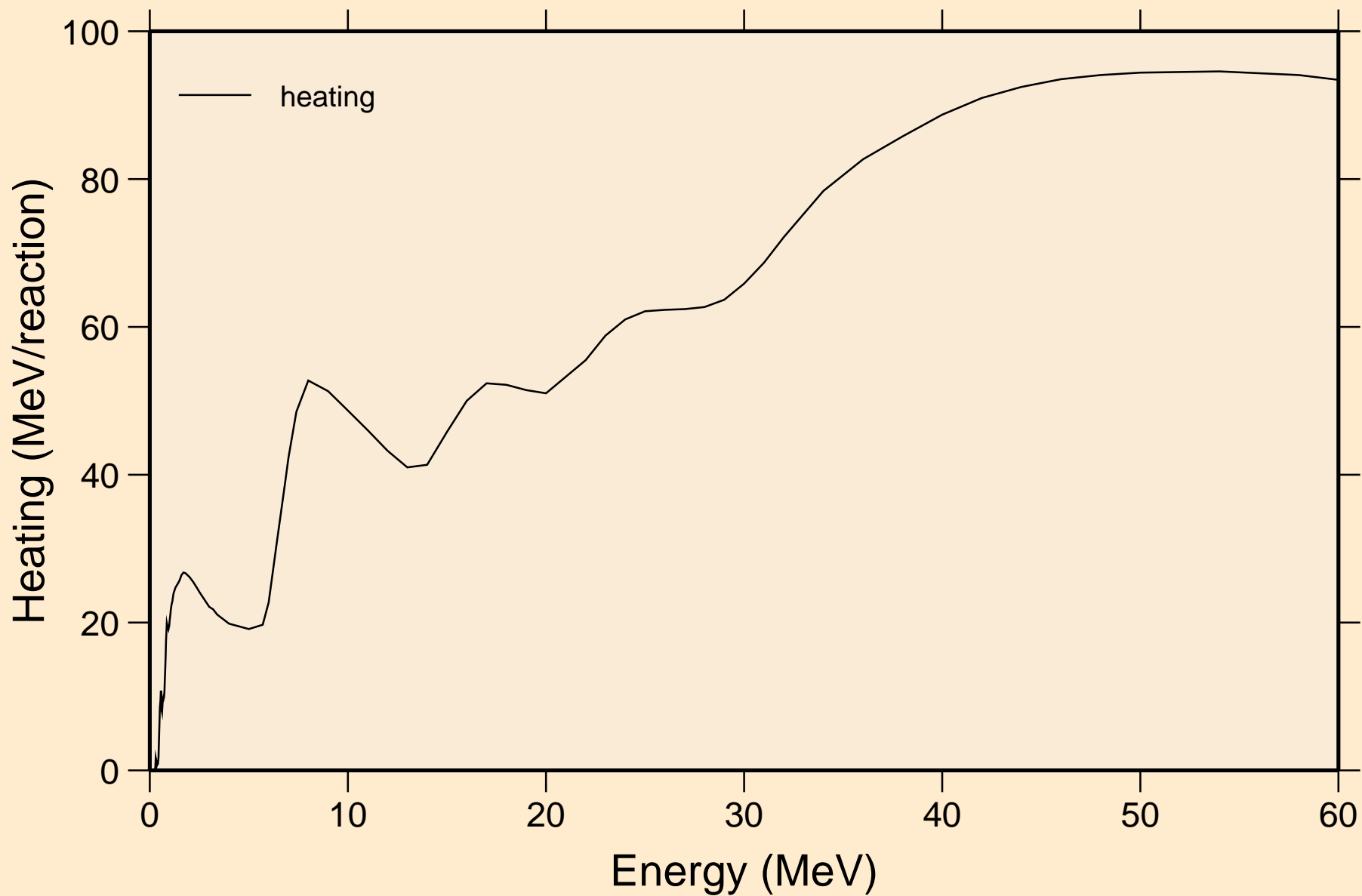

ENDF/B-VII.1 PA-231

Damage

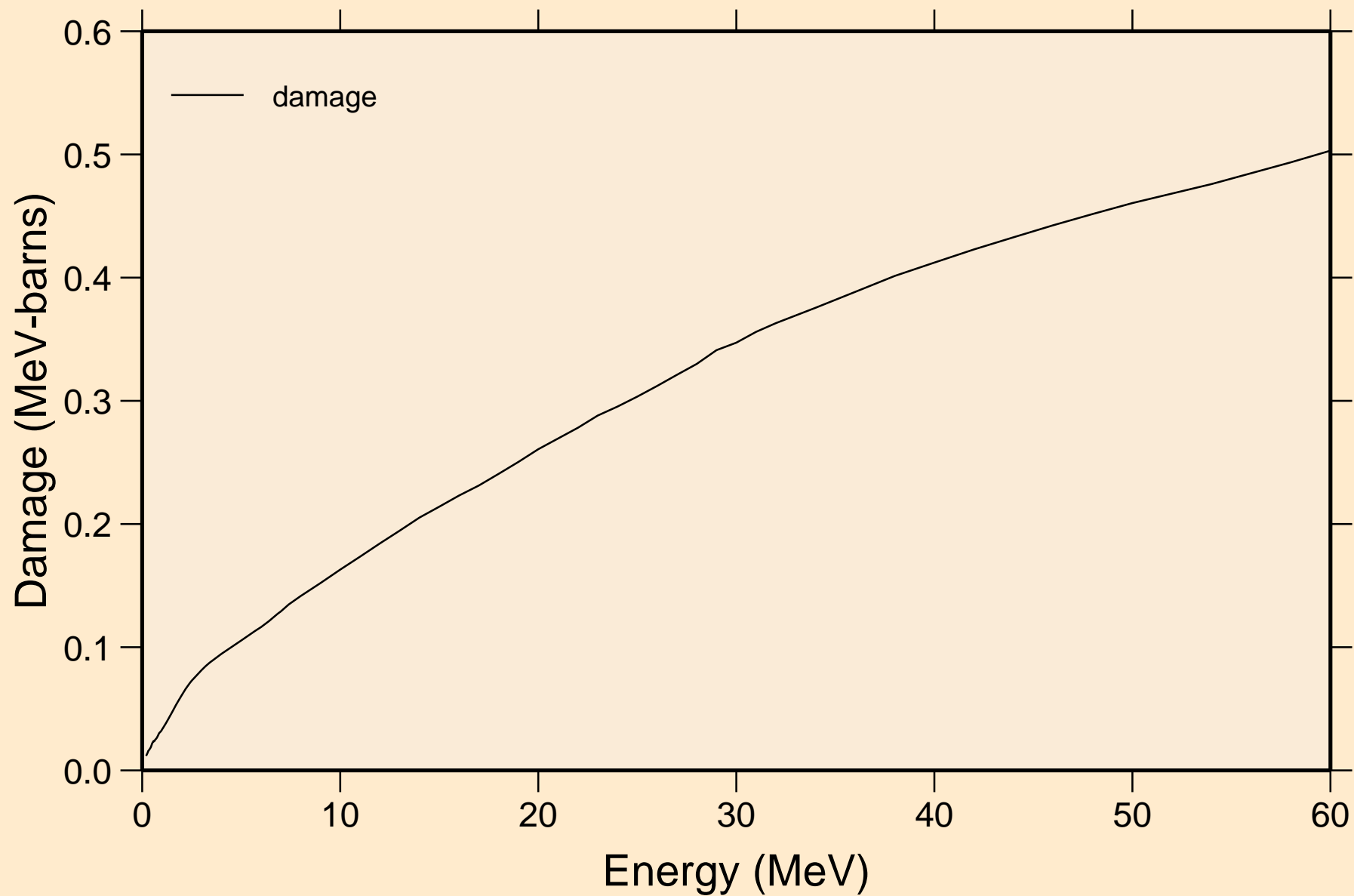

ENDF/B-VII.1 PA-231
Non-threshold reactions

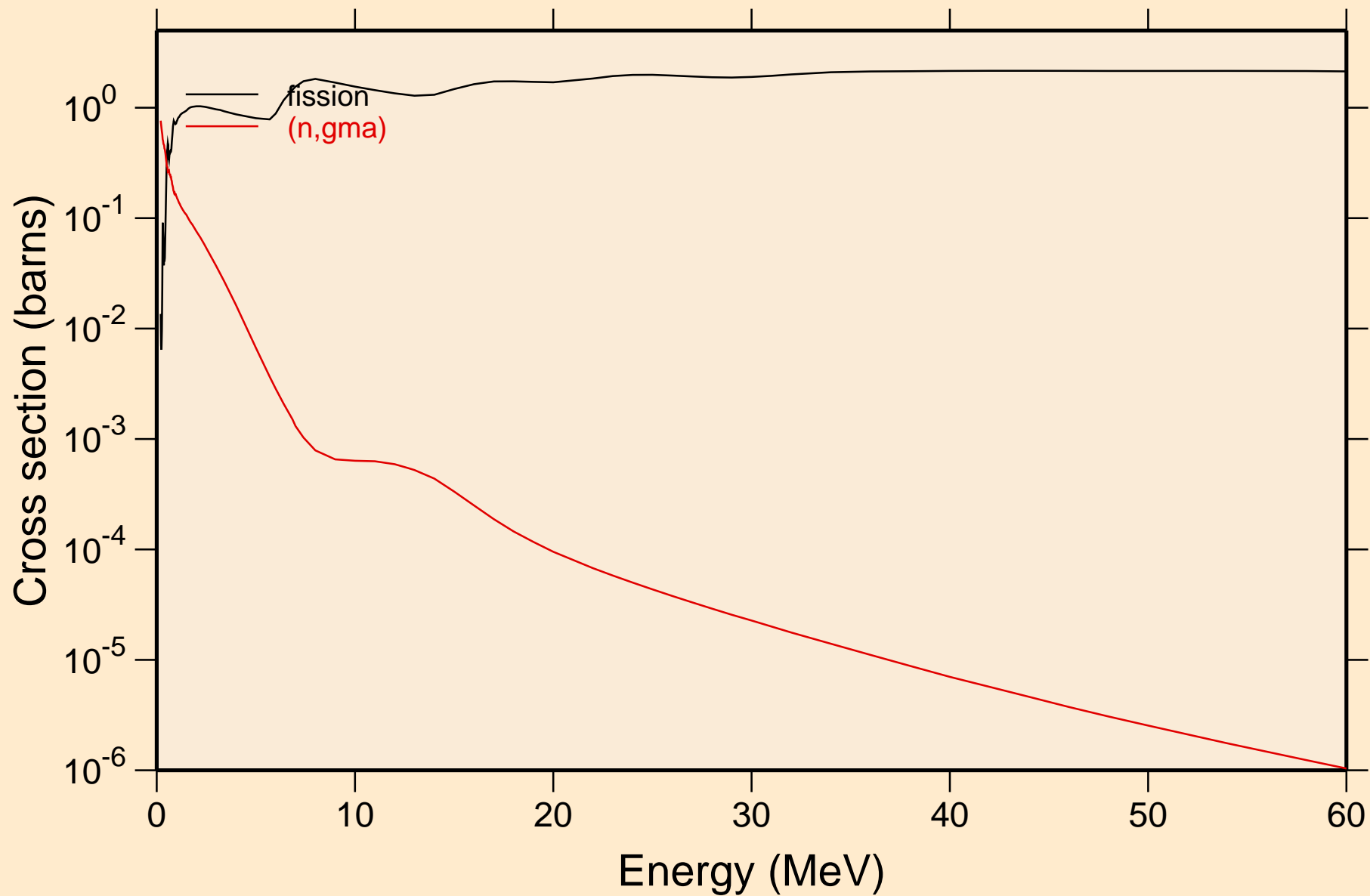

ENDF/B-VII.1 PA-231

Inelastic levels

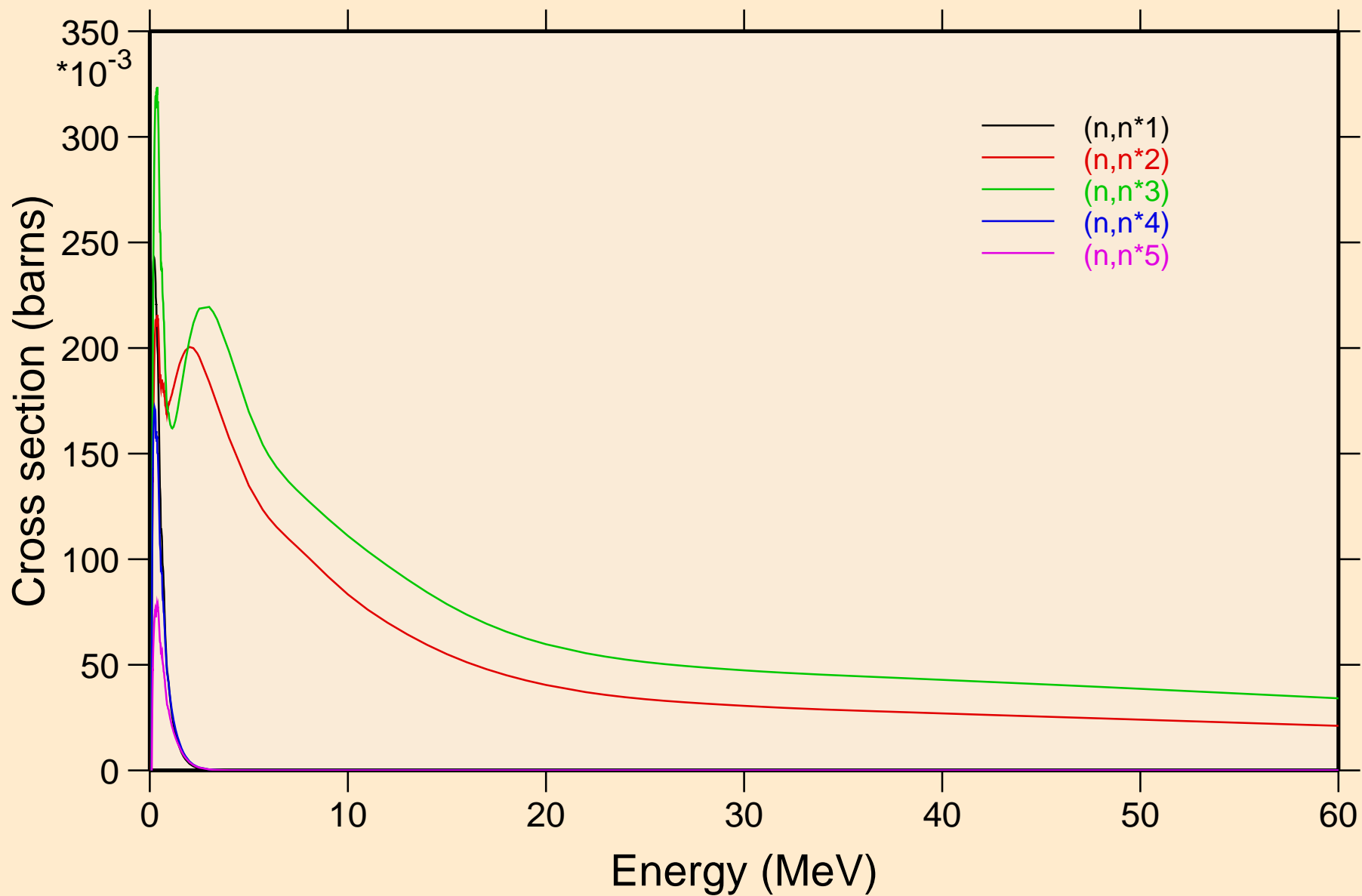

ENDF/B-VII.1 PA-231

Inelastic levels

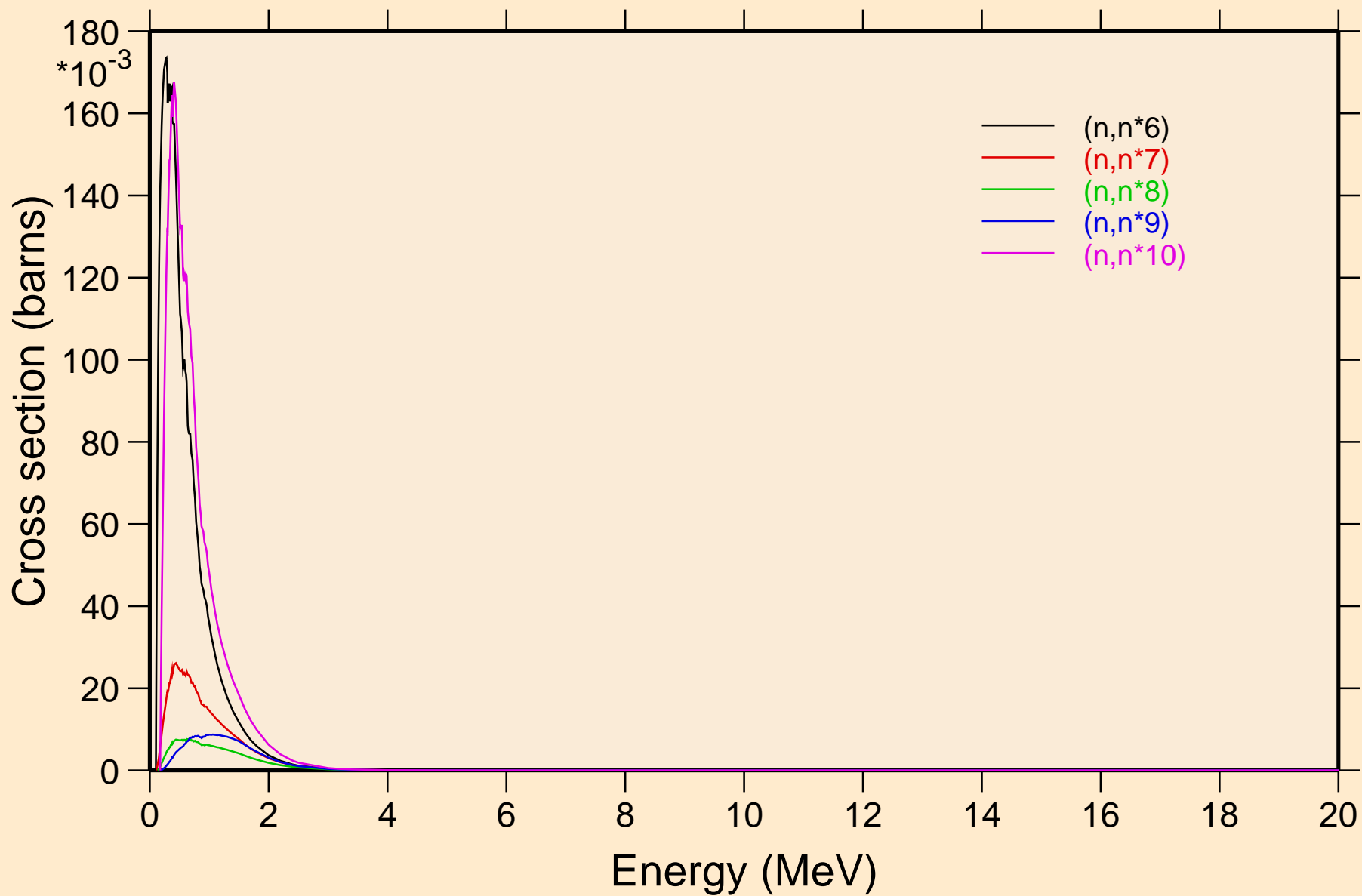

ENDF/B-VII.1 PA-231

Inelastic levels

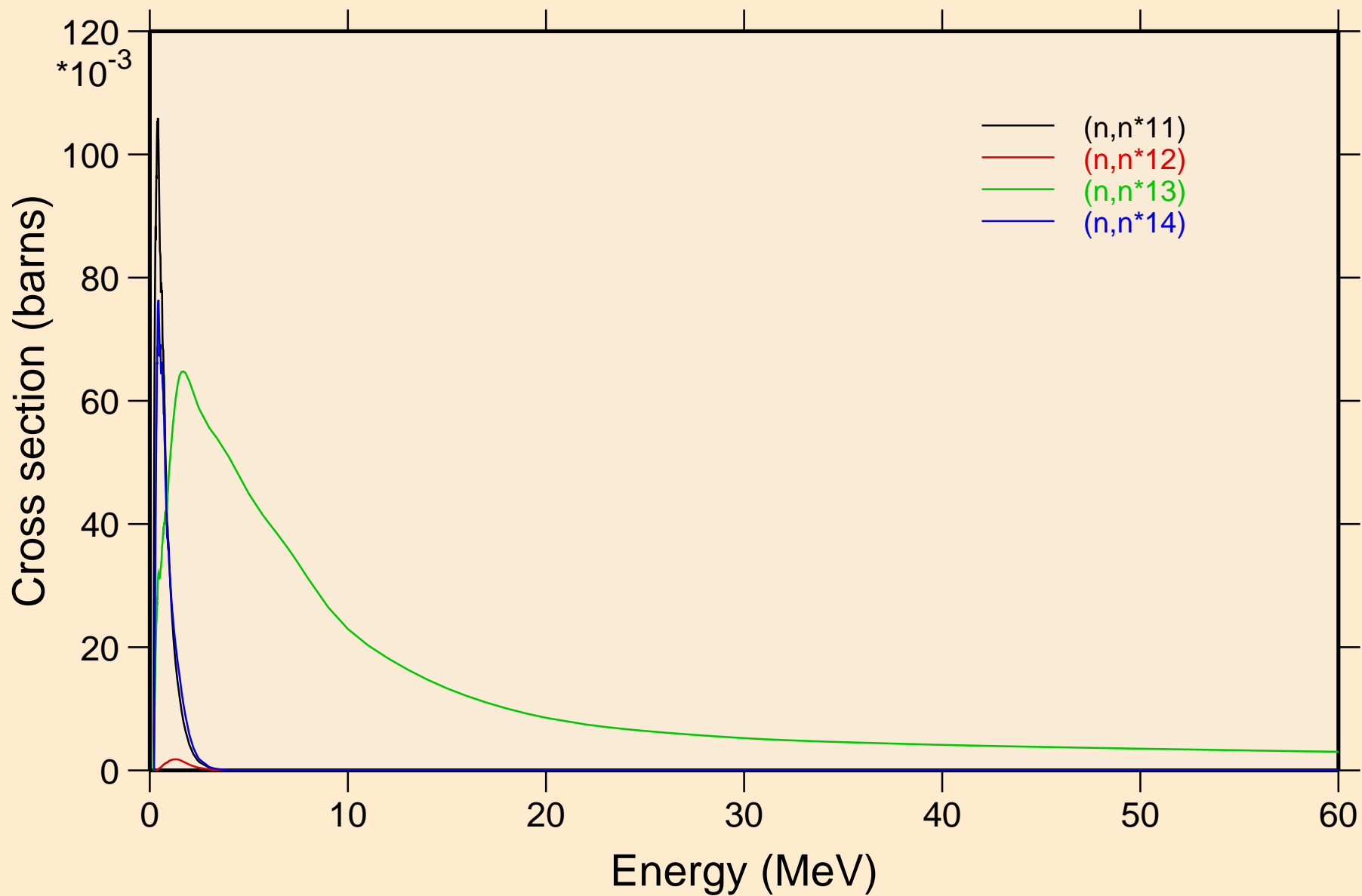

ENDF/B-VII.1 PA-231

Threshold reactions

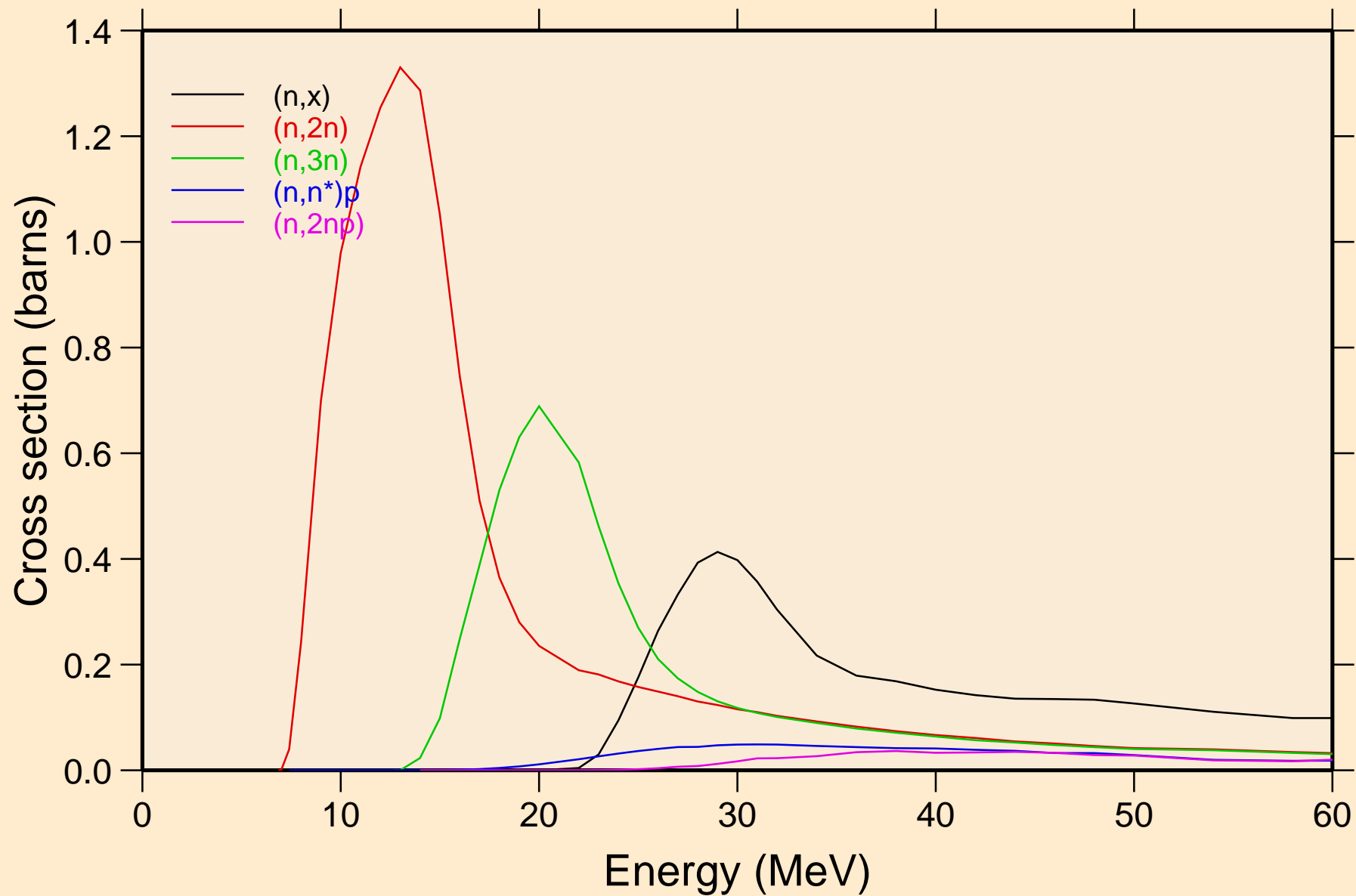

ENDF/B-VII.1 PA-231

Threshold reactions

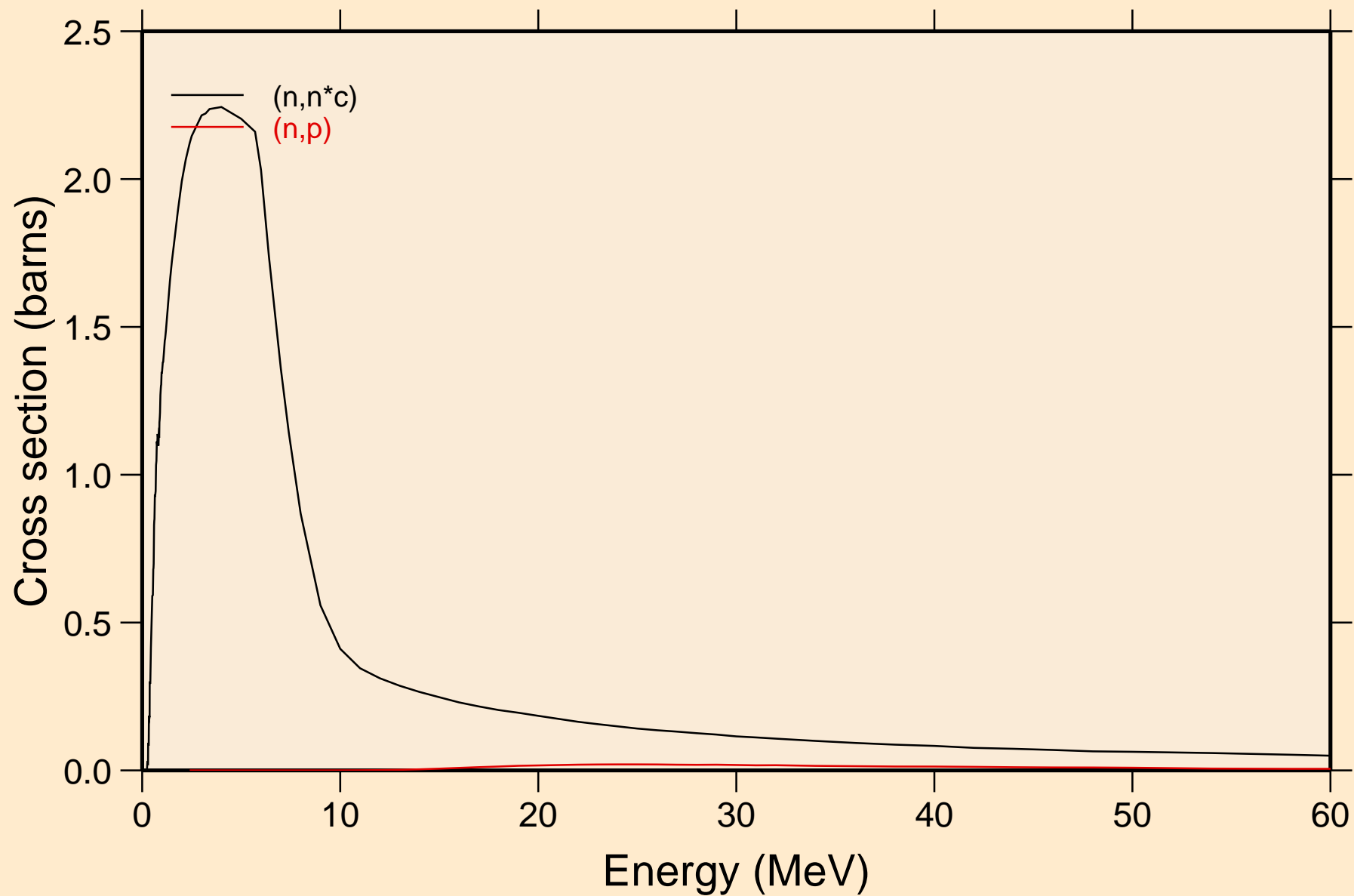

ENDF/B-VII.1 PA-231

Threshold reactions

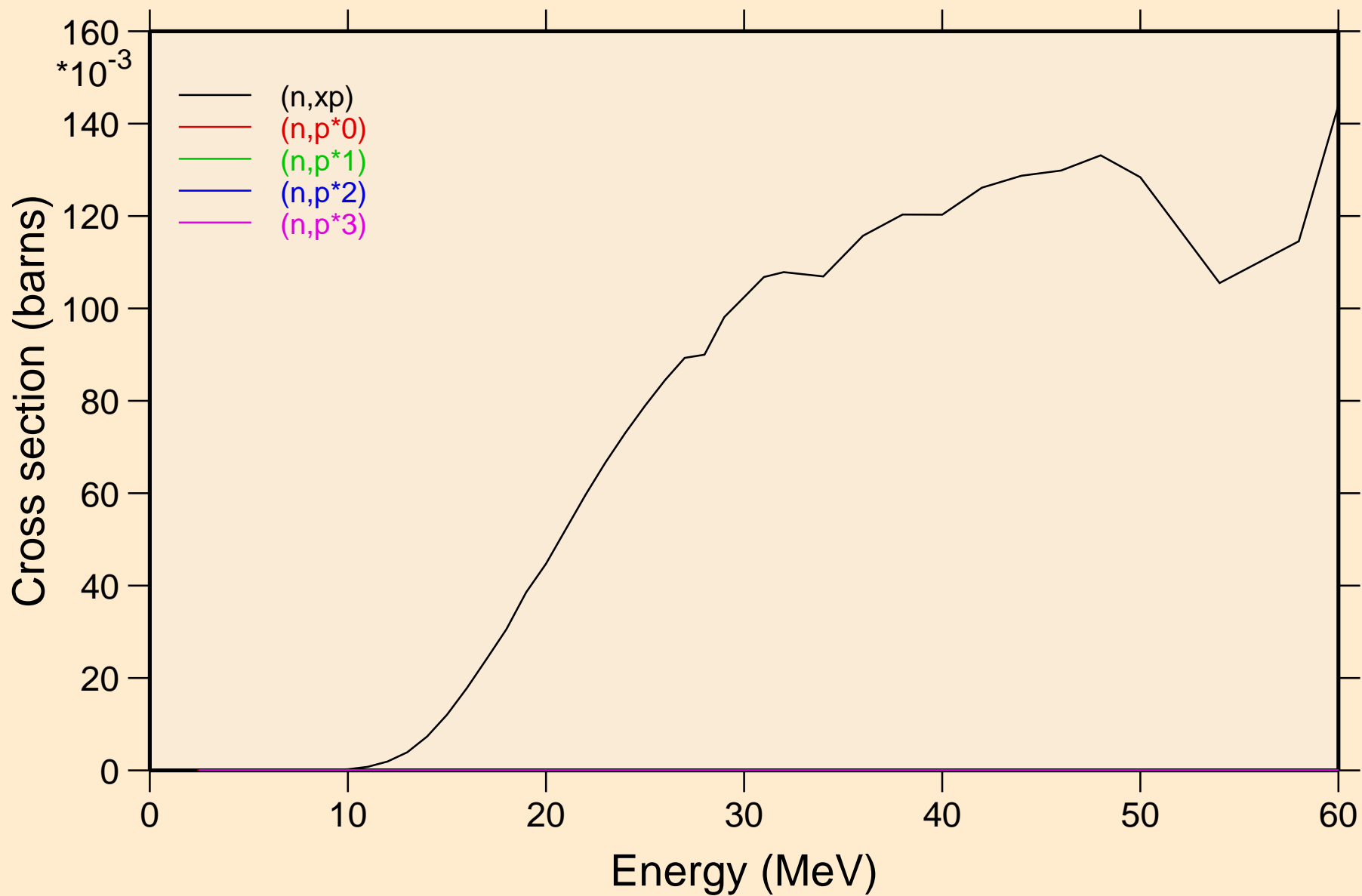

ENDF/B-VII.1 PA-231

Threshold reactions

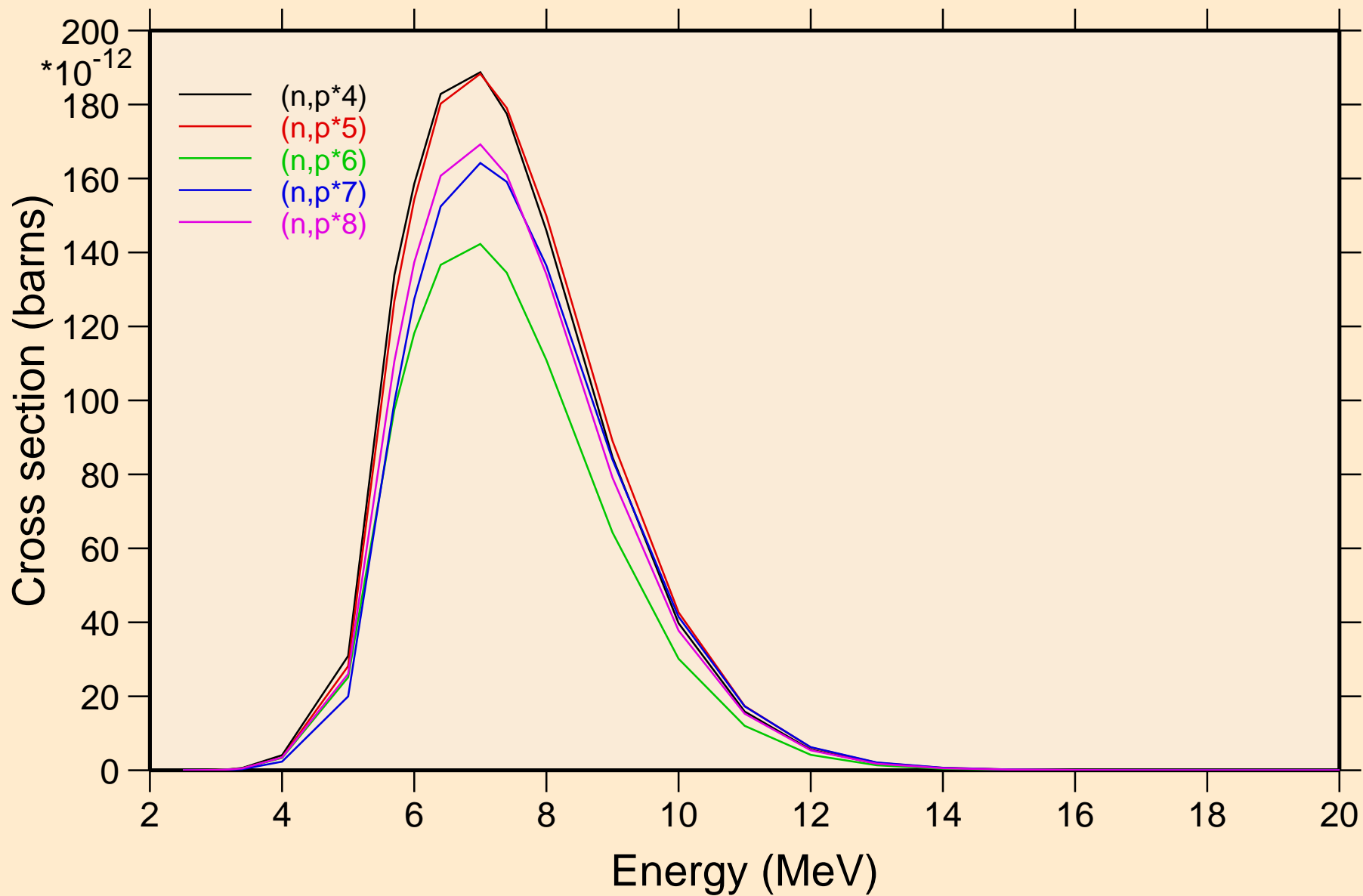

ENDF/B-VII.1 PA-231

Threshold reactions

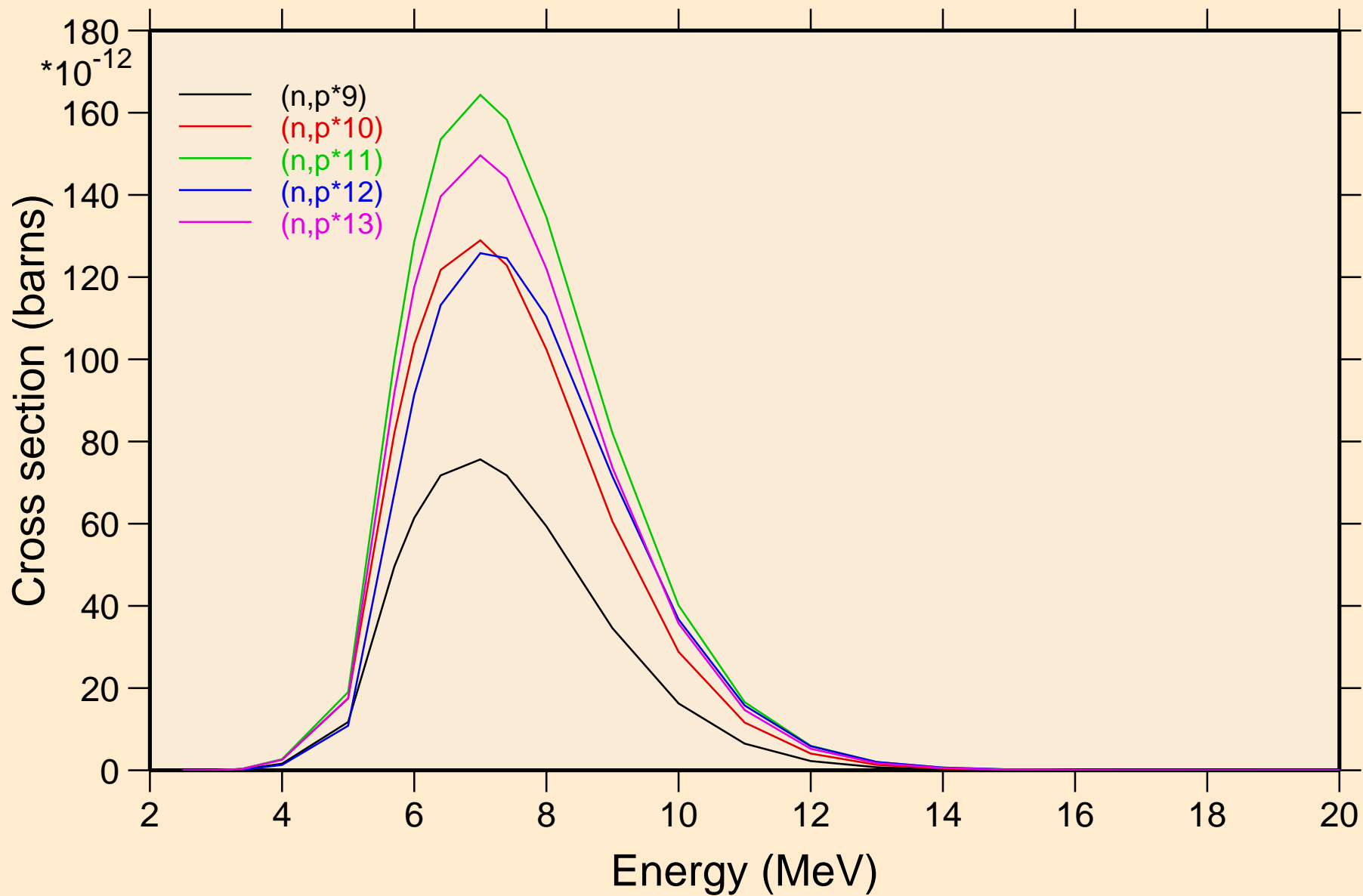

ENDF/B-VII.1 PA-231

Threshold reactions

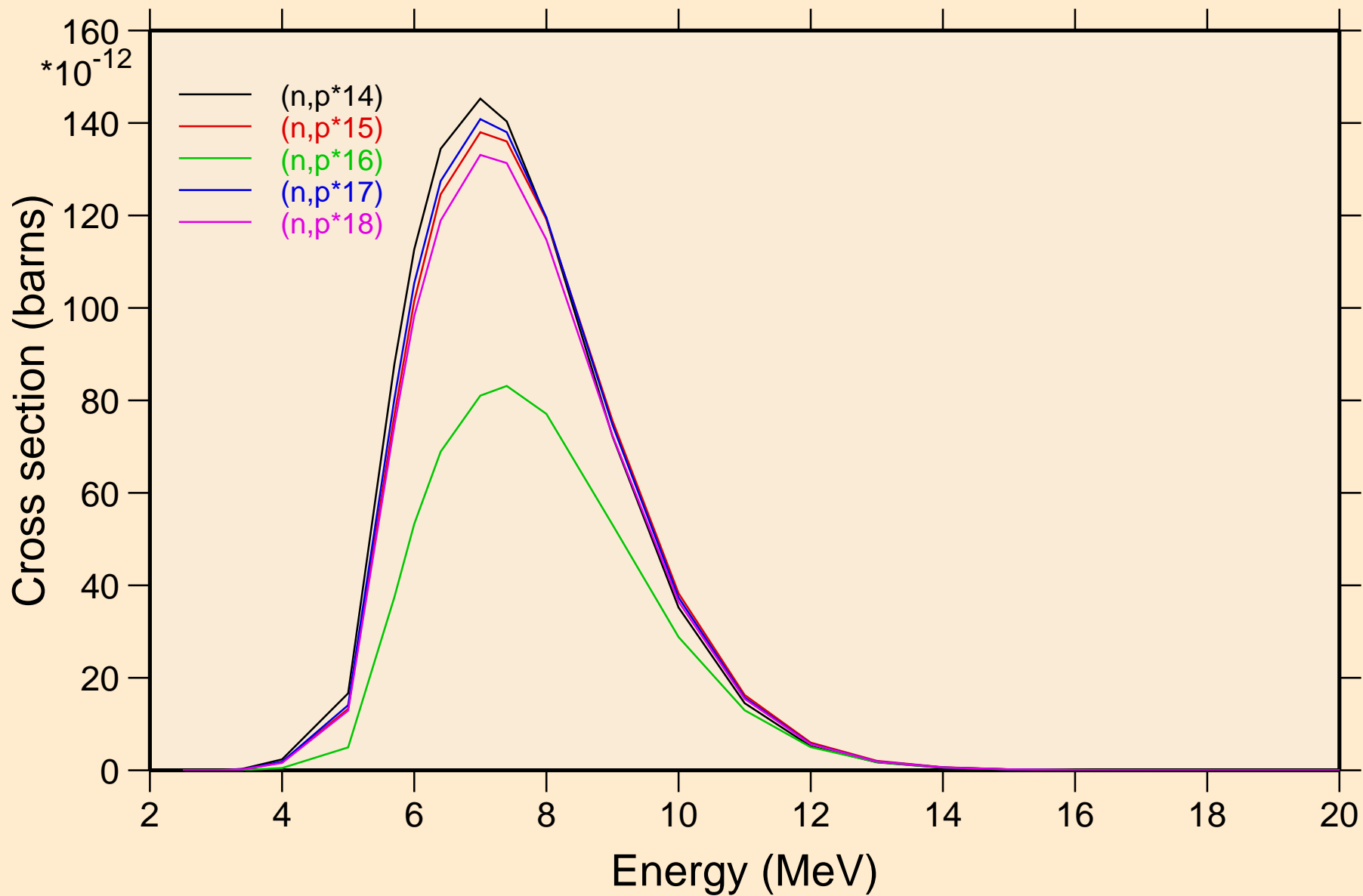

ENDF/B-VII.1 PA-231

Threshold reactions

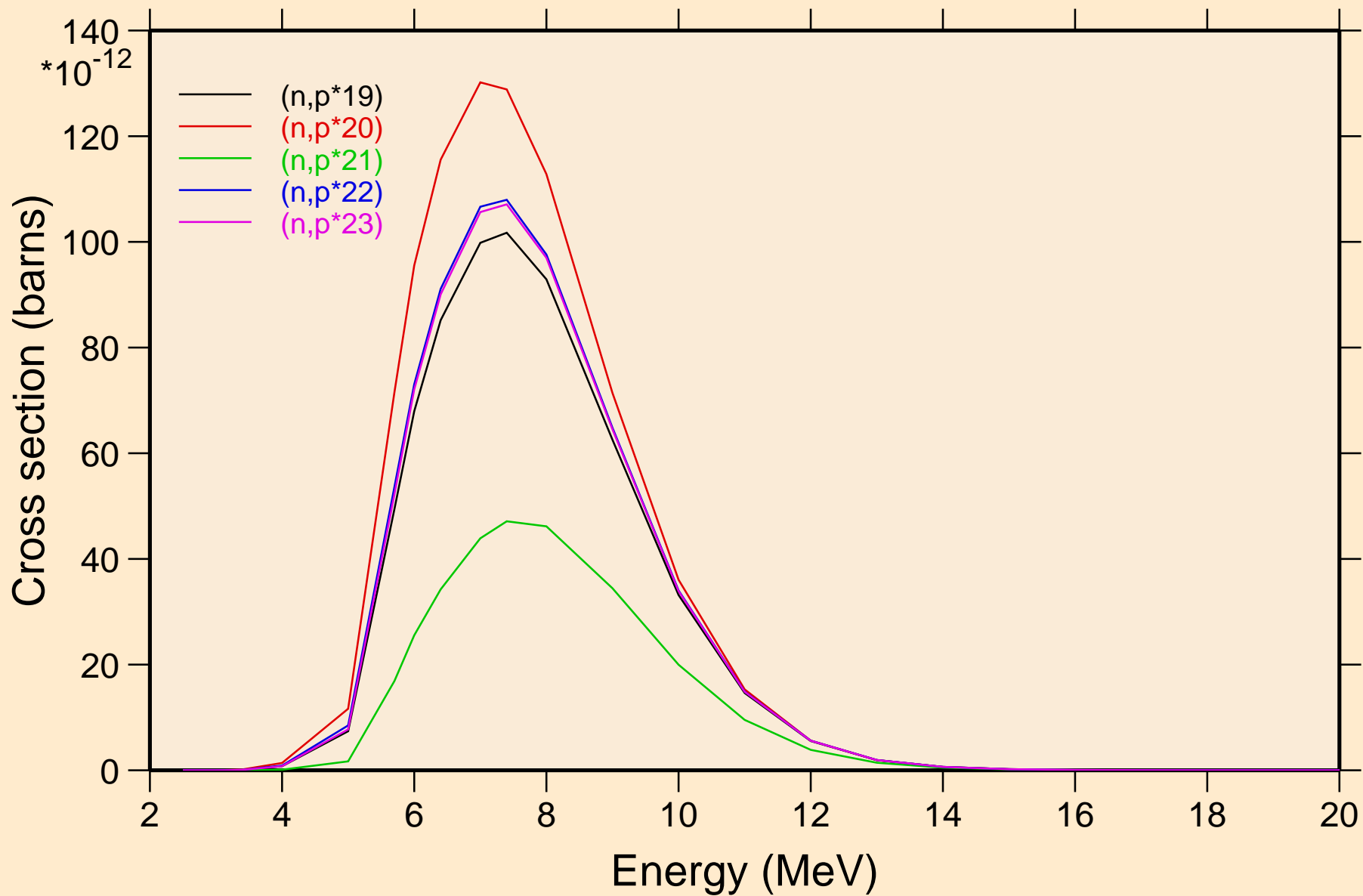

ENDF/B-VII.1 PA-231

Threshold reactions

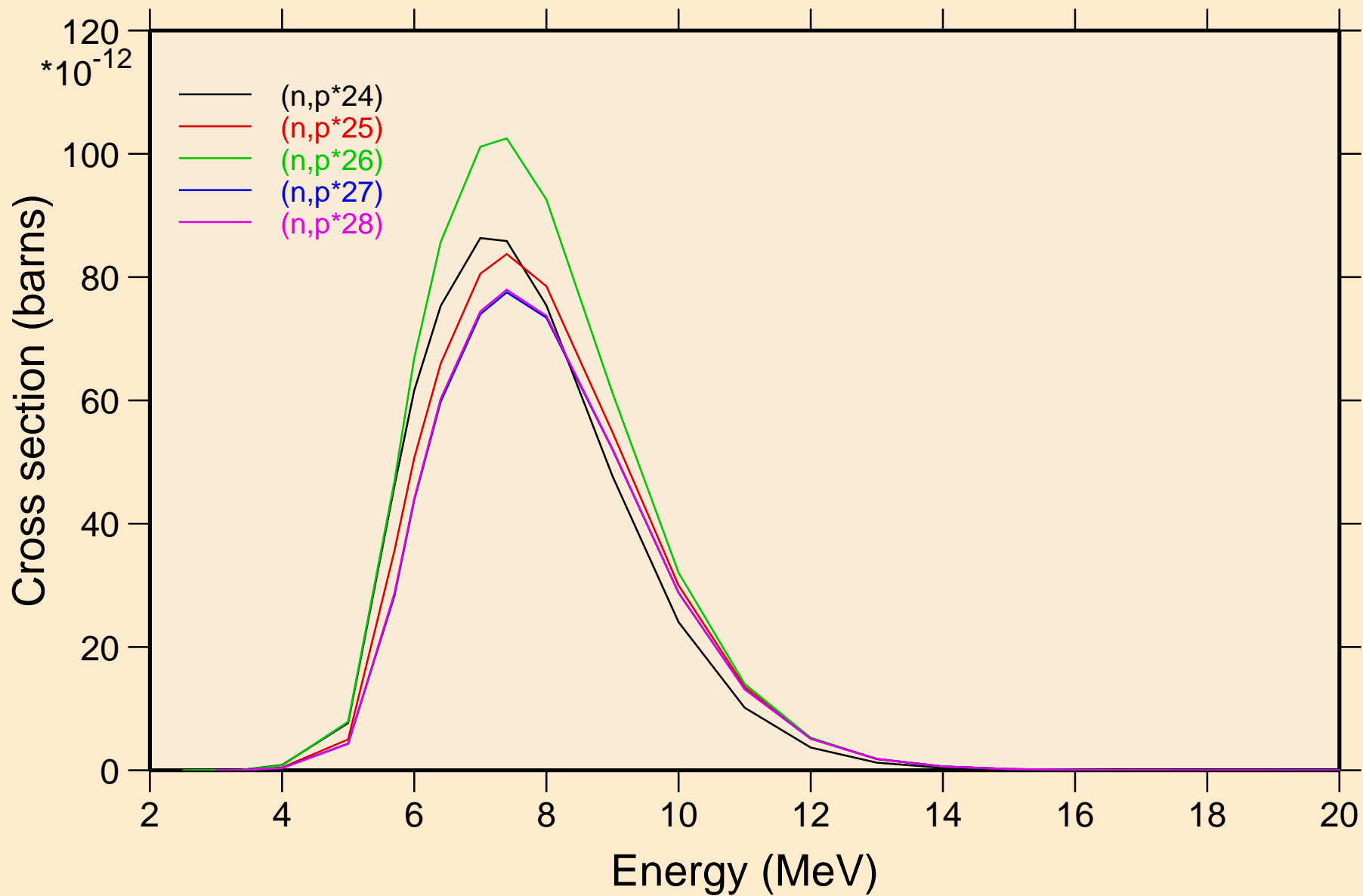

ENDF/B-VII.1 PA-231

Threshold reactions

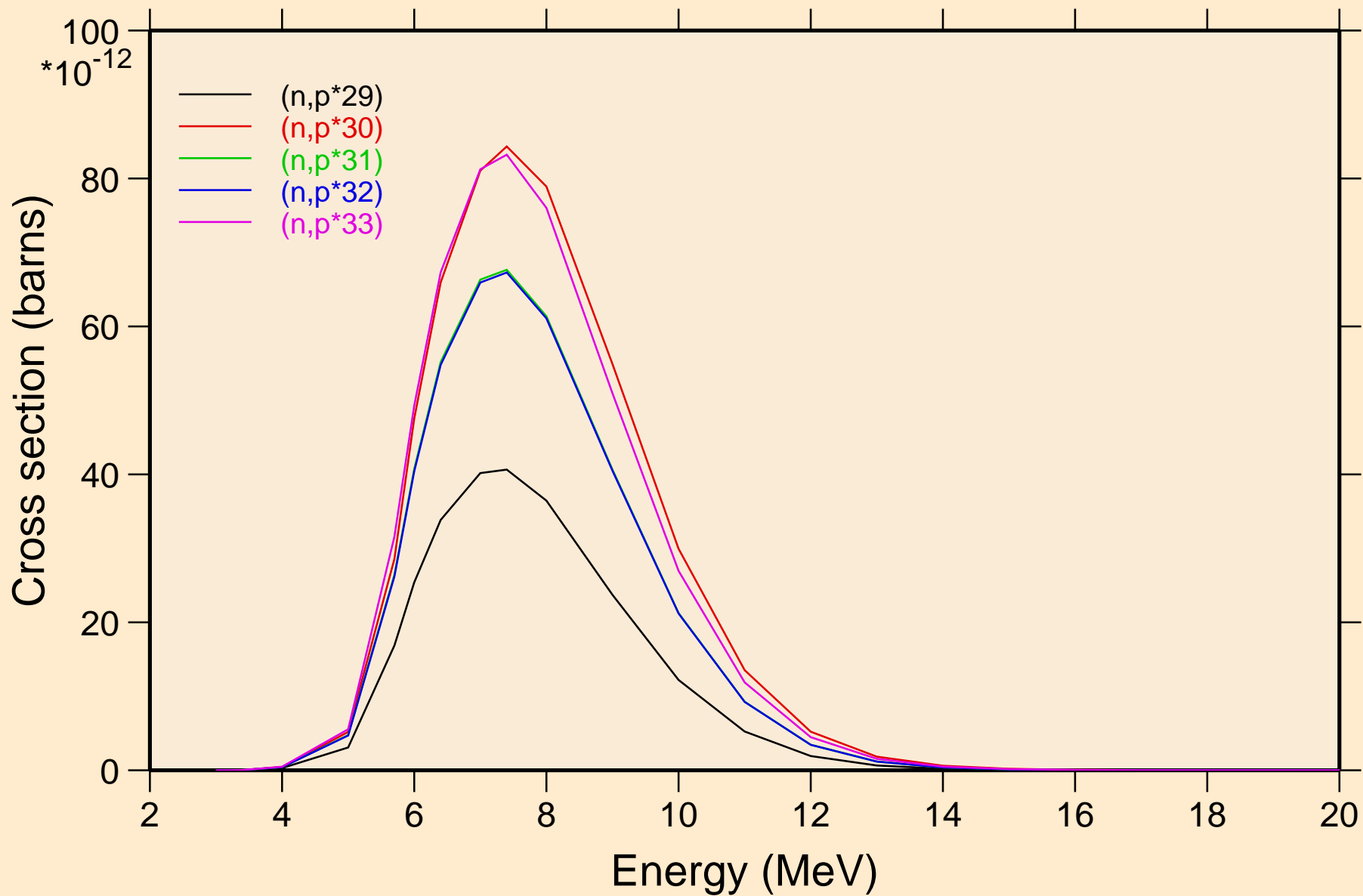

ENDF/B-VII.1 PA-231

Threshold reactions

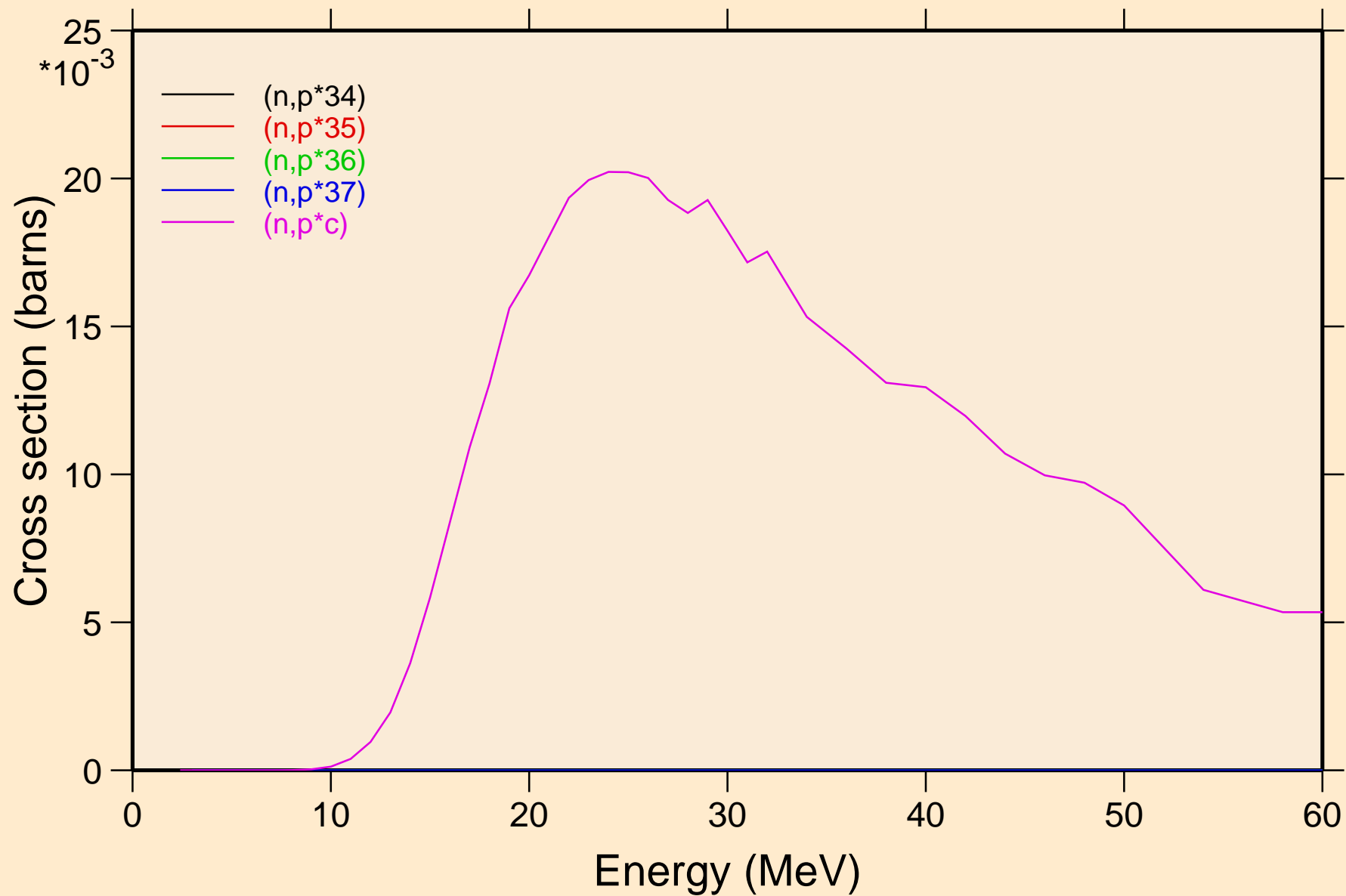

ENDF/B-VII.1 PA-231
angular distribution for elastic

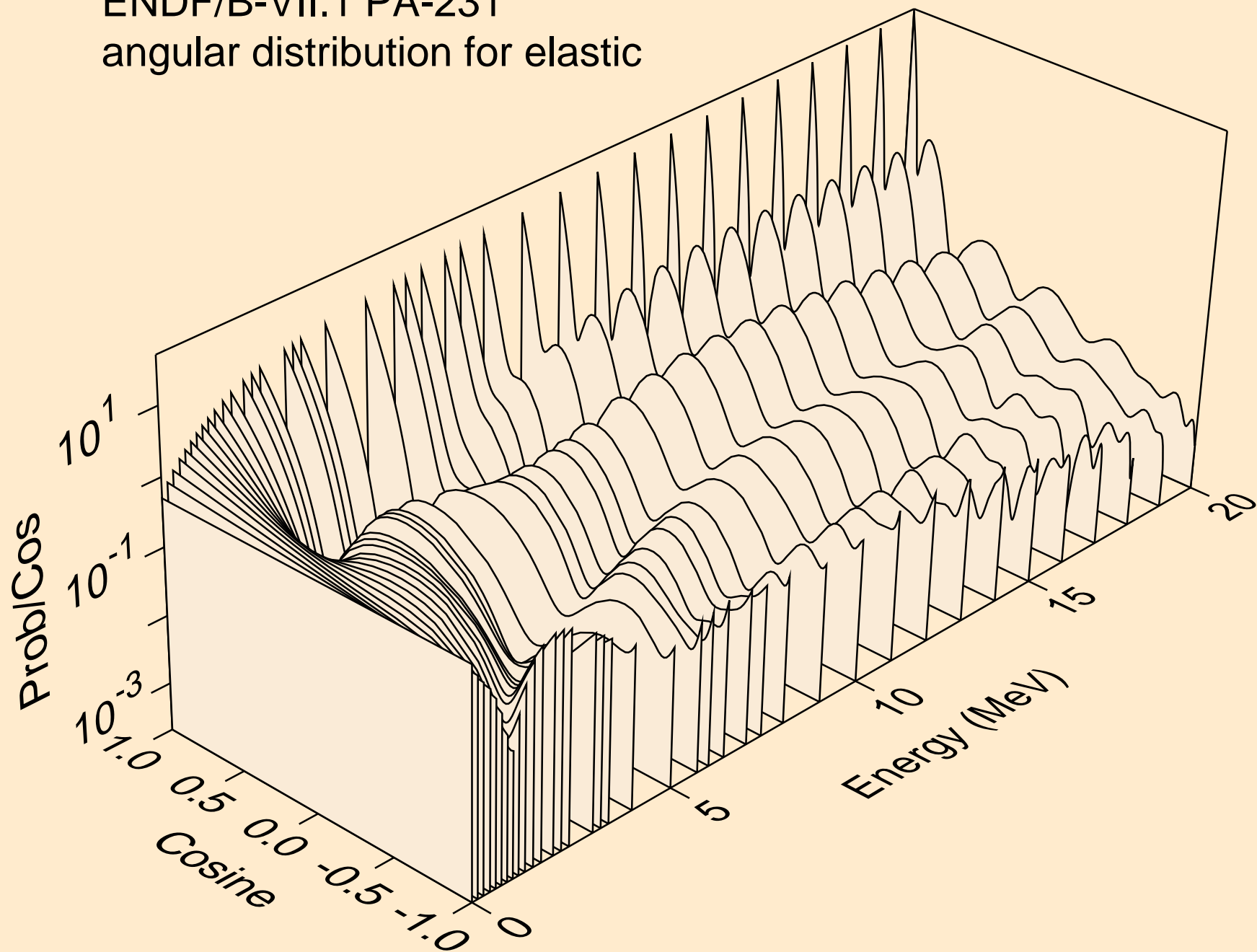

ENDF/B-VII.1 PA-231
angular distribution for elastic

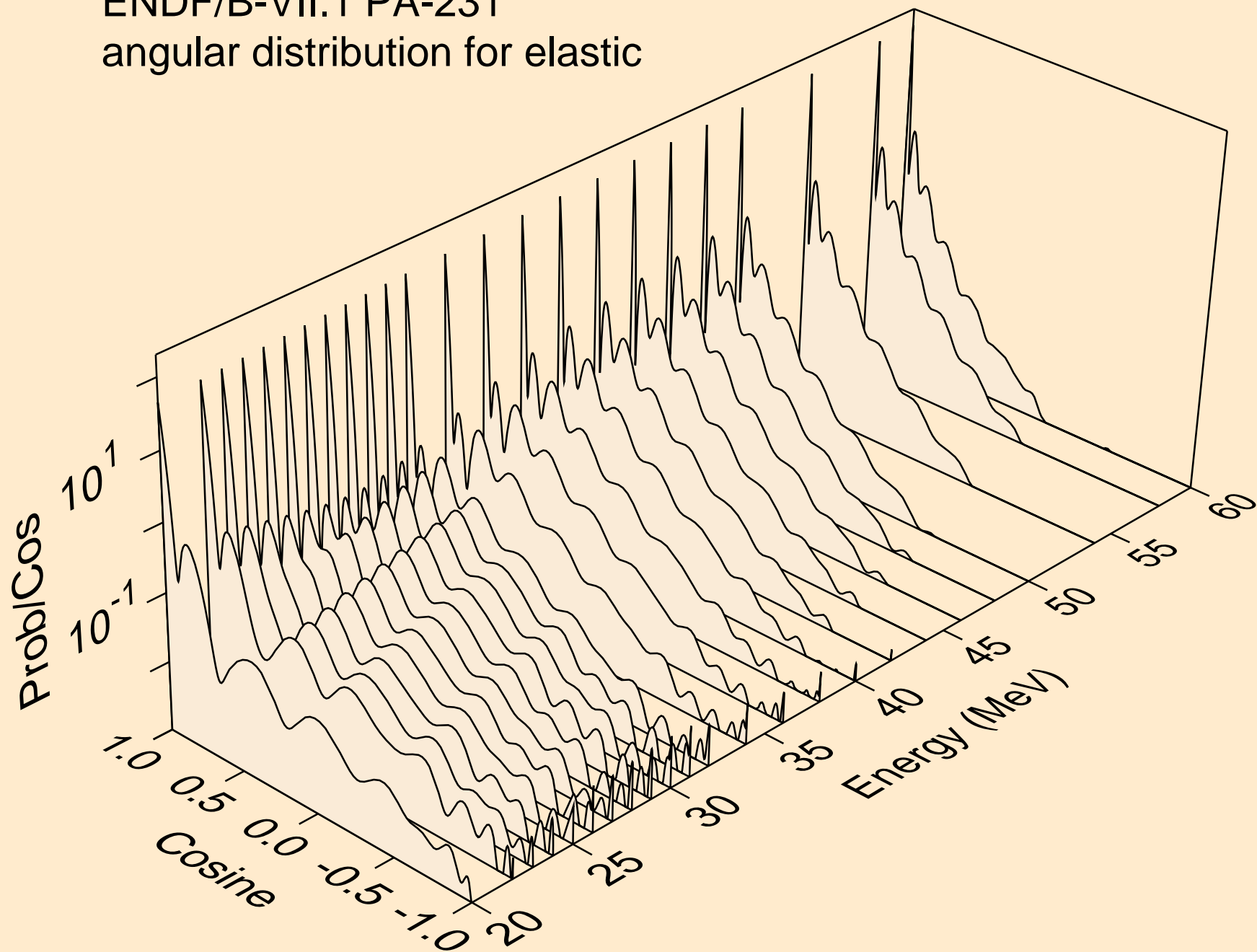

ENDF/B-VII.1 PA-231

Total fission nubar

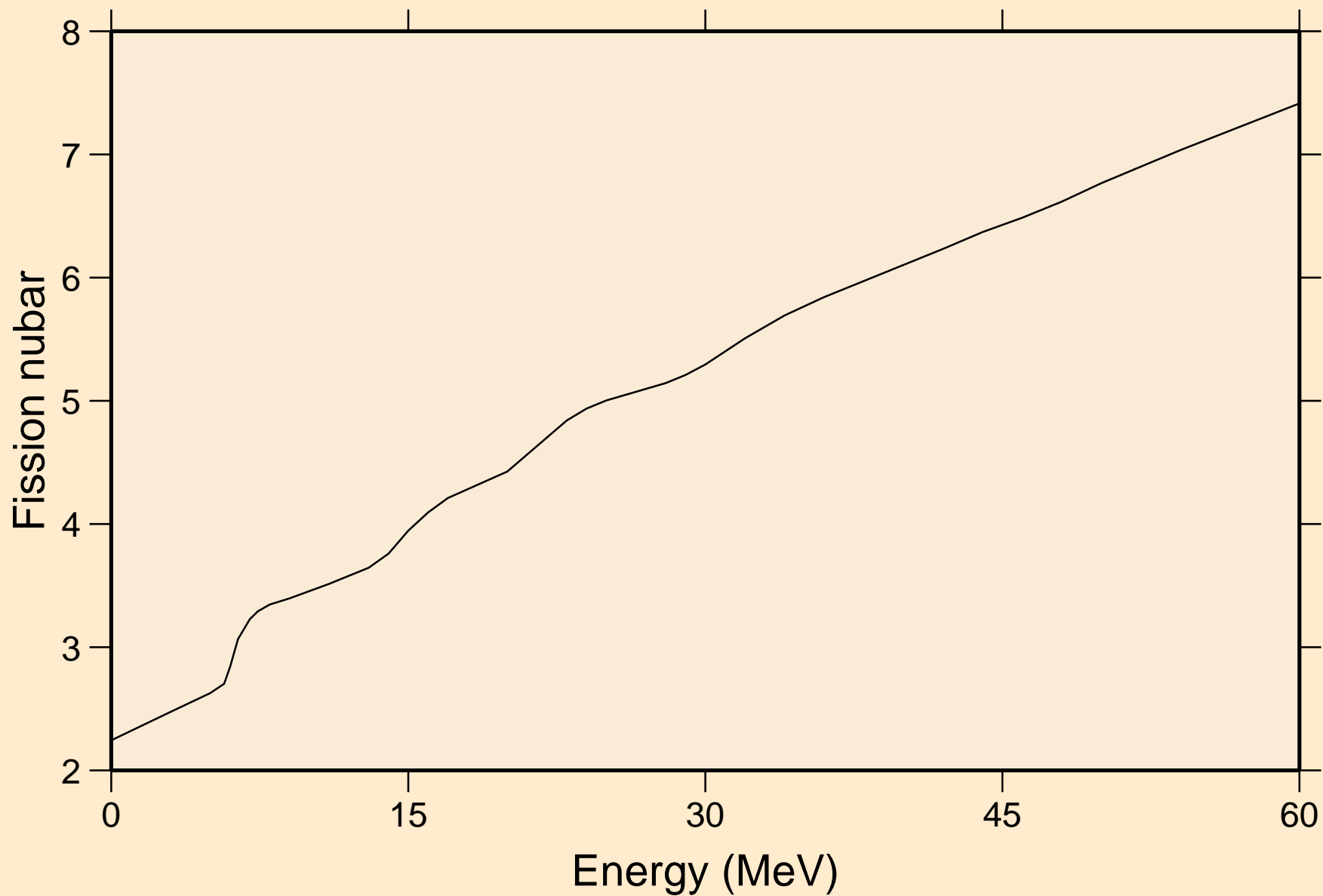

ENDF/B-VII.1 PA-231

Delayed nubar

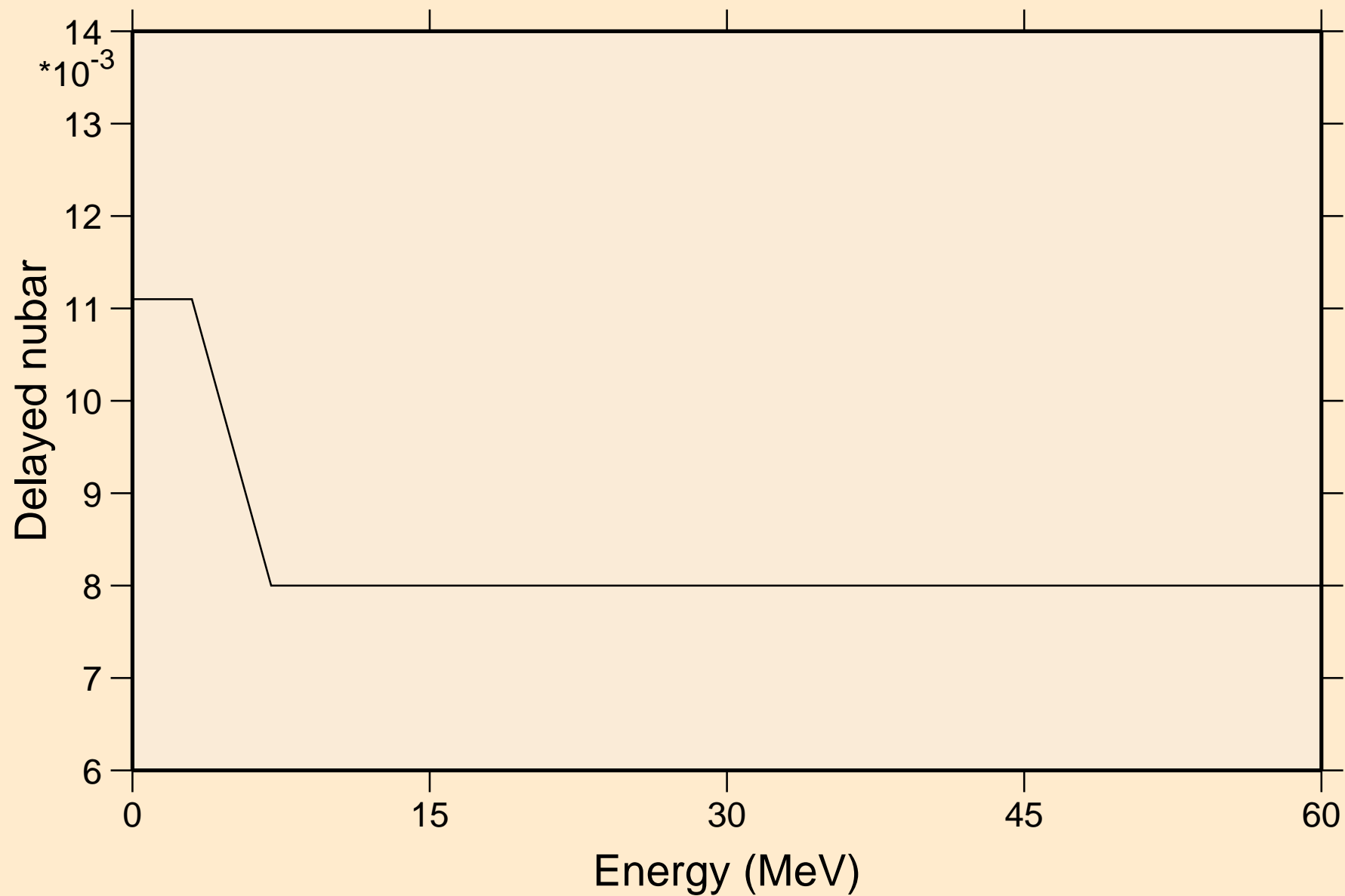

ENDF/B-VII.1 PA-231

Delayed neutron spectra

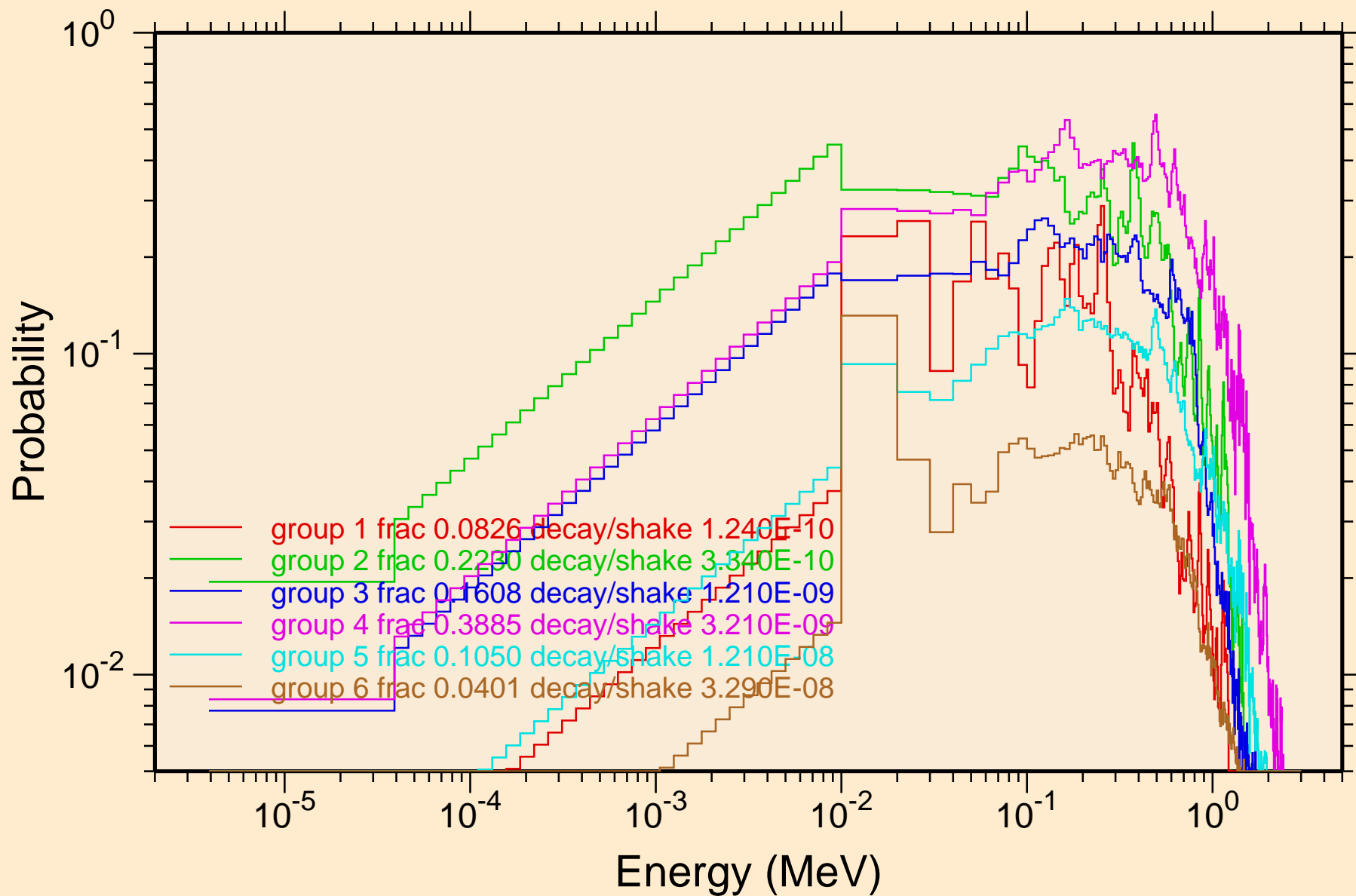

ENDF/B-VII.1 PA-231
Photon emission for (n,x)

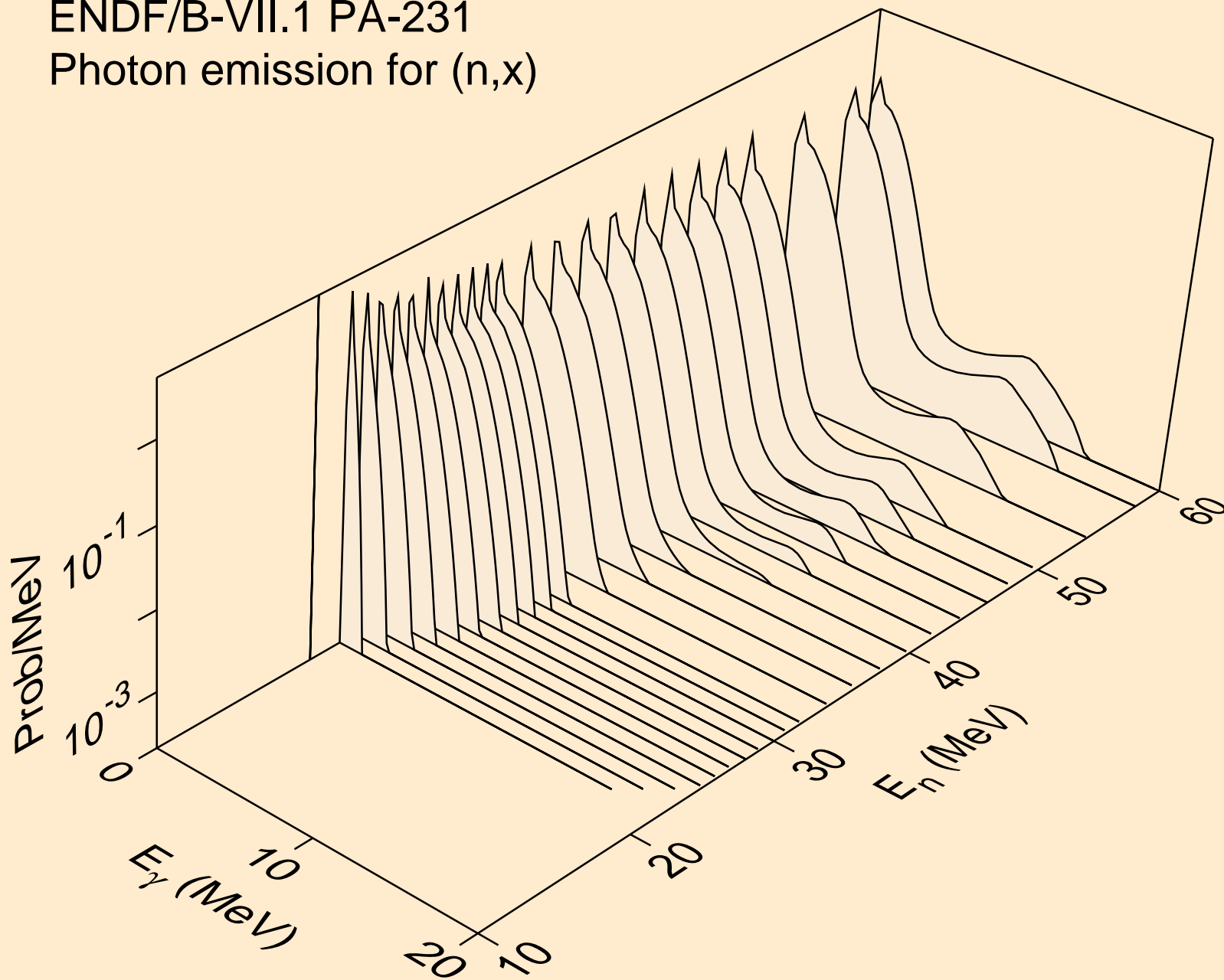

ENDF/B-VII.1 PA-231
Photon emission for (n,2n)

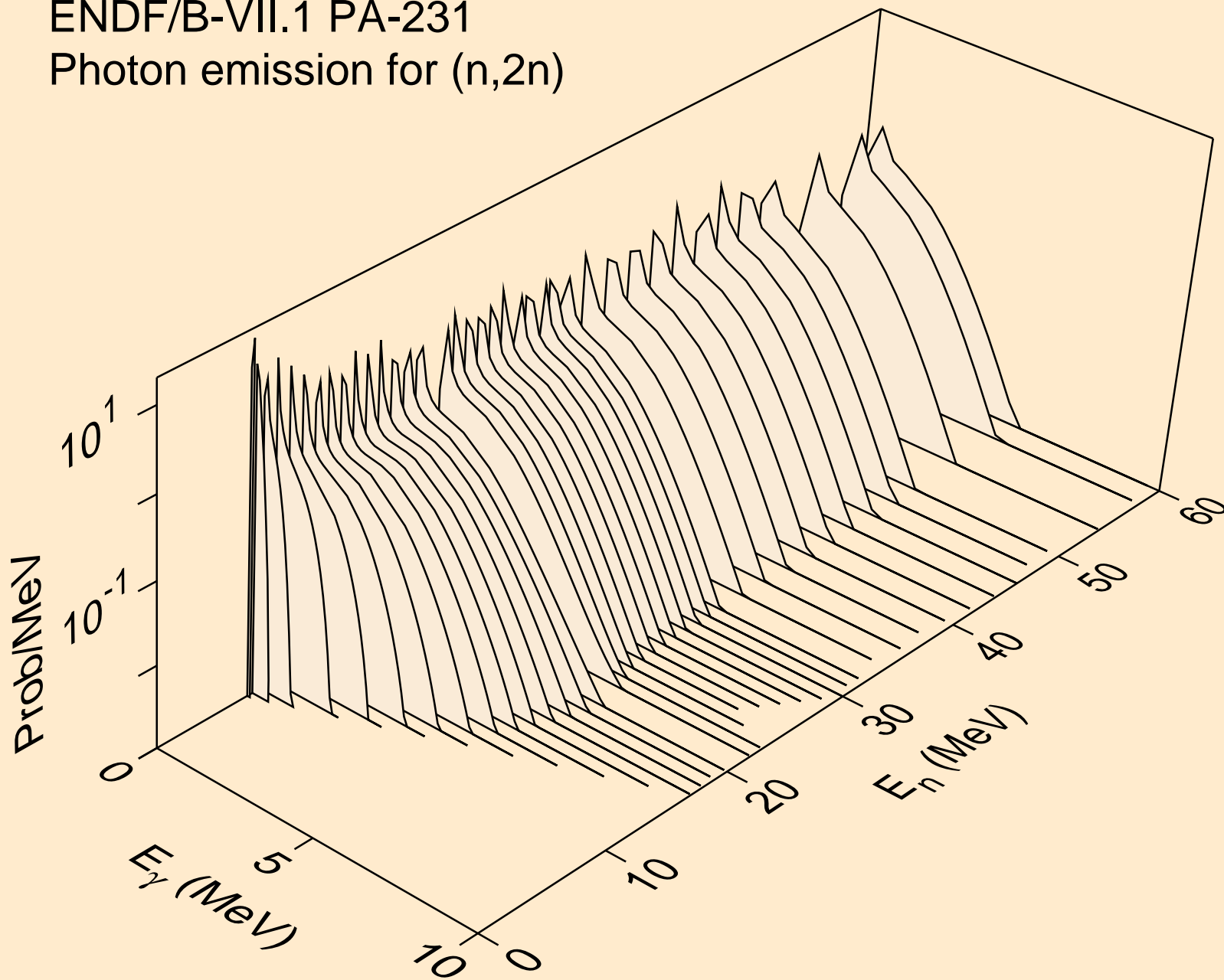

ENDF/B-VII.1 PA-231
Photon emission for (n,3n)

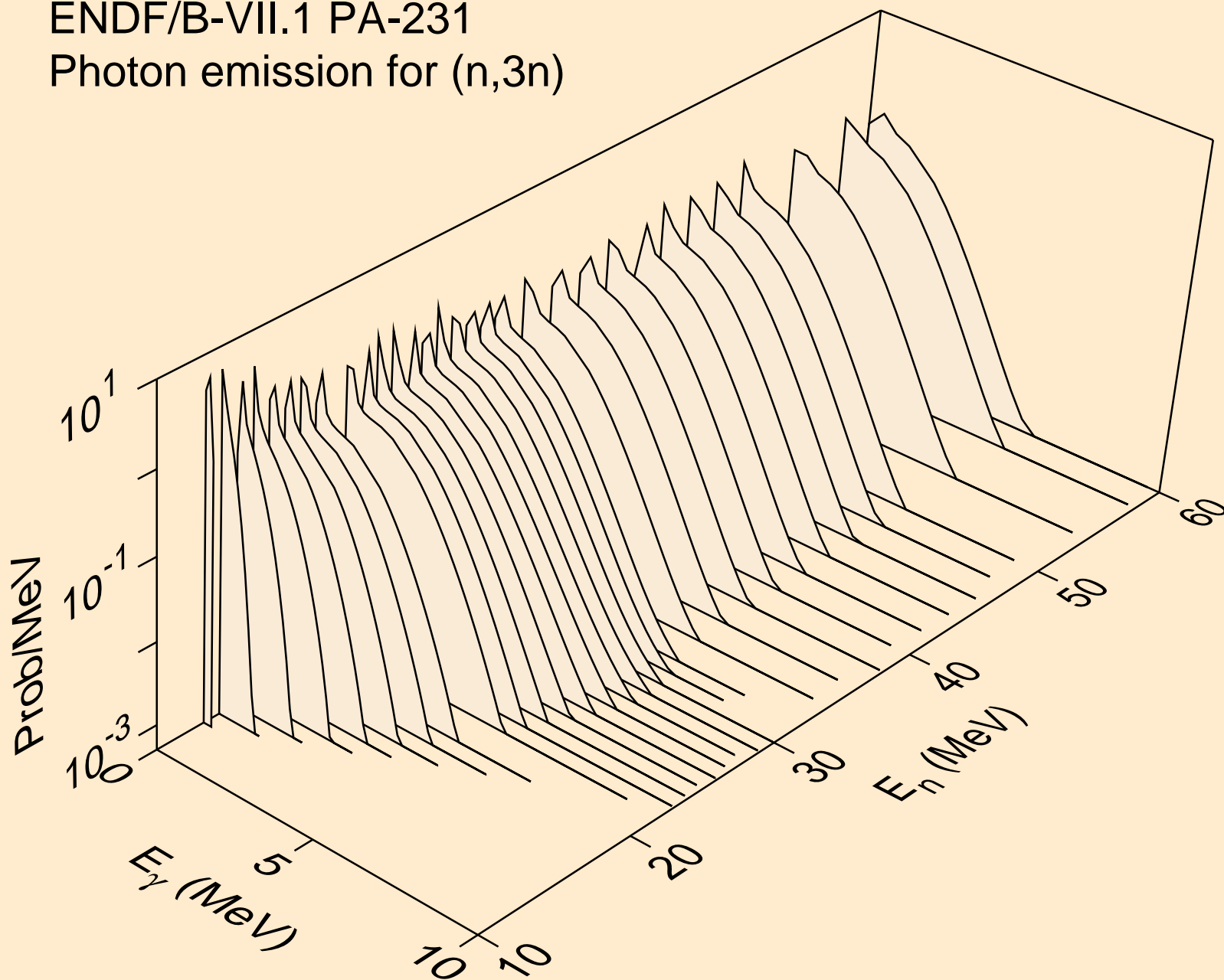

ENDF/B-VII.1 PA-231
Photon emission for fission

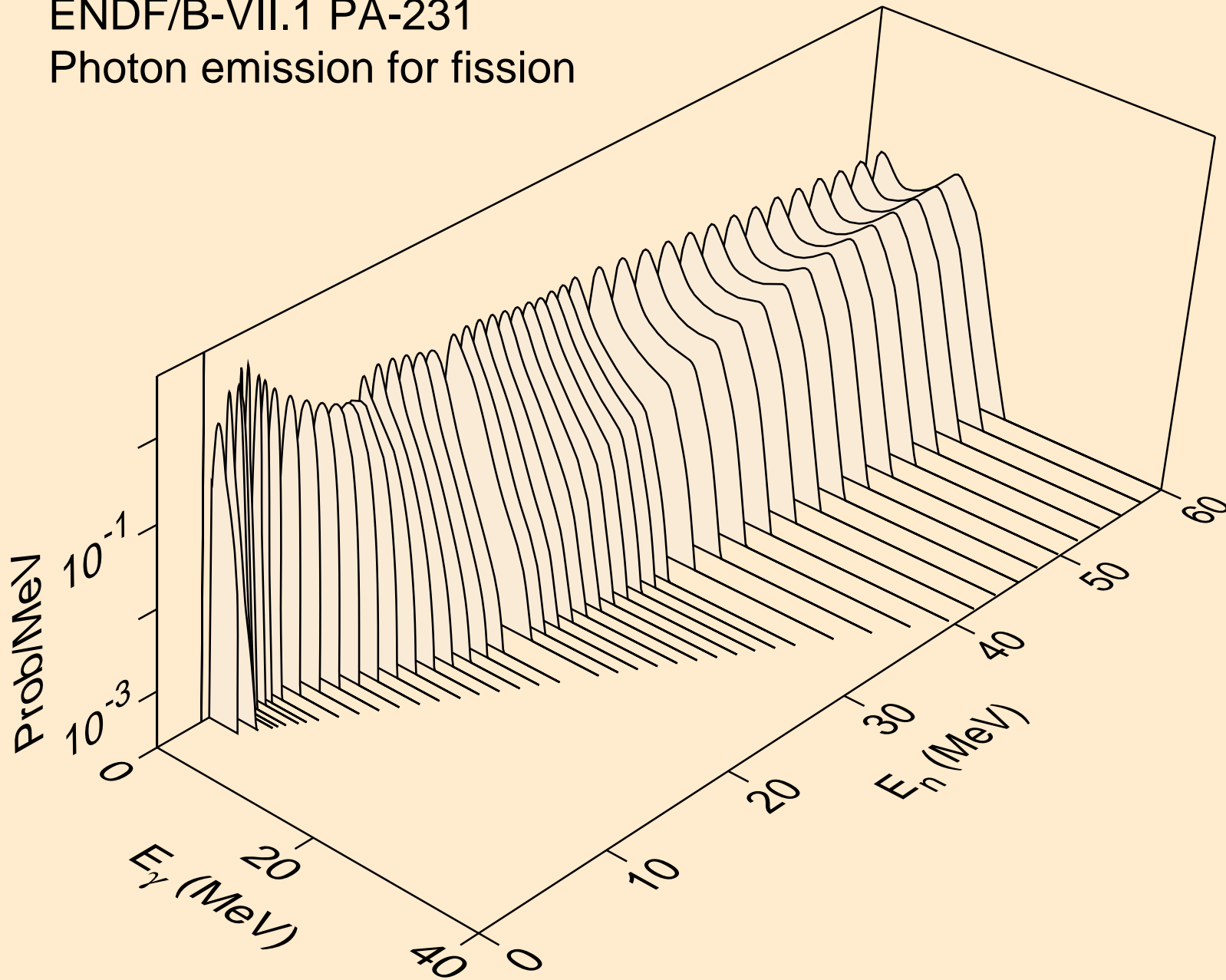

ENDF/B-VII.1 PA-231
Photon emission for (n,n*)p

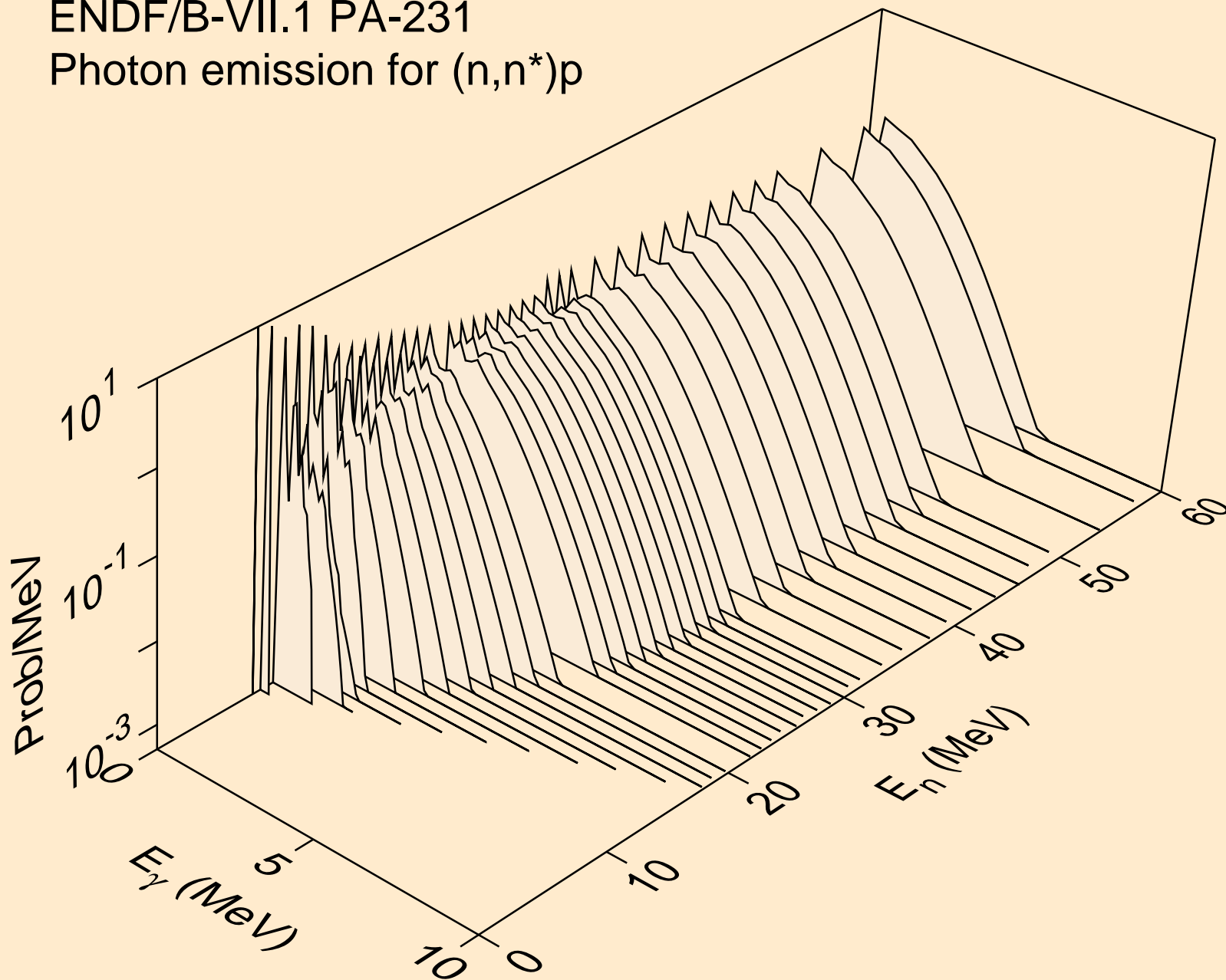

ENDF/B-VII.1 PA-231
Photon emission for (n,2np)

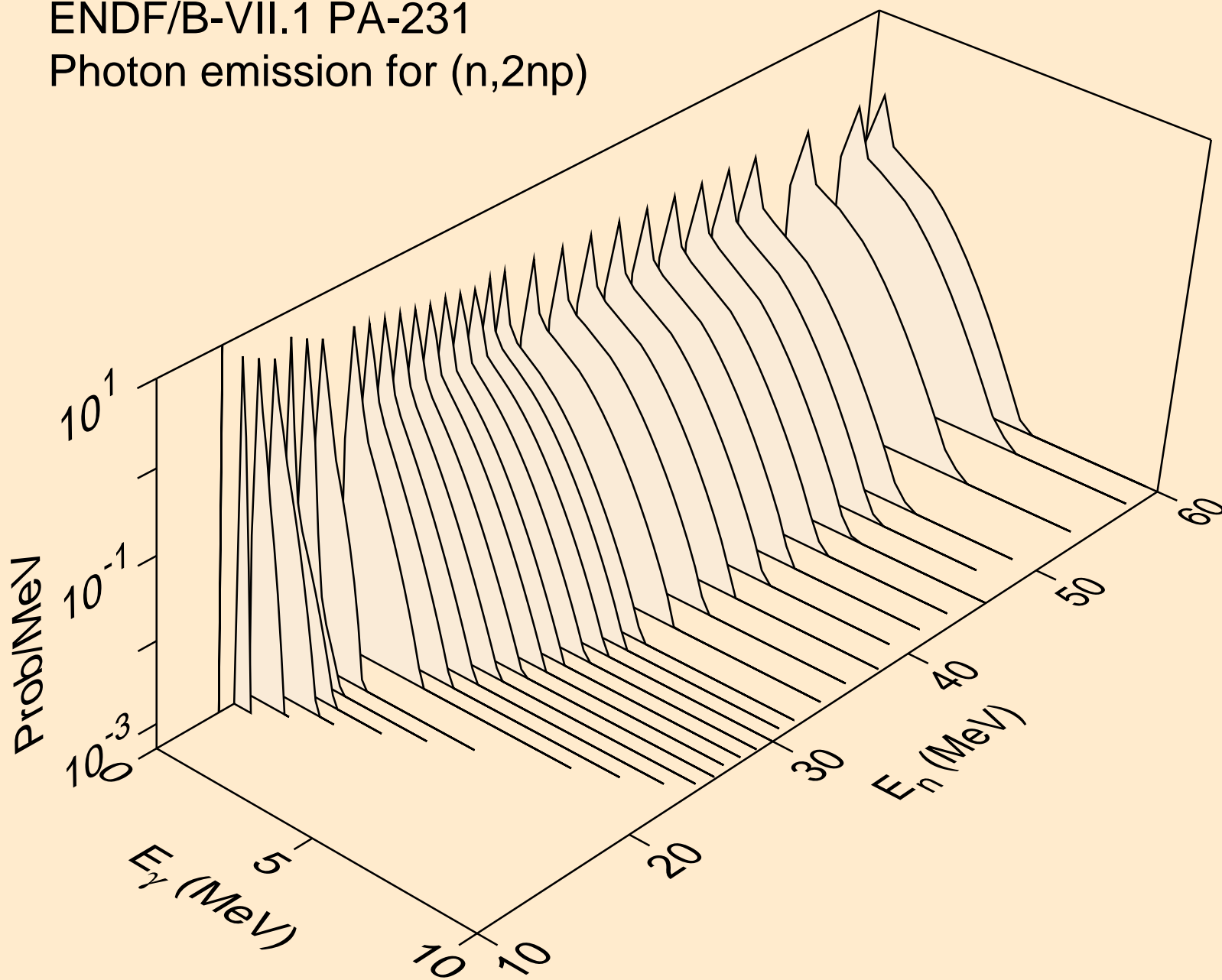

ENDF/B-VII.1 PA-231
Photon emission for (n,n*c)

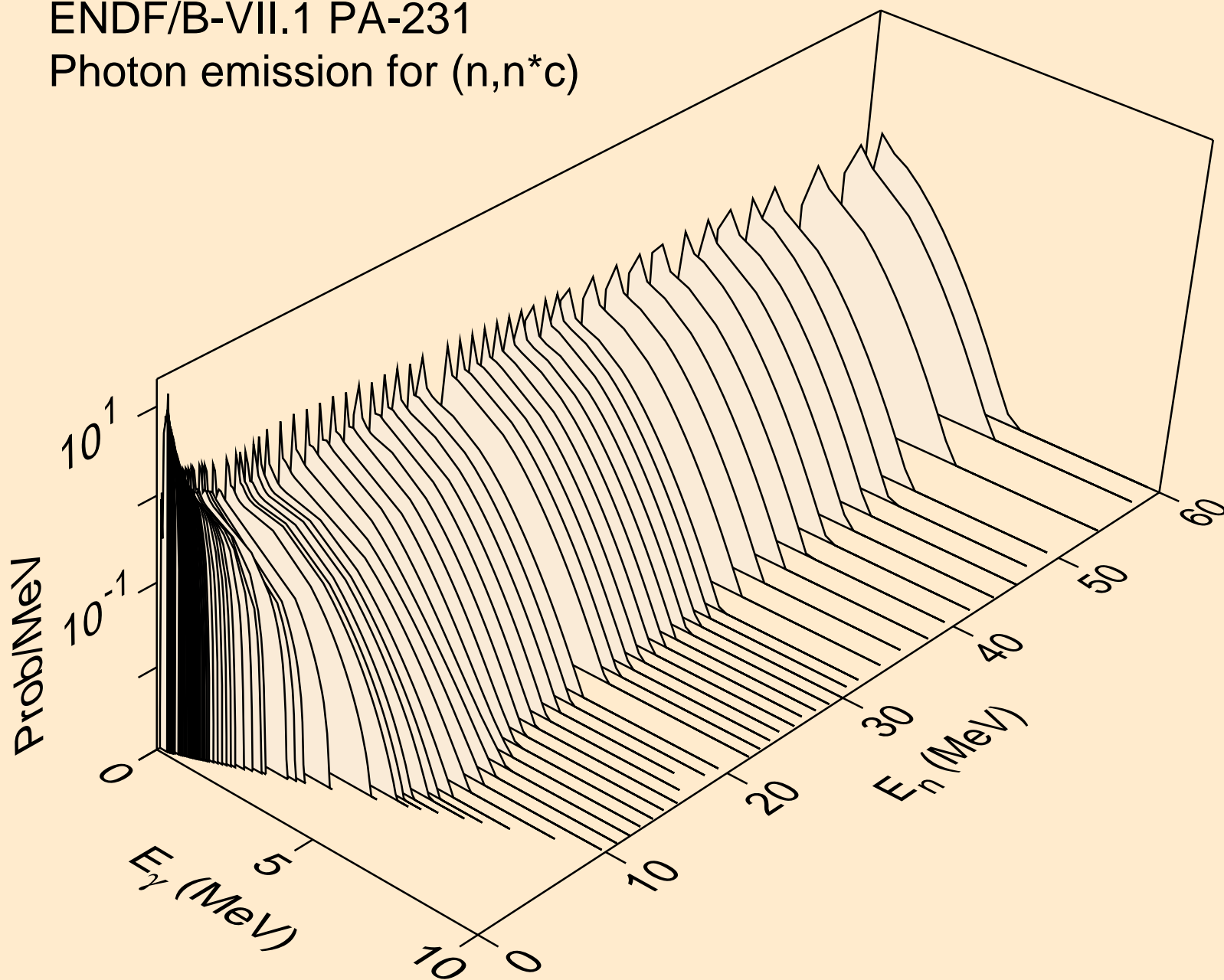

ENDF/B-VII.1 PA-231
Photon emission for (n,gma)

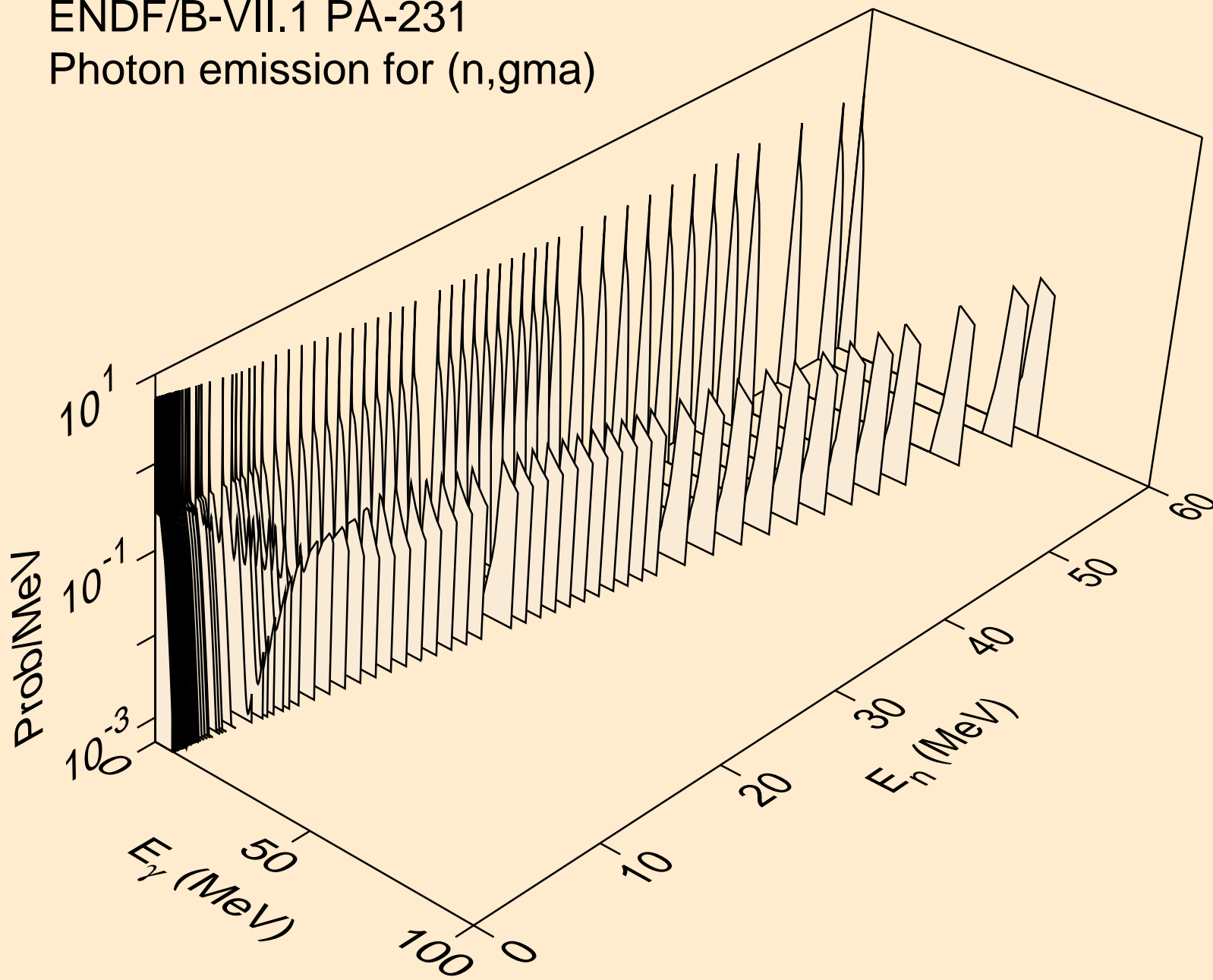

ENDF/B-VII.1 PA-231
Photon emission for (n,p*c)

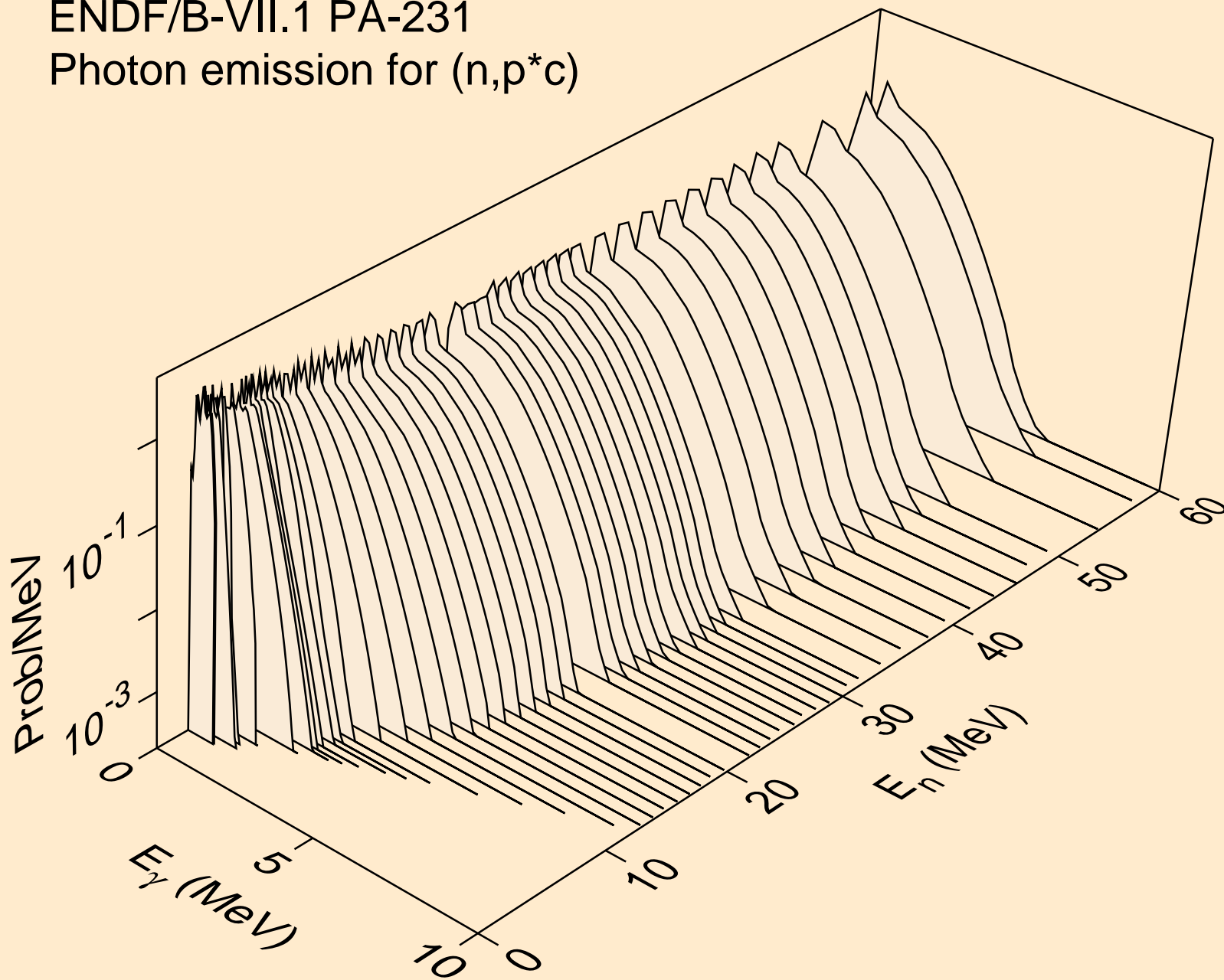

ENDF/B-VII.1 PA-231
thermal capture photon spectrum

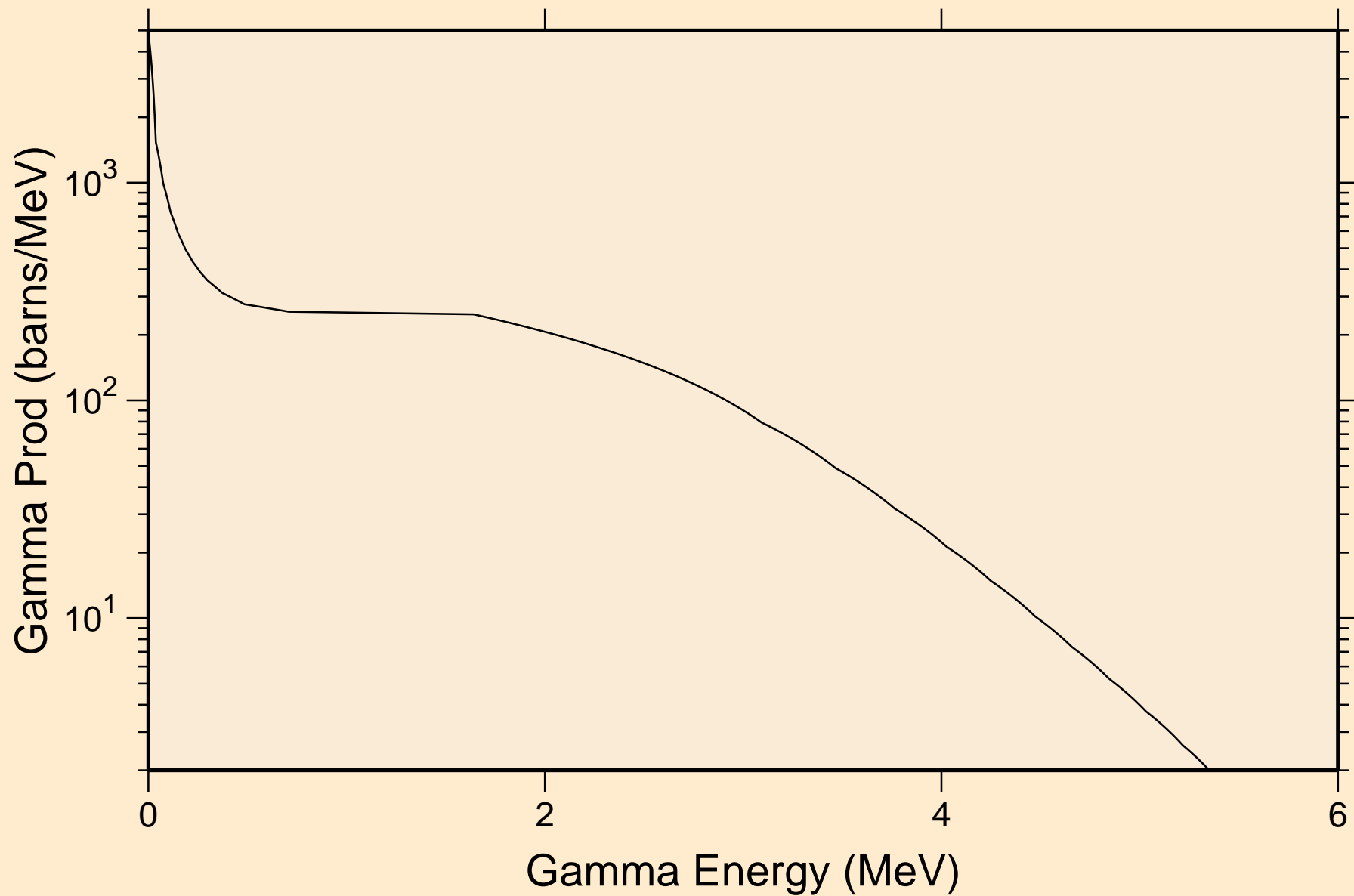

ENDF/B-VII.1 PA-231
14 MeV photon spectrum

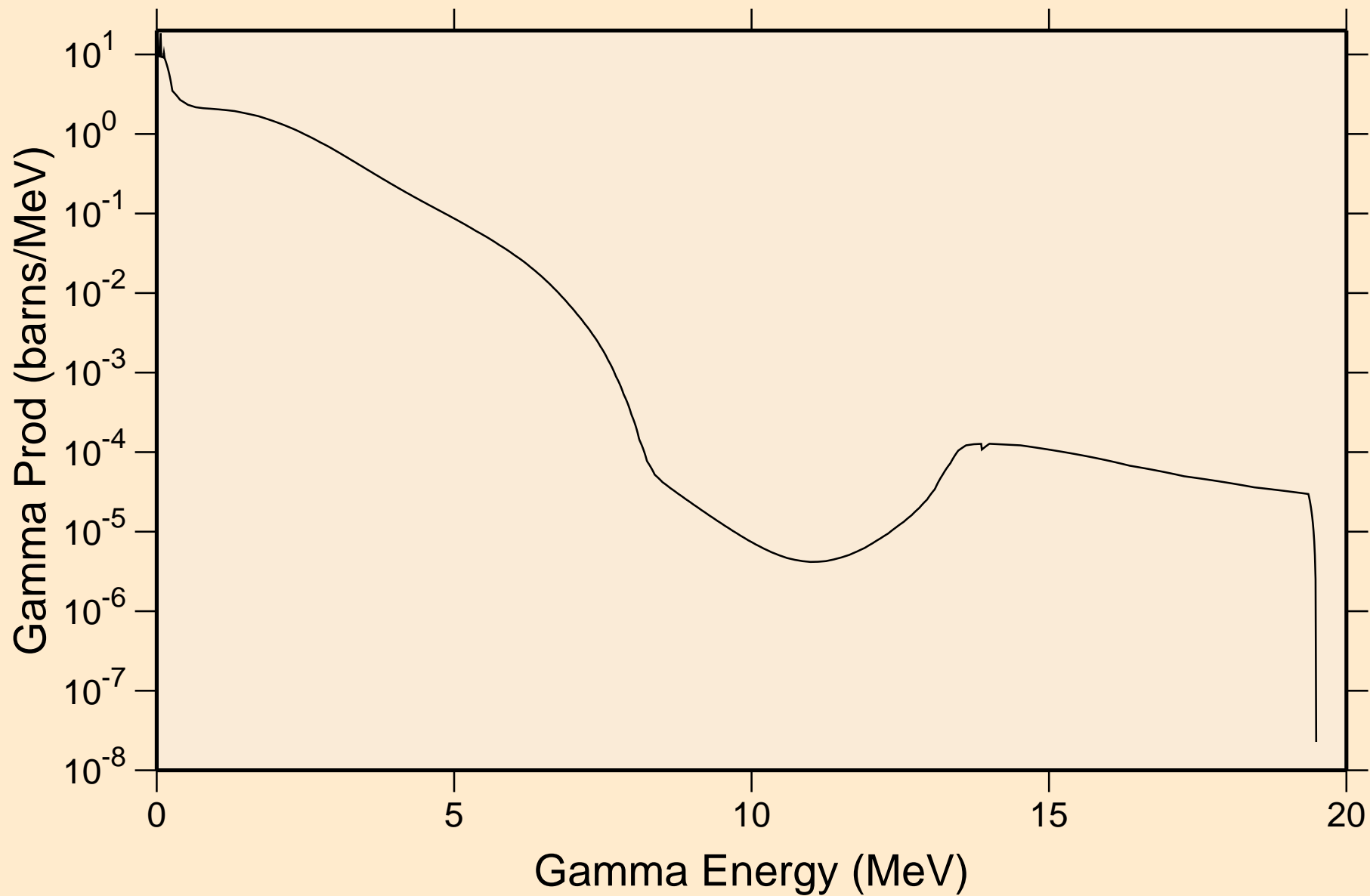

ENDF/B-VII.1 PA-231

Particle heating contributions

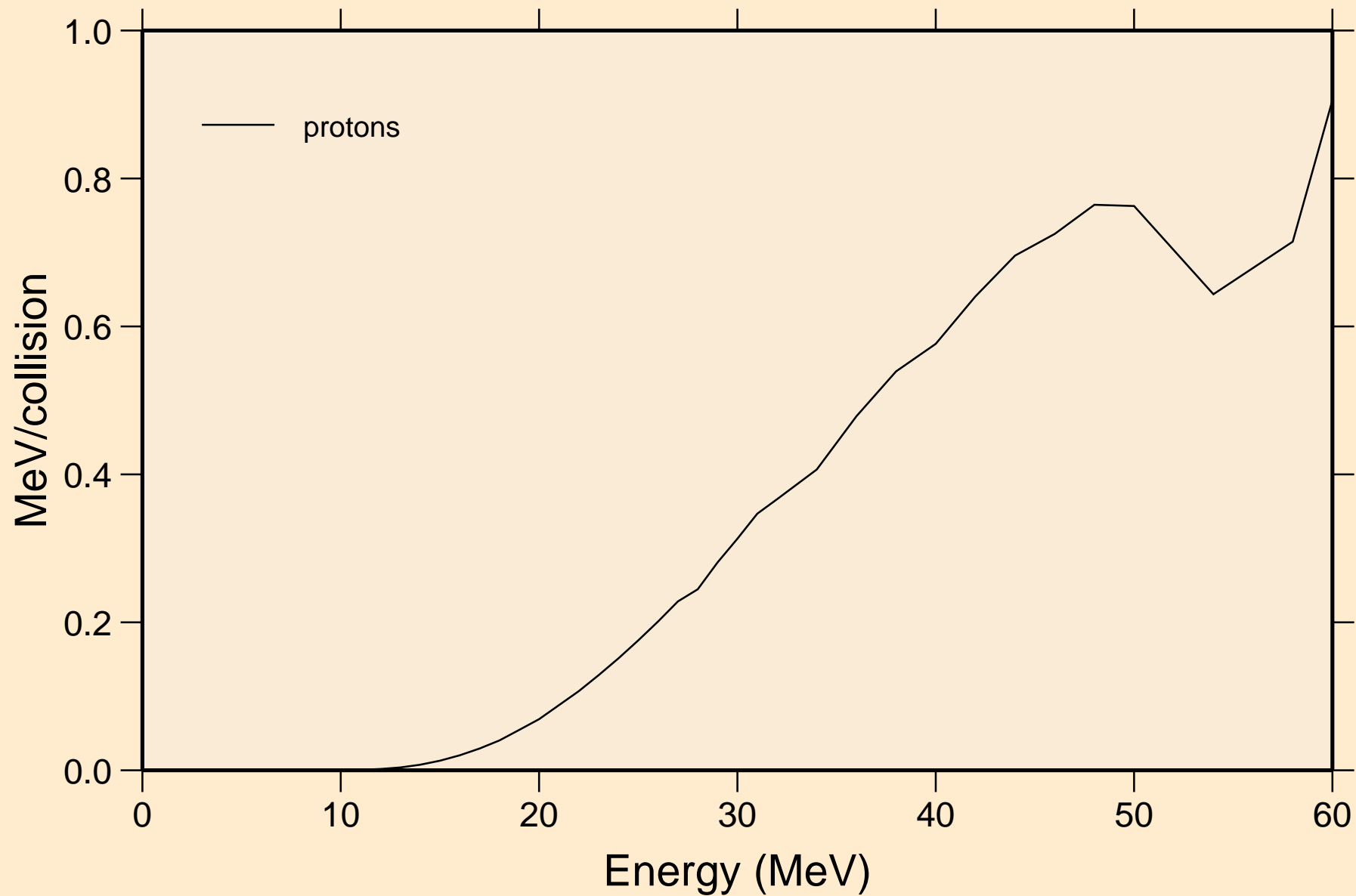

ENDF/B-VII.1 PA-231

Recoil Heating

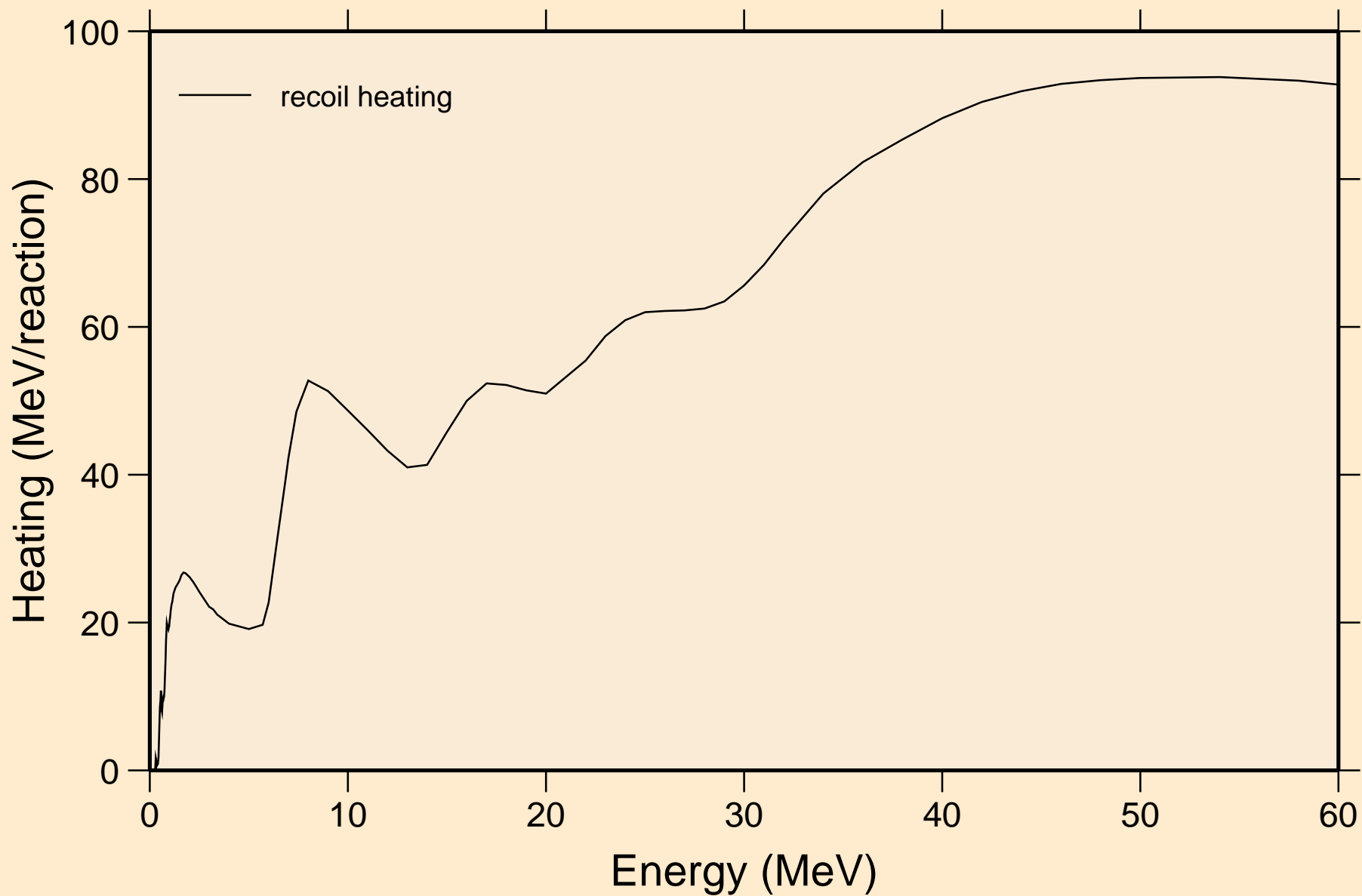

ENDF/B-VII.1 PA-231

Particle production cross sections

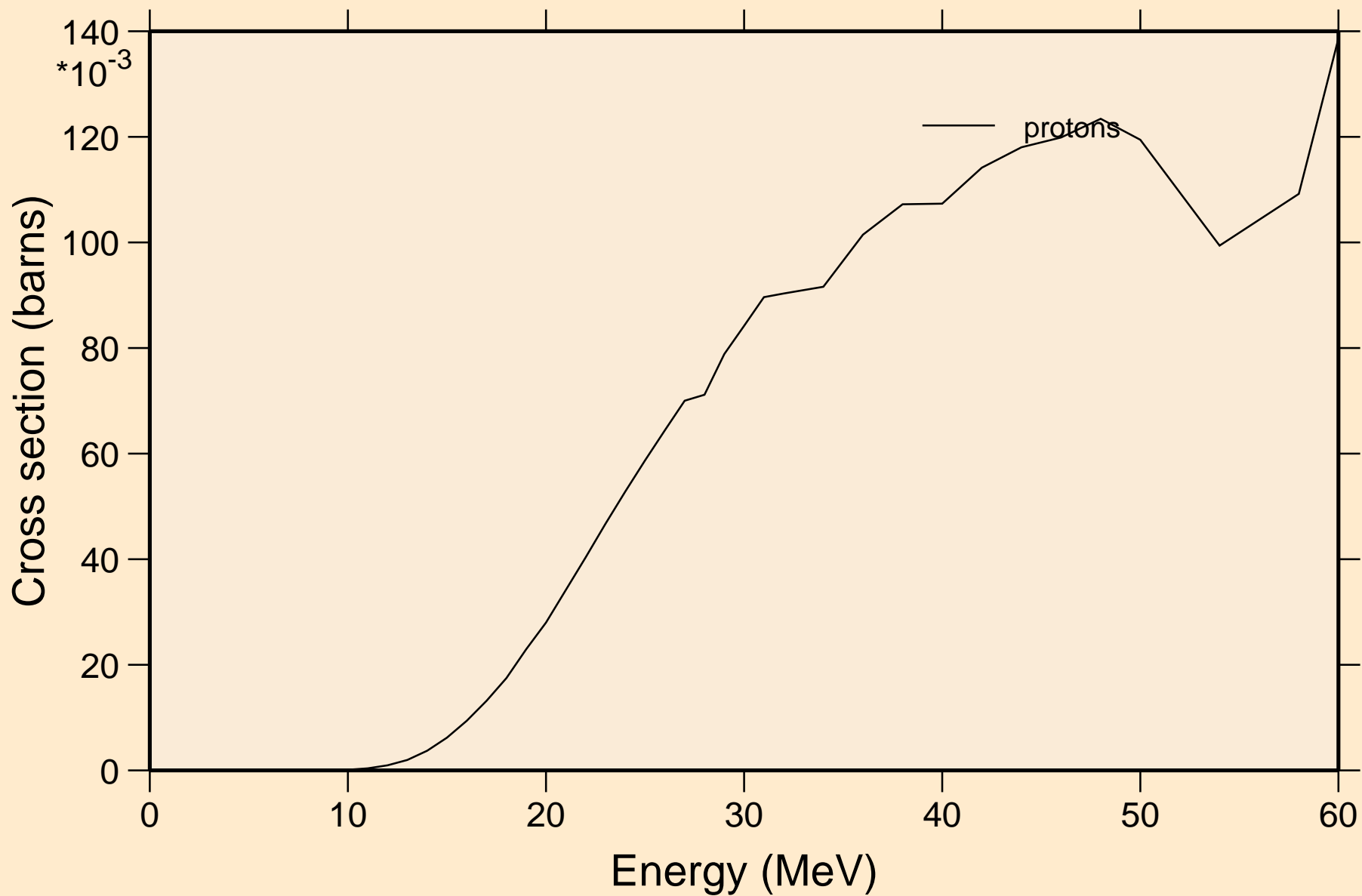

ENDF/B-VII.1 PA-231
protons from (n,x)

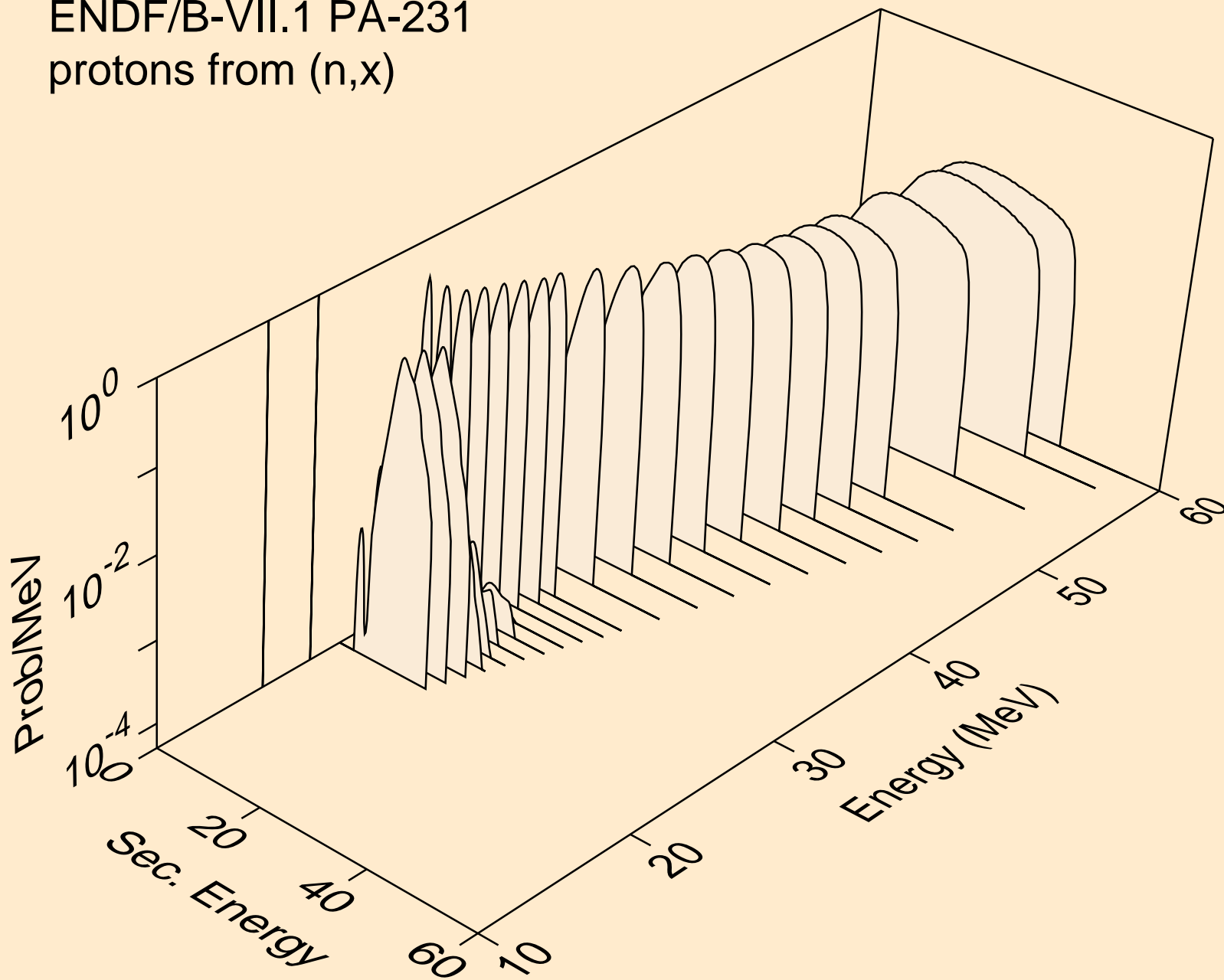

ENDF/B-VII.1 PA-231
protons from (n,n*)p

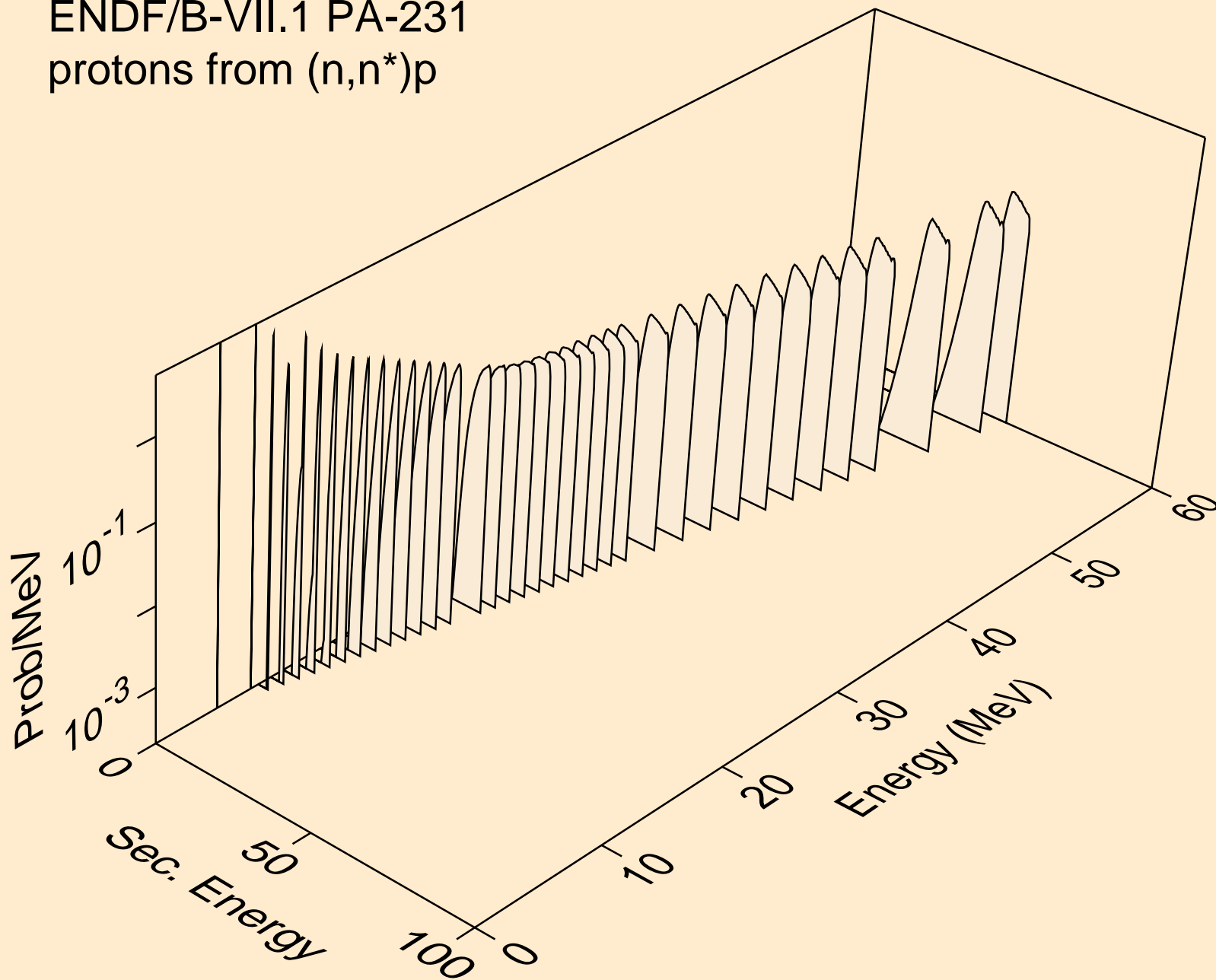

ENDF/B-VII.1 PA-231
protons from (n,2np)

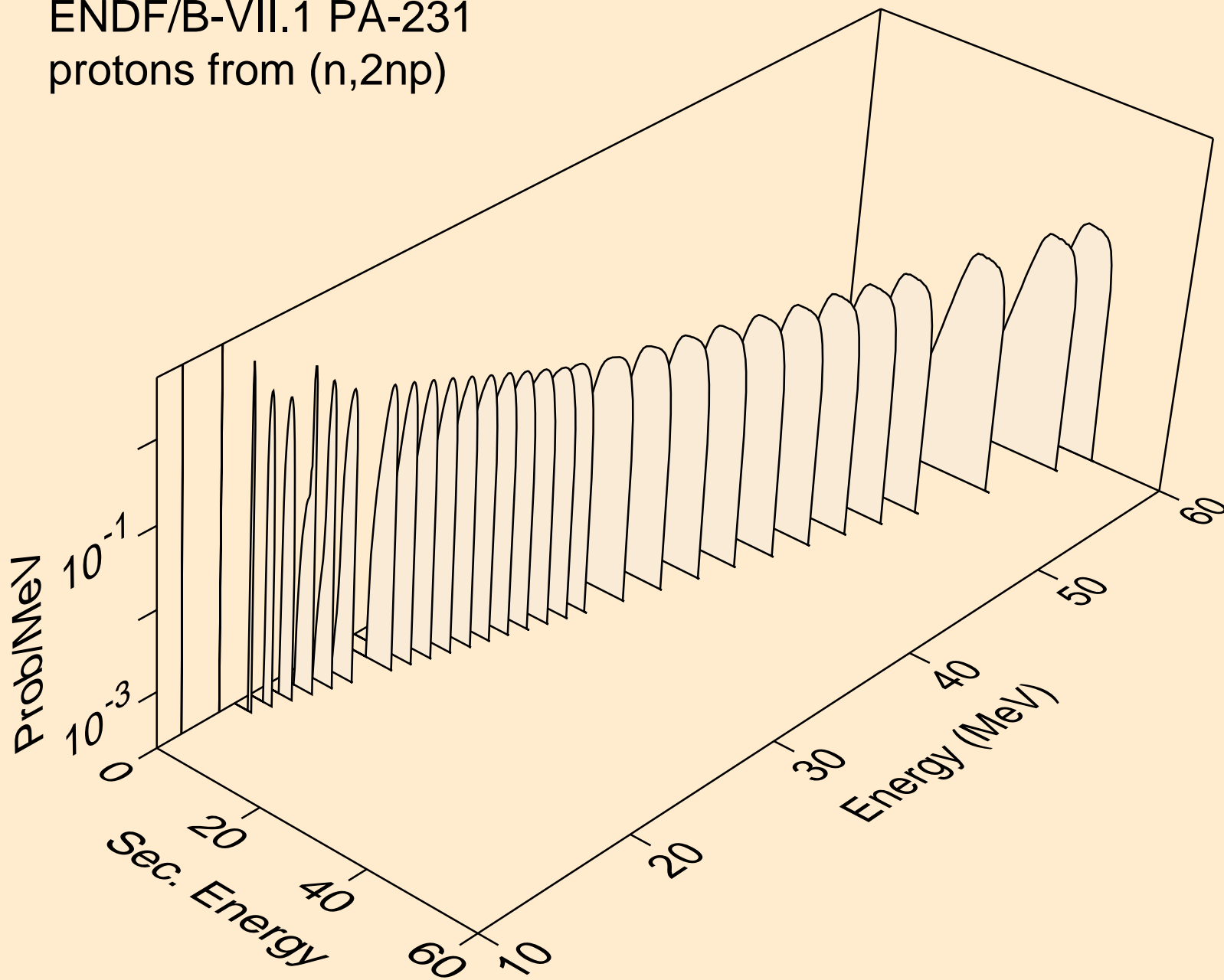

ENDF/B-VII.1 PA-231

angular distribution for (n,p*0) proton

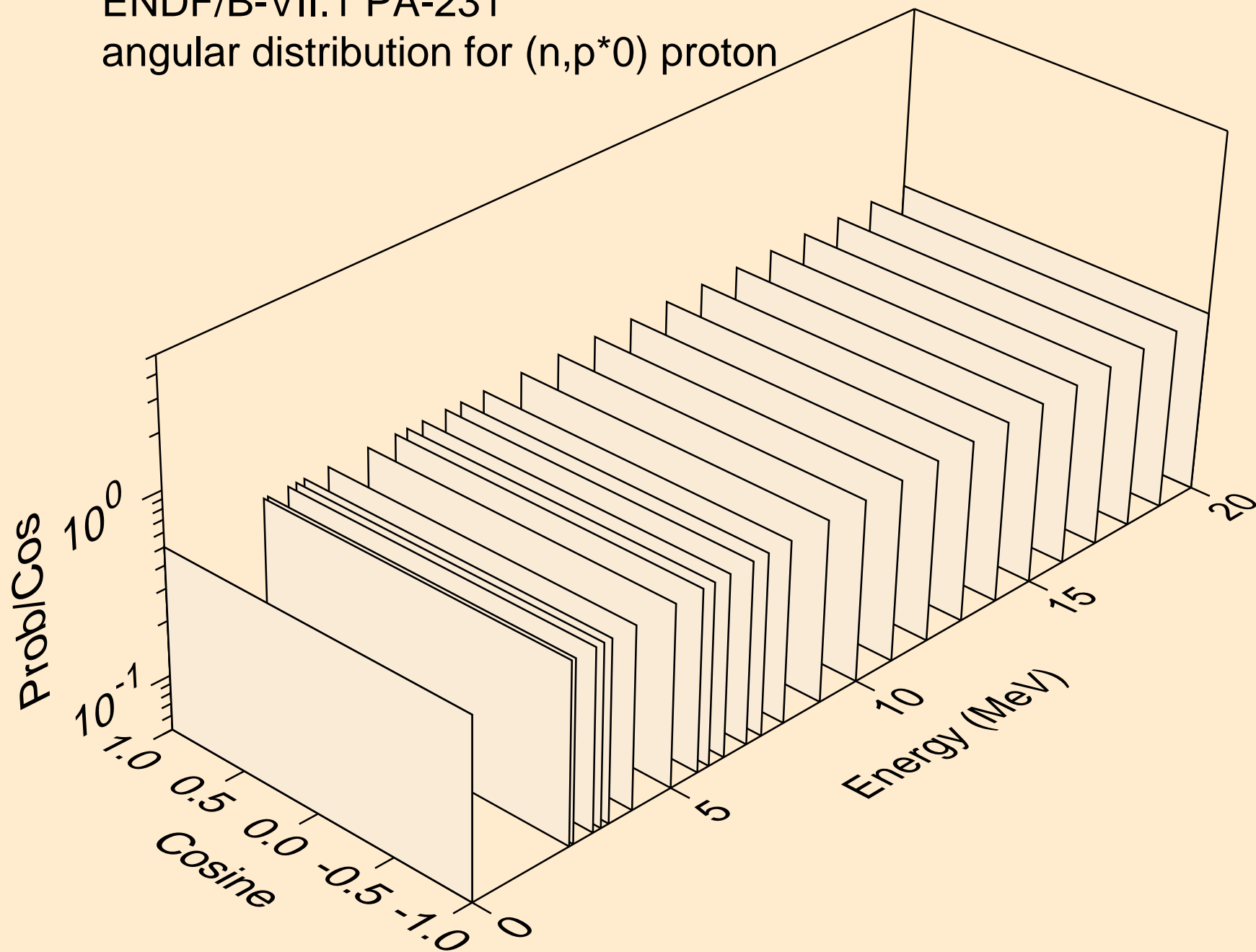

ENDF/B-VII.1 PA-231

angular distribution for (n,p*0) proton

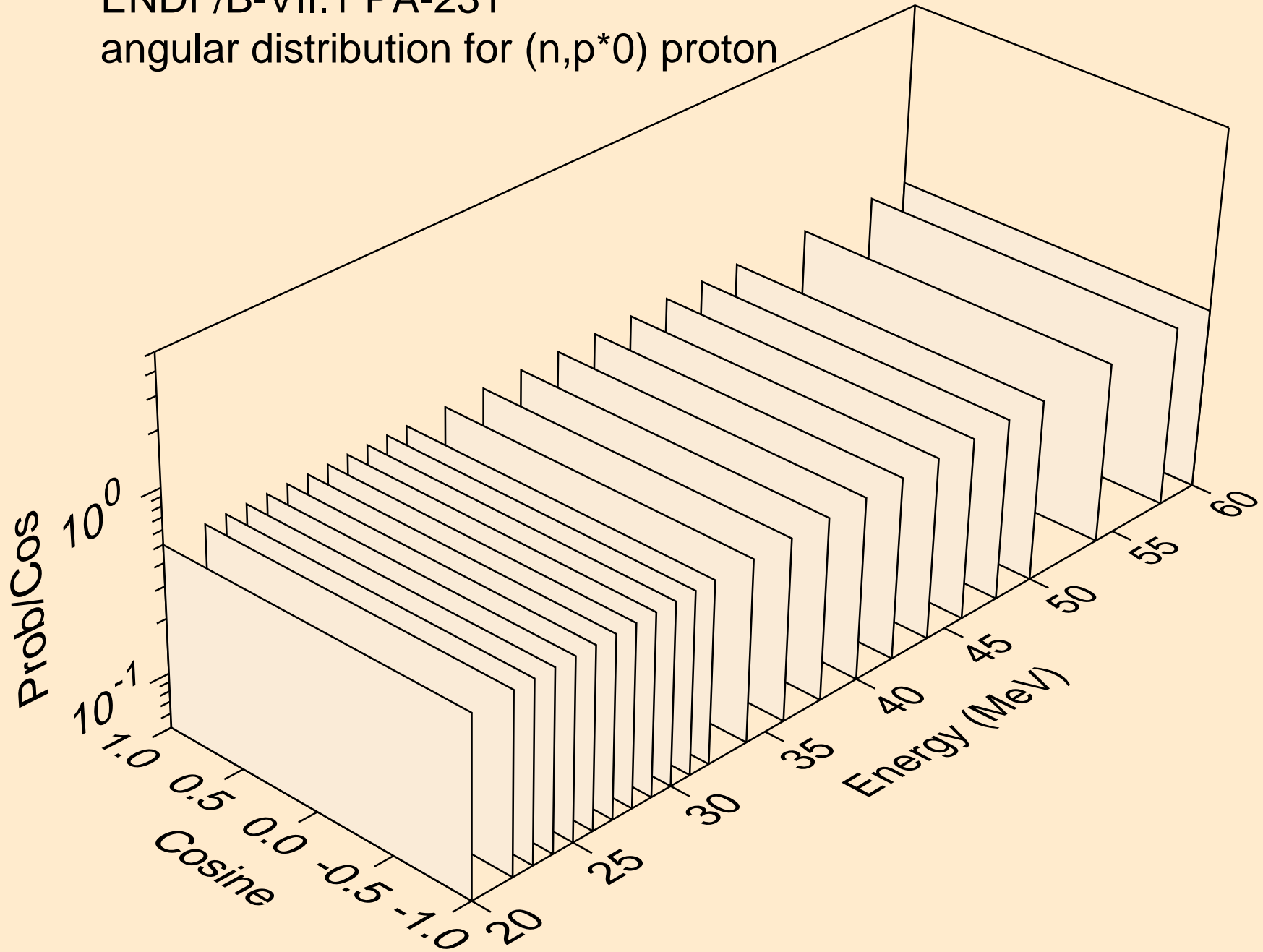

ENDF/B-VII.1 PA-231

angular distribution for (n,p*1) proton

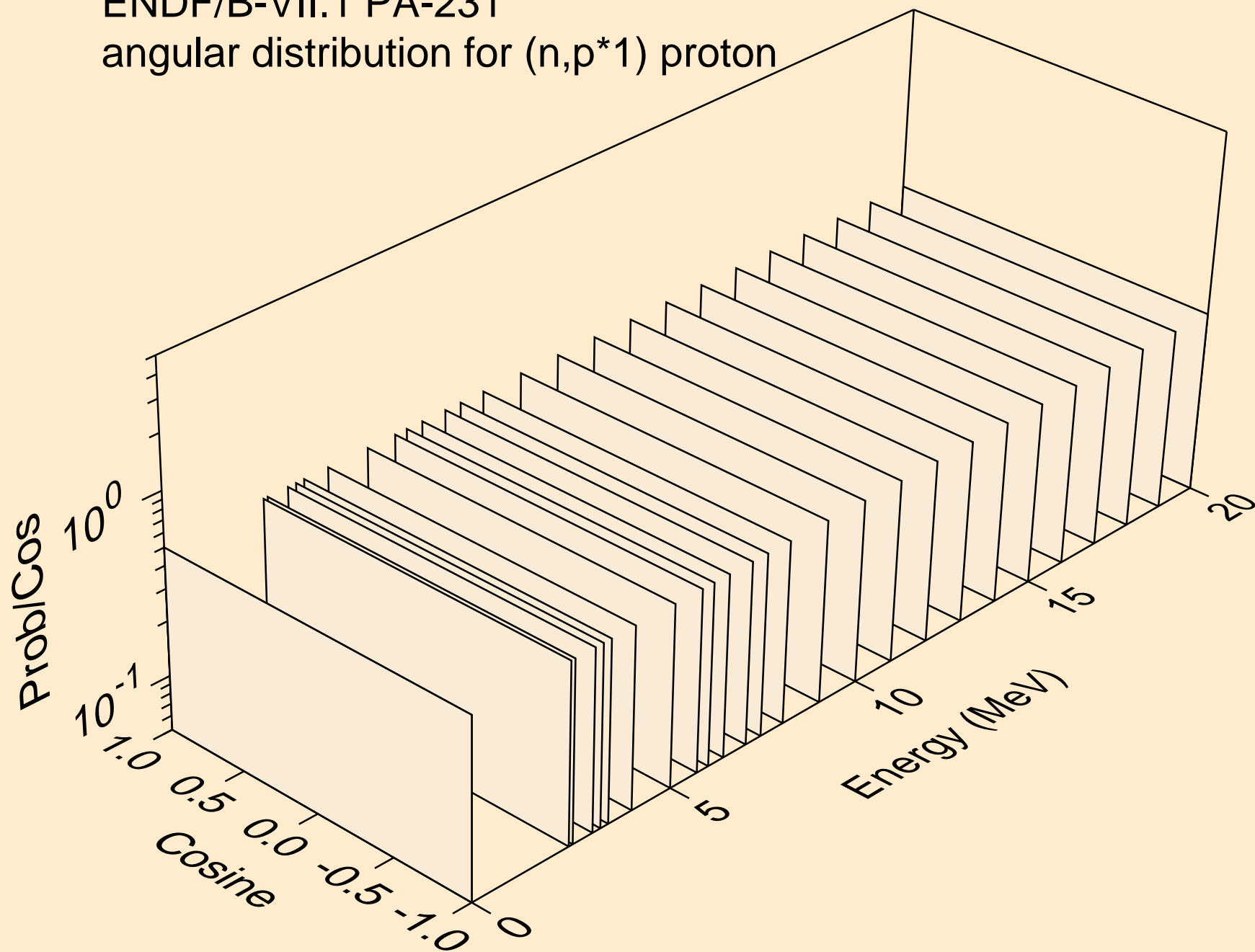

ENDF/B-VII.1 PA-231

angular distribution for (n,p*1) proton

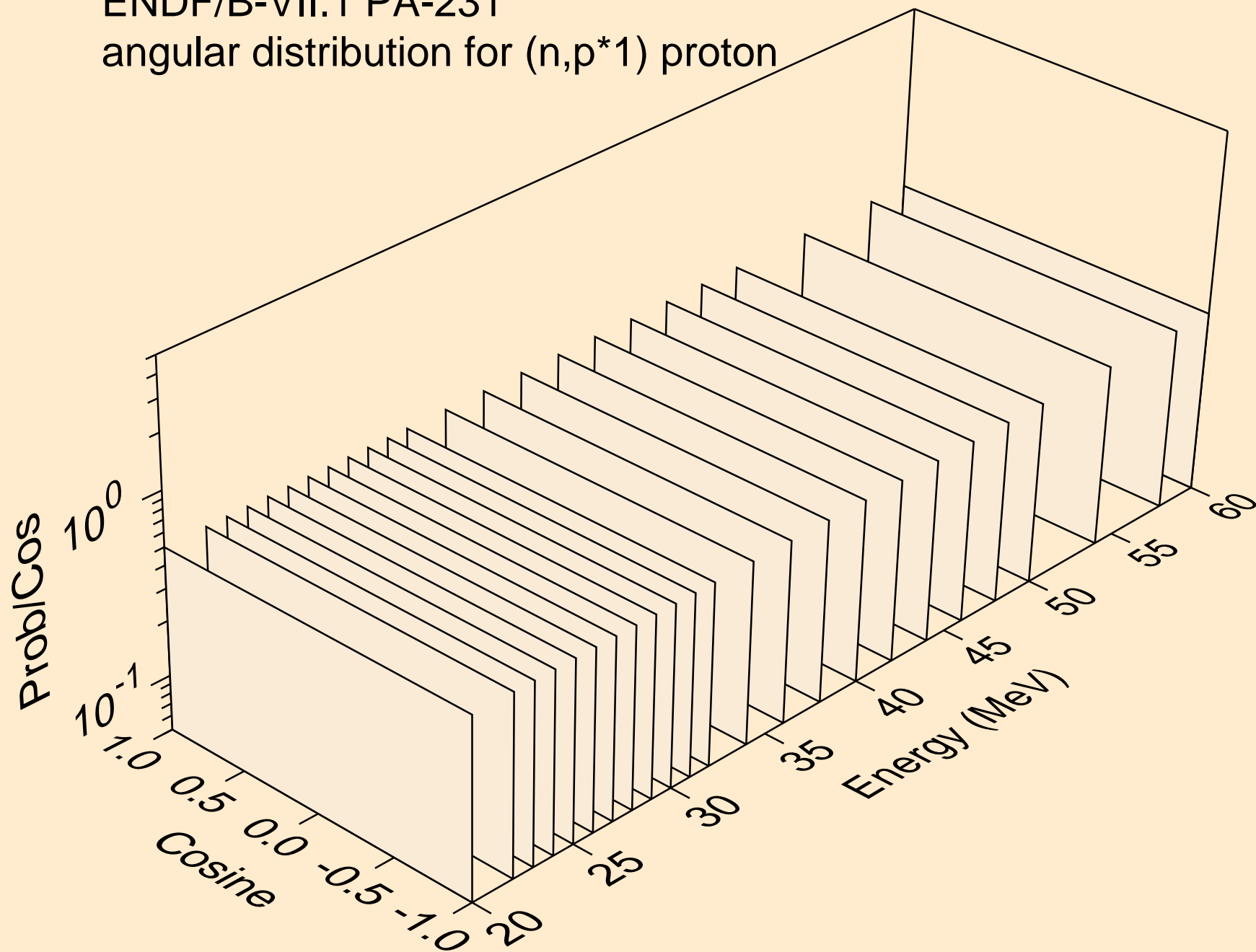

ENDF/B-VII.1 PA-231

angular distribution for (n,p*2) proton

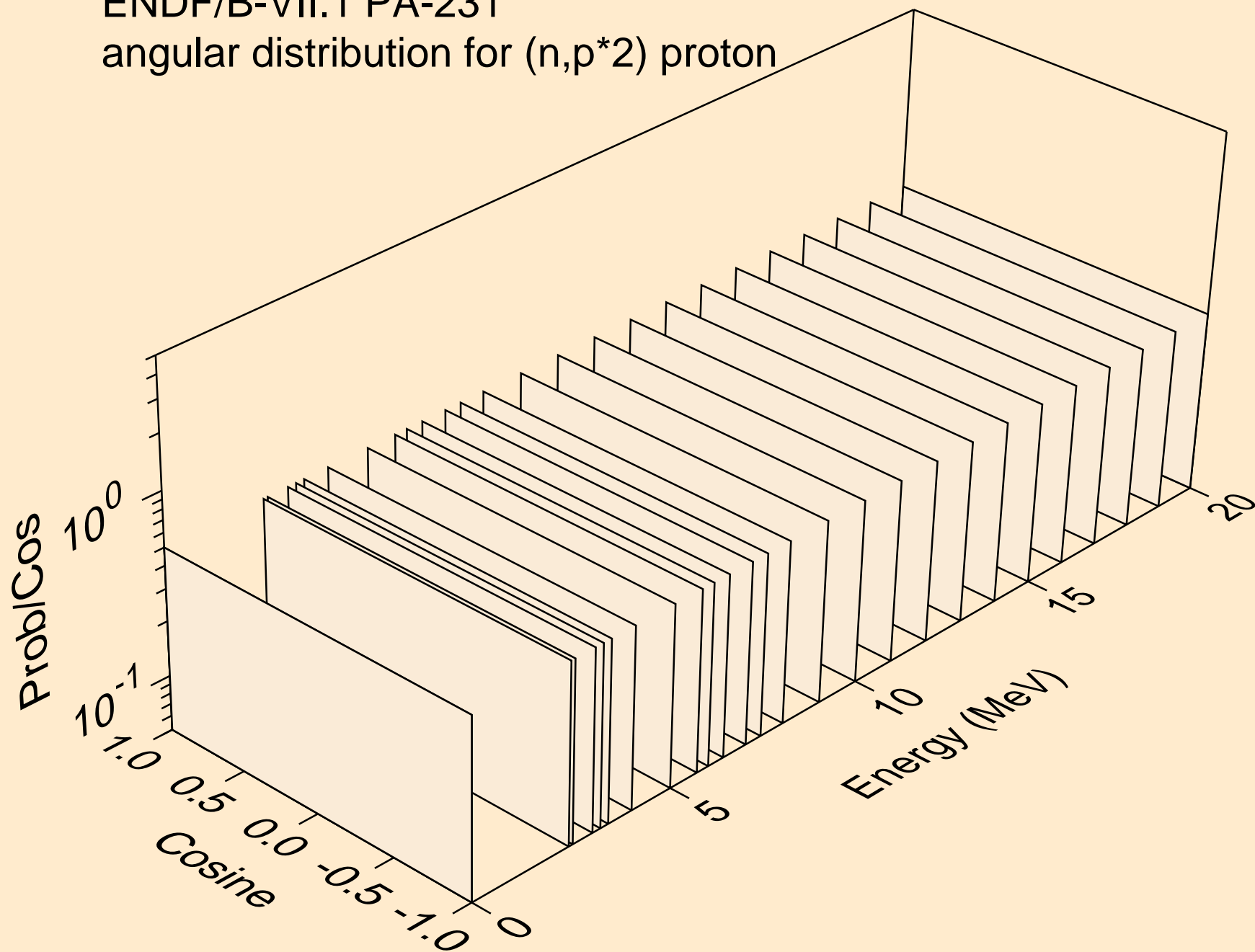

ENDF/B-VII.1 PA-231

angular distribution for (n,p*2) proton

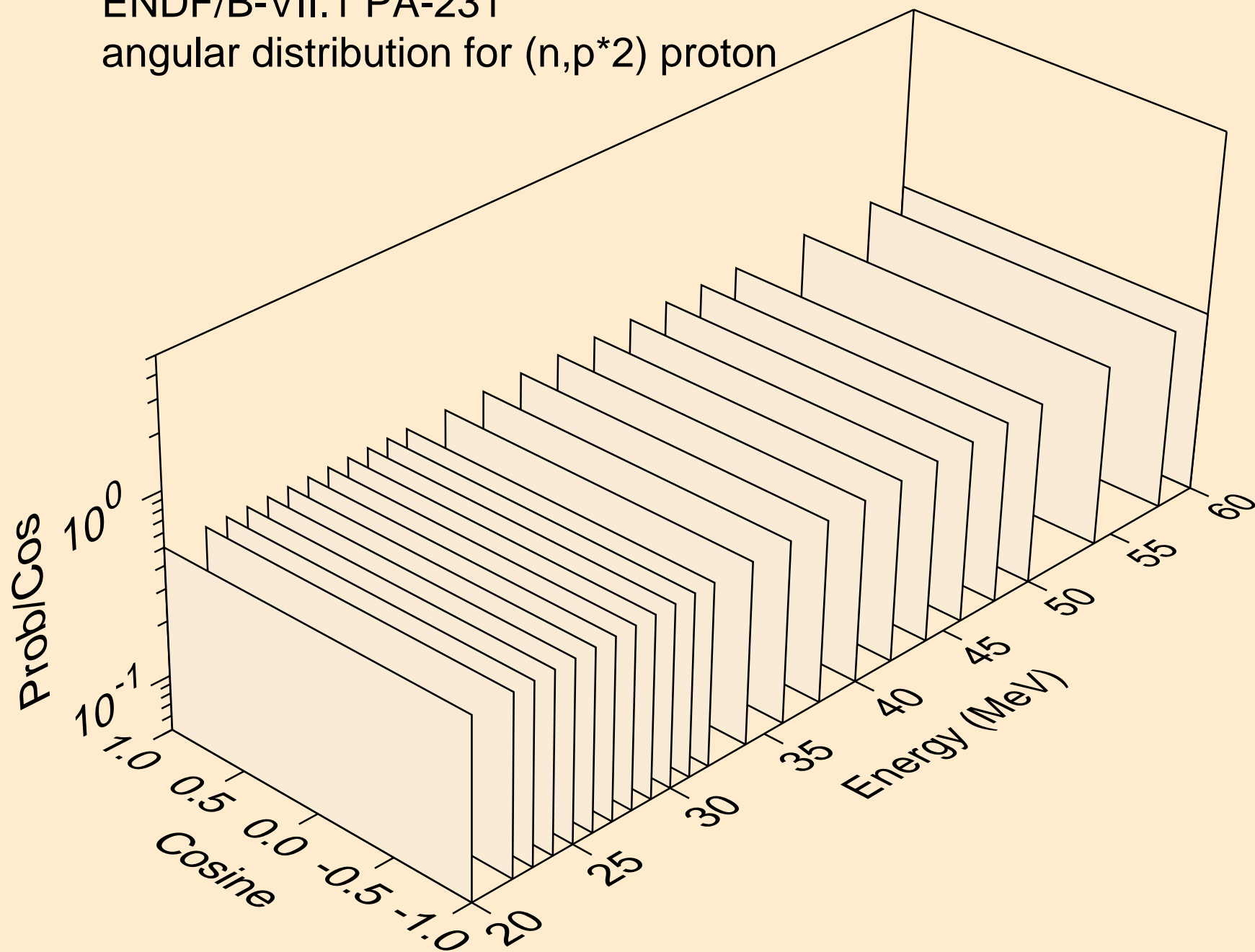

ENDF/B-VII.1 PA-231

angular distribution for (n,p*3) proton

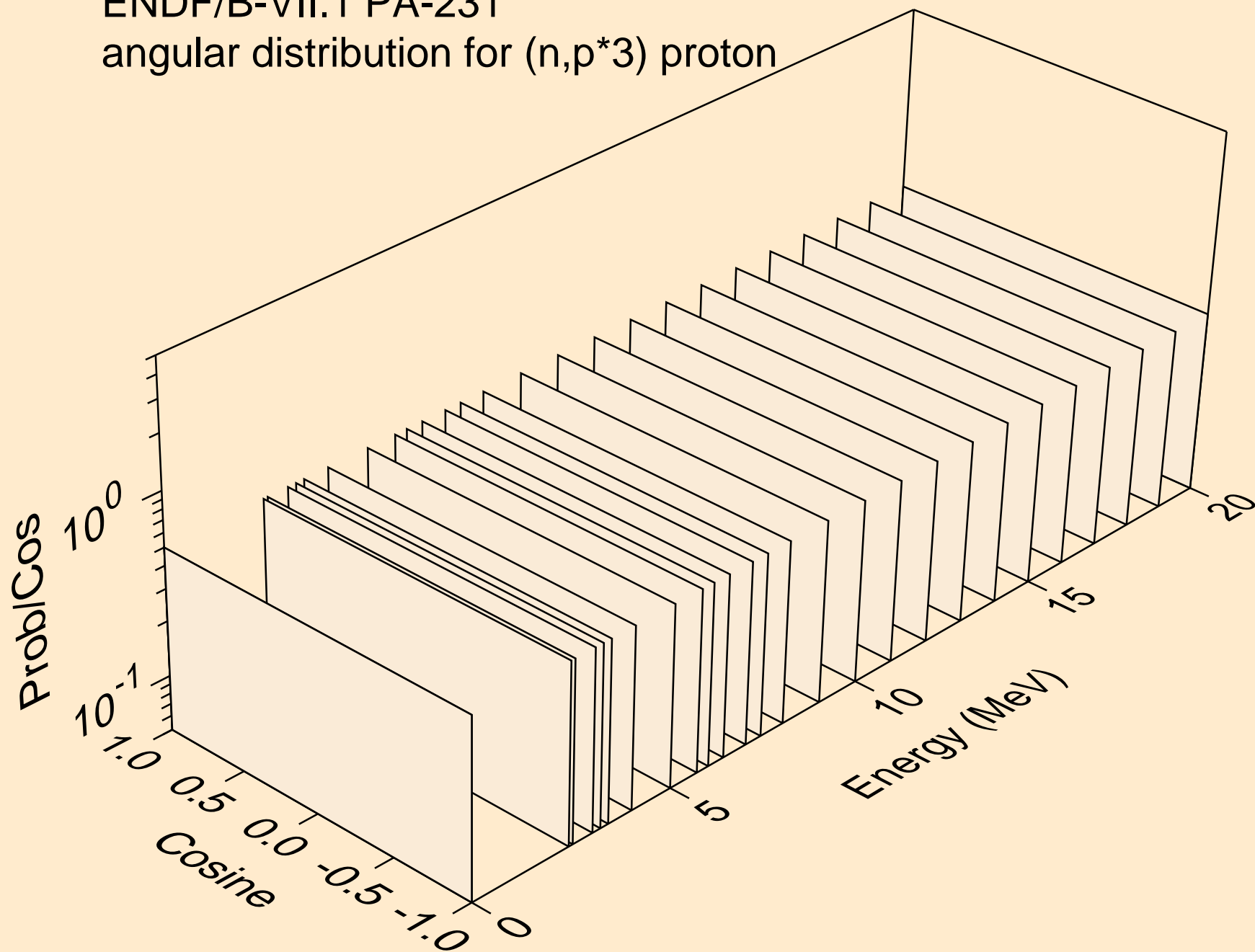

ENDF/B-VII.1 PA-231

angular distribution for (n,p*3) proton

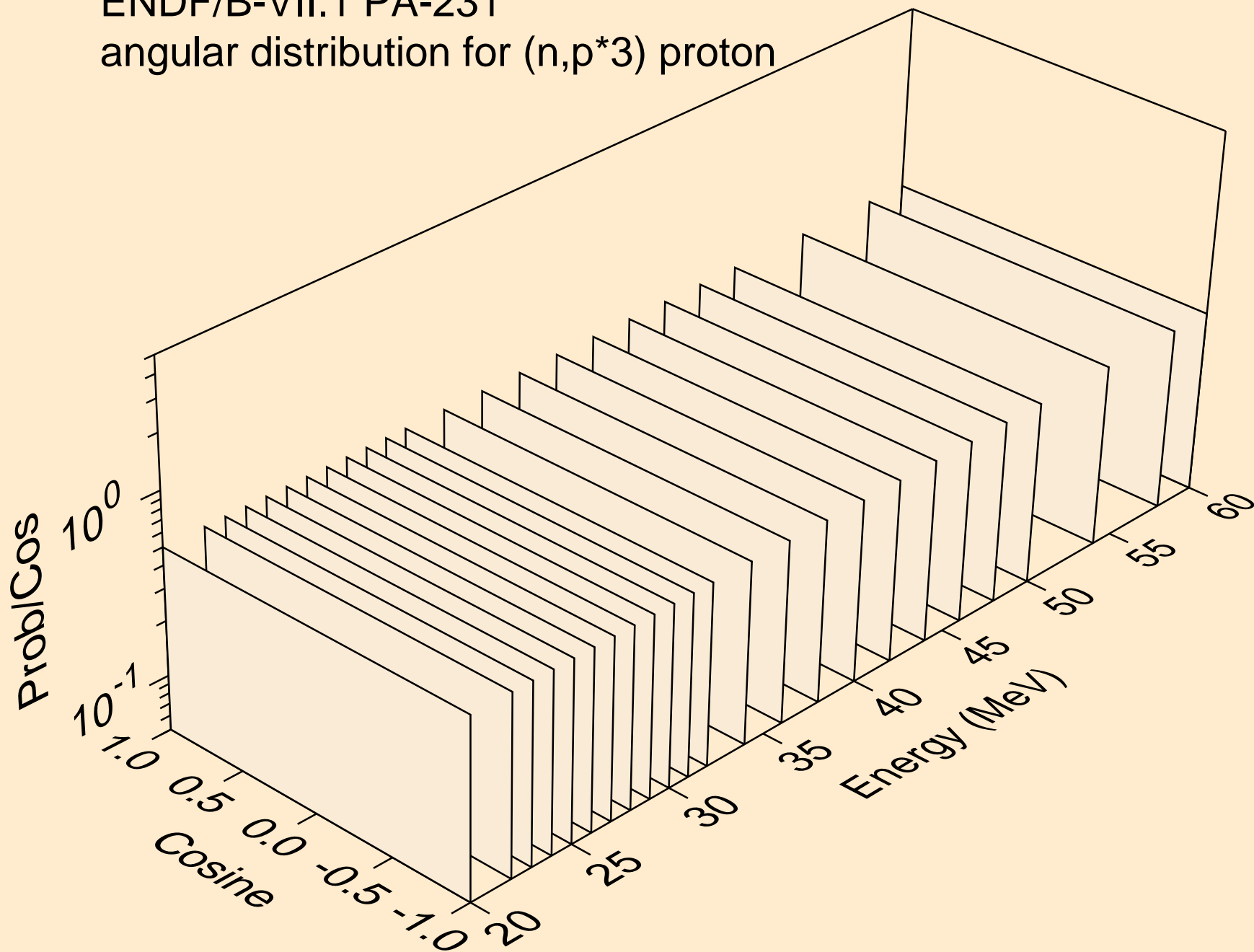

ENDF/B-VII.1 PA-231

angular distribution for (n,p*4) proton

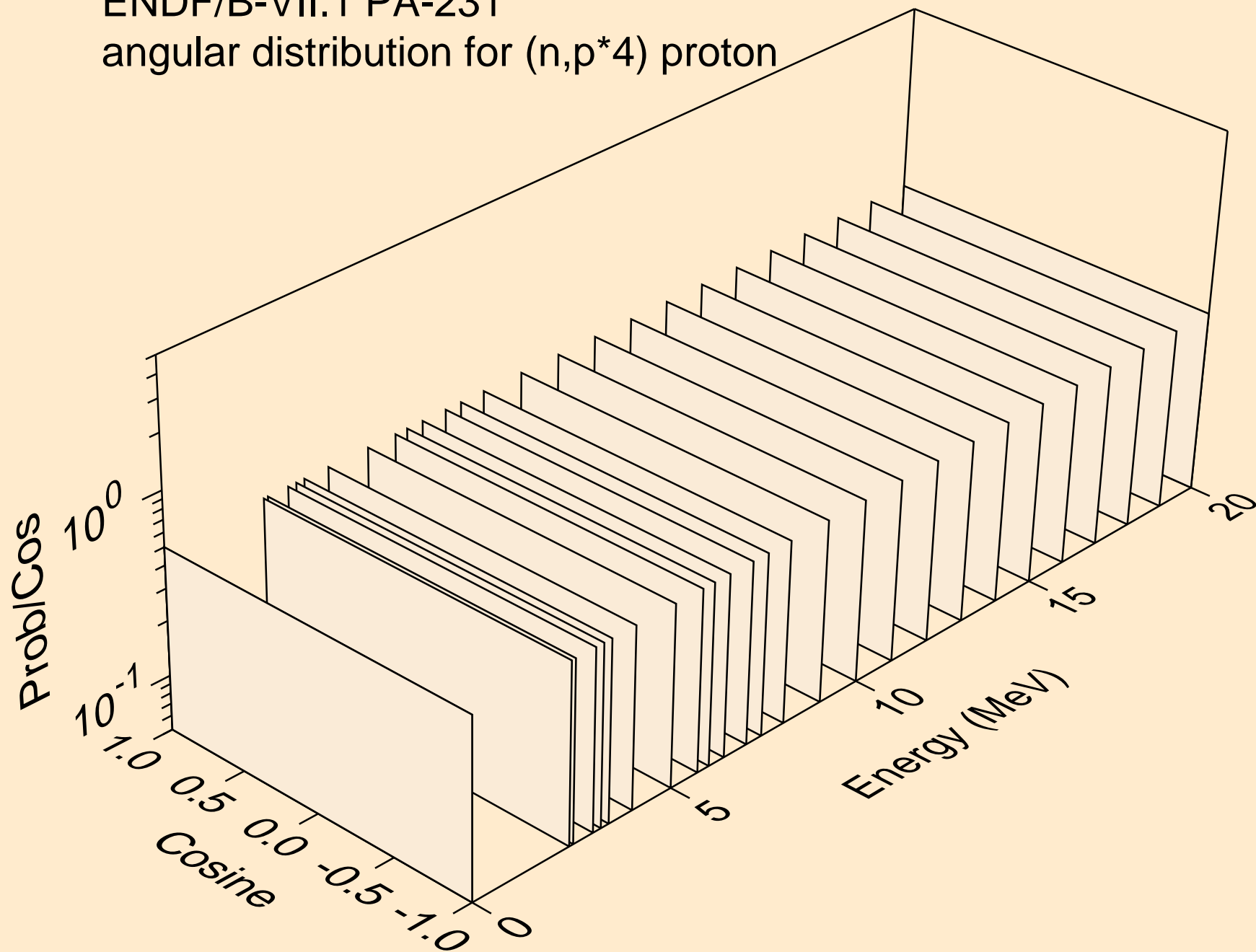

ENDF/B-VII.1 PA-231

angular distribution for (n,p*4) proton

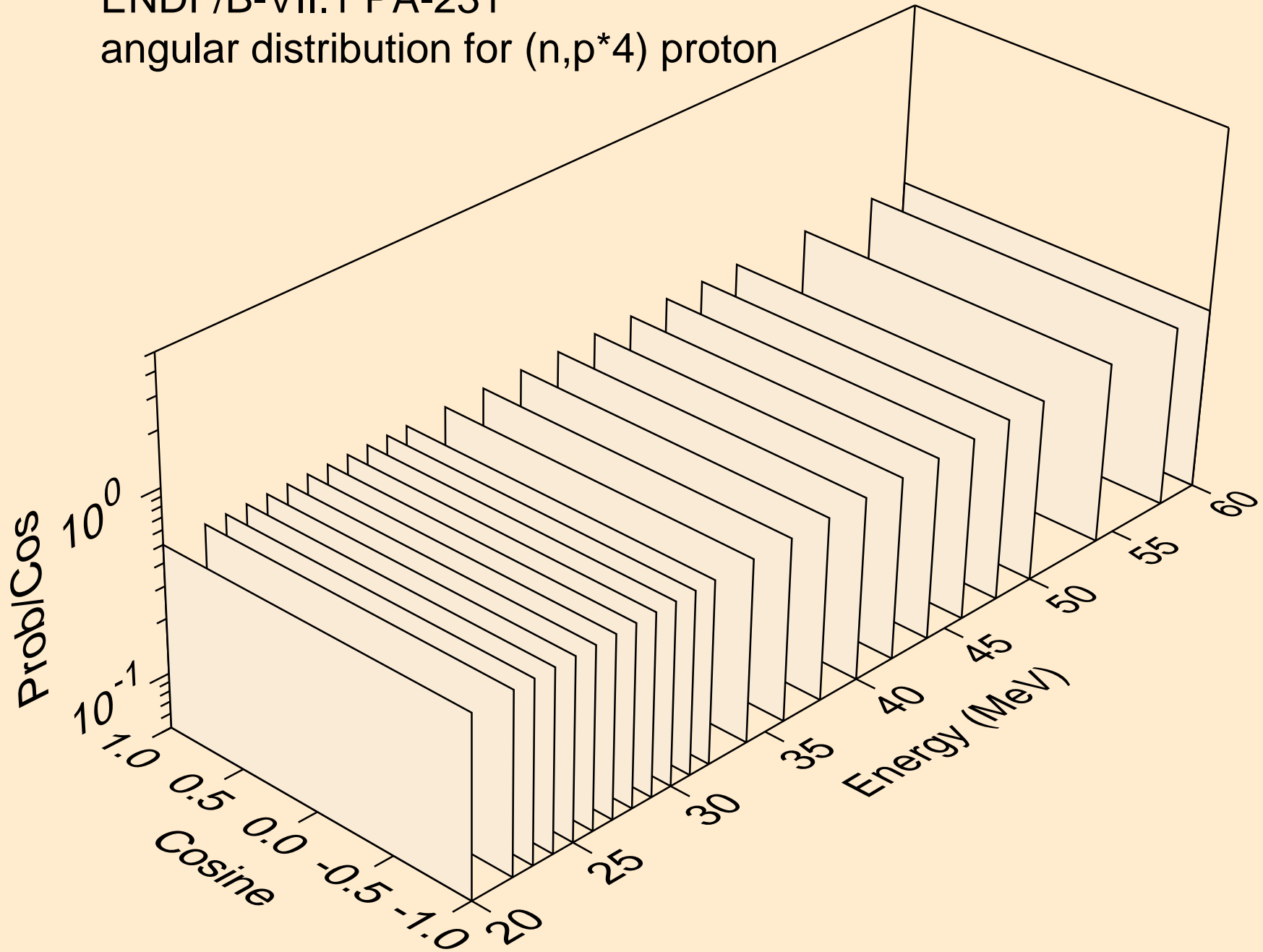

ENDF/B-VII.1 PA-231

angular distribution for (n,p*5) proton

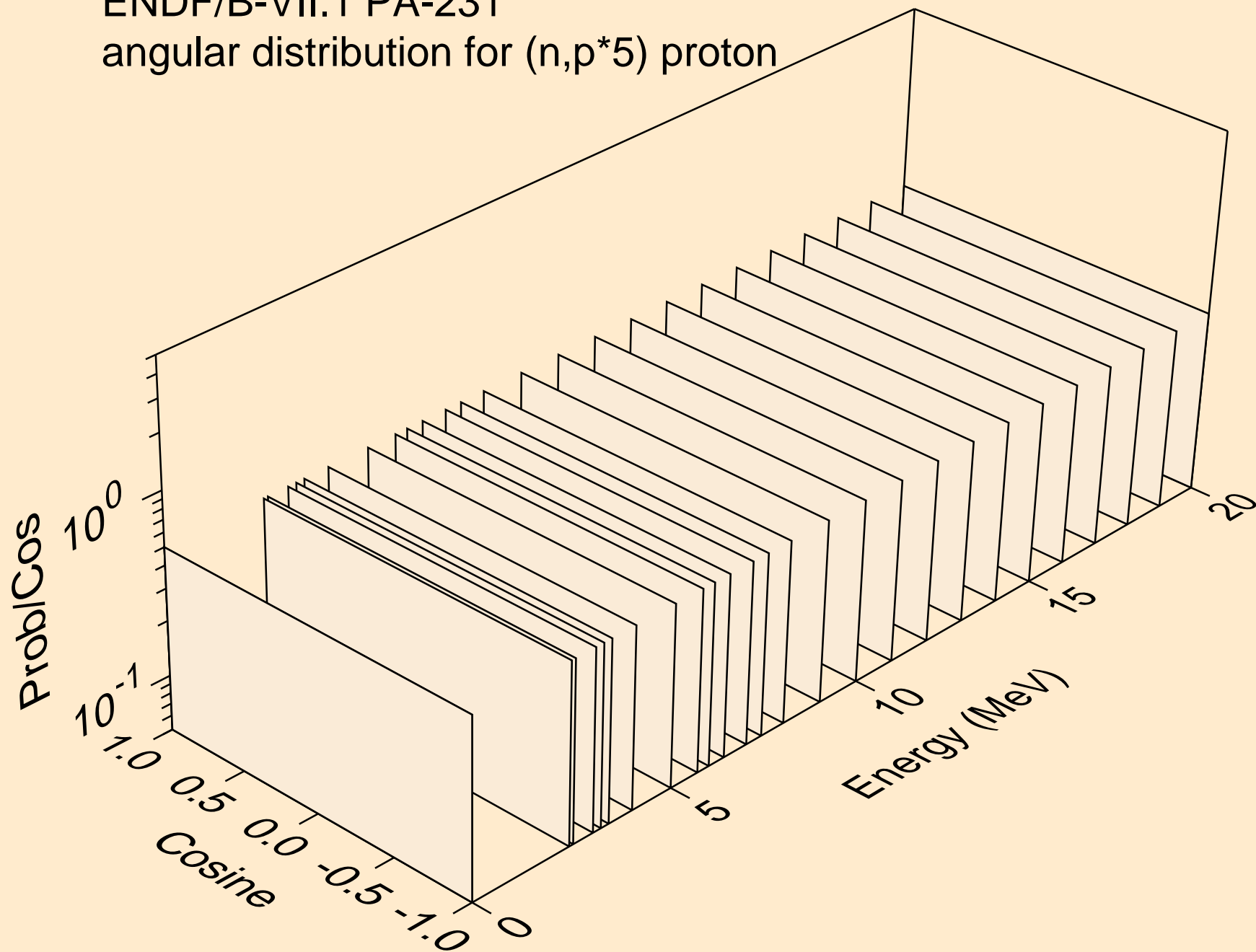

ENDF/B-VII.1 PA-231

angular distribution for (n,p*5) proton

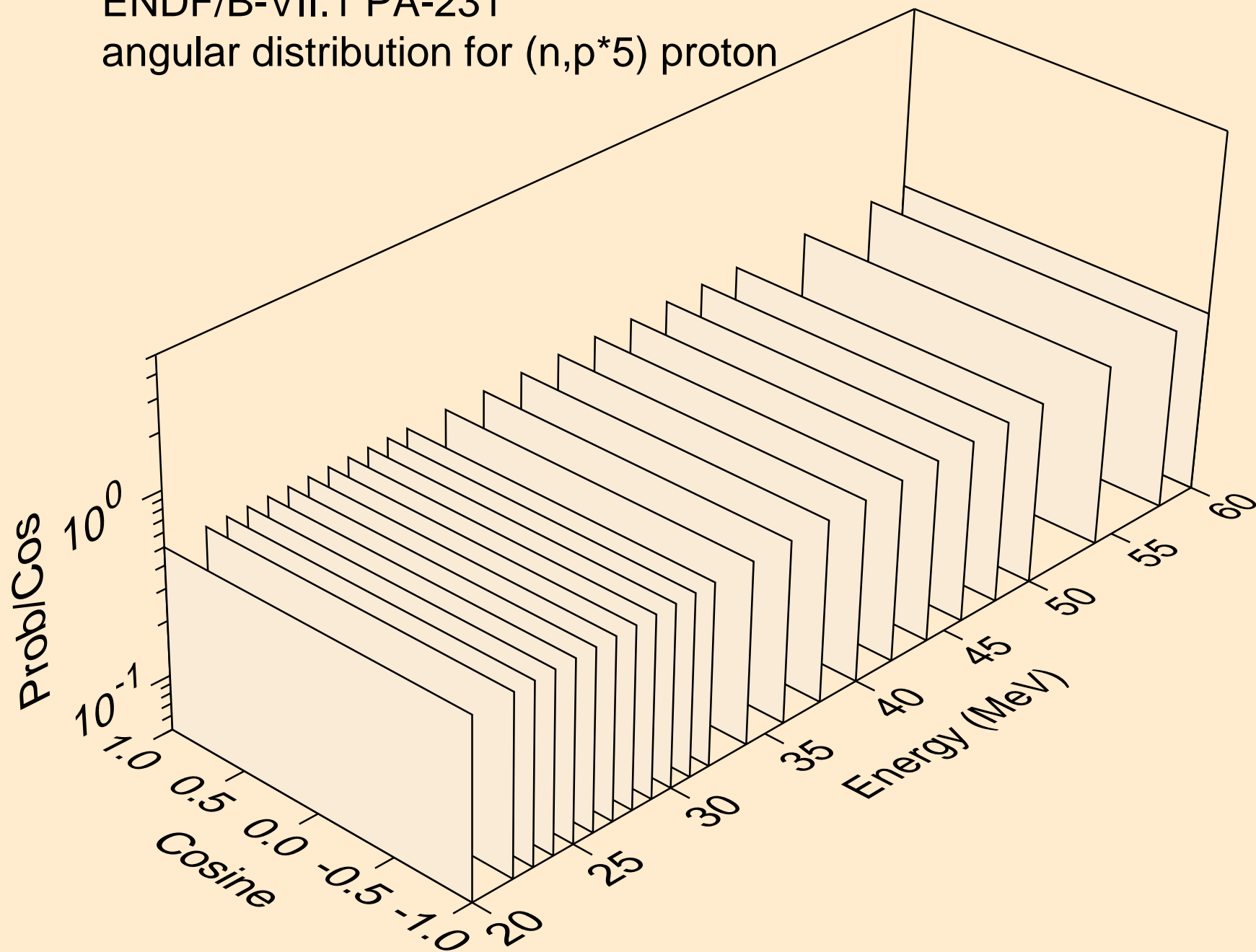

ENDF/B-VII.1 PA-231

angular distribution for (n,p*6) proton

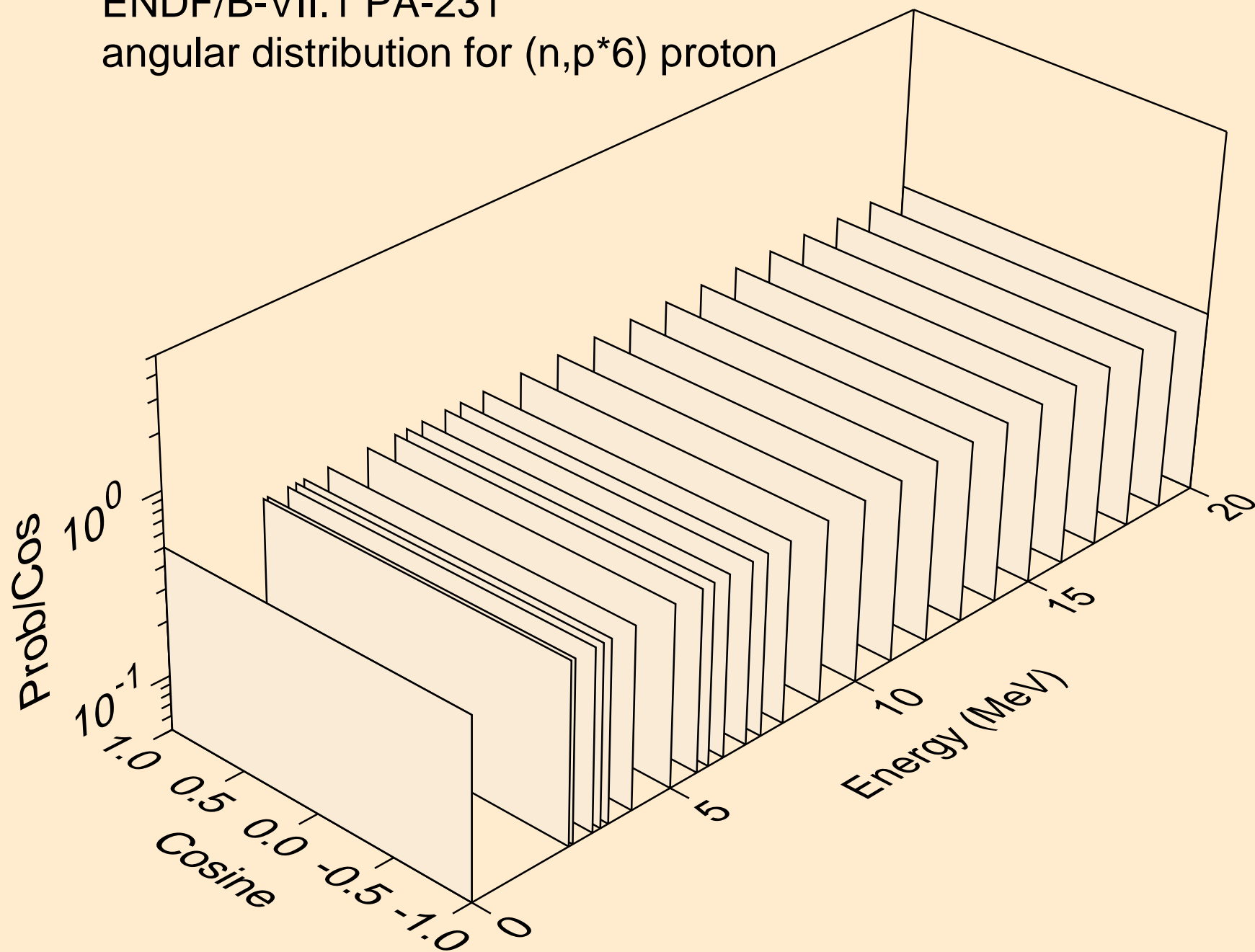

ENDF/B-VII.1 PA-231

angular distribution for (n,p*6) proton

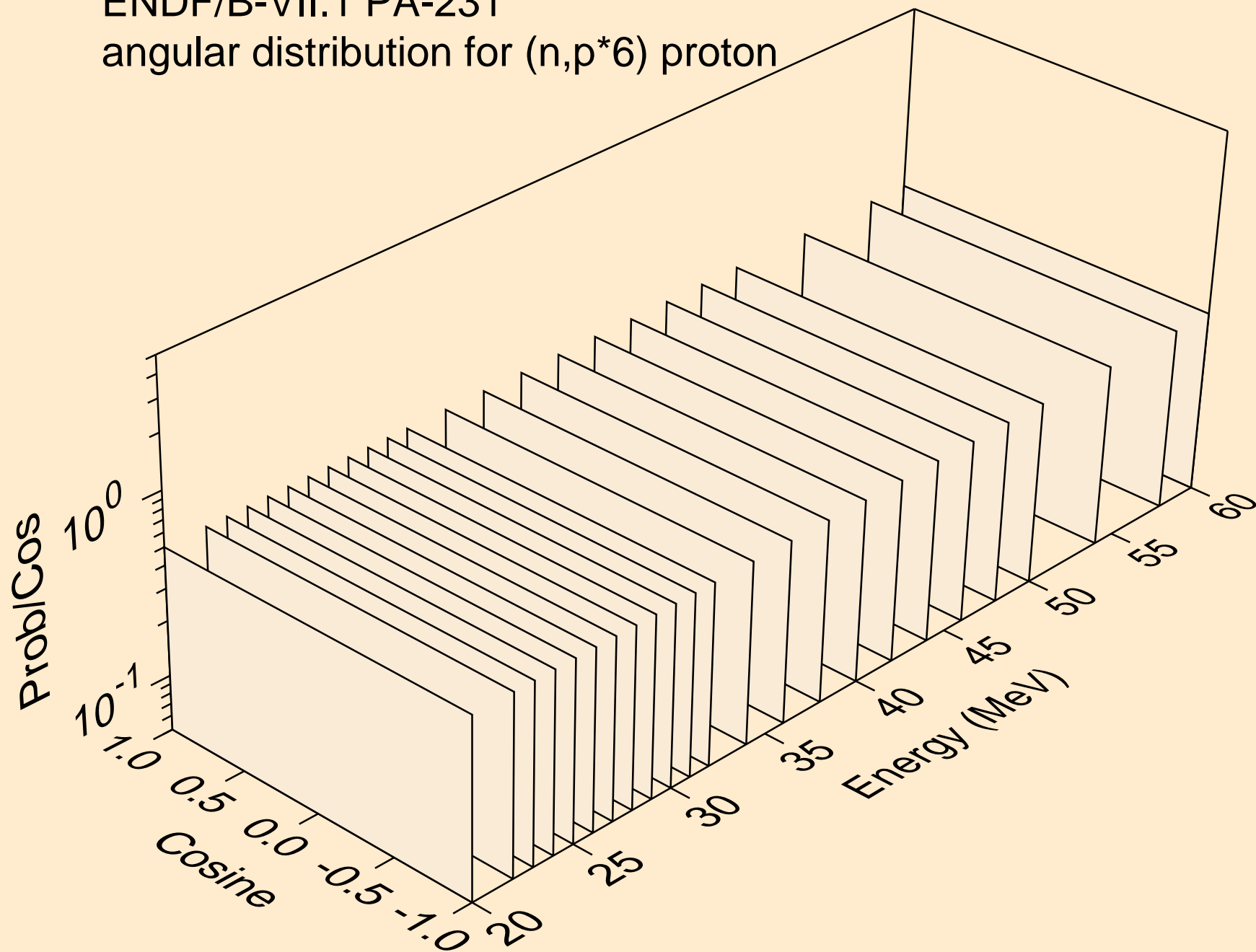

ENDF/B-VII.1 PA-231

angular distribution for (n,p*7) proton

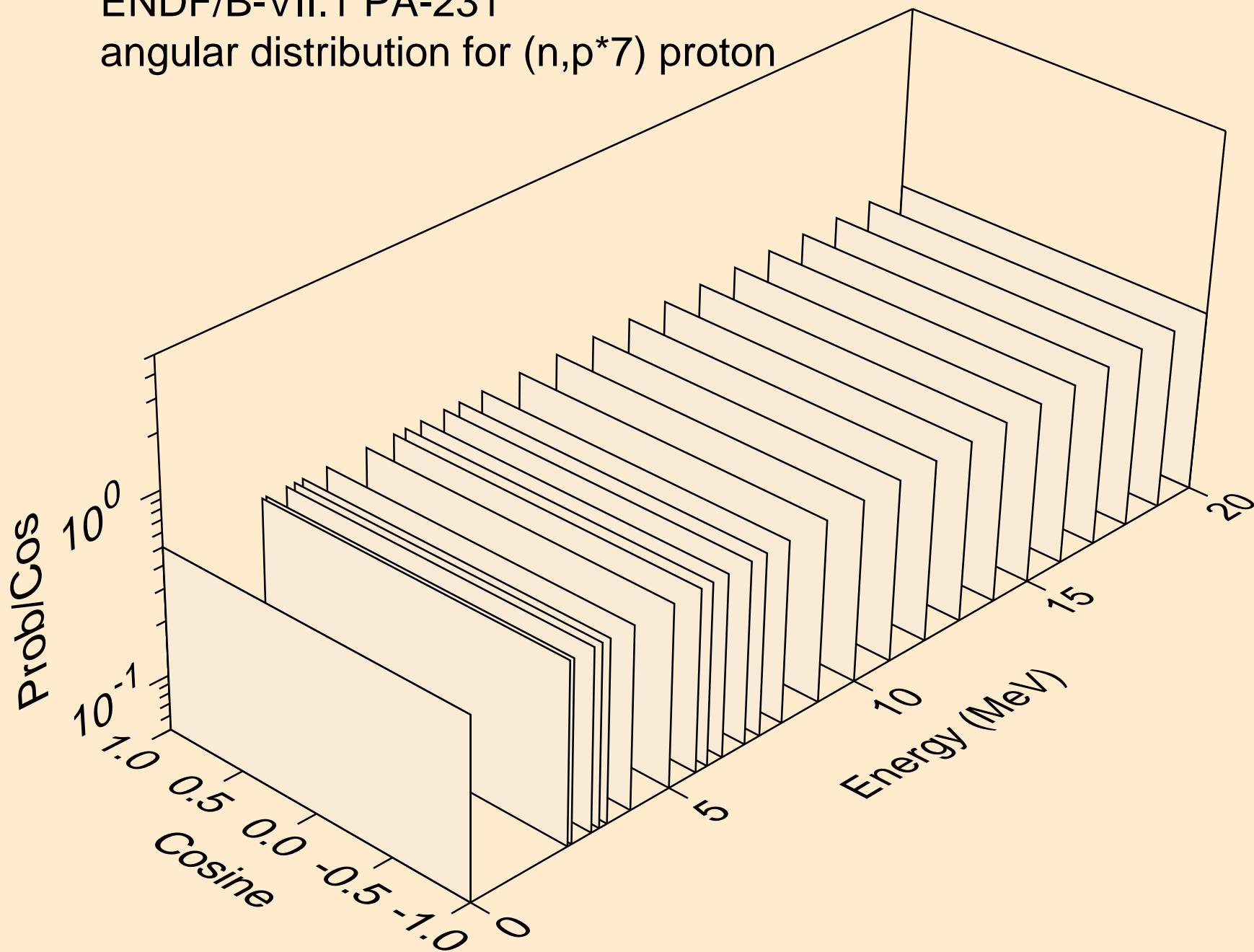

ENDF/B-VII.1 PA-231

angular distribution for (n,p*7) proton

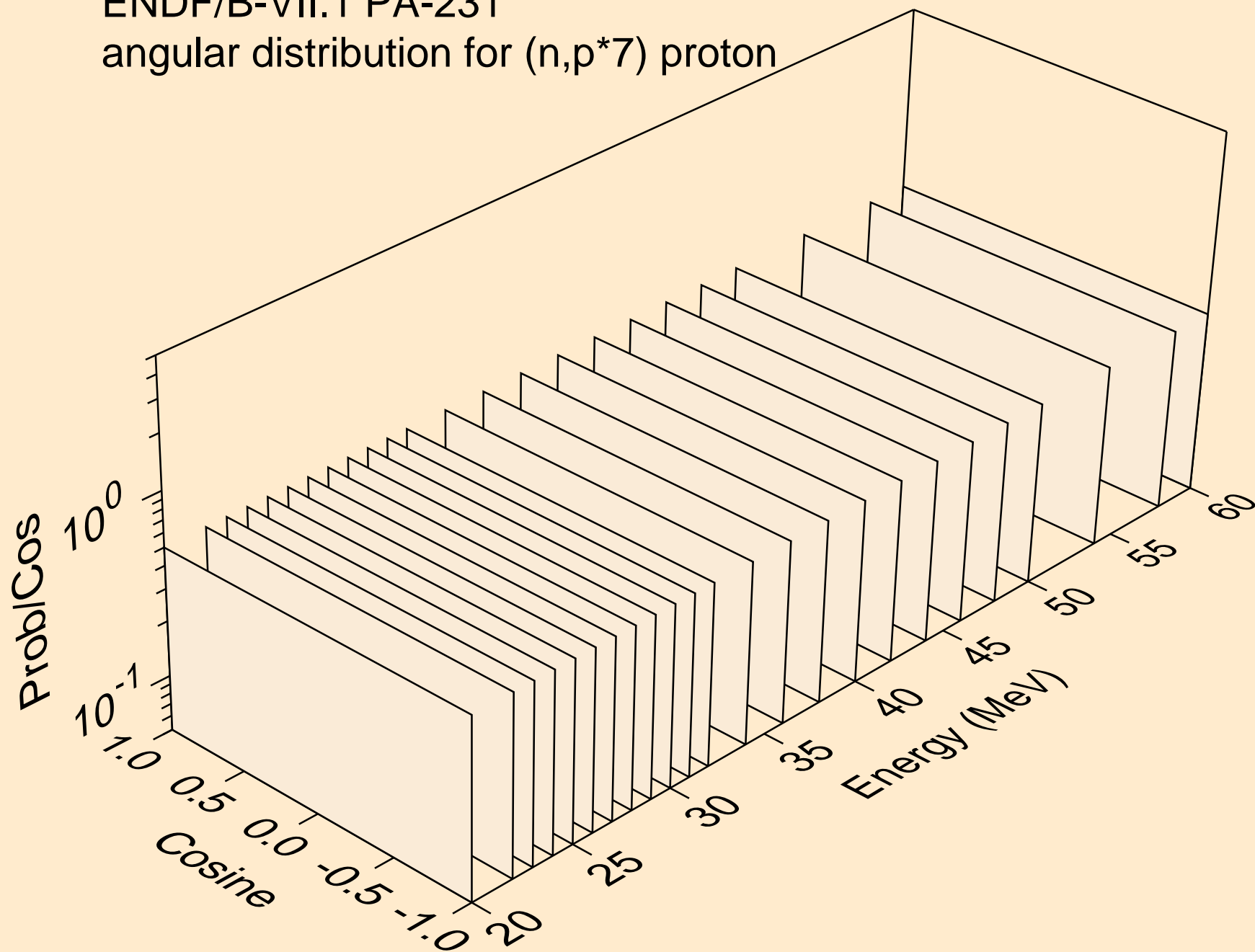

ENDF/B-VII.1 PA-231

angular distribution for (n,p*8) proton

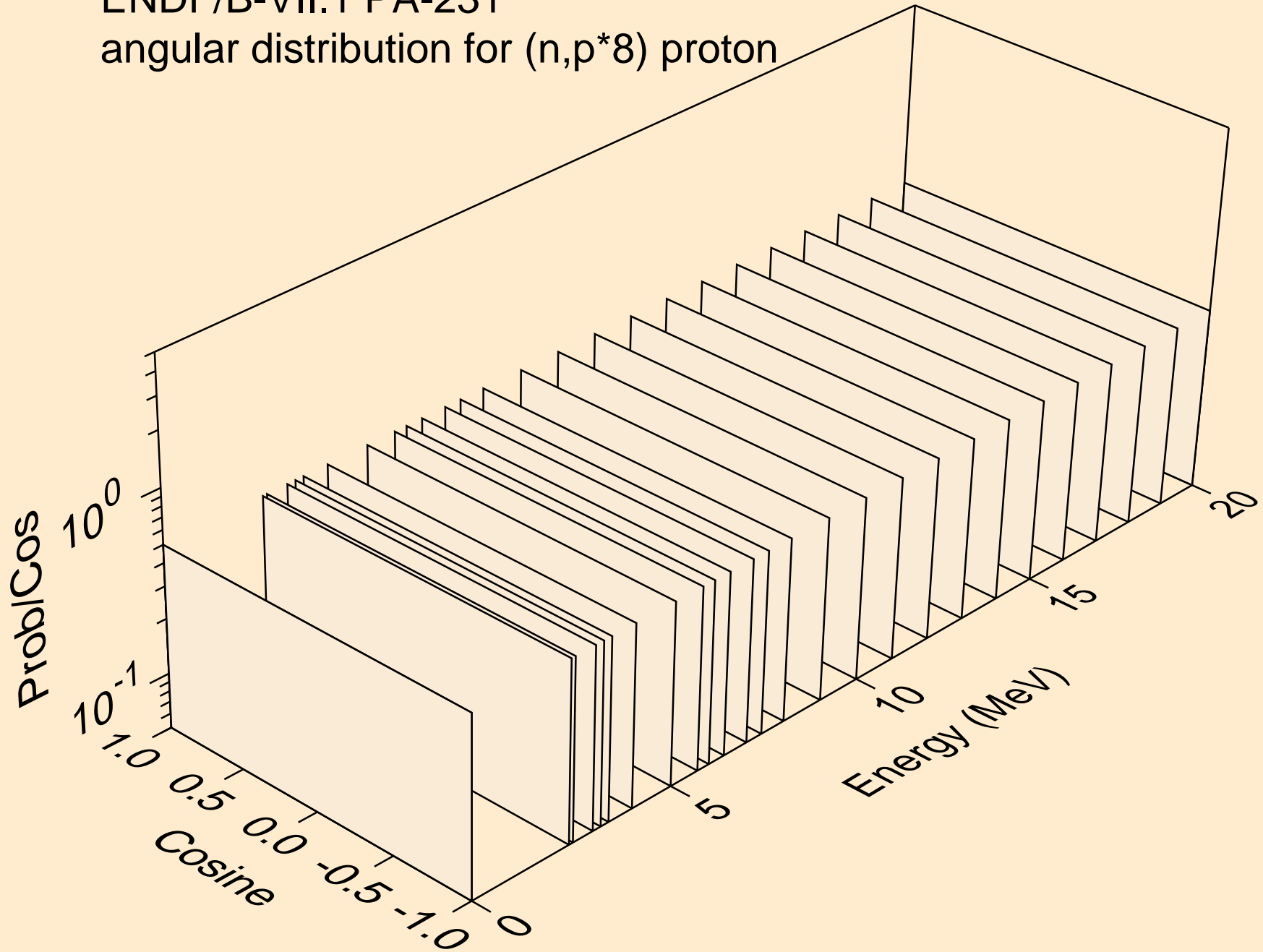

ENDF/B-VII.1 PA-231

angular distribution for (n,p*8) proton

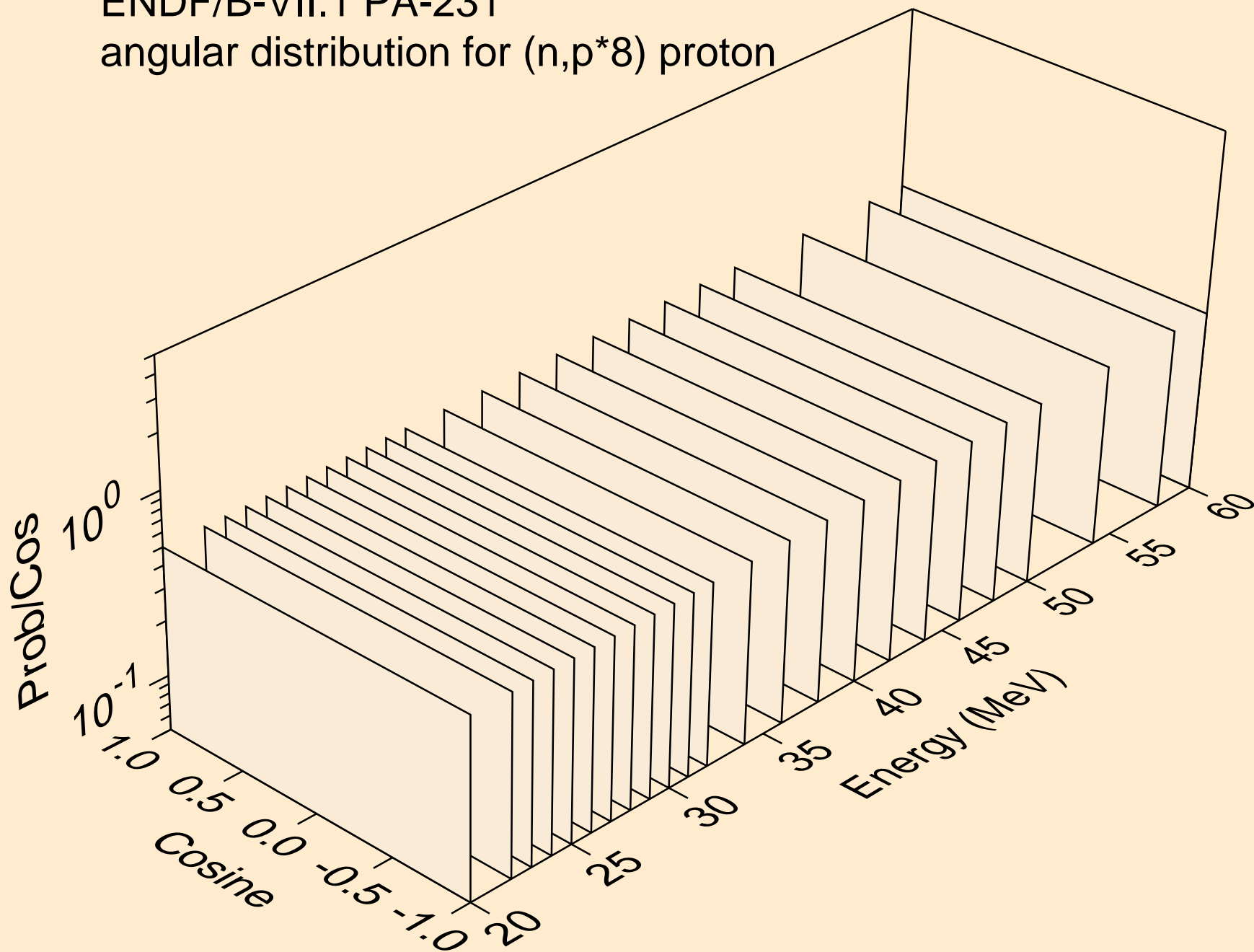

ENDF/B-VII.1 PA-231

angular distribution for (n,p*9) proton

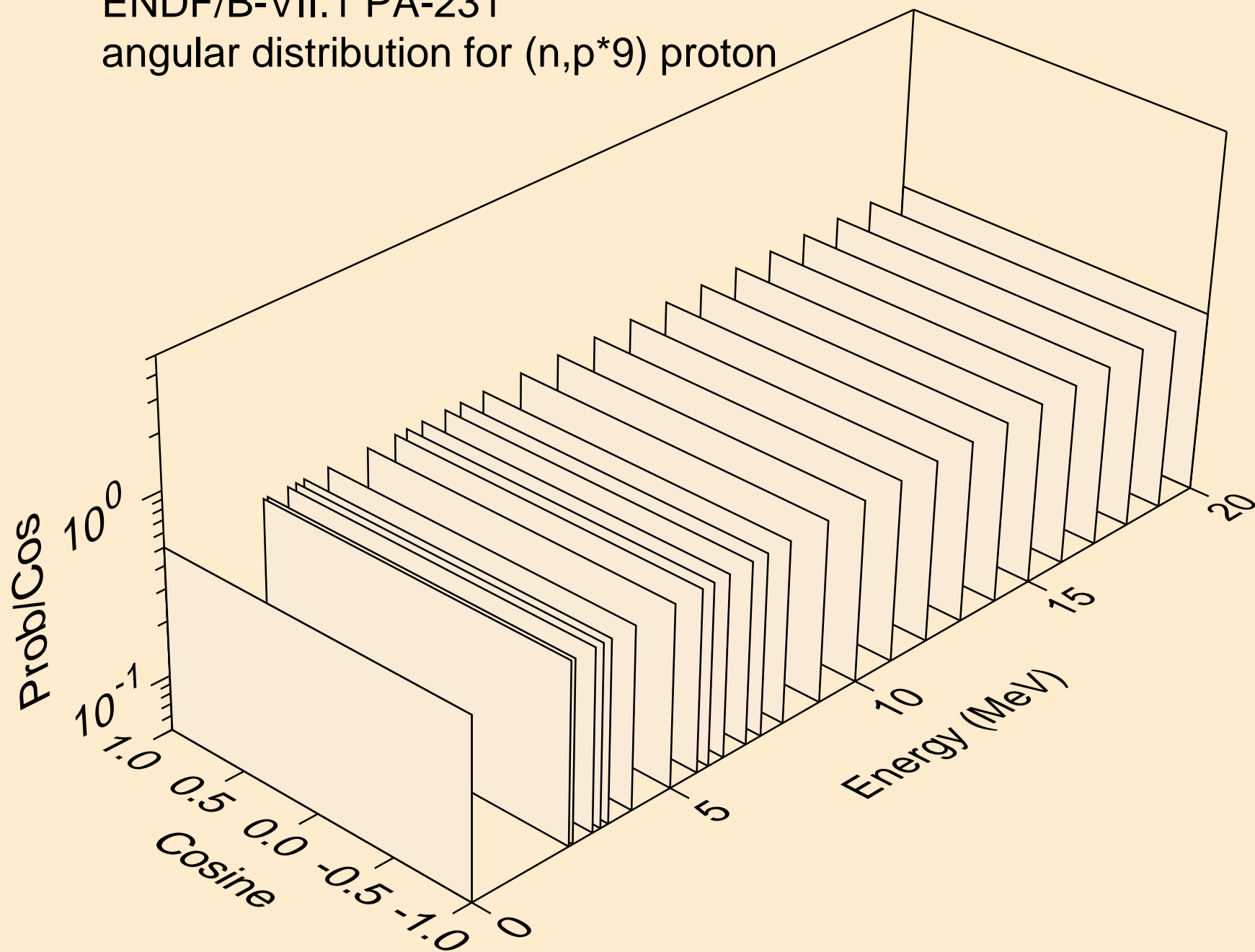

ENDF/B-VII.1 PA-231

angular distribution for (n,p*9) proton

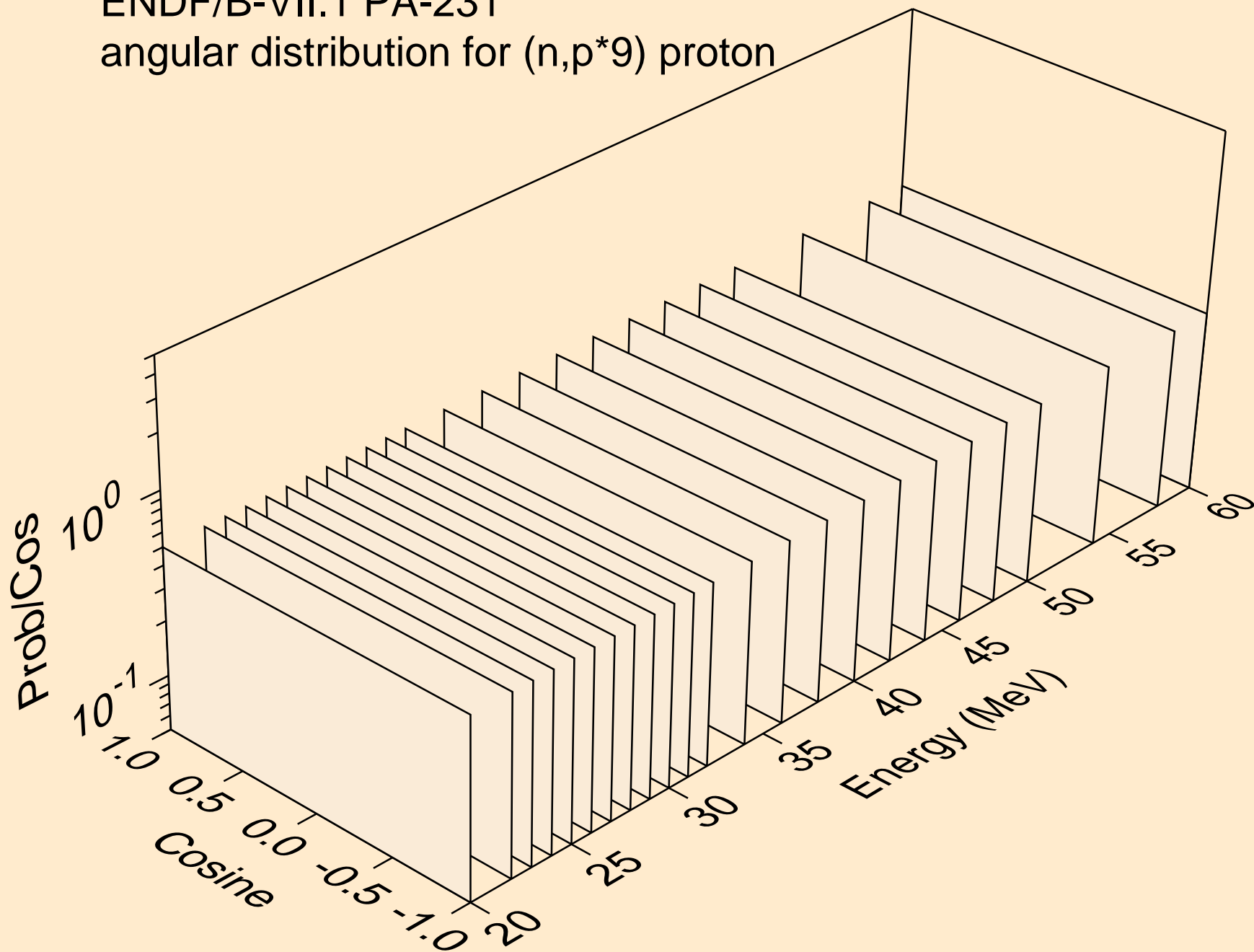

ENDF/B-VII.1 PA-231

angular distribution for (n,p*10) proton

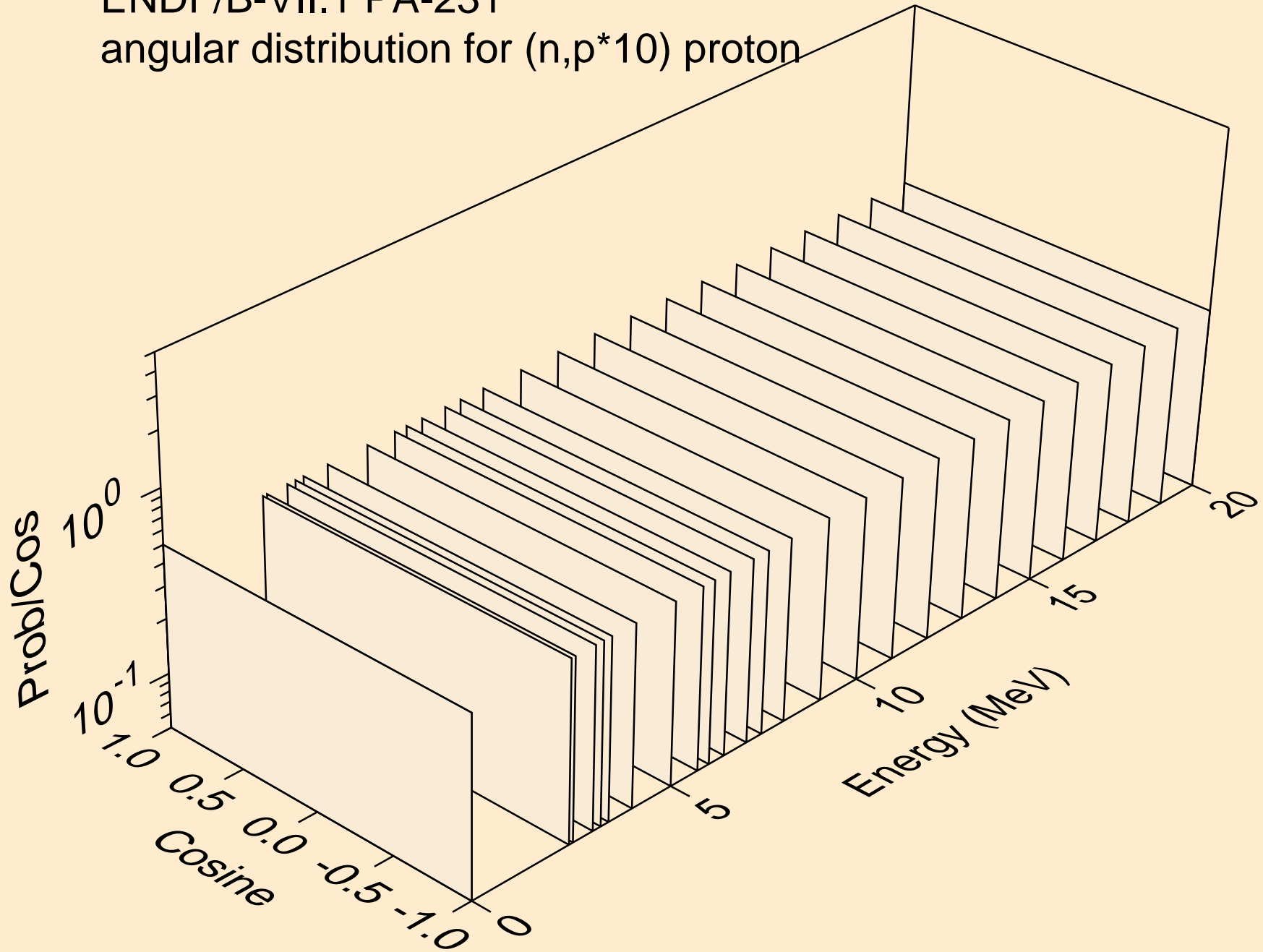

ENDF/B-VII.1 PA-231

angular distribution for (n,p*10) proton

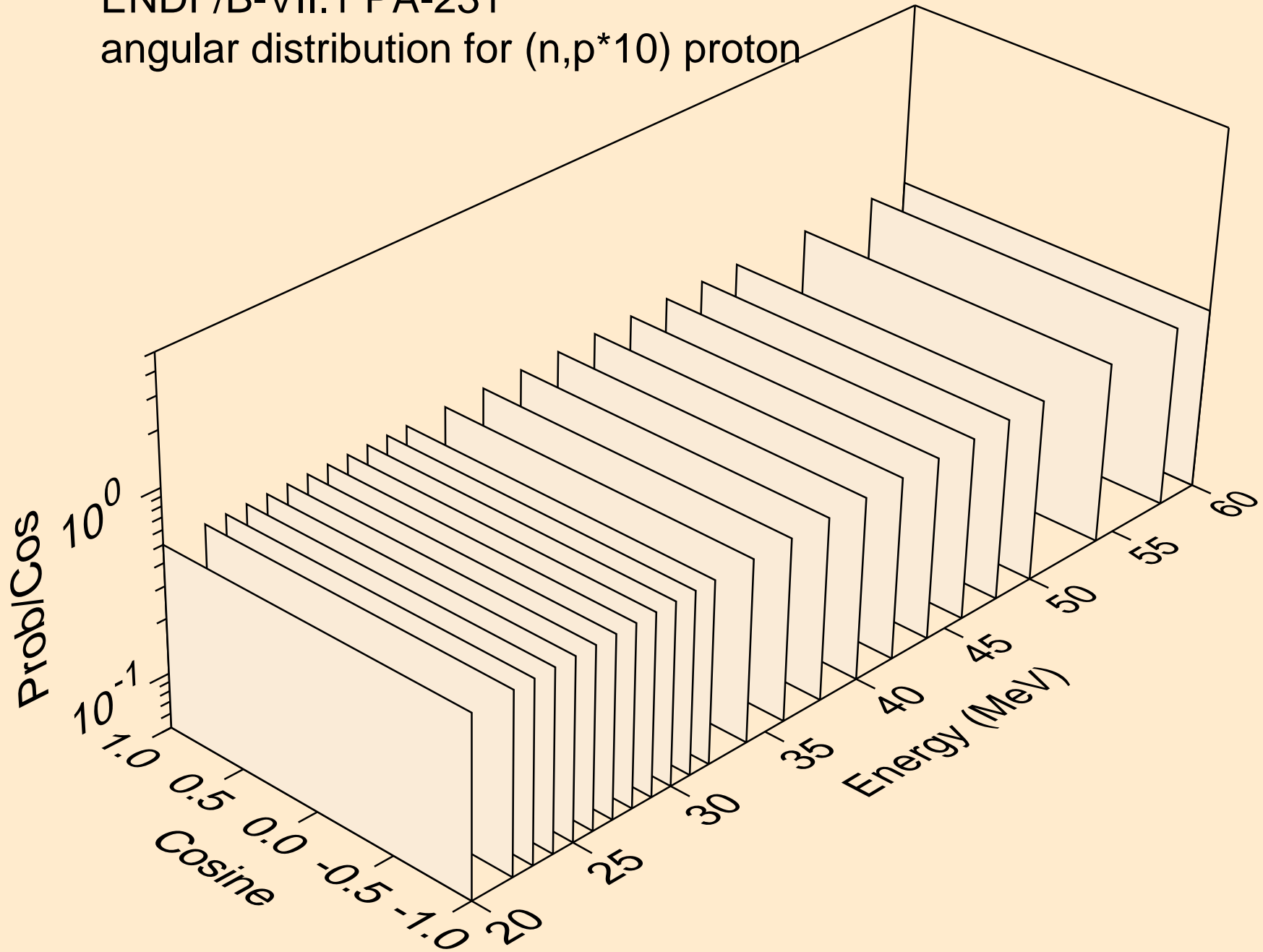

ENDF/B-VII.1 PA-231
angular distribution for (n,p*11) proton

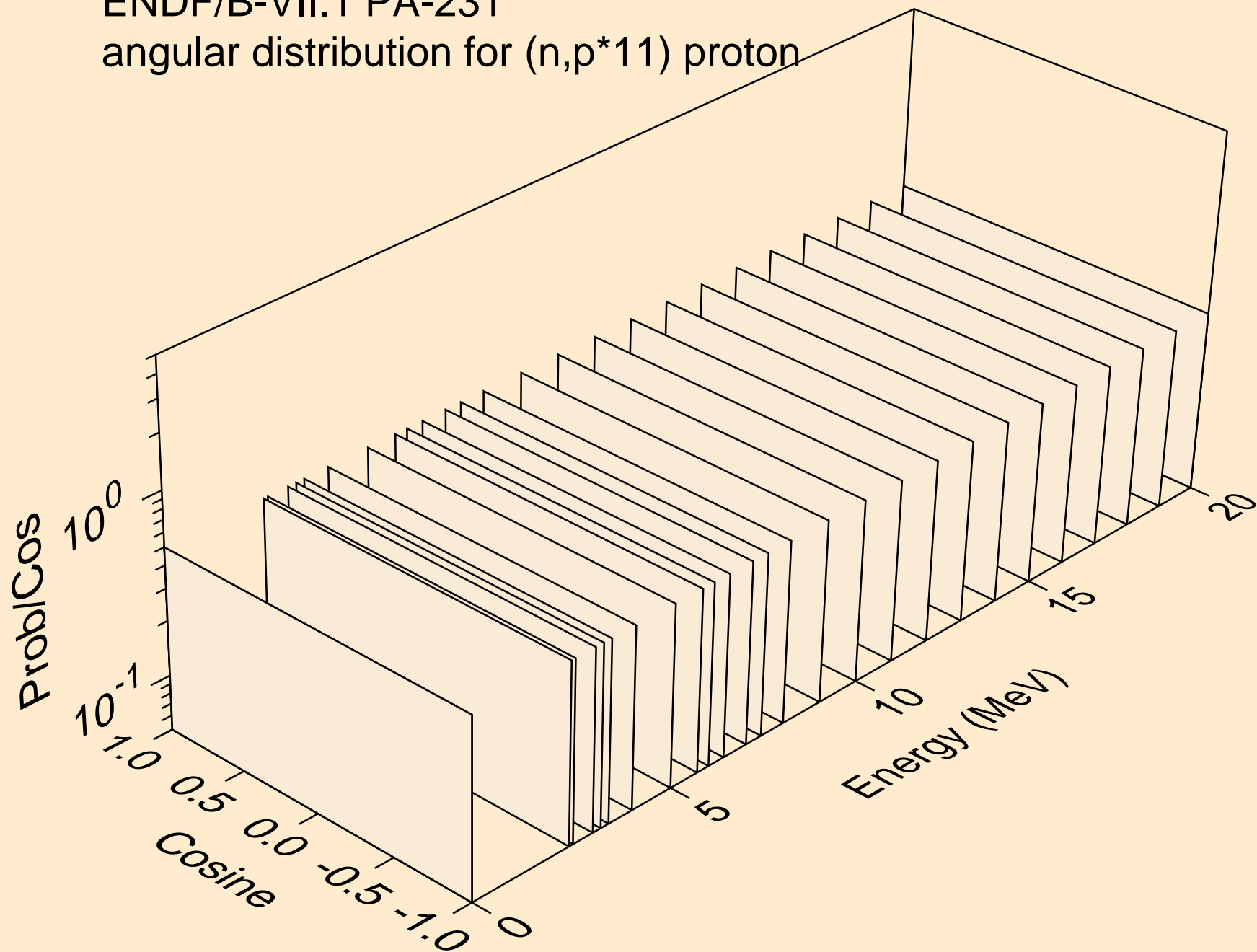

ENDF/B-VII.1 PA-231

angular distribution for (n,p*11) proton

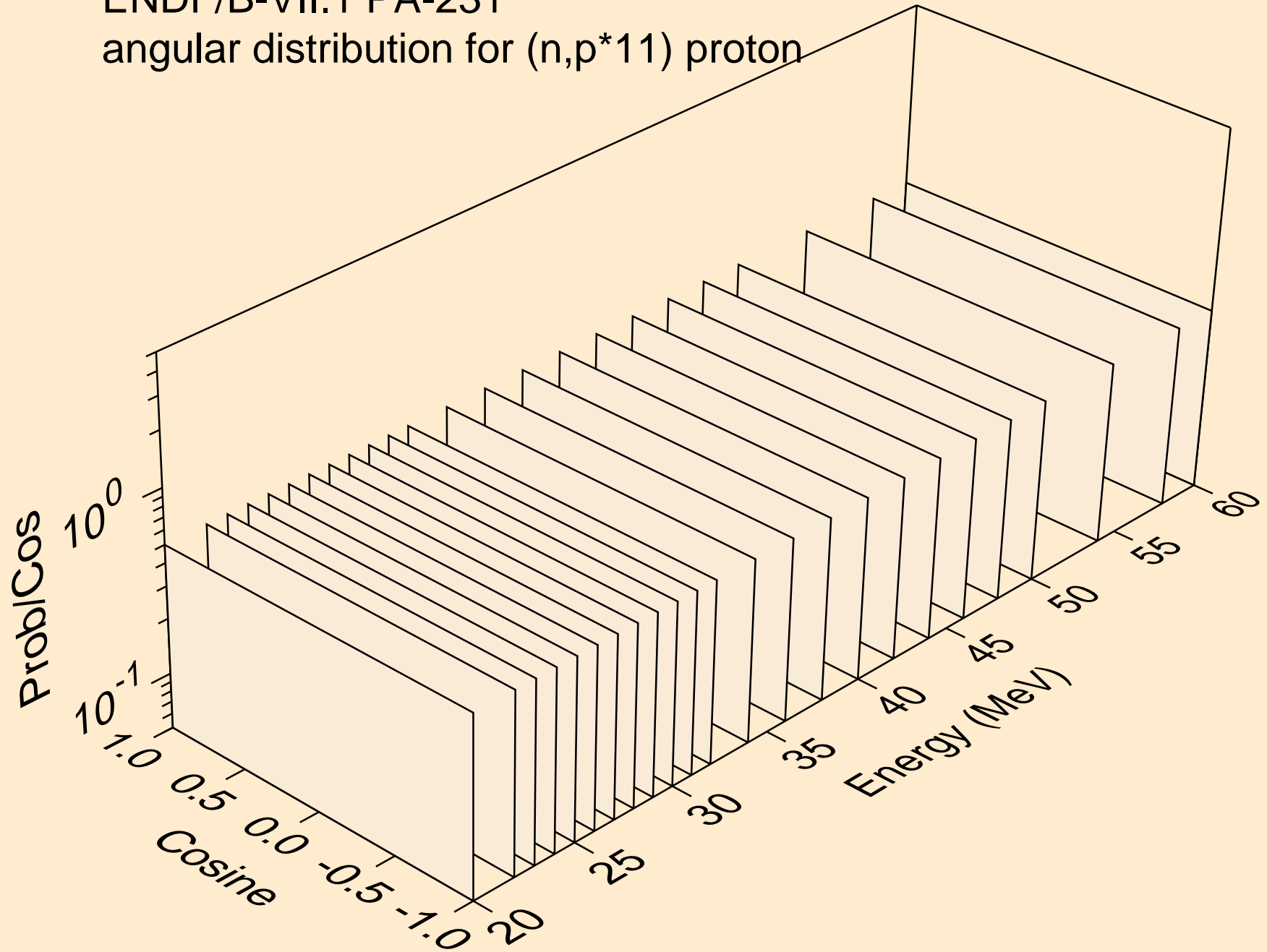

ENDF/B-VII.1 PA-231

angular distribution for (n,p*12) proton

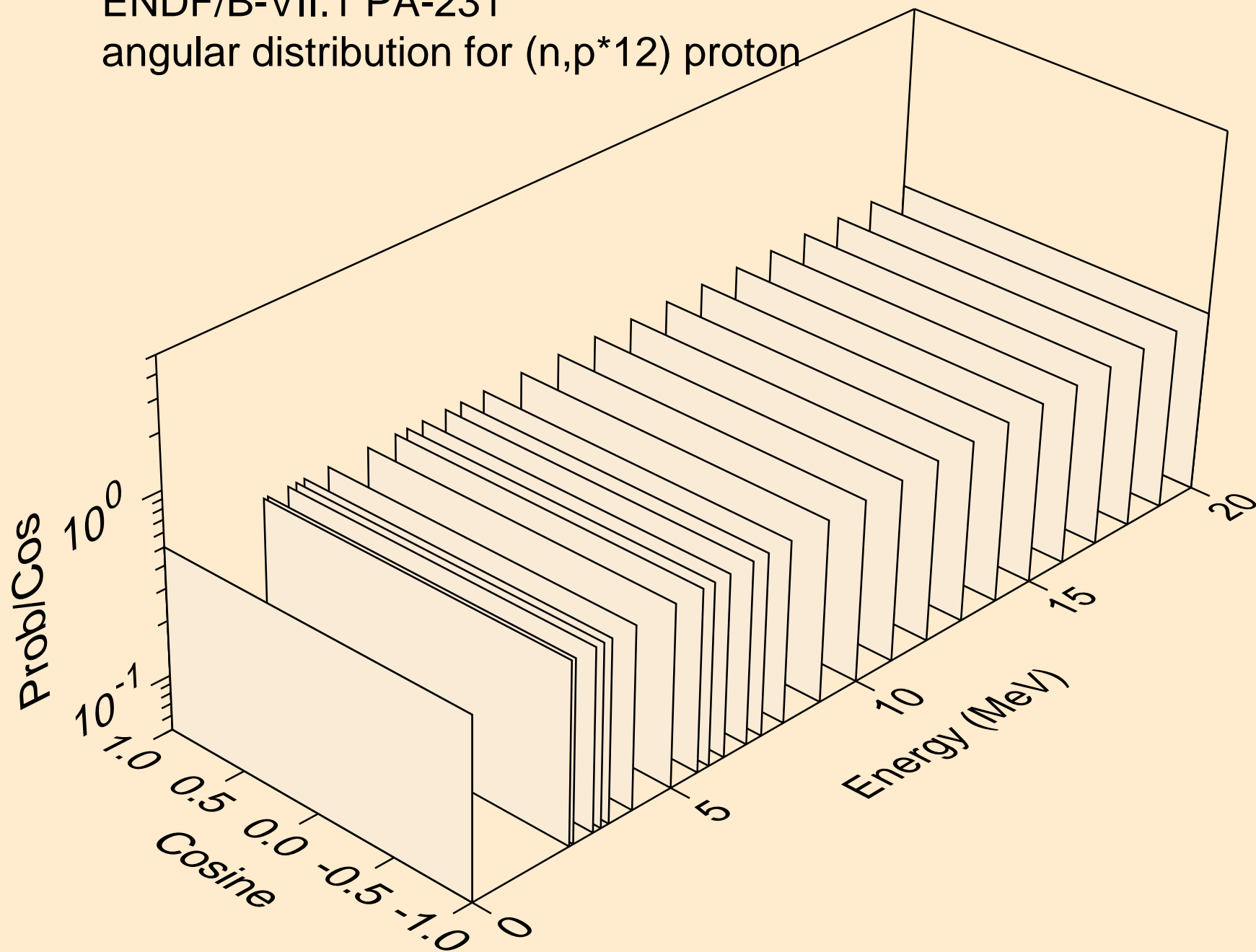

ENDF/B-VII.1 PA-231

angular distribution for (n,p*12) proton

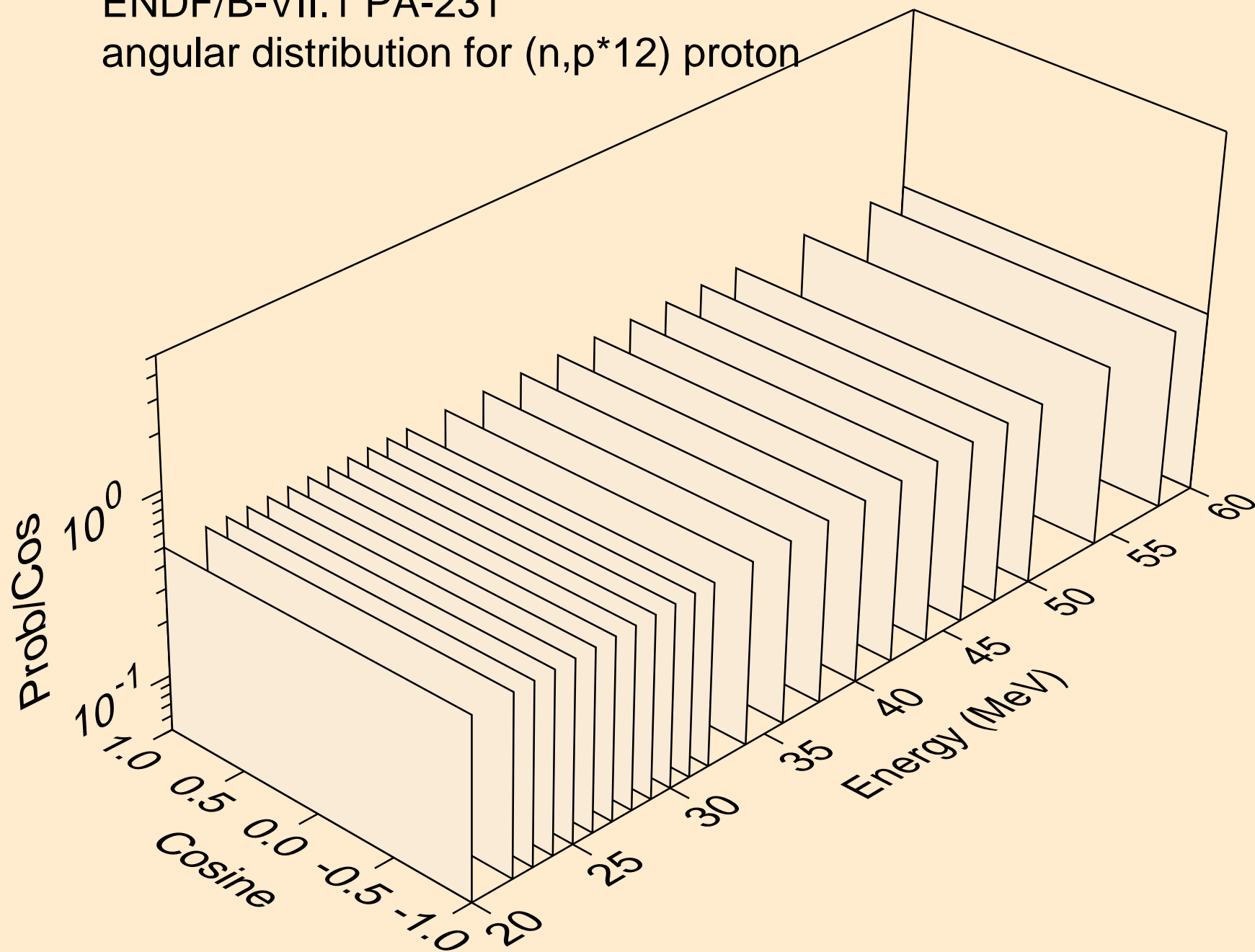

ENDF/B-VII.1 PA-231
angular distribution for (n,p*13) proton

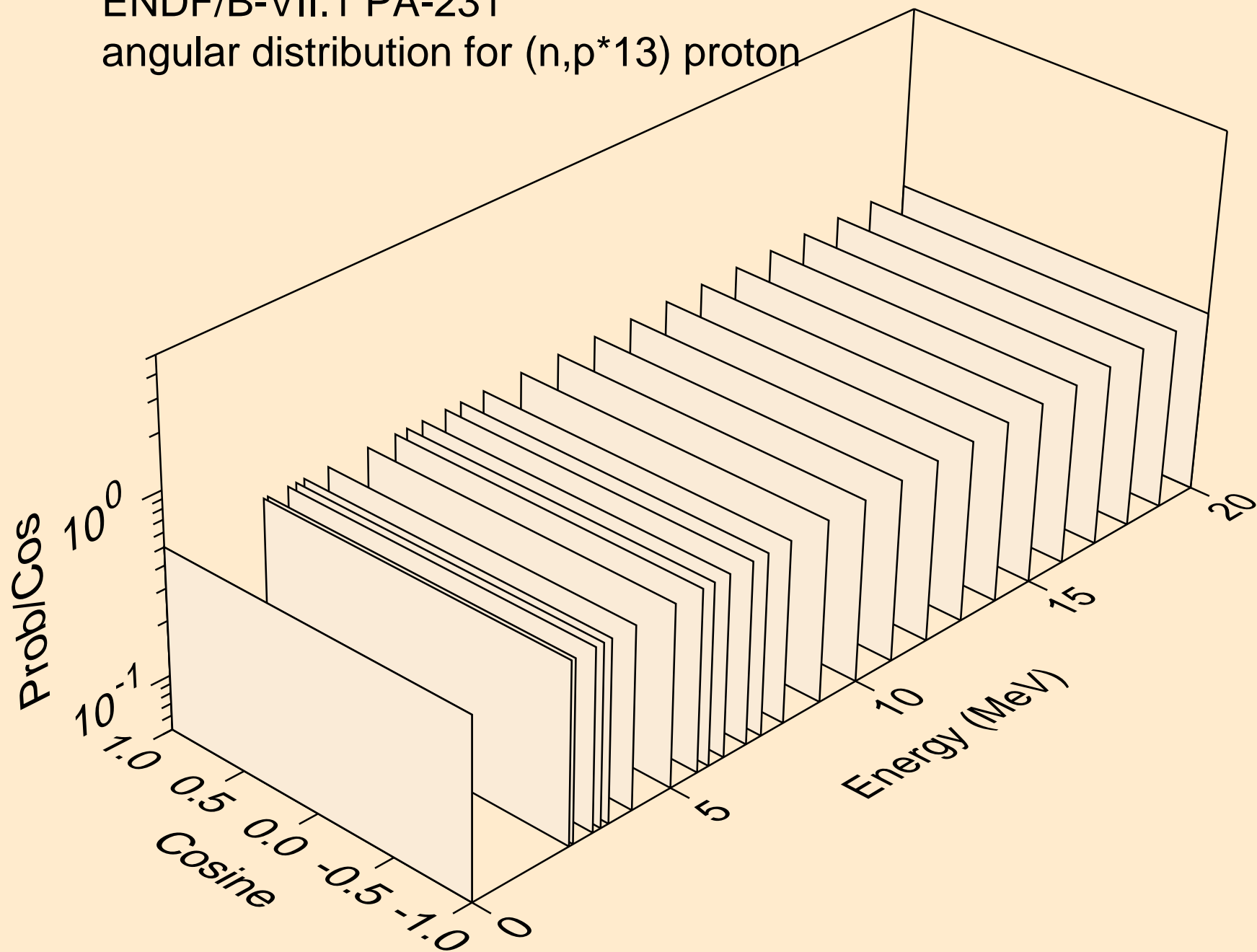

ENDF/B-VII.1 PA-231

angular distribution for (n,p*13) proton

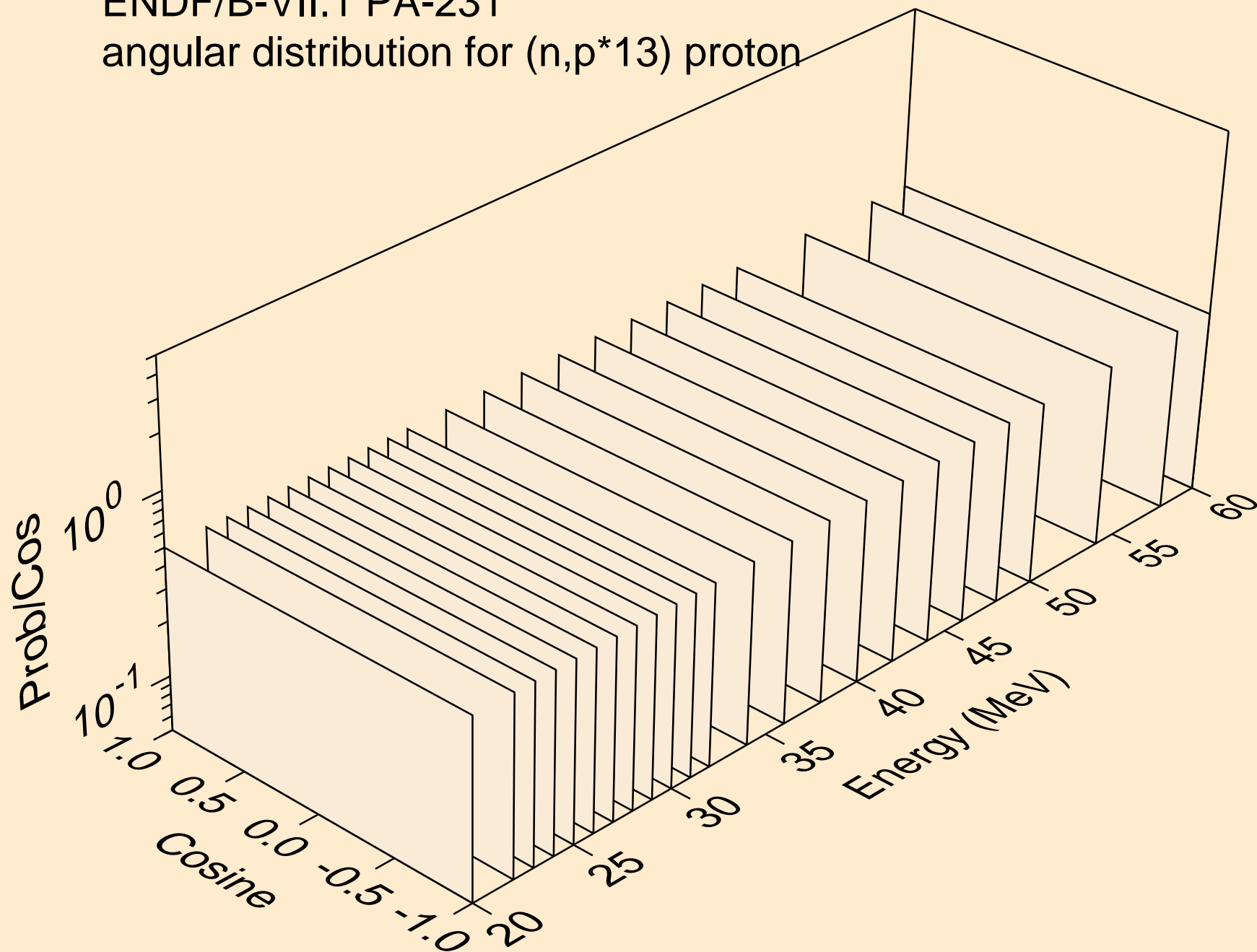

ENDF/B-VII.1 PA-231

angular distribution for (n,p*14) proton

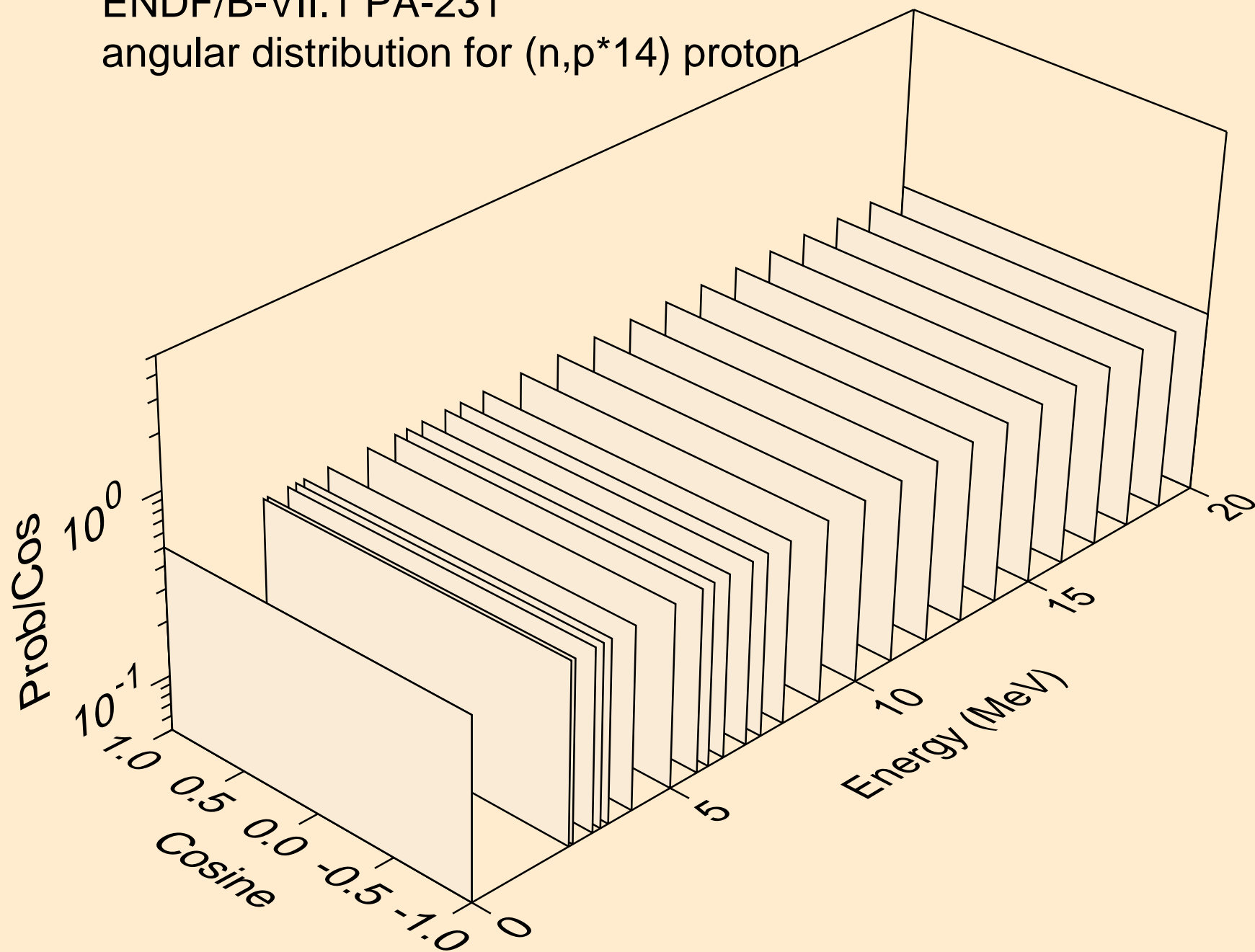

ENDF/B-VII.1 PA-231

angular distribution for (n,p*14) proton

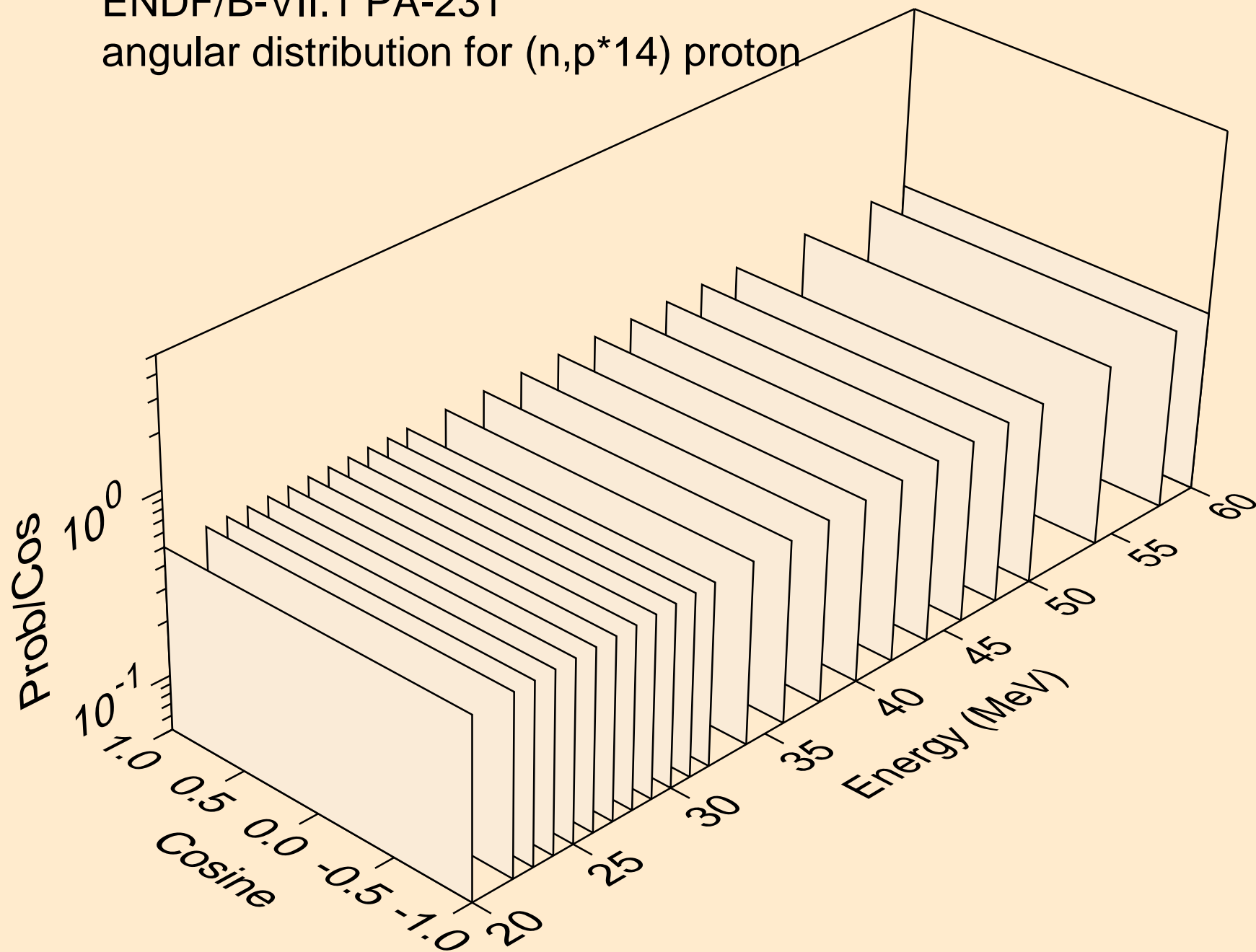

ENDF/B-VII.1 PA-231
angular distribution for (n,p*15) proton

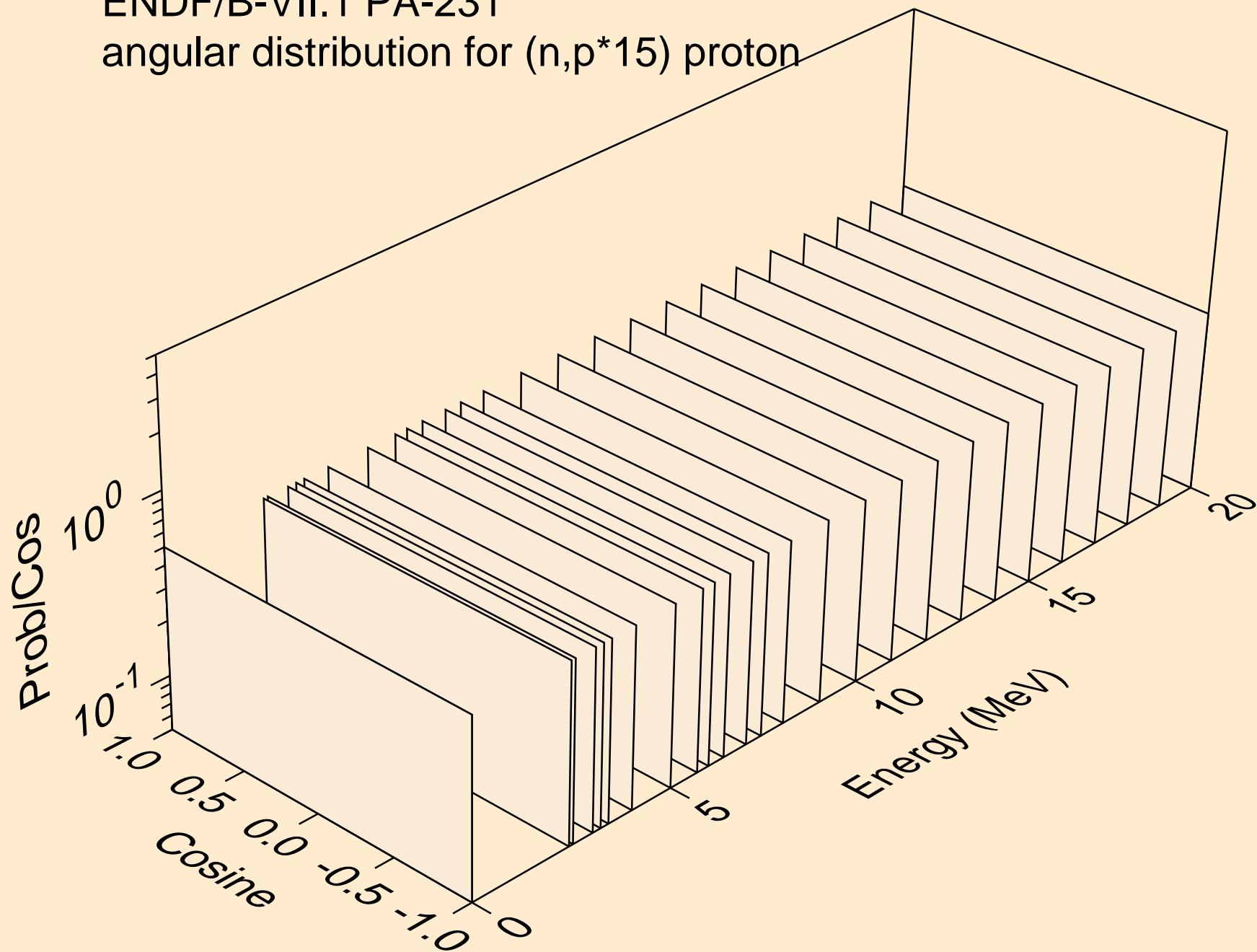

ENDF/B-VII.1 PA-231

angular distribution for (n,p*15) proton

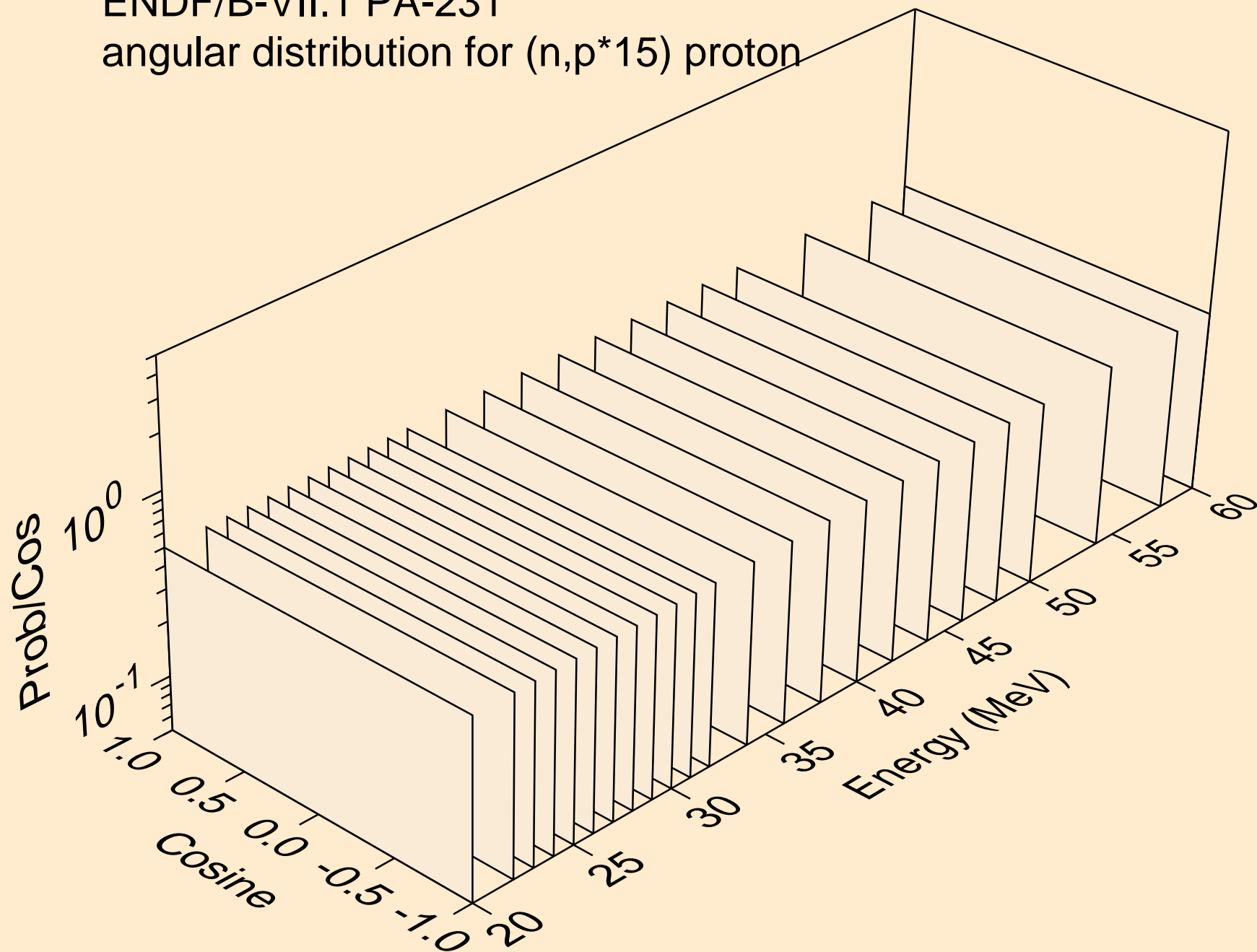

ENDF/B-VII.1 PA-231
angular distribution for (n,p*16) proton

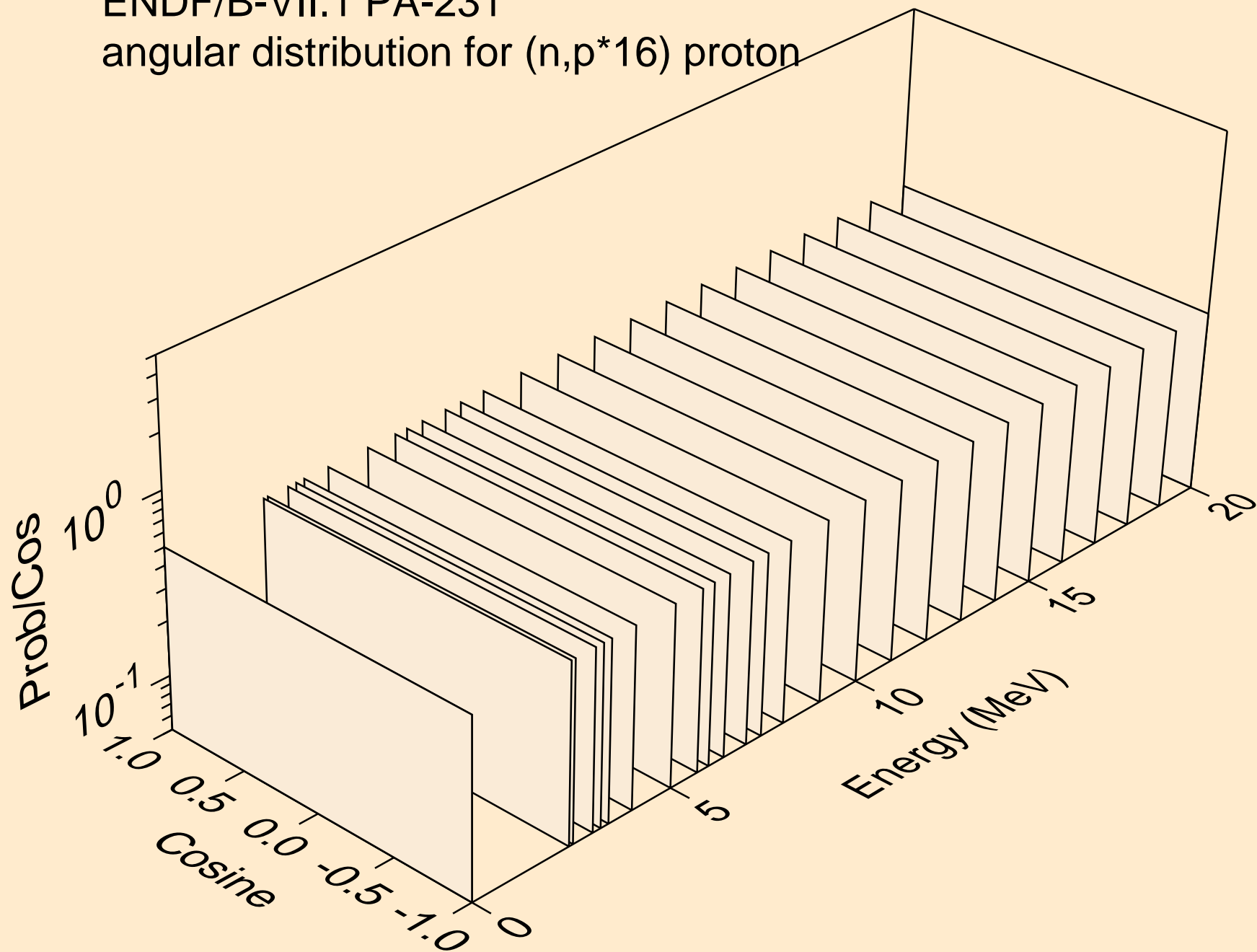

ENDF/B-VII.1 PA-231

angular distribution for (n,p*16) proton

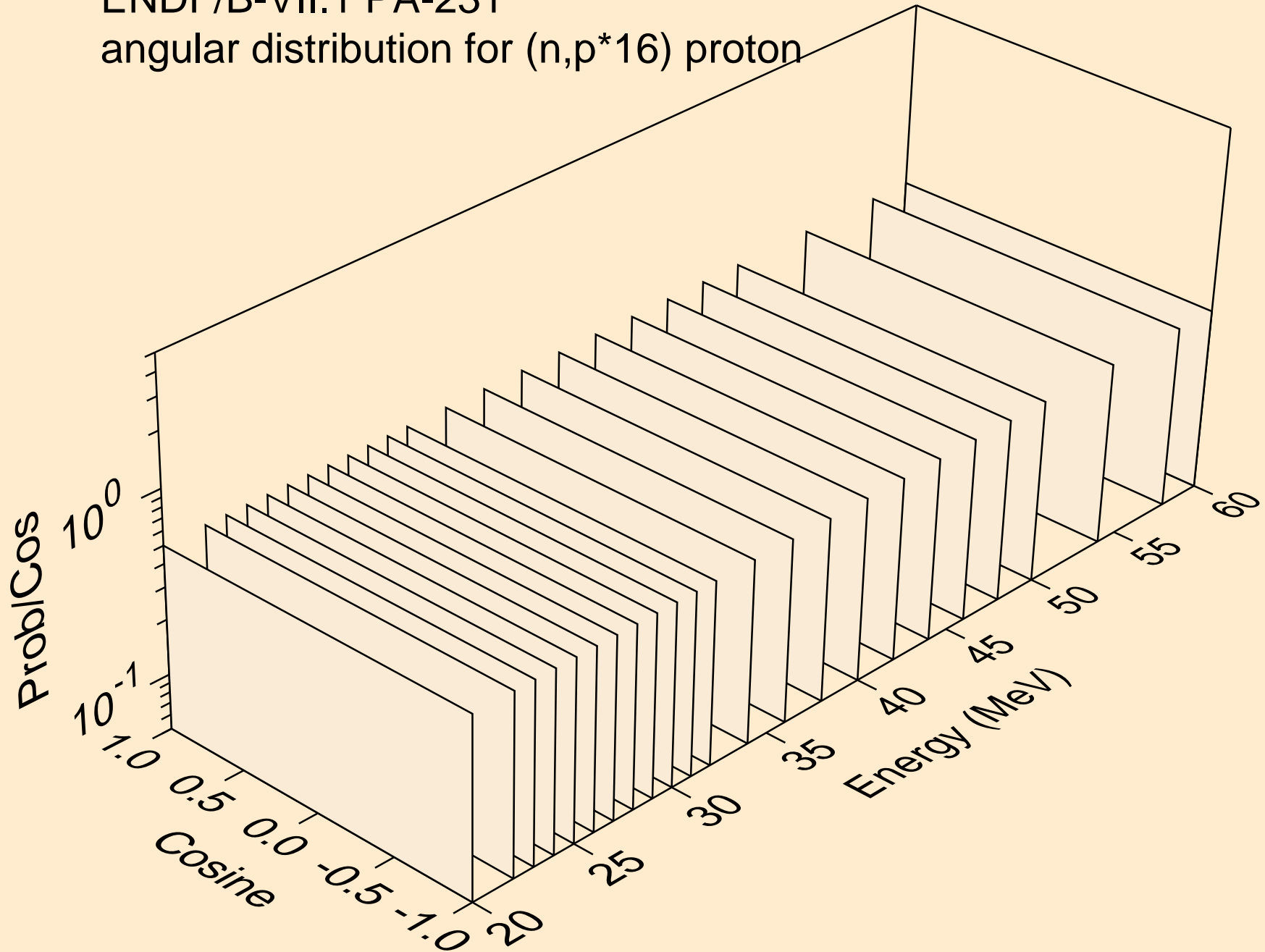

ENDF/B-VII.1 PA-231
angular distribution for (n,p*17) proton

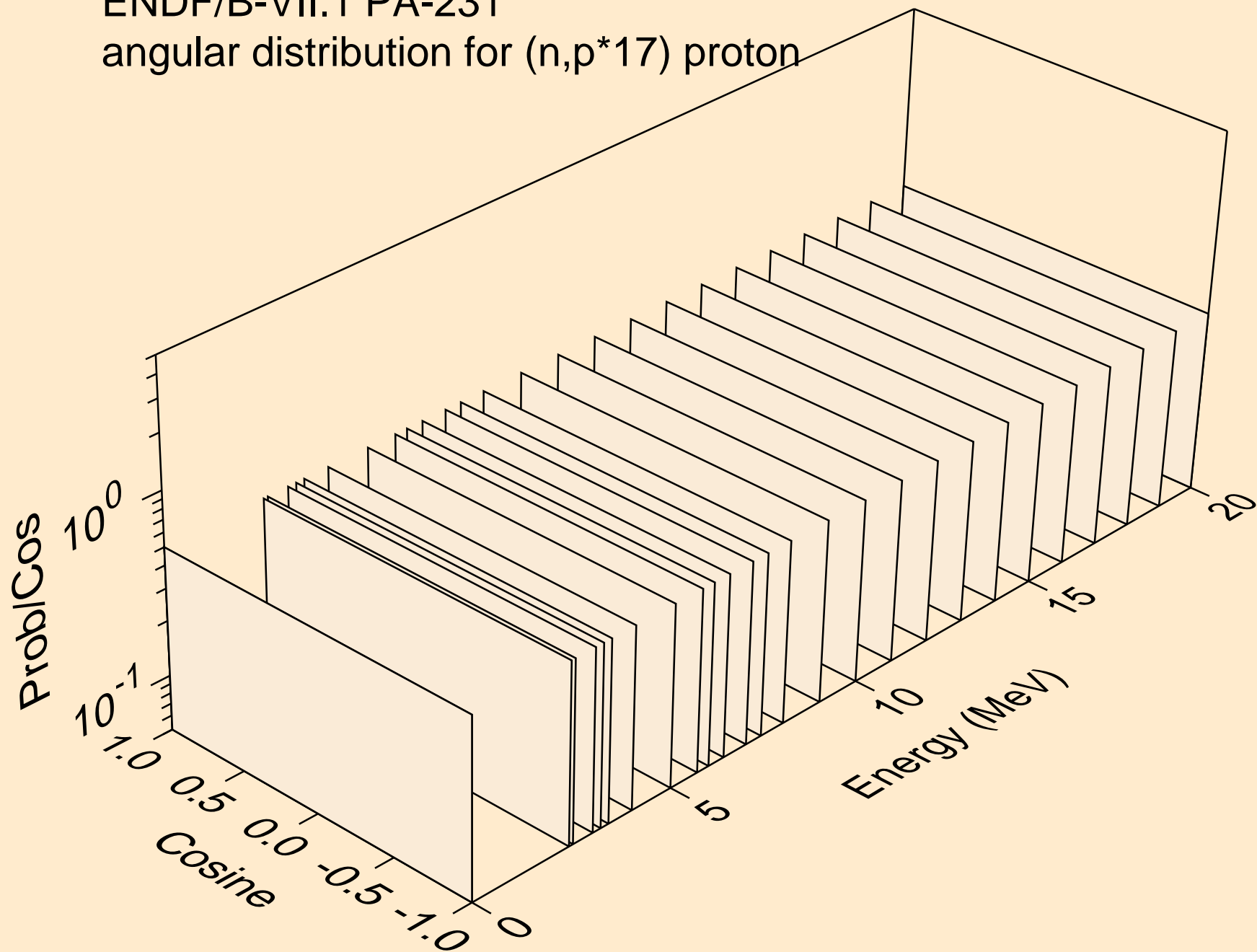

ENDF/B-VII.1 PA-231

angular distribution for (n,p*17) proton

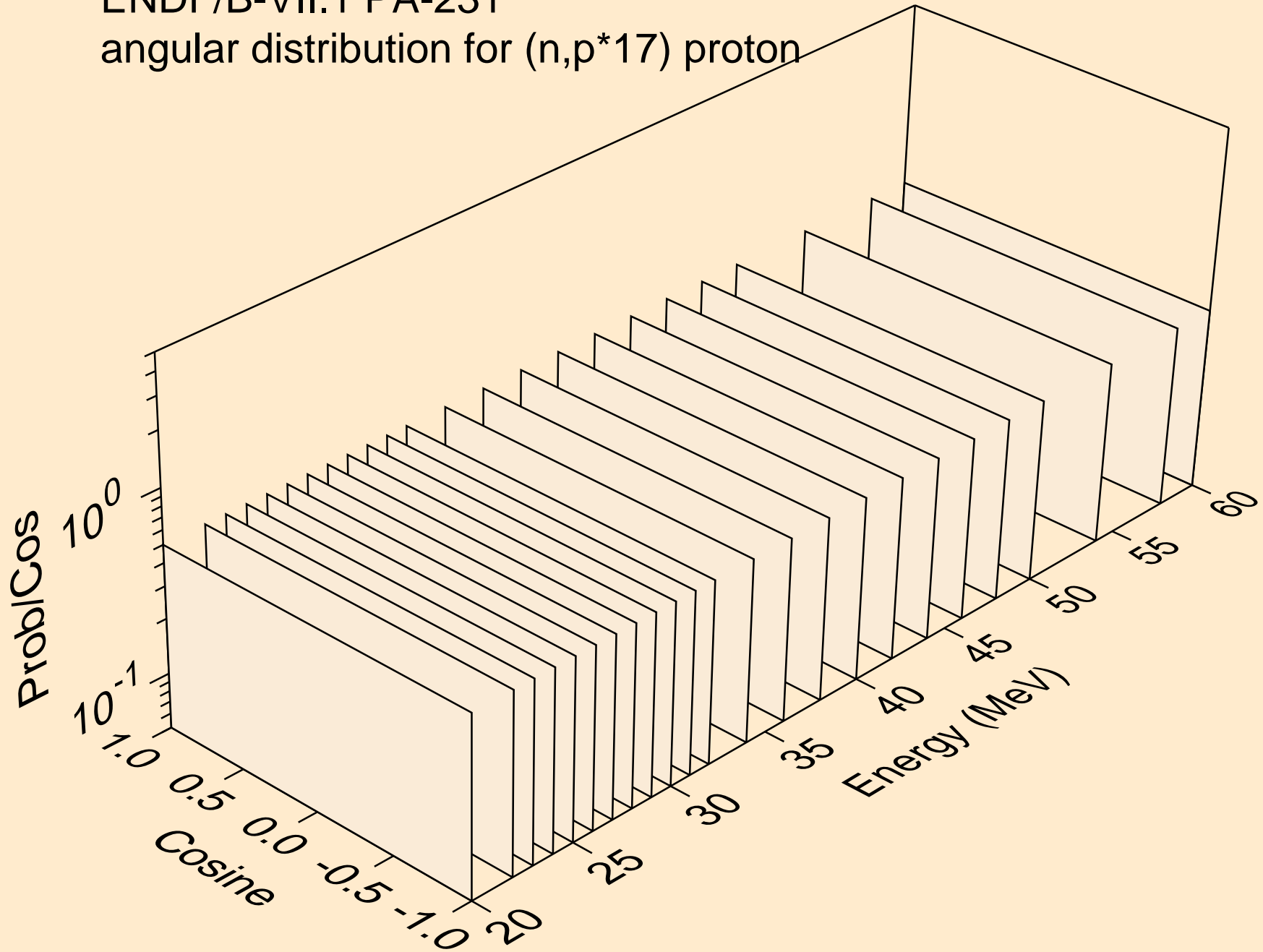

ENDF/B-VII.1 PA-231

angular distribution for (n,p*18) proton

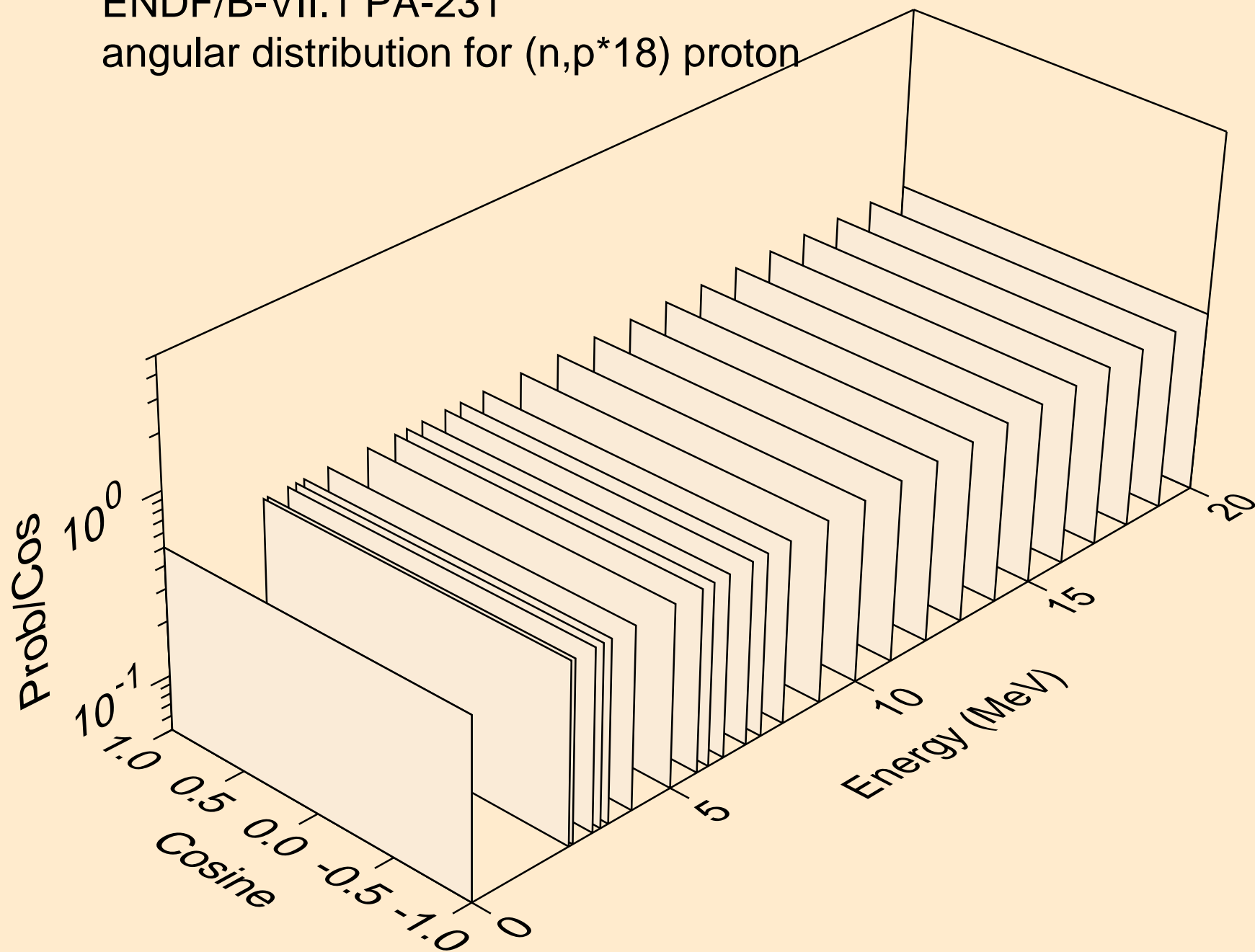

ENDF/B-VII.1 PA-231

angular distribution for (n,p*18) proton

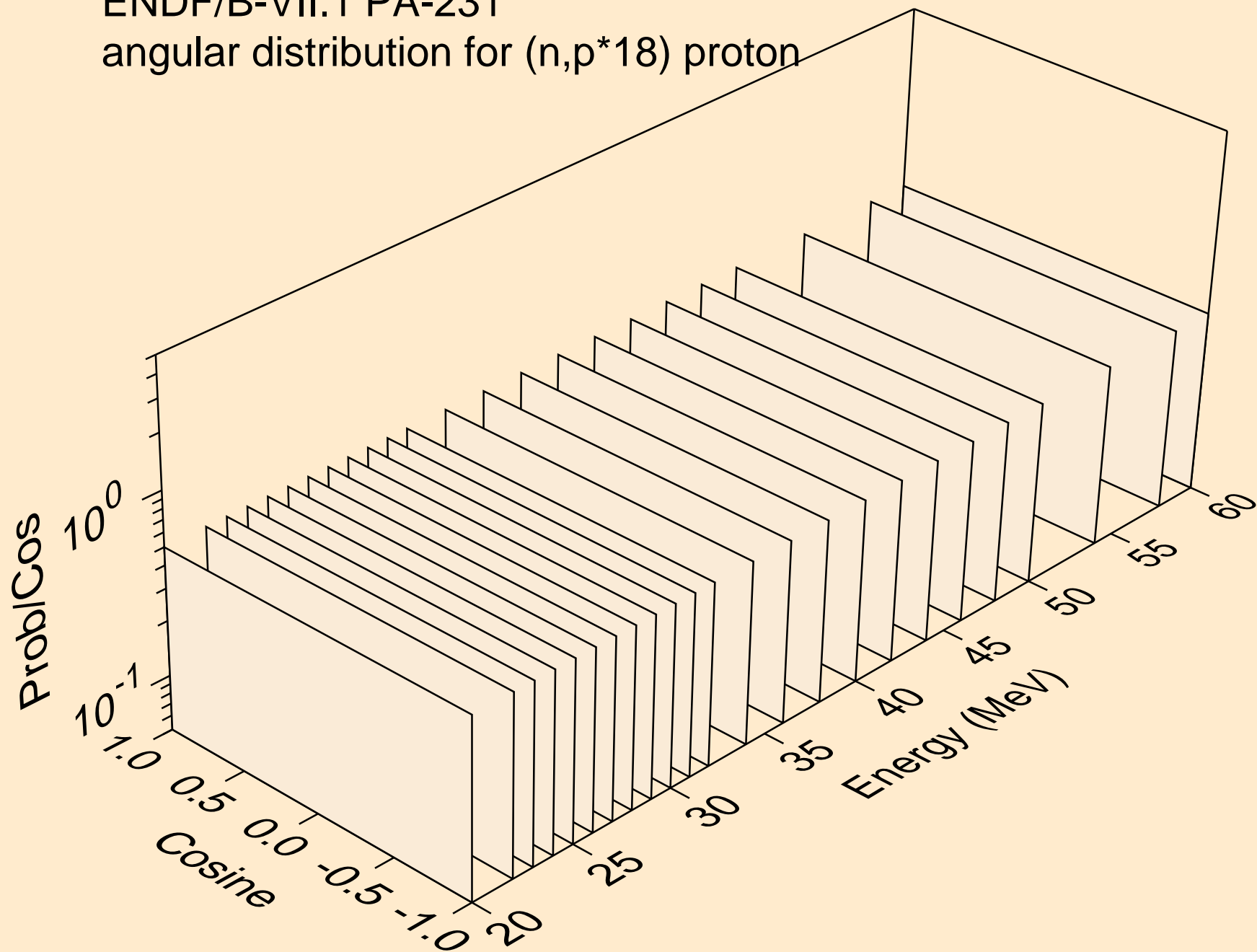

ENDF/B-VII.1 PA-231
angular distribution for (n,p*19) proton

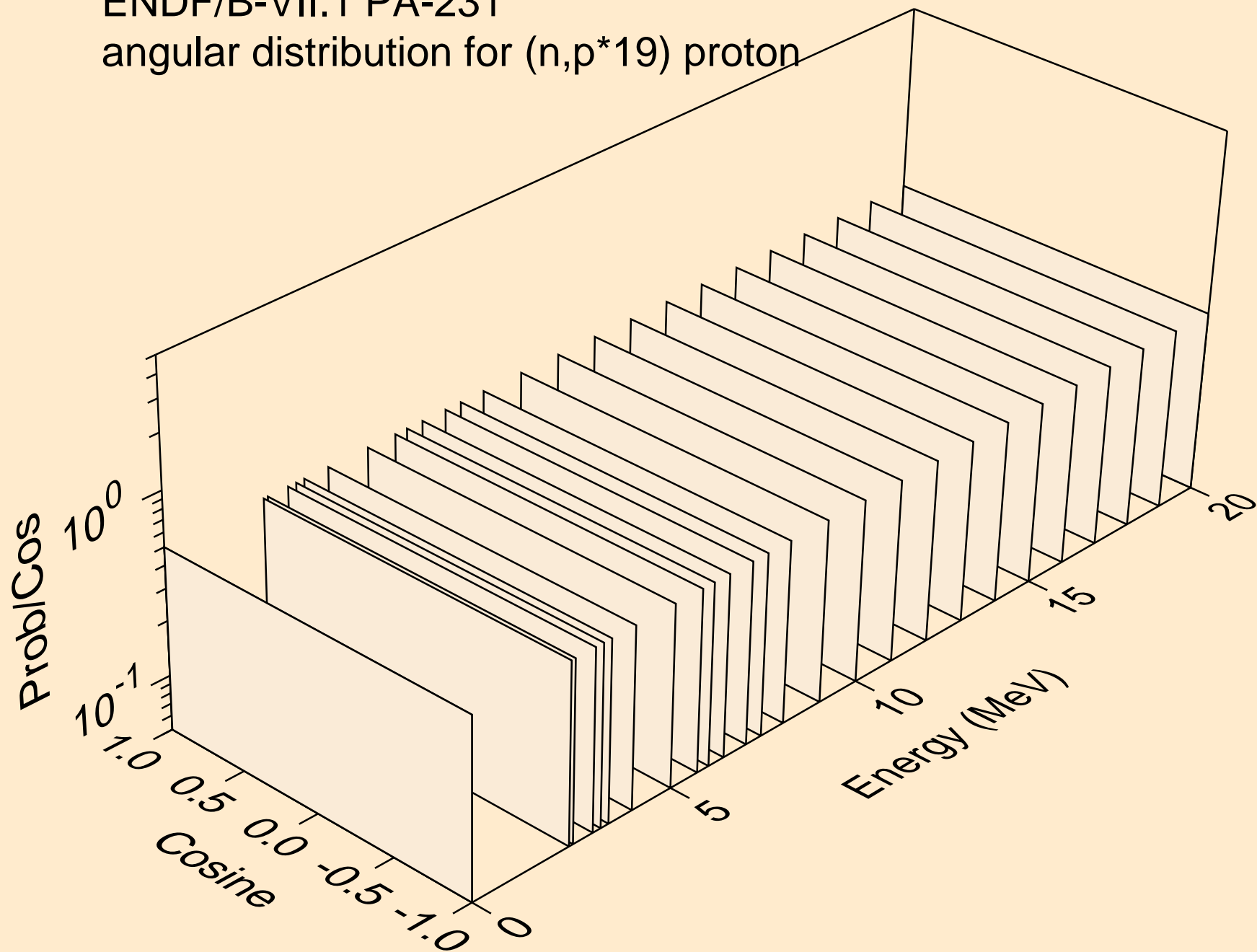

ENDF/B-VII.1 PA-231

angular distribution for (n,p*19) proton

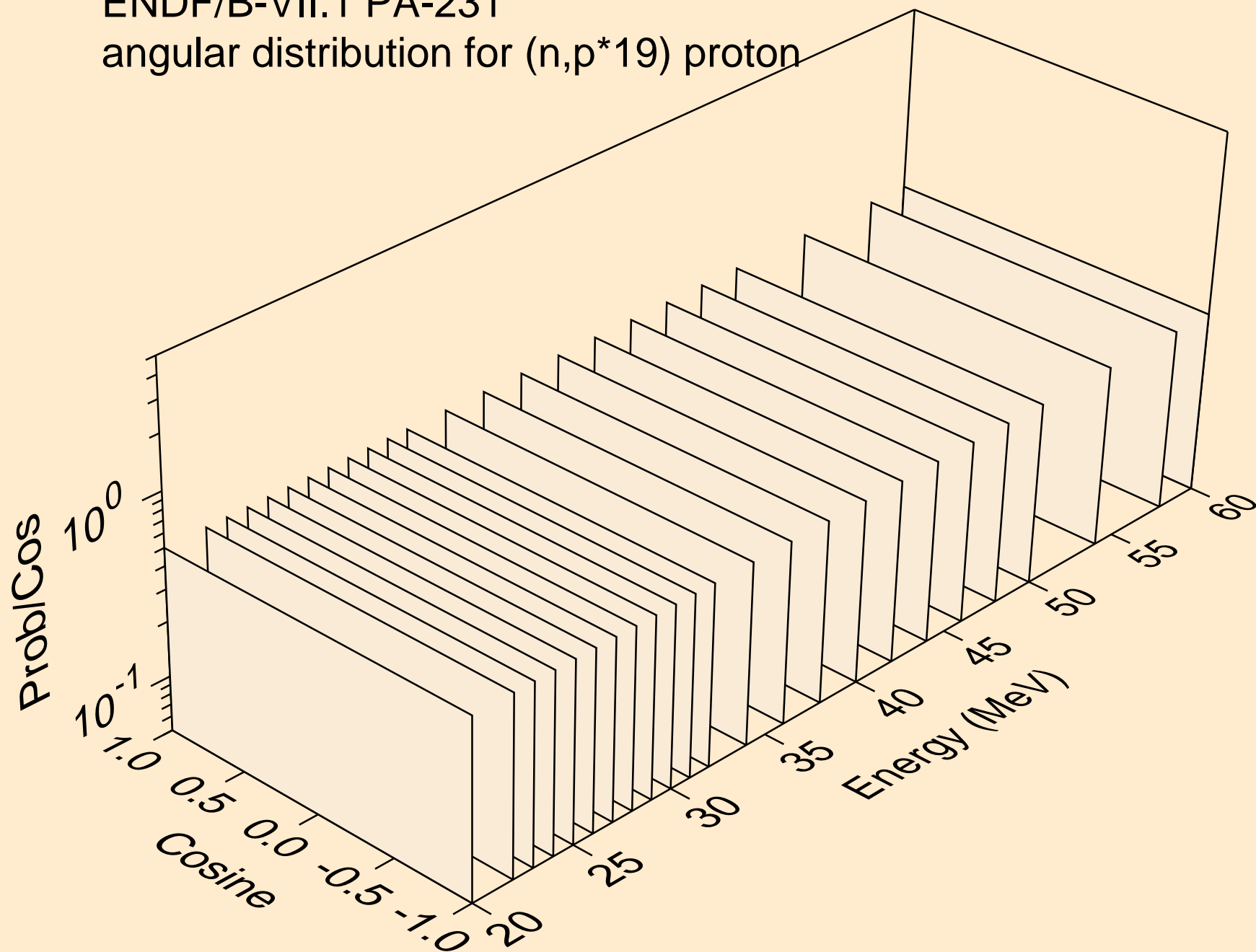

ENDF/B-VII.1 PA-231

angular distribution for (n,p*20) proton

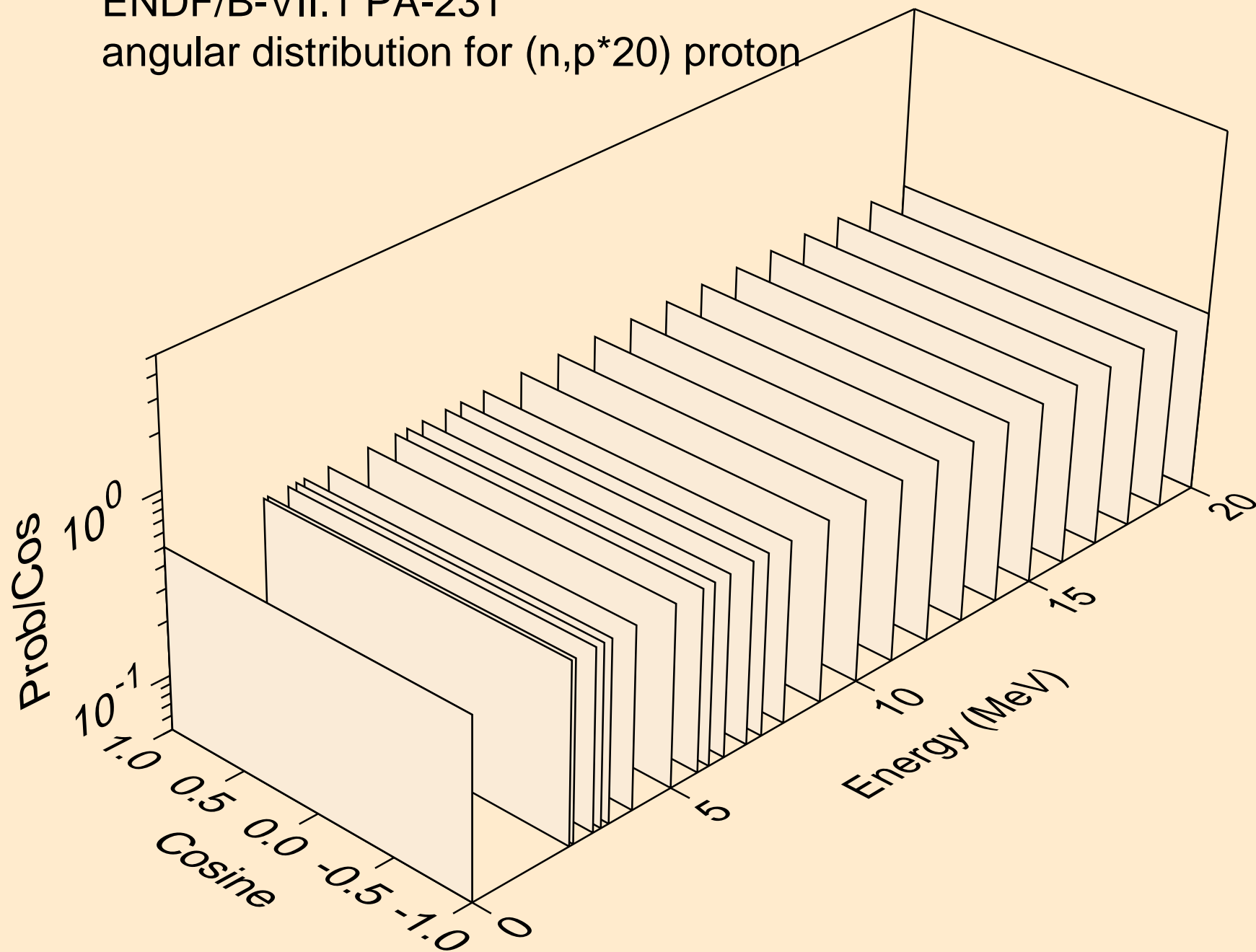

ENDF/B-VII.1 PA-231

angular distribution for (n,p*20) proton

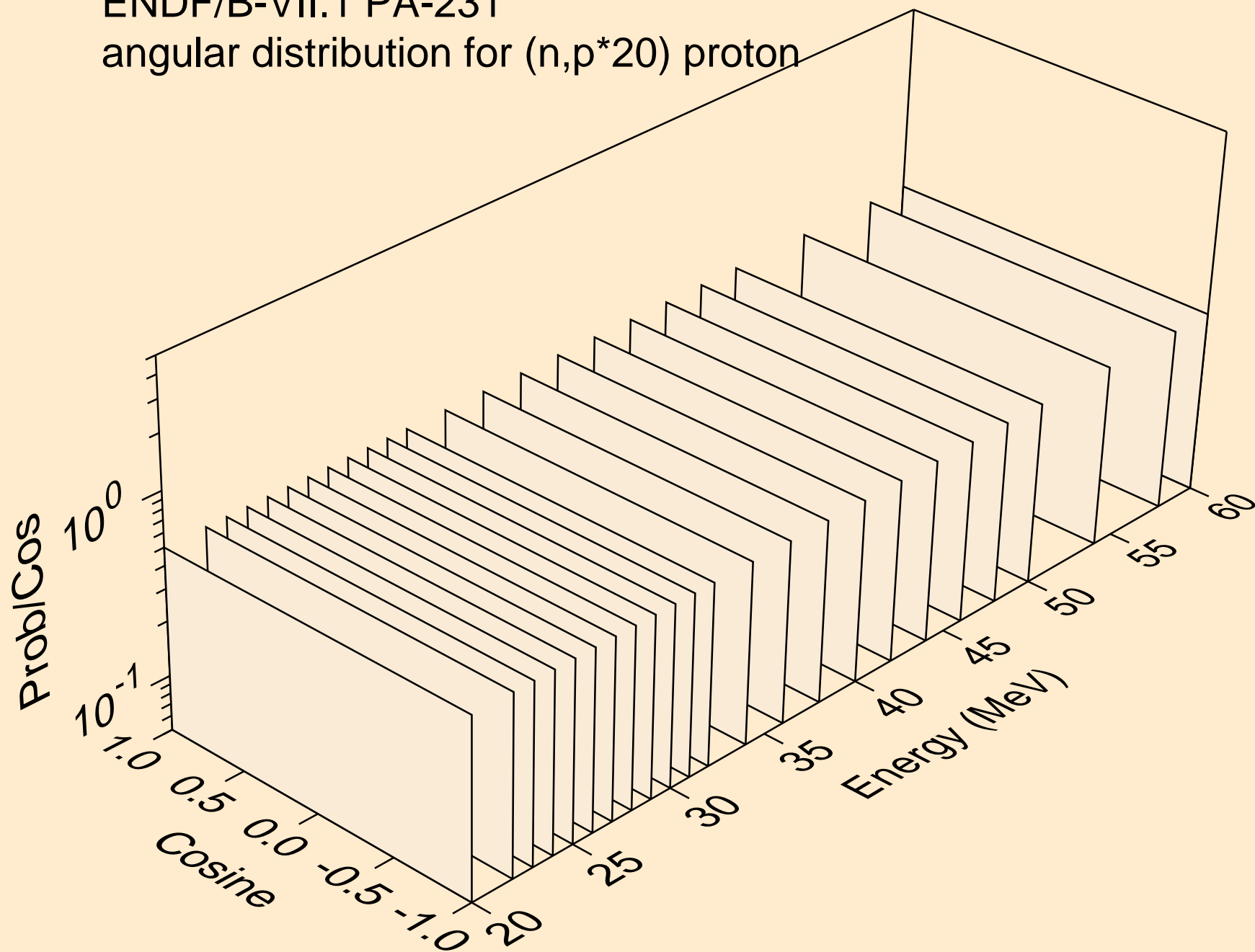

ENDF/B-VII.1 PA-231
angular distribution for (n,p*21) proton

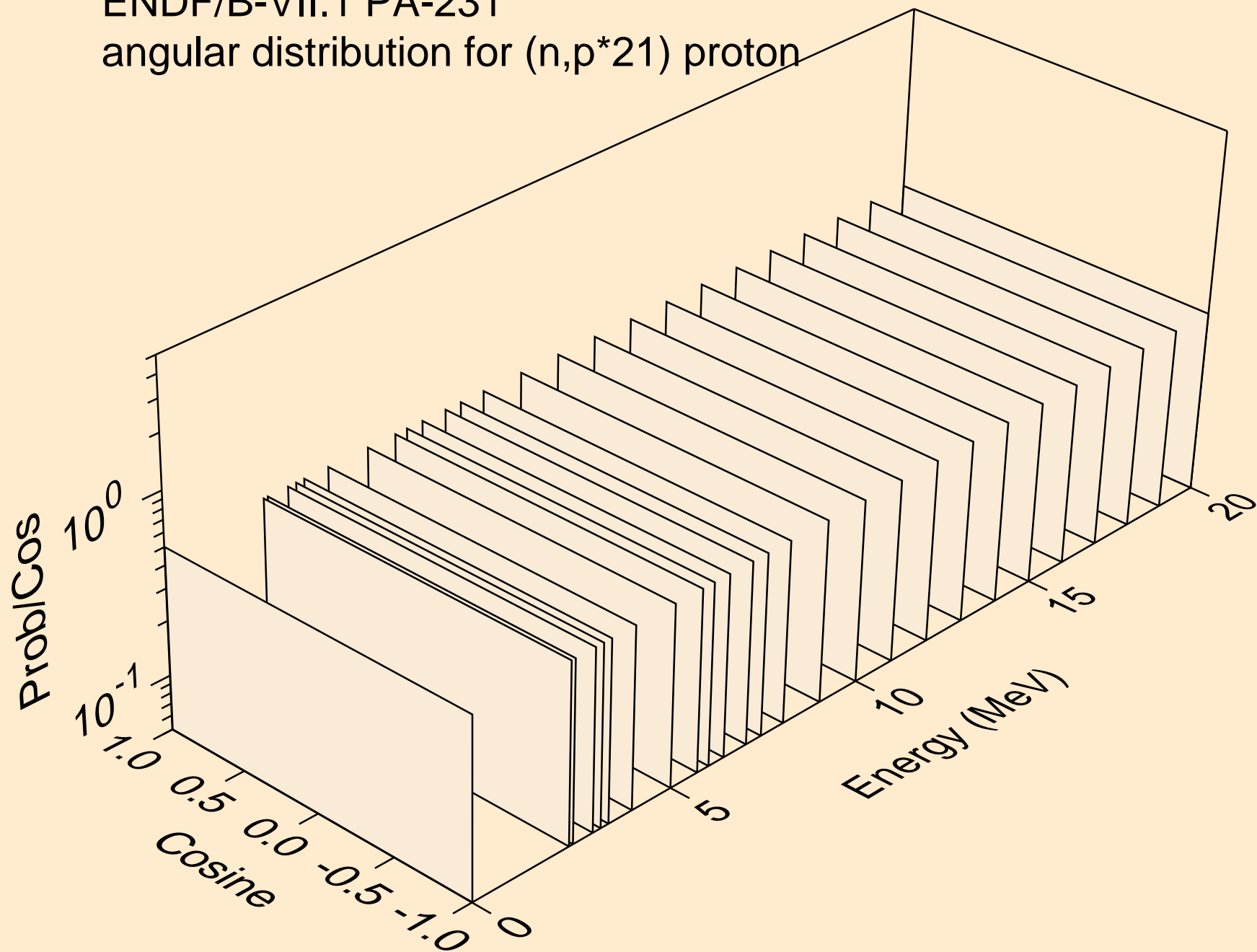

ENDF/B-VII.1 PA-231

angular distribution for (n,p*21) proton

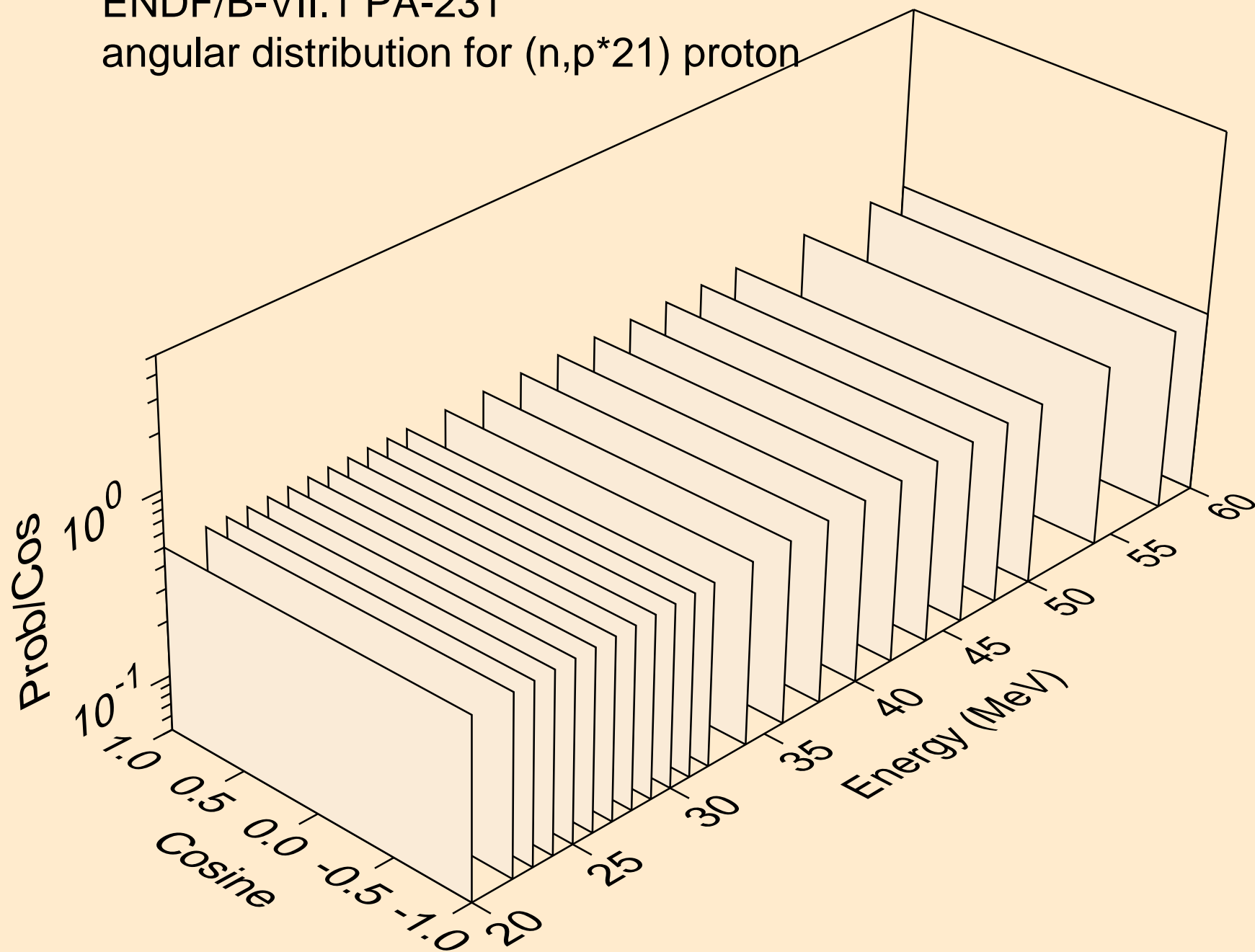

ENDF/B-VII.1 PA-231
angular distribution for (n,p*22) proton

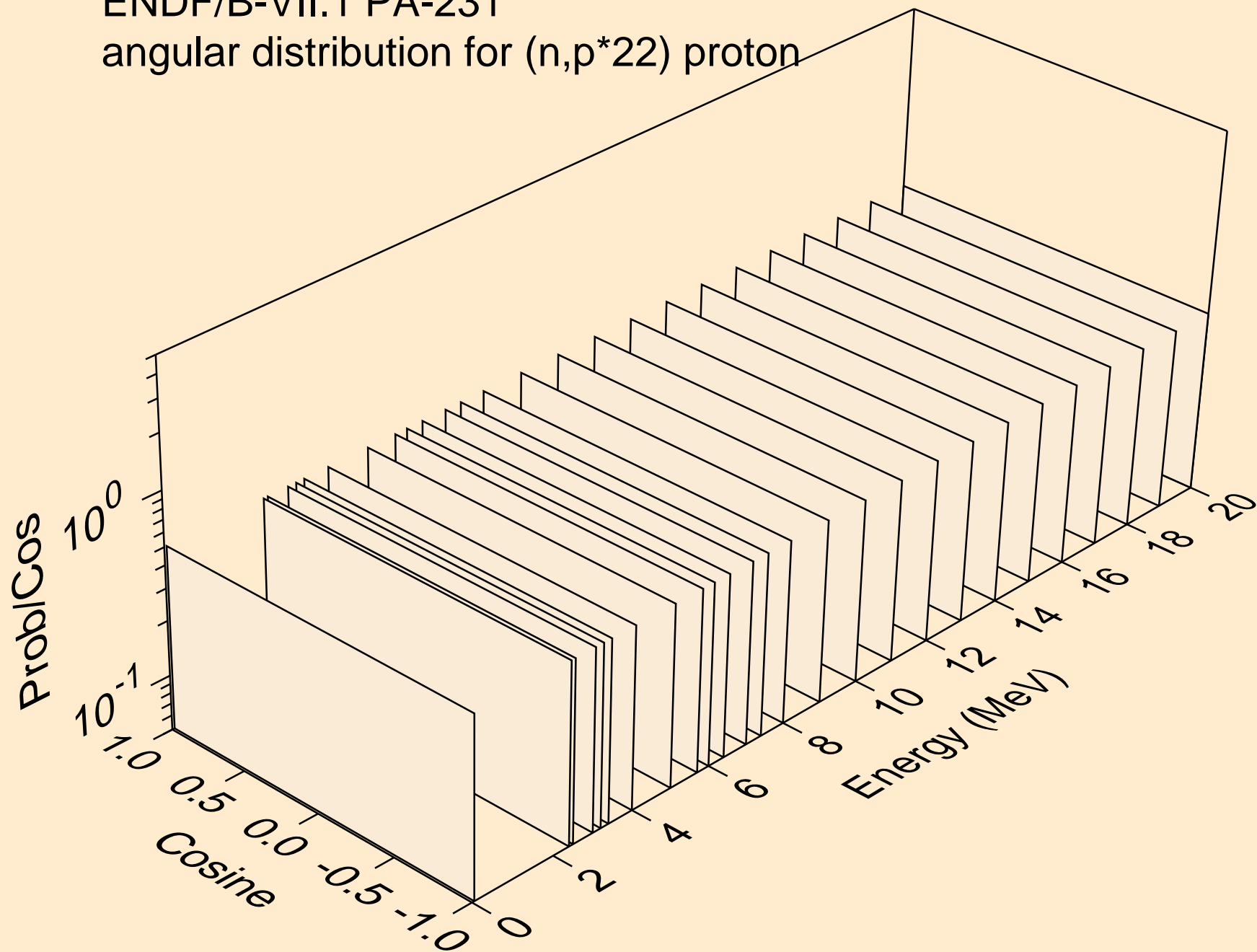

ENDF/B-VII.1 PA-231

angular distribution for (n,p*22) proton

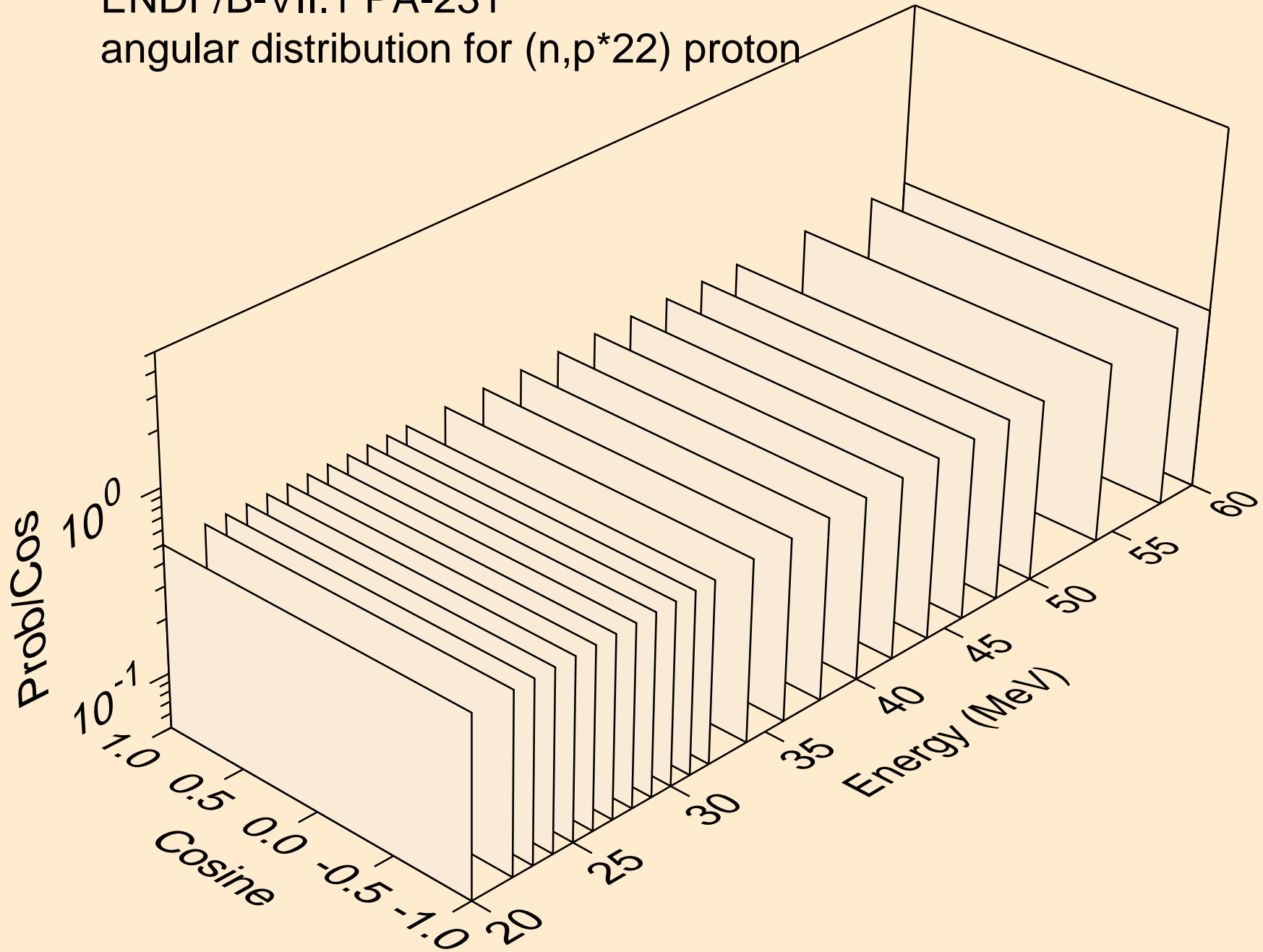

ENDF/B-VII.1 PA-231
angular distribution for (n,p*23) proton

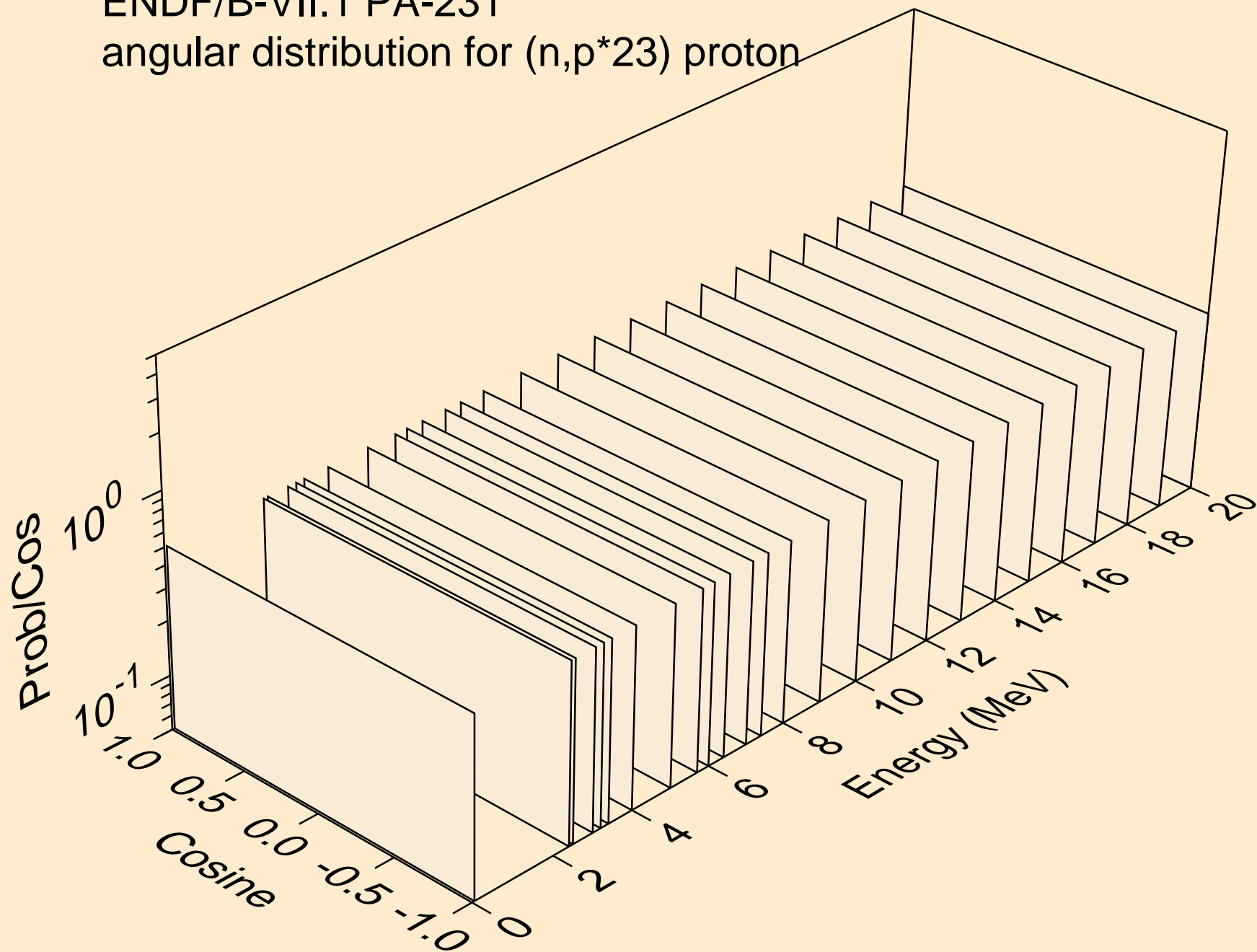

ENDF/B-VII.1 PA-231

angular distribution for (n,p*23) proton

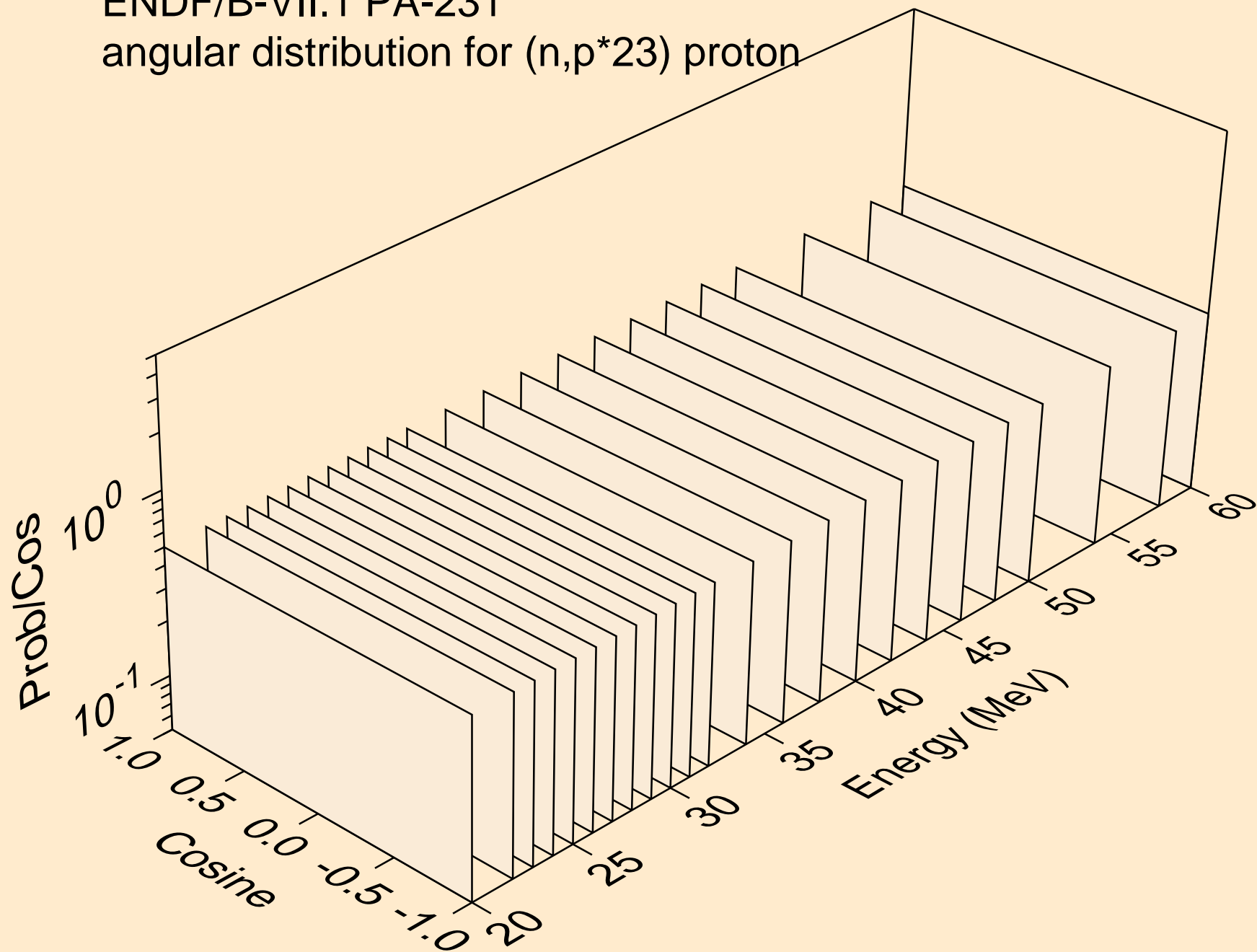

ENDF/B-VII.1 PA-231

angular distribution for (n,p*24) proton

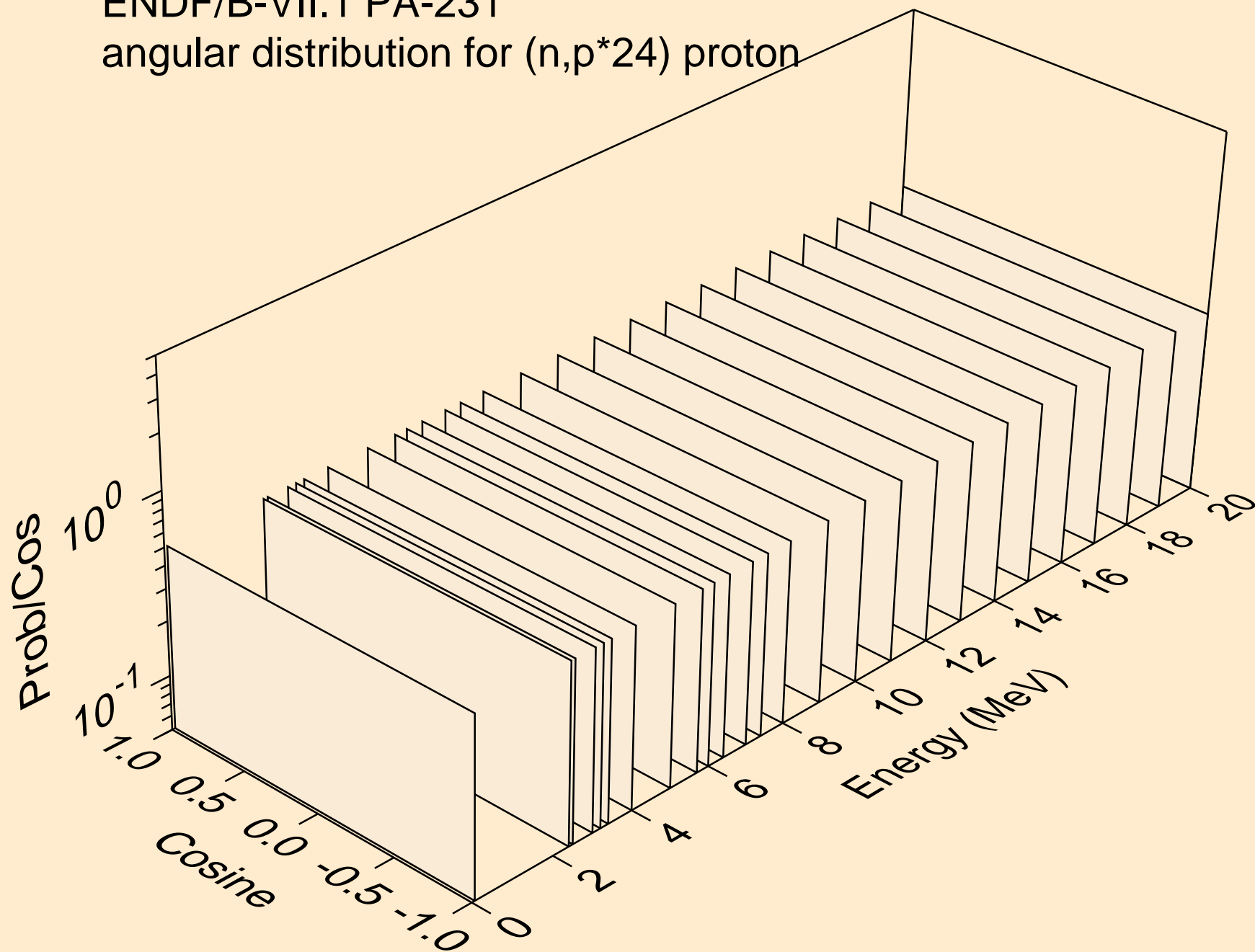

ENDF/B-VII.1 PA-231

angular distribution for (n,p*24) proton

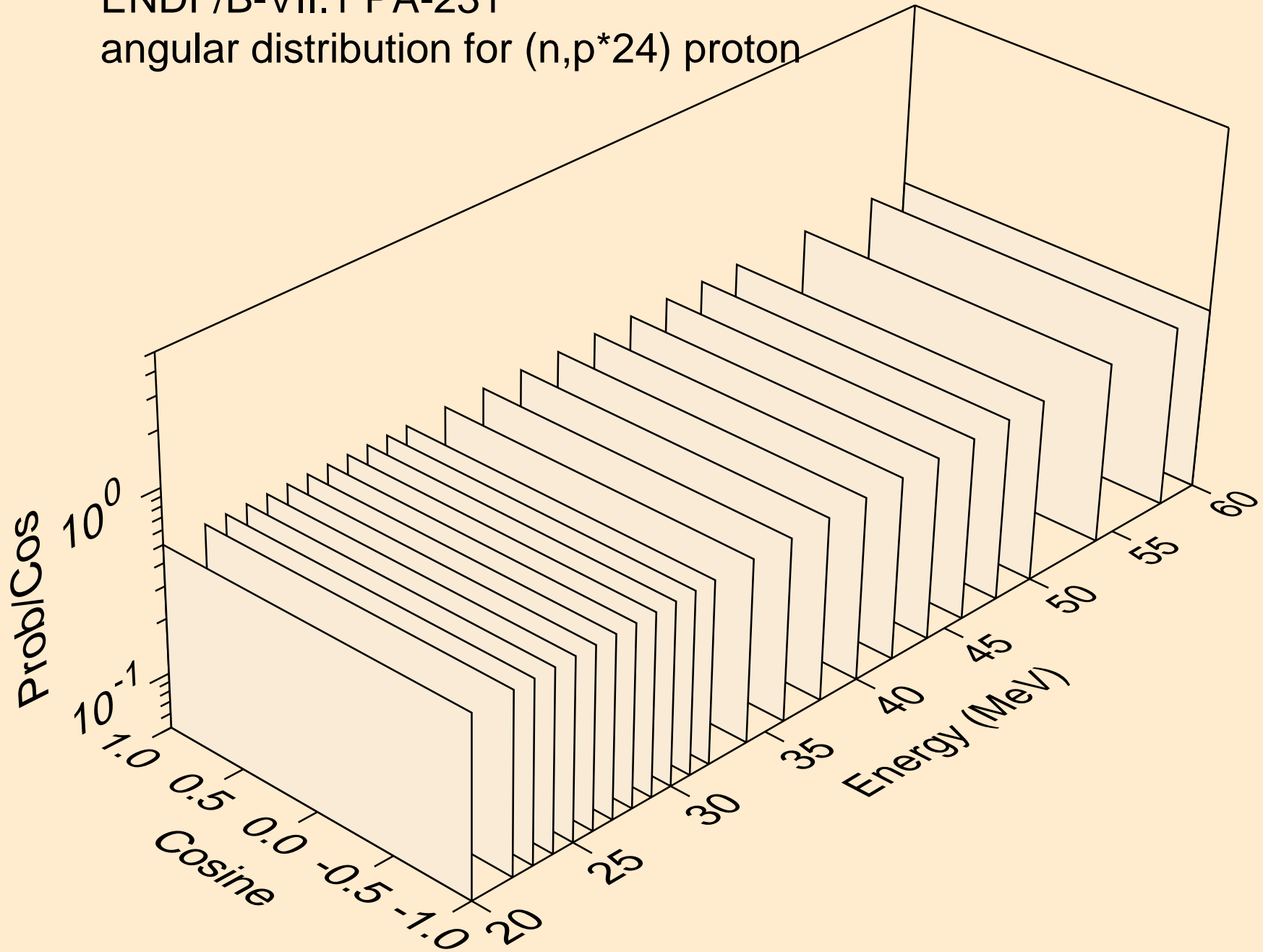

ENDF/B-VII.1 PA-231

angular distribution for (n,p*25) proton

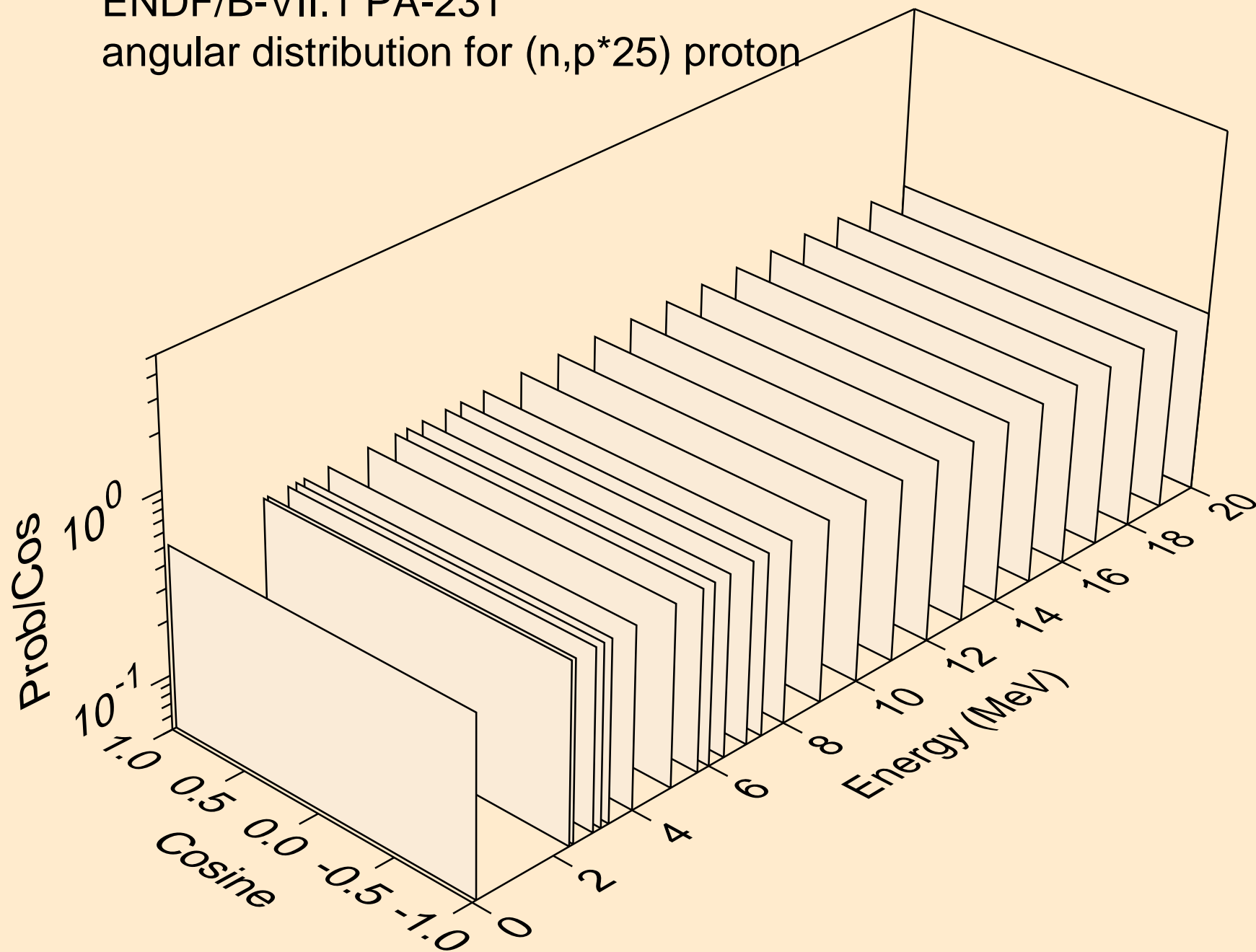

ENDF/B-VII.1 PA-231

angular distribution for (n,p*25) proton

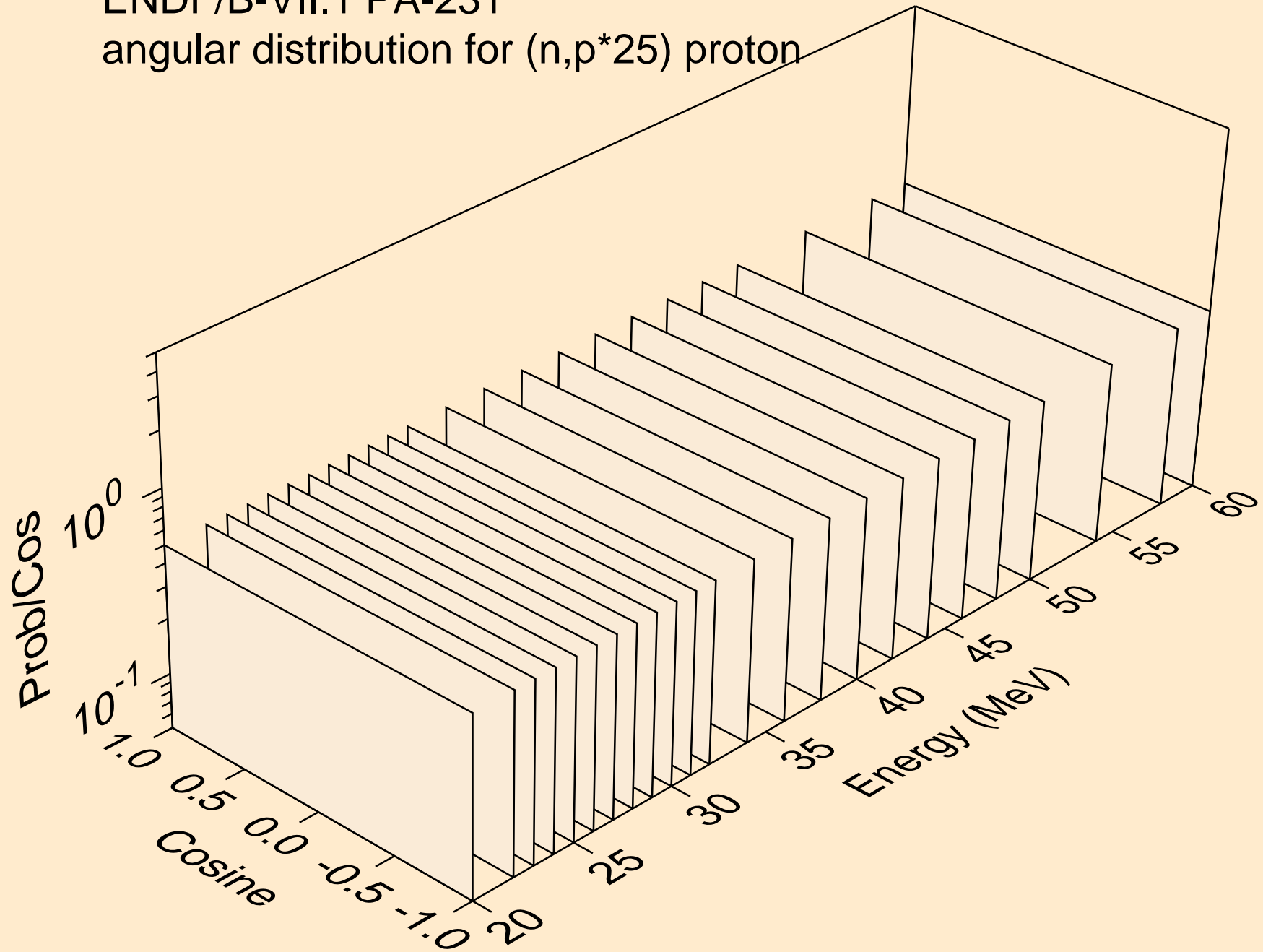

ENDF/B-VII.1 PA-231

angular distribution for (n,p*26) proton

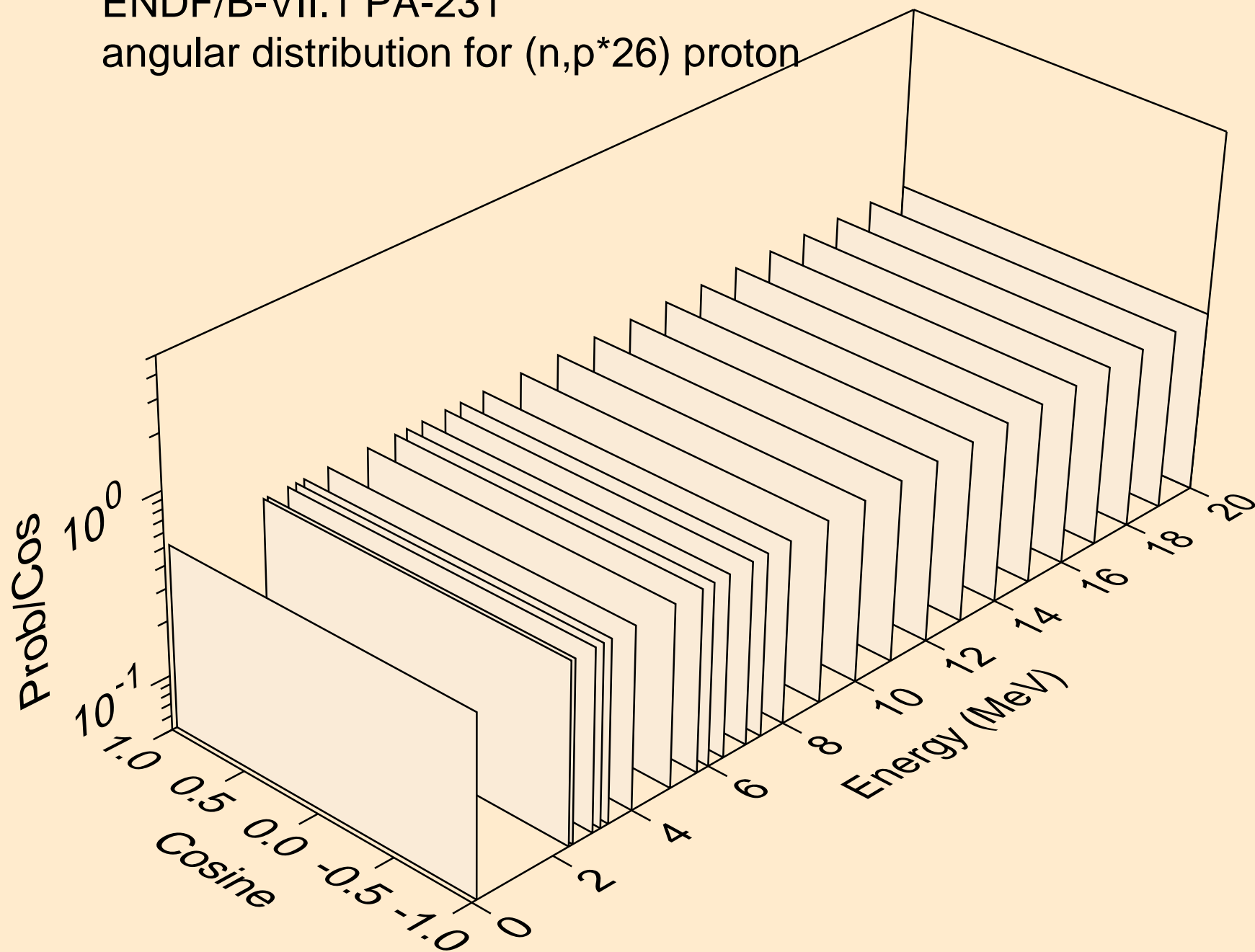

ENDF/B-VII.1 PA-231

angular distribution for (n,p*26) proton

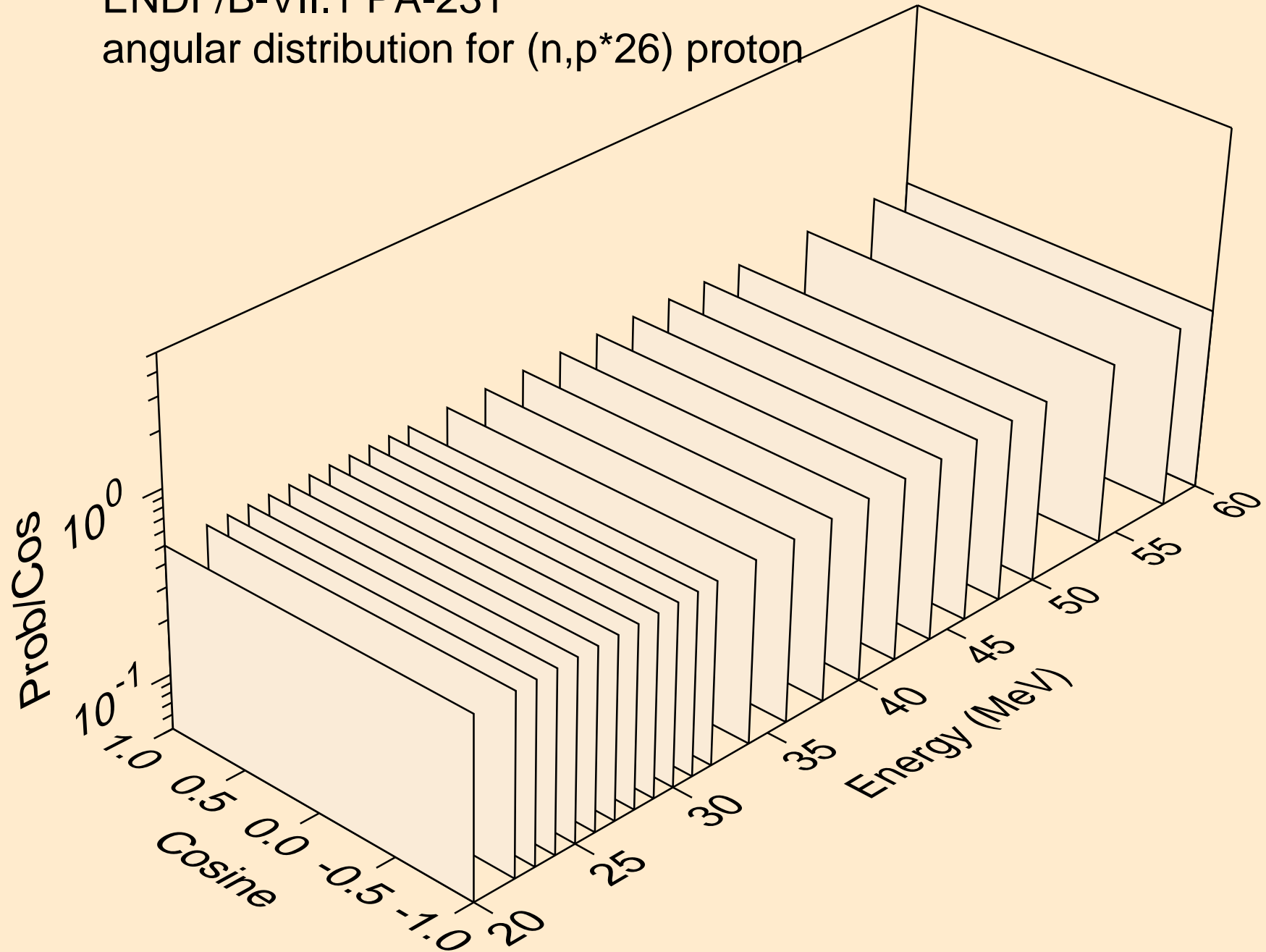

ENDF/B-VII.1 PA-231

angular distribution for (n,p*27) proton

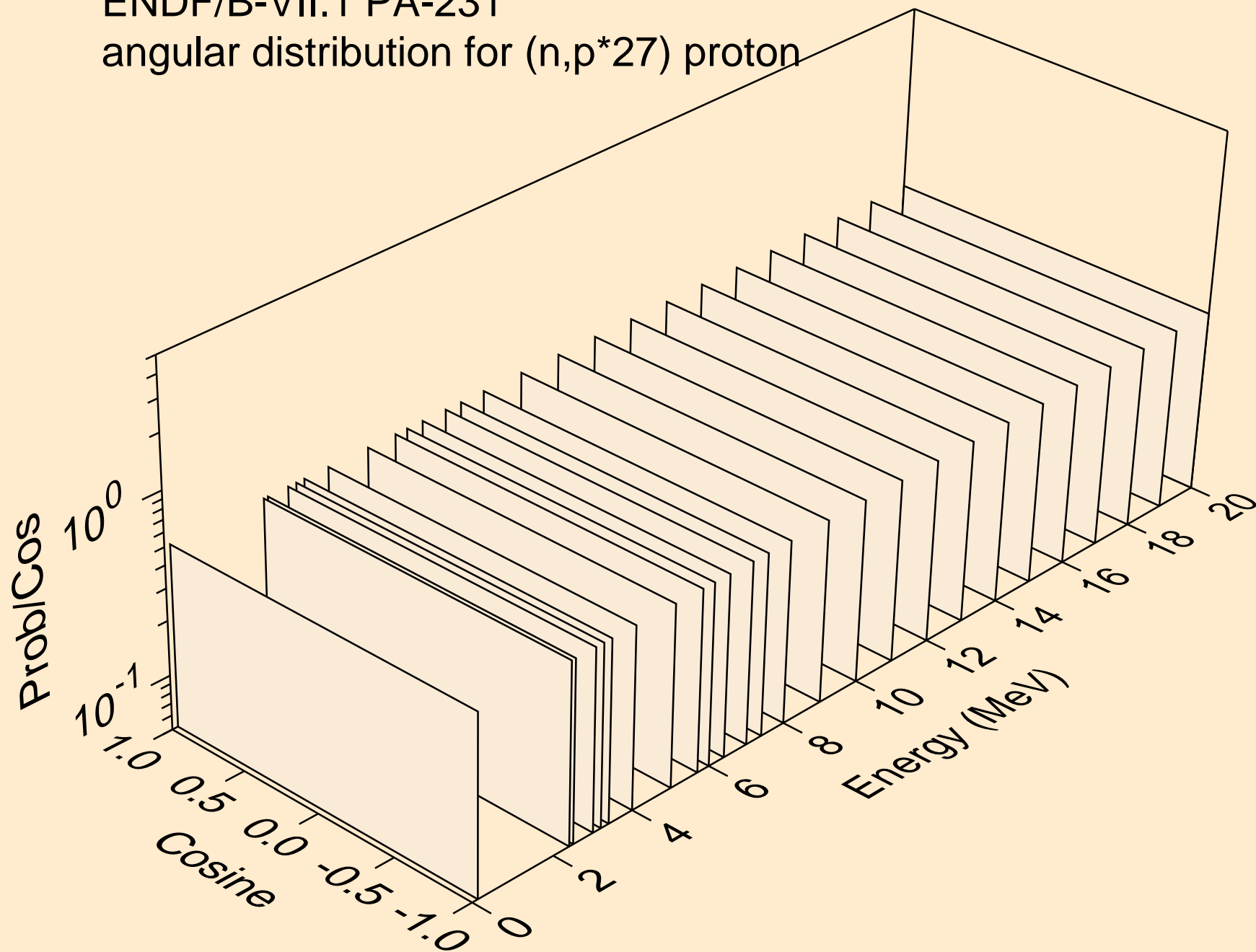

ENDF/B-VII.1 PA-231

angular distribution for (n,p*27) proton

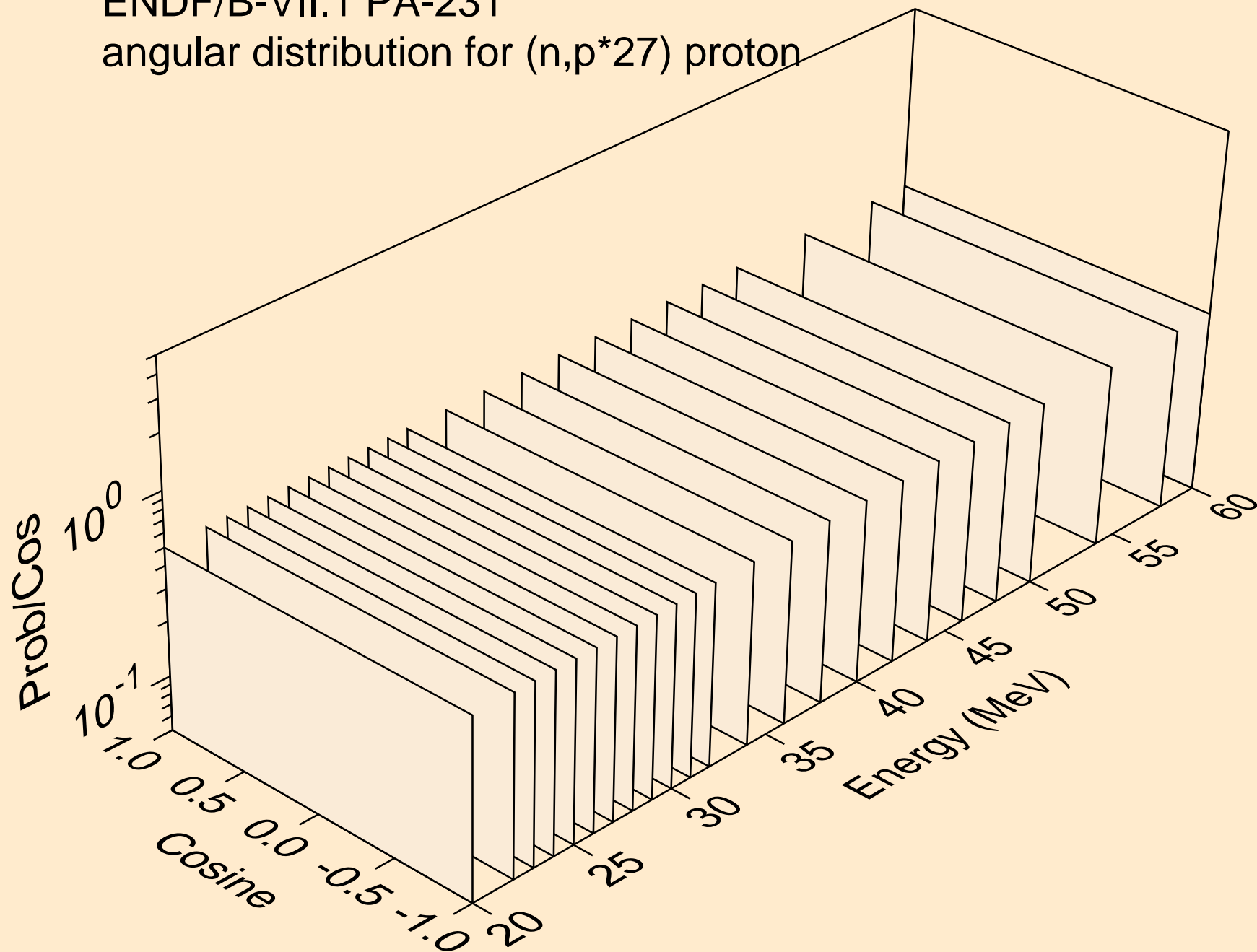

ENDF/B-VII.1 PA-231

angular distribution for (n,p*28) proton

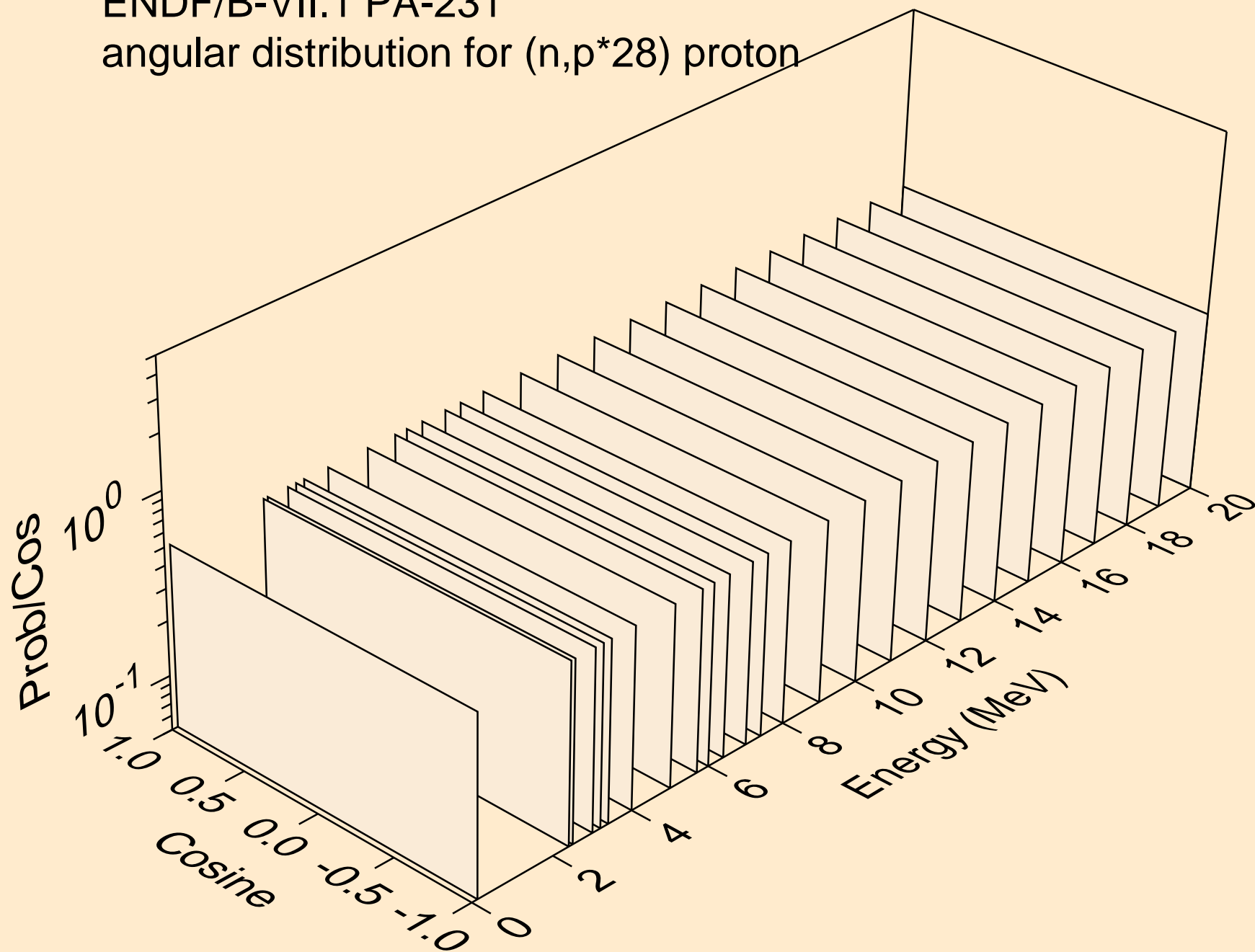

ENDF/B-VII.1 PA-231

angular distribution for (n,p*28) proton

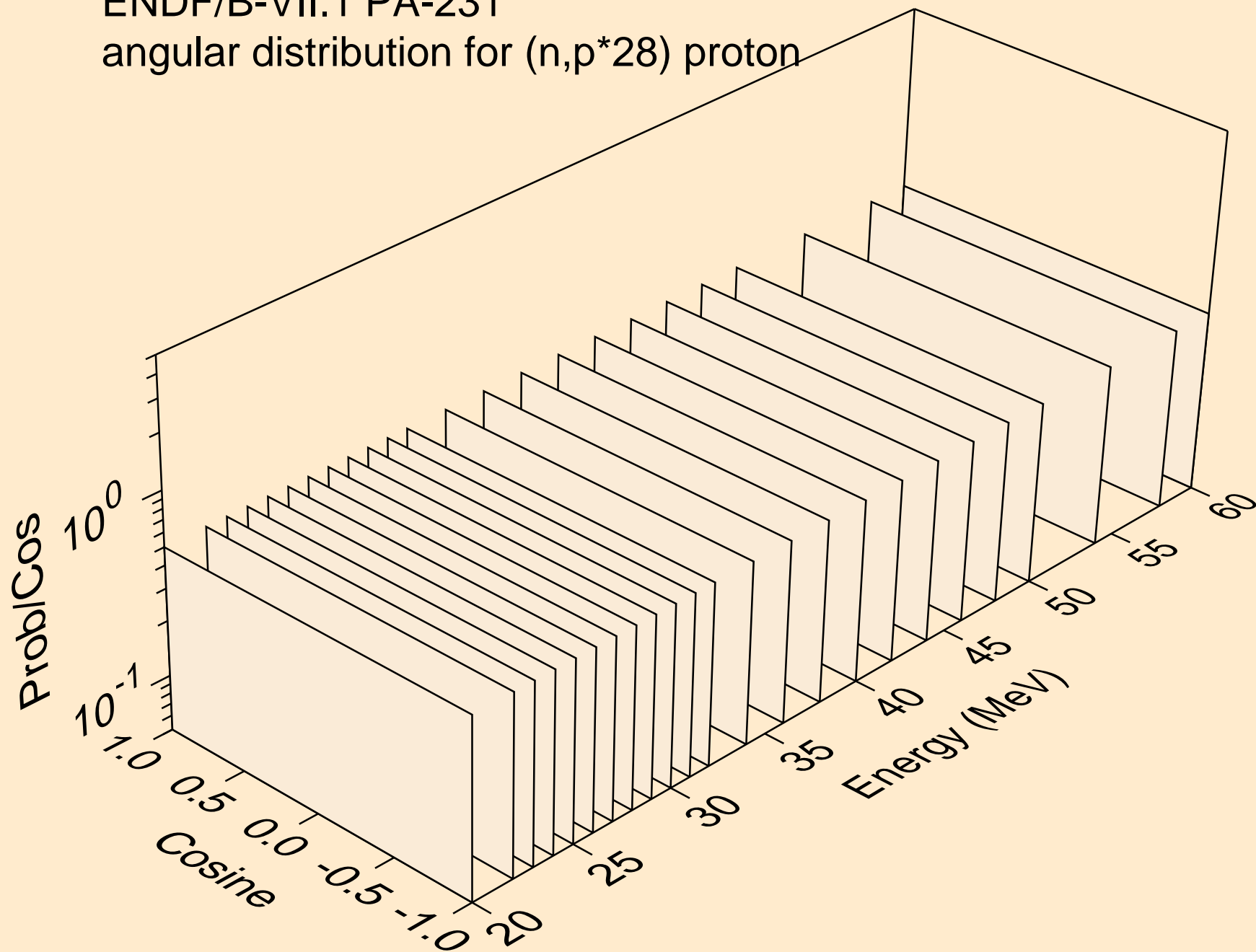

ENDF/B-VII.1 PA-231

angular distribution for (n,p*29) proton

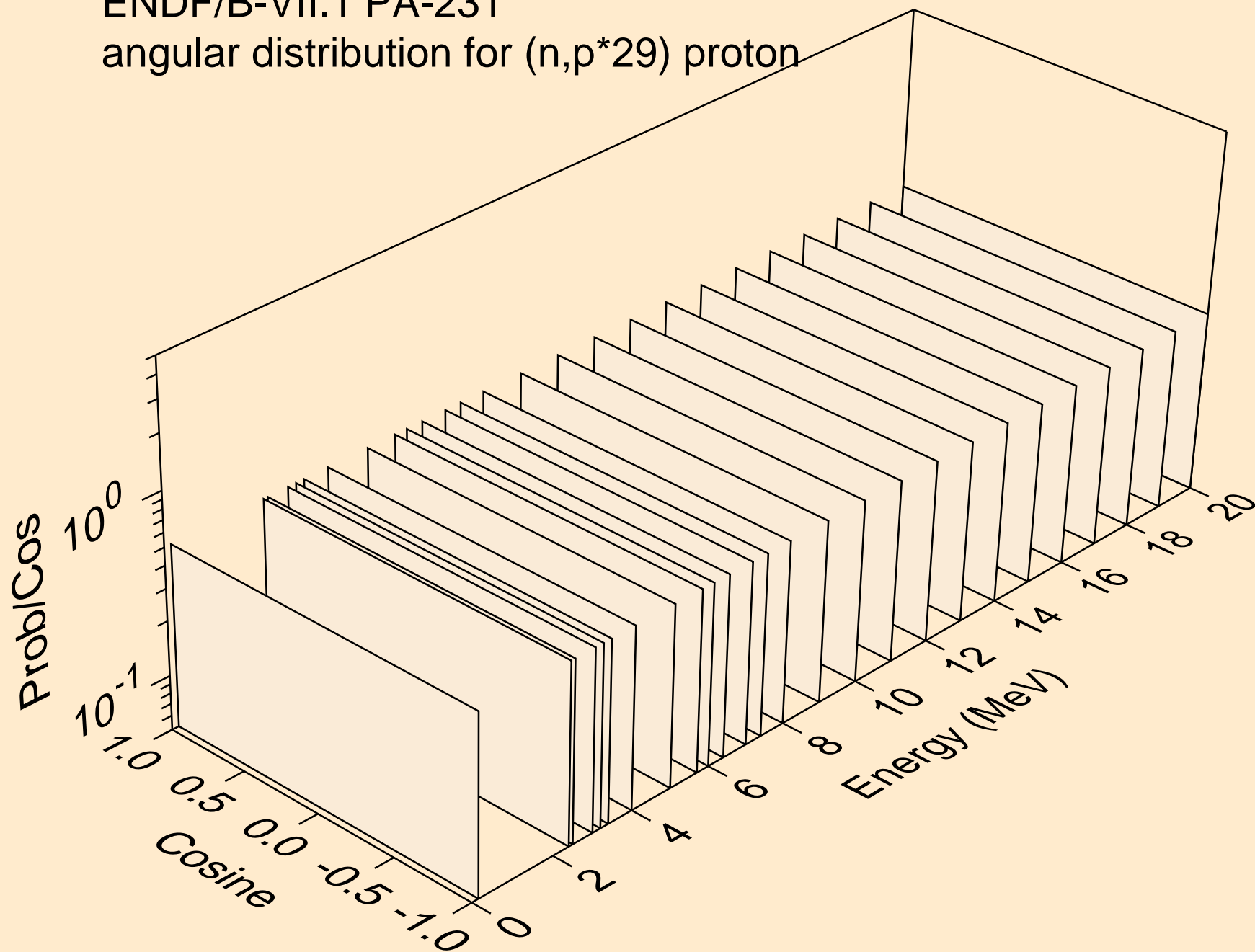

ENDF/B-VII.1 PA-231

angular distribution for (n,p*29) proton

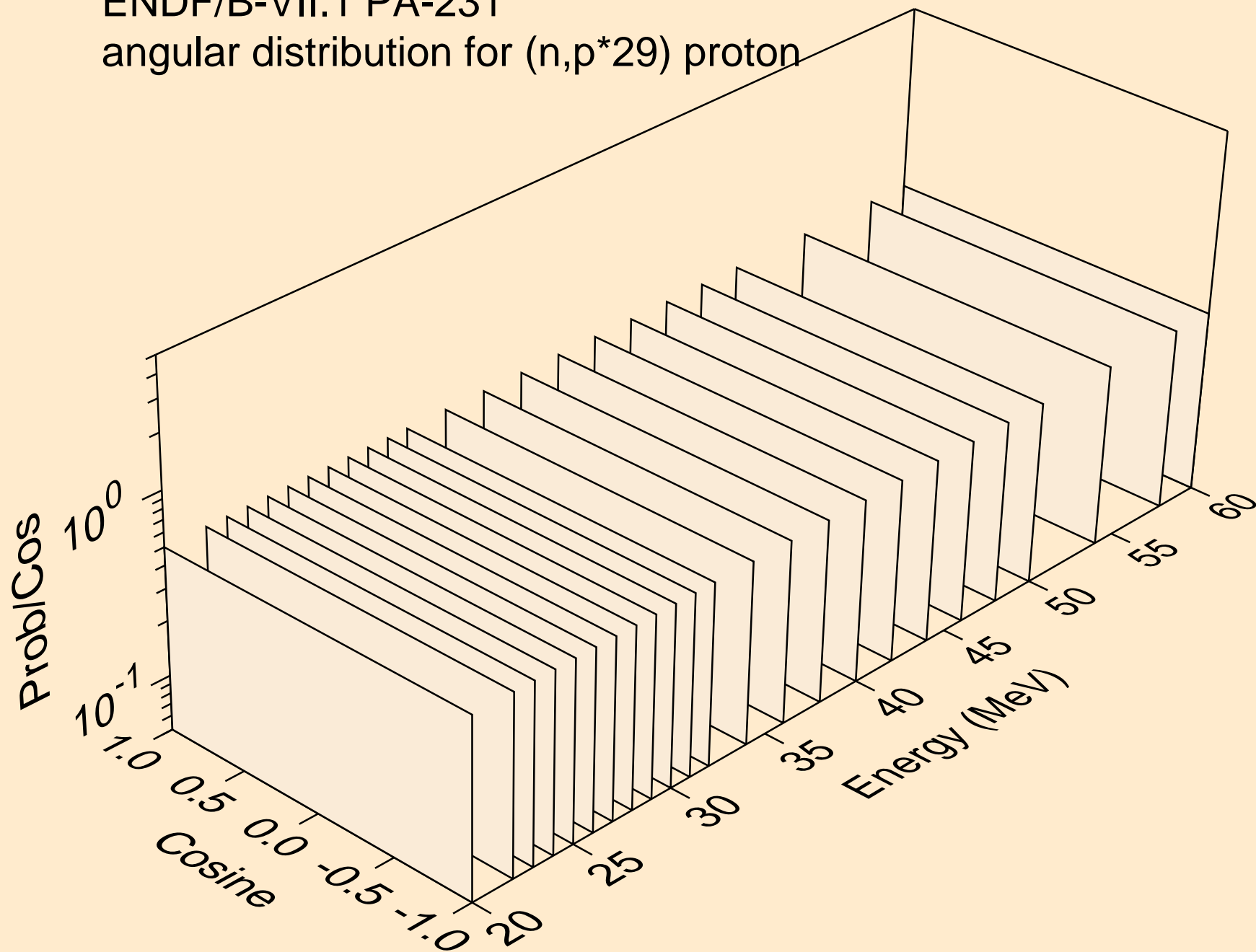

ENDF/B-VII.1 PA-231

angular distribution for (n,p*30) proton

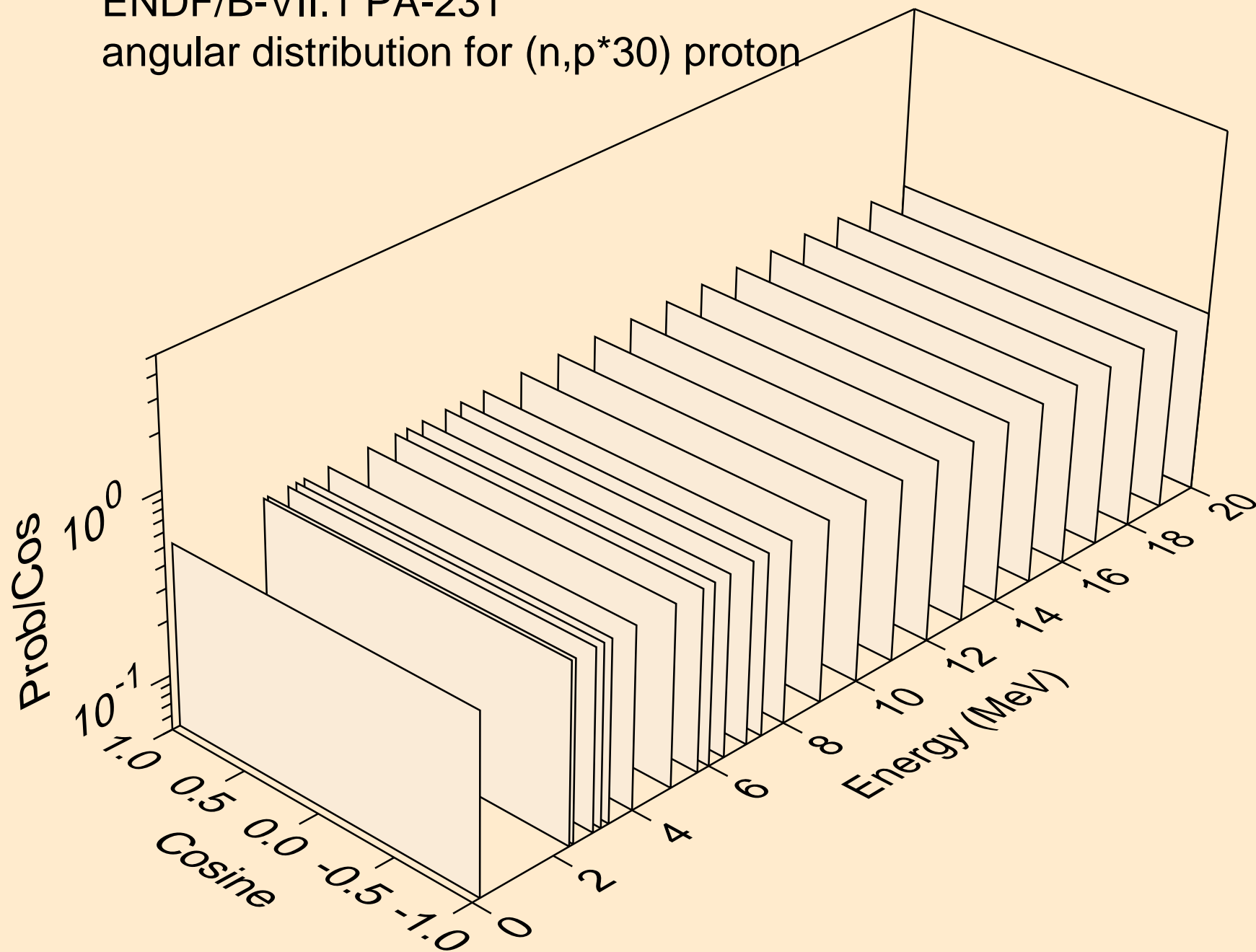

ENDF/B-VII.1 PA-231

angular distribution for (n,p*30) proton

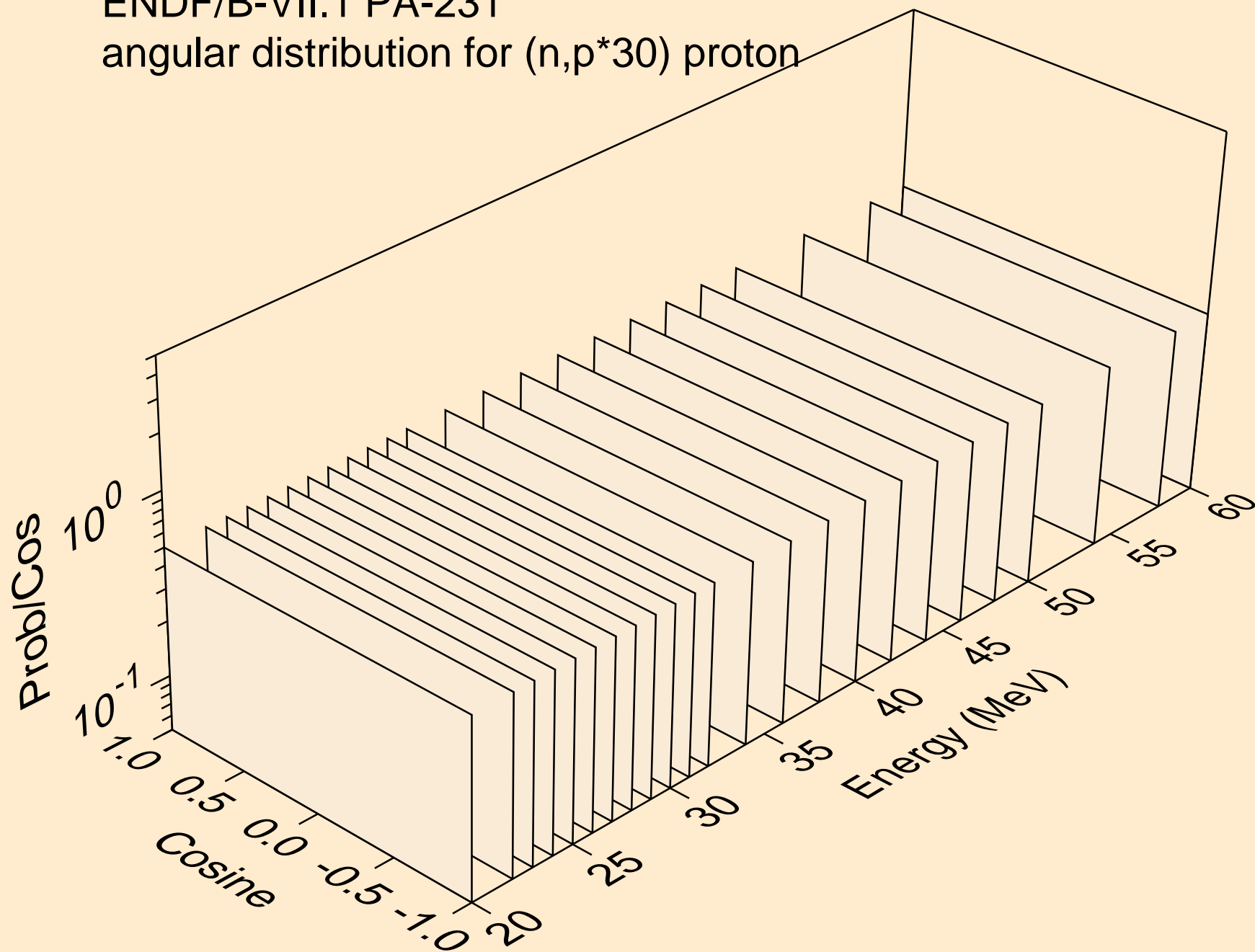

ENDF/B-VII.1 PA-231
angular distribution for (n,p*31) proton

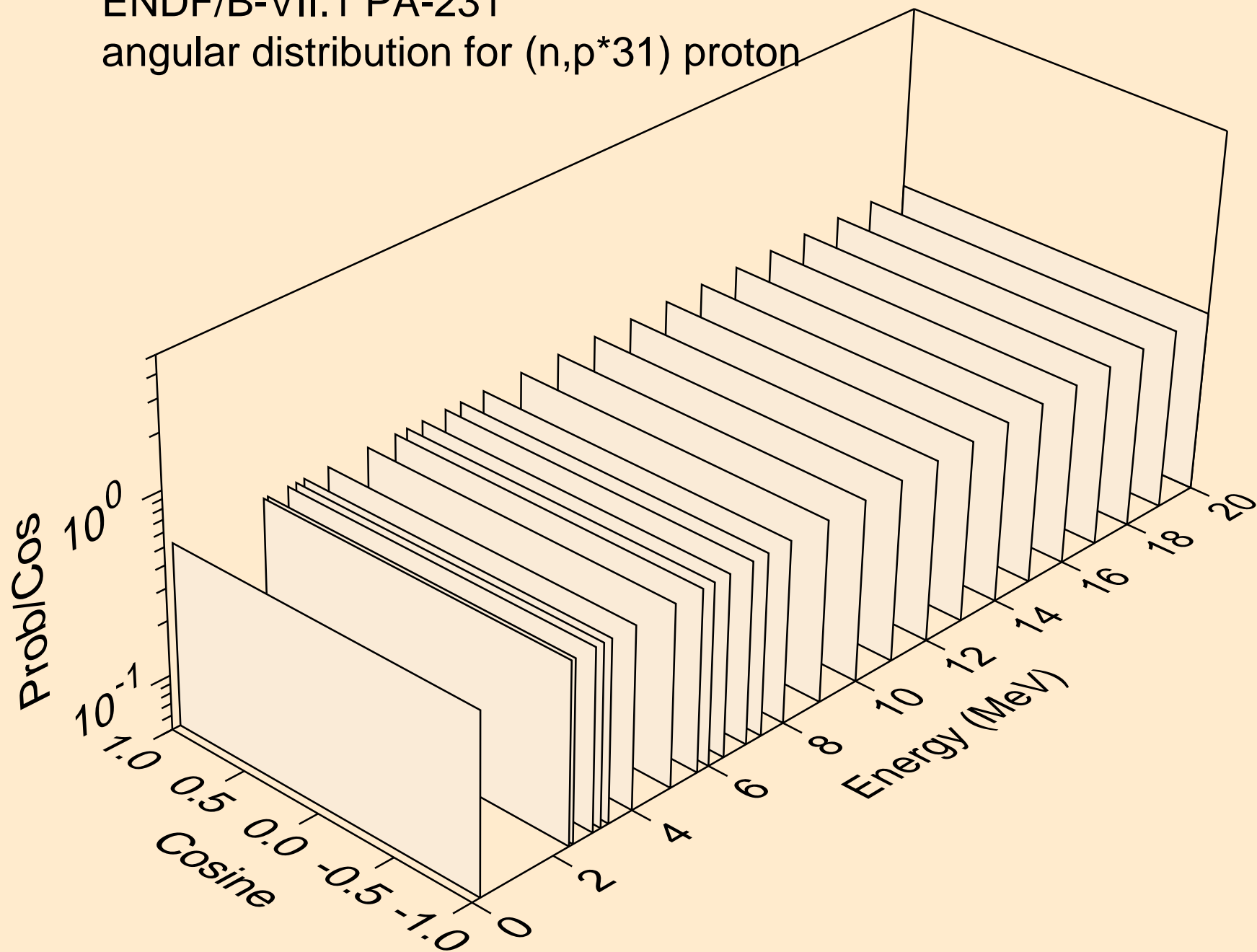

ENDF/B-VII.1 PA-231

angular distribution for (n,p*31) proton

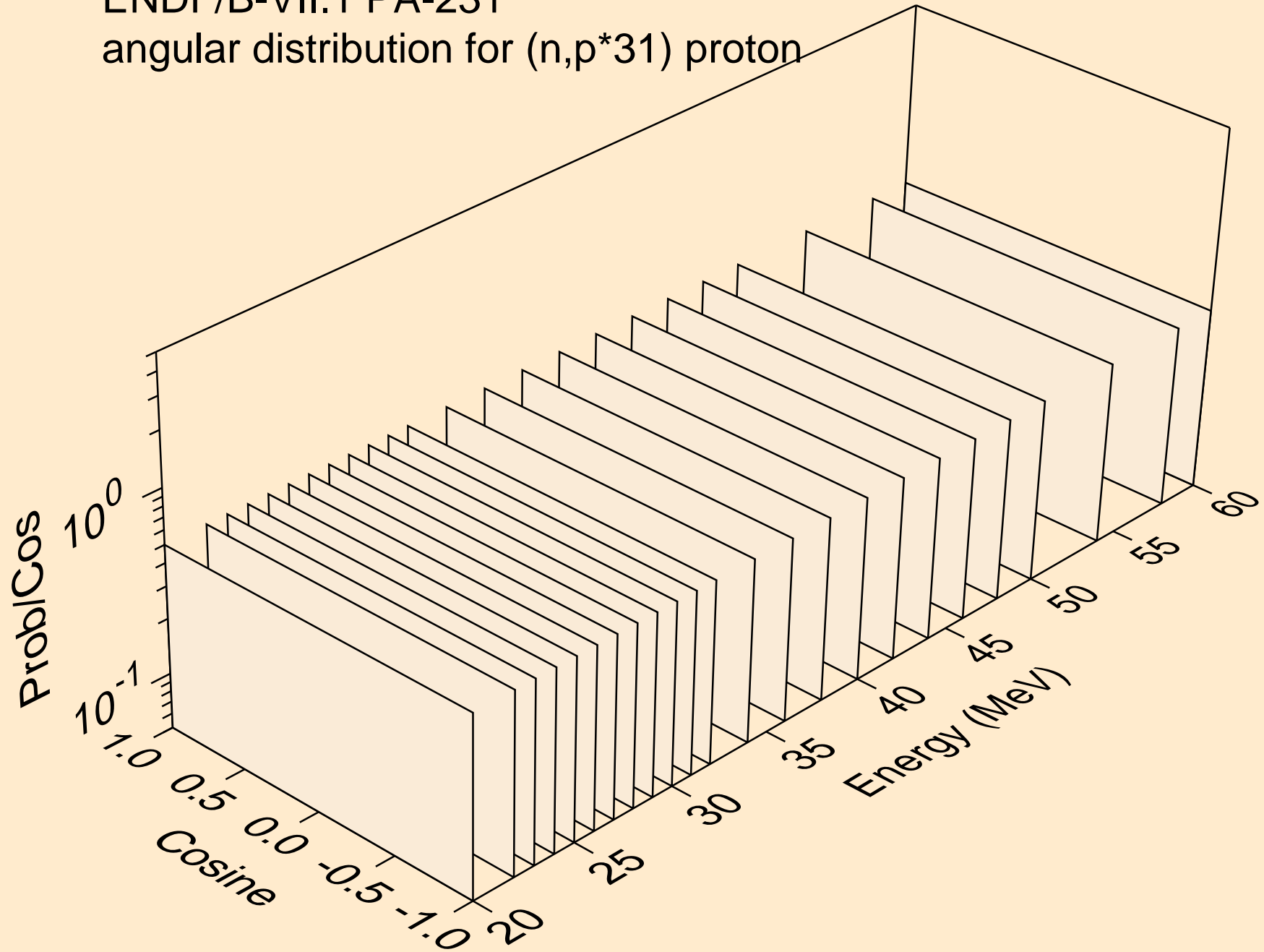

ENDF/B-VII.1 PA-231

angular distribution for (n,p*32) proton

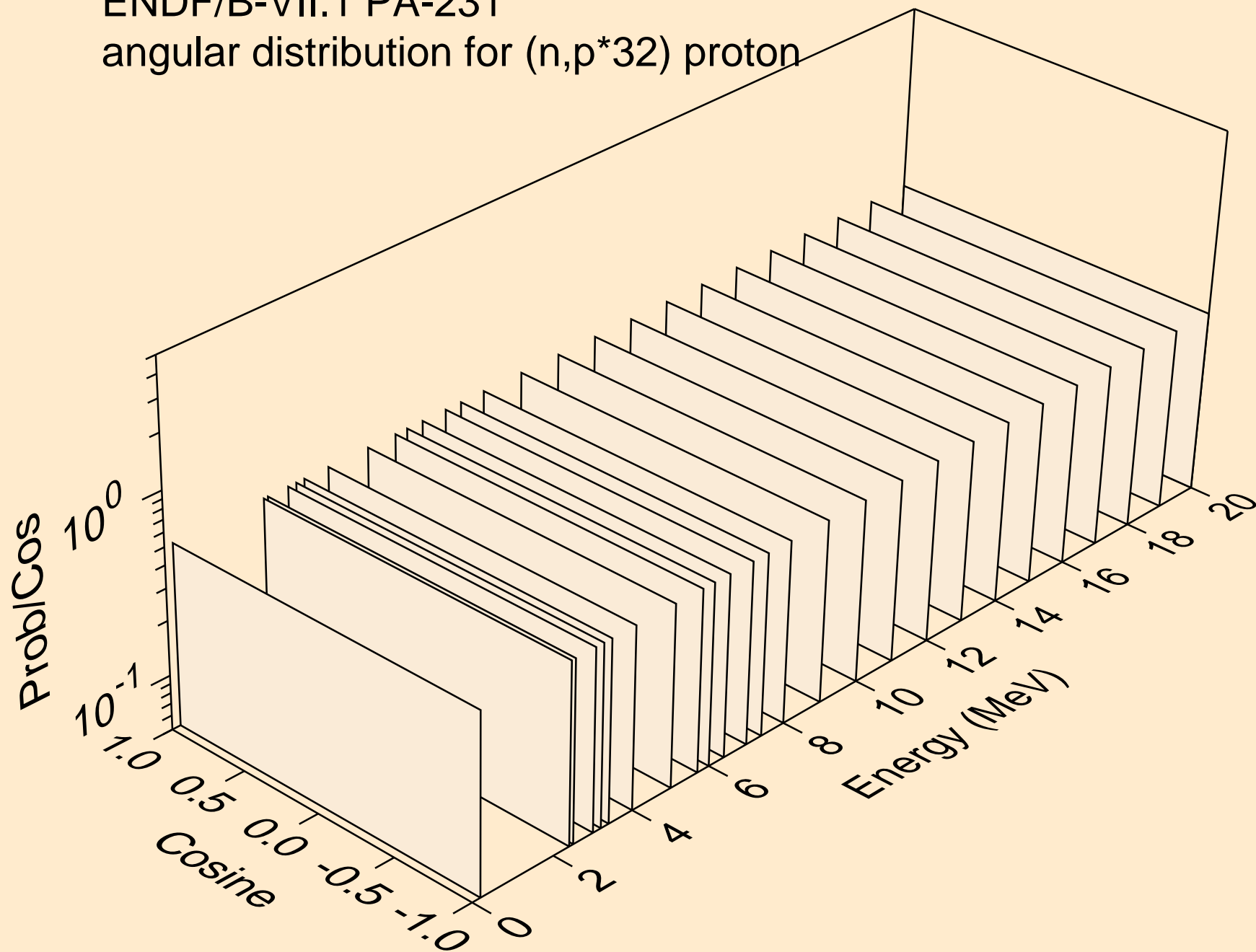

ENDF/B-VII.1 PA-231

angular distribution for (n,p*32) proton

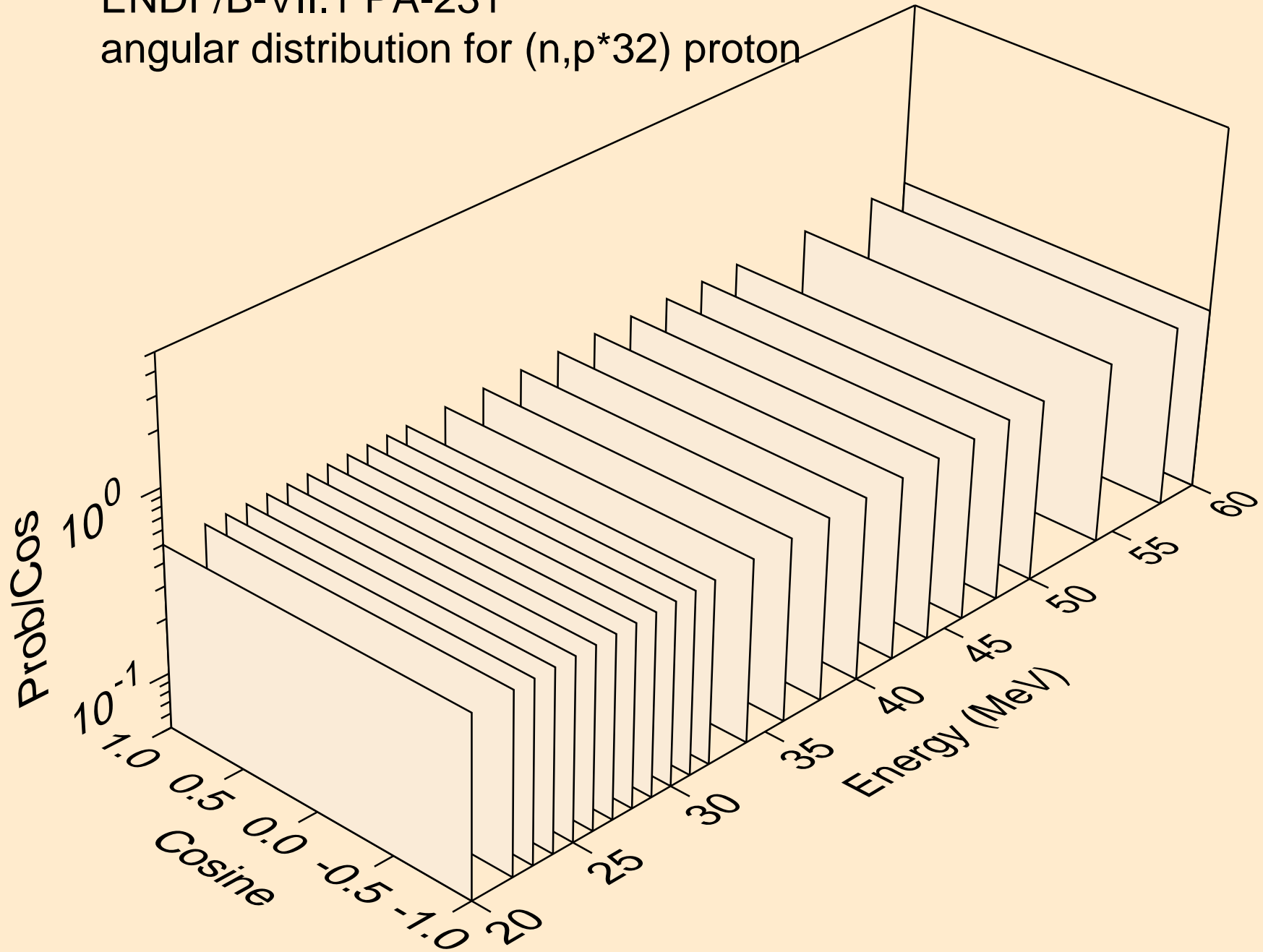

ENDF/B-VII.1 PA-231

angular distribution for (n,p*33) proton

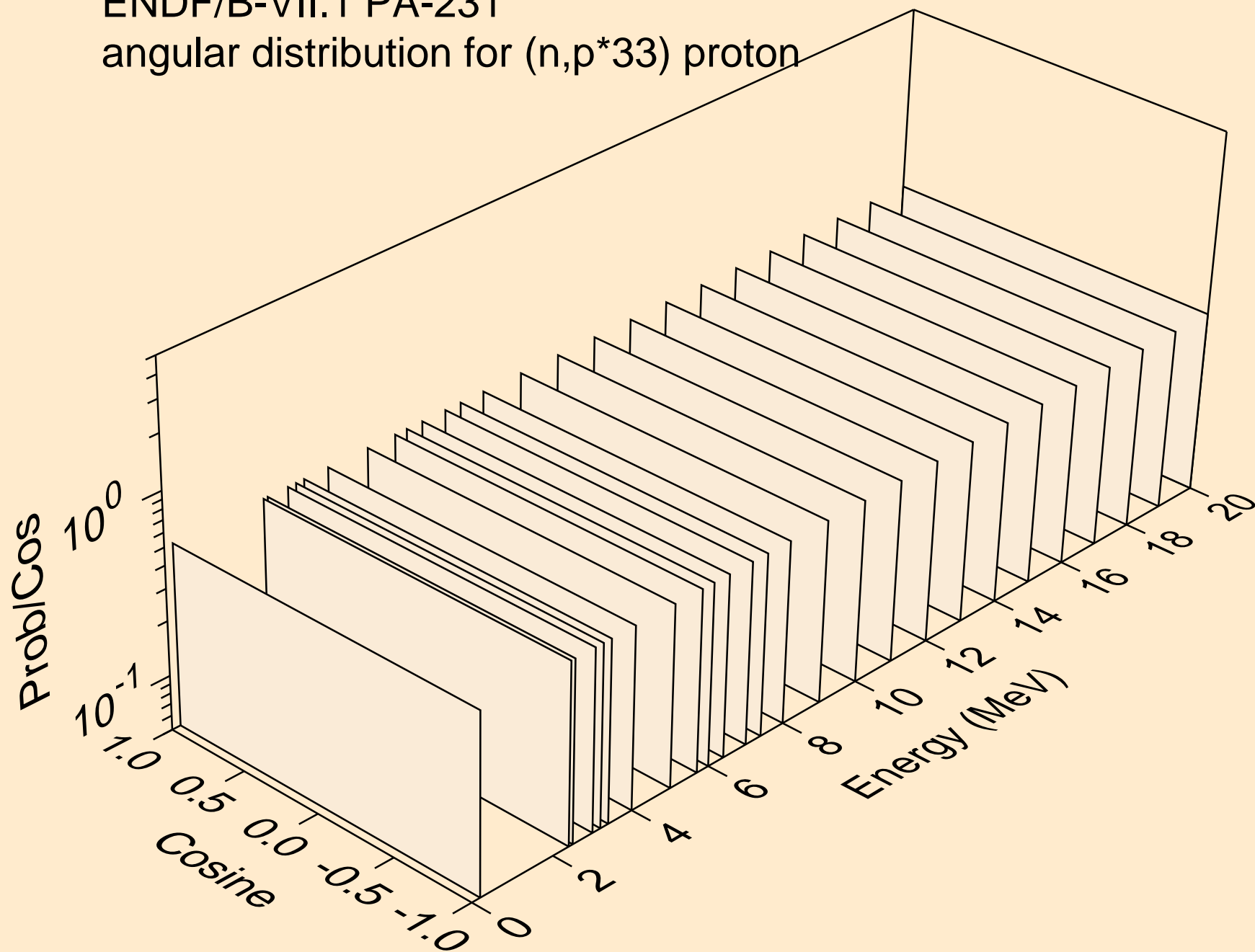

ENDF/B-VII.1 PA-231

angular distribution for (n,p*33) proton

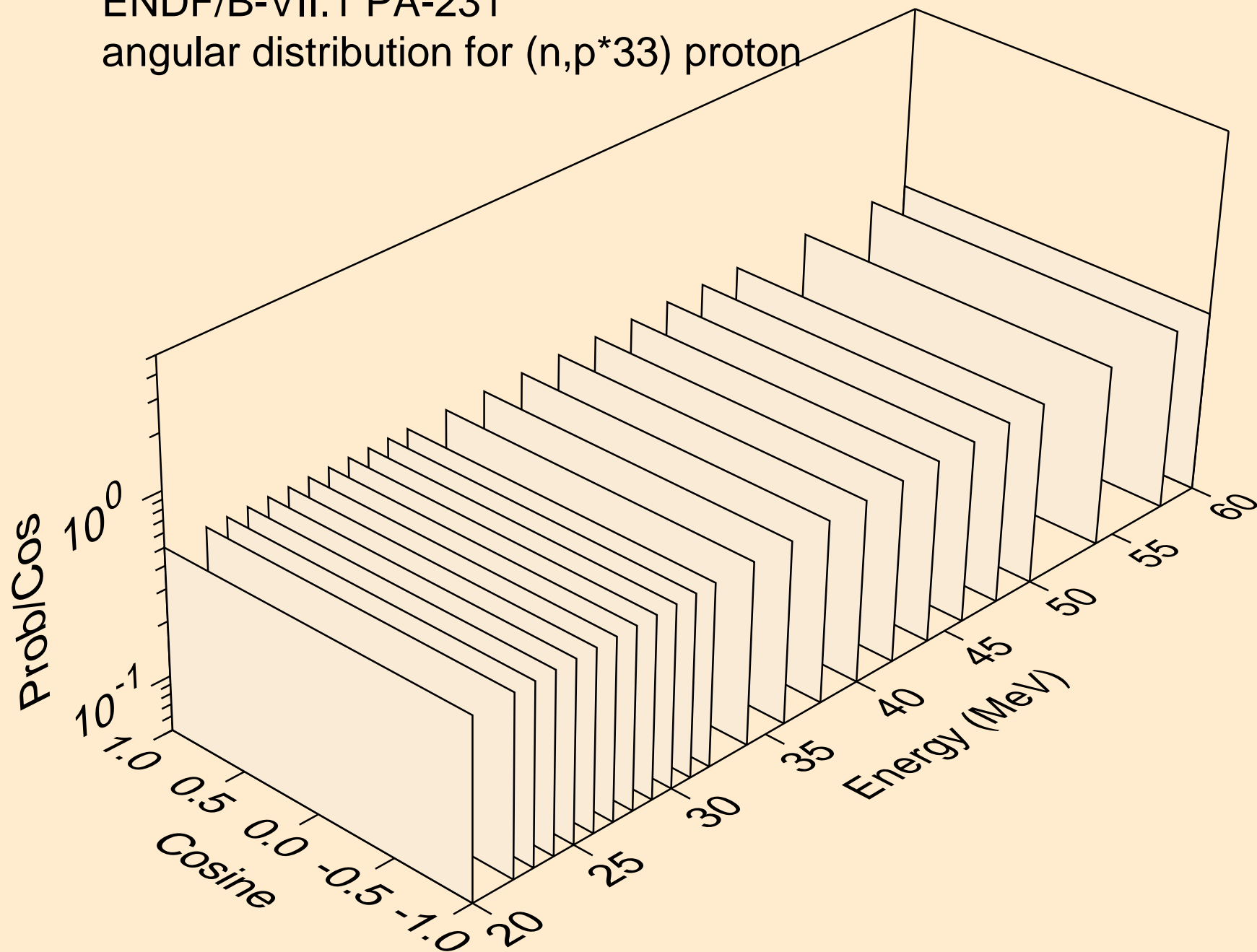

ENDF/B-VII.1 PA-231
angular distribution for (n,p*34) proton

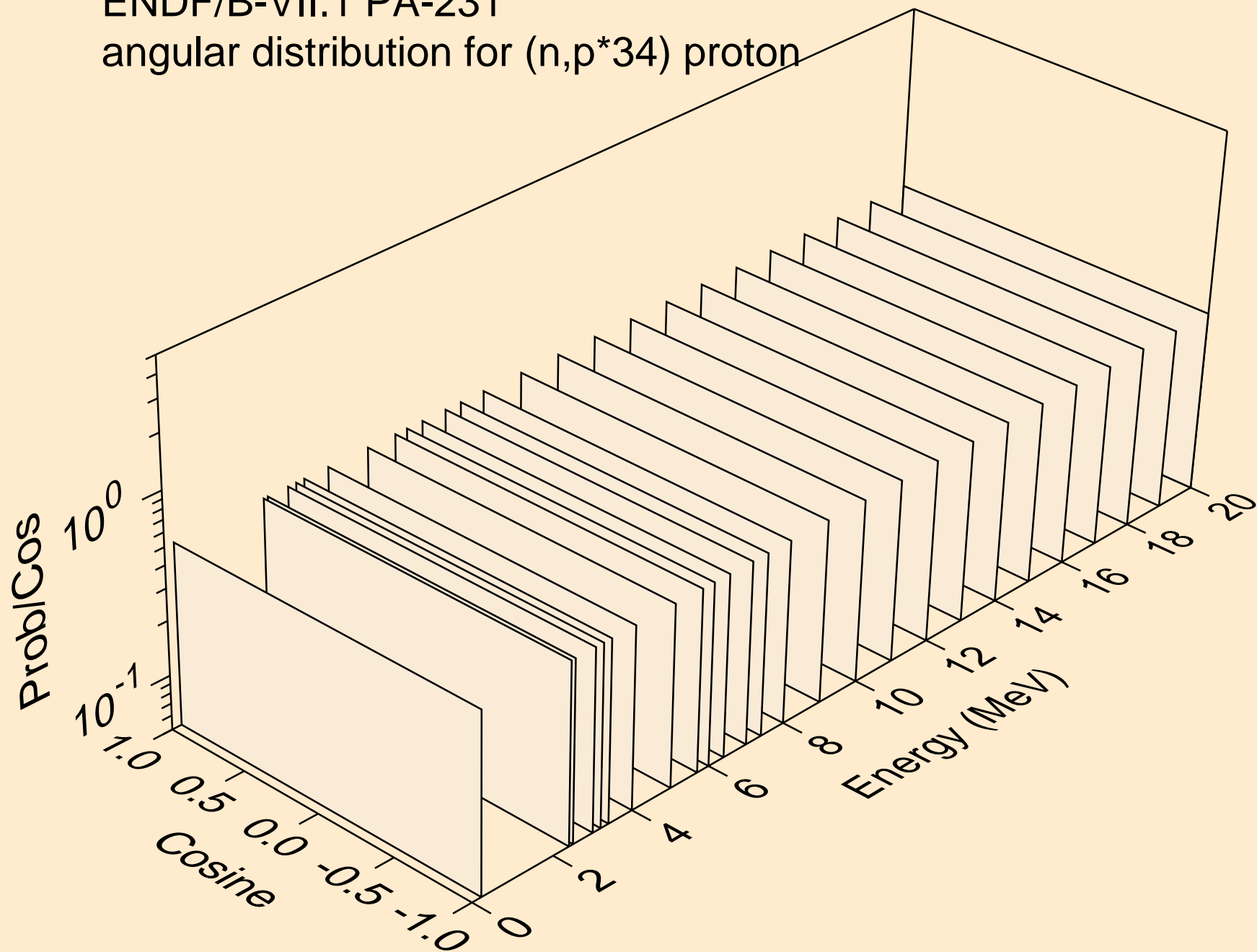

ENDF/B-VII.1 PA-231

angular distribution for (n,p*34) proton

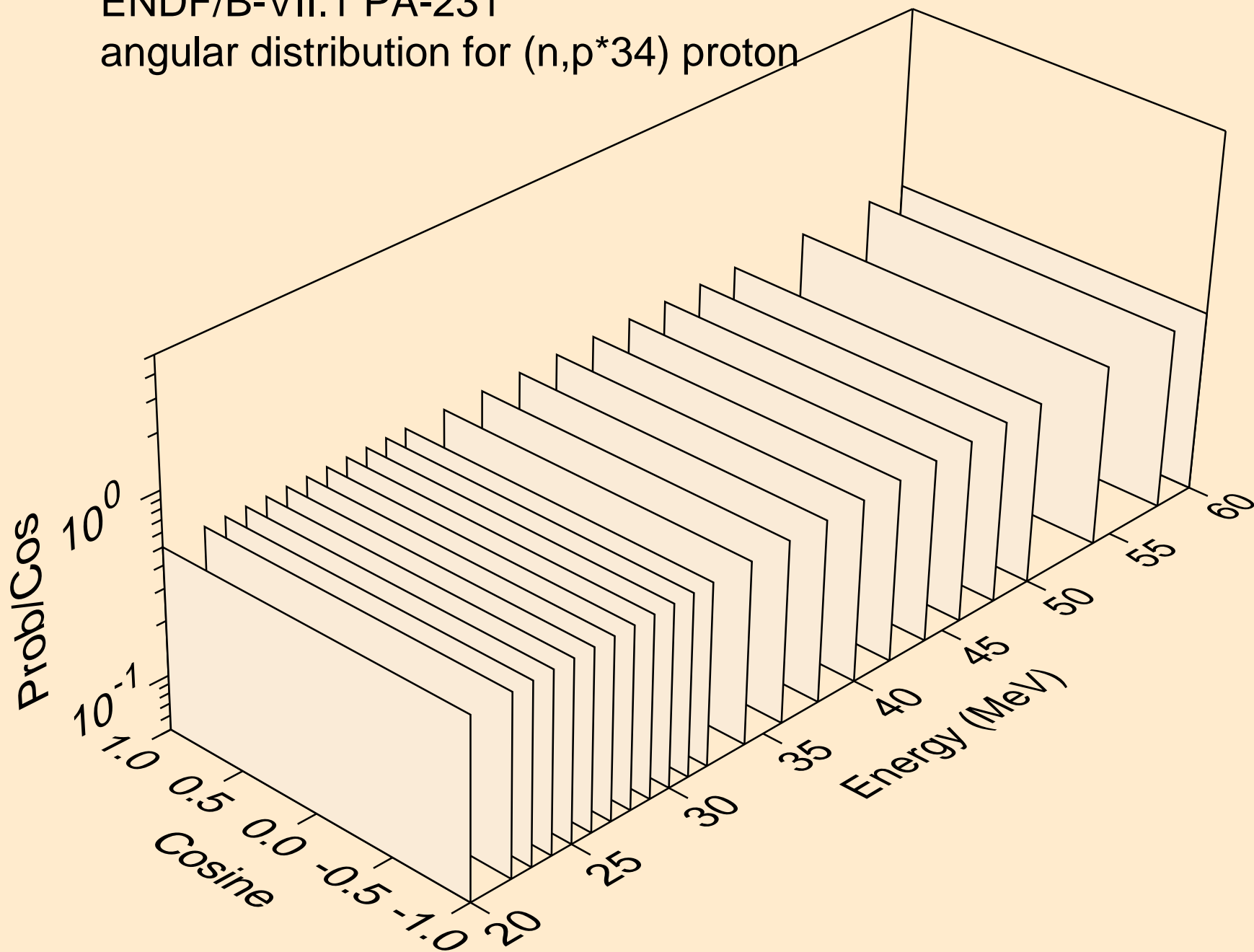

ENDF/B-VII.1 PA-231

angular distribution for (n,p*35) proton

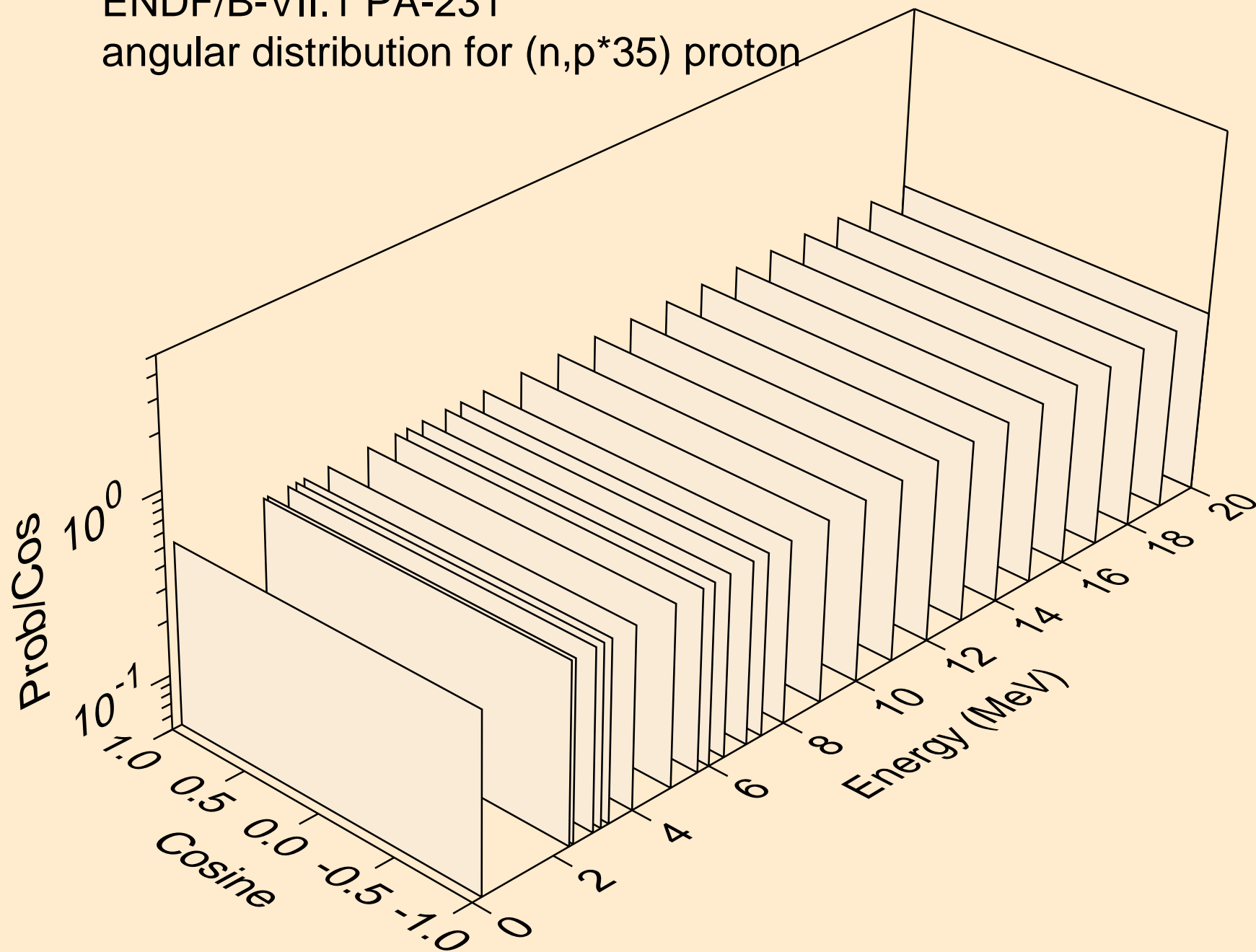

ENDF/B-VII.1 PA-231

angular distribution for (n,p*35) proton

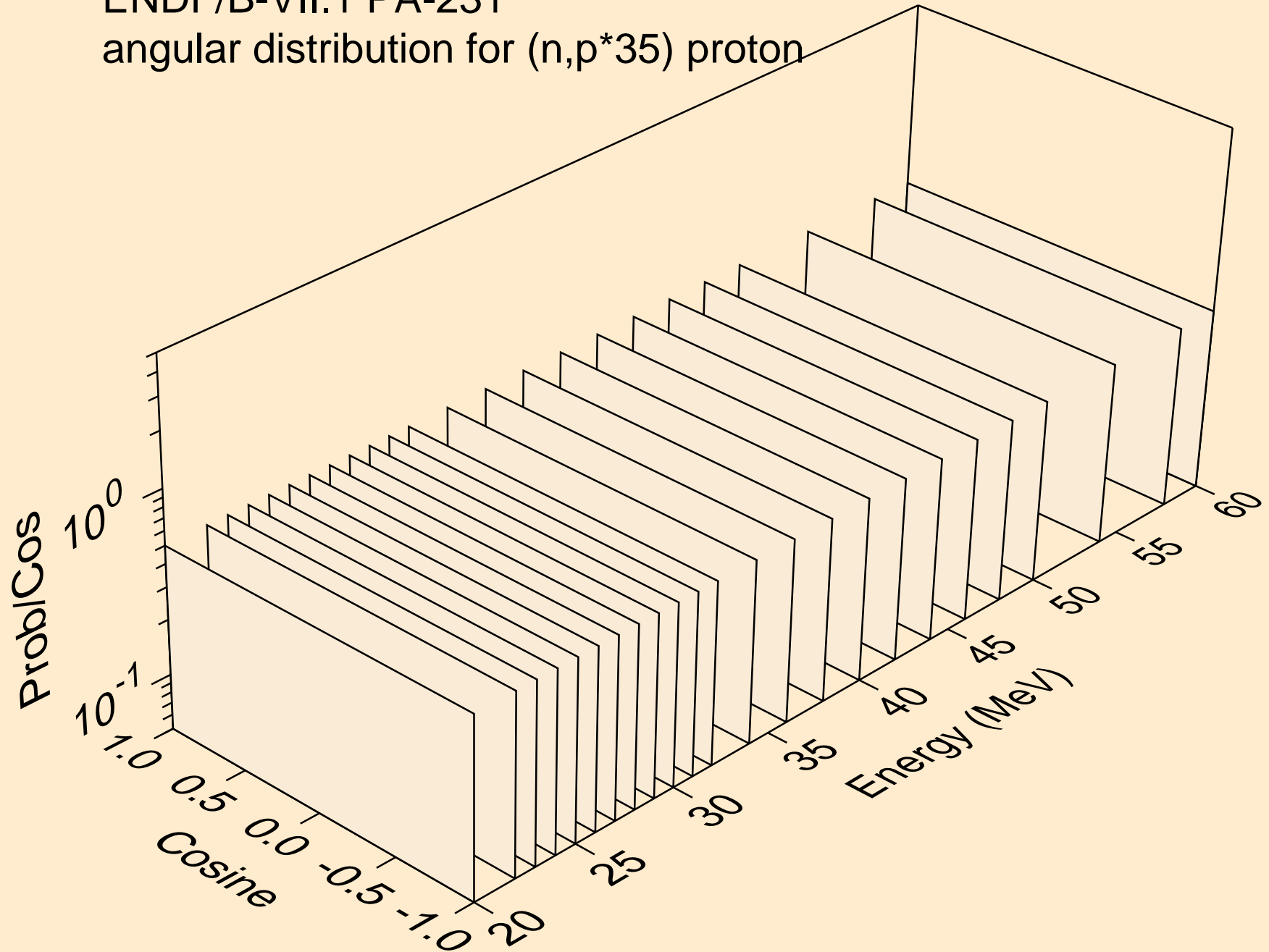

ENDF/B-VII.1 PA-231
angular distribution for (n,p*36) proton

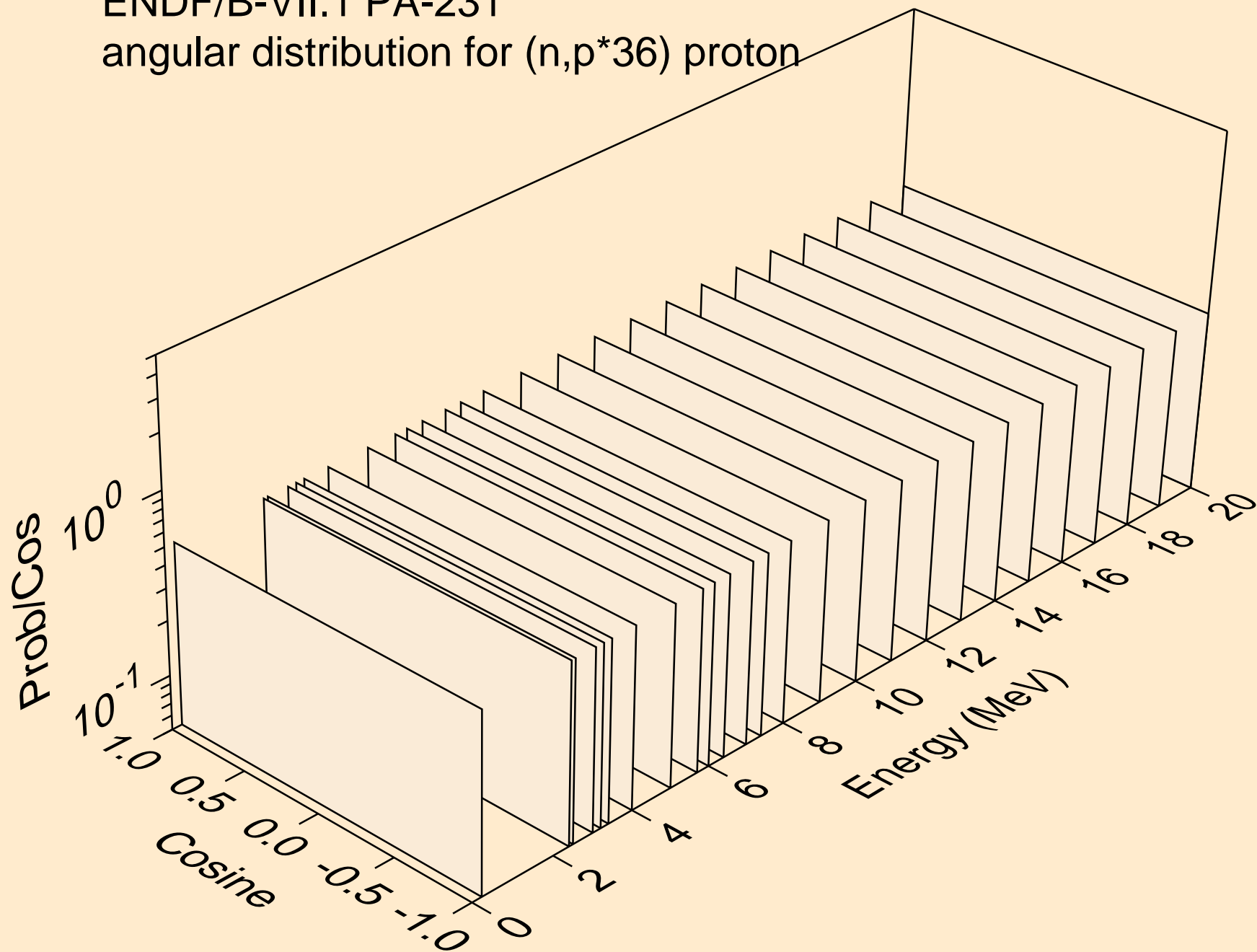

ENDF/B-VII.1 PA-231

angular distribution for (n,p*36) proton

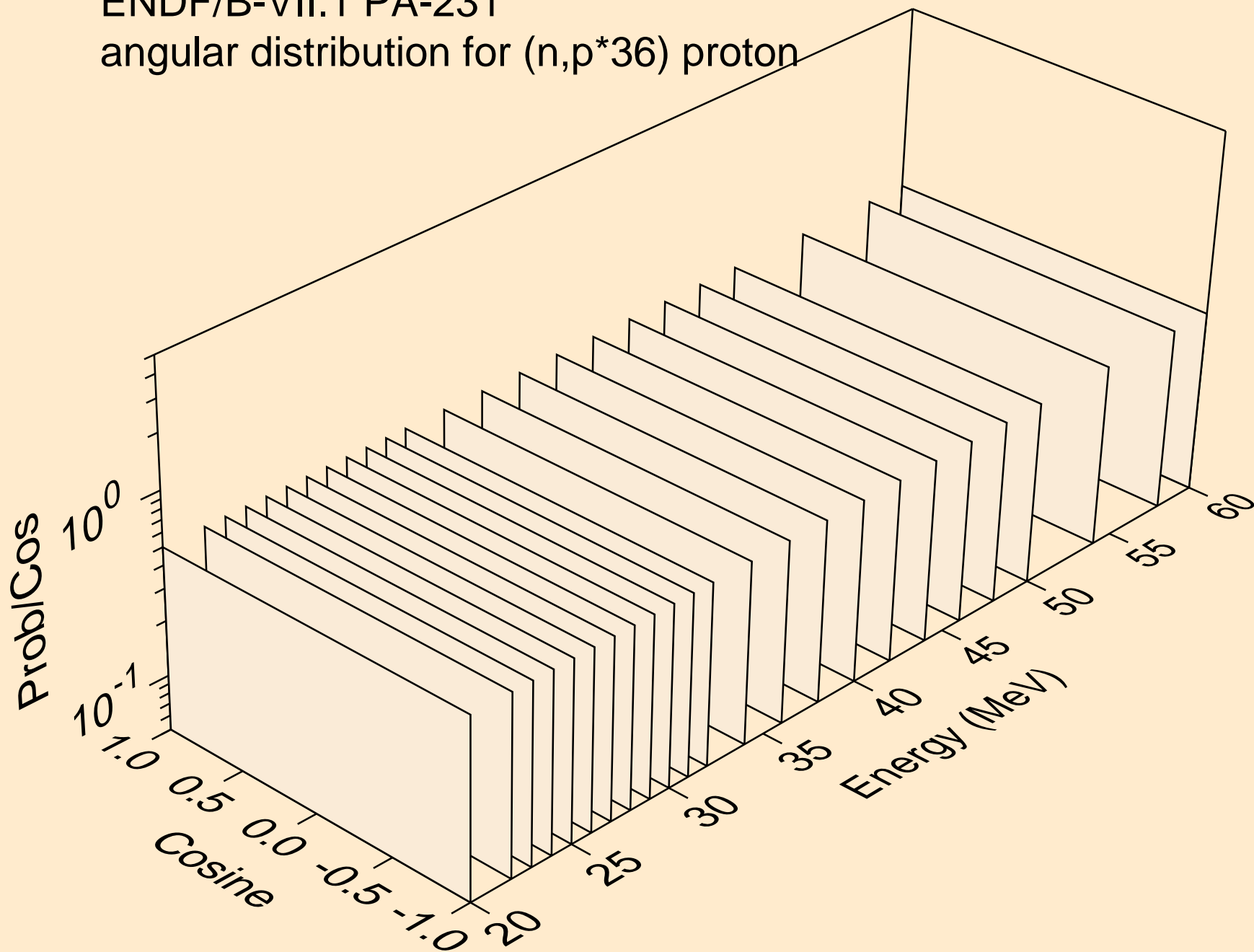

ENDF/B-VII.1 PA-231

angular distribution for (n,p*37) proton

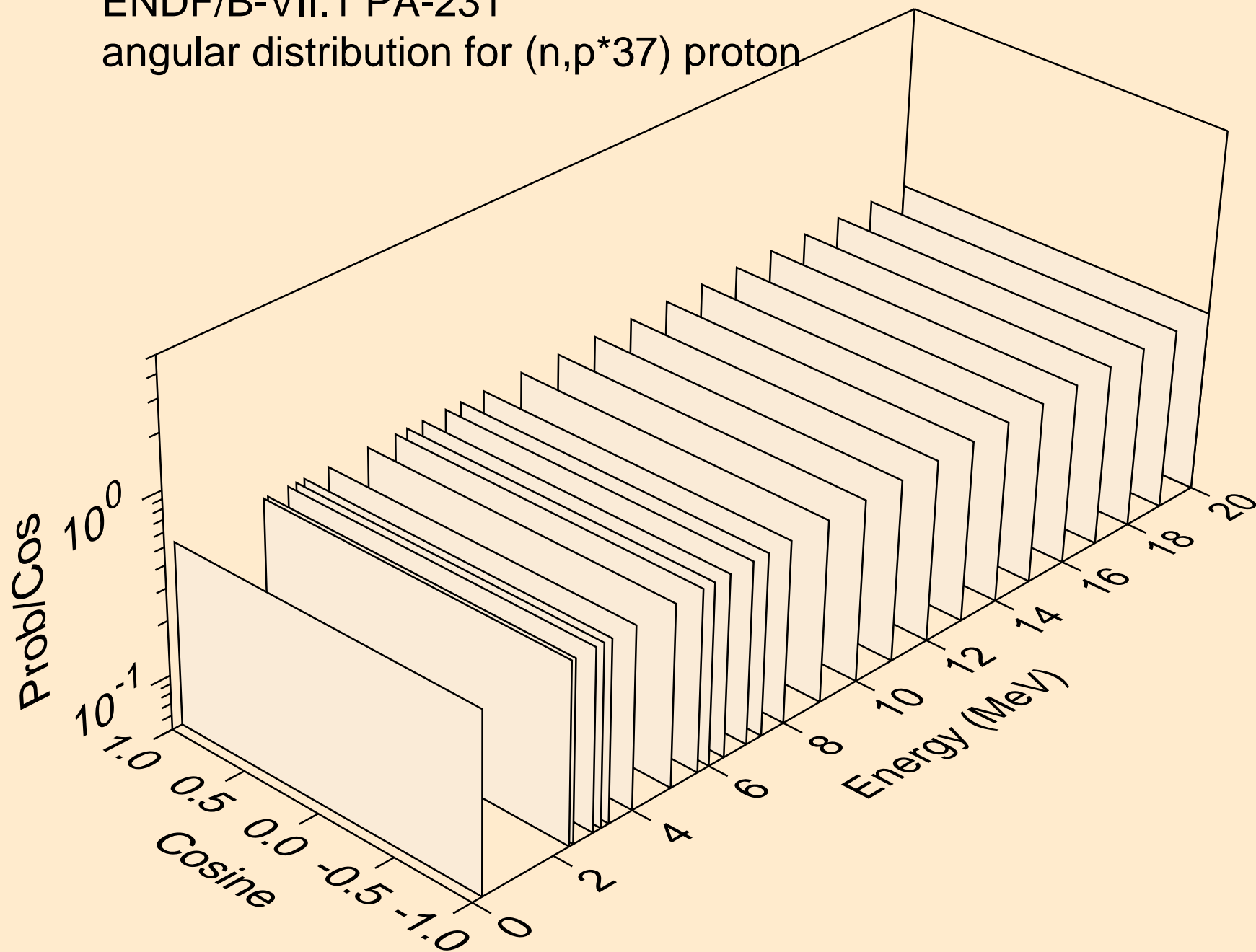

ENDF/B-VII.1 PA-231

angular distribution for (n,p*37) proton

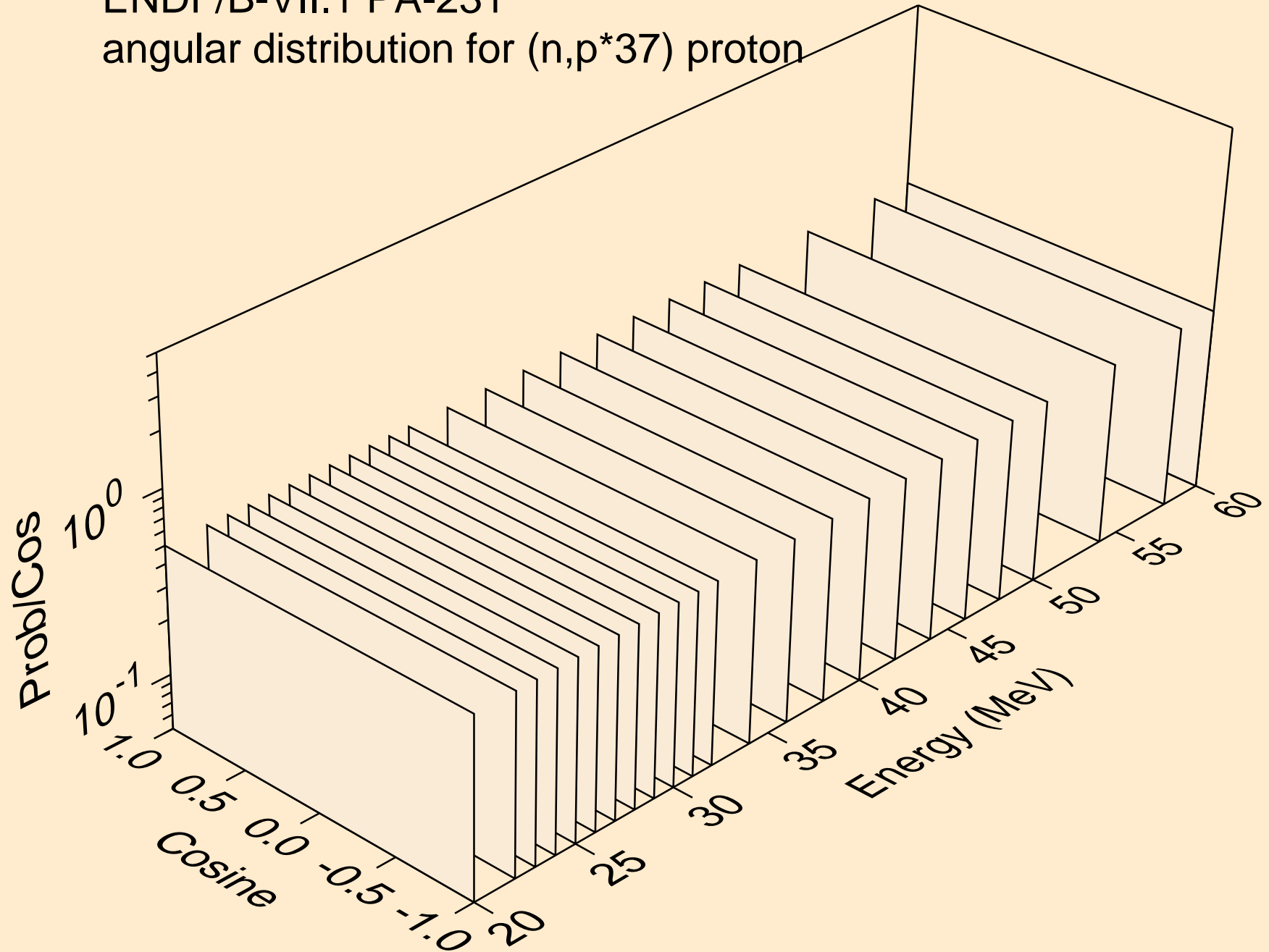

ENDF/B-VII.1 PA-231
protons from (n,p*c)

