

ENDF/B-VII.1 IR-191

Principal cross sections

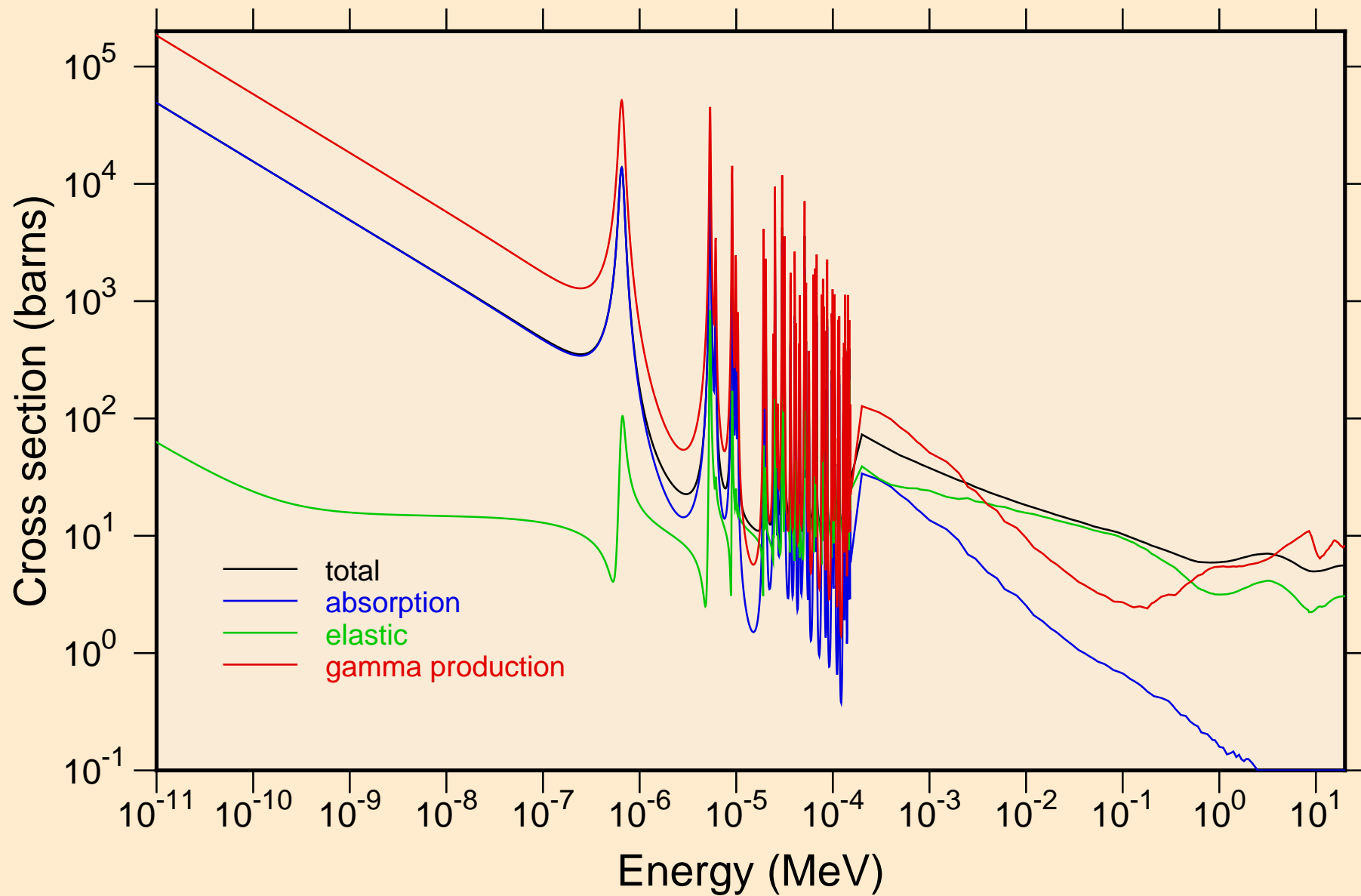

ENDF/B-VII.1 IR-191
resonance total cross section

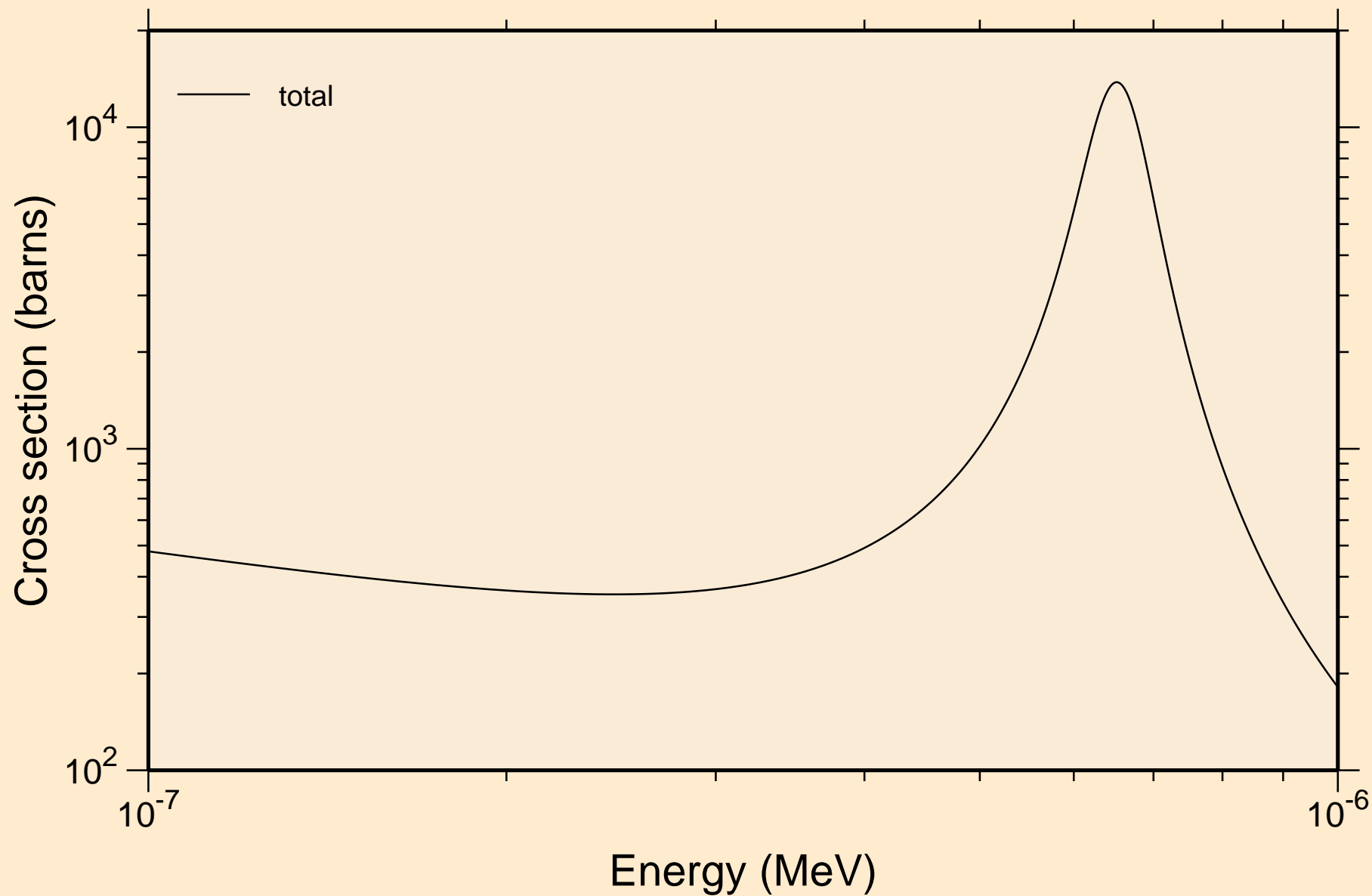

ENDF/B-VII.1 IR-191
resonance total cross section

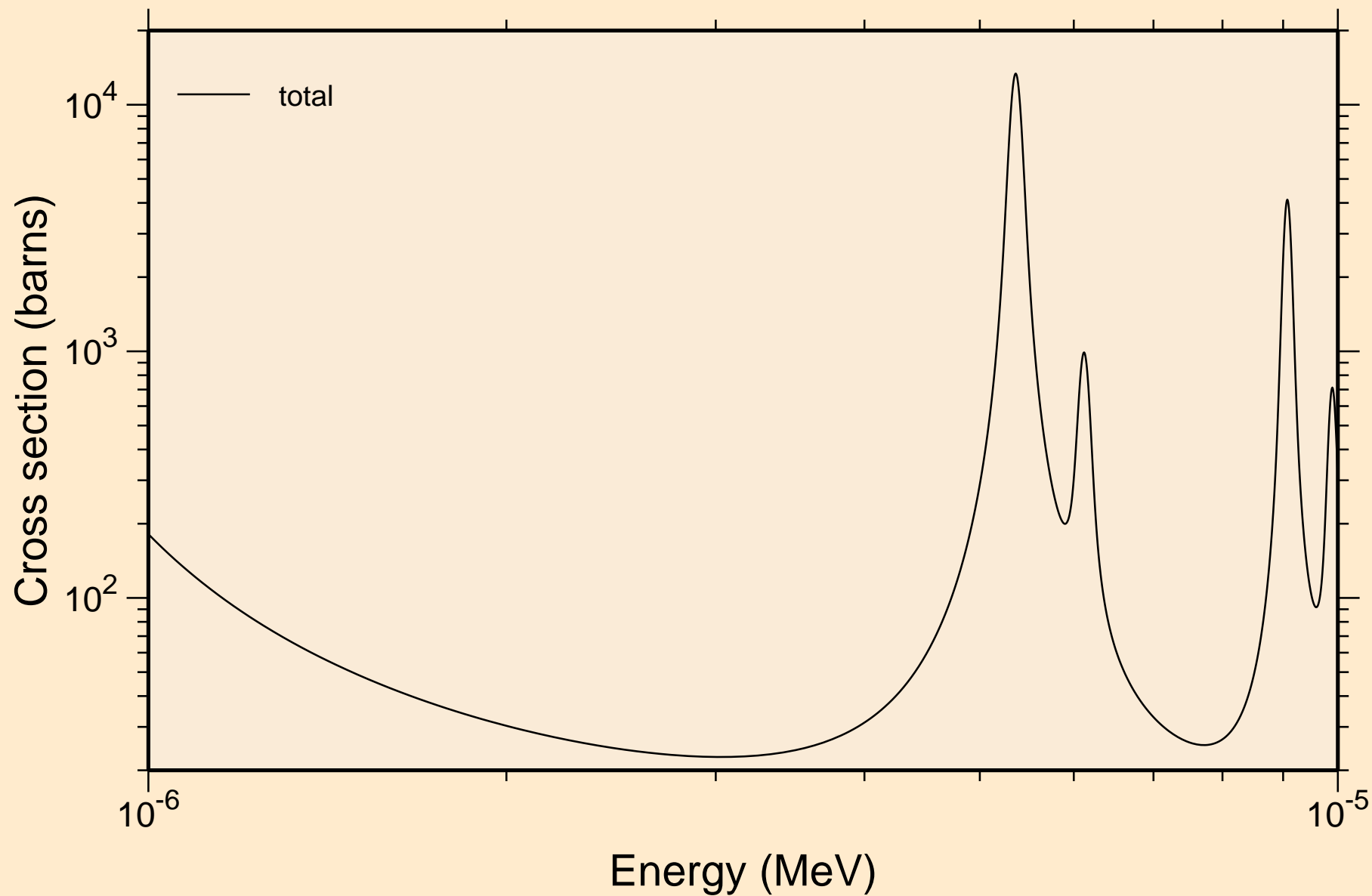

ENDF/B-VII.1 IR-191
resonance total cross section

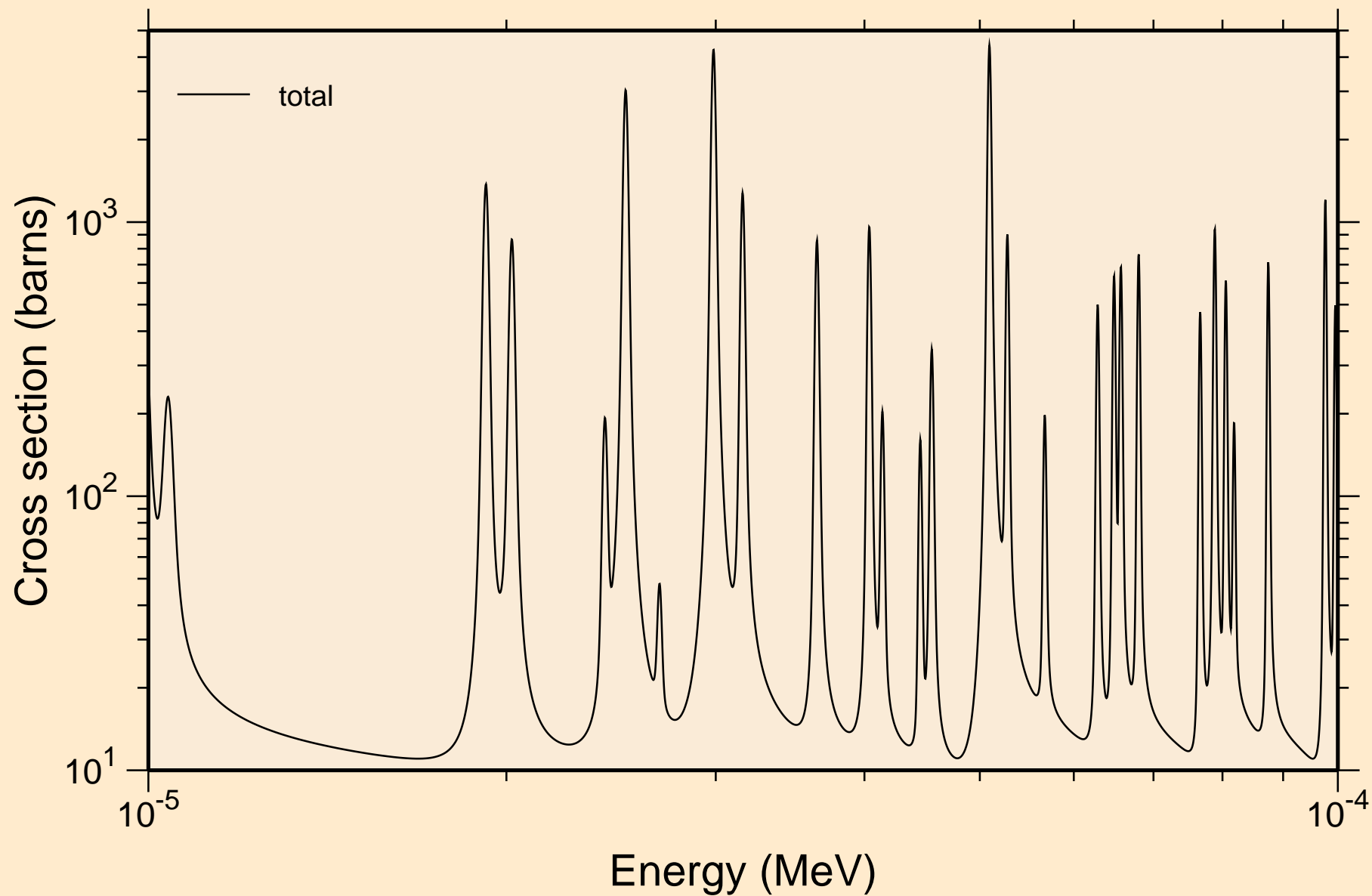

ENDF/B-VII.1 IR-191
resonance total cross section

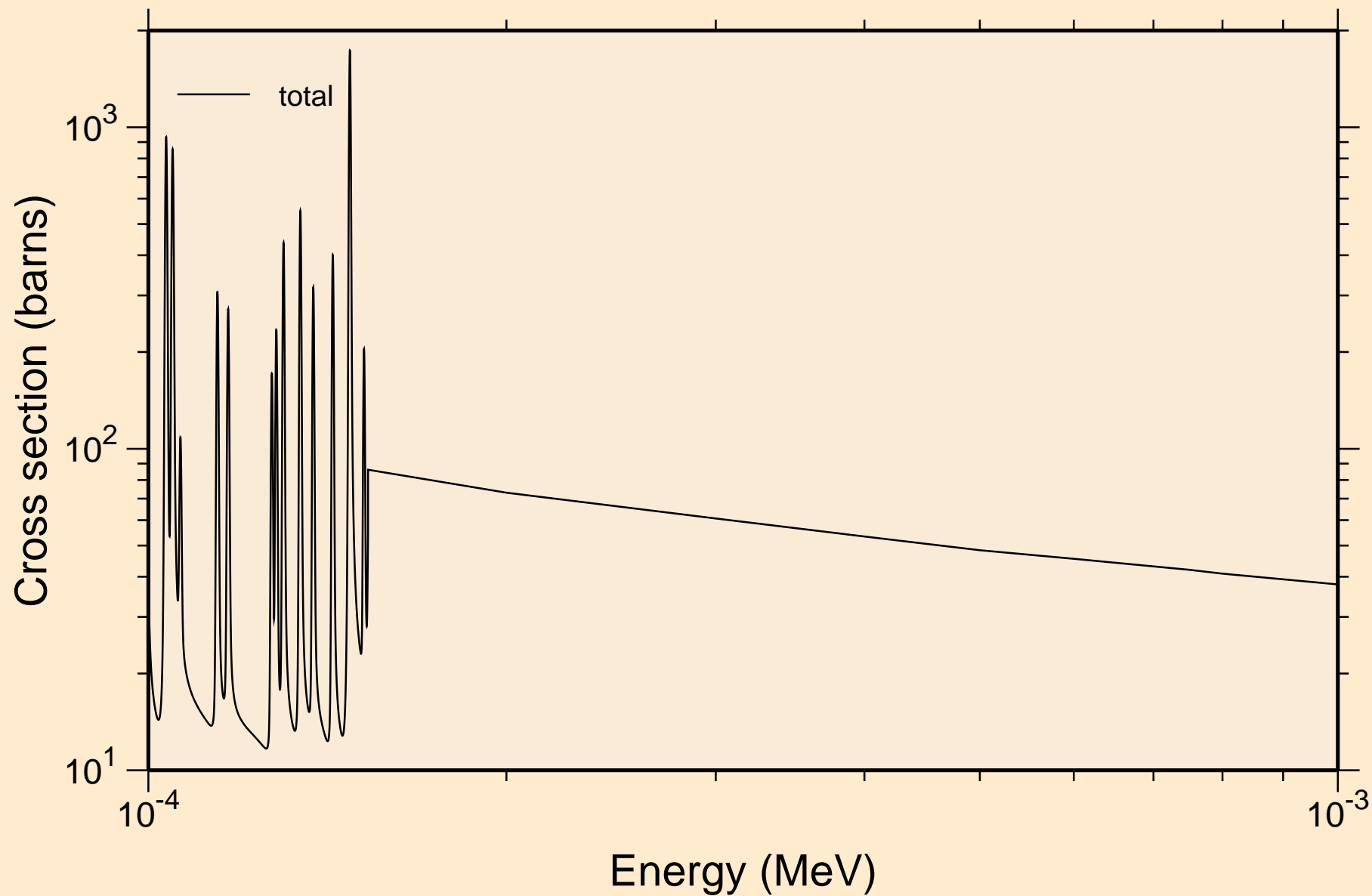

ENDF/B-VII.1 IR-191
resonance absorption cross sections

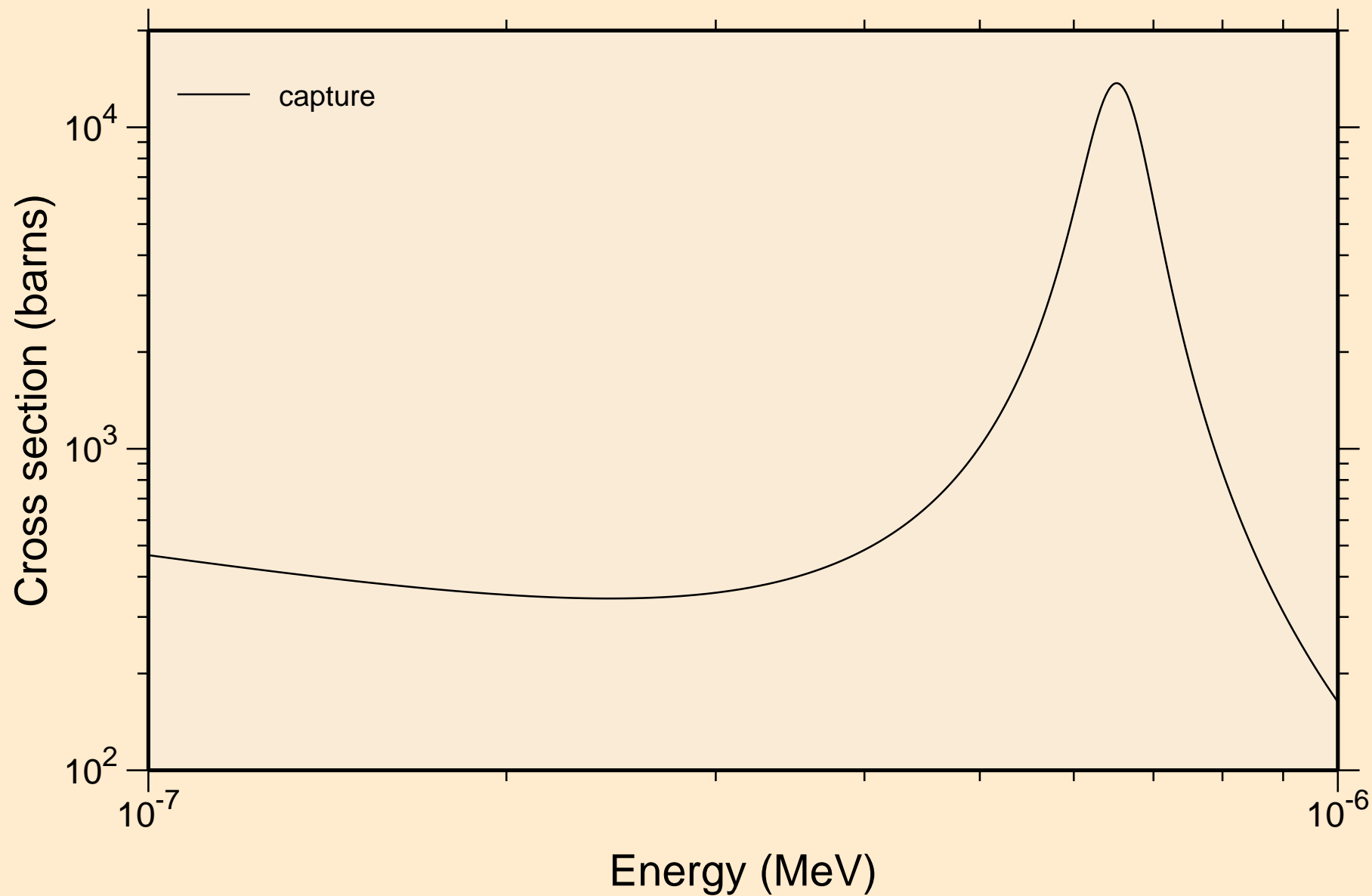

ENDF/B-VII.1 IR-191
resonance absorption cross sections

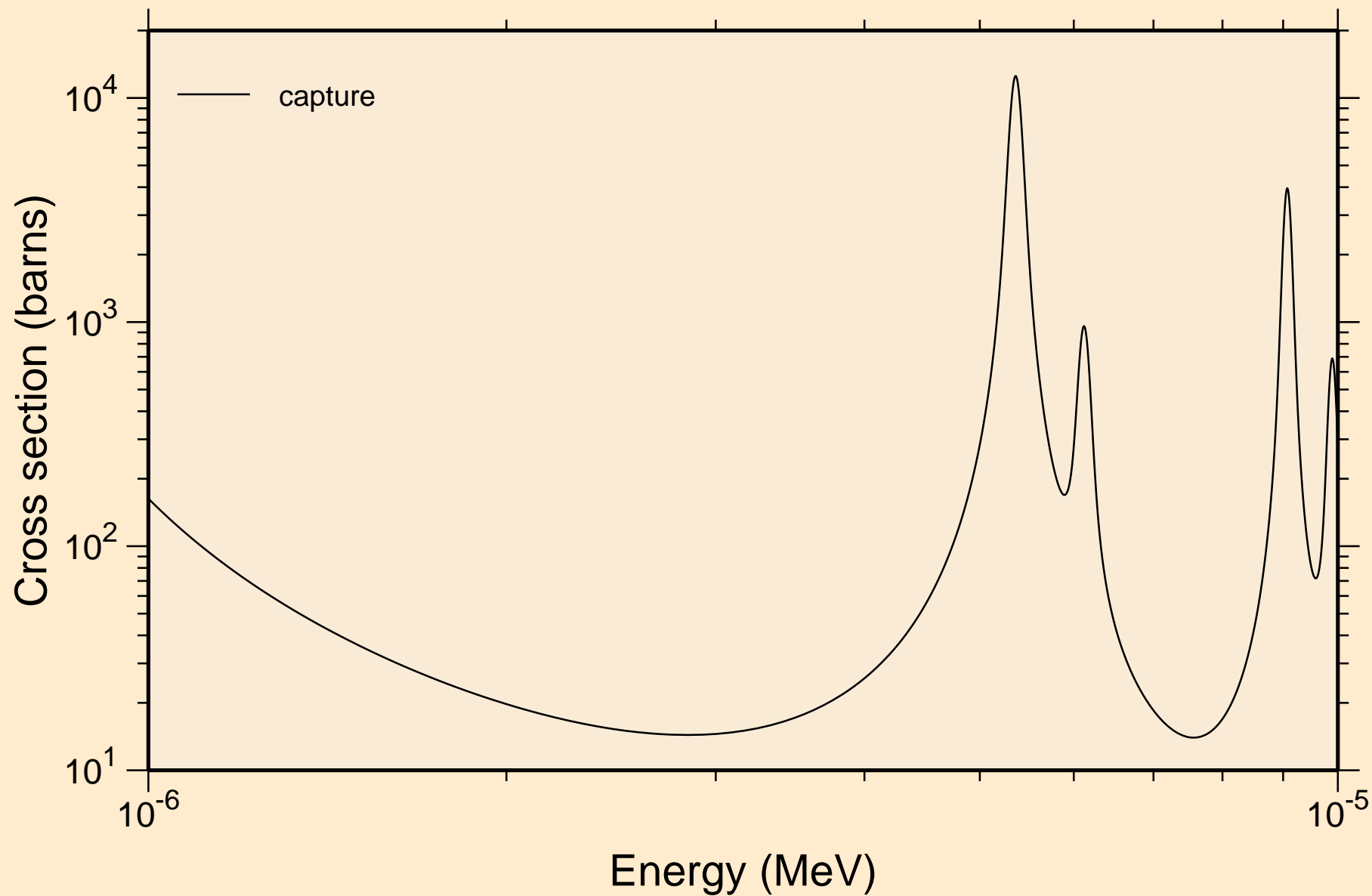

ENDF/B-VII.1 IR-191 resonance absorption cross sections

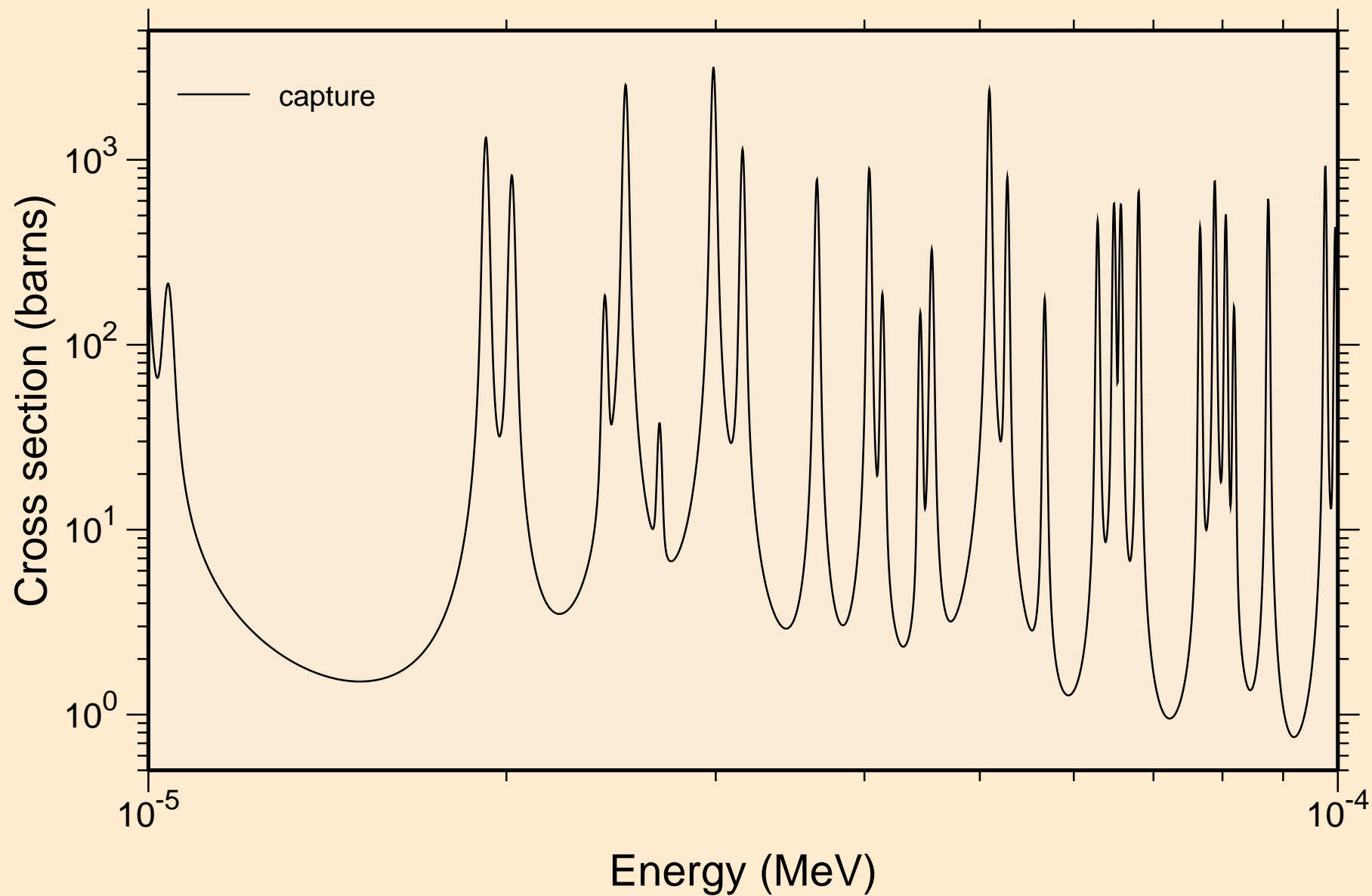

ENDF/B-VII.1 IR-191
resonance absorption cross sections

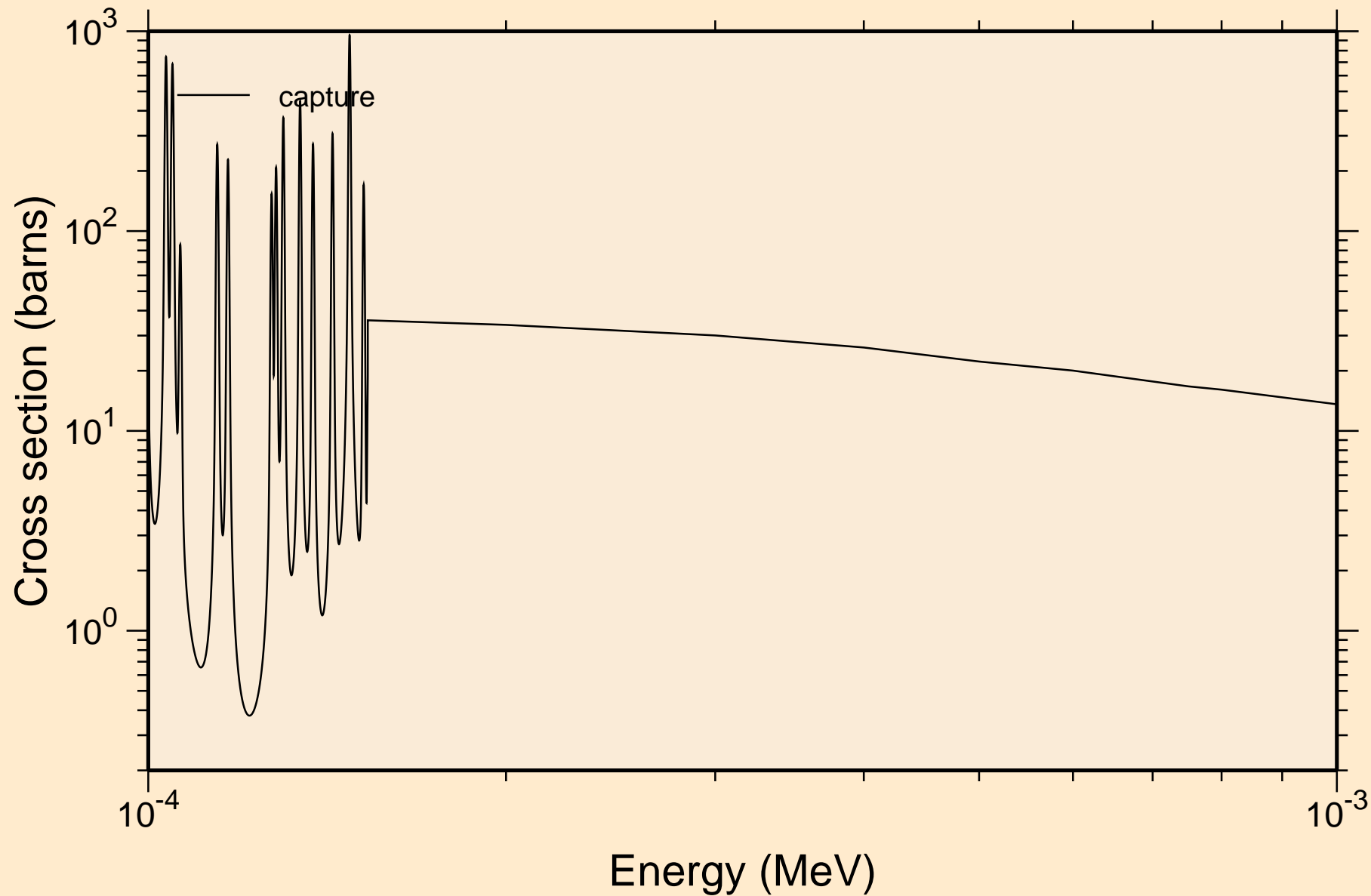

ENDF/B-VII.1 IR-191

Heating

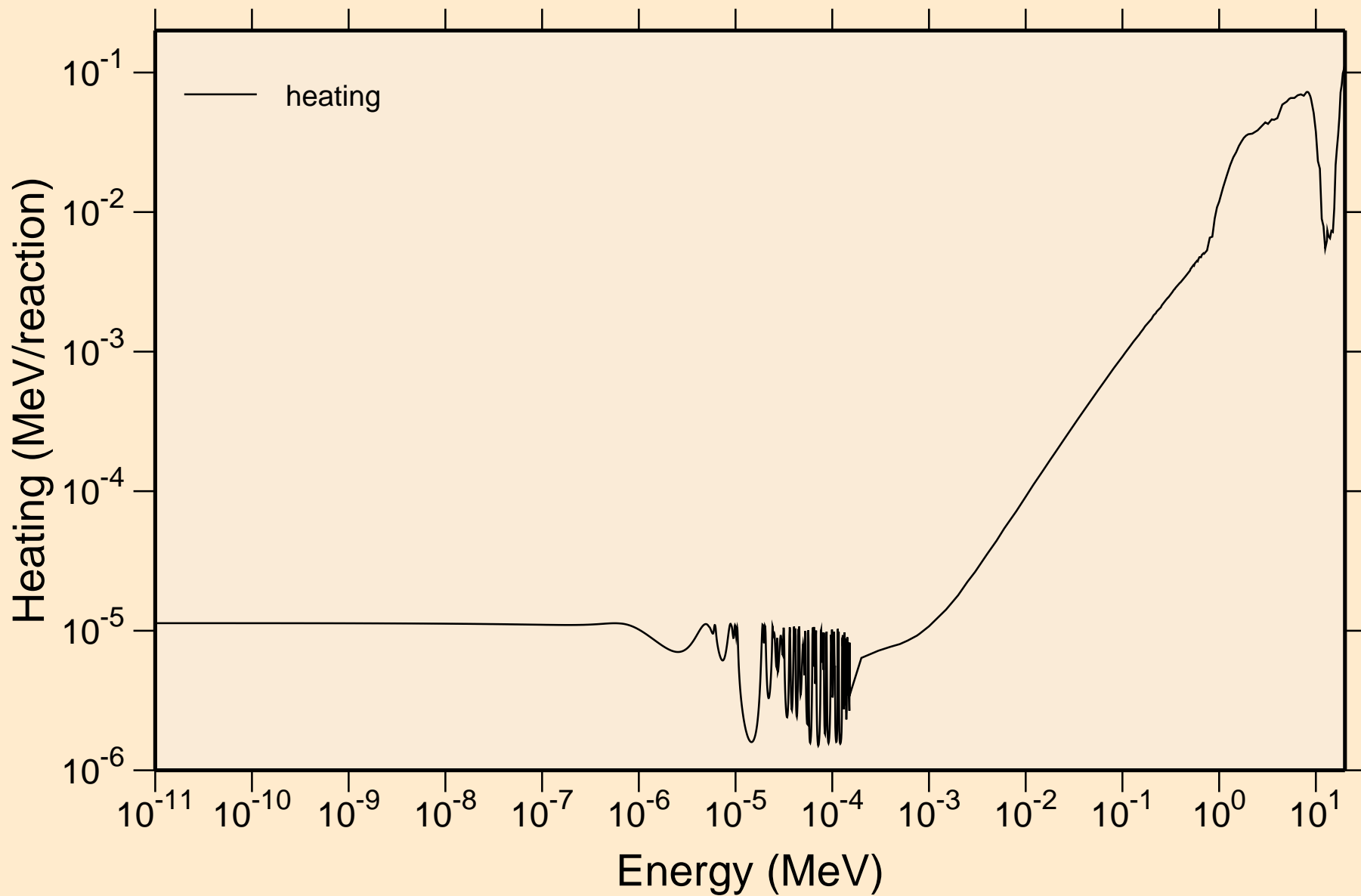

ENDF/B-VII.1 IR-191 Damage

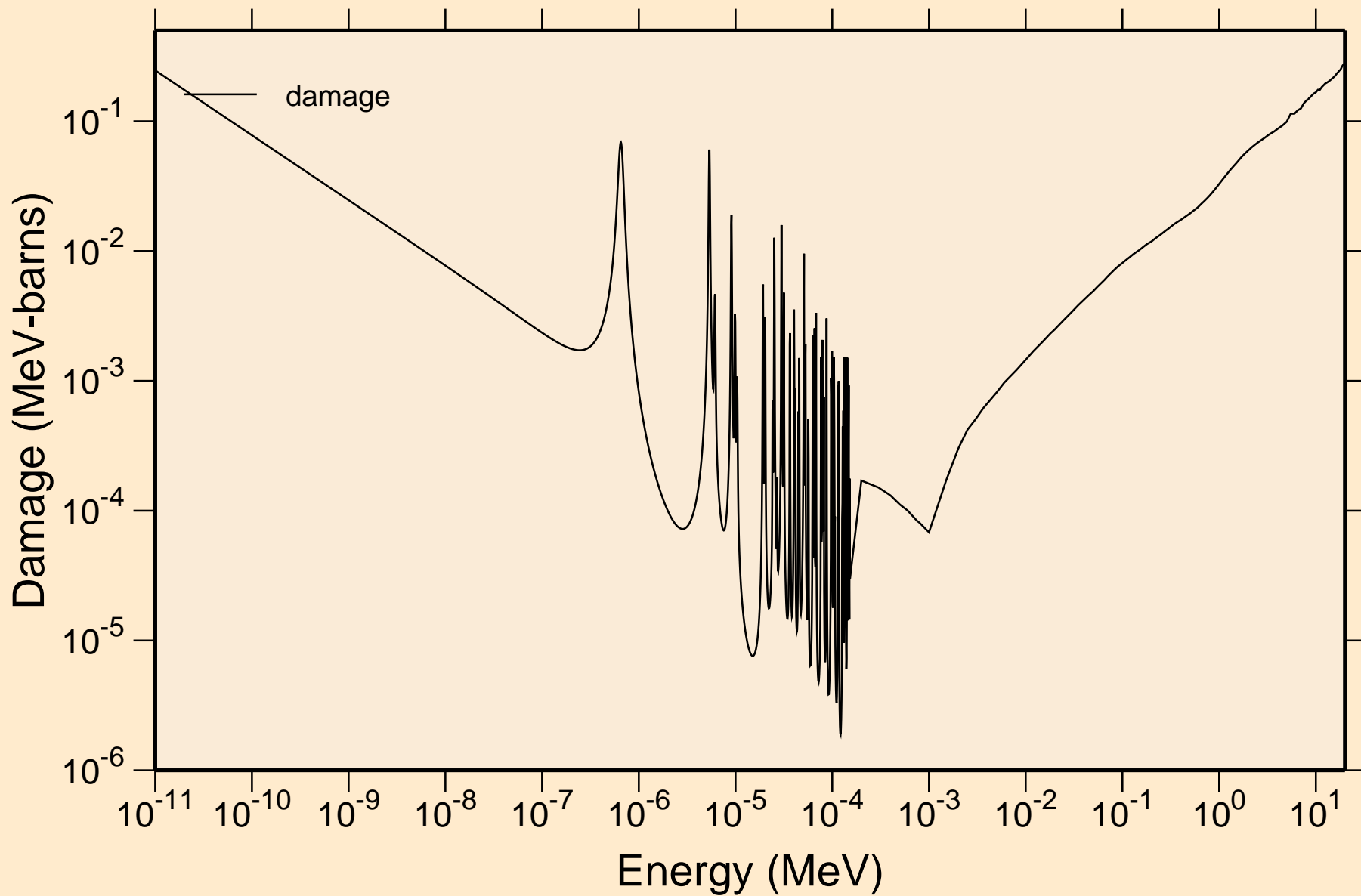

ENDF/B-VII.1 IR-191
Non-threshold reactions

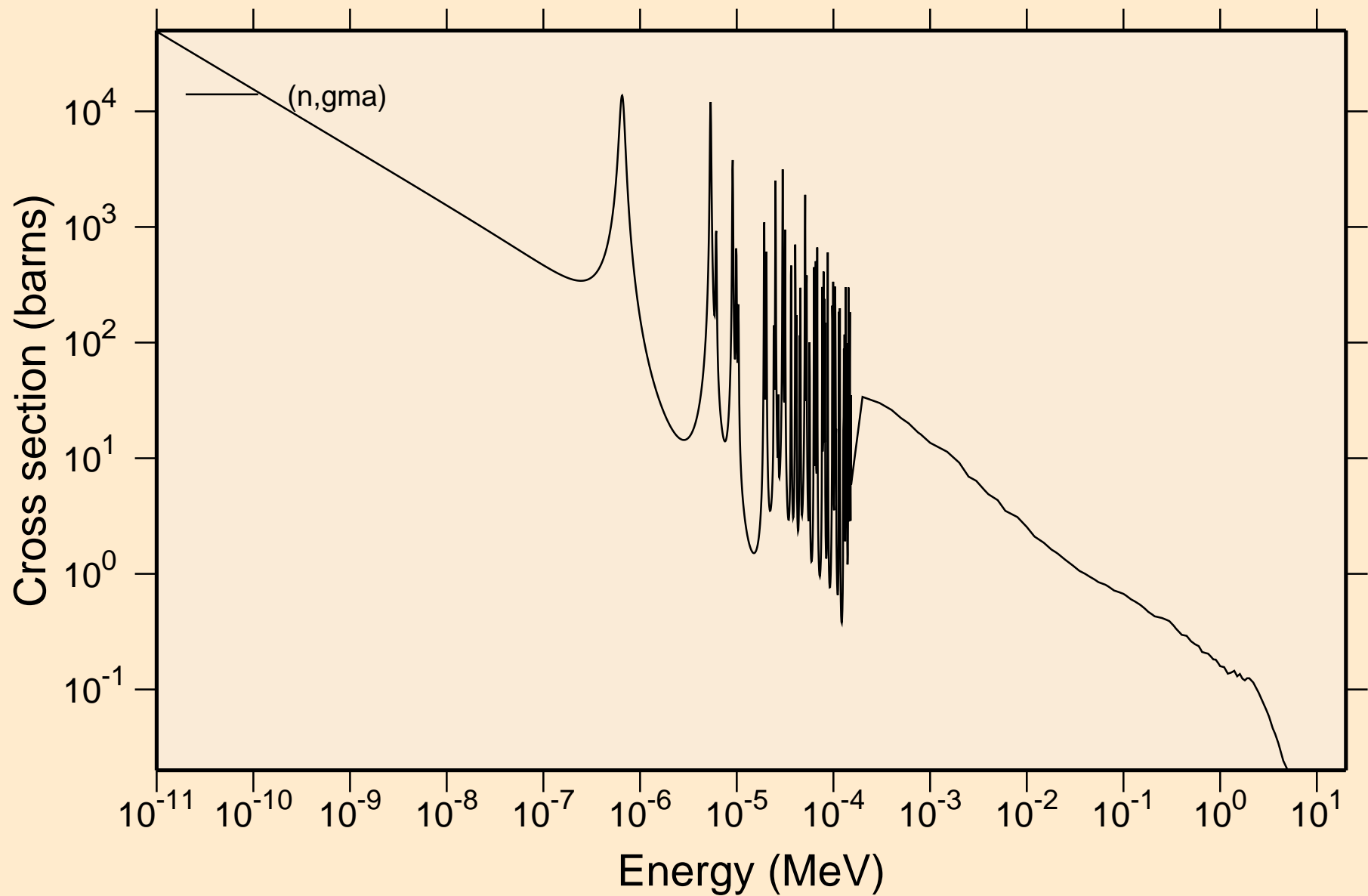

ENDF/B-VII.1 IR-191

Principal cross sections

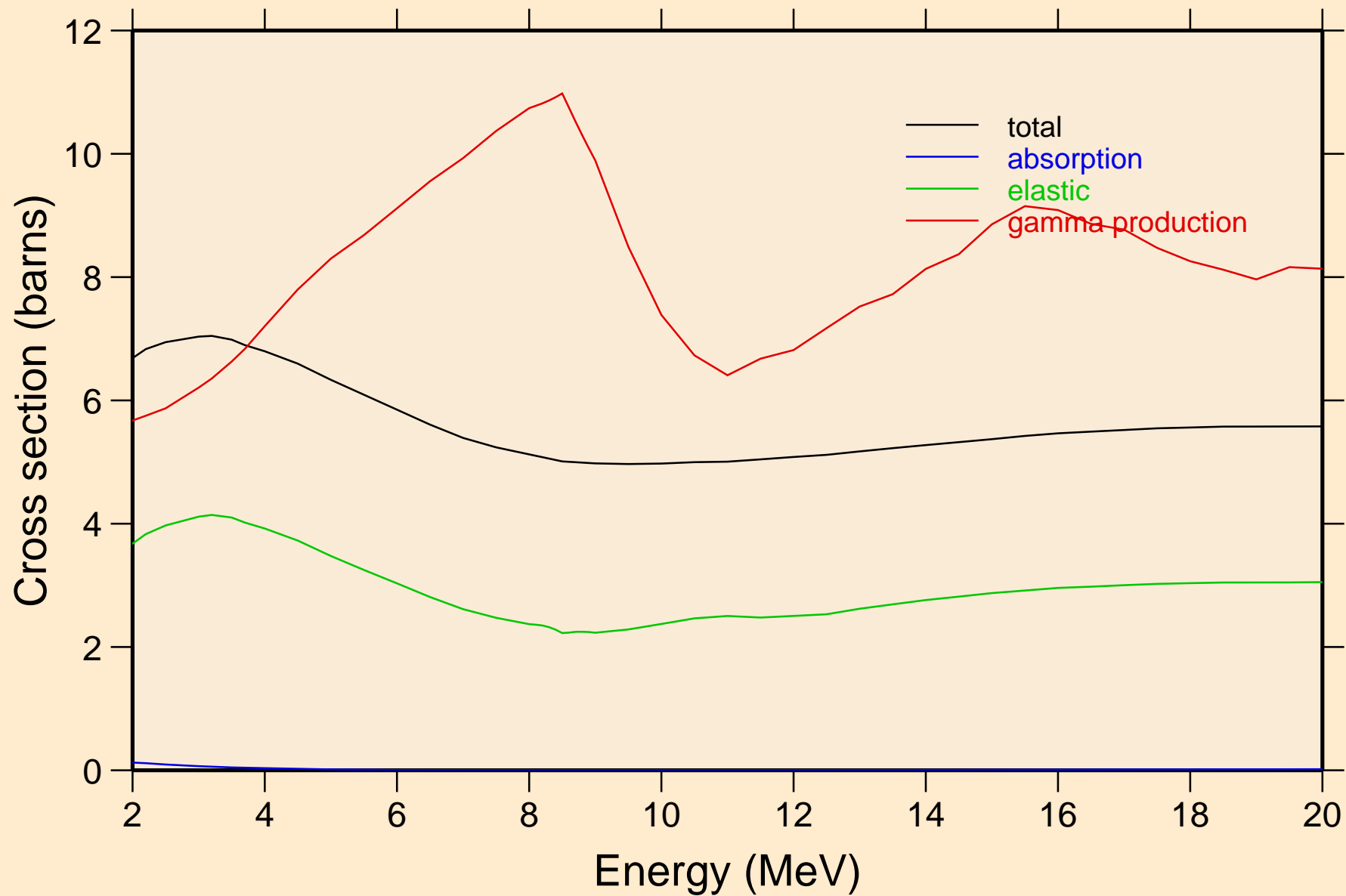

ENDF/B-VII.1 IR-191

Heating

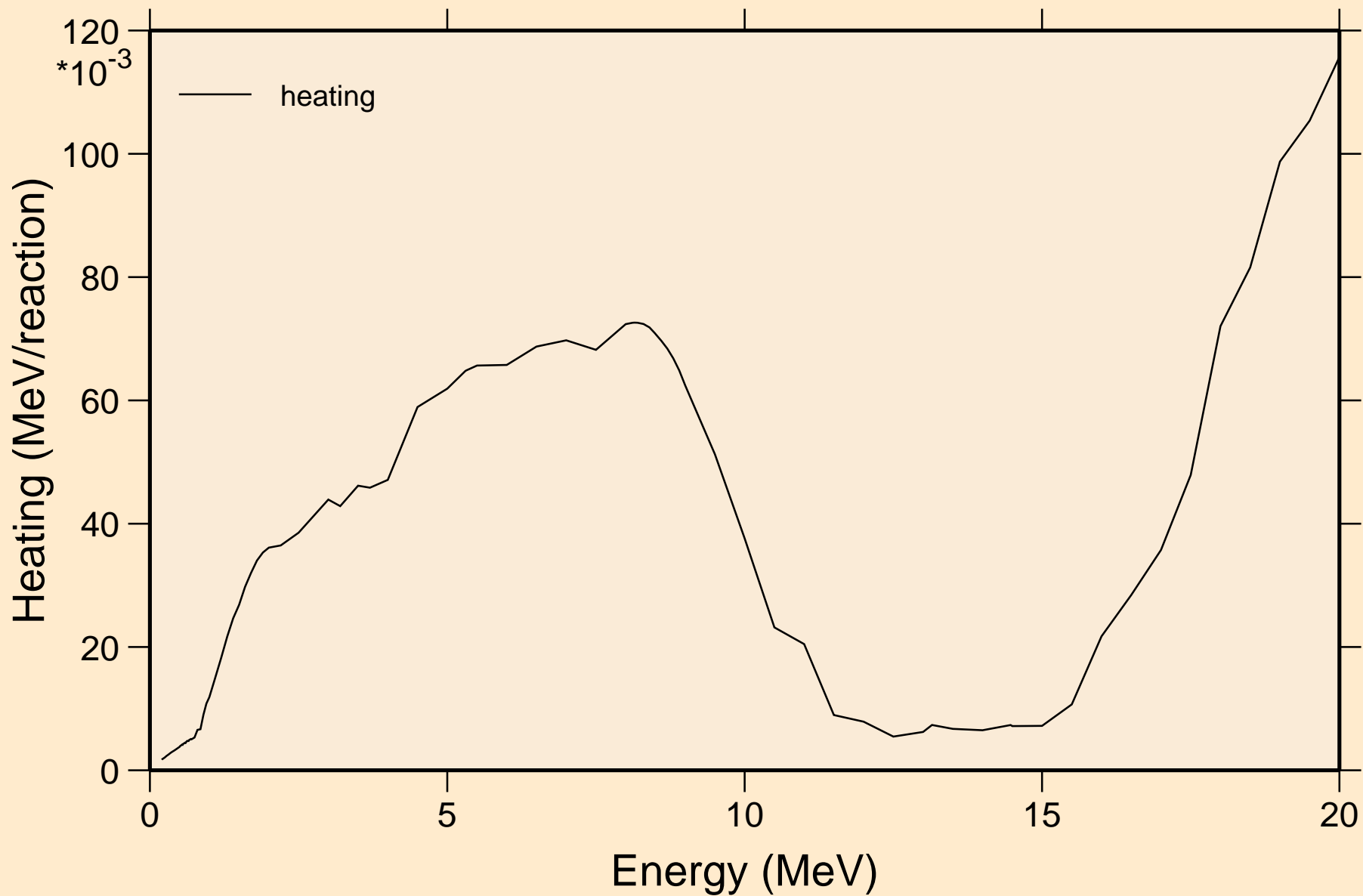

ENDF/B-VII.1 IR-191

Damage

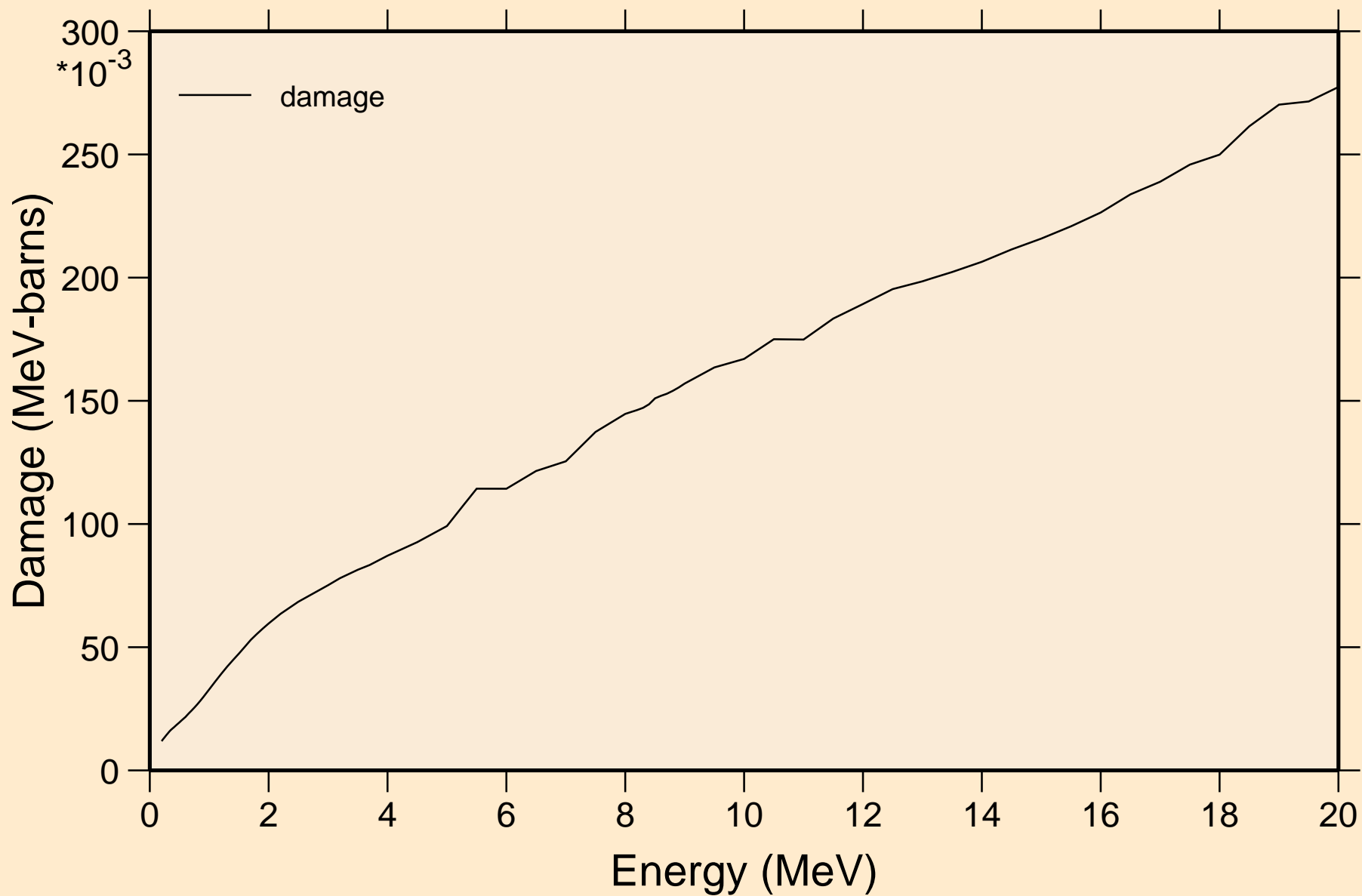

ENDF/B-VII.1 IR-191
Non-threshold reactions

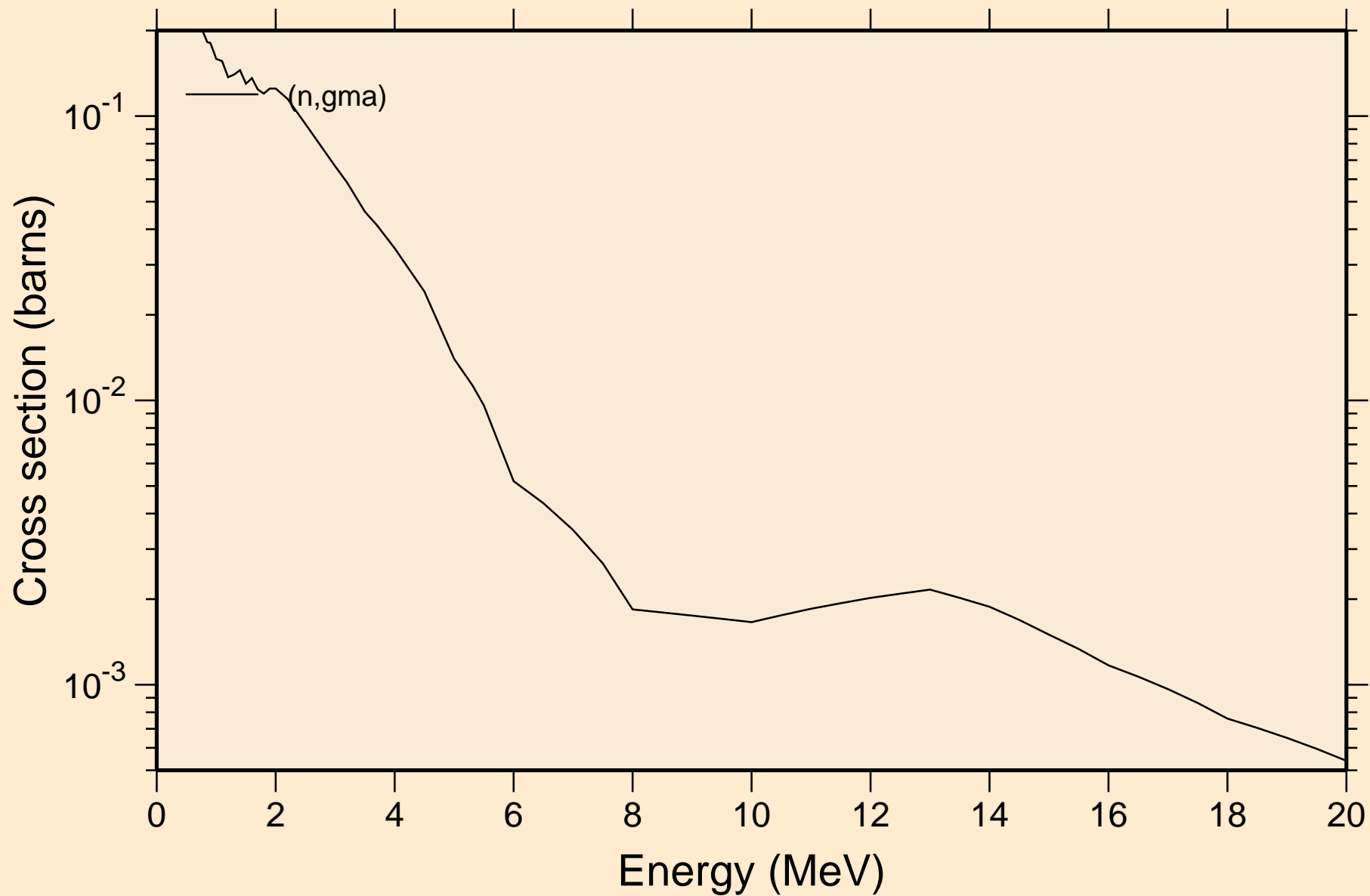

ENDF/B-VII.1 IR-191

Inelastic levels

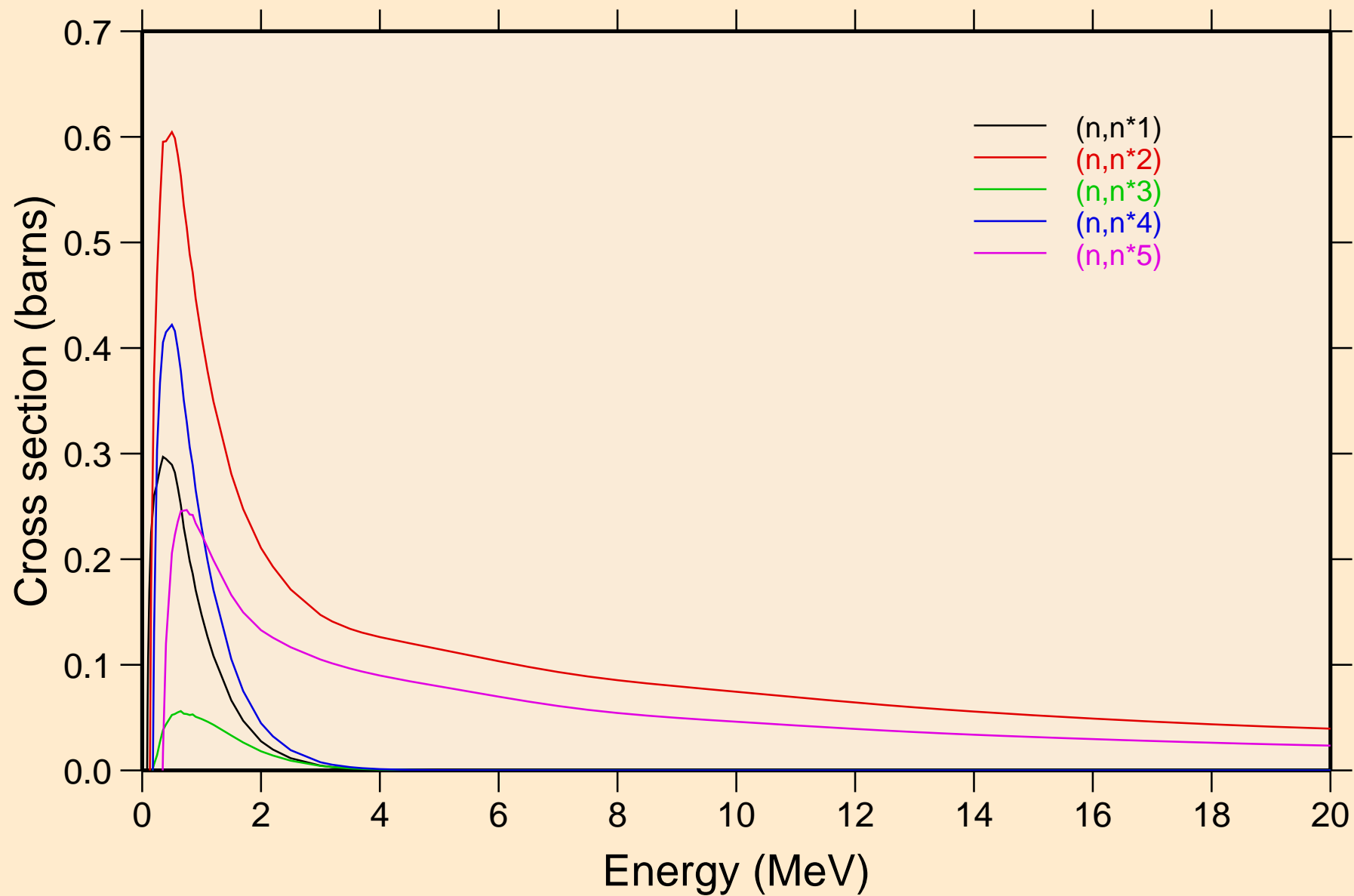

ENDF/B-VII.1 IR-191

Inelastic levels

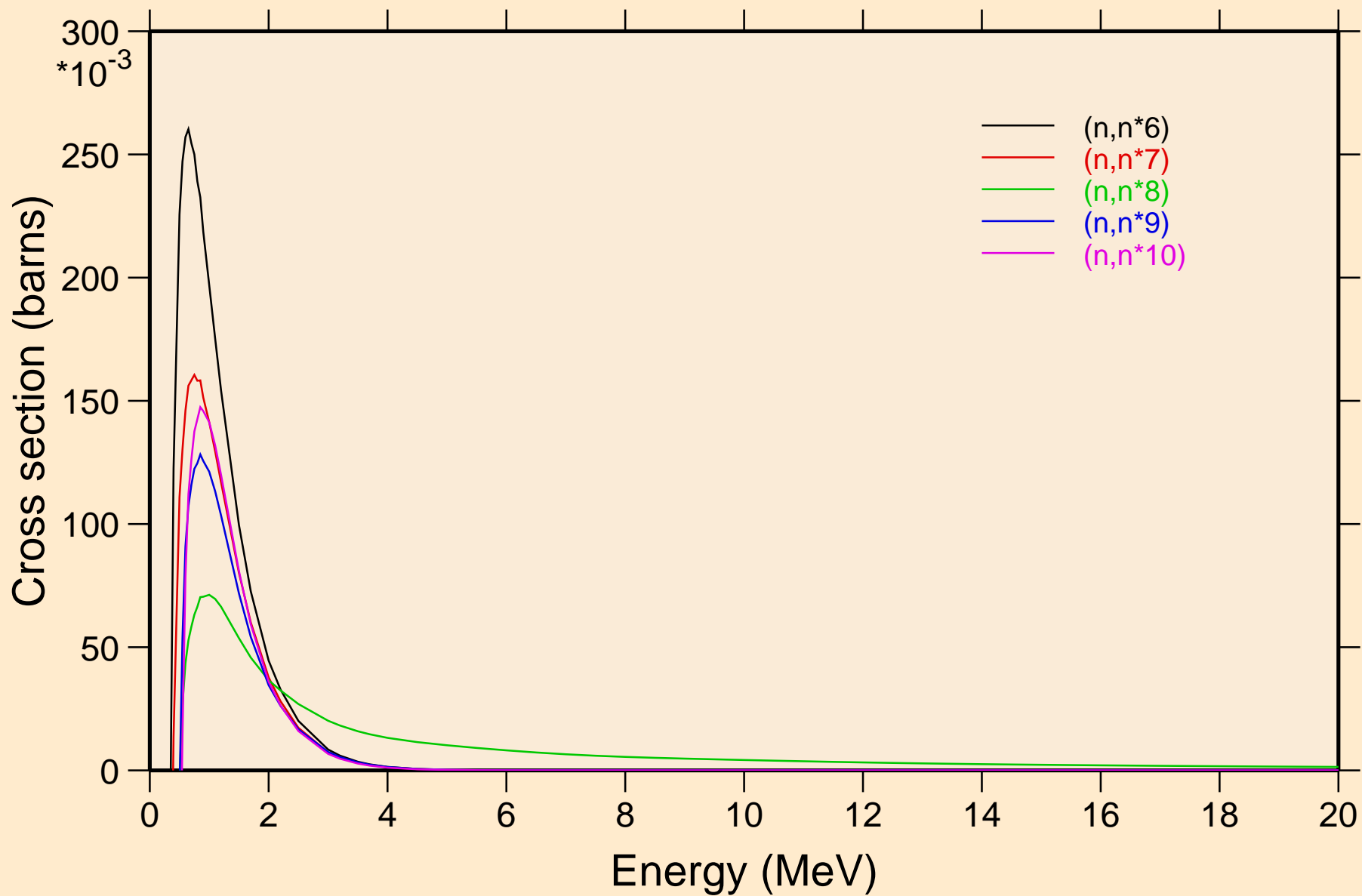

ENDF/B-VII.1 IR-191

Inelastic levels

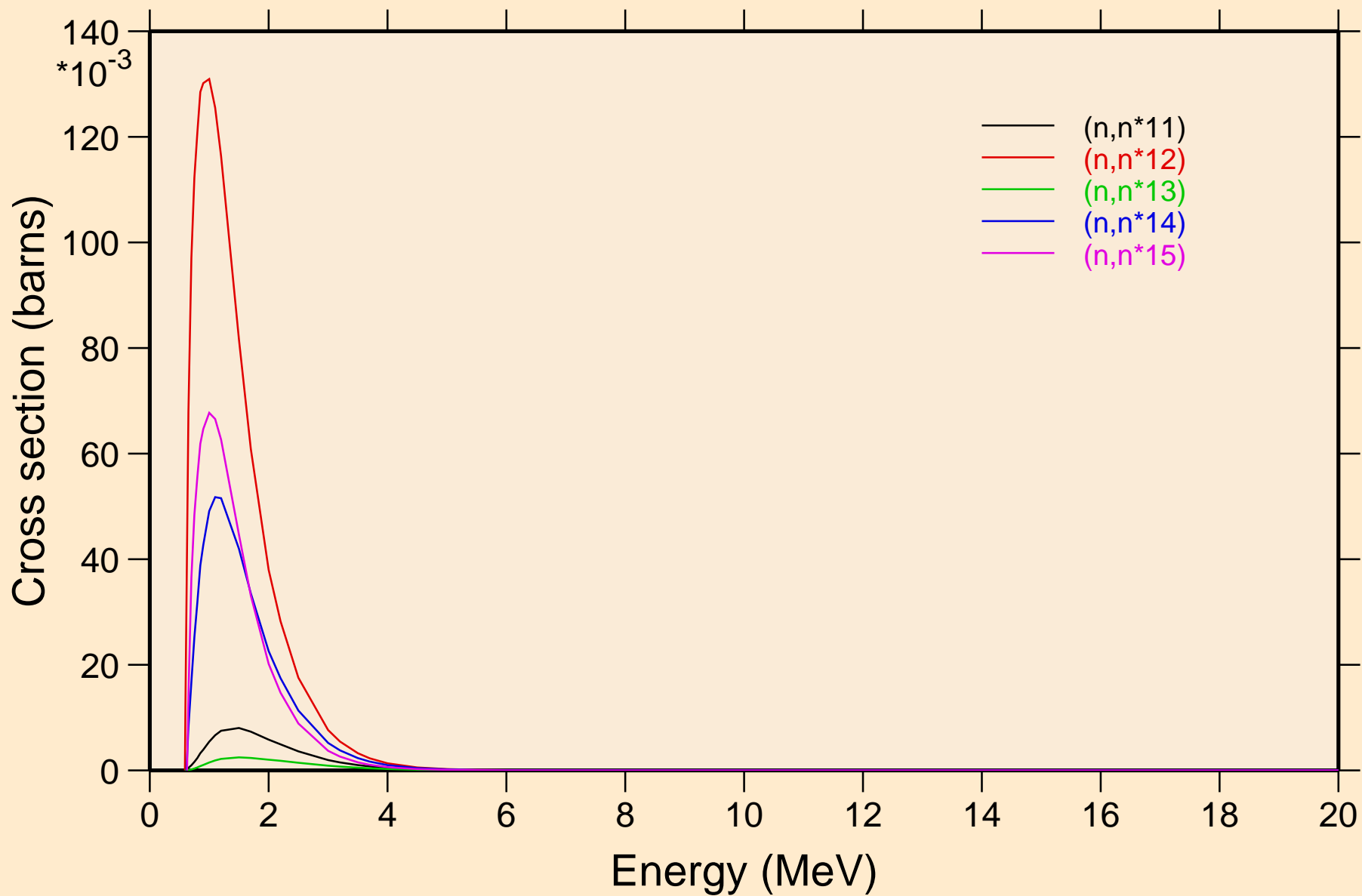

ENDF/B-VII.1 IR-191

Inelastic levels

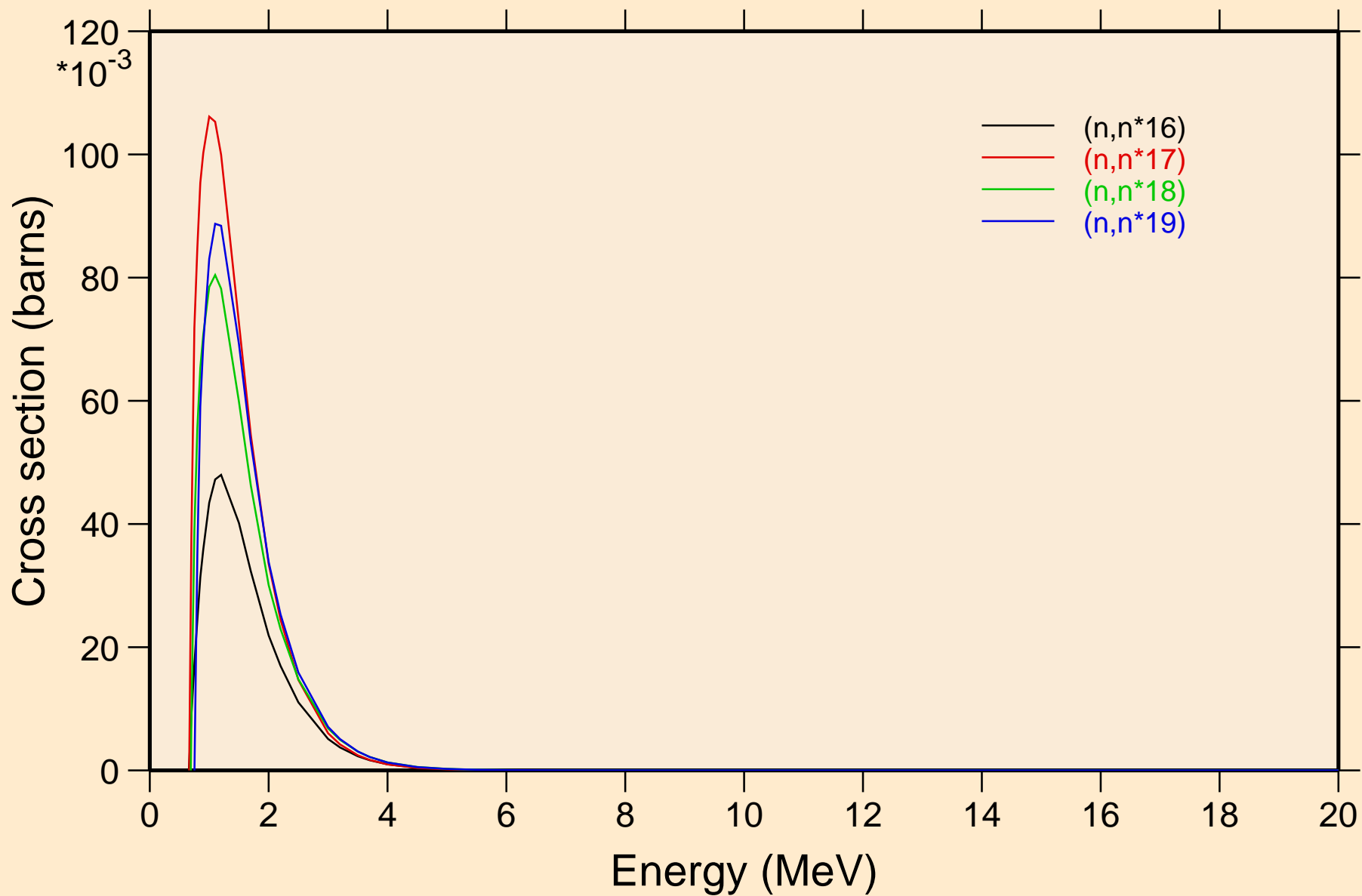

ENDF/B-VII.1 IR-191

Threshold reactions

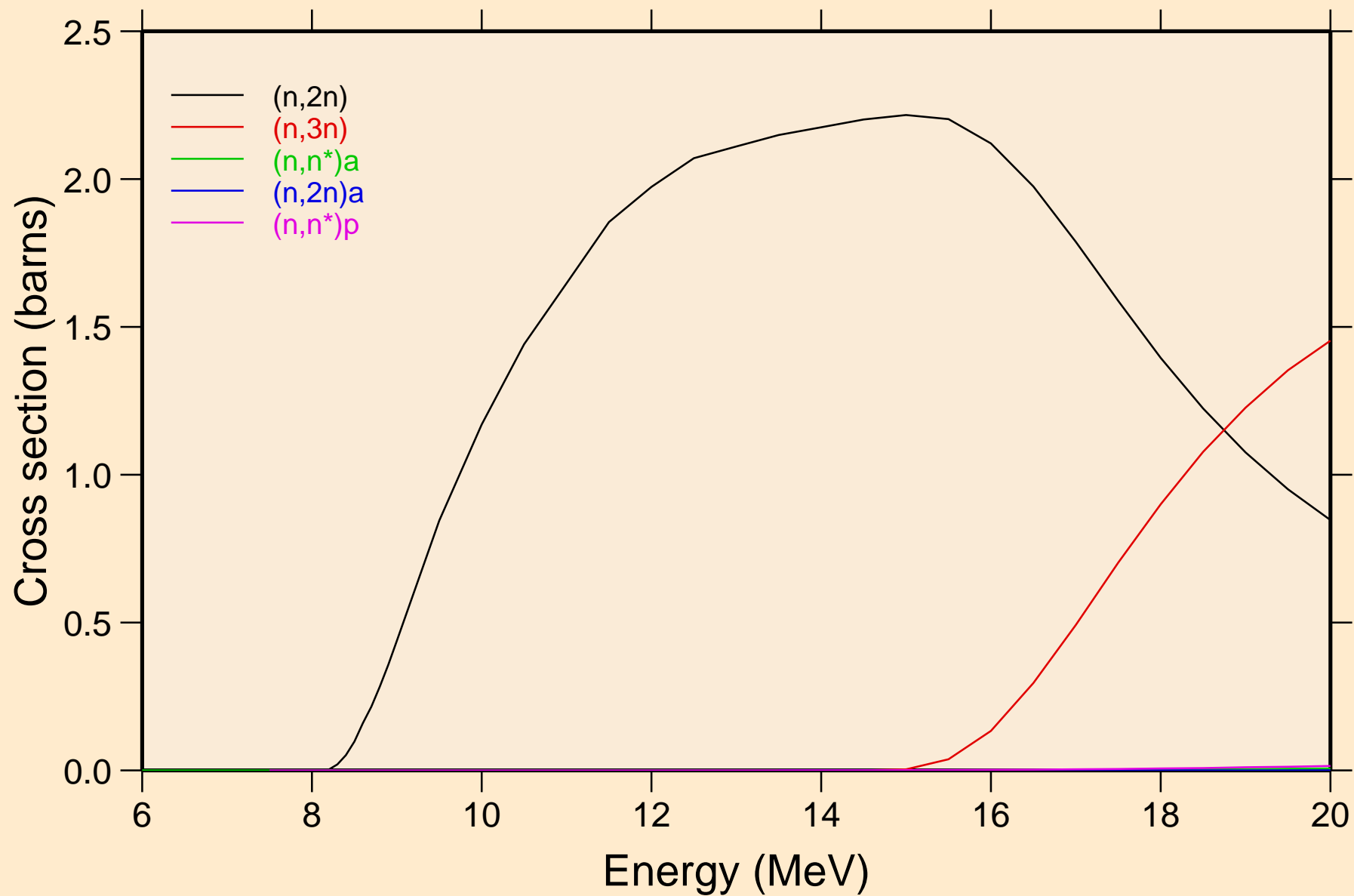

ENDF/B-VII.1 IR-191

Threshold reactions

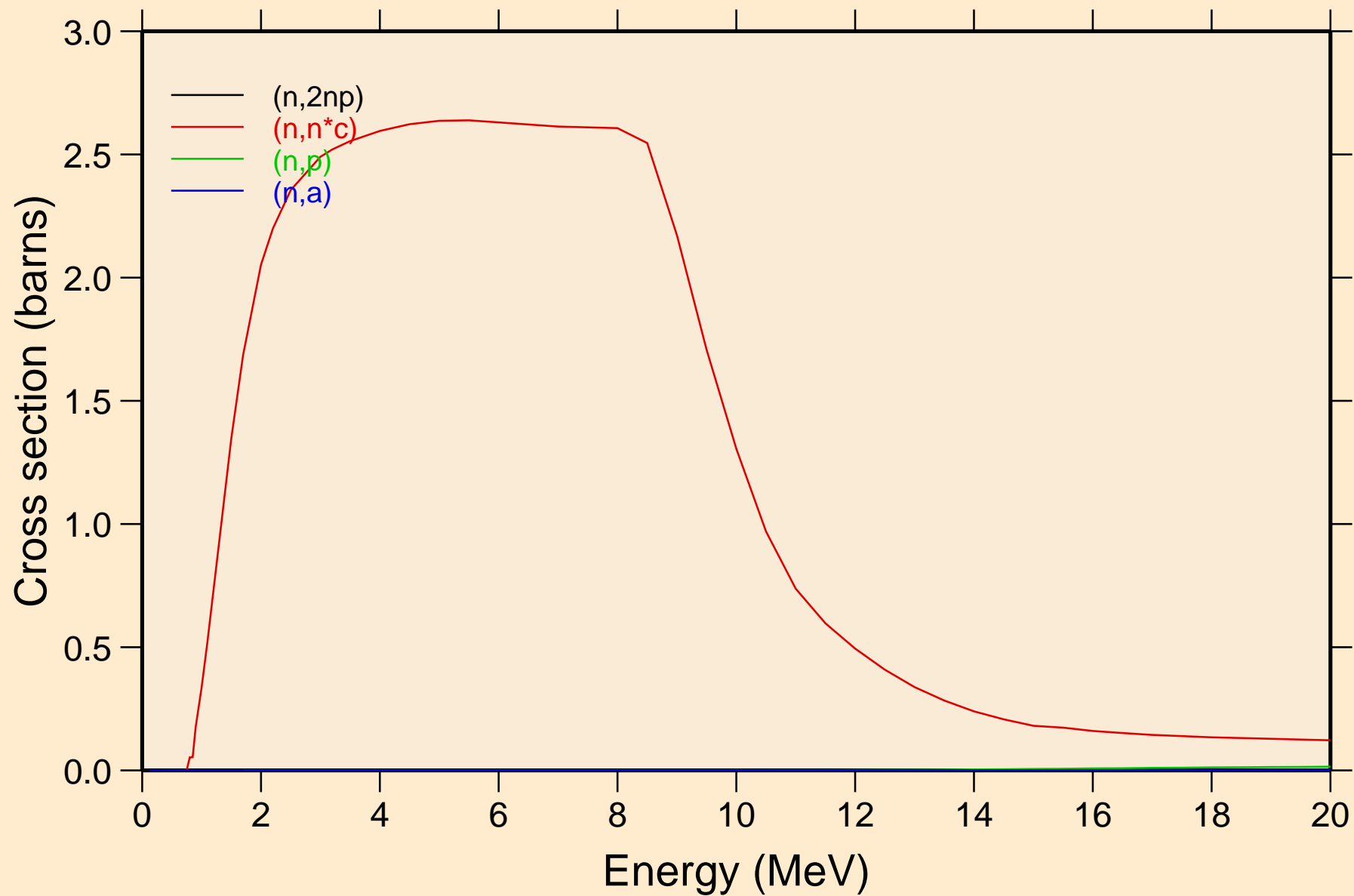

ENDF/B-VII.1 IR-191

Threshold reactions

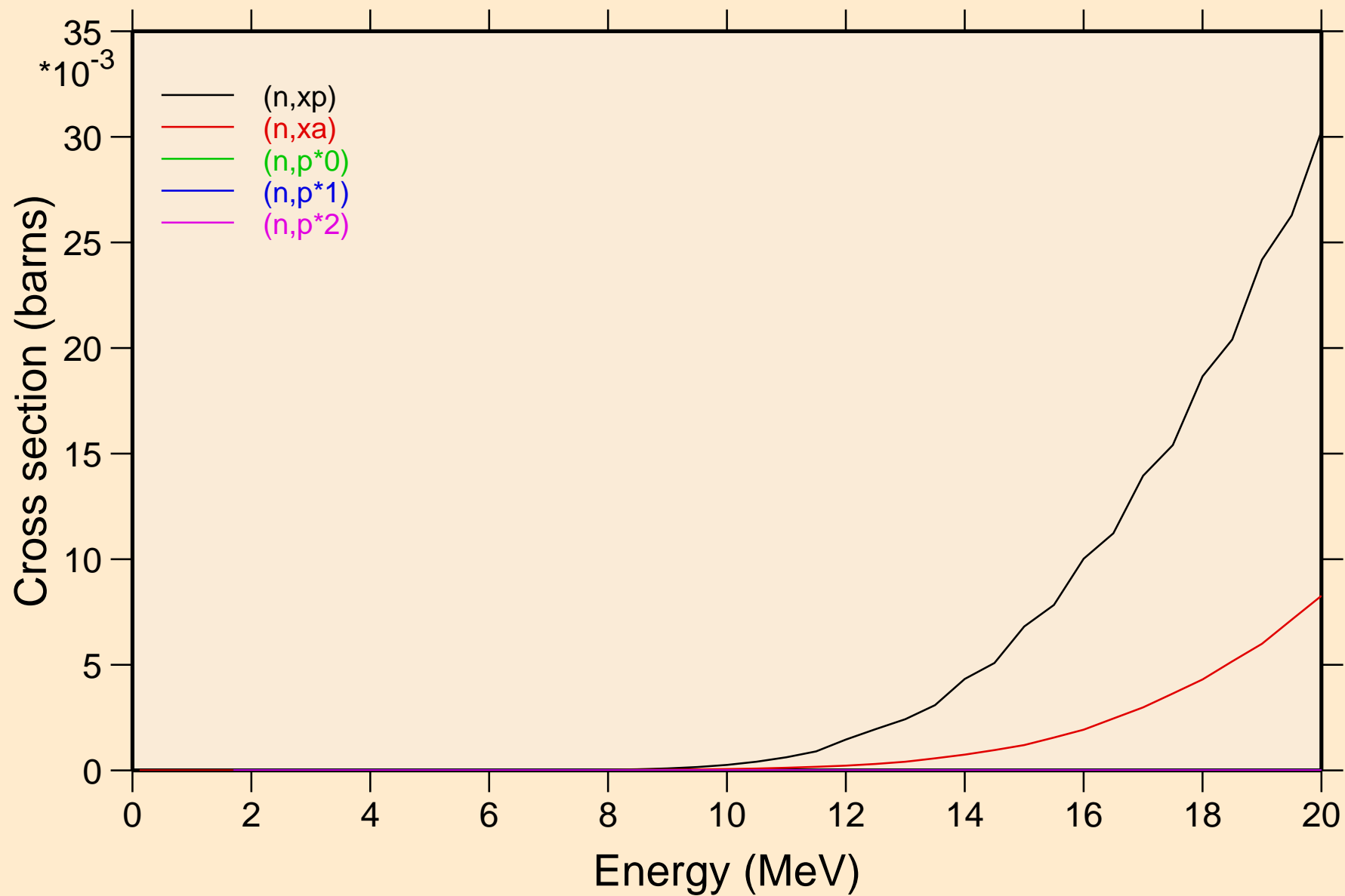

ENDF/B-VII.1 IR-191

Threshold reactions

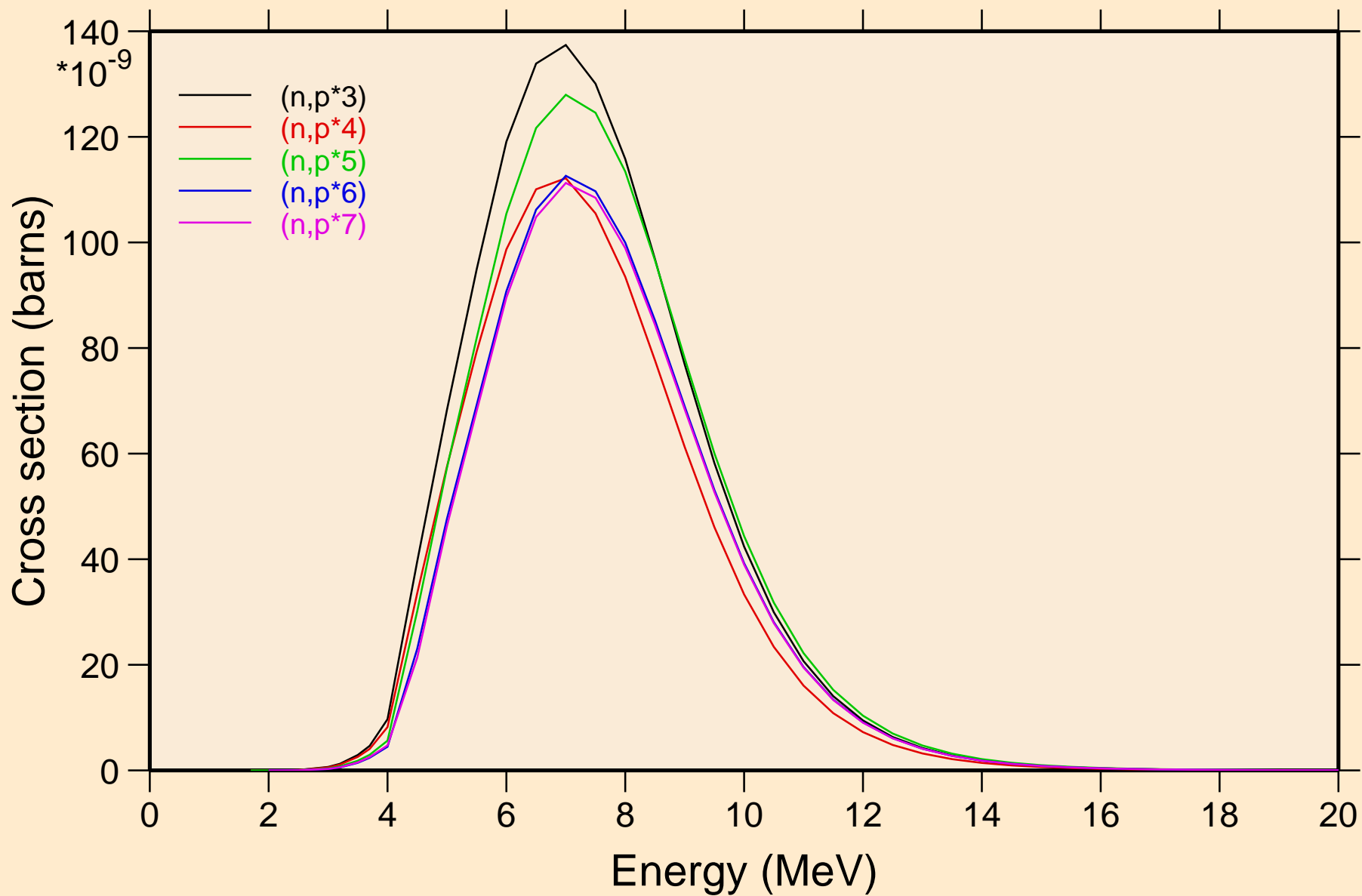

ENDF/B-VII.1 IR-191

Threshold reactions

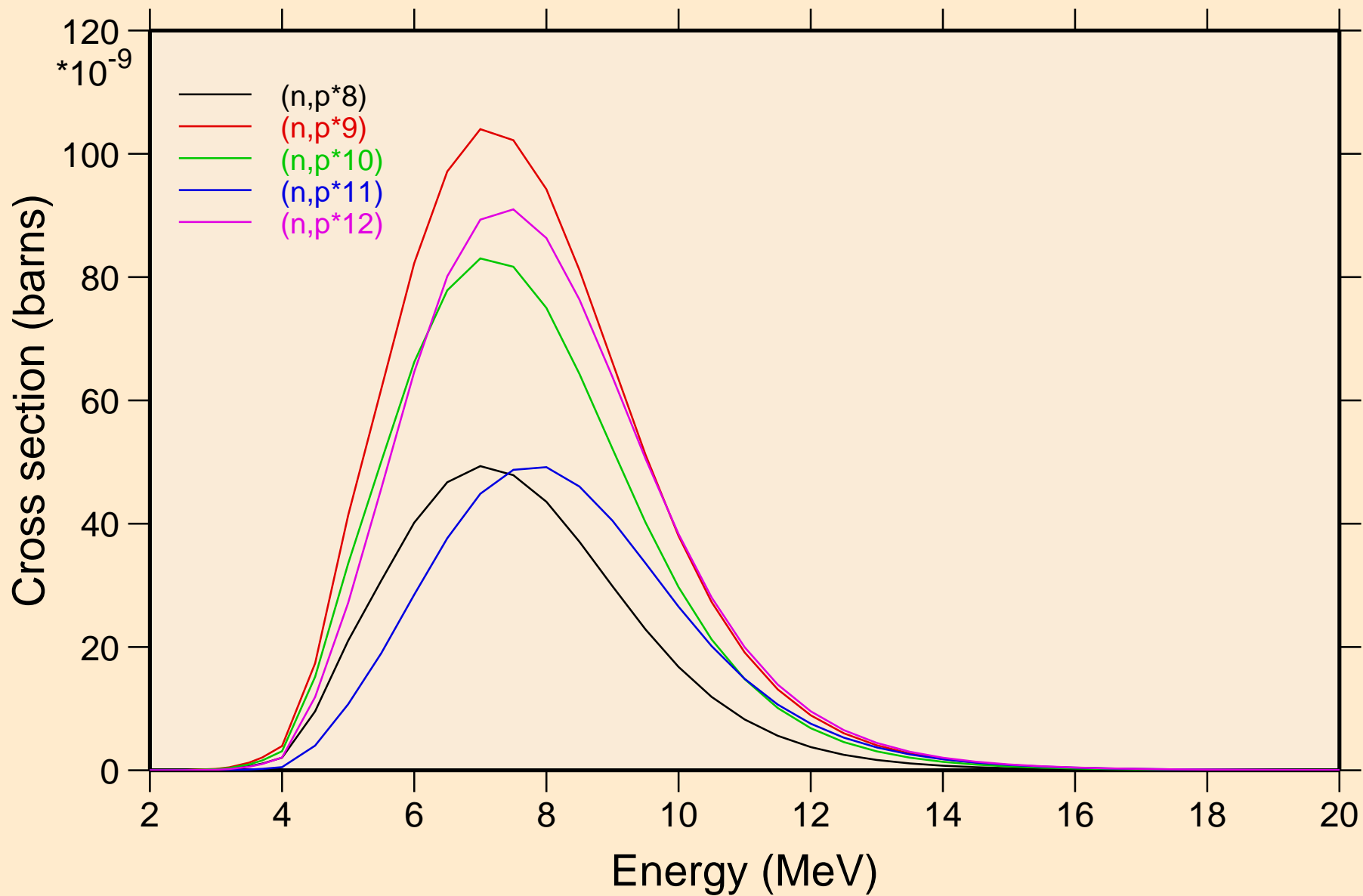

ENDF/B-VII.1 IR-191

Threshold reactions

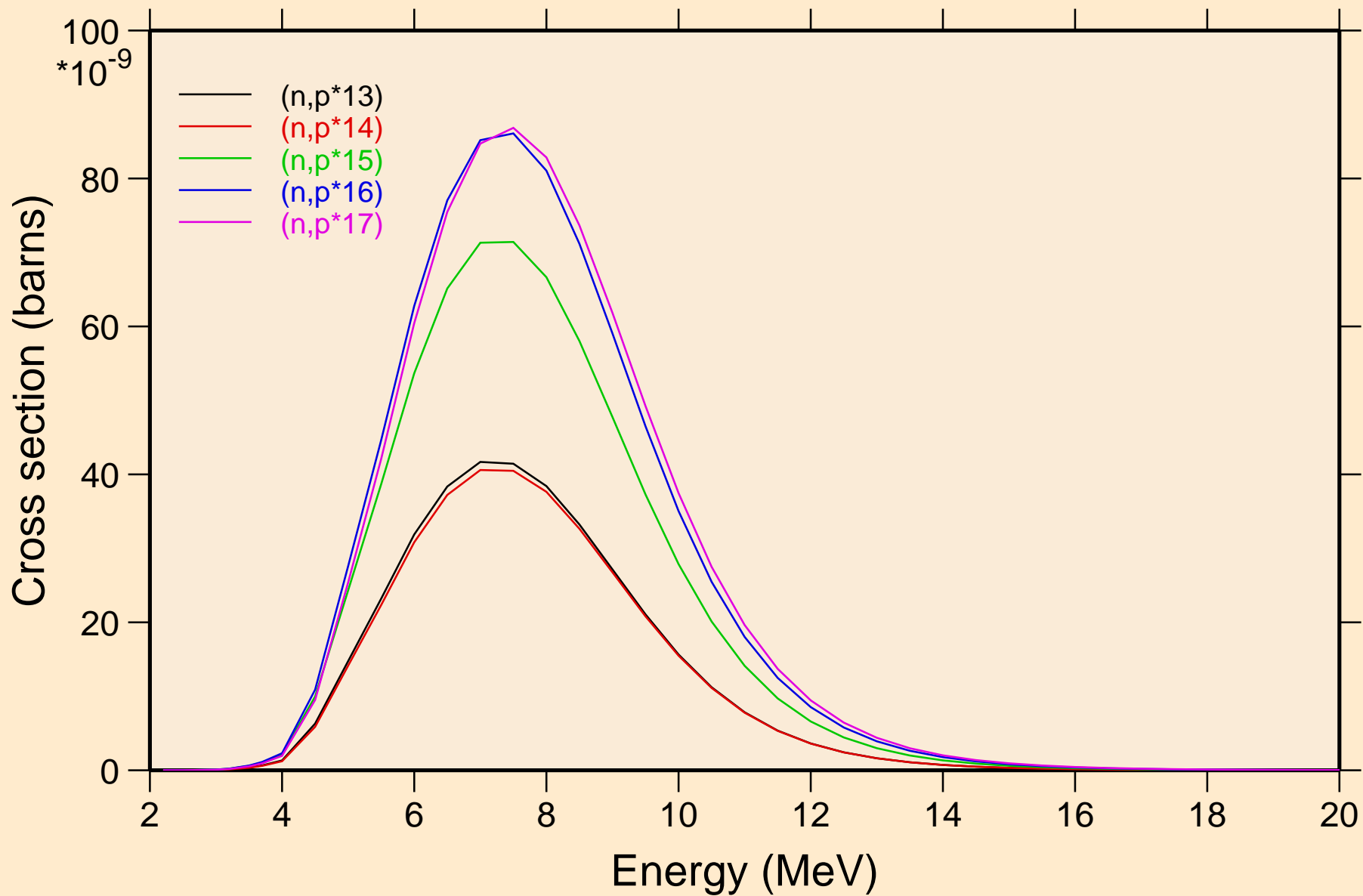

ENDF/B-VII.1 IR-191

Threshold reactions

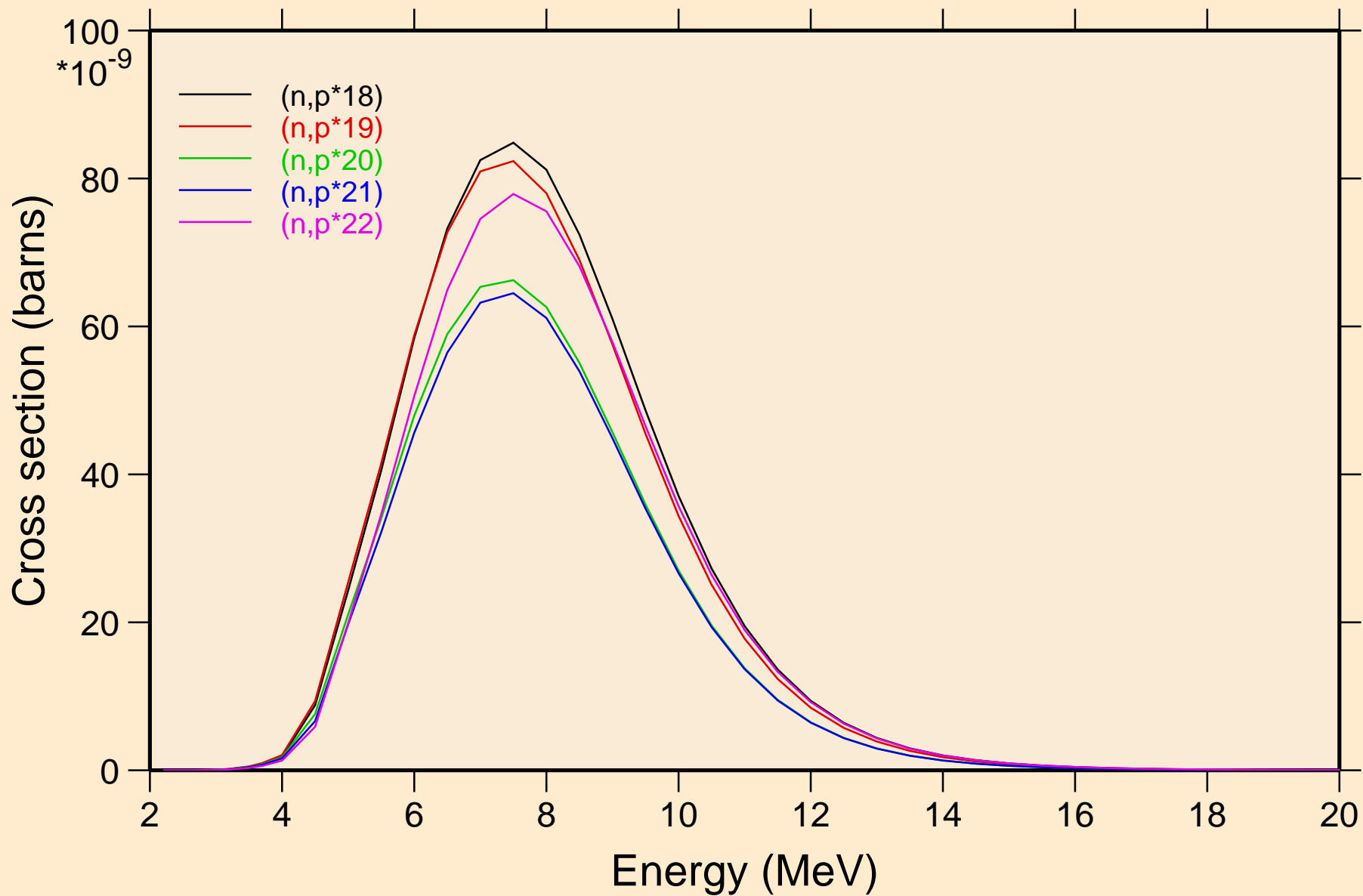

ENDF/B-VII.1 IR-191

Threshold reactions

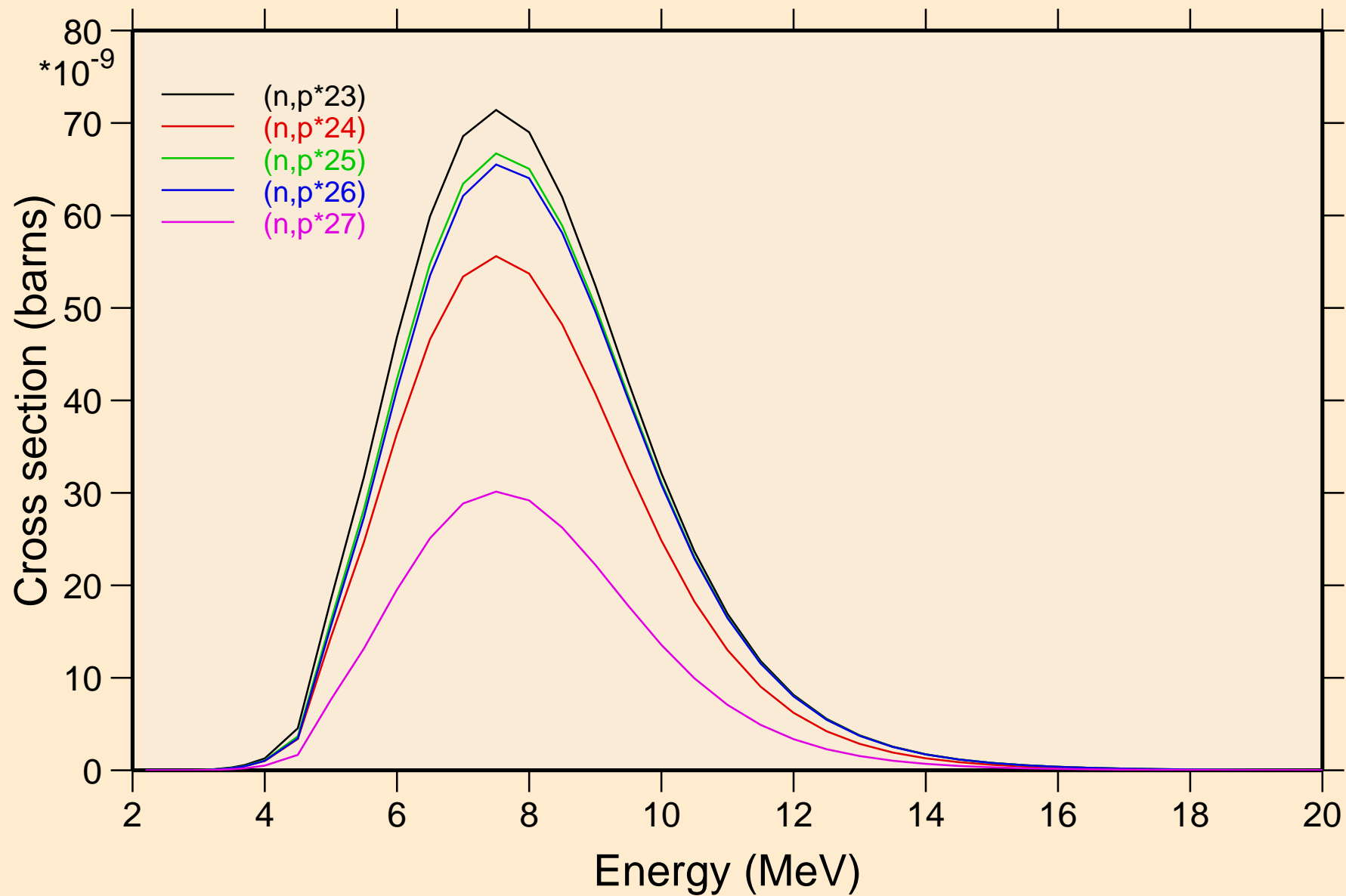

ENDF/B-VII.1 IR-191

Threshold reactions

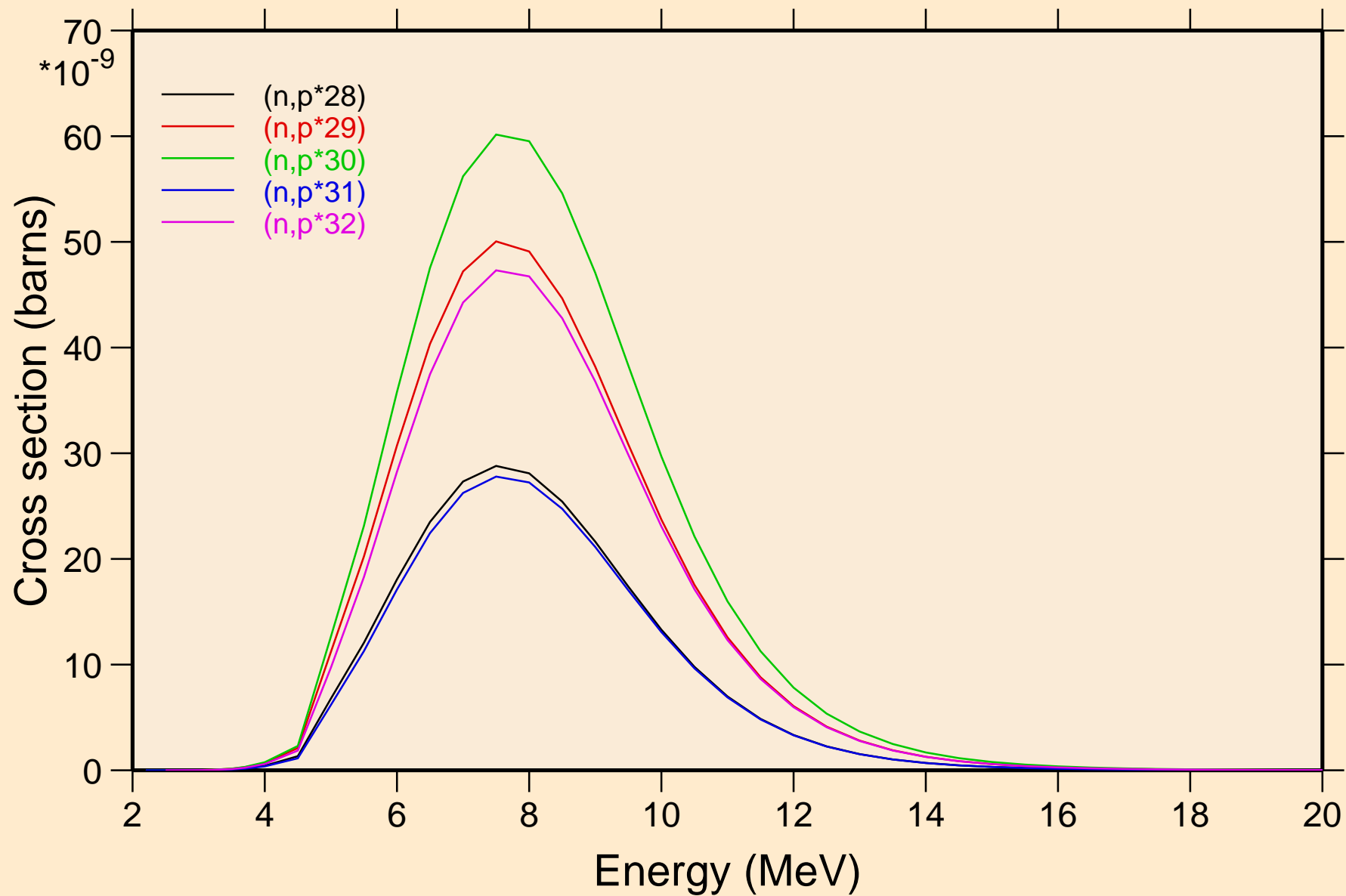

ENDF/B-VII.1 IR-191

Threshold reactions

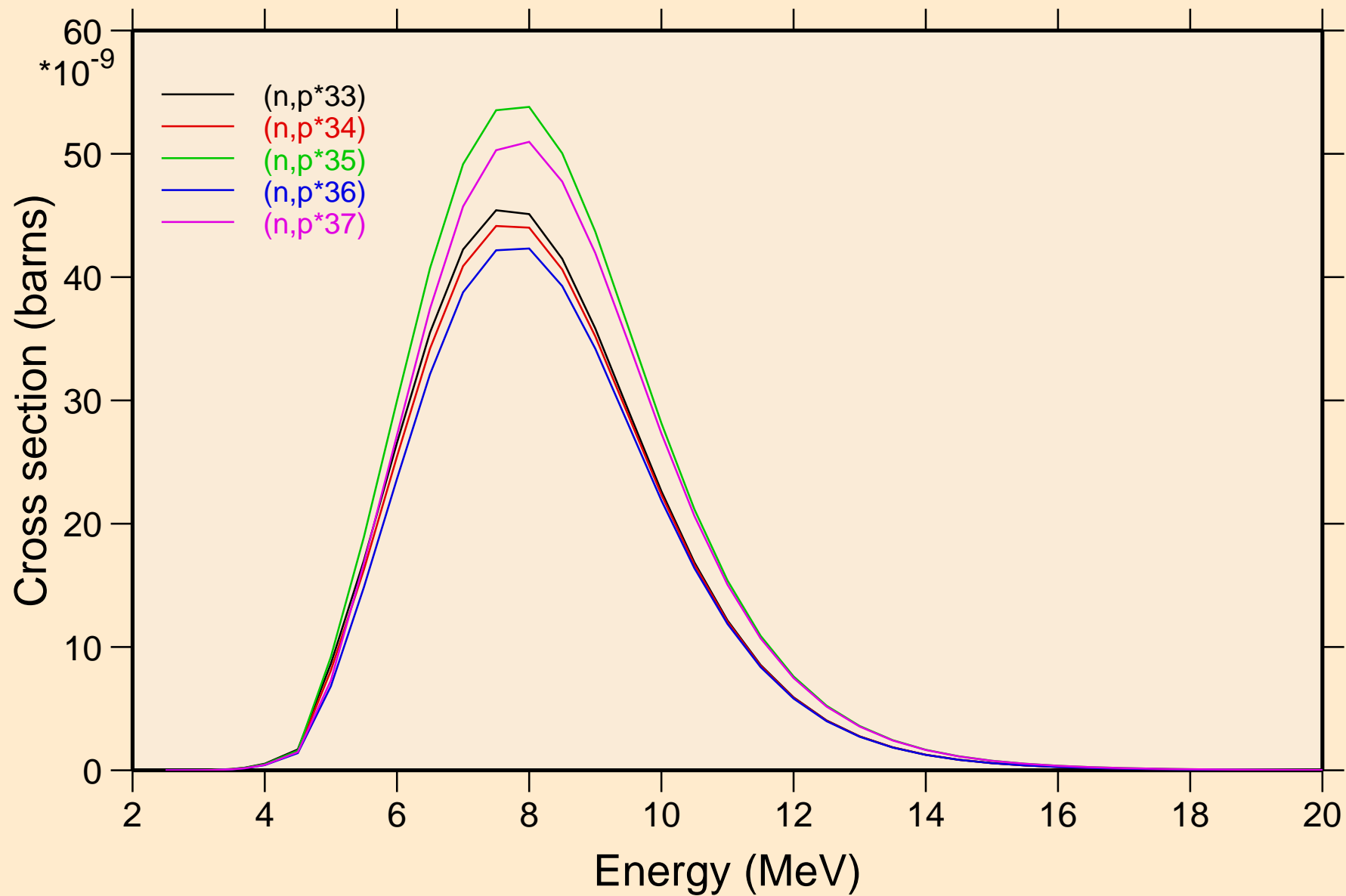

ENDF/B-VII.1 IR-191

Threshold reactions

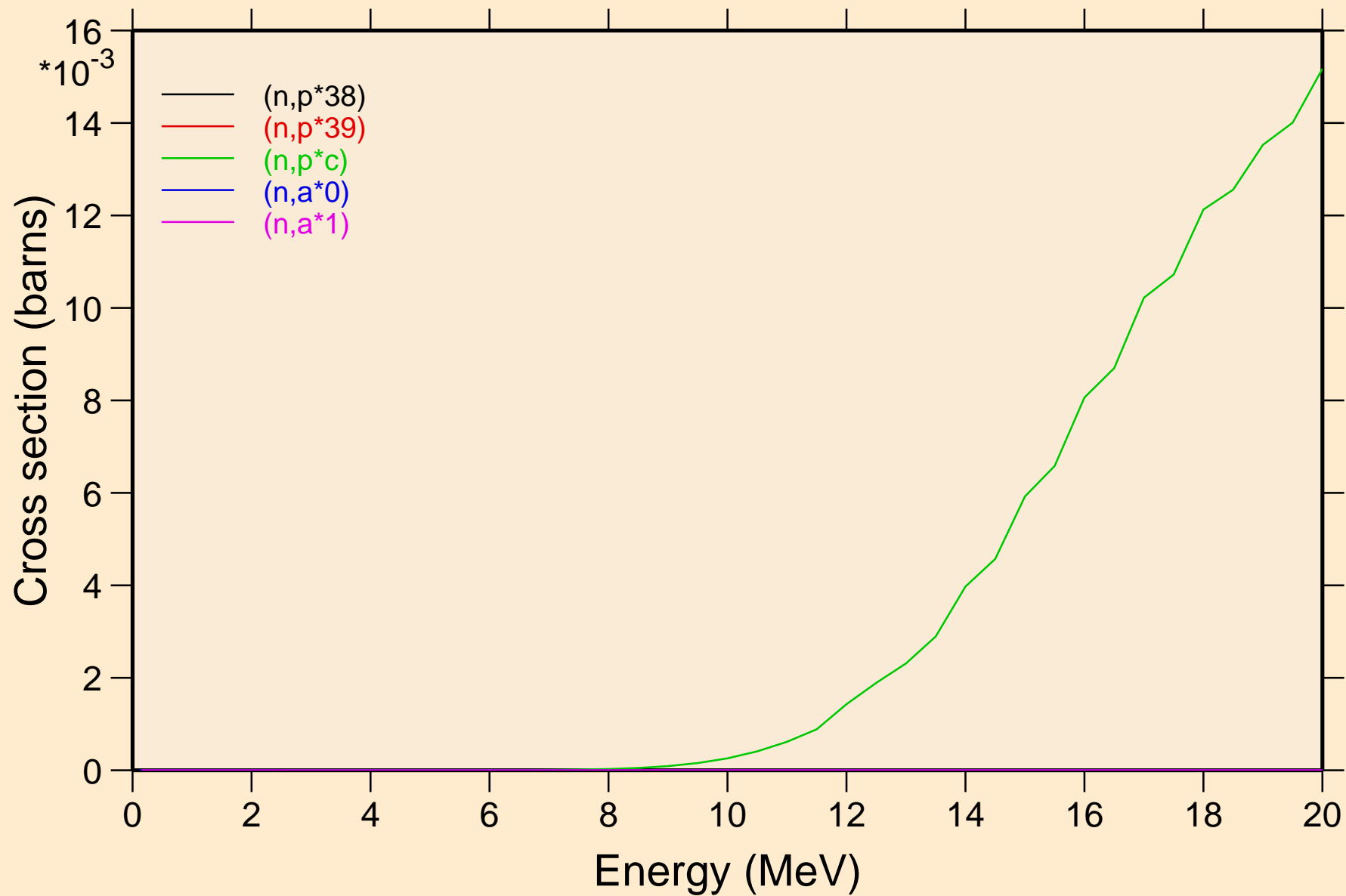

ENDF/B-VII.1 IR-191

Threshold reactions

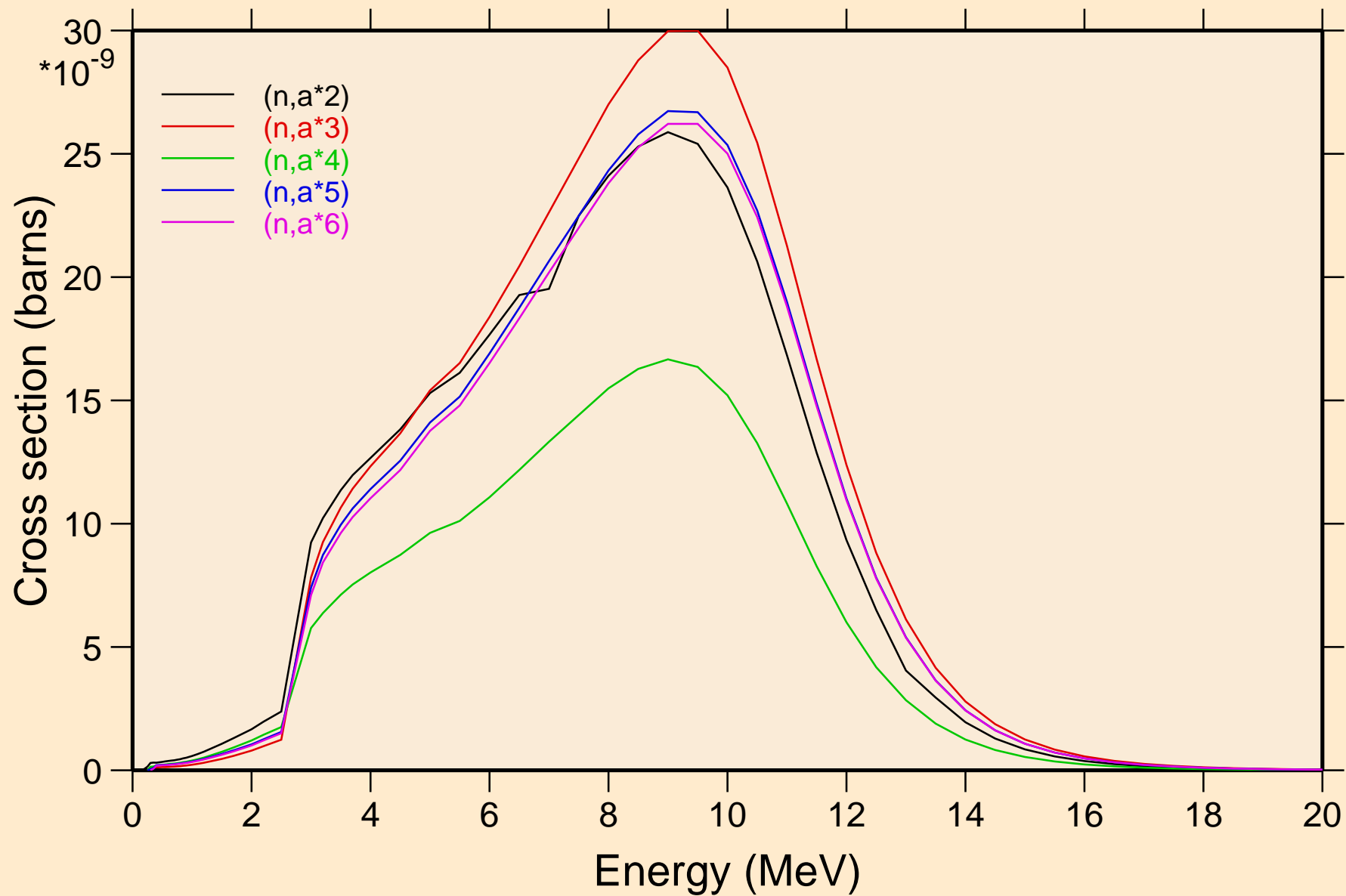

ENDF/B-VII.1 IR-191

Threshold reactions

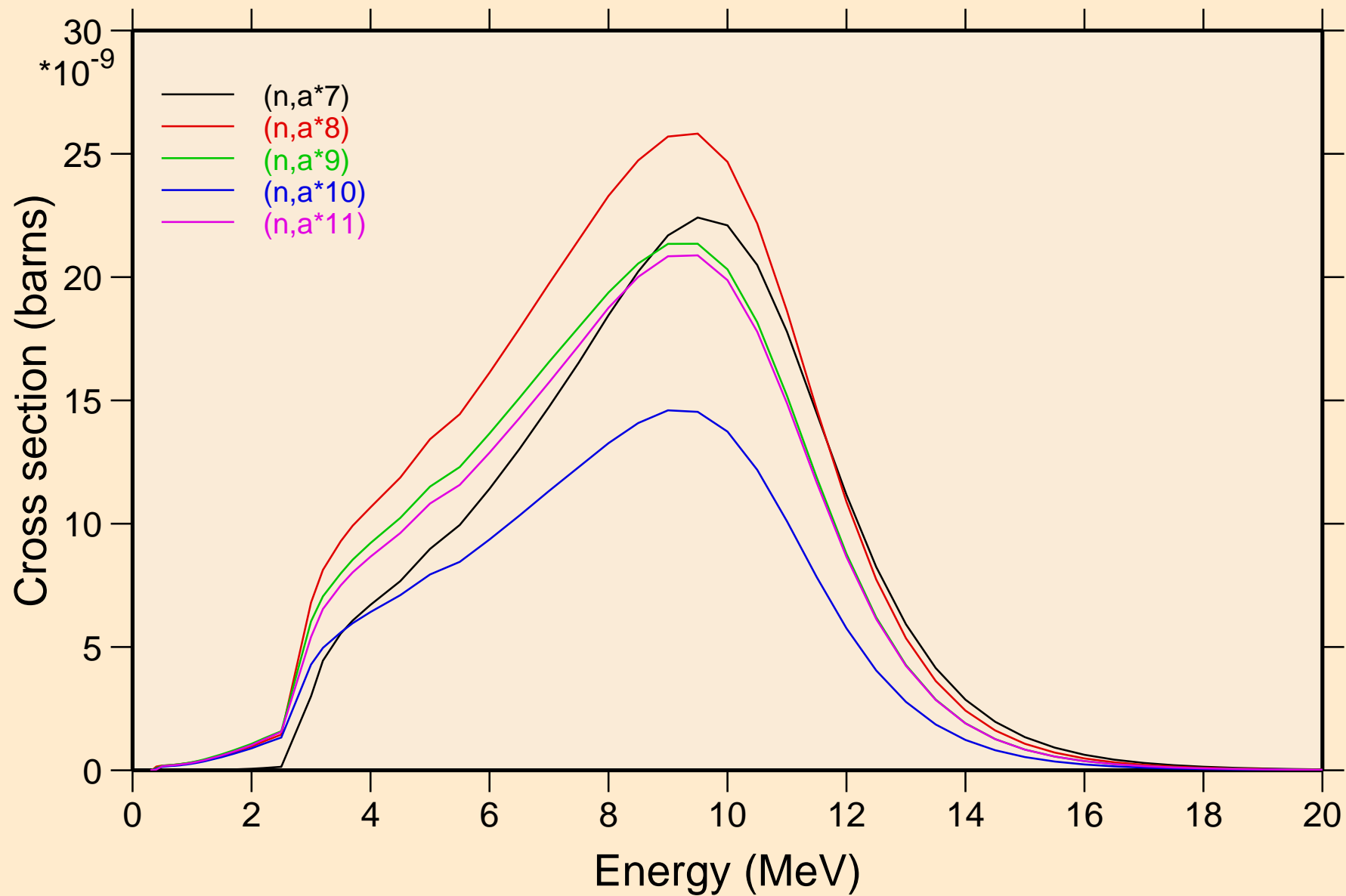

ENDF/B-VII.1 IR-191

Threshold reactions

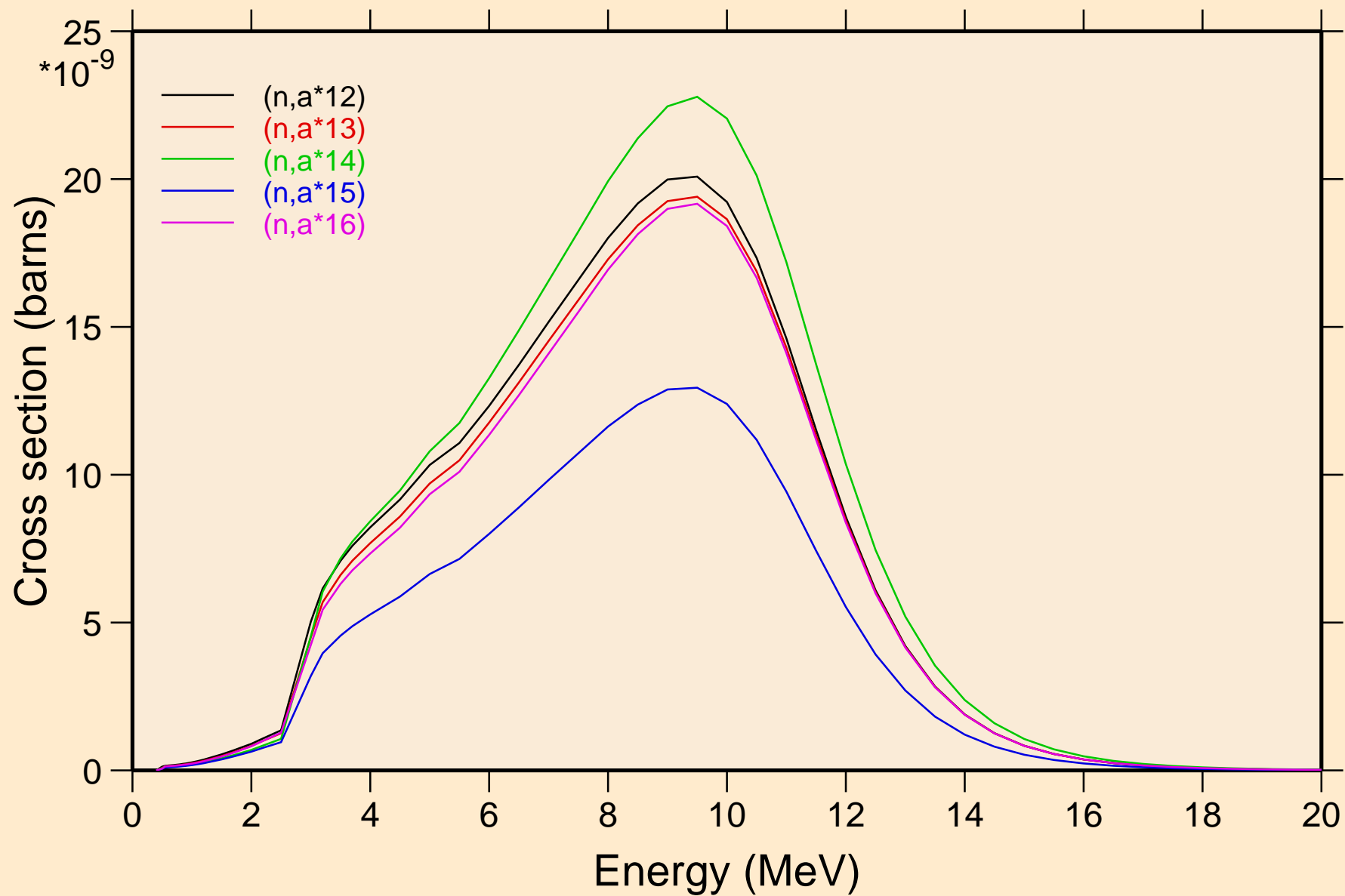

ENDF/B-VII.1 IR-191

Threshold reactions

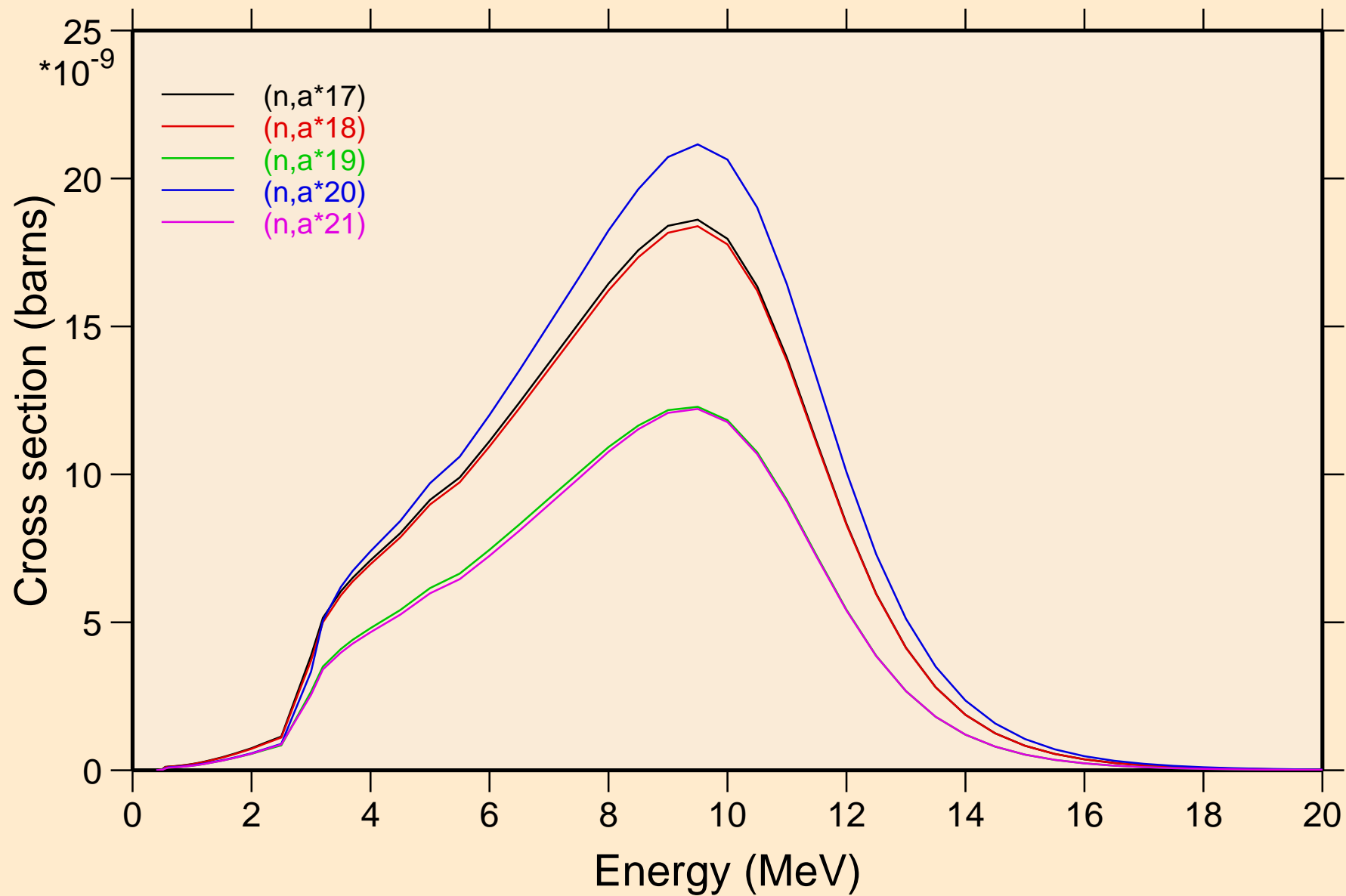

ENDF/B-VII.1 IR-191

Threshold reactions

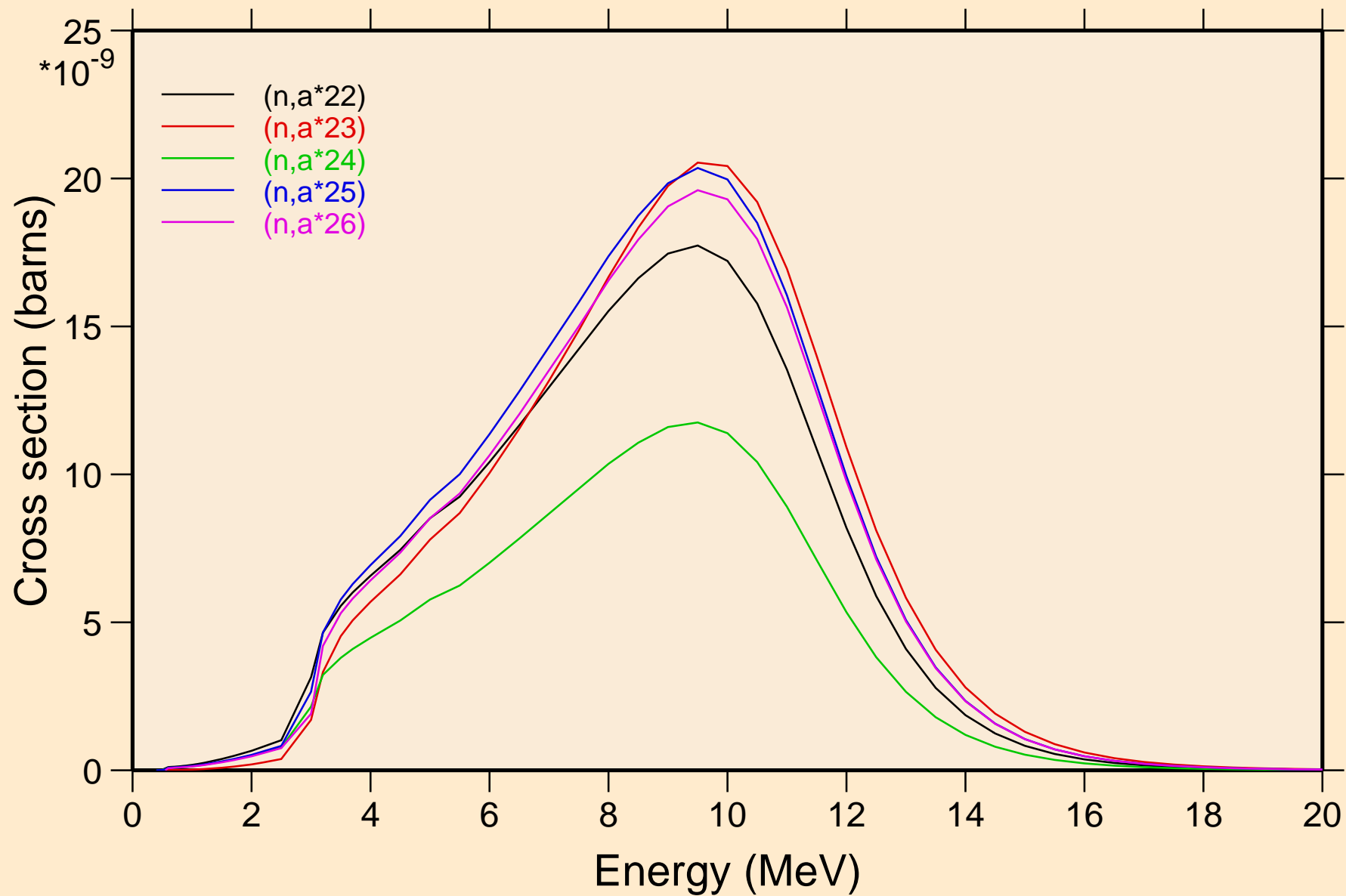

ENDF/B-VII.1 IR-191

Threshold reactions

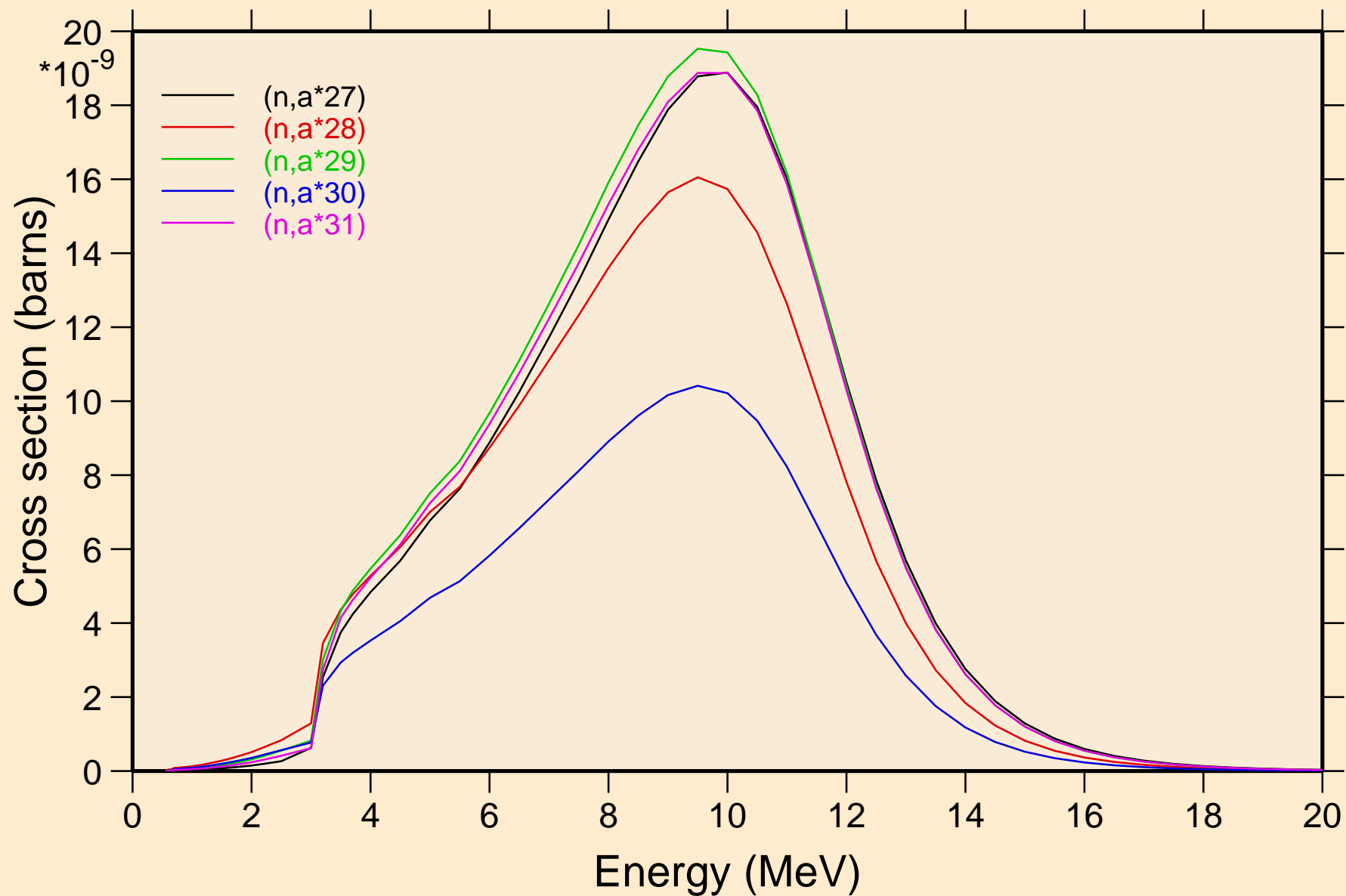

ENDF/B-VII.1 IR-191

Threshold reactions

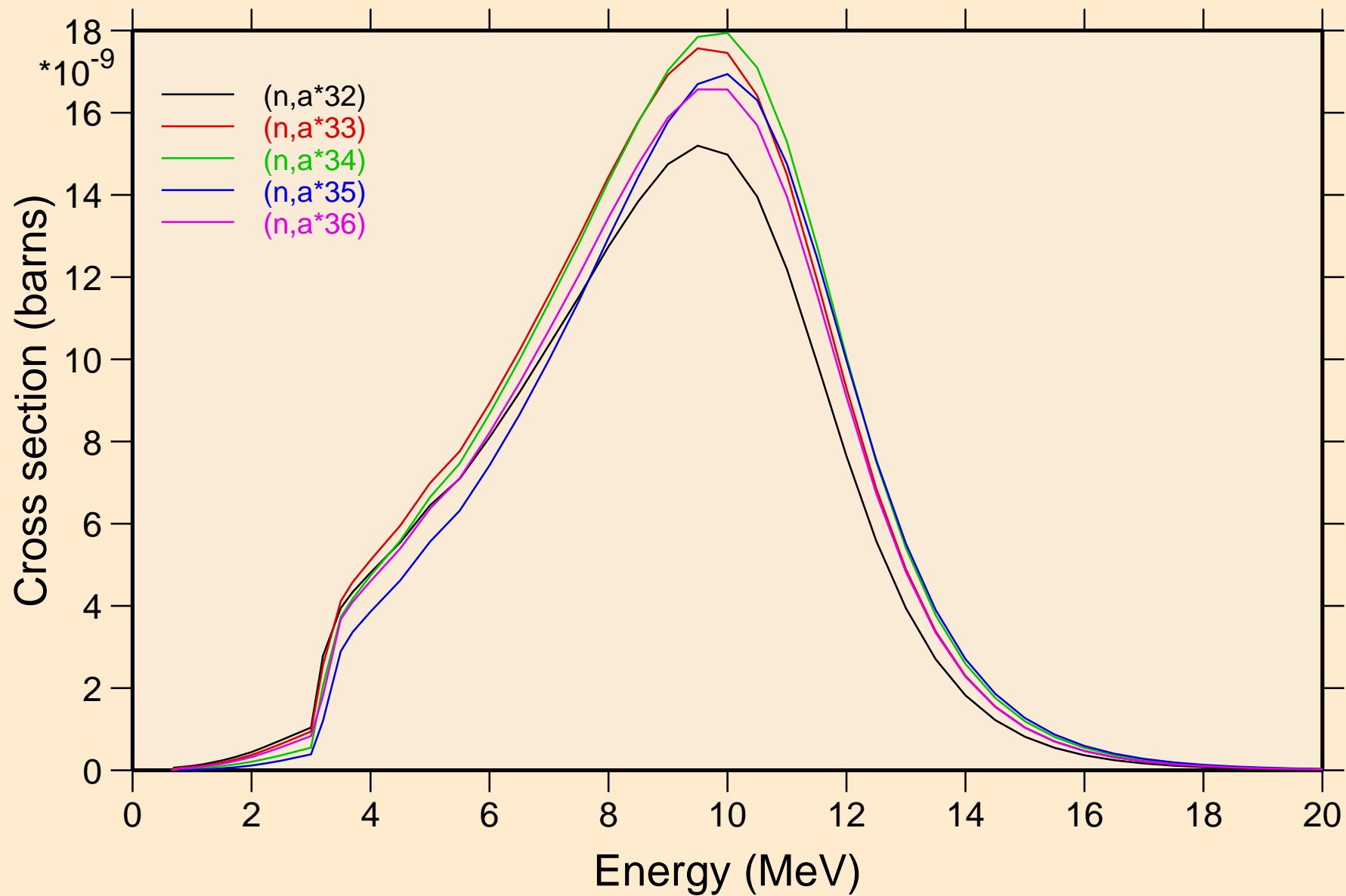

ENDF/B-VII.1 IR-191

Threshold reactions

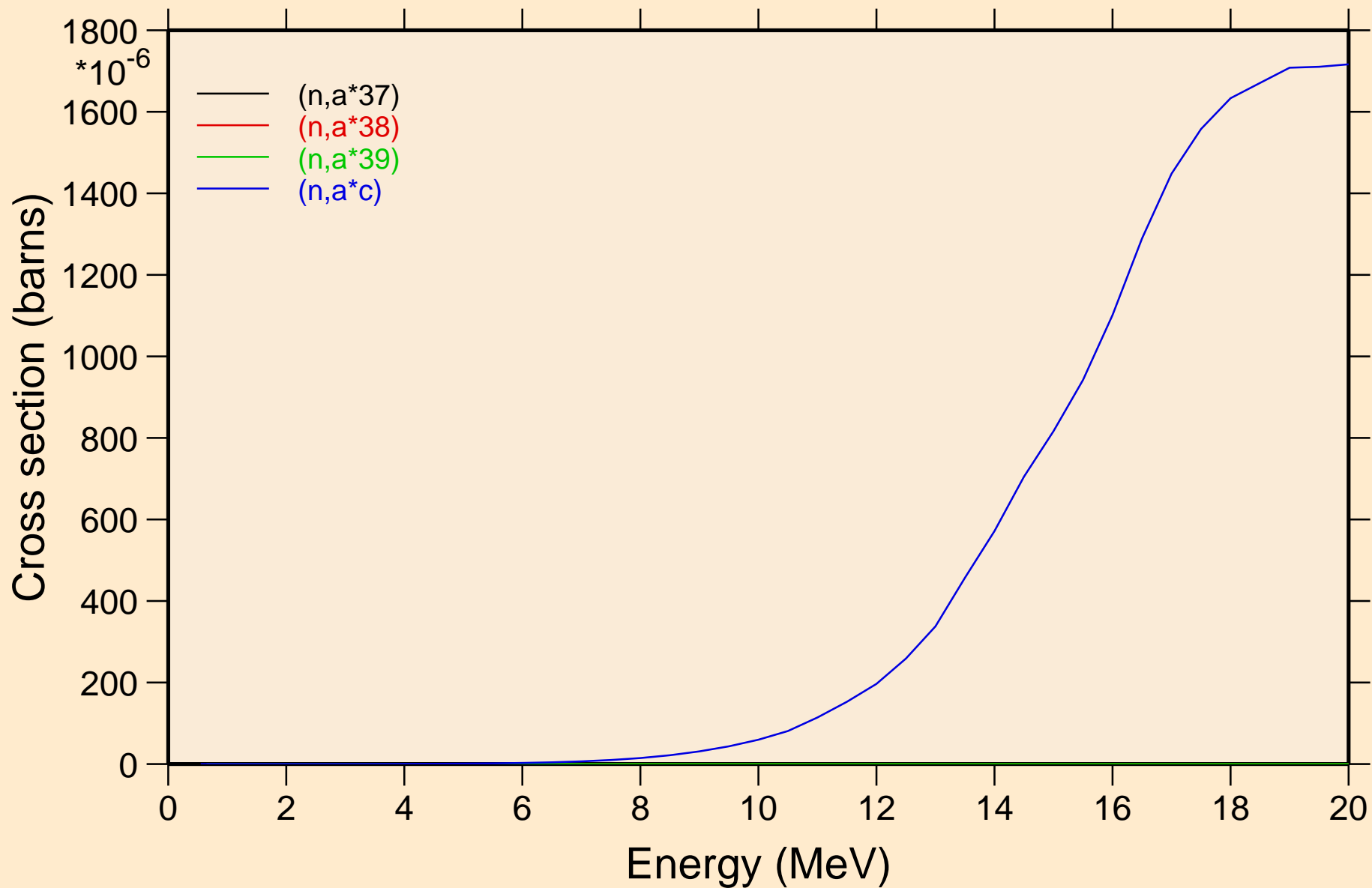

ENDF/B-VII.1 IR-191
angular distribution for elastic

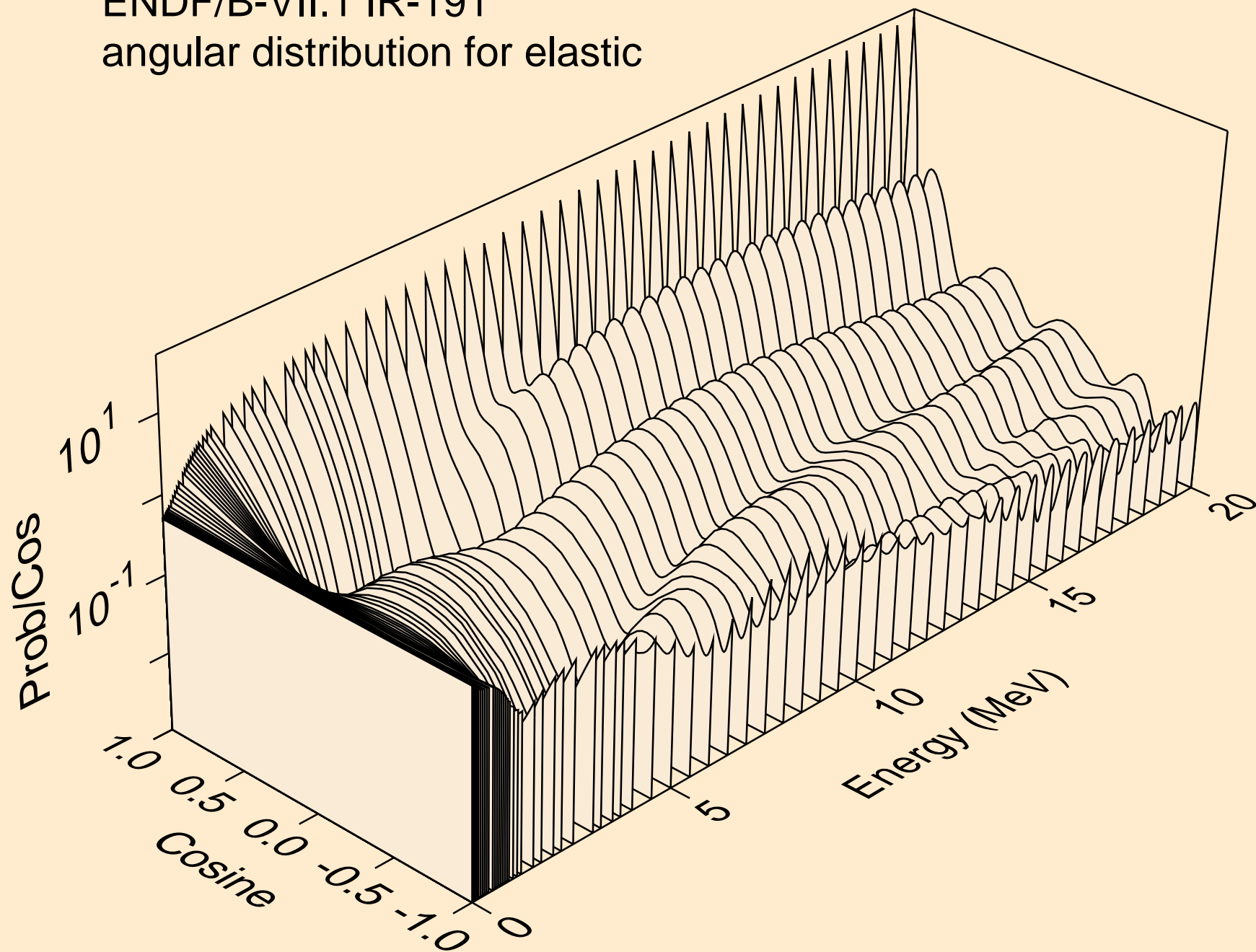

ENDF/B-VII.1 IR-191
angular distribution for (n,n*1)

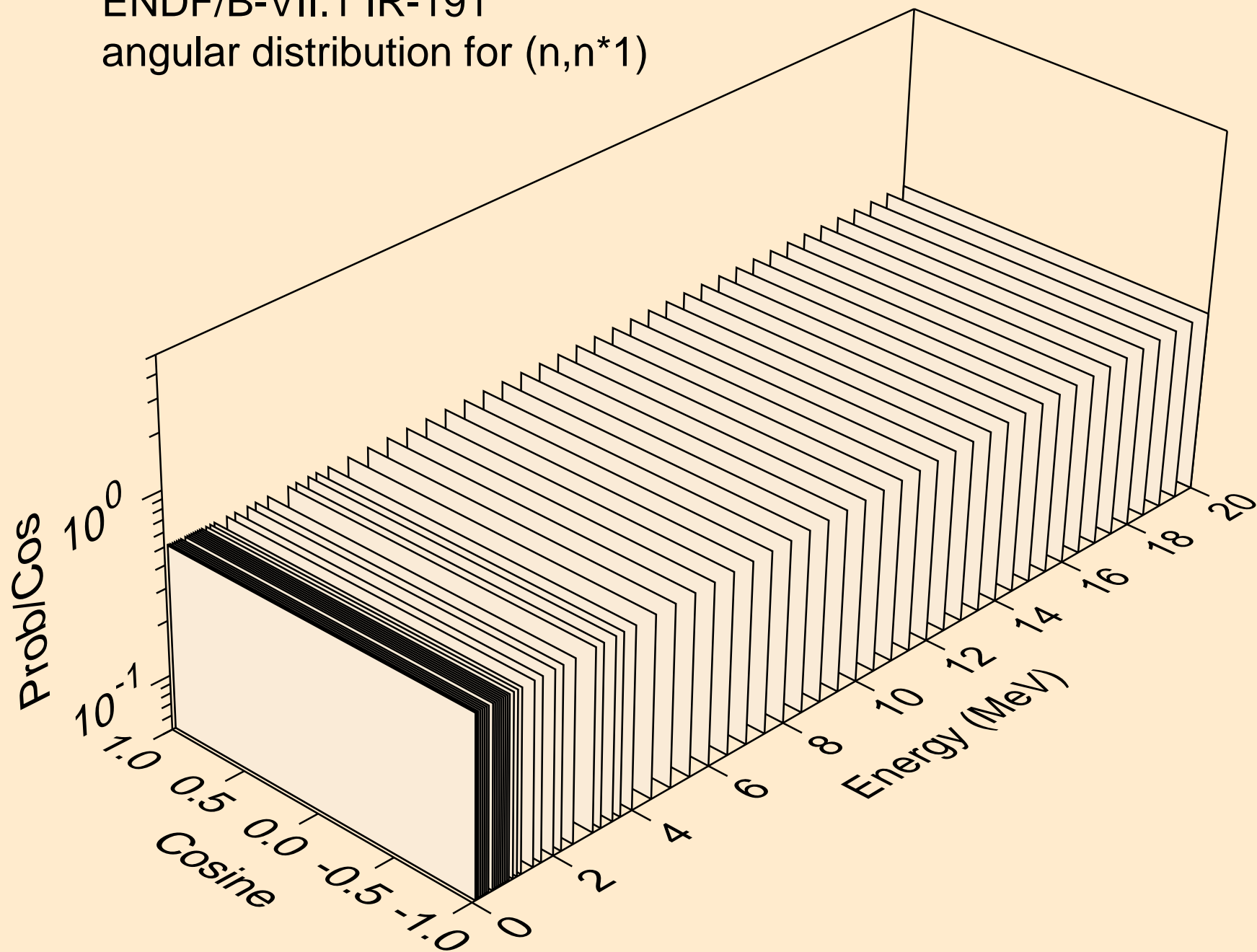

ENDF/B-VII.1 IR-191
angular distribution for (n,n*2)

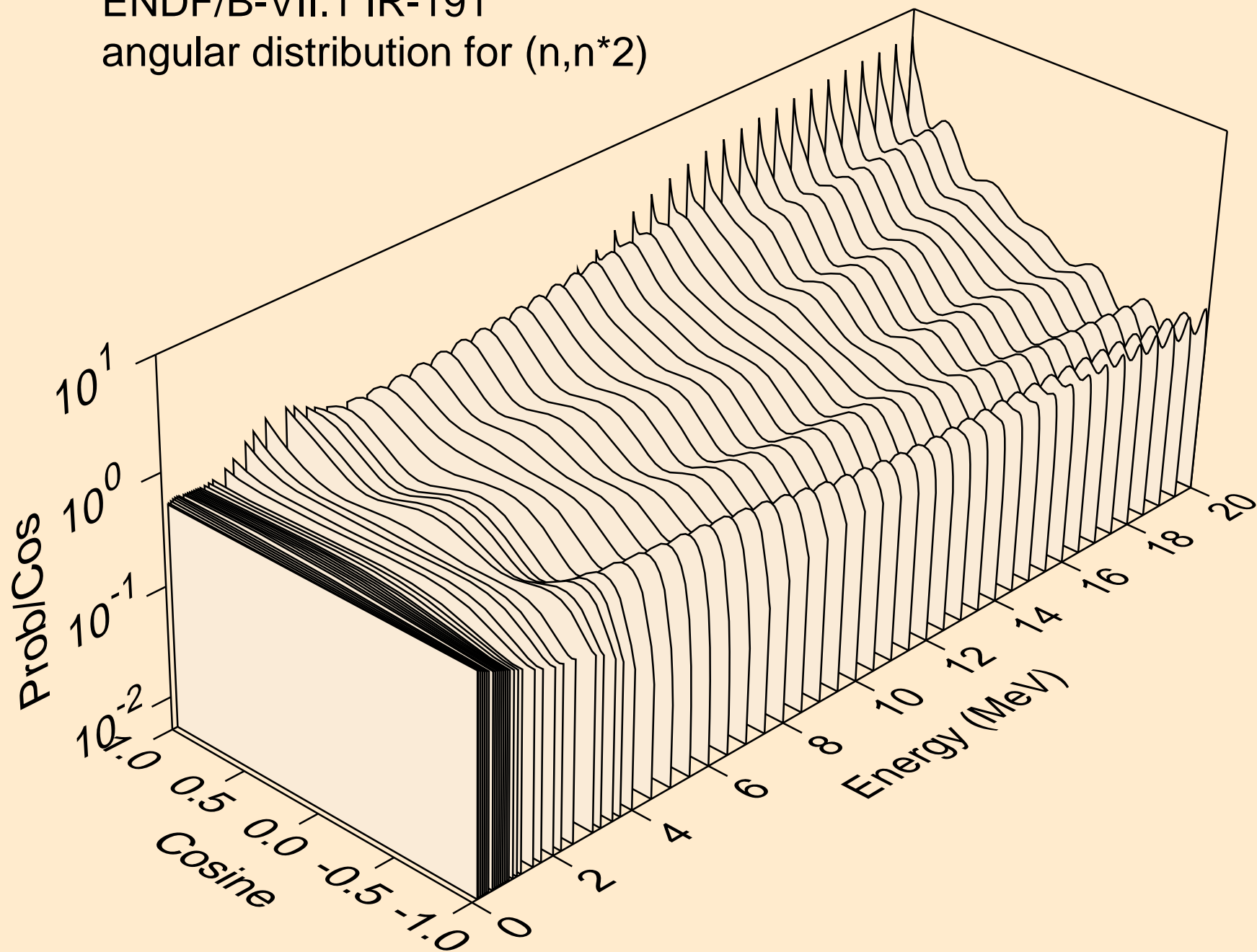

ENDF/B-VII.1 IR-191
angular distribution for (n,n*3)

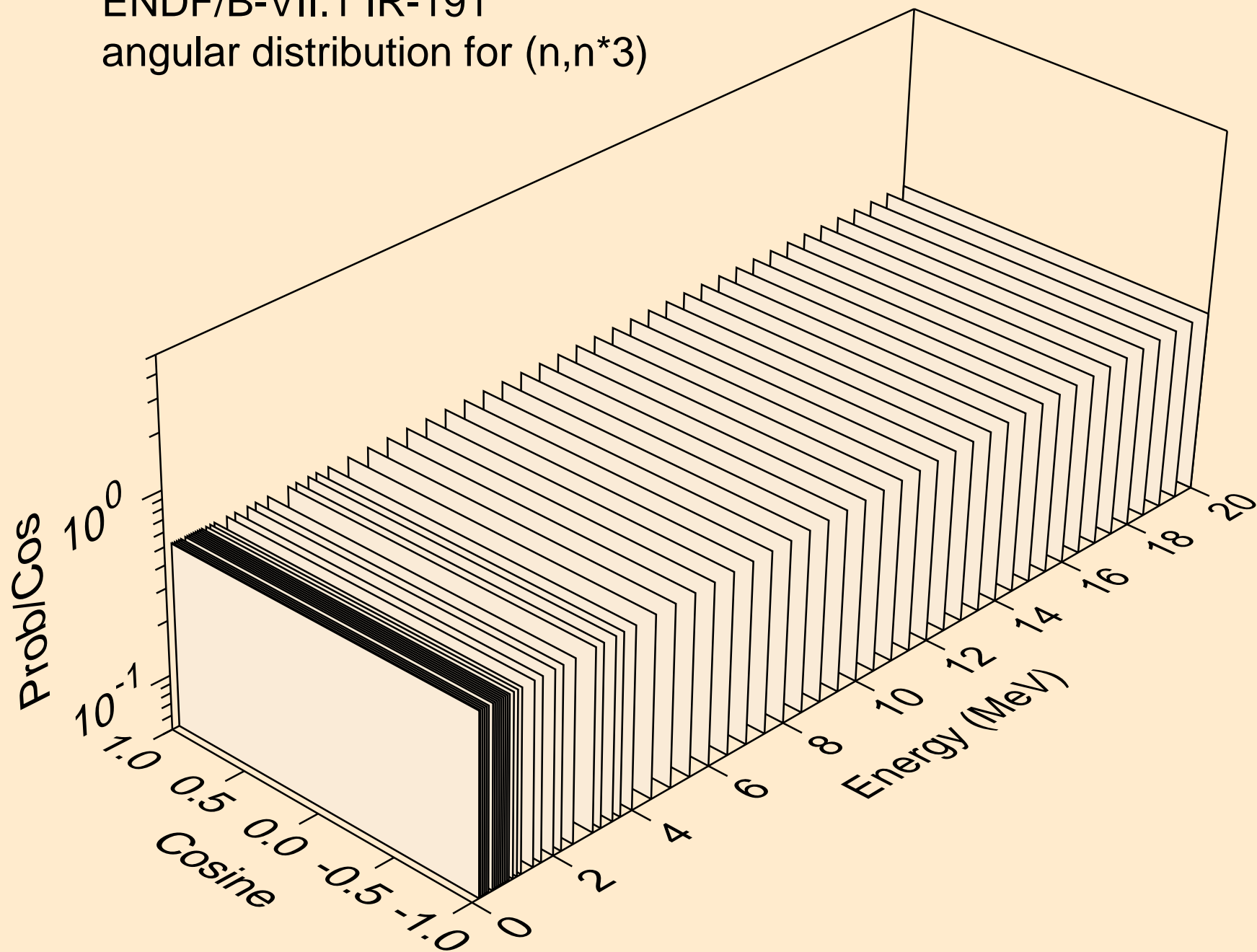

ENDF/B-VII.1 IR-191
angular distribution for (n,n*4)

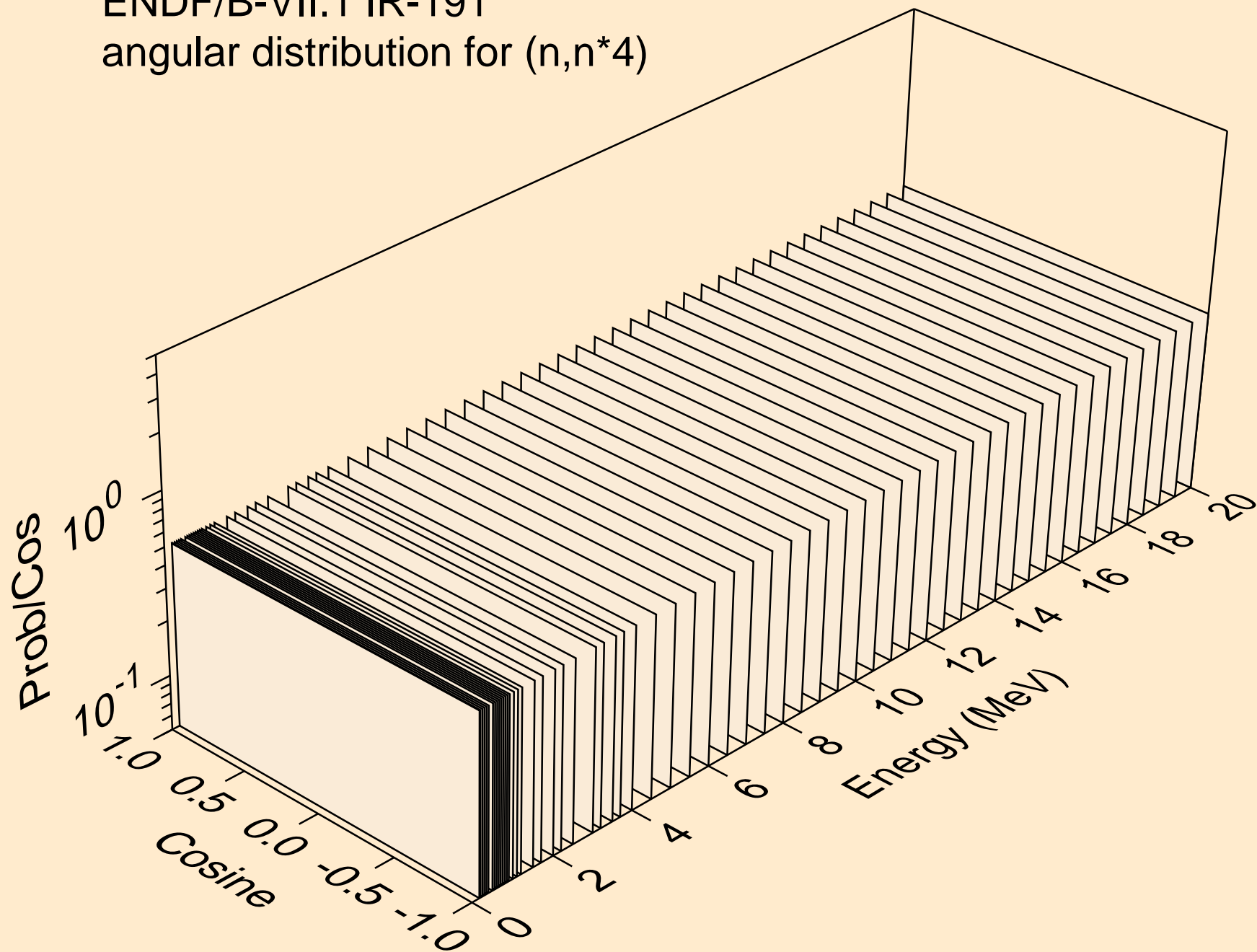

ENDF/B-VII.1 IR-191
angular distribution for (n,n*5)

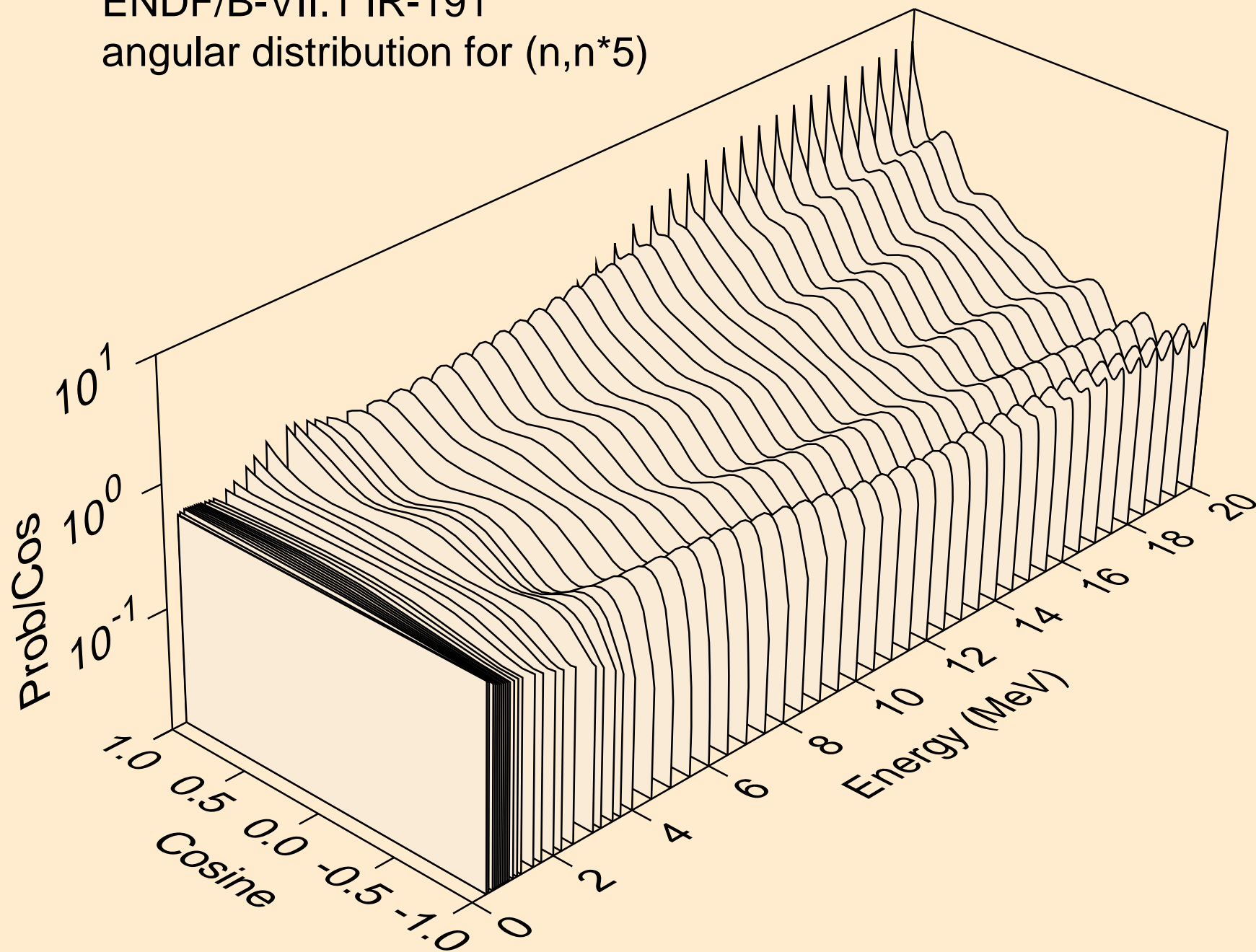

ENDF/B-VII.1 IR-191
angular distribution for (n,n*6)

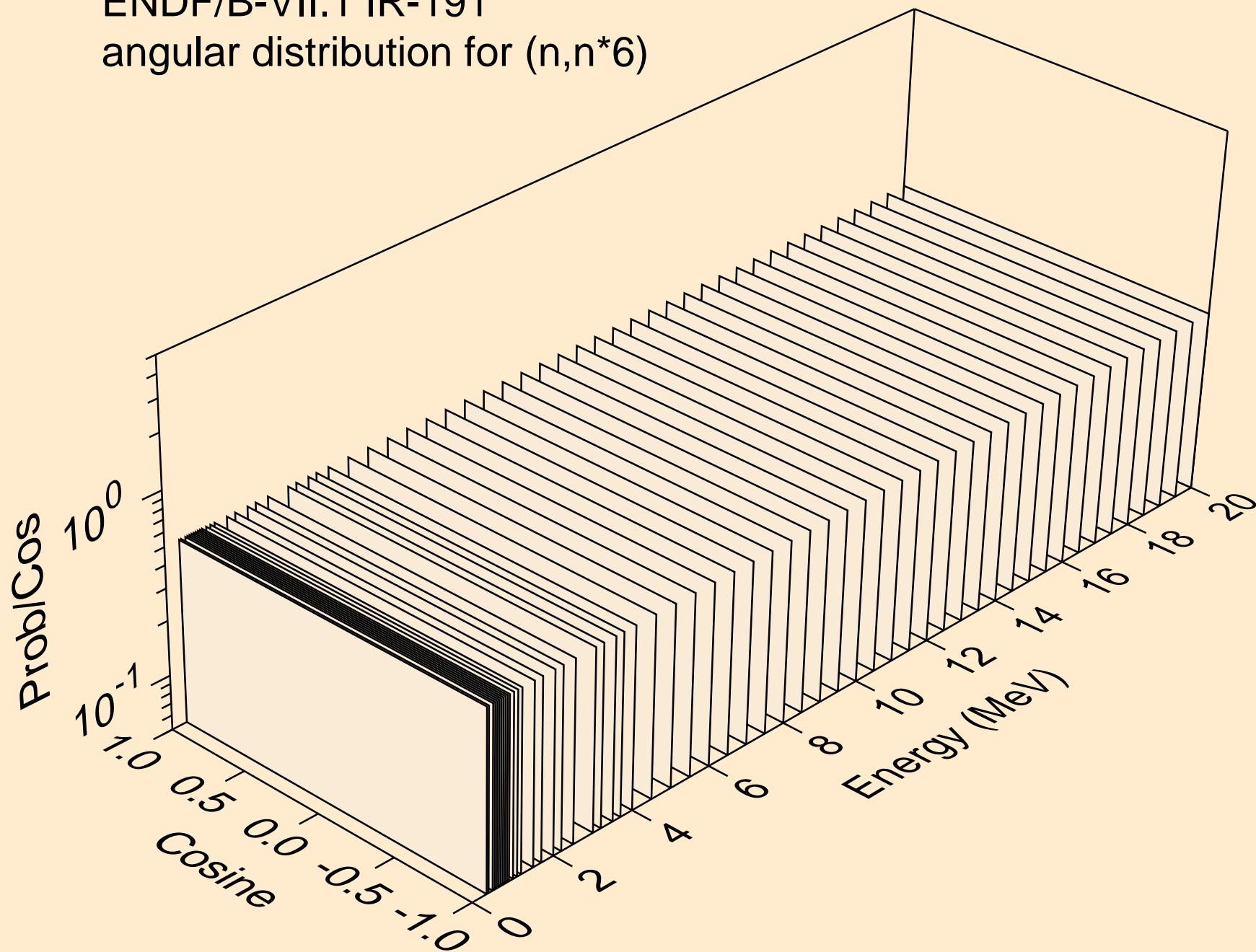

ENDF/B-VII.1 IR-191
angular distribution for (n,n*7)

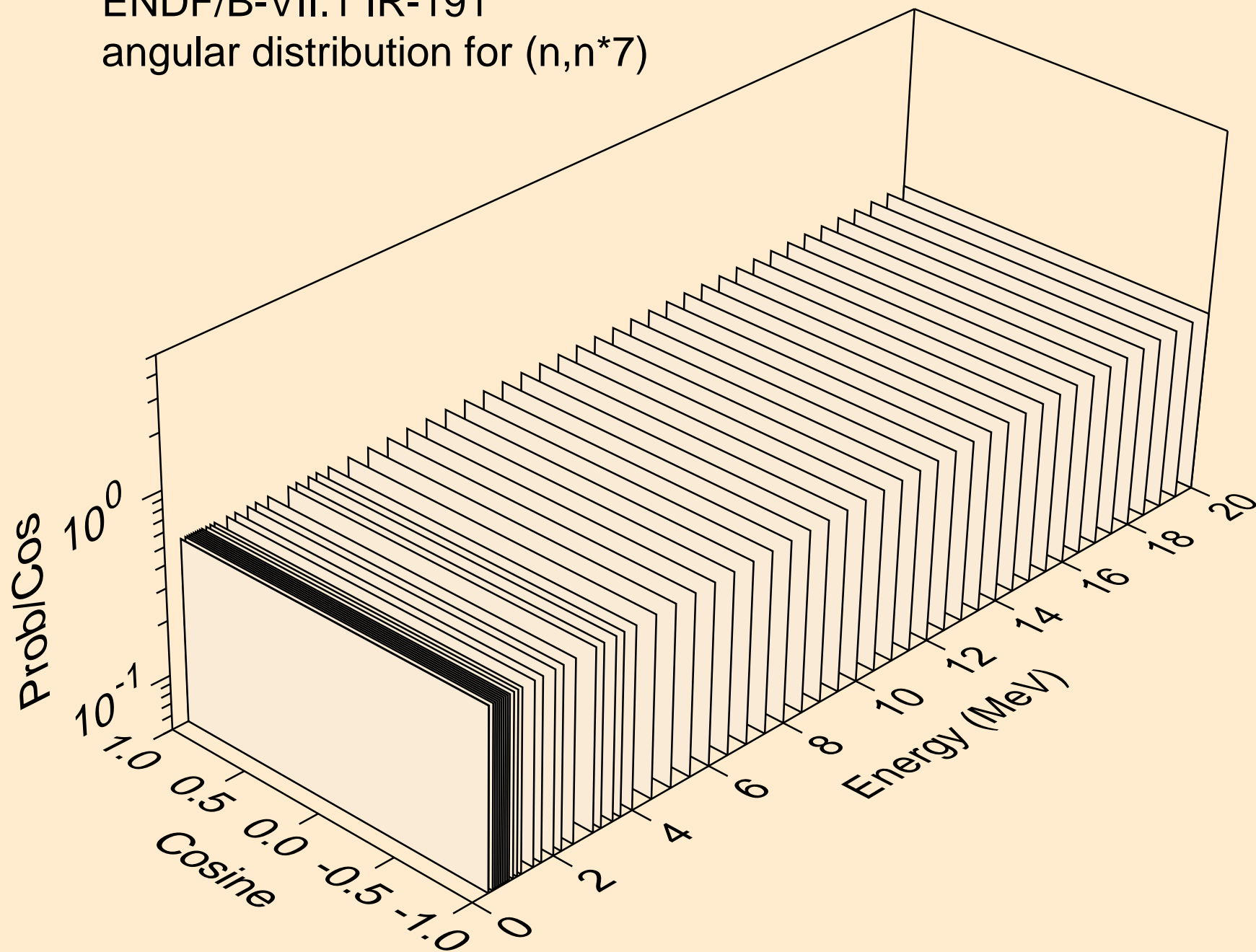

ENDF/B-VII.1 IR-191
angular distribution for (n,n*8)

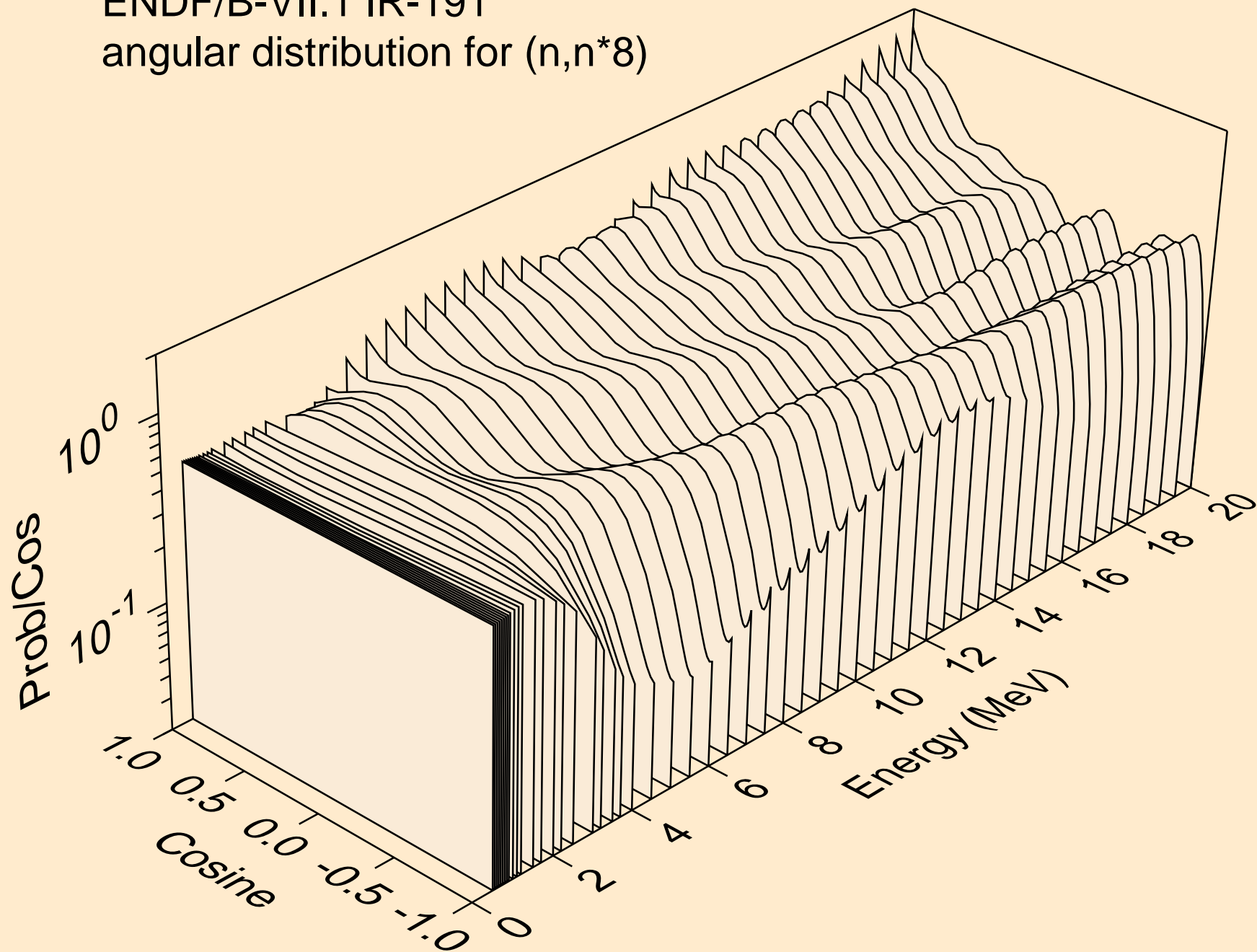

ENDF/B-VII.1 IR-191
angular distribution for (n,n*9)

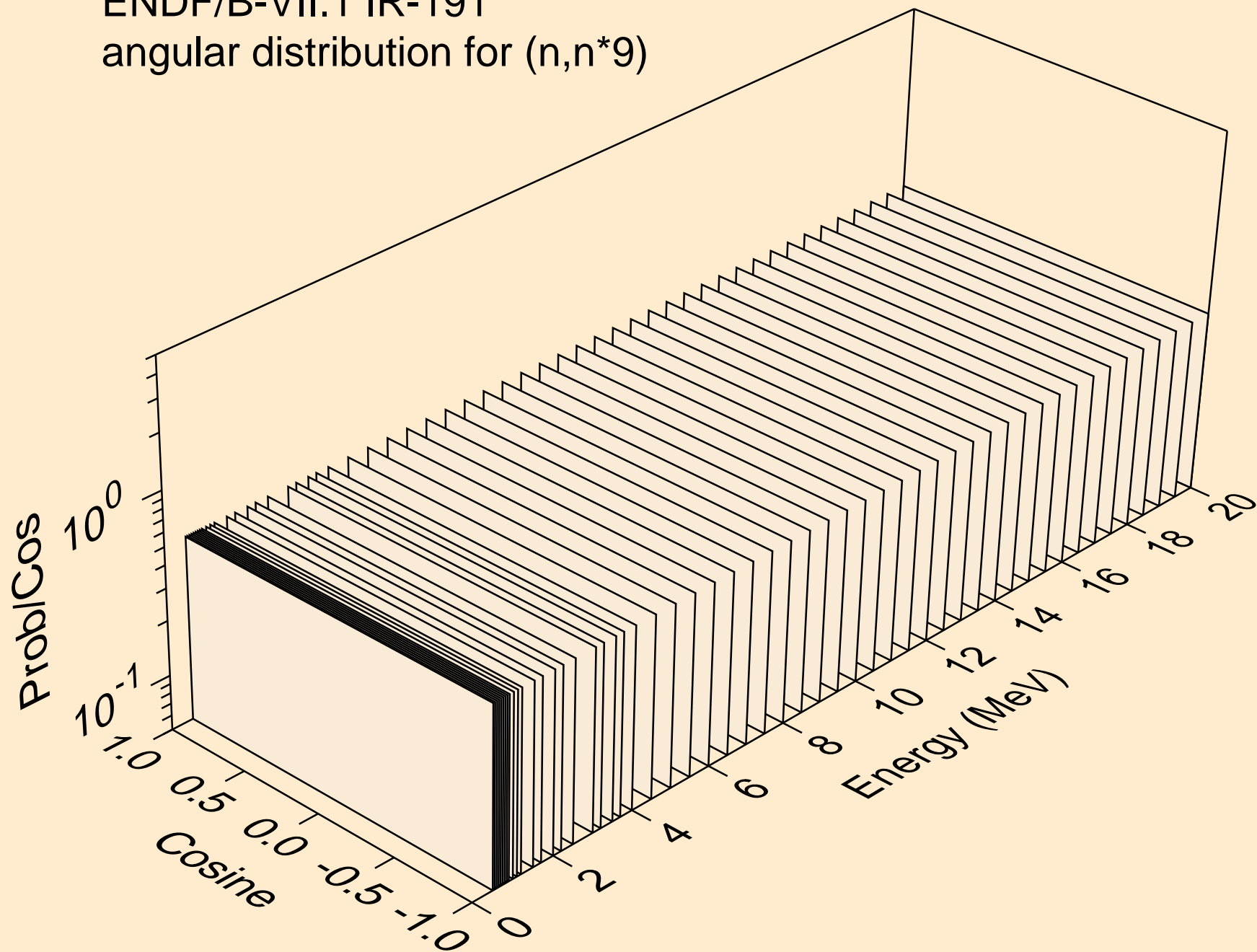

ENDF/B-VII.1 IR-191
angular distribution for (n,n*10)

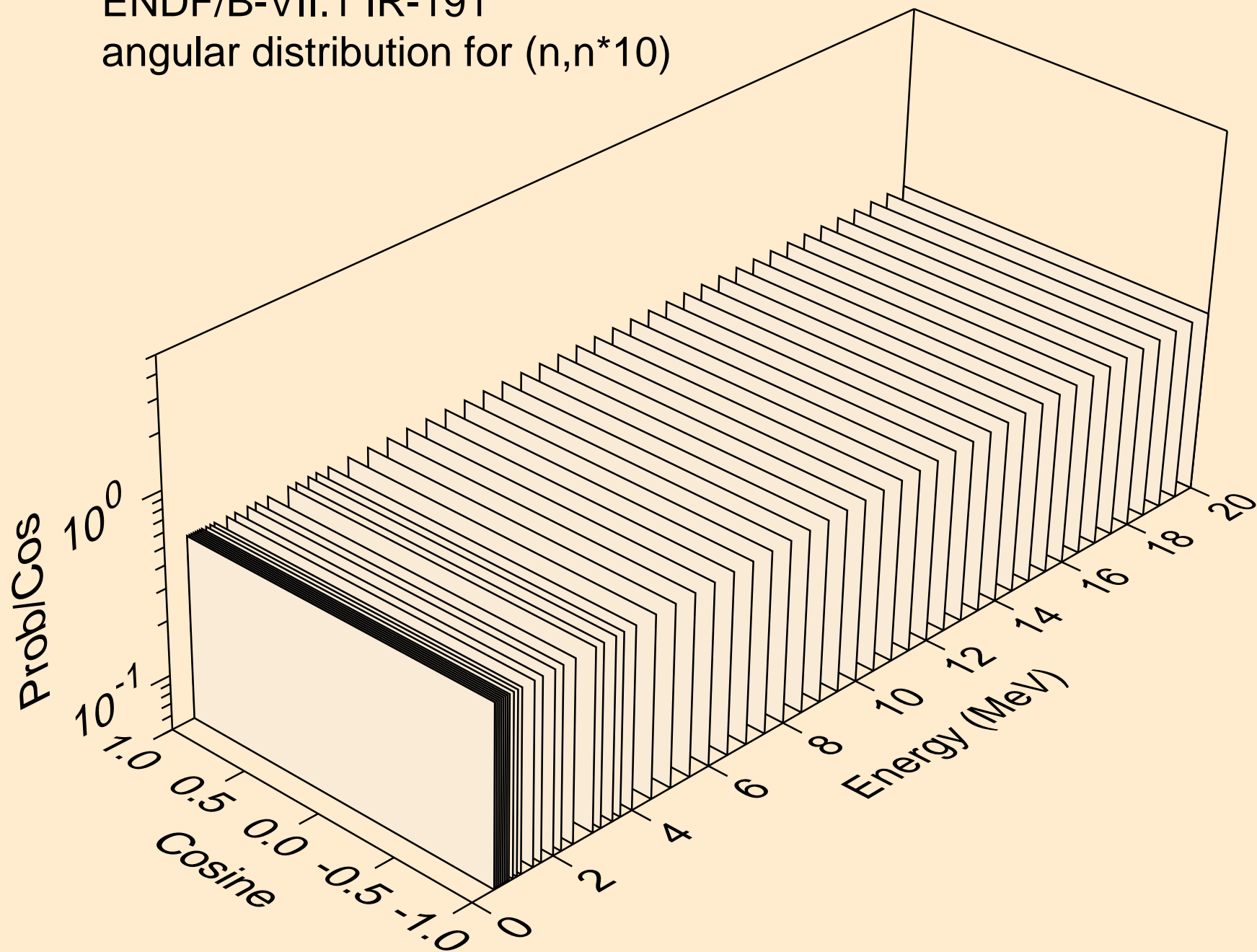

ENDF/B-VII.1 IR-191
angular distribution for (n,n*11)

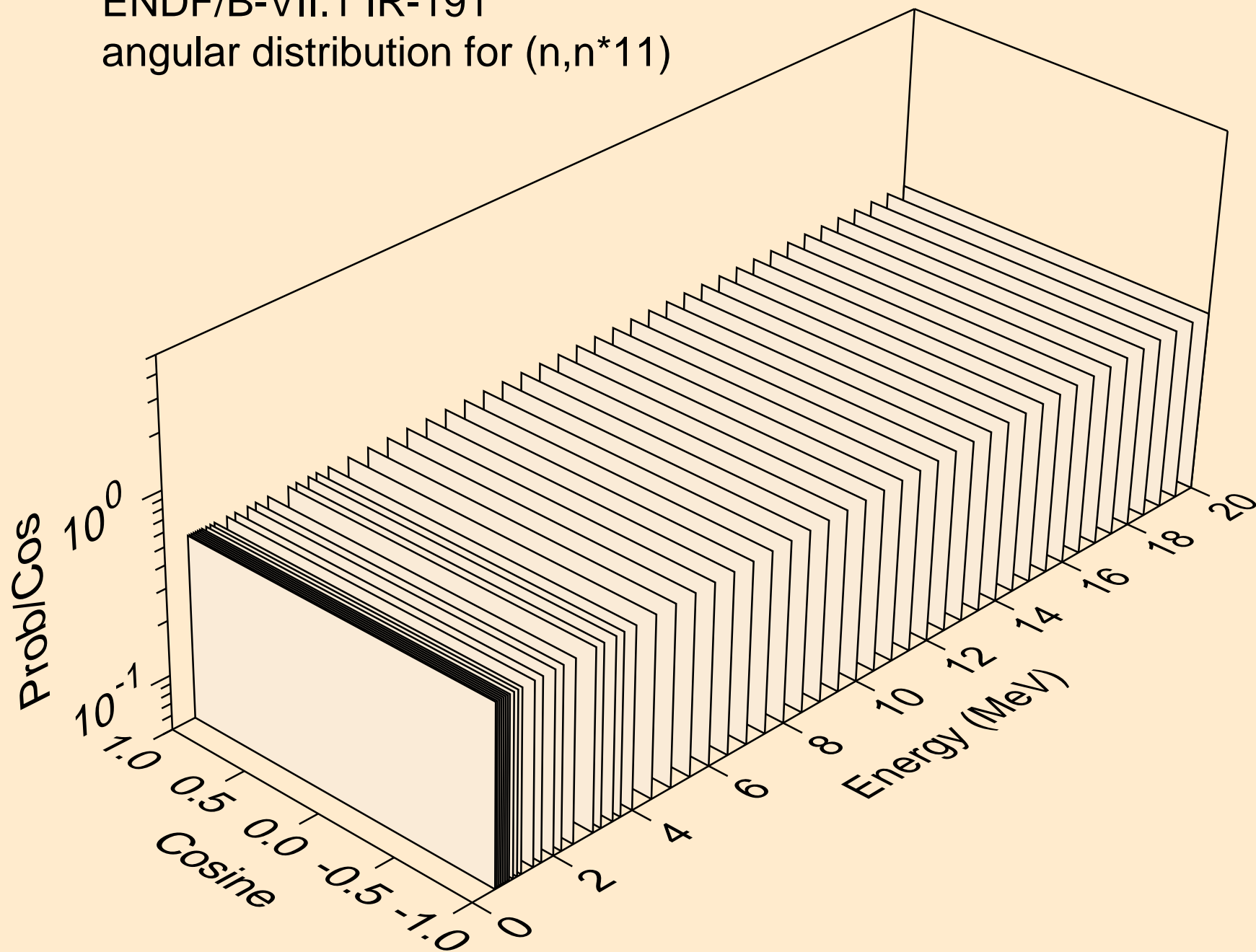

ENDF/B-VII.1 IR-191
angular distribution for (n,n*12)

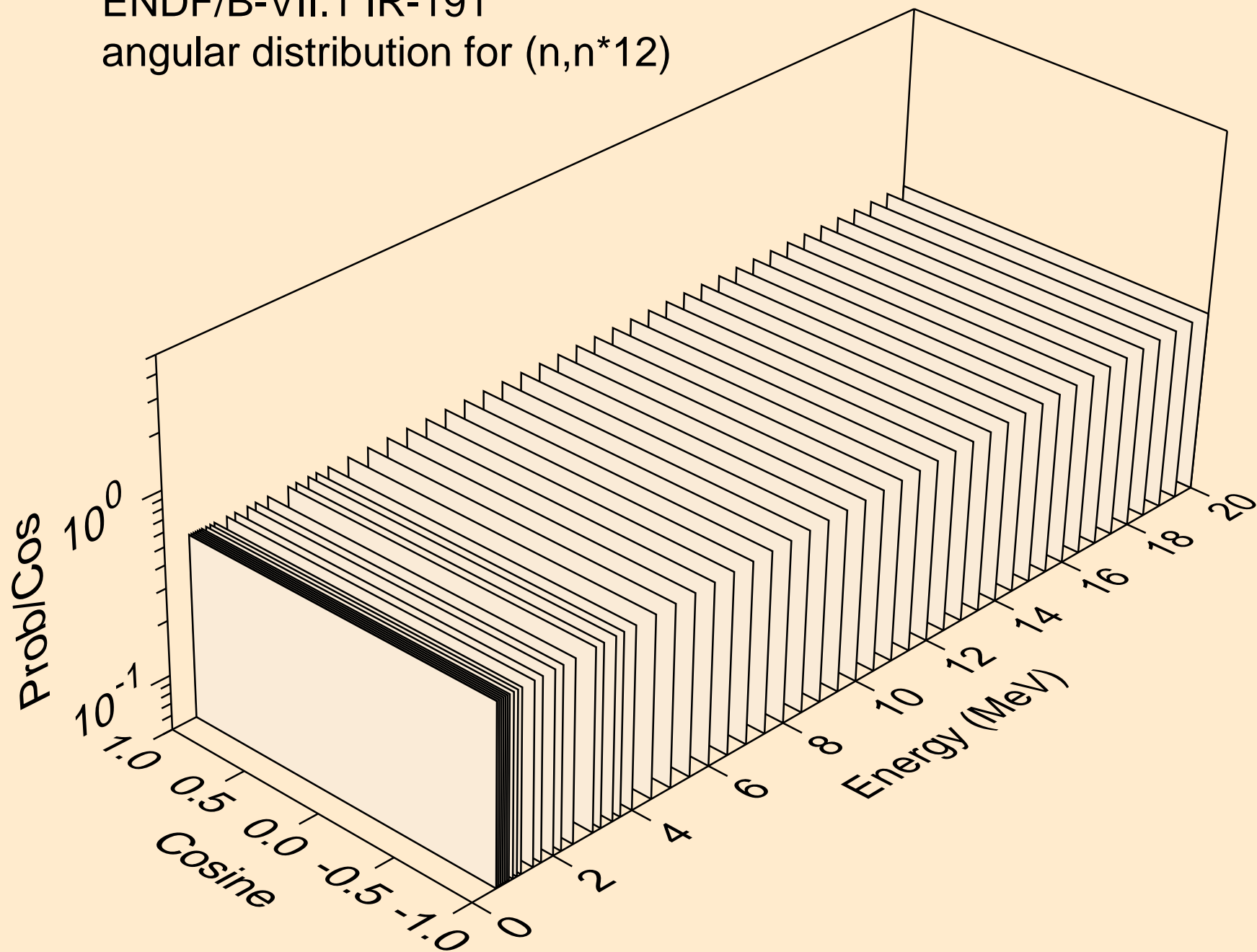

ENDF/B-VII.1 IR-191
angular distribution for (n,n*13)

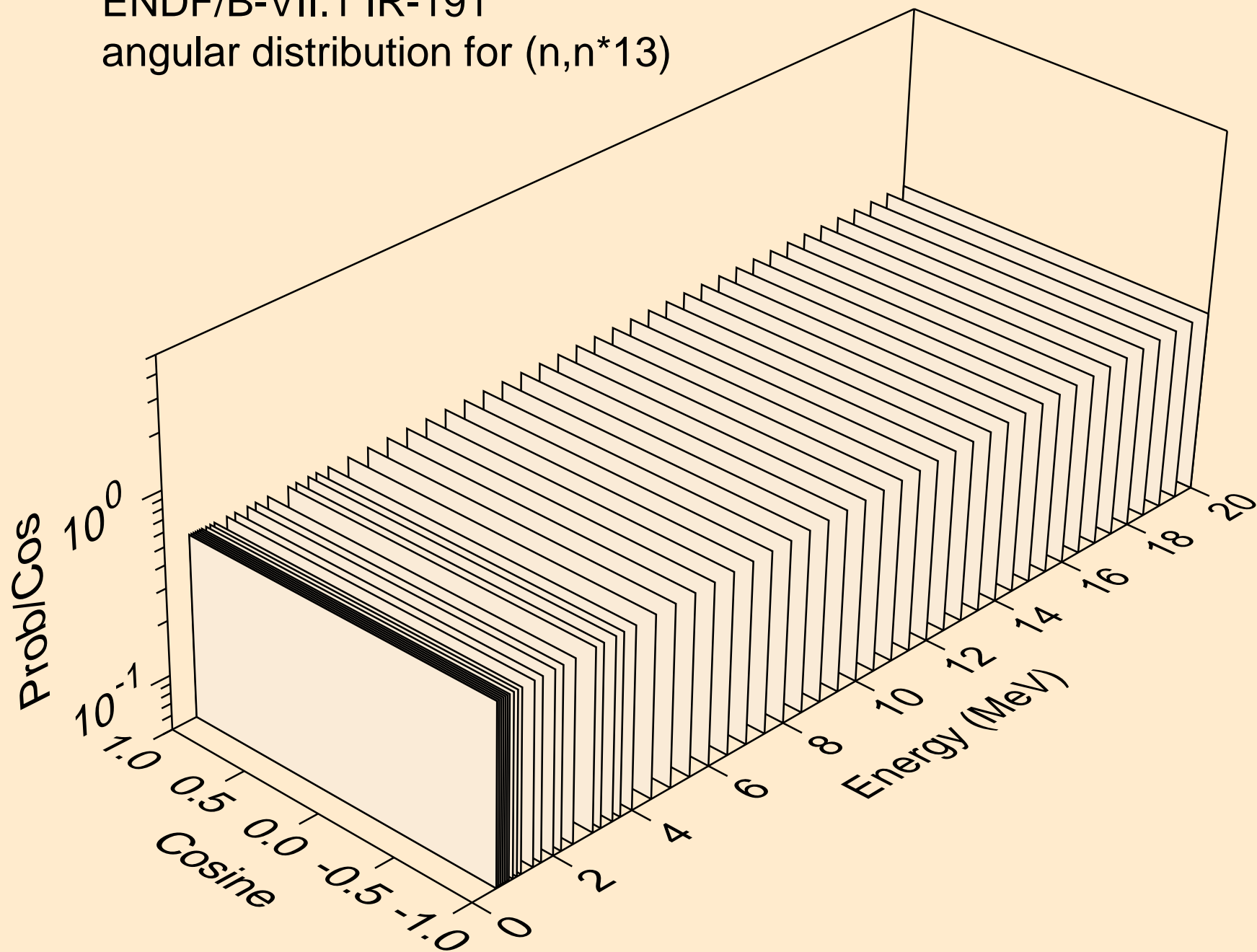

ENDF/B-VII.1 IR-191
angular distribution for (n,n*14)

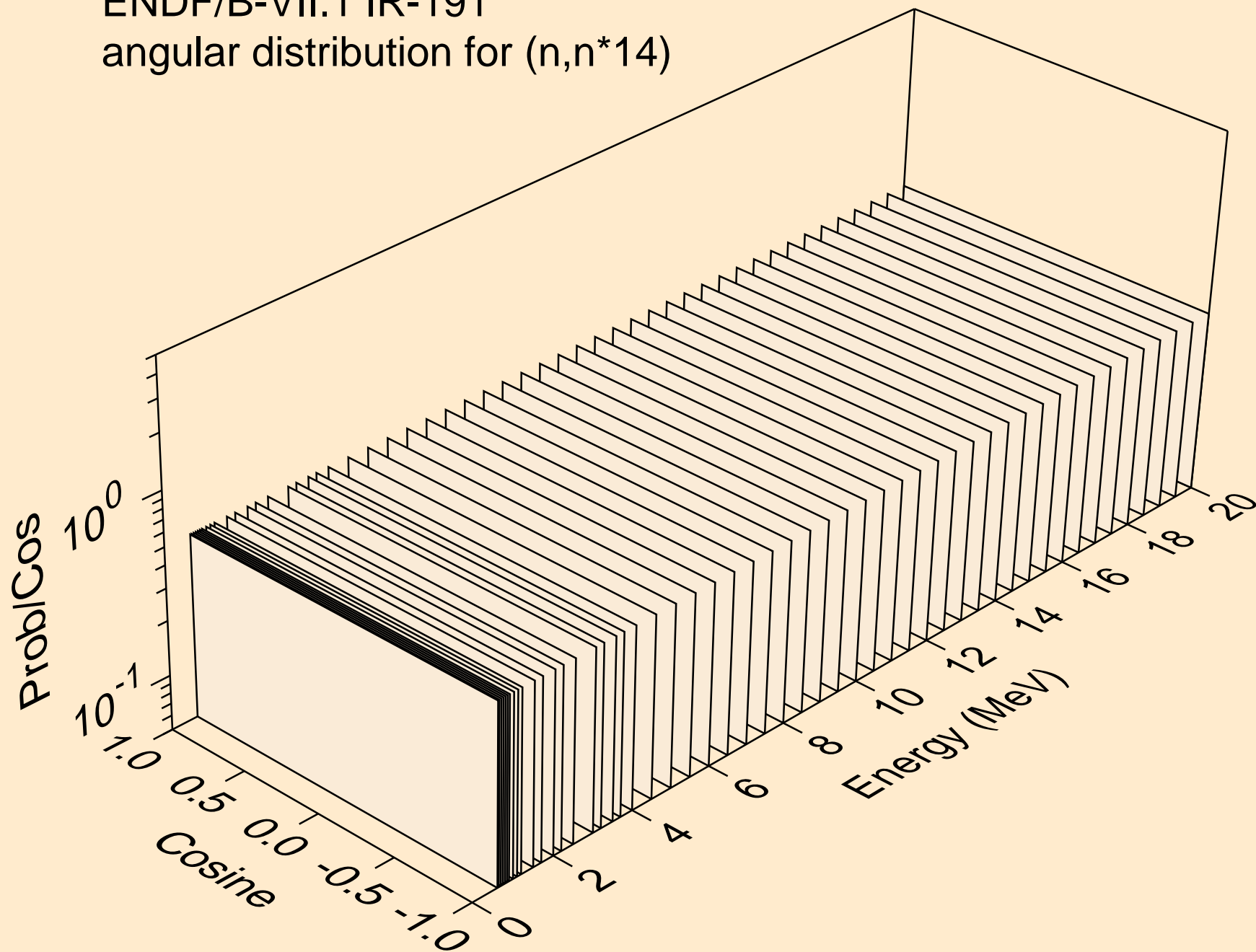

ENDF/B-VII.1 IR-191
angular distribution for (n,n*15)

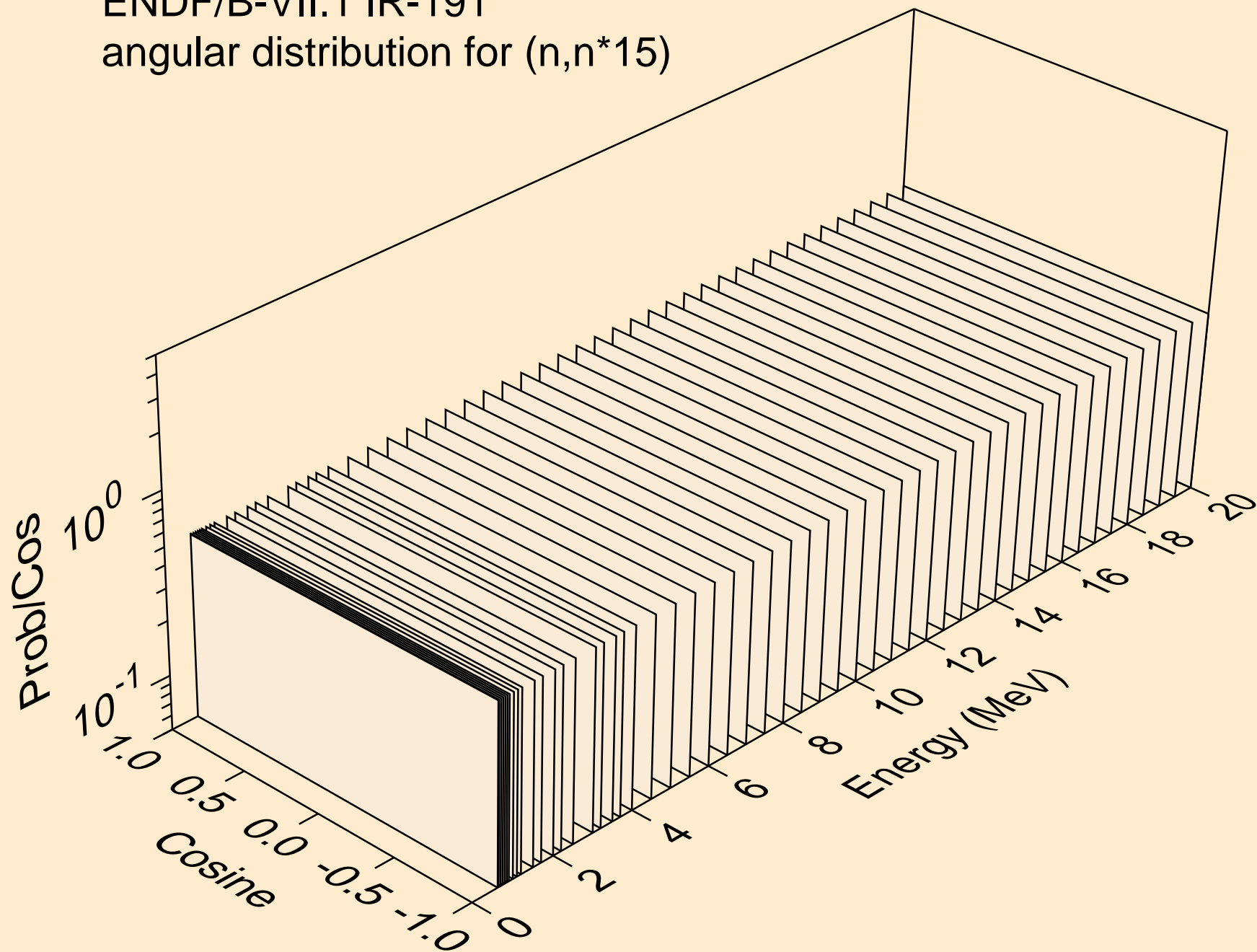

ENDF/B-VII.1 IR-191
angular distribution for (n,n*16)

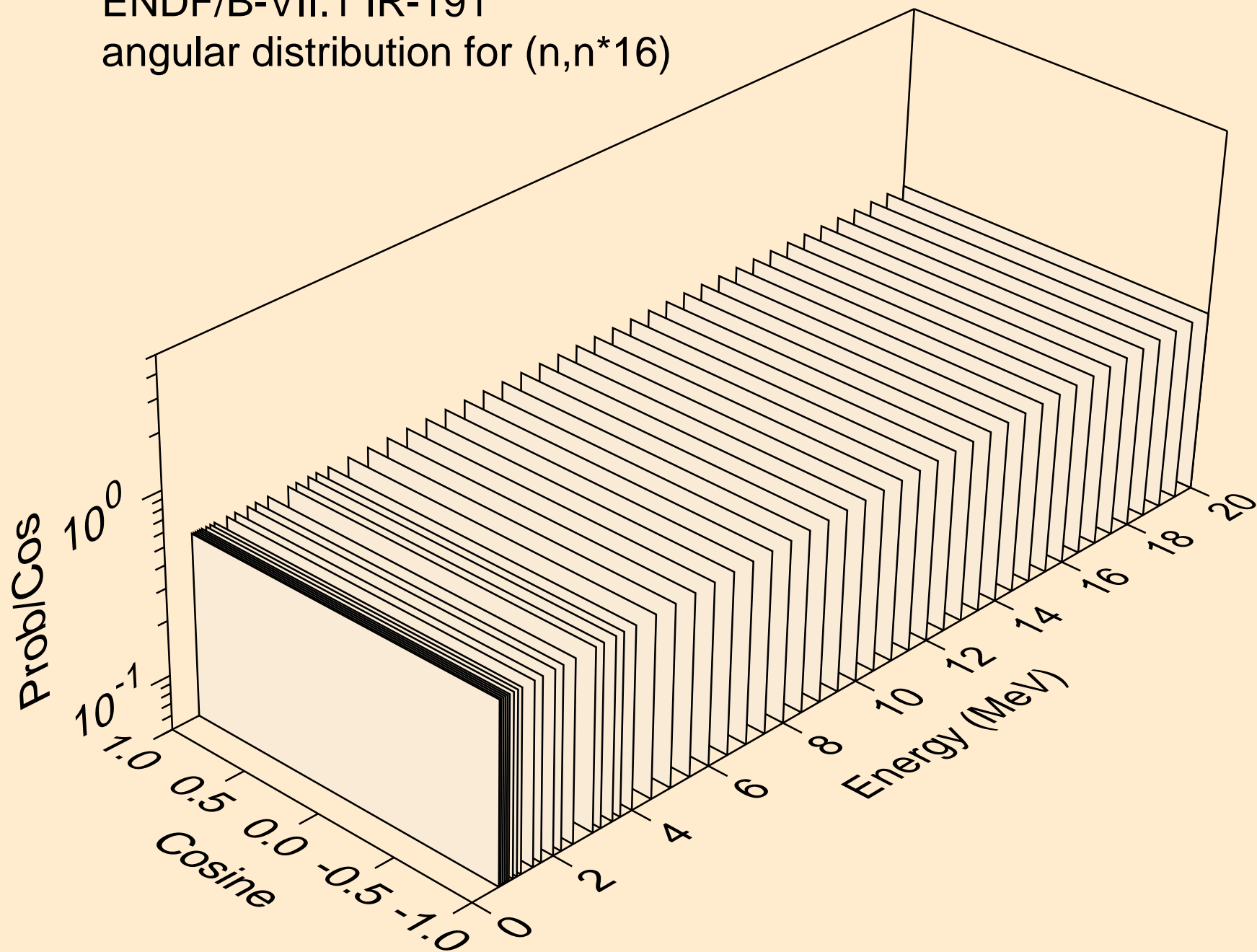

ENDF/B-VII.1 IR-191
angular distribution for (n,n*17)

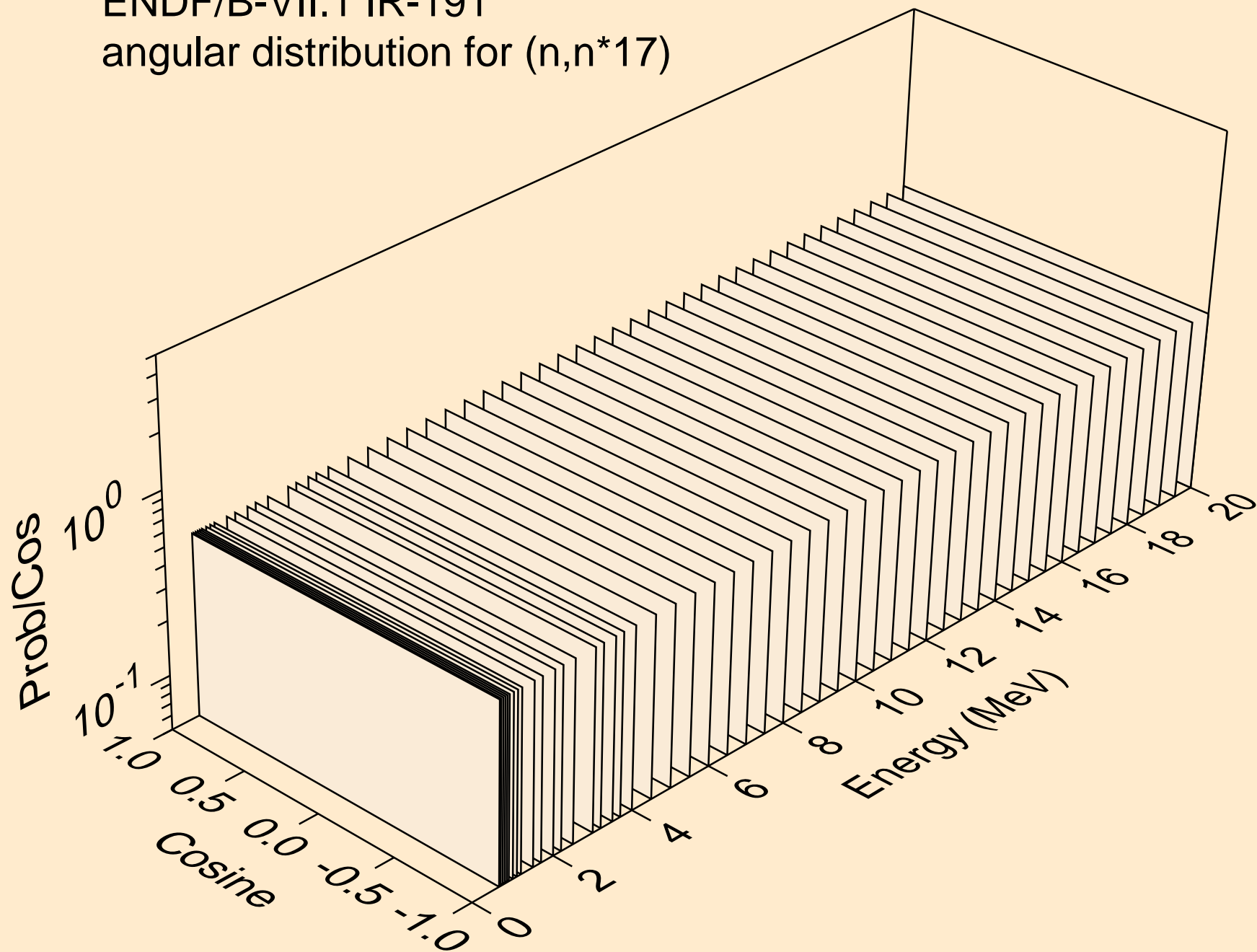

ENDF/B-VII.1 IR-191
angular distribution for (n,n*18)

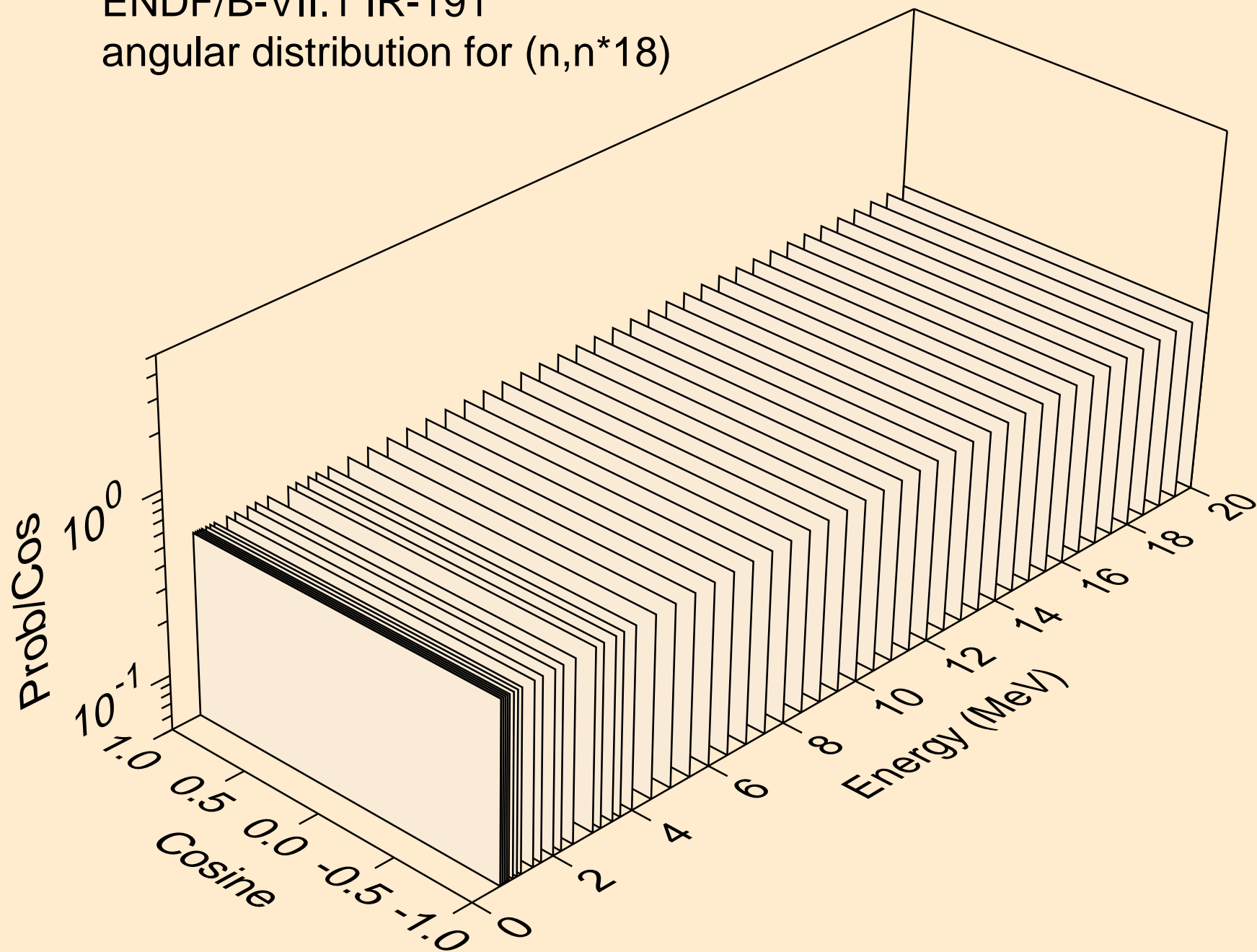

ENDF/B-VII.1 IR-191
angular distribution for (n,n*19)

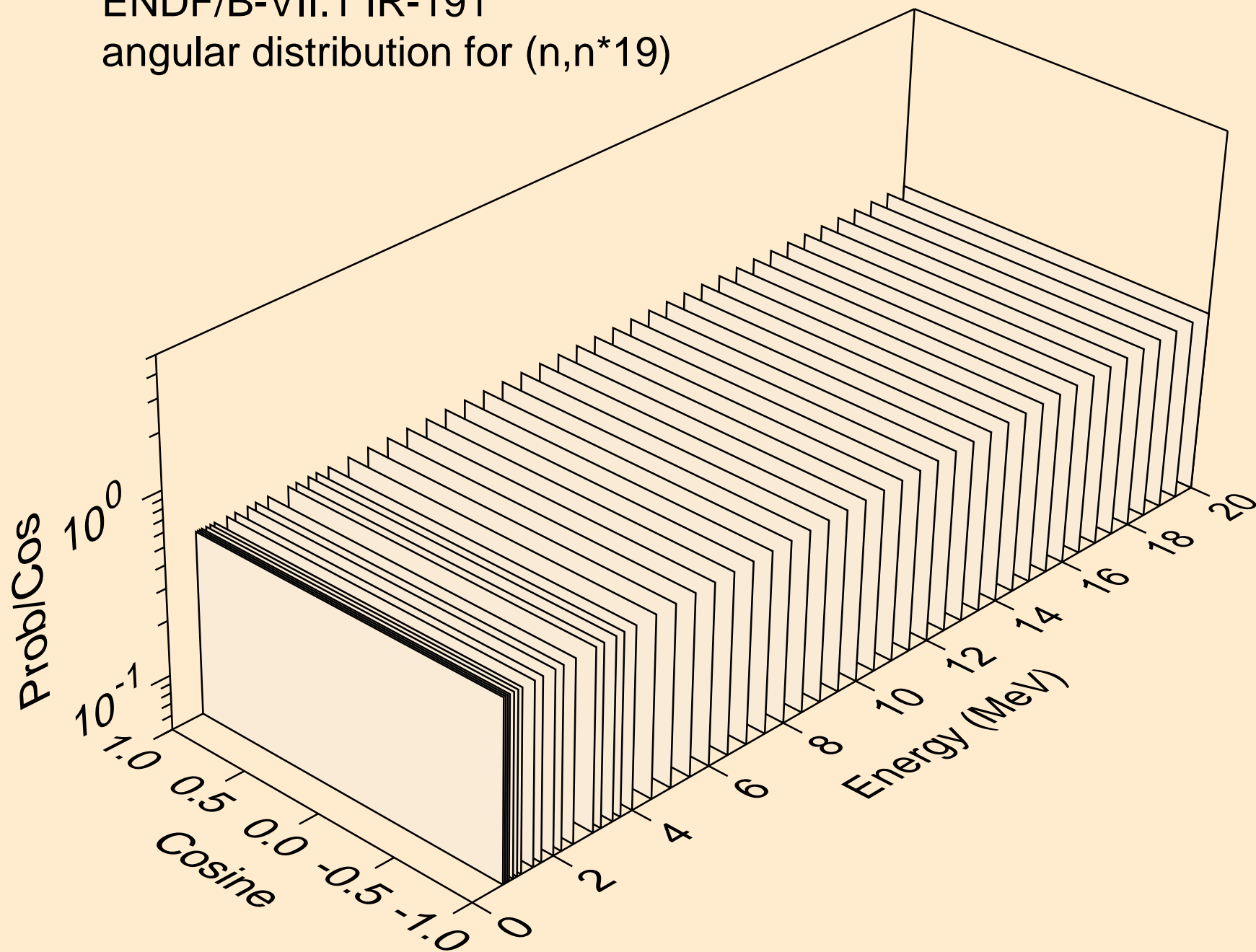

ENDF/B-VII.1 IR-191
Neutron emission for (n,2n)

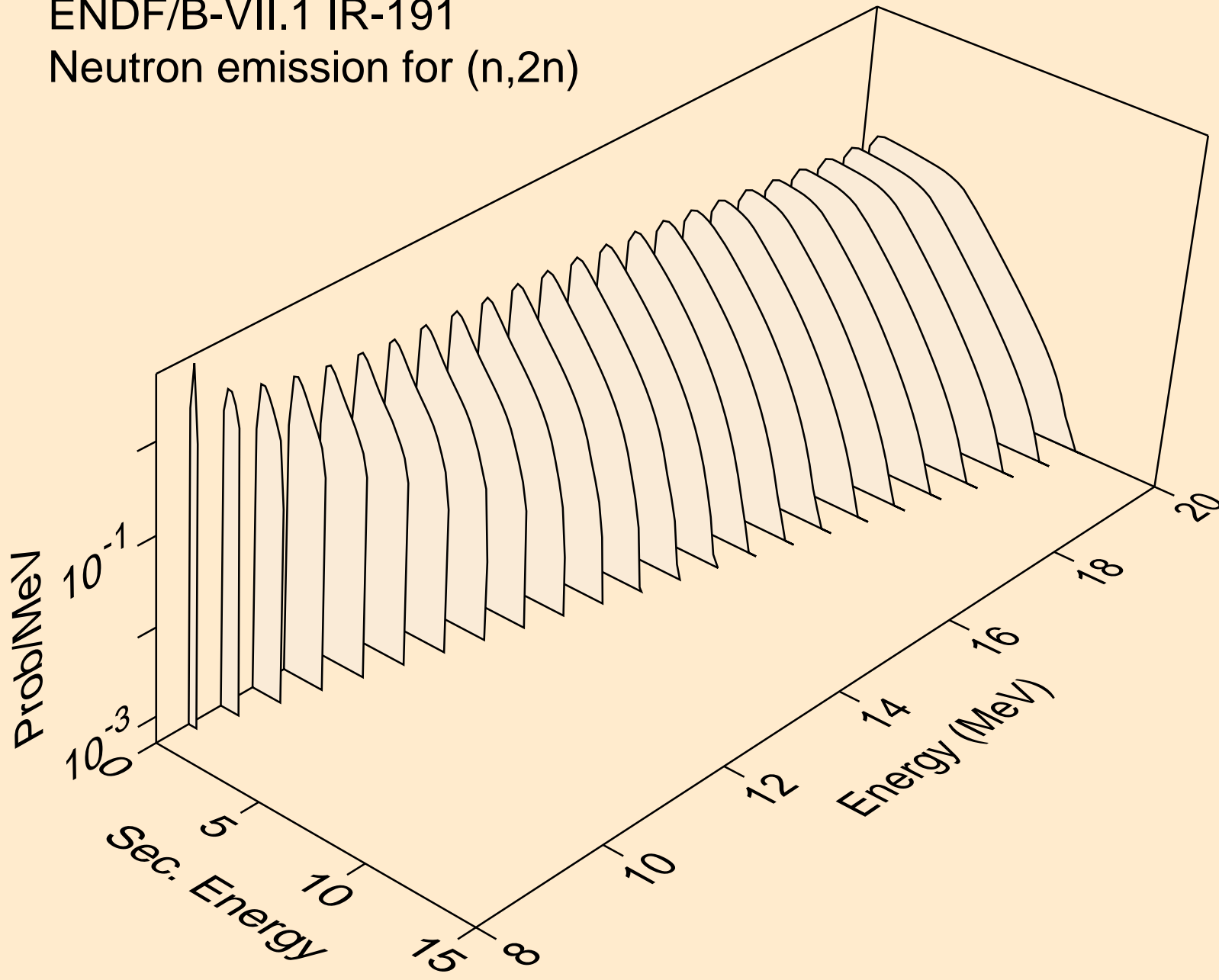

ENDF/B-VII.1 IR-191
Neutron emission for (n,3n)

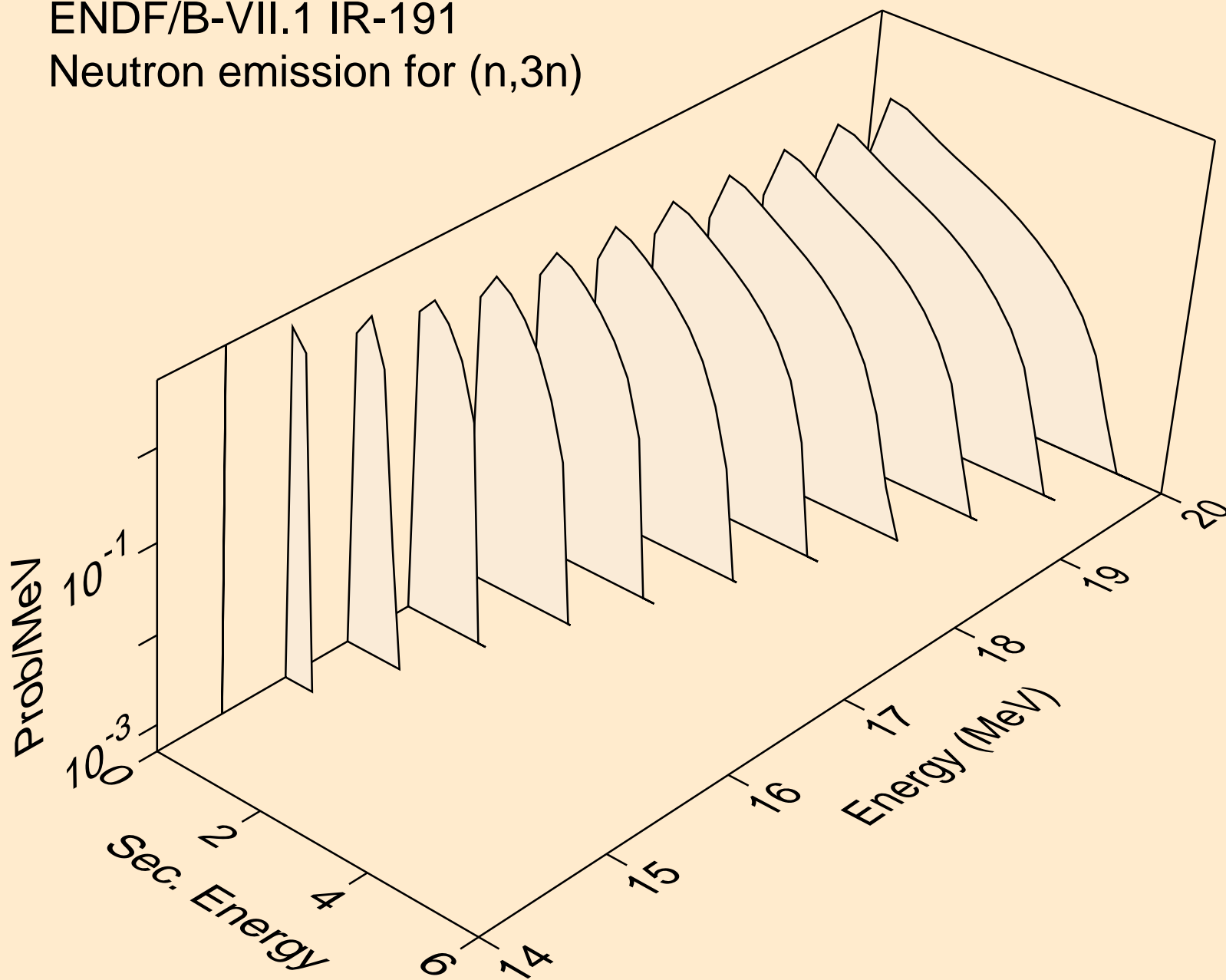

ENDF/B-VII.1 IR-191
Neutron emission for (n,n*)a

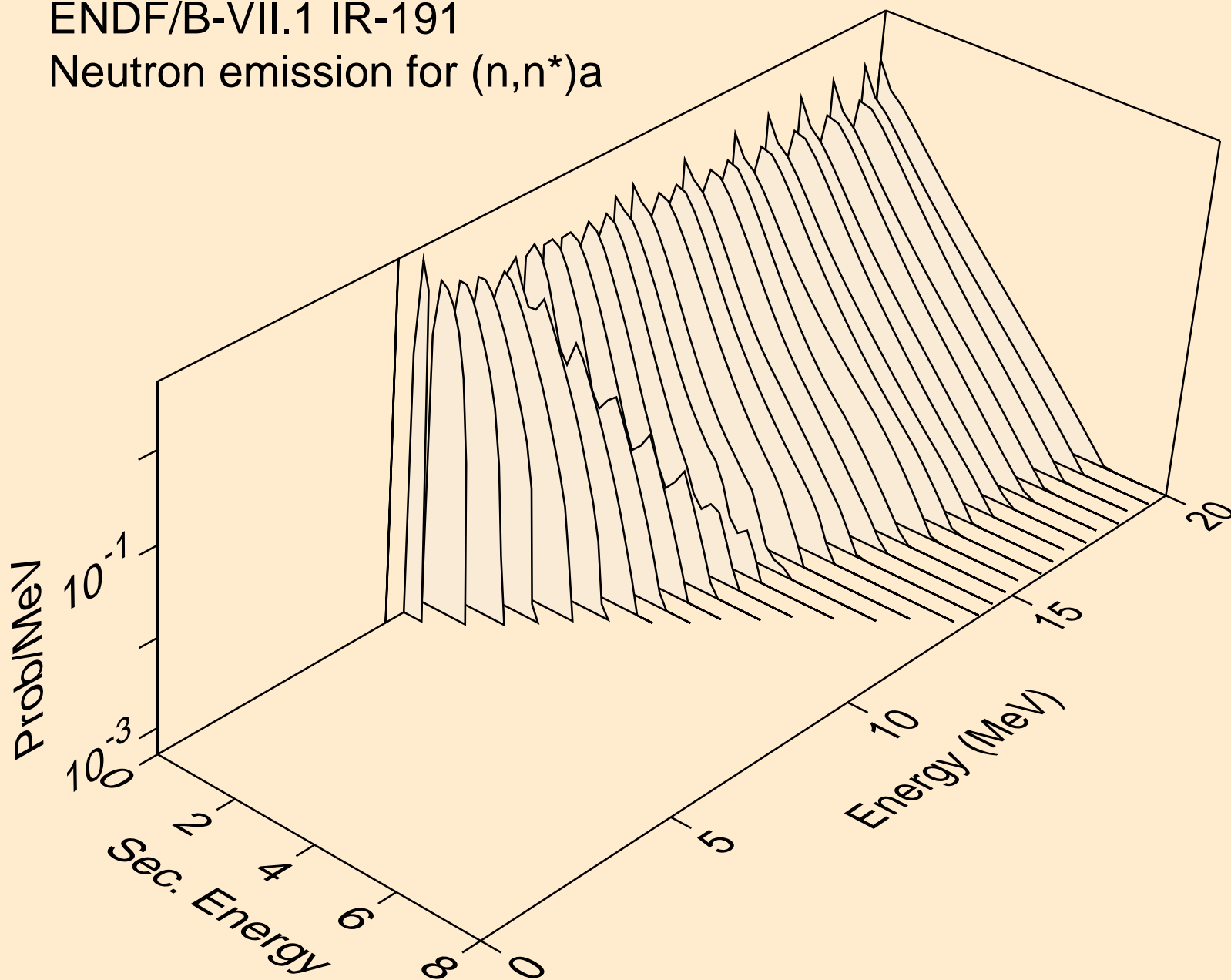

ENDF/B-VII.1 IR-191
Neutron emission for (n,2n)a

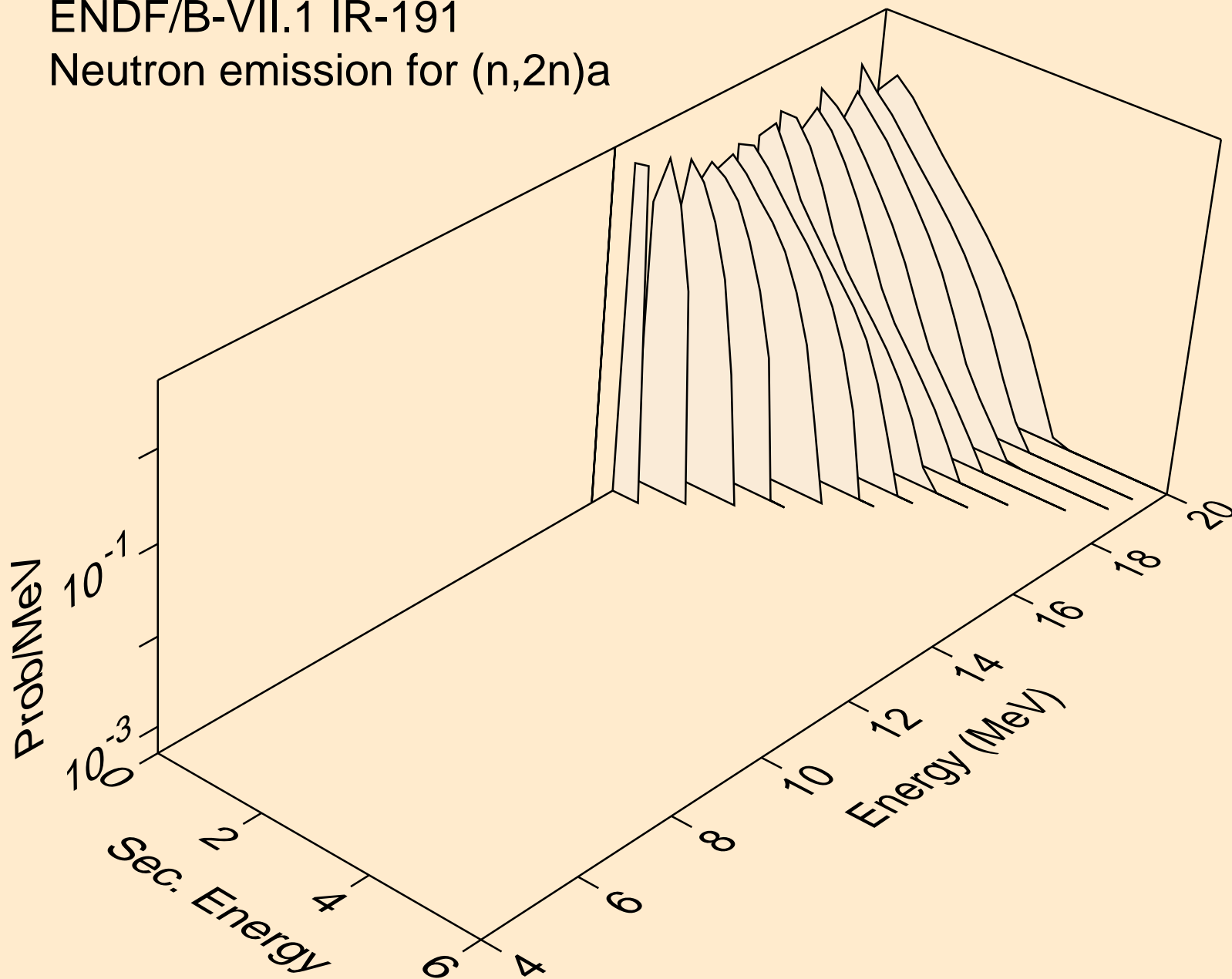

ENDF/B-VII.1 IR-191
Neutron emission for (n,n*)p

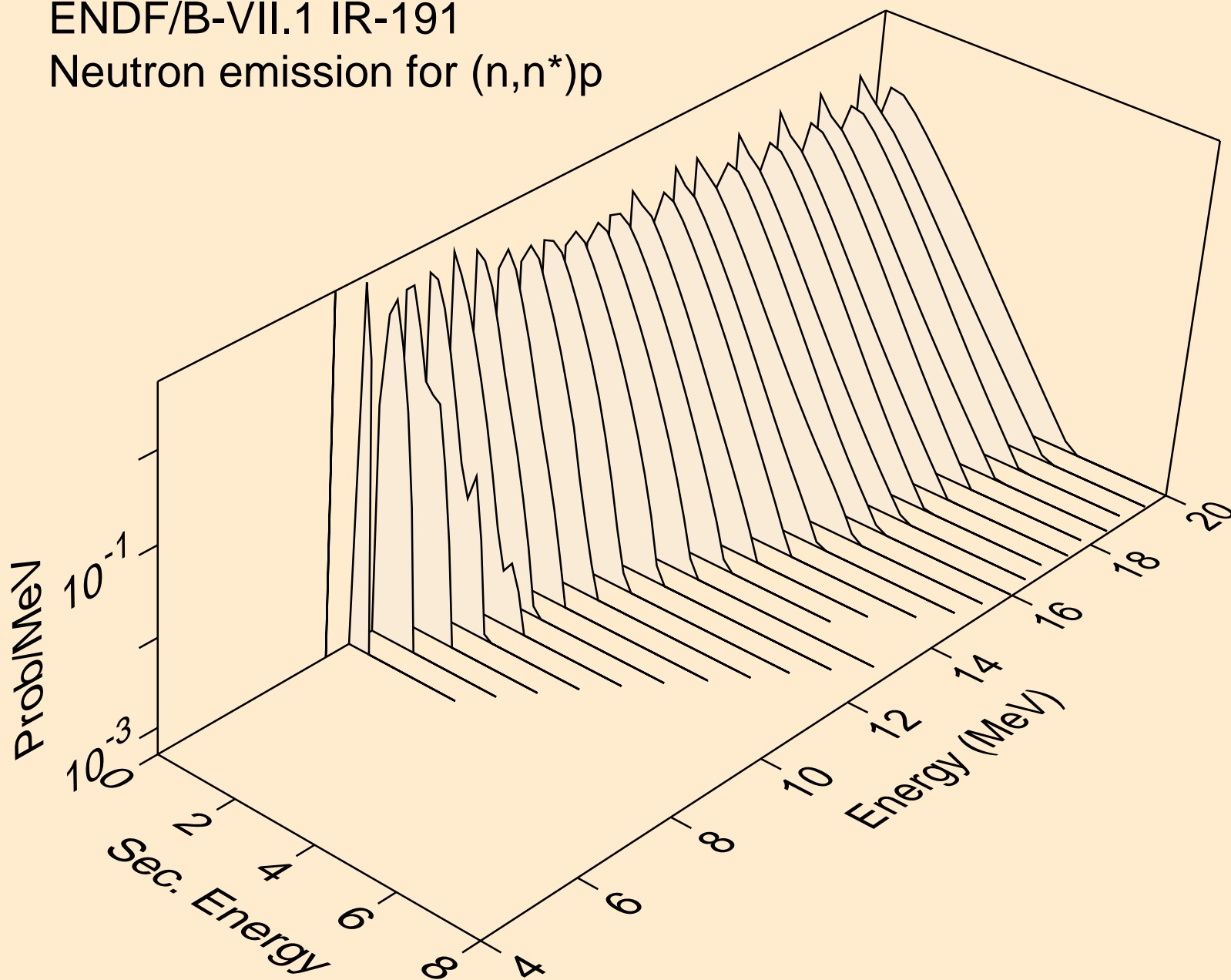

ENDF/B-VII.1 IR-191
Neutron emission for (n,2np)

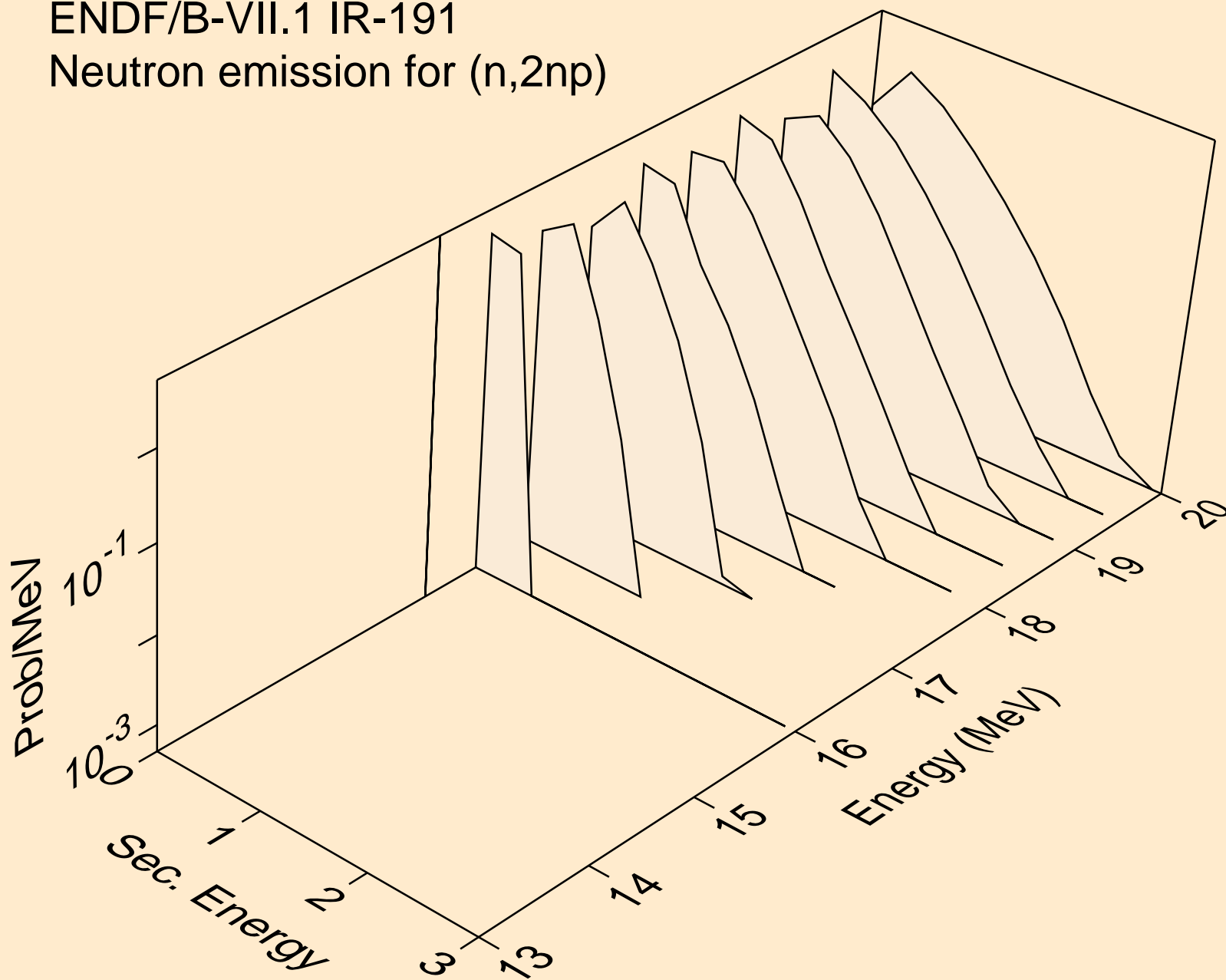

ENDF/B-VII.1 IR-191
Neutron emission for (n,n*c)

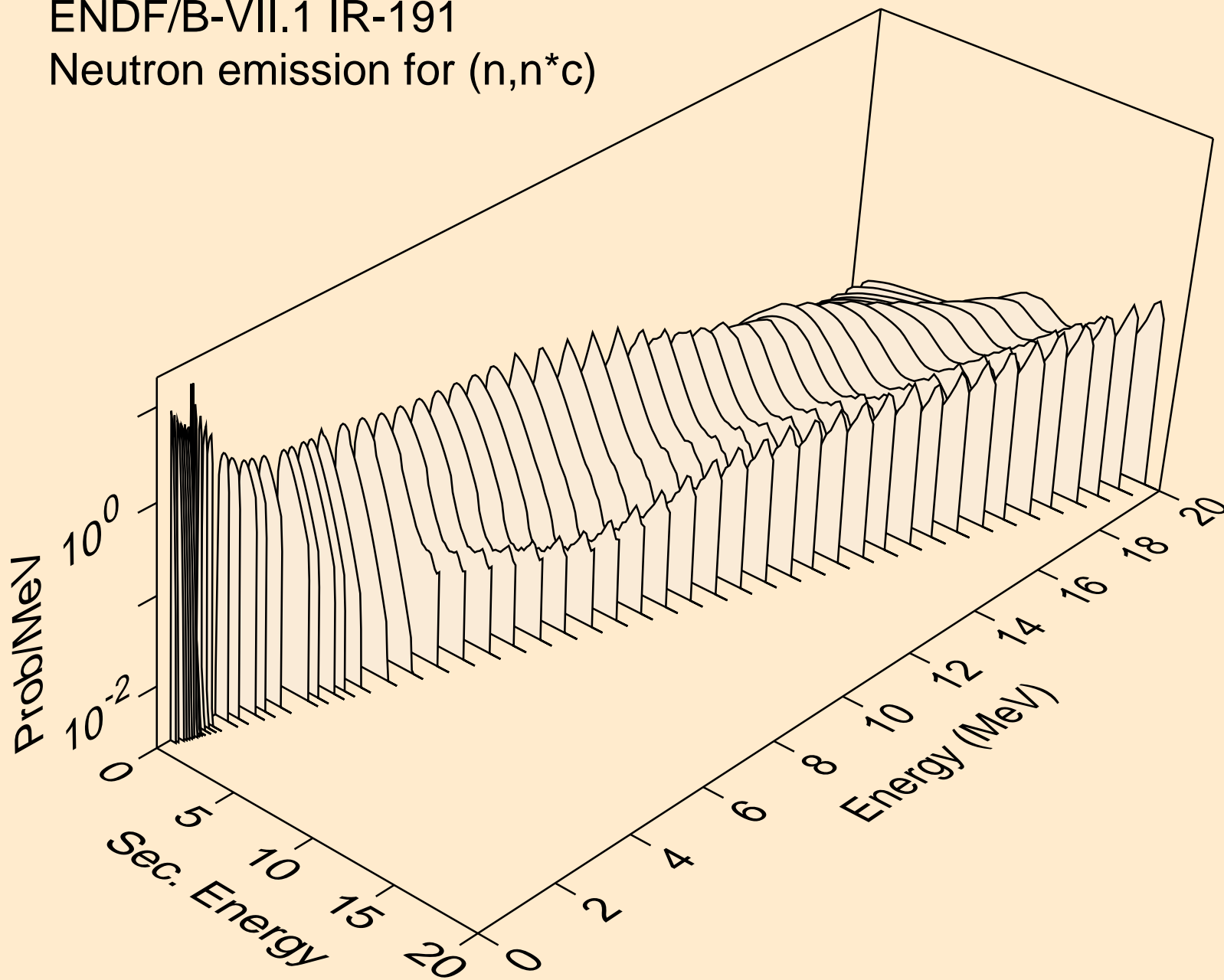

ENDF/B-VII.1 IR-191
Photon emission for (n,2n)

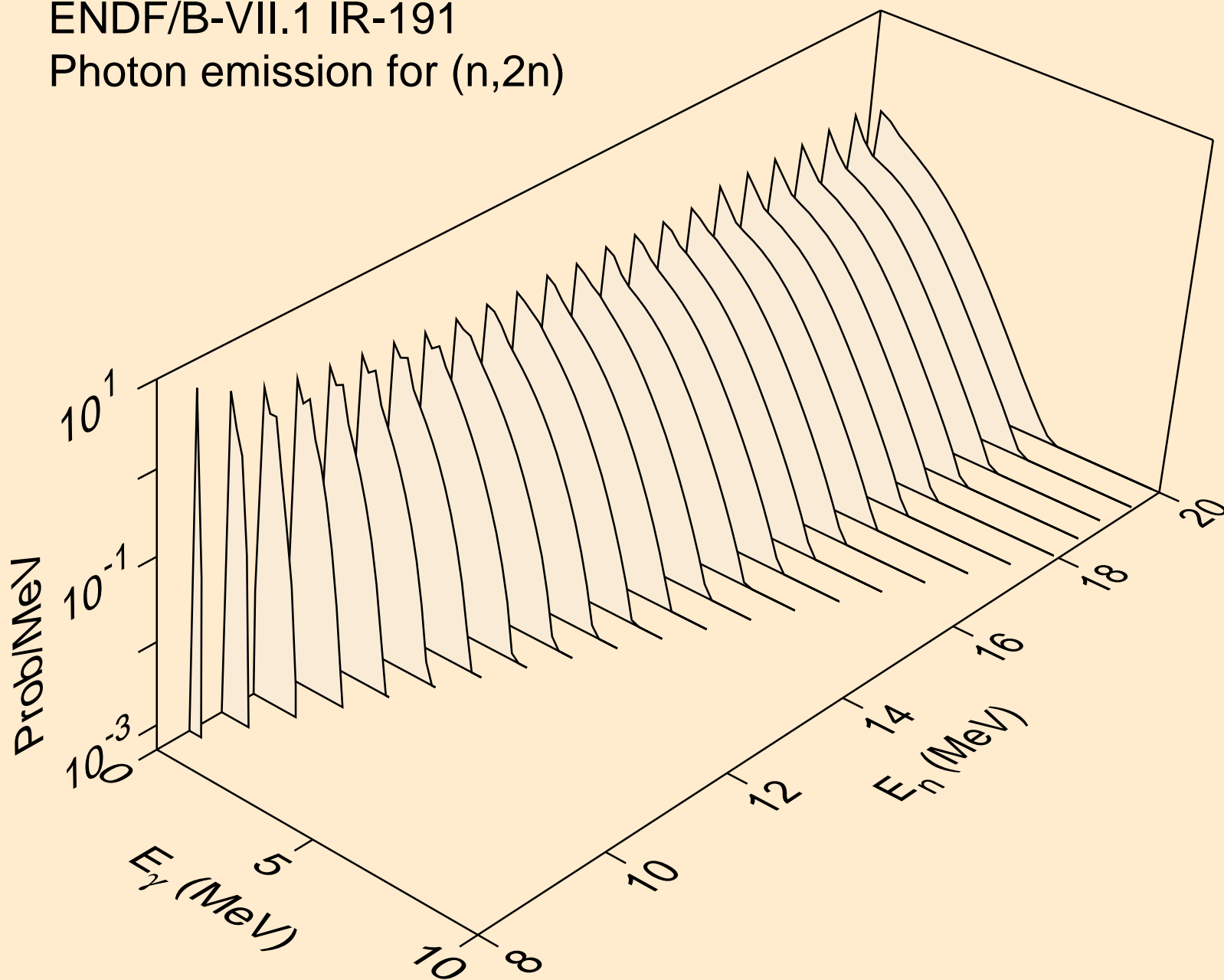

ENDF/B-VII.1 IR-191
Photon emission for (n,3n)

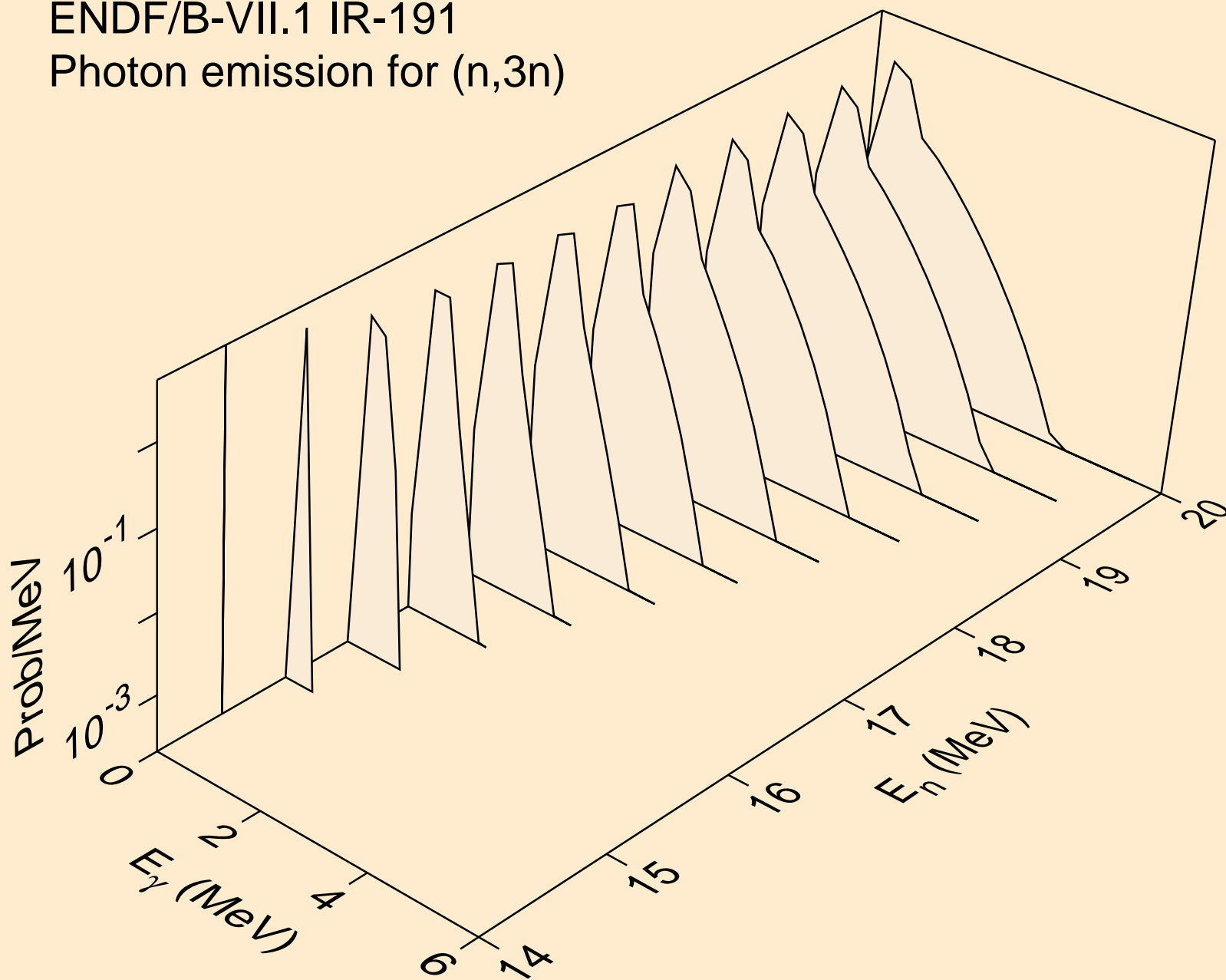

ENDF/B-VII.1 IR-191
Photon emission for (n,n*)a

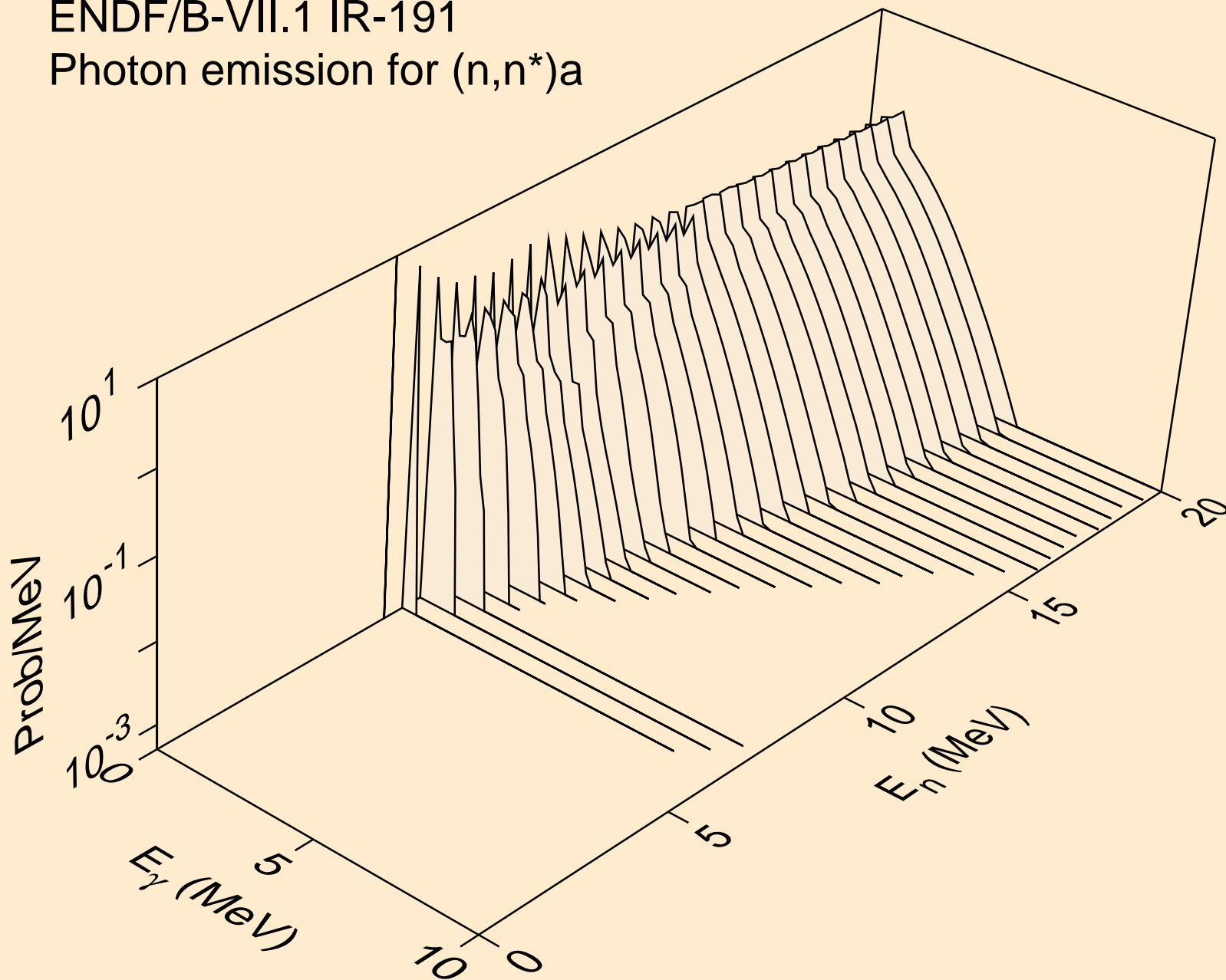

ENDF/B-VII.1 IR-191
Photon emission for (n,2n)a

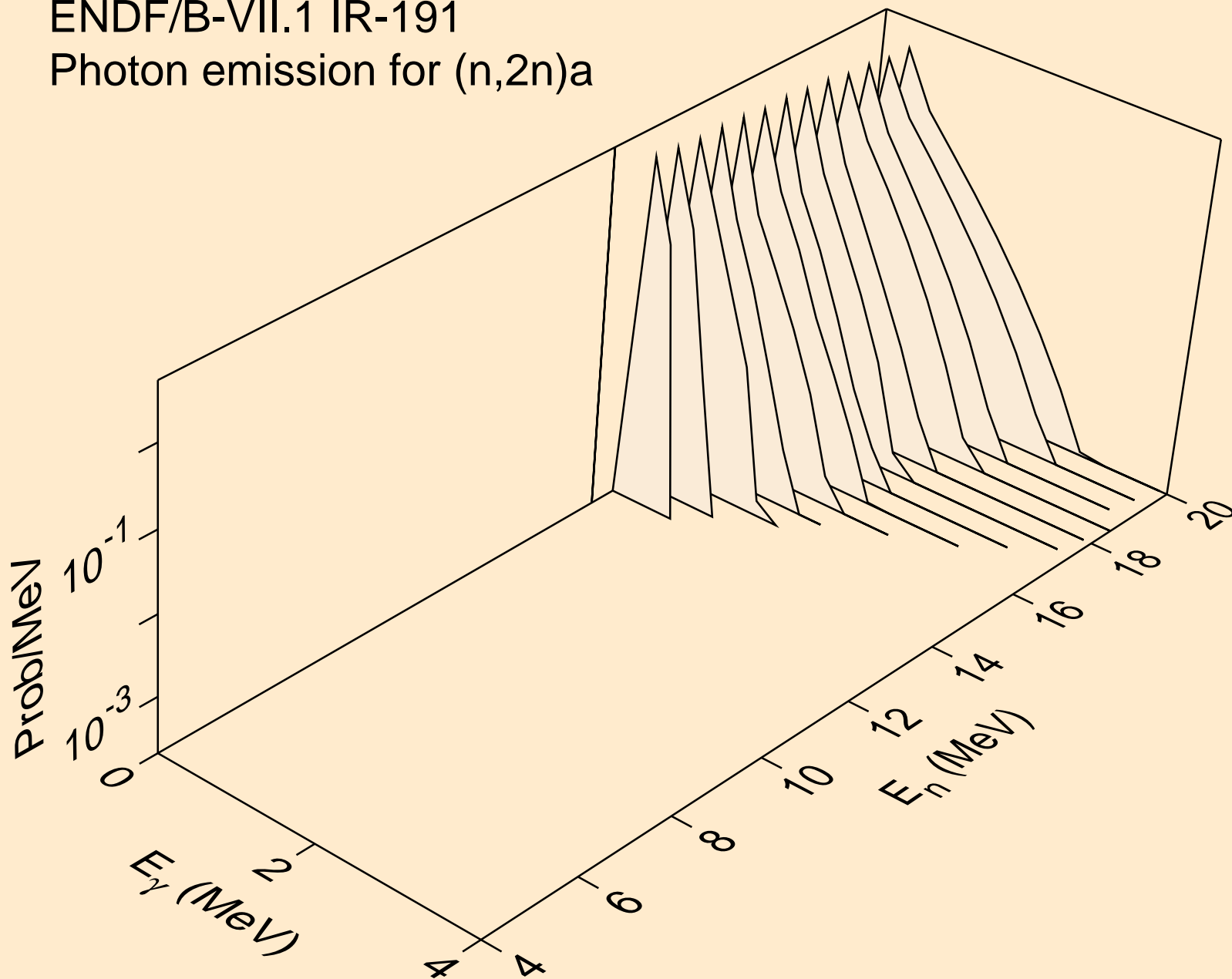

ENDF/B-VII.1 IR-191
Photon emission for (n,n*)p

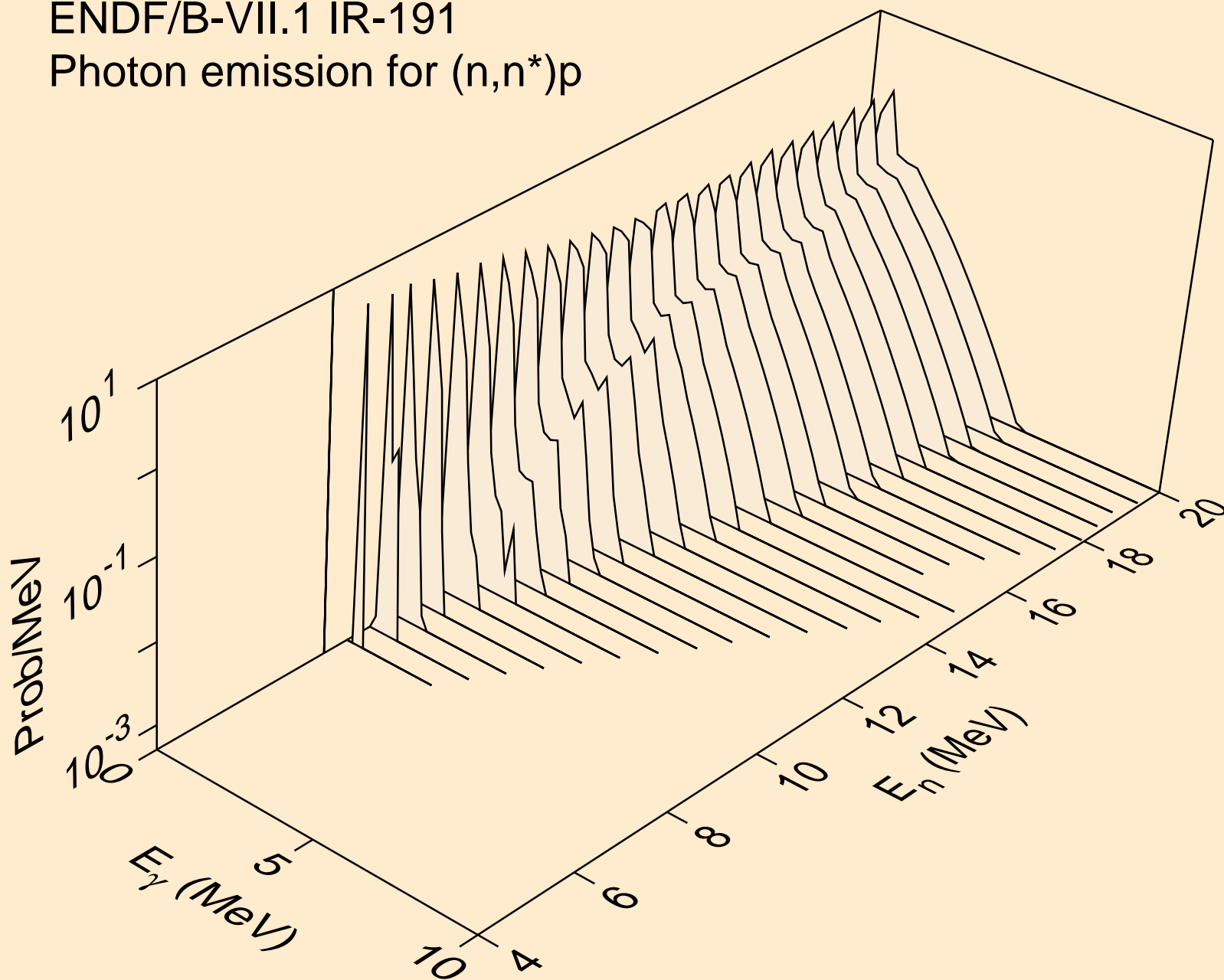

ENDF/B-VII.1 IR-191
Photon emission for (n,2np)

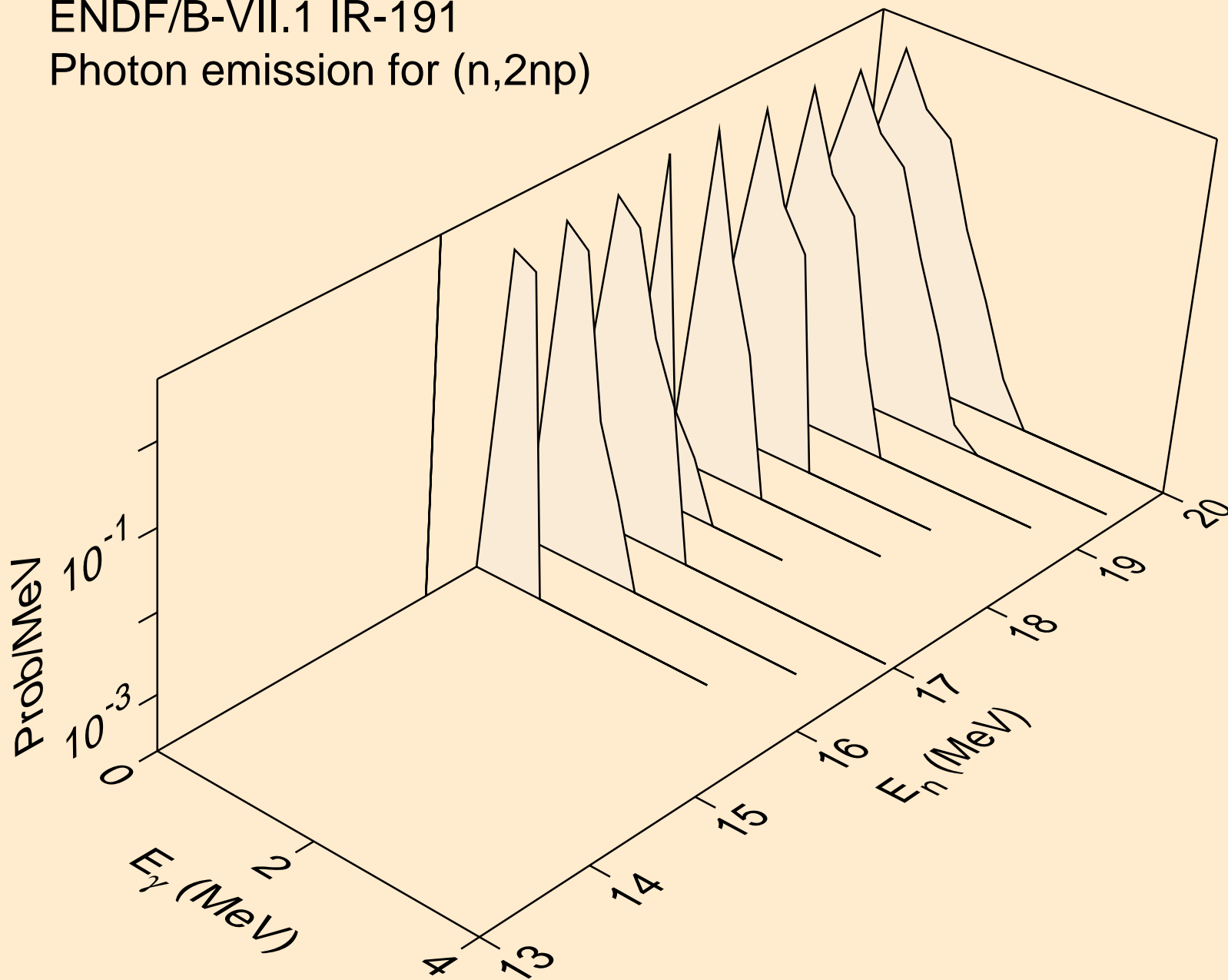

ENDF/B-VII.1 IR-191
Photon emission for (n,n*c)

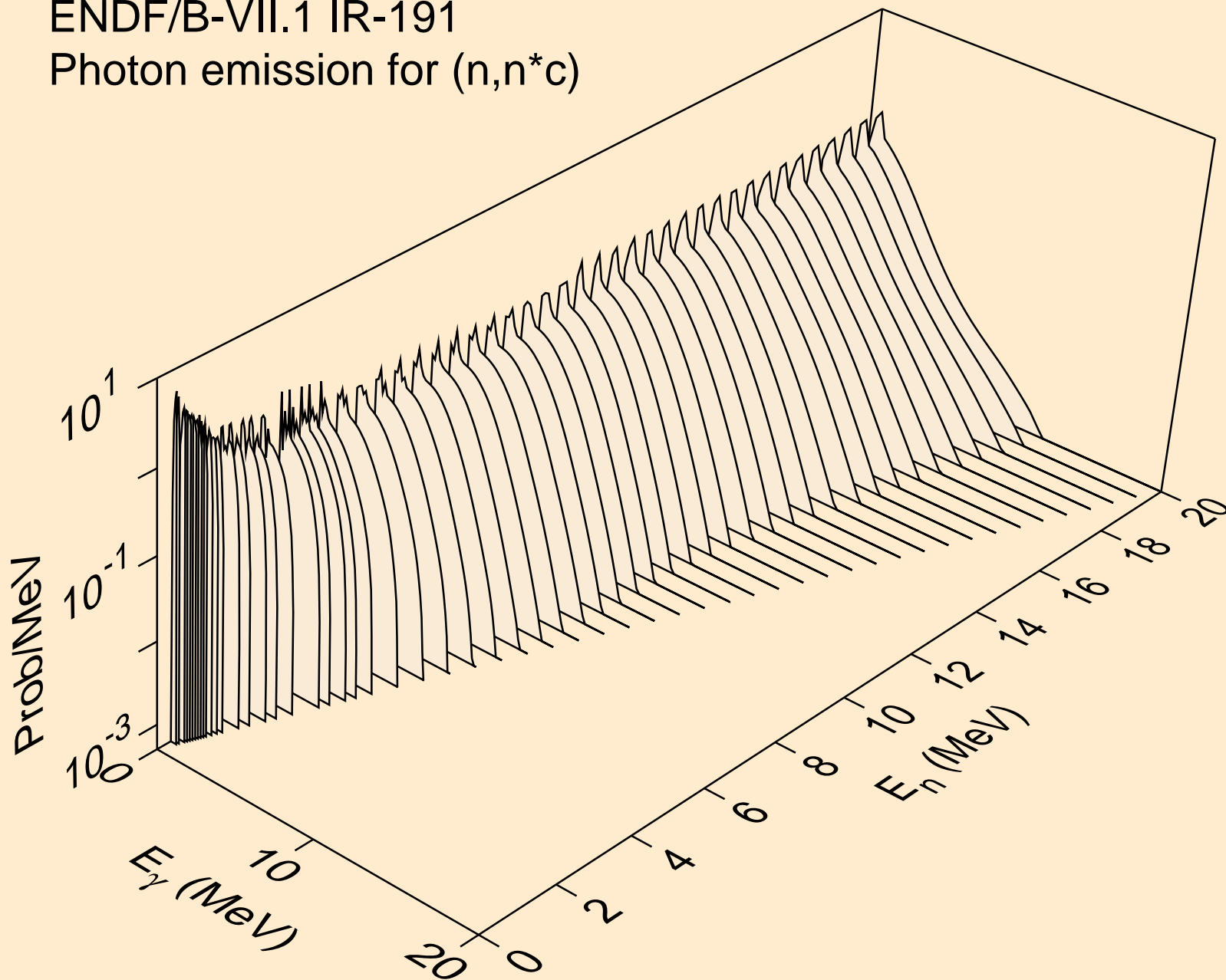

ENDF/B-VII.1 IR-191
Photon emission for (n,gma)

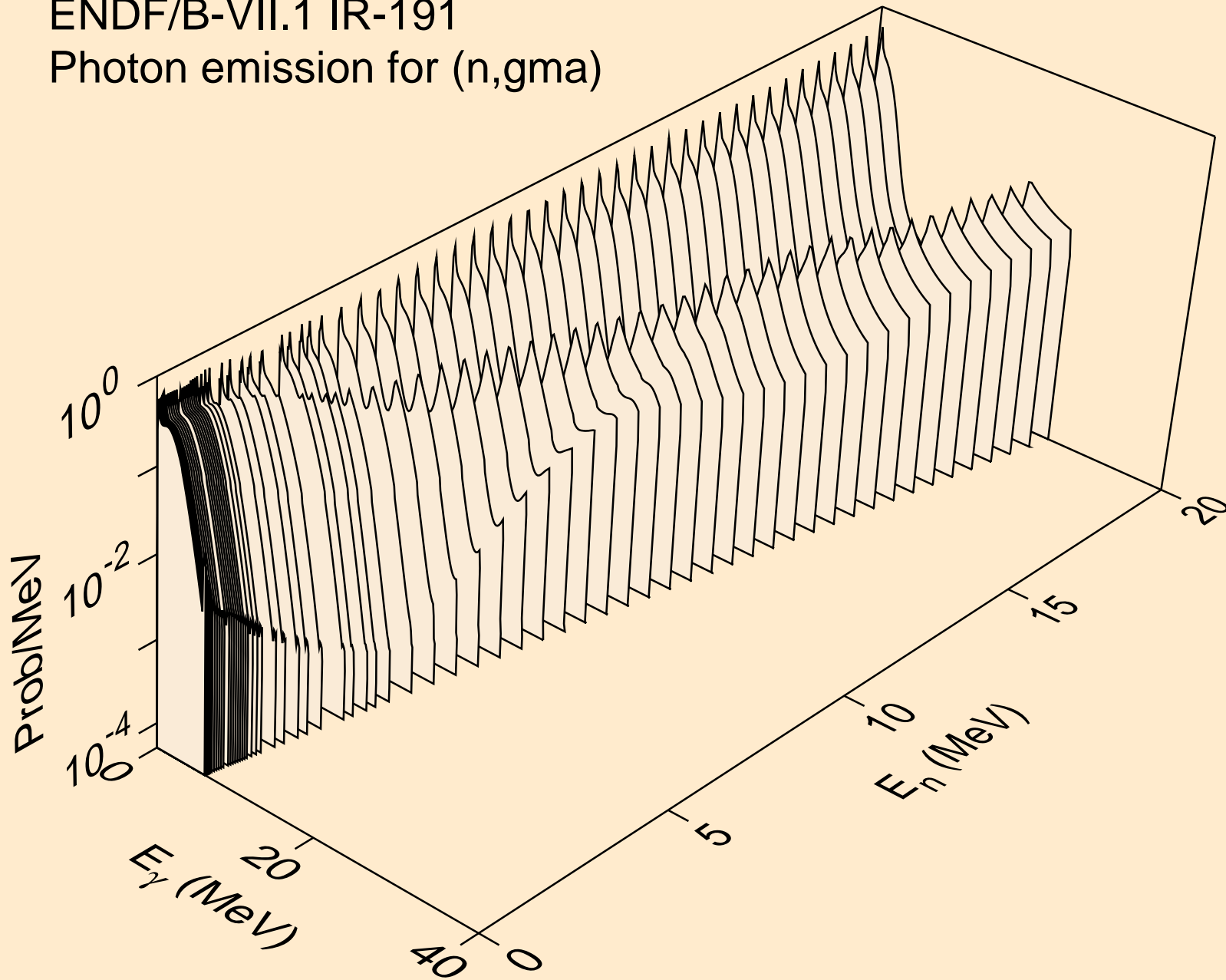

ENDF/B-VII.1 IR-191
Photon emission for (n,p*c)

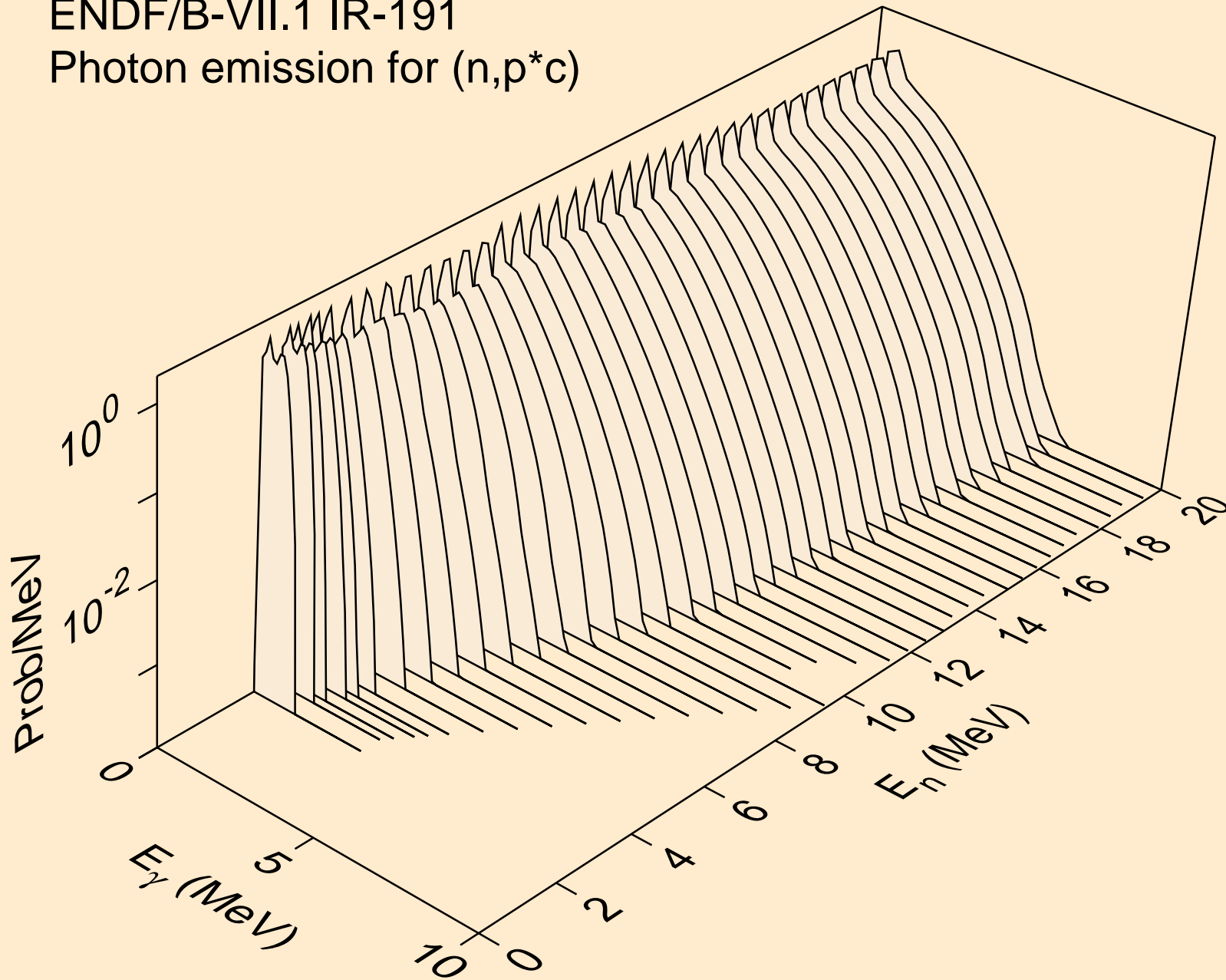

ENDF/B-VII.1 IR-191
Photon emission for (n,a*c)

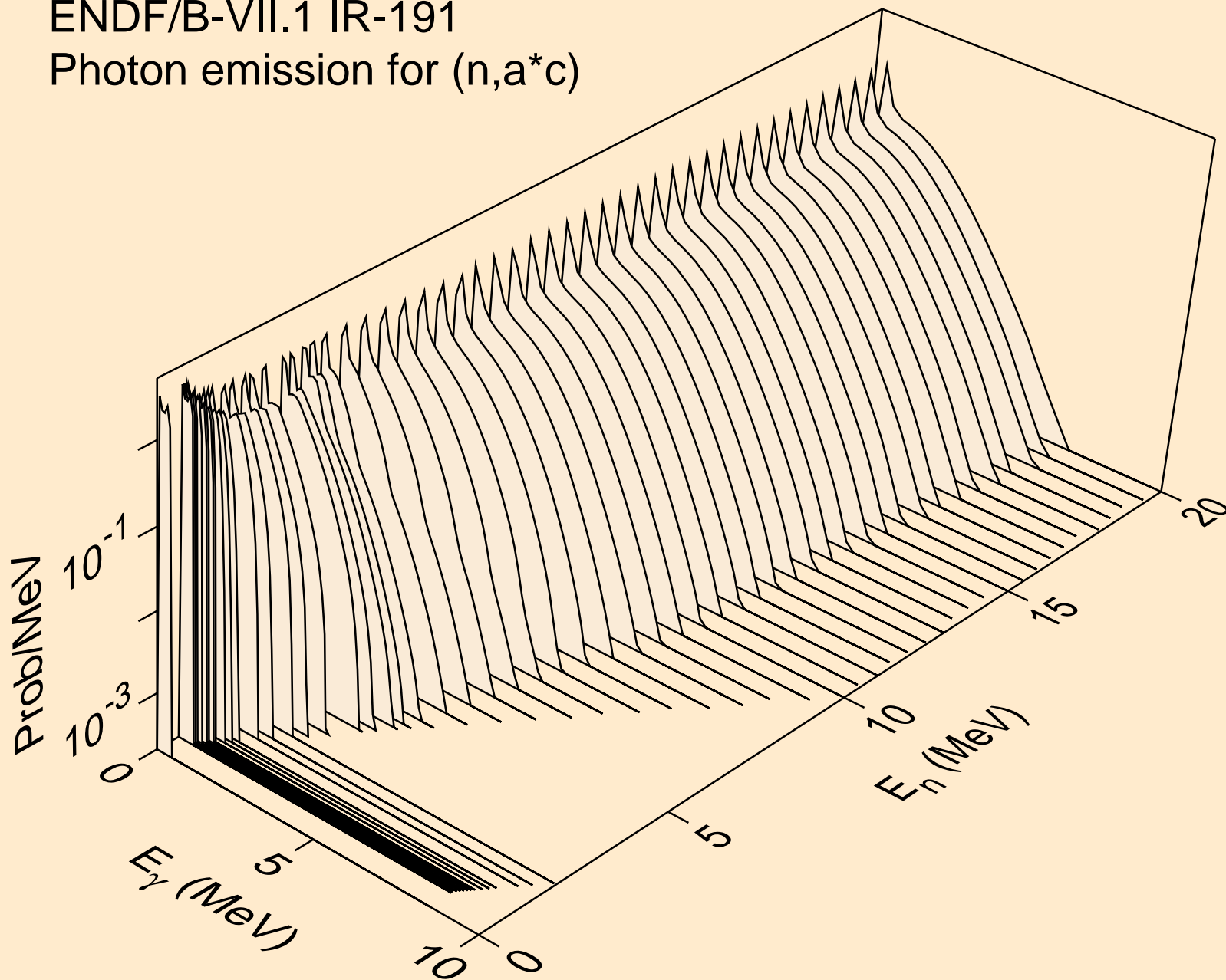

ENDF/B-VII.1 IR-191
thermal capture photon spectrum

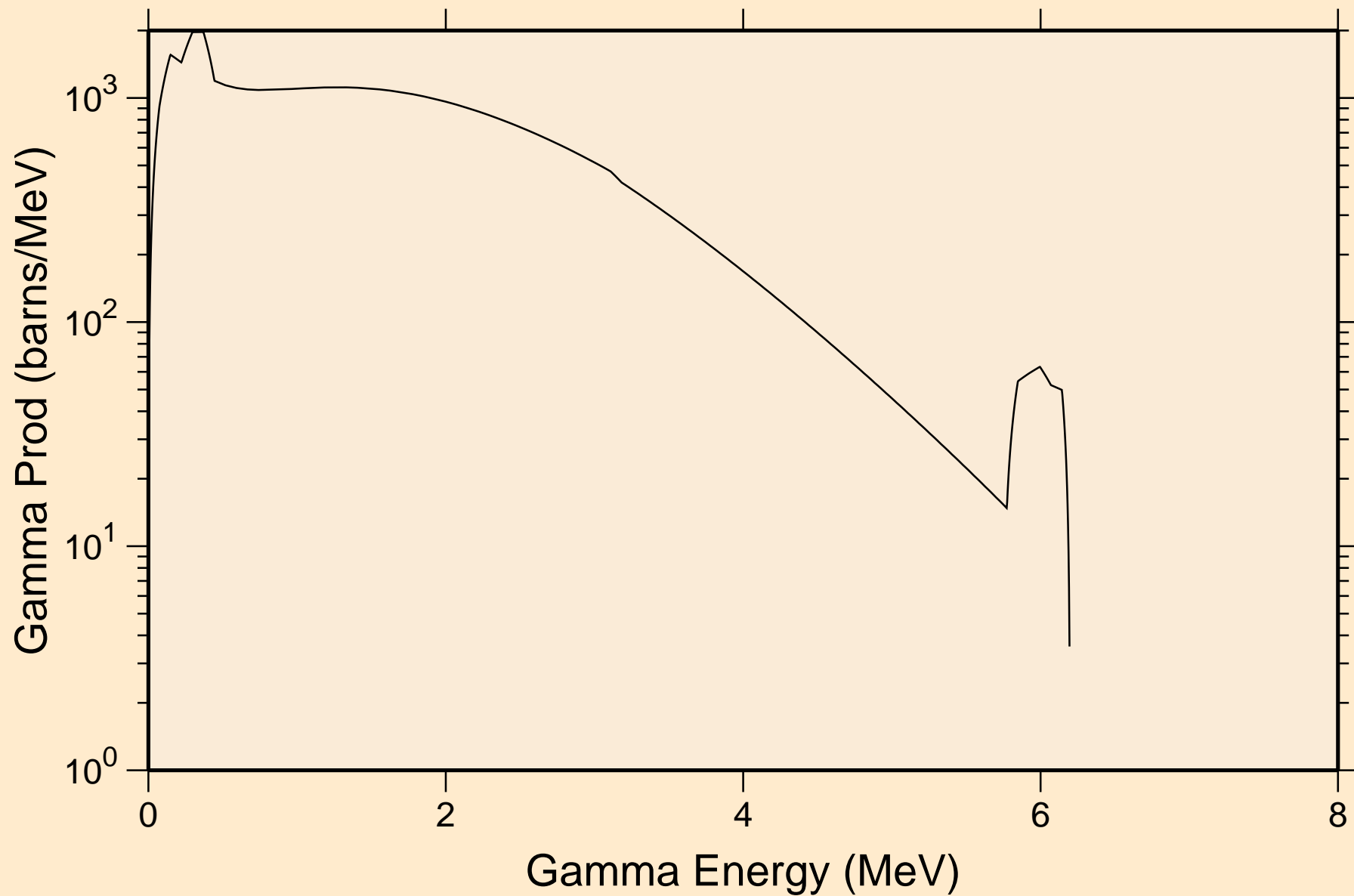

ENDF/B-VII.1 IR-191
14 MeV photon spectrum

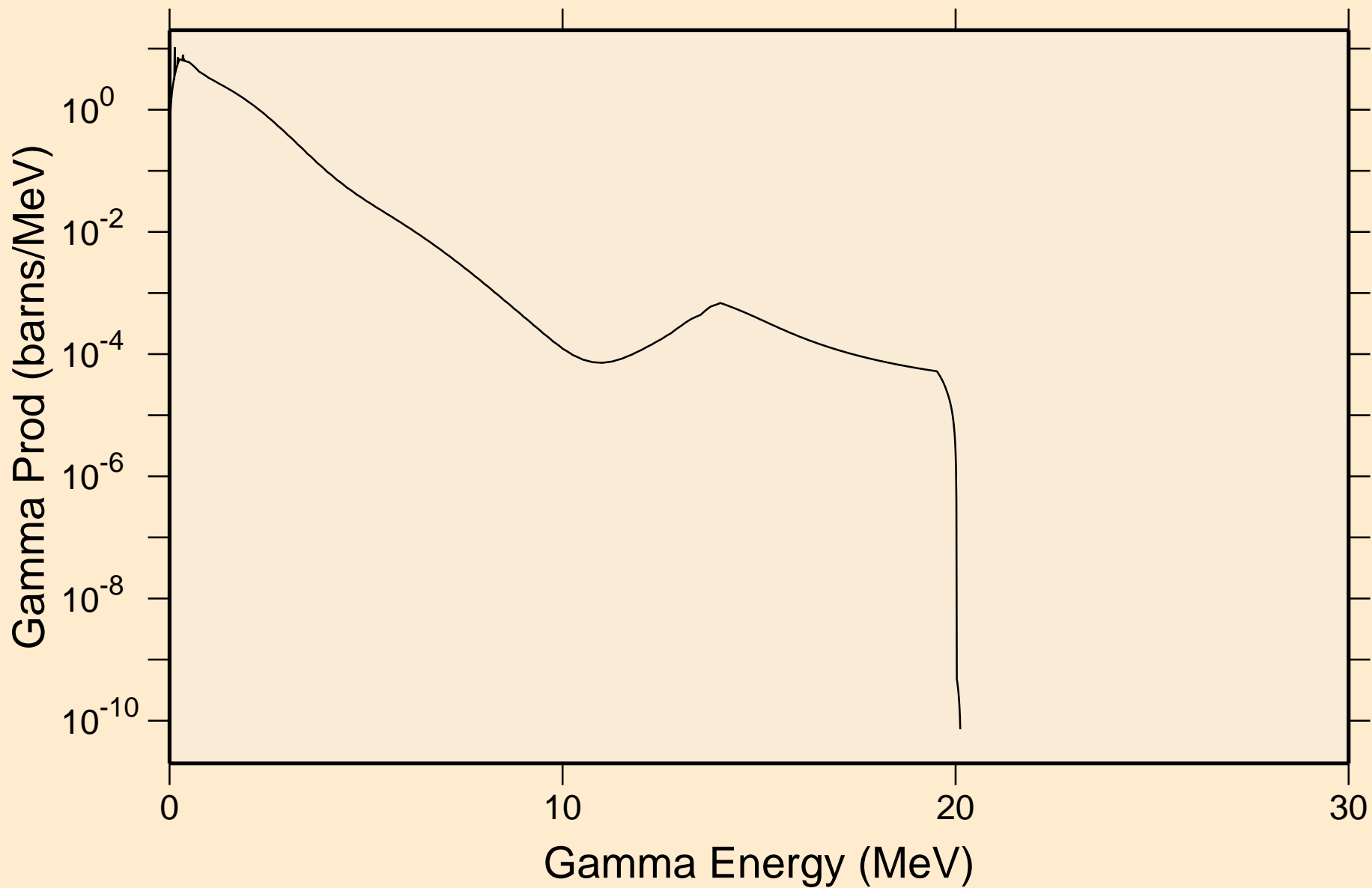

ENDF/B-VII.1 IR-191

Particle heating contributions

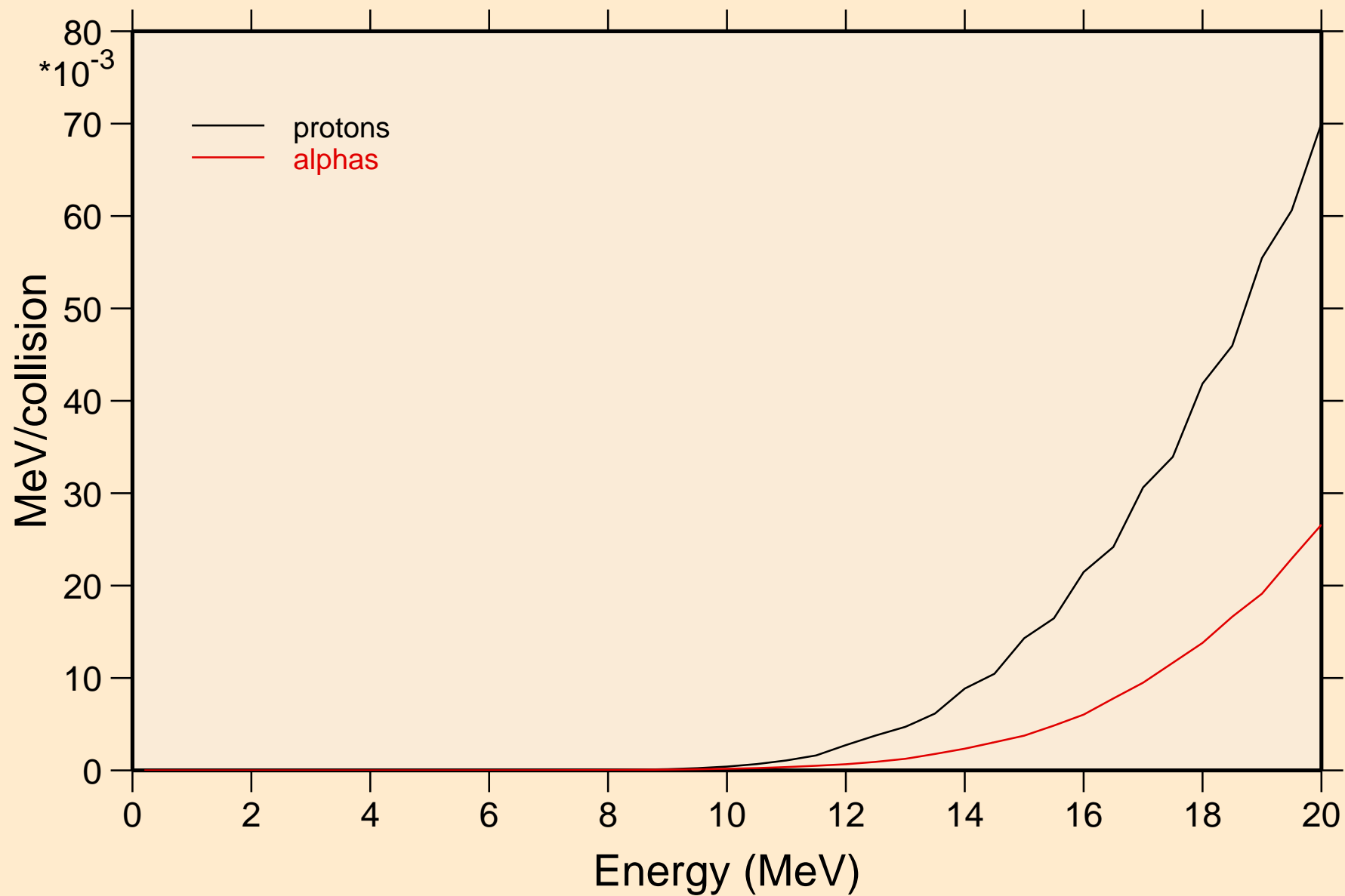

ENDF/B-VII.1 IR-191

Recoil Heating

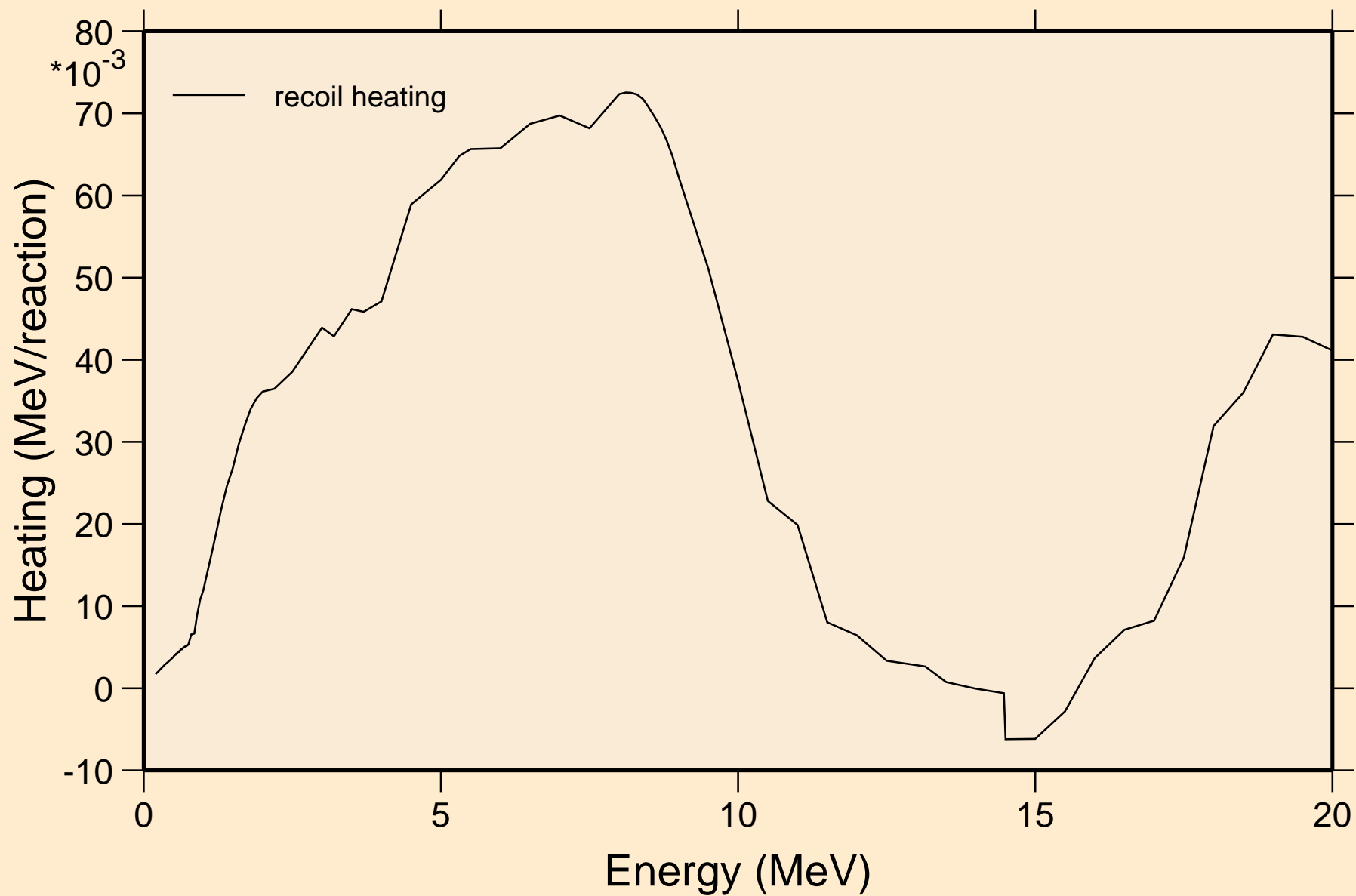

ENDF/B-VII.1 IR-191

Particle production cross sections

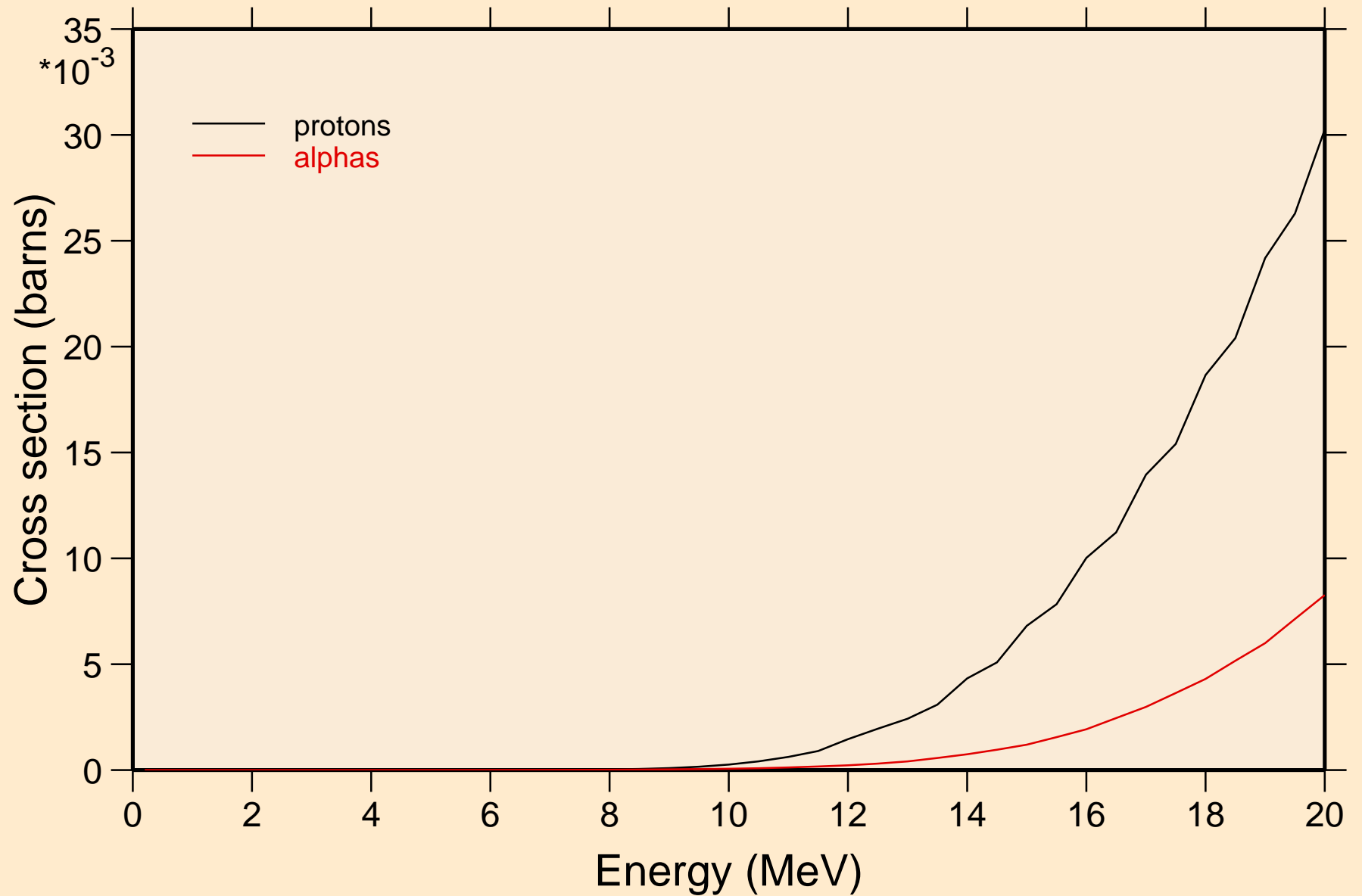

ENDF/B-VII.1 IR-191
protons from (n,n*)p

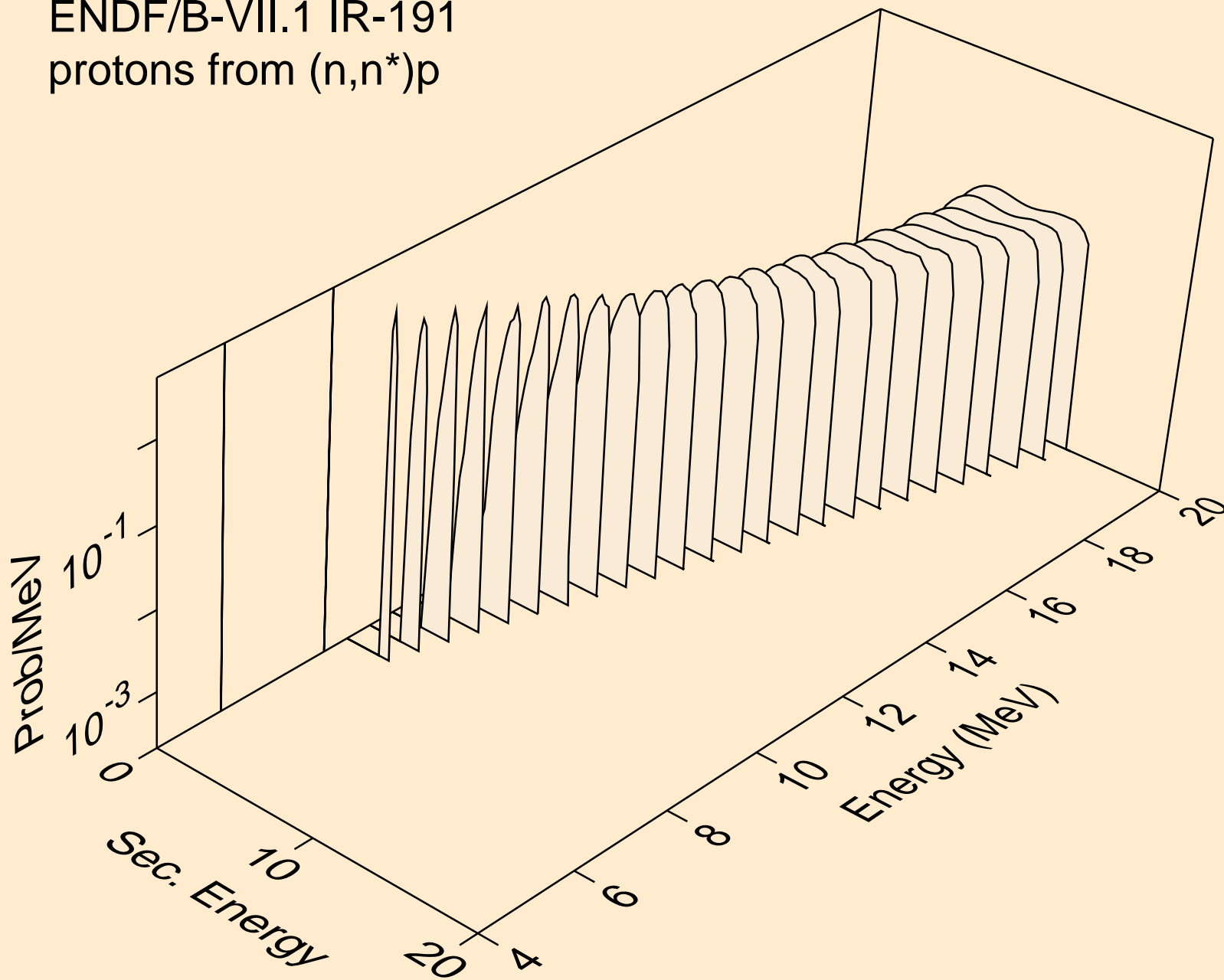

ENDF/B-VII.1 IR-191
protons from (n,2np)

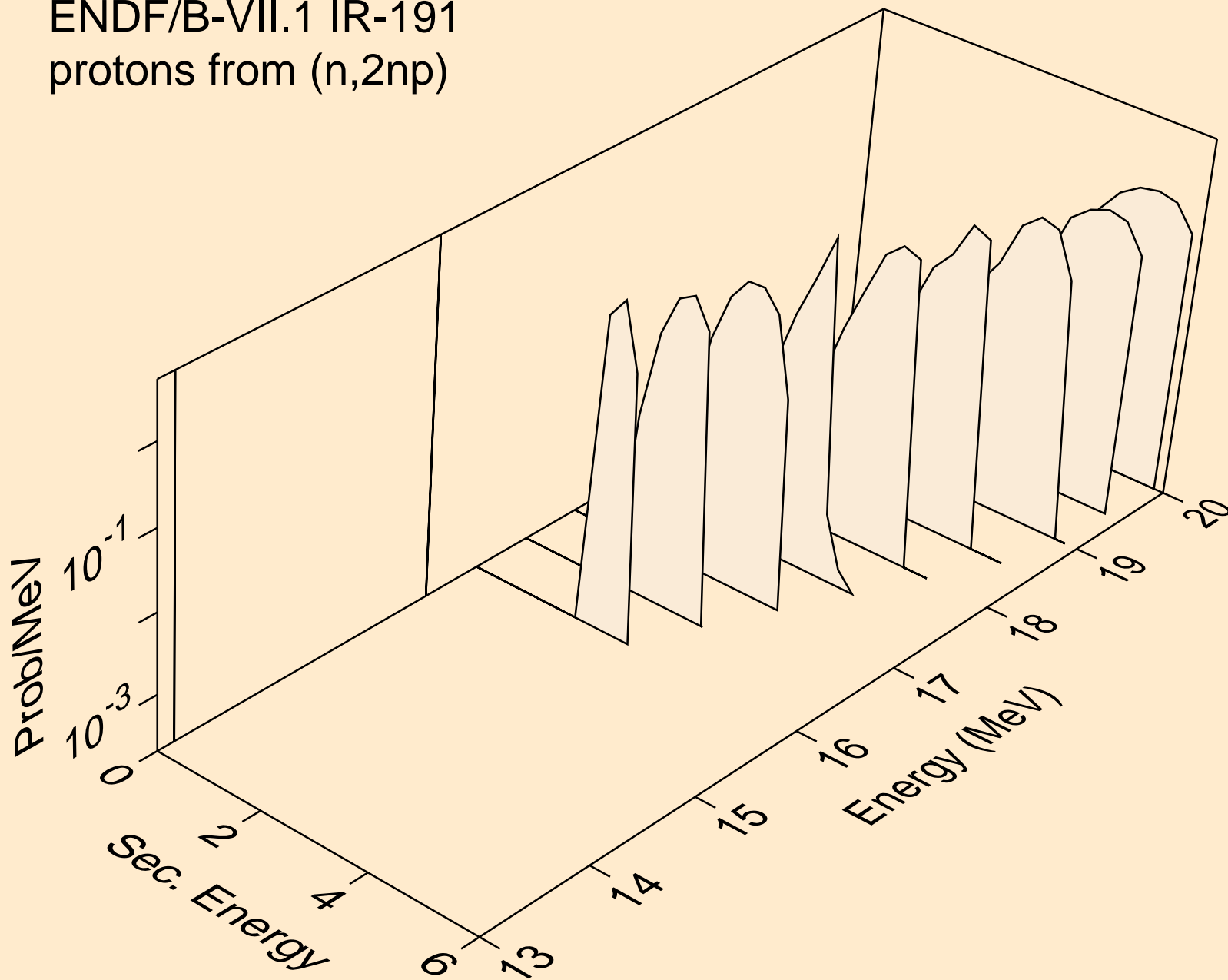

ENDF/B-VII.1 IR-191

angular distribution for (n,p*0) proton

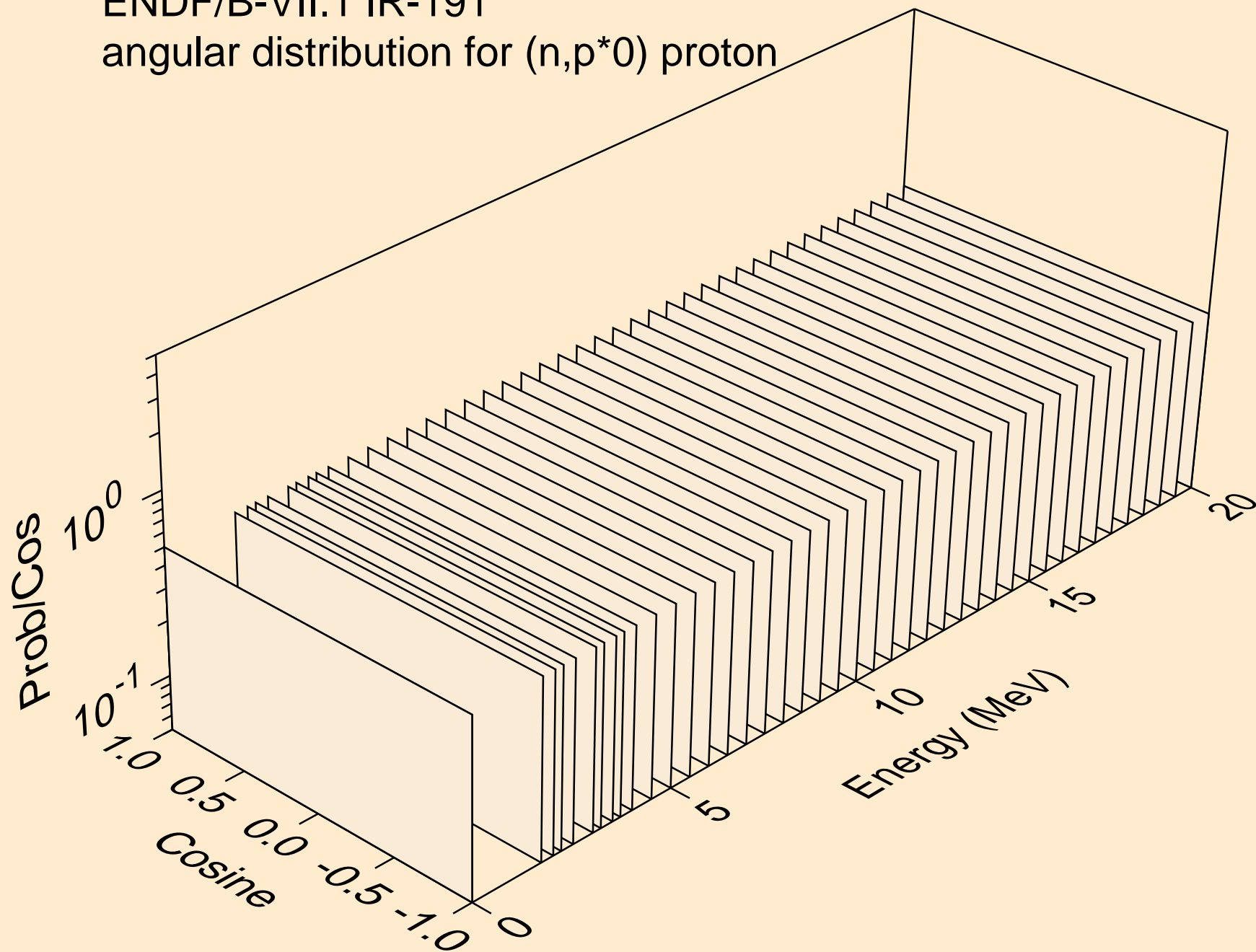

ENDF/B-VII.1 IR-191

angular distribution for (n,p*1) proton

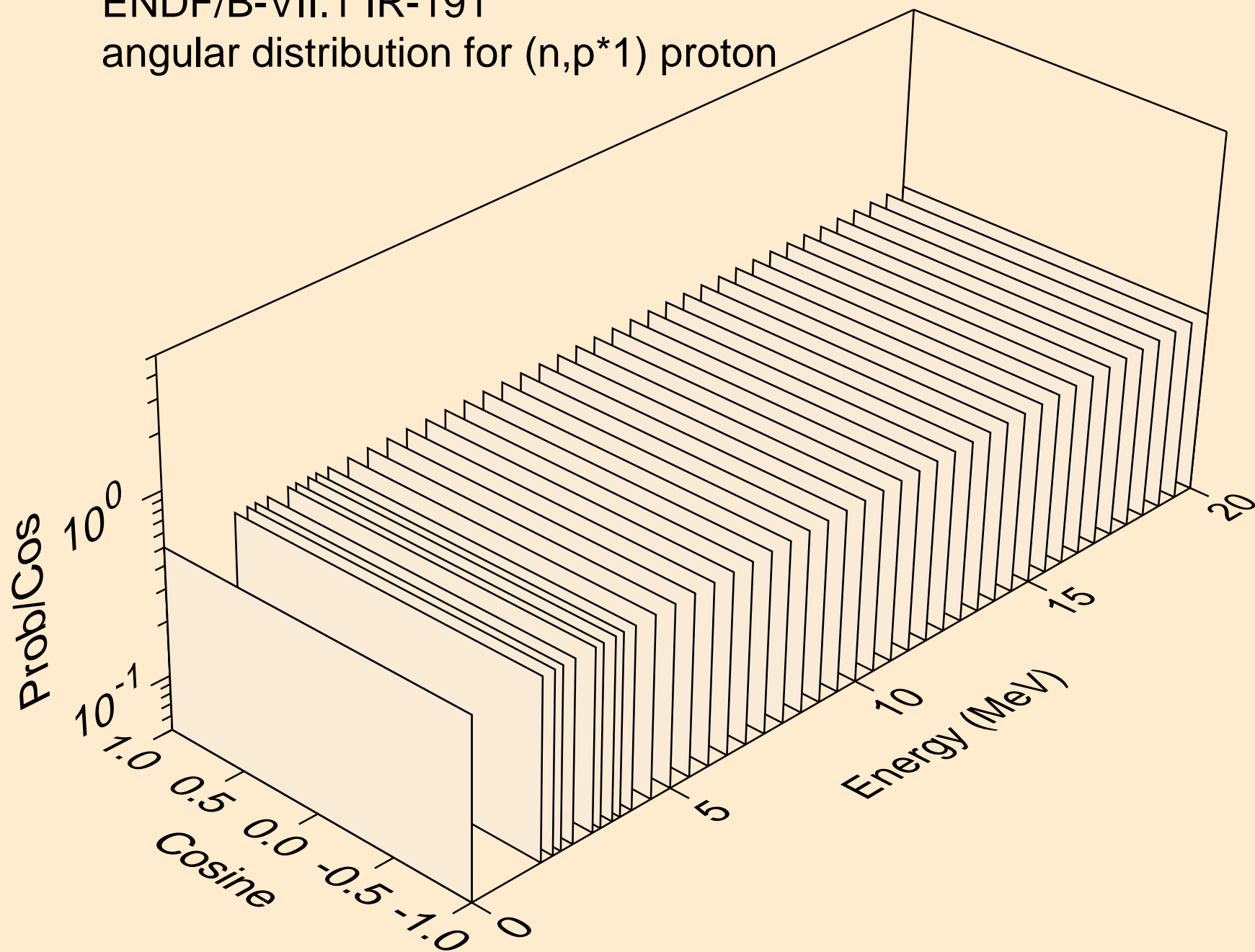

ENDF/B-VII.1 IR-191

angular distribution for (n,p*2) proton

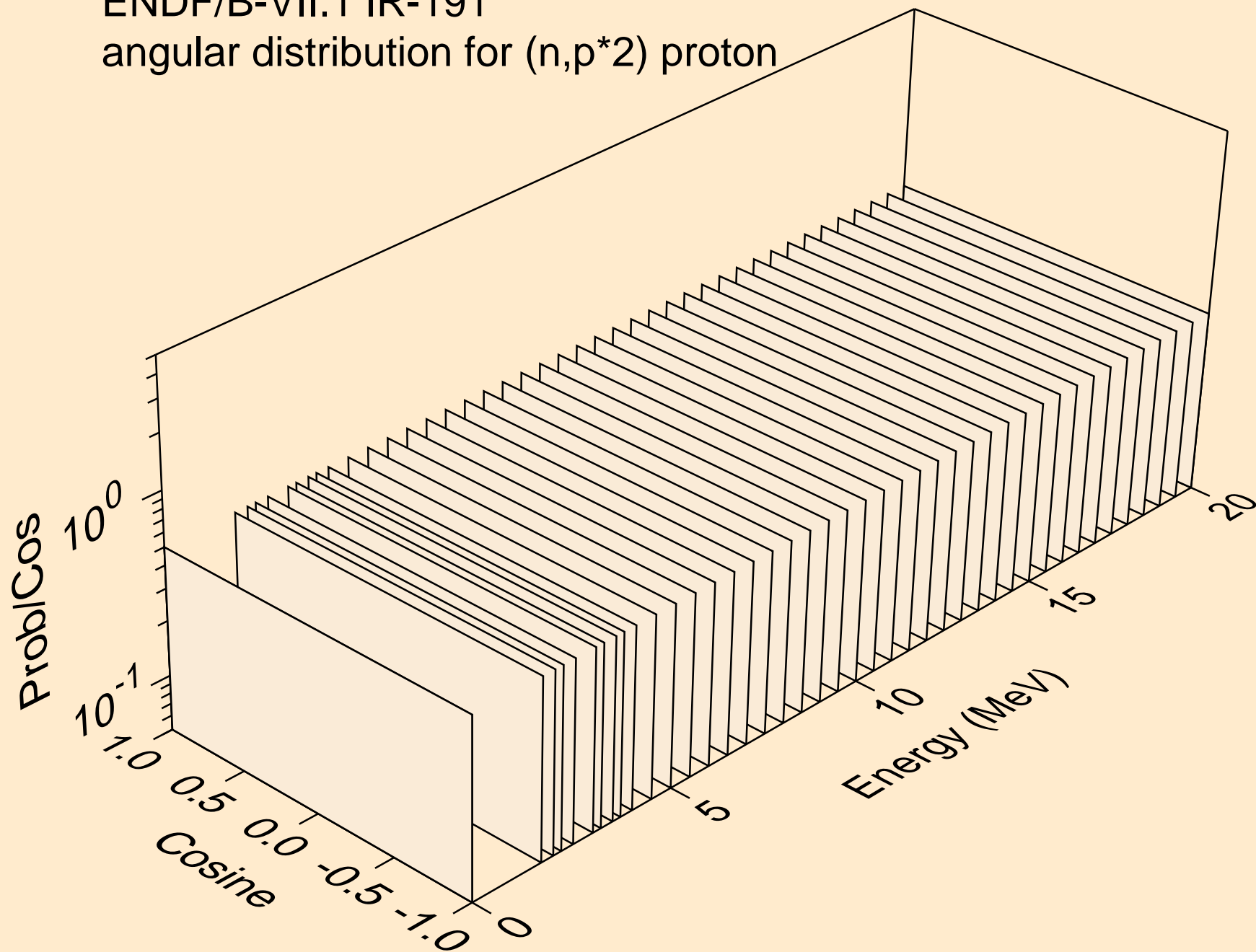

ENDF/B-VII.1 IR-191

angular distribution for (n,p*3) proton

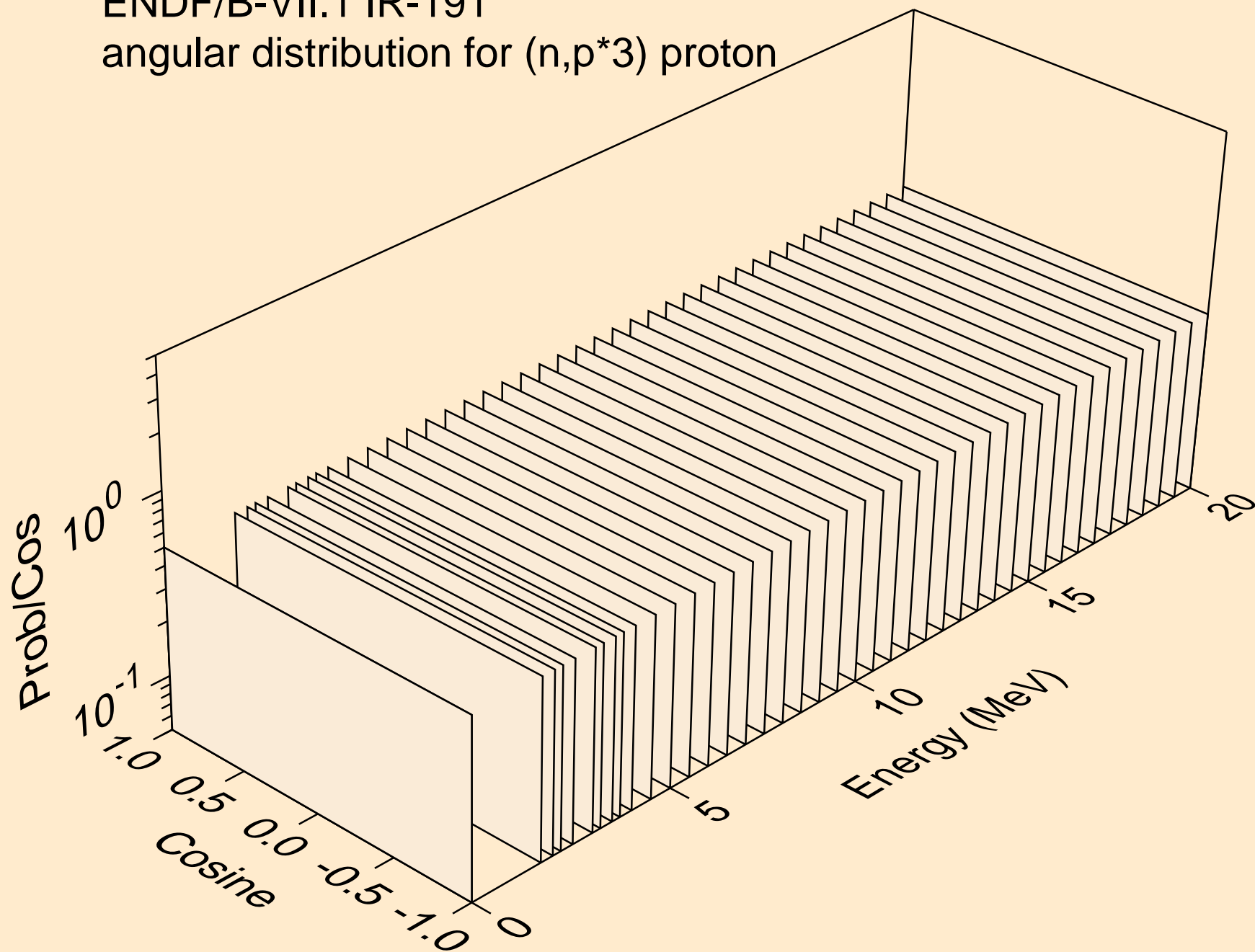

ENDF/B-VII.1 IR-191
angular distribution for (n,p*4) proton

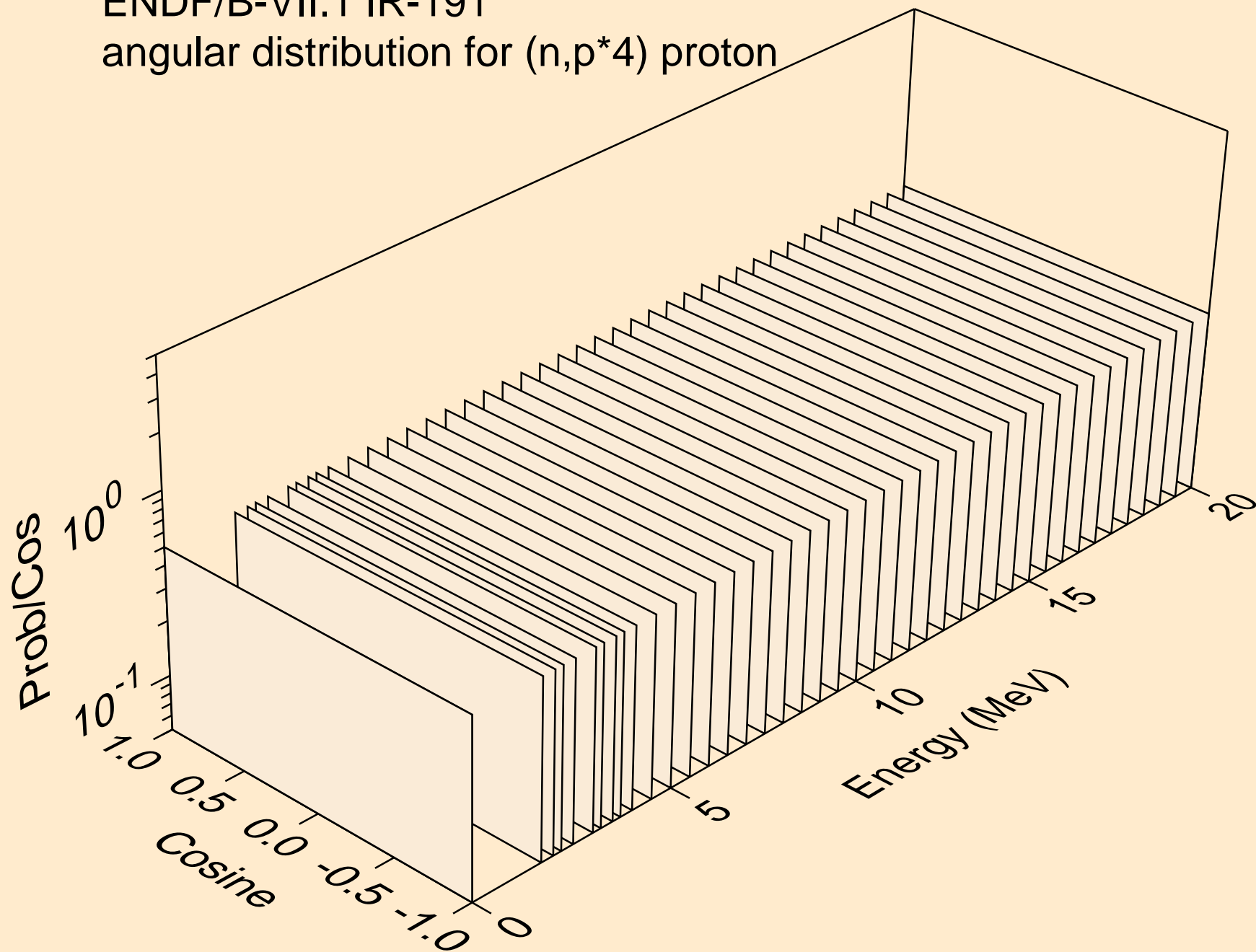

ENDF/B-VII.1 IR-191

angular distribution for (n,p*5) proton

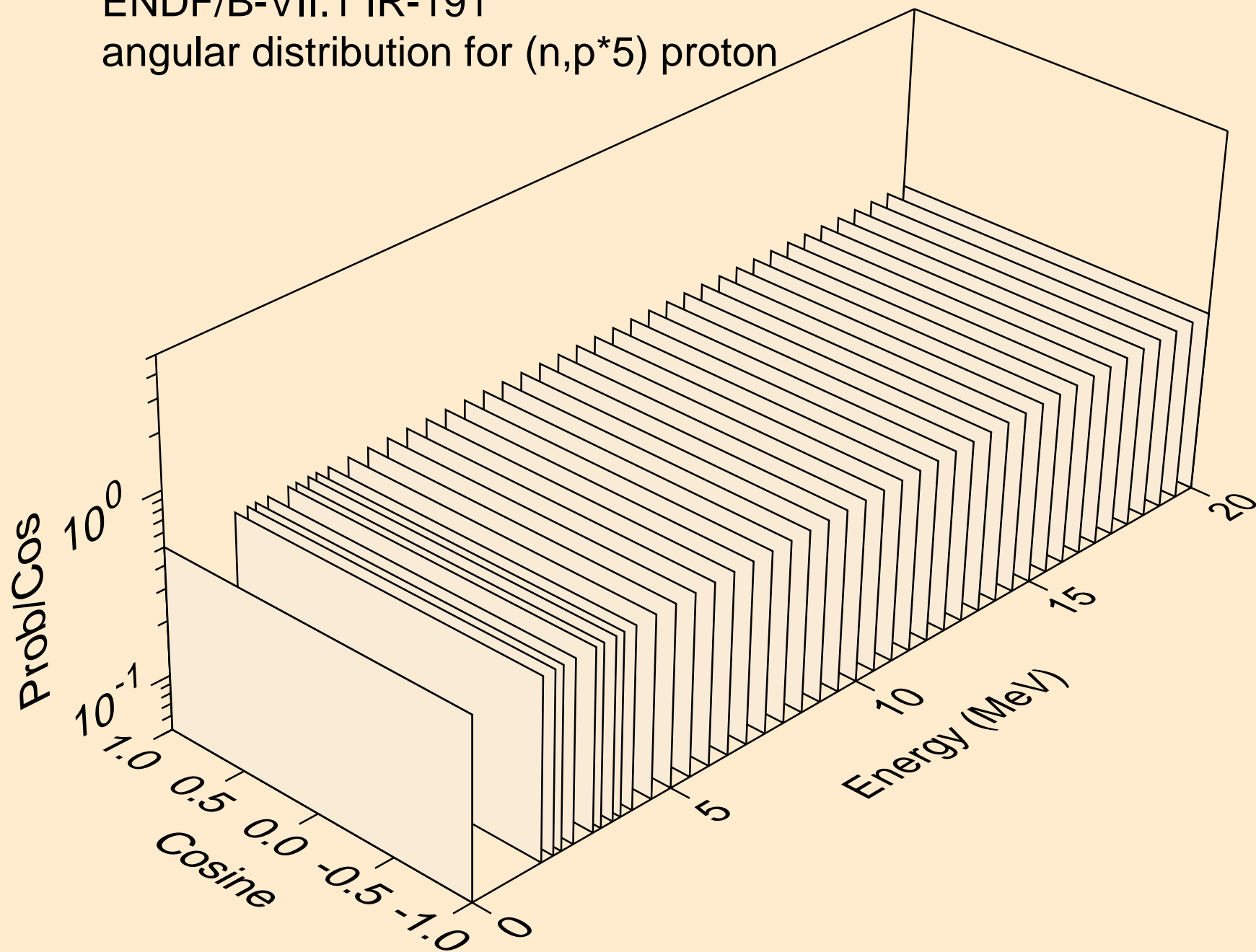

ENDF/B-VII.1 IR-191

angular distribution for (n,p*6) proton

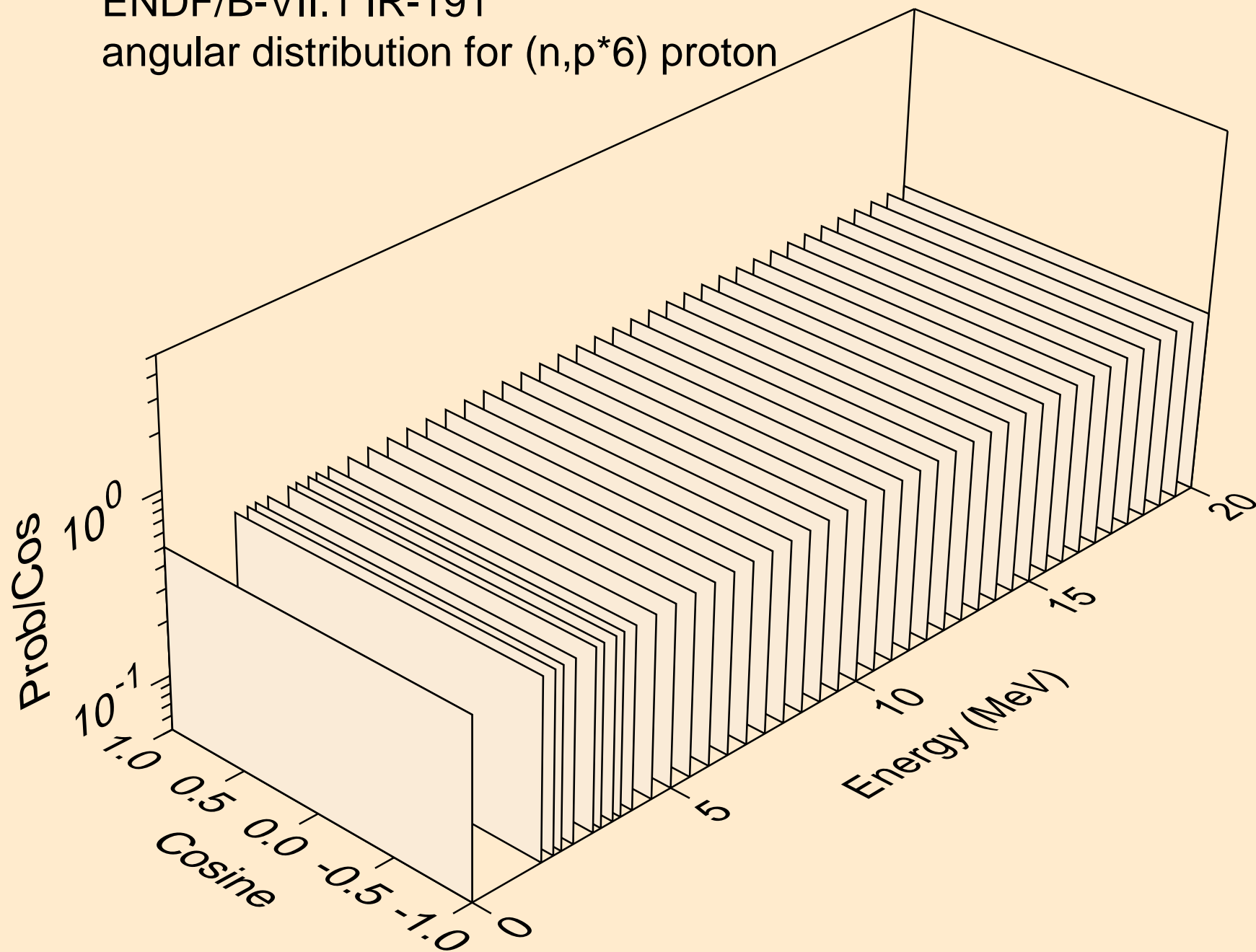

ENDF/B-VII.1 IR-191

angular distribution for (n,p*7) proton

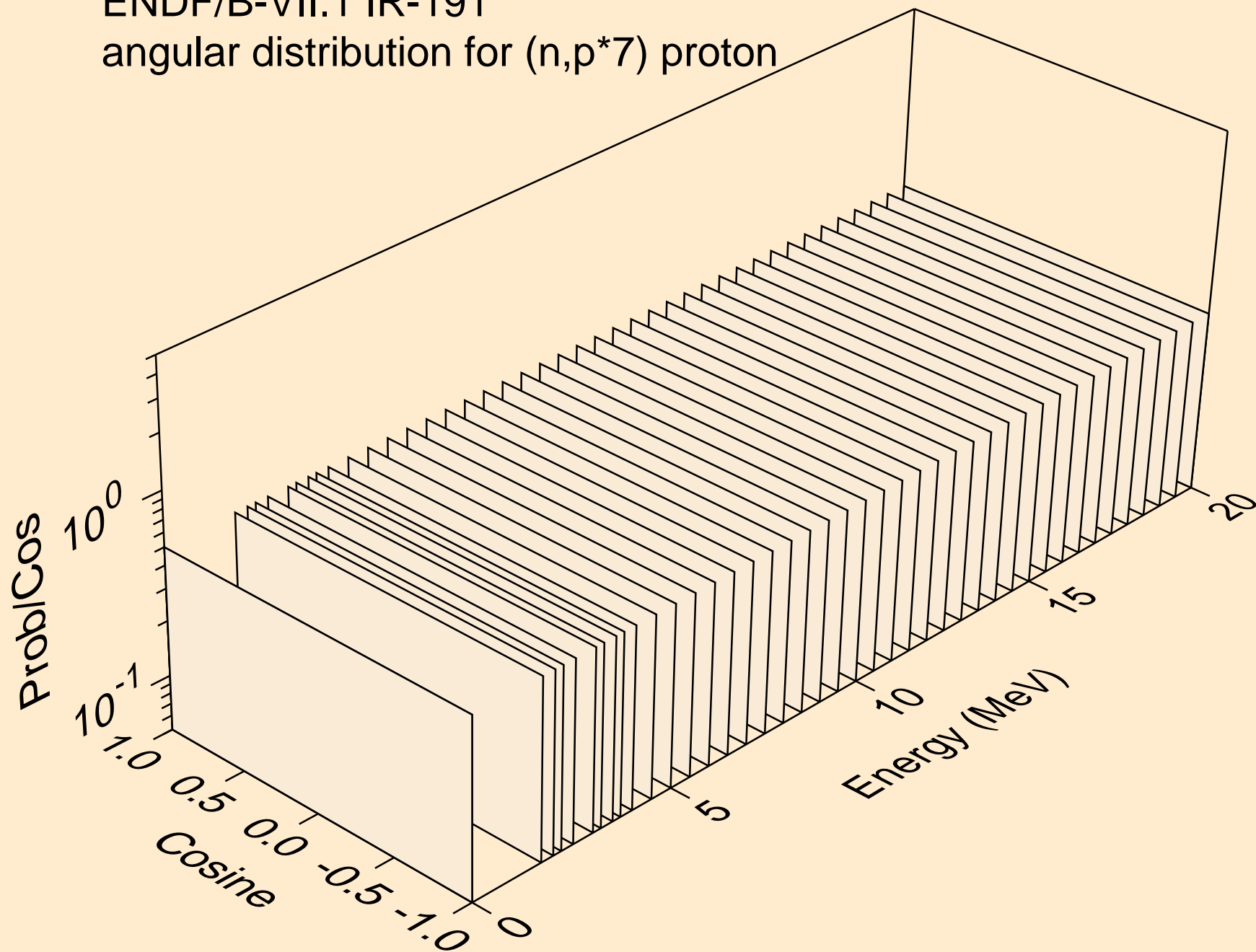

ENDF/B-VII.1 IR-191

angular distribution for (n,p*8) proton

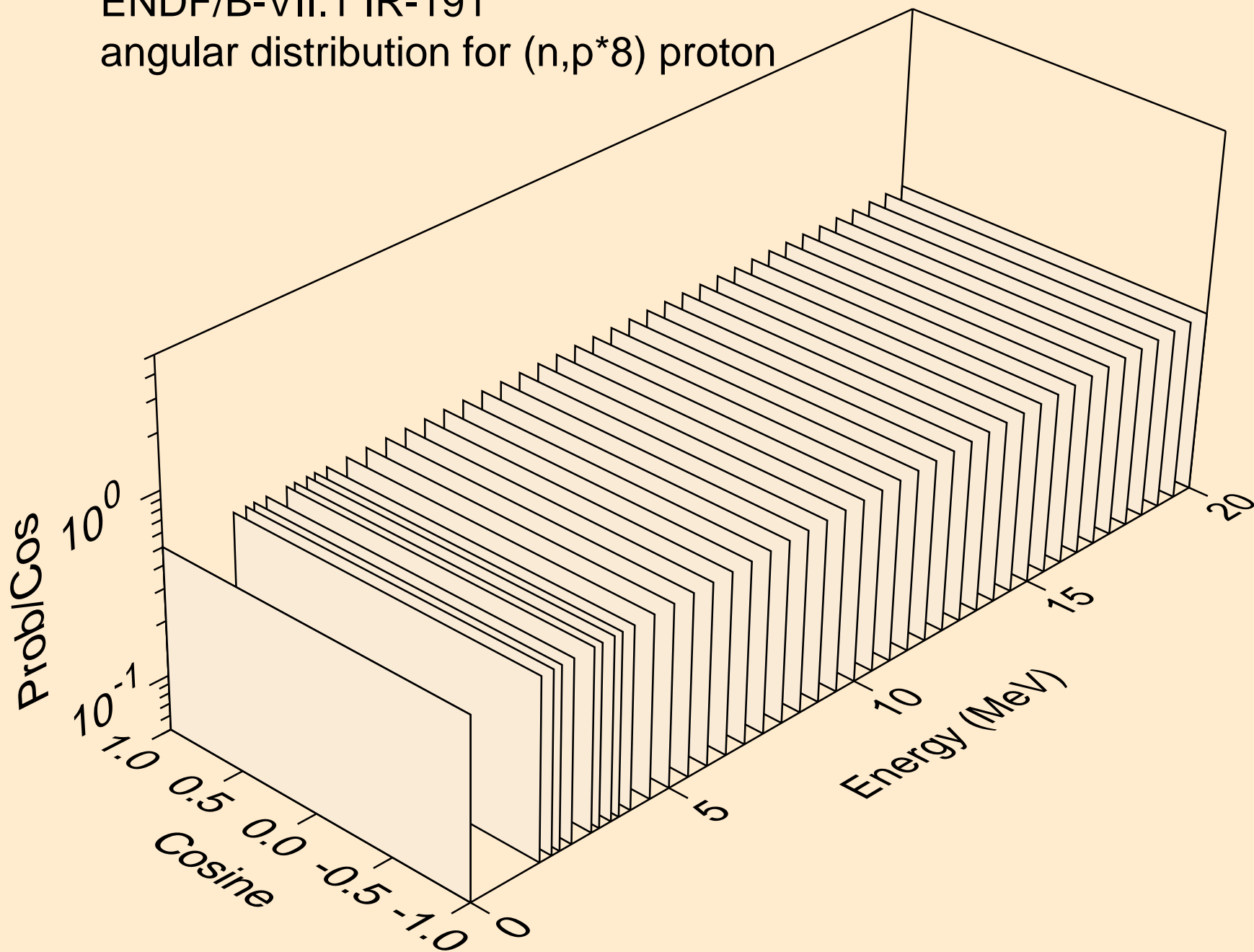

ENDF/B-VII.1 IR-191

angular distribution for (n,p*9) proton

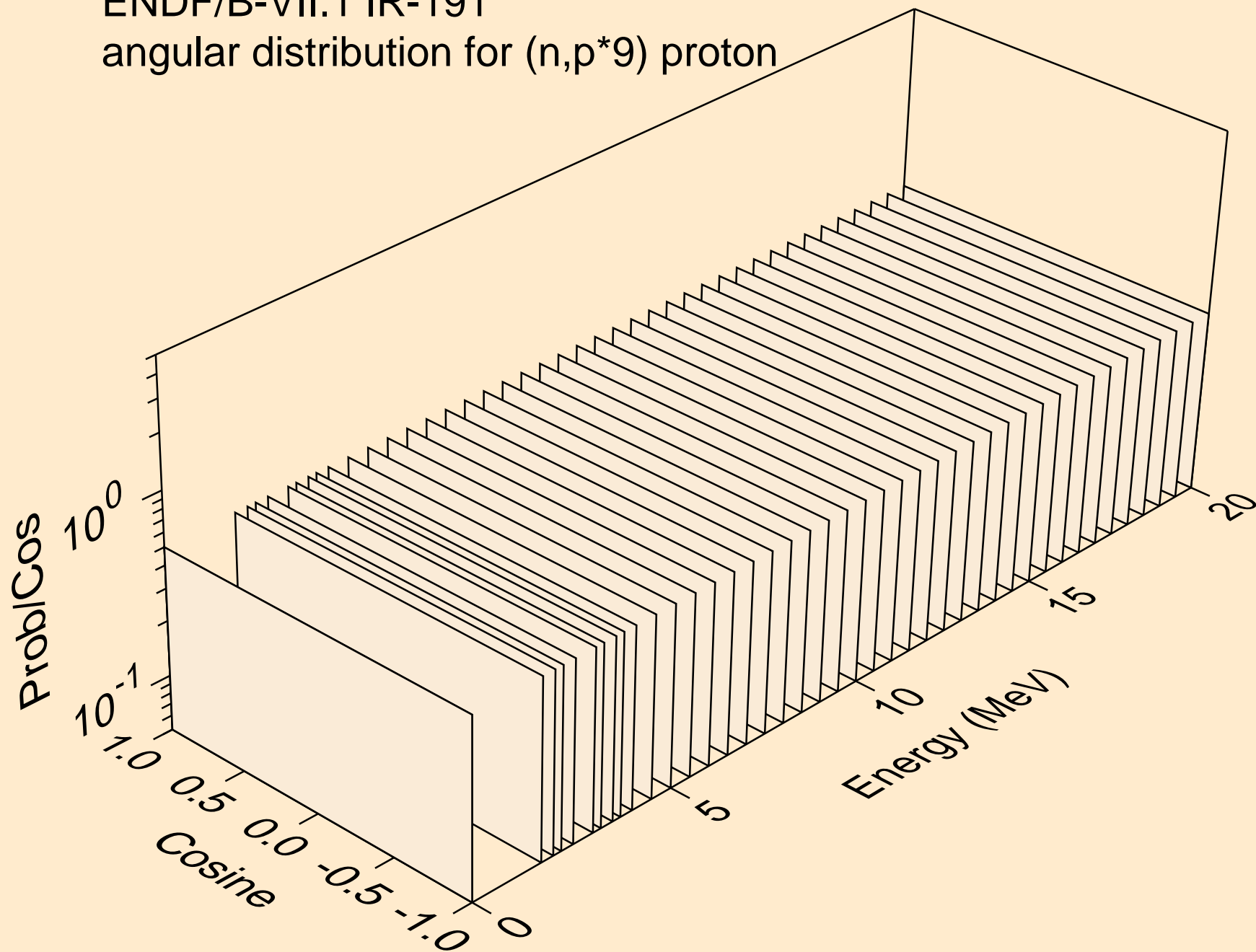

ENDF/B-VII.1 IR-191

angular distribution for (n,p*10) proton

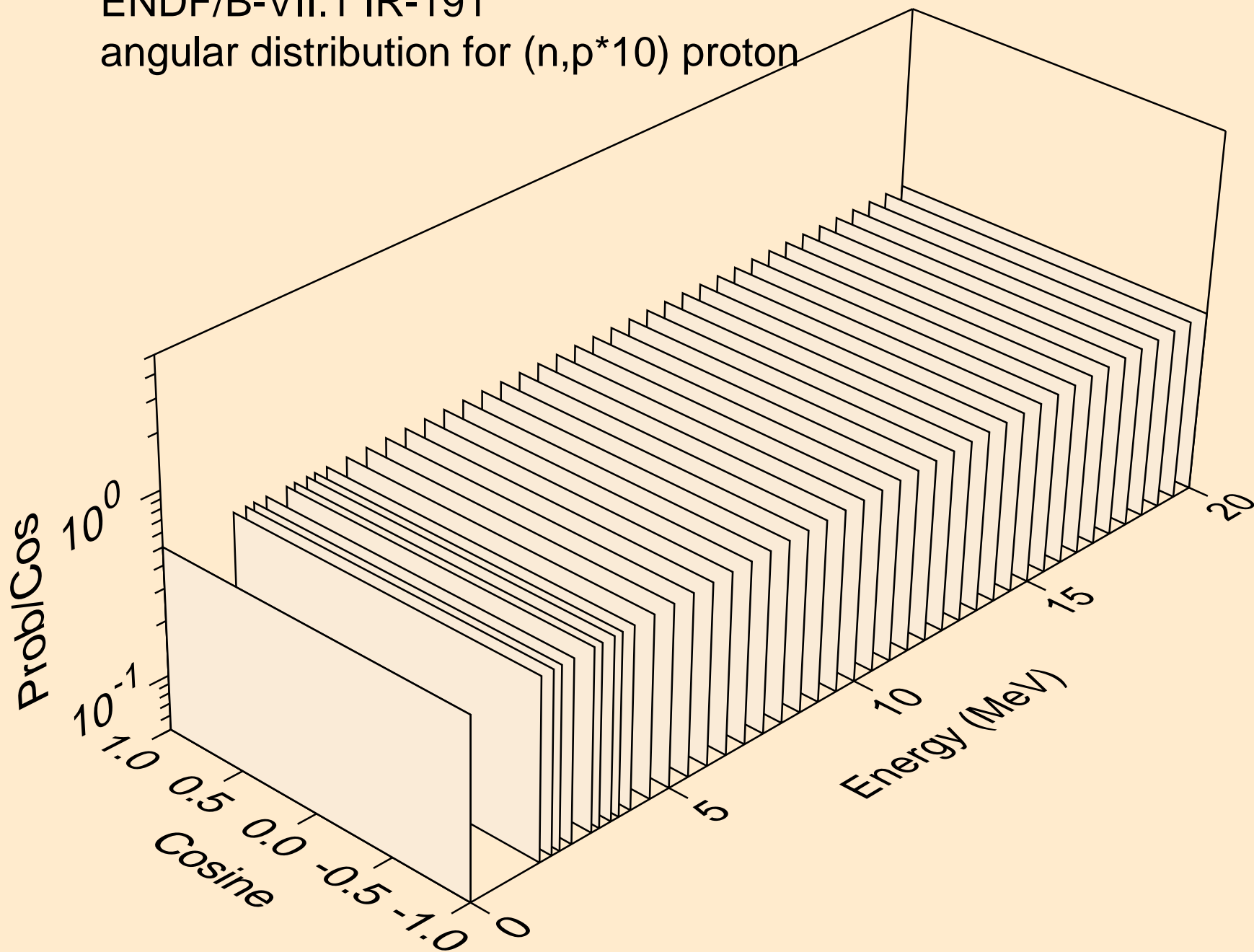

ENDF/B-VII.1 IR-191
angular distribution for (n,p*11) proton

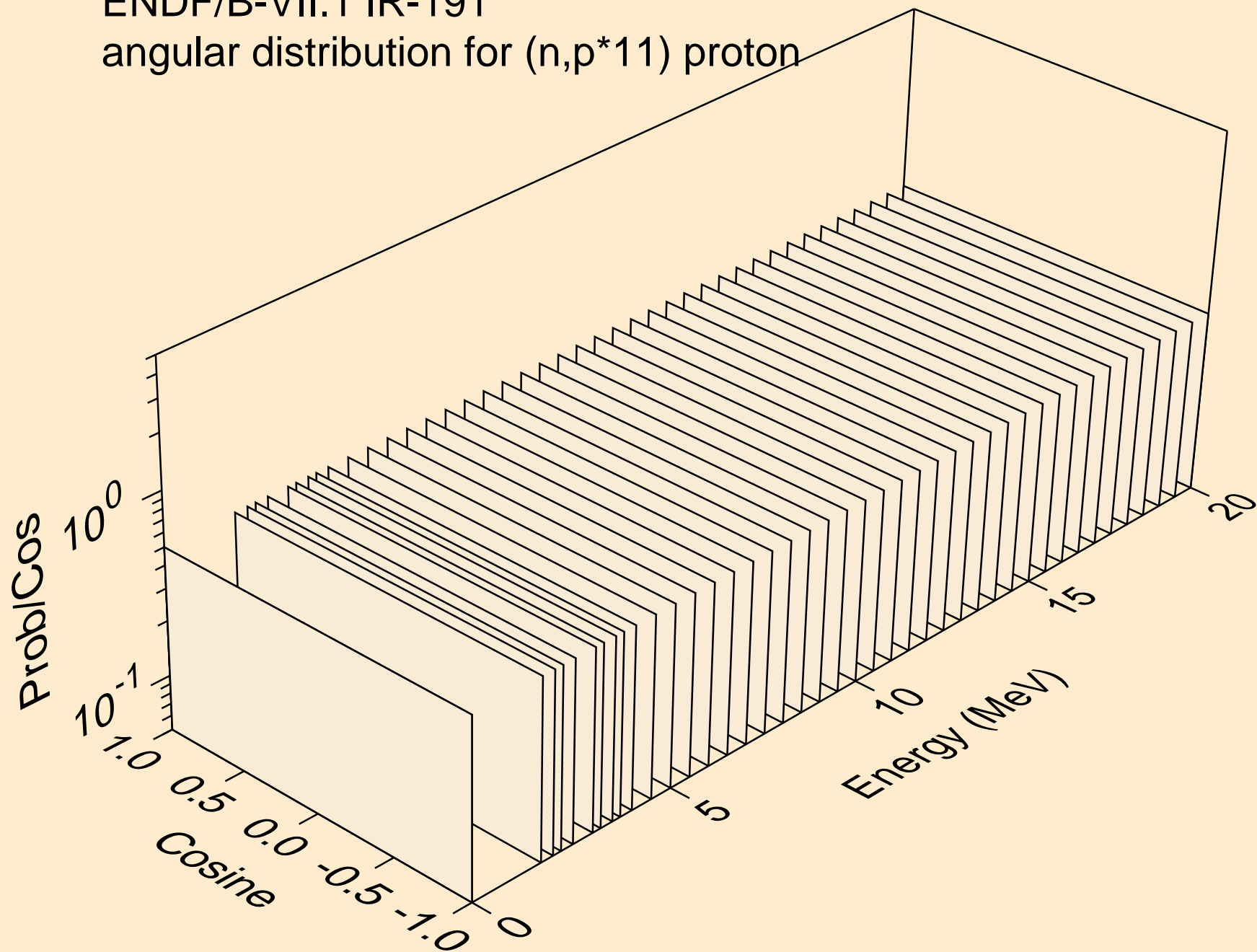

ENDF/B-VII.1 IR-191
angular distribution for (n,p*12) proton

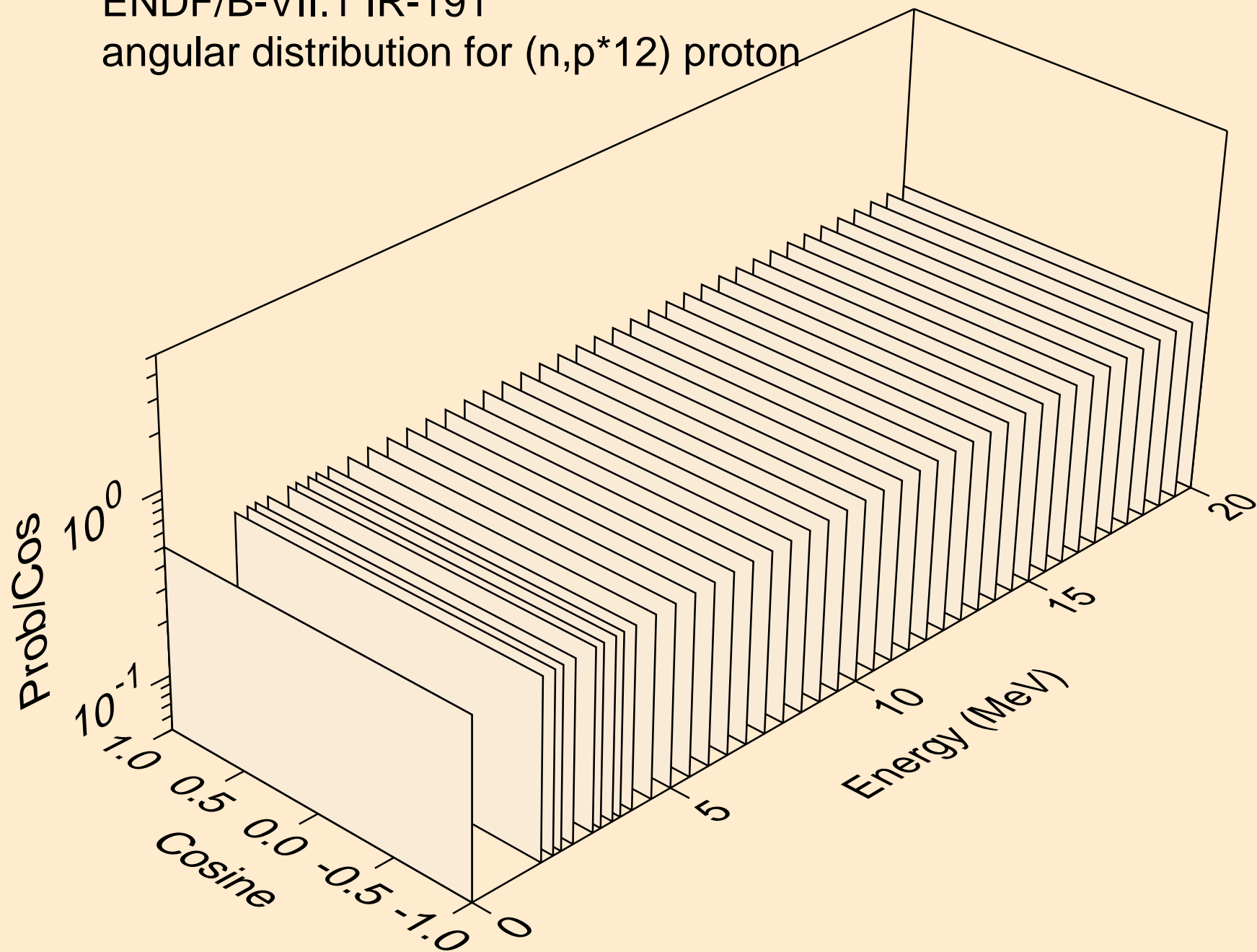

ENDF/B-VII.1 IR-191
angular distribution for (n,p*13) proton

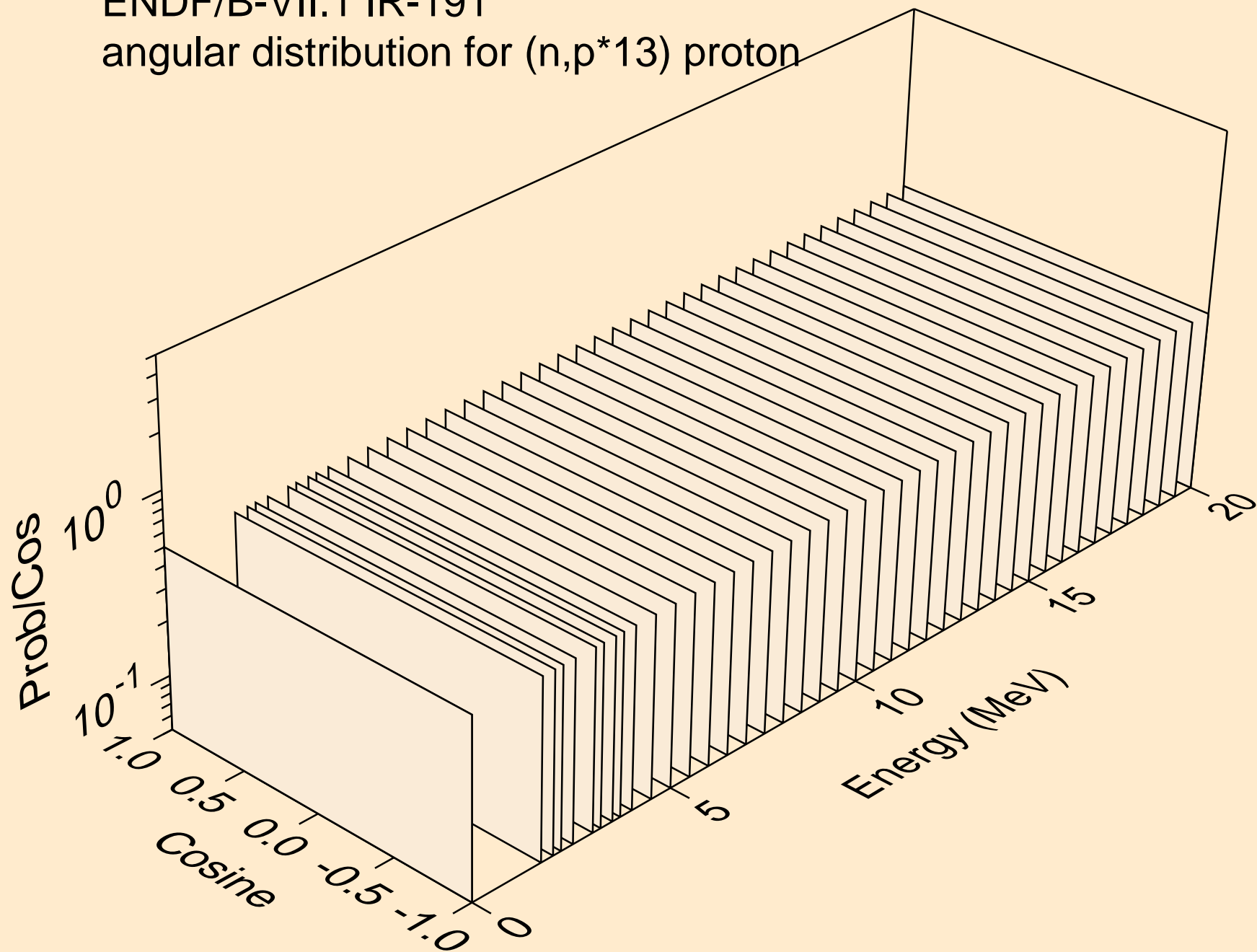

ENDF/B-VII.1 IR-191
angular distribution for (n,p*14) proton

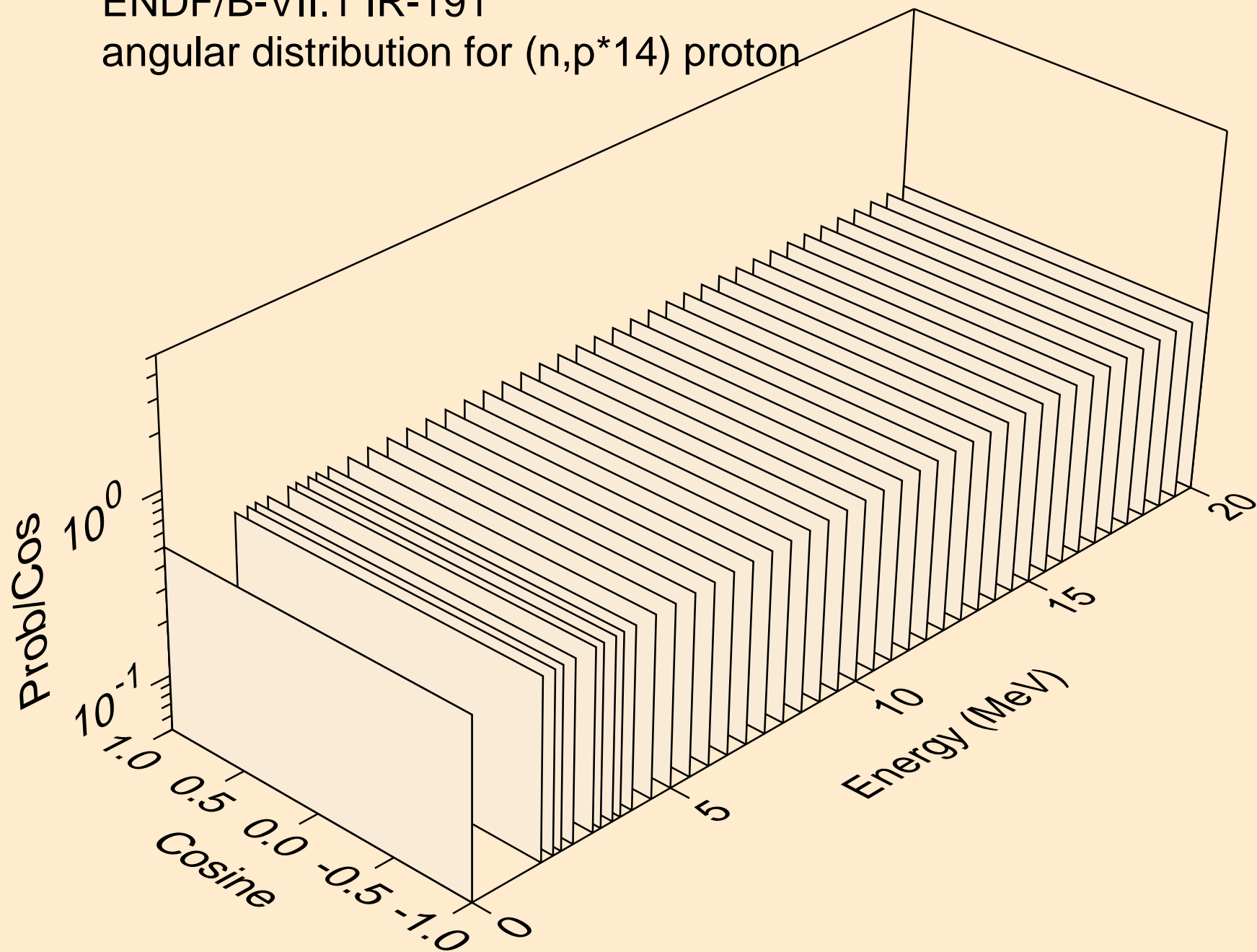

ENDF/B-VII.1 IR-191
angular distribution for (n,p*15) proton

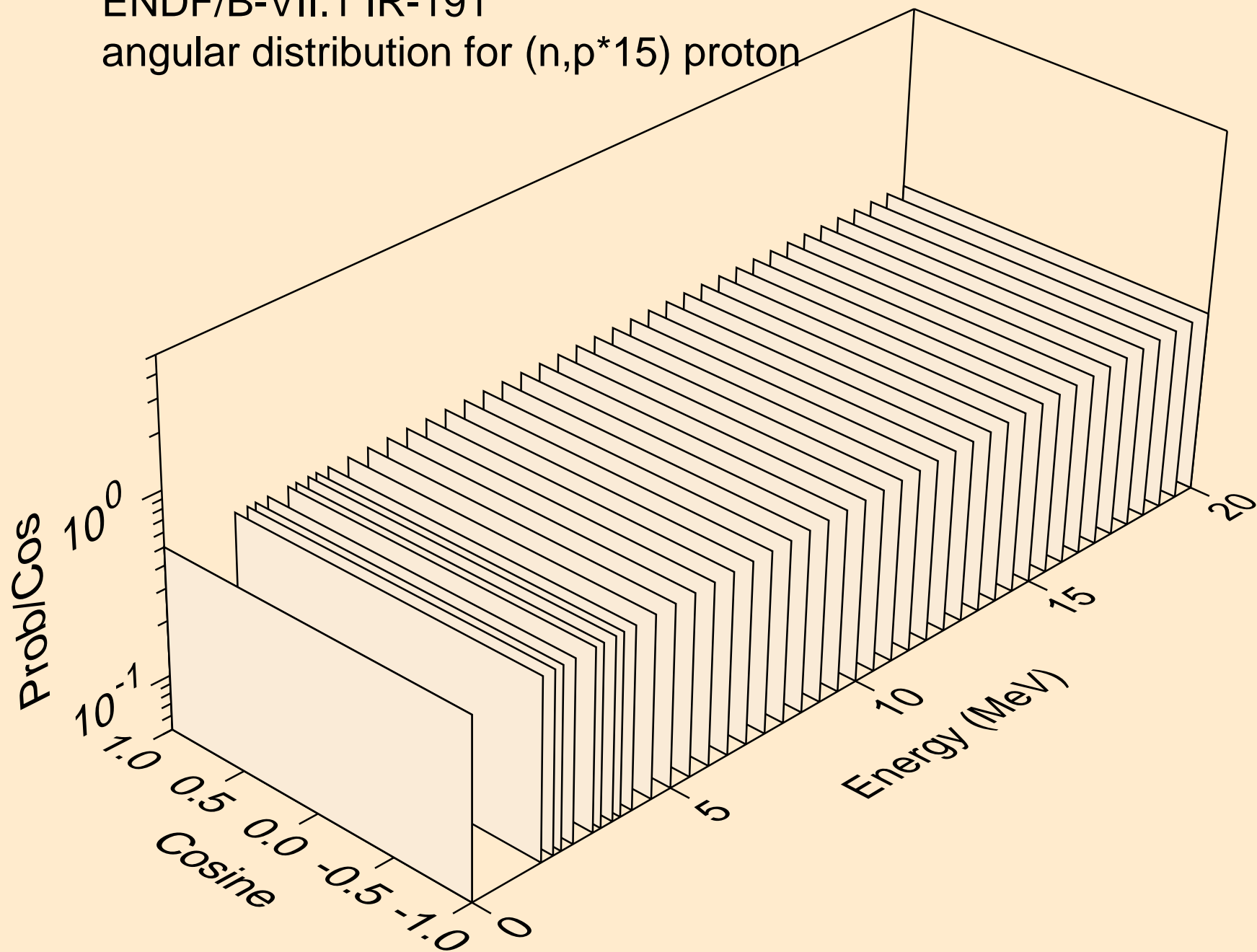

ENDF/B-VII.1 IR-191
angular distribution for (n,p*16) proton

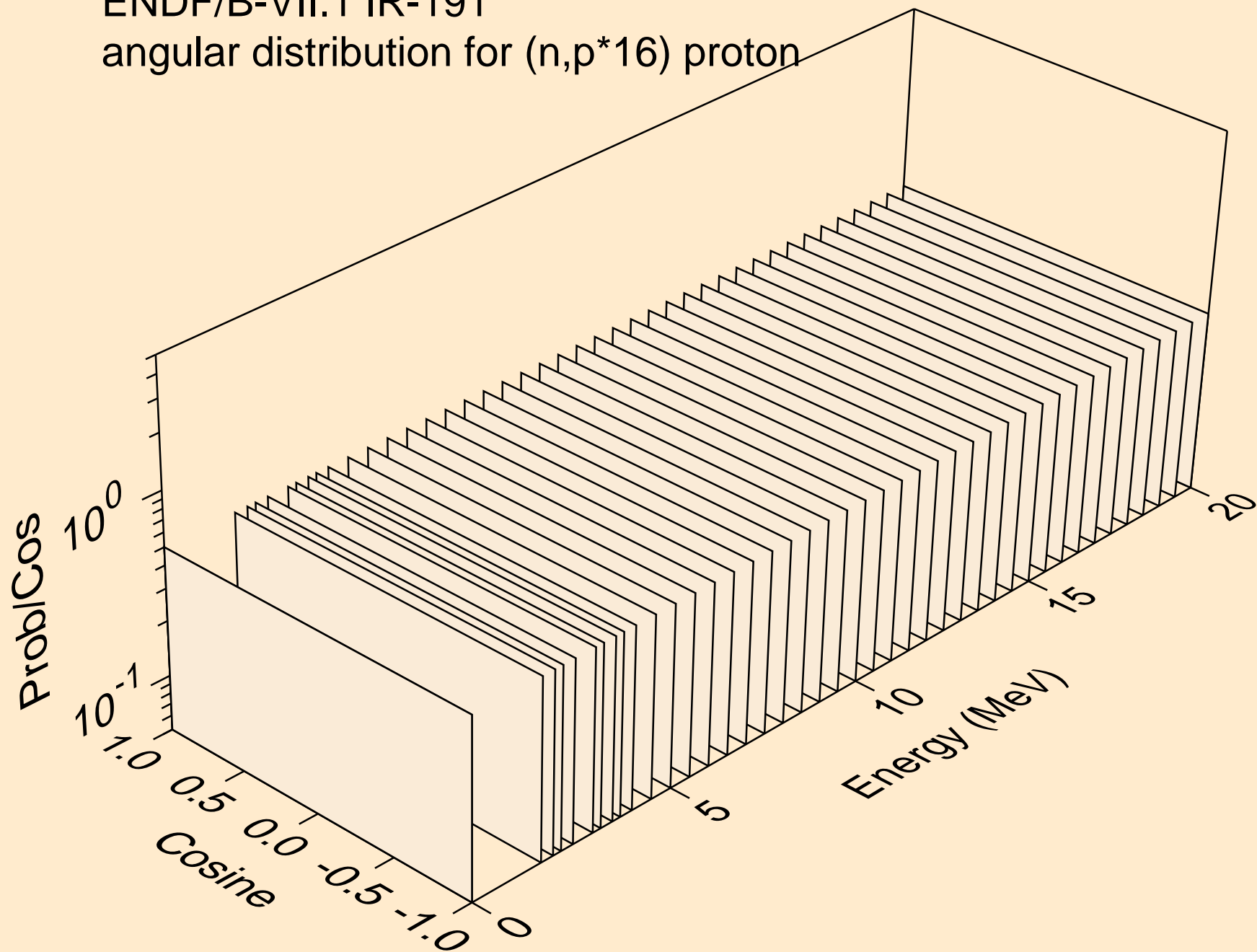

ENDF/B-VII.1 IR-191
angular distribution for (n,p*17) proton

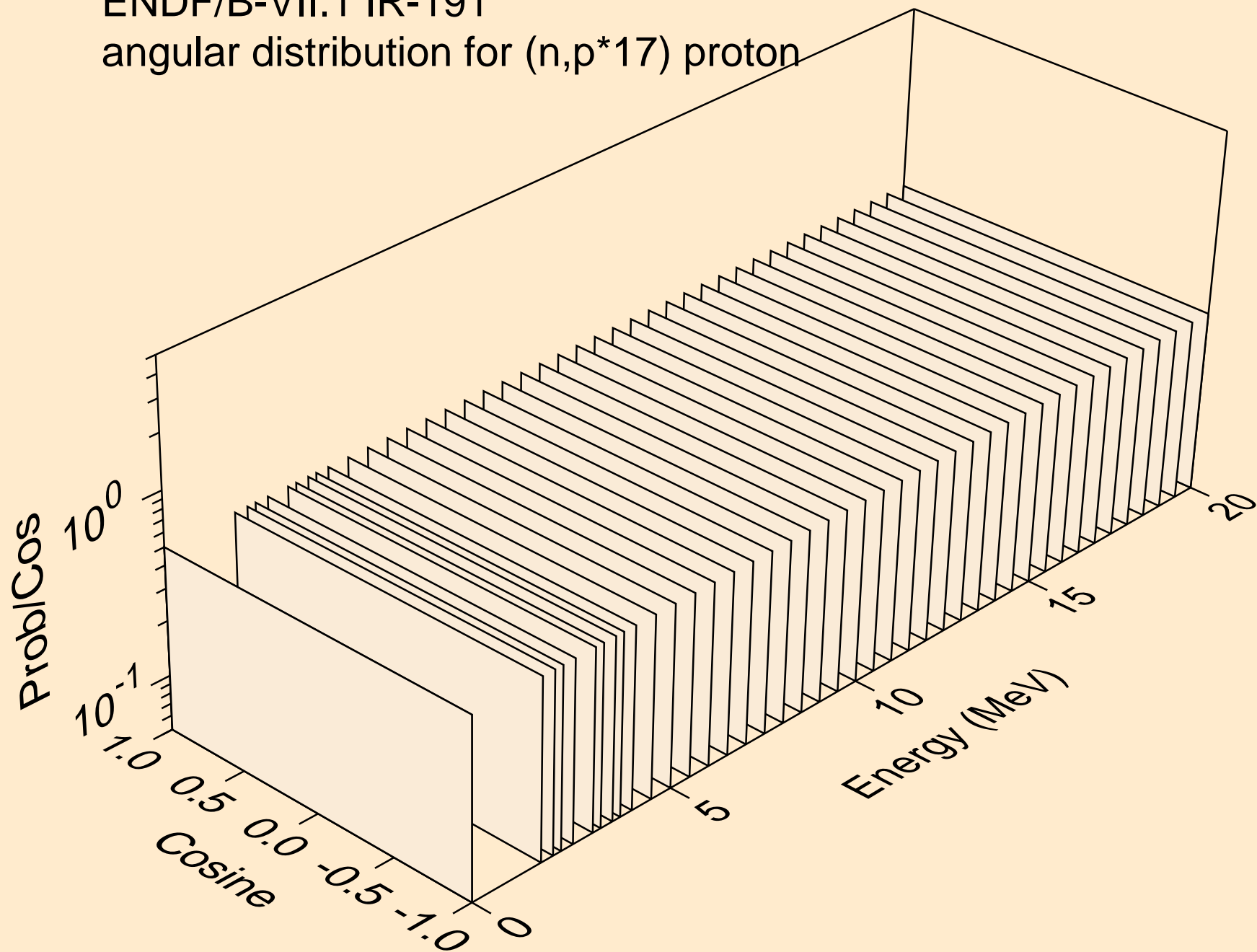

ENDF/B-VII.1 IR-191
angular distribution for (n,p*18) proton

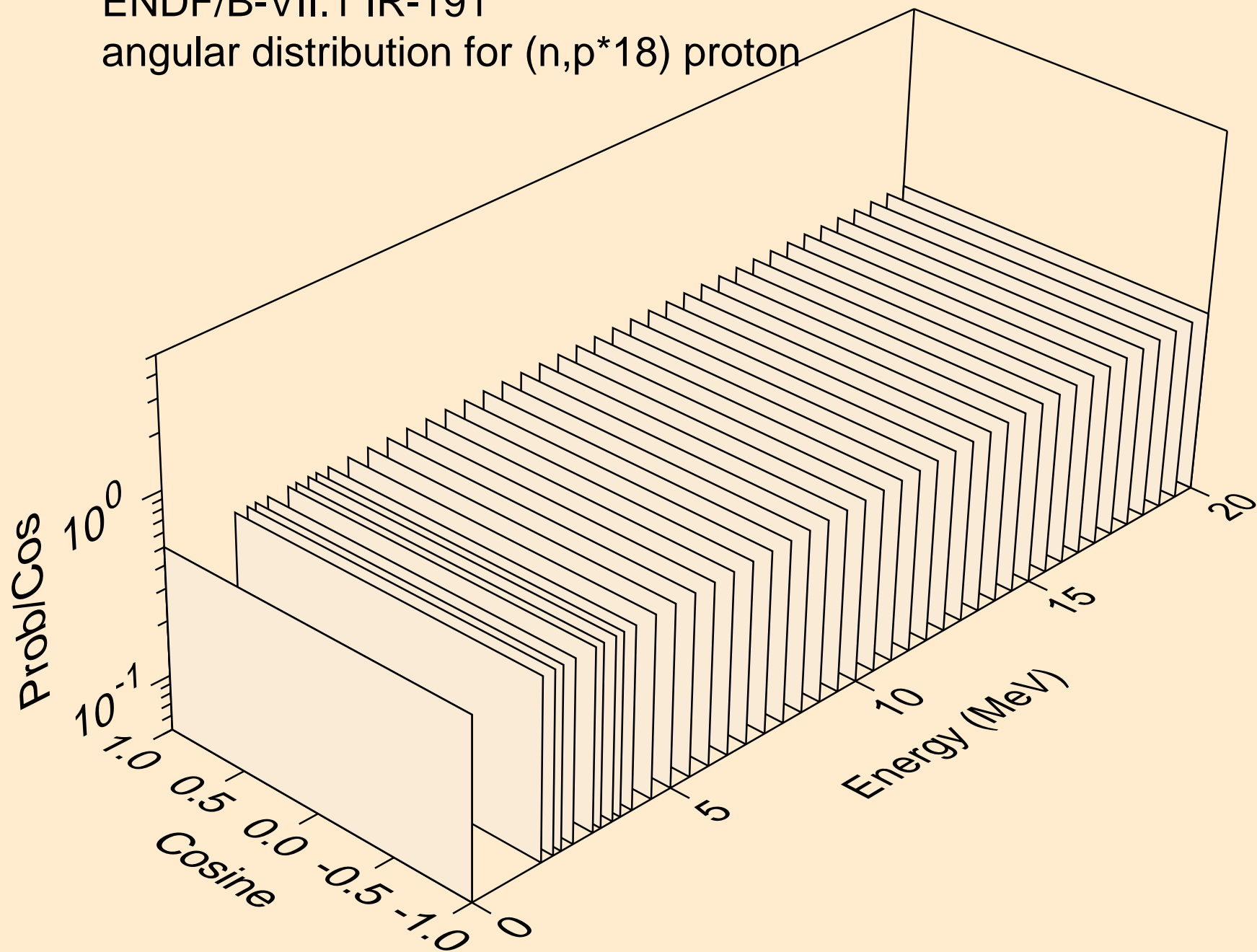

ENDF/B-VII.1 IR-191
angular distribution for (n,p*19) proton

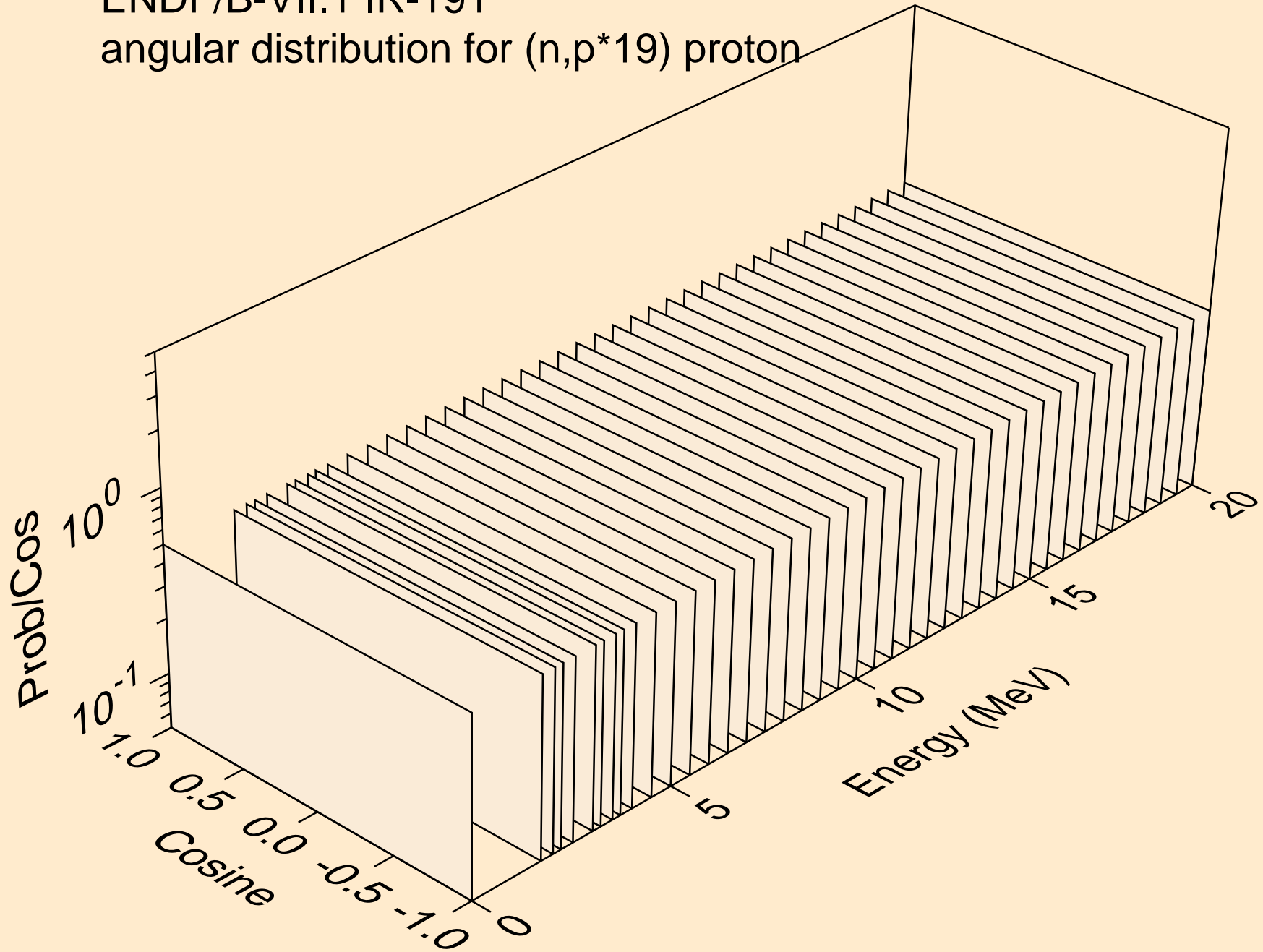

ENDF/B-VII.1 IR-191

angular distribution for (n,p*20) proton

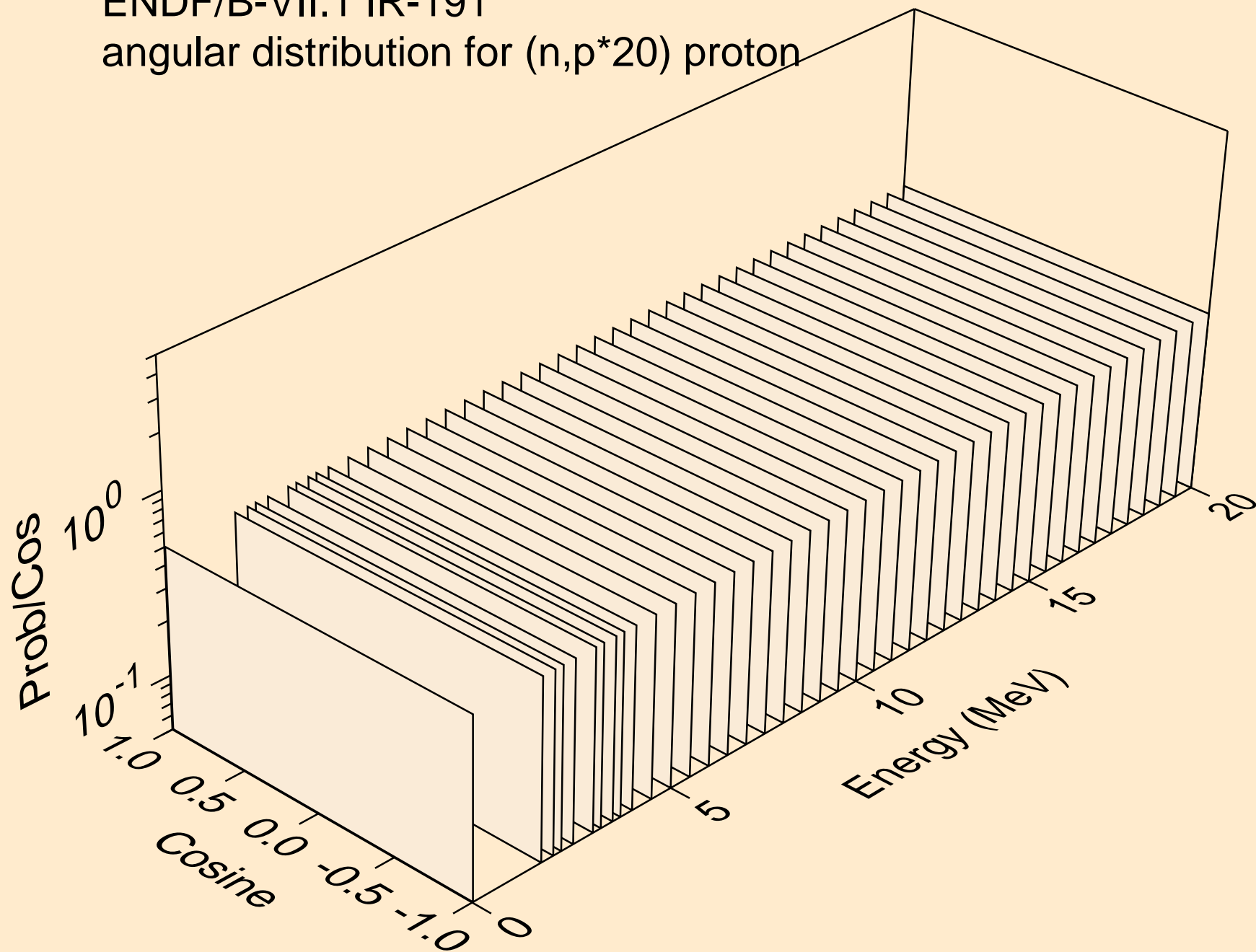

ENDF/B-VII.1 IR-191

angular distribution for (n,p*21) proton

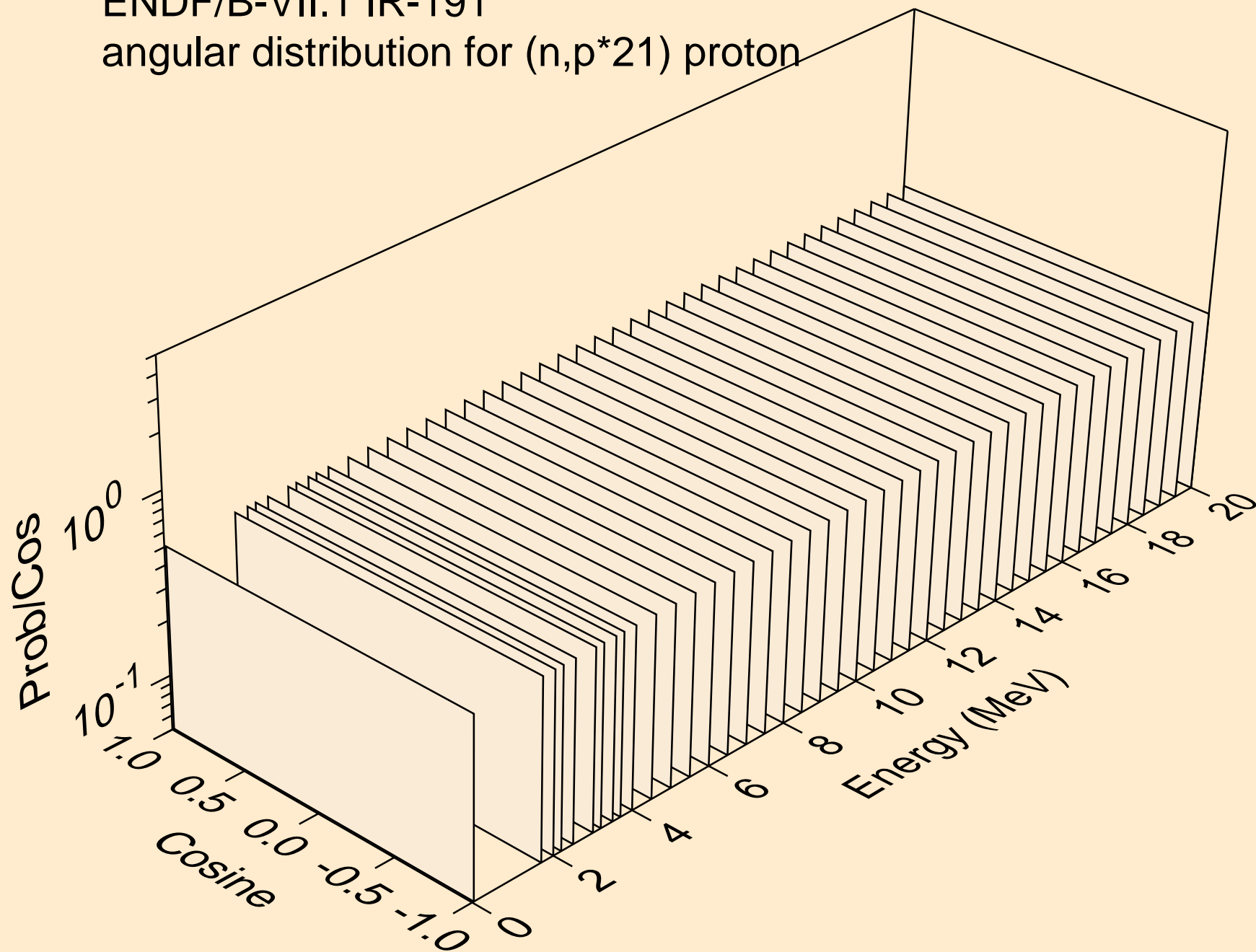

ENDF/B-VII.1 IR-191

angular distribution for (n,p*22) proton

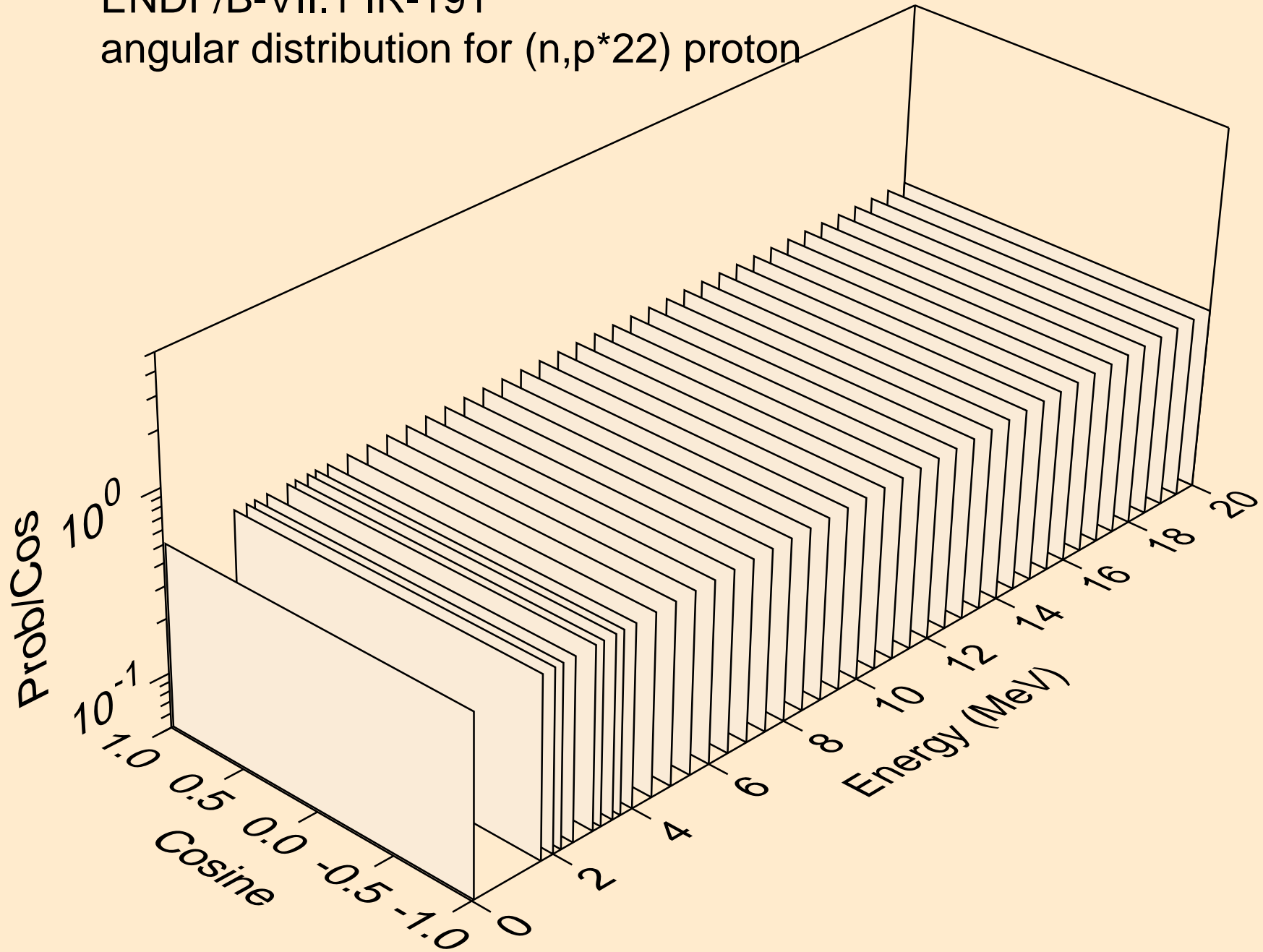

ENDF/B-VII.1 IR-191
angular distribution for (n,p*23) proton

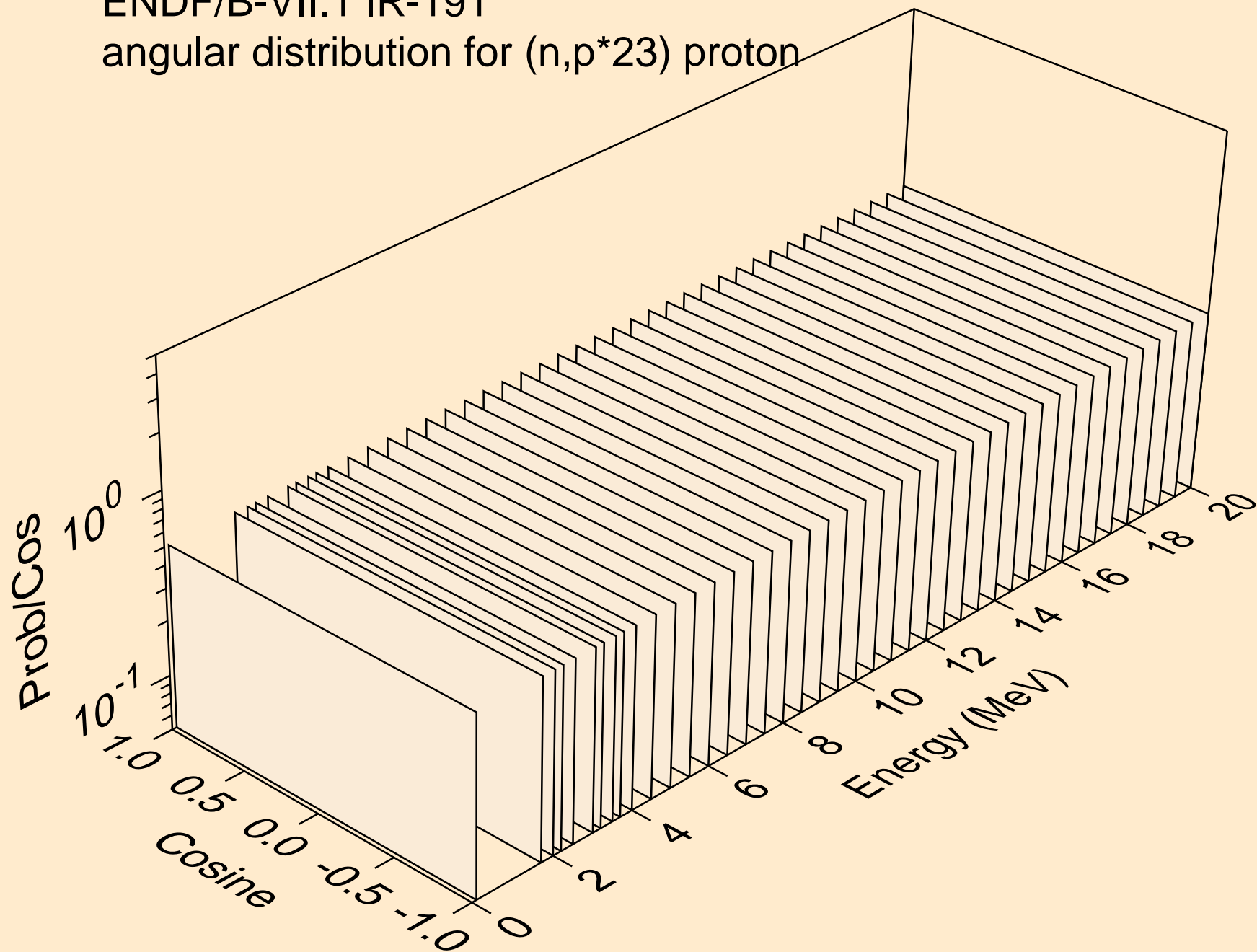

ENDF/B-VII.1 IR-191

angular distribution for (n,p*24) proton

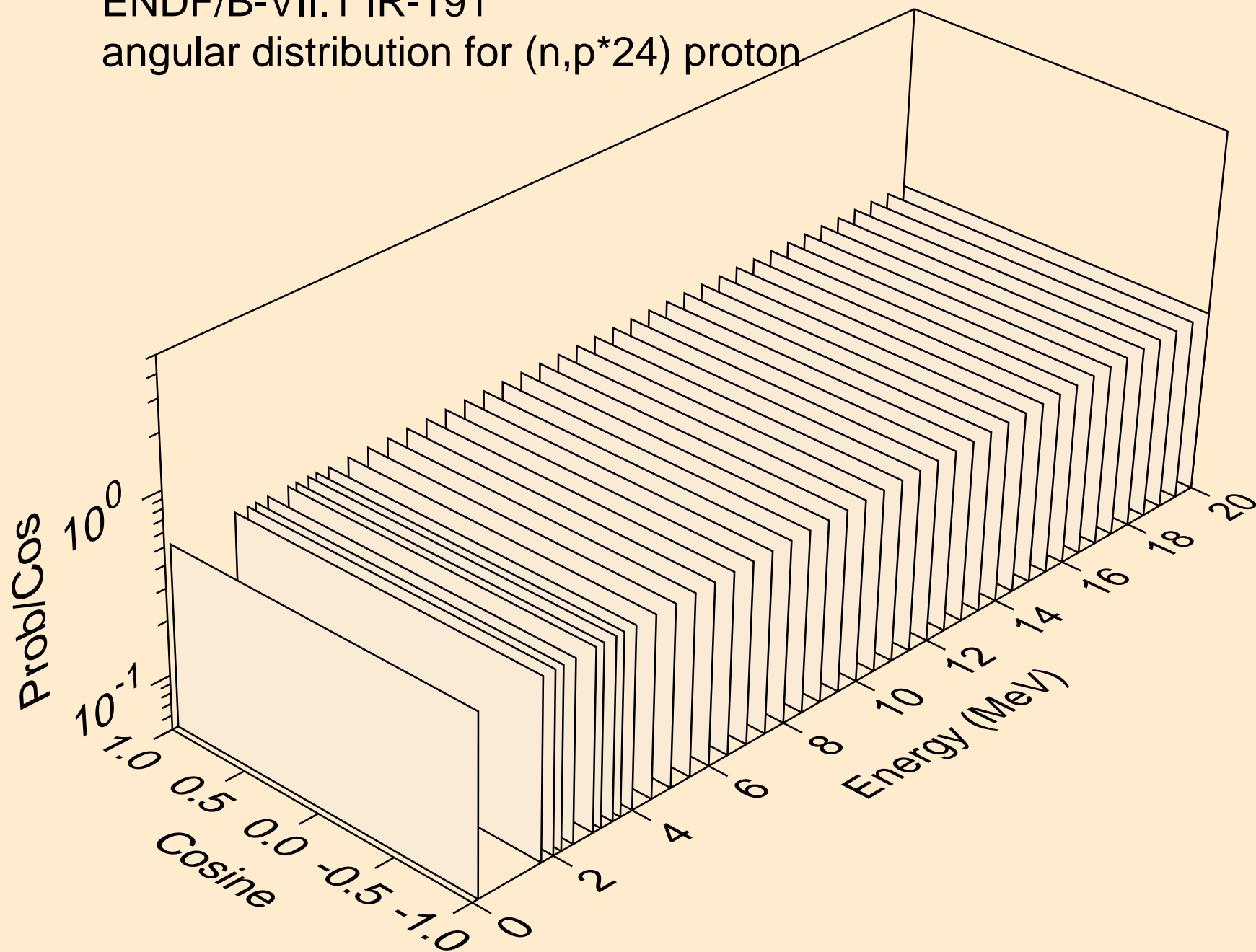

ENDF/B-VII.1 IR-191
angular distribution for (n,p*25) proton

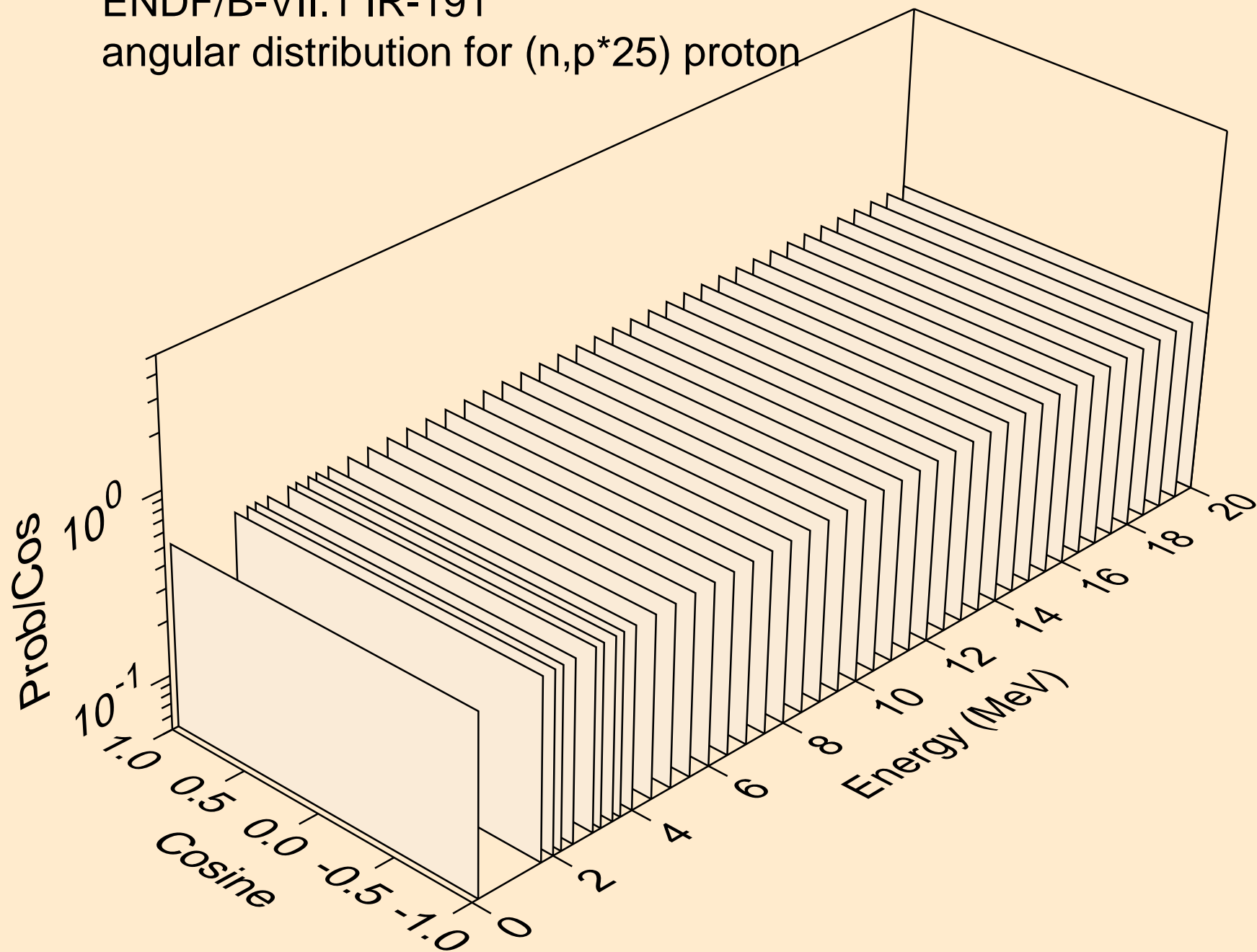

ENDF/B-VII.1 IR-191
angular distribution for (n,p*26) proton

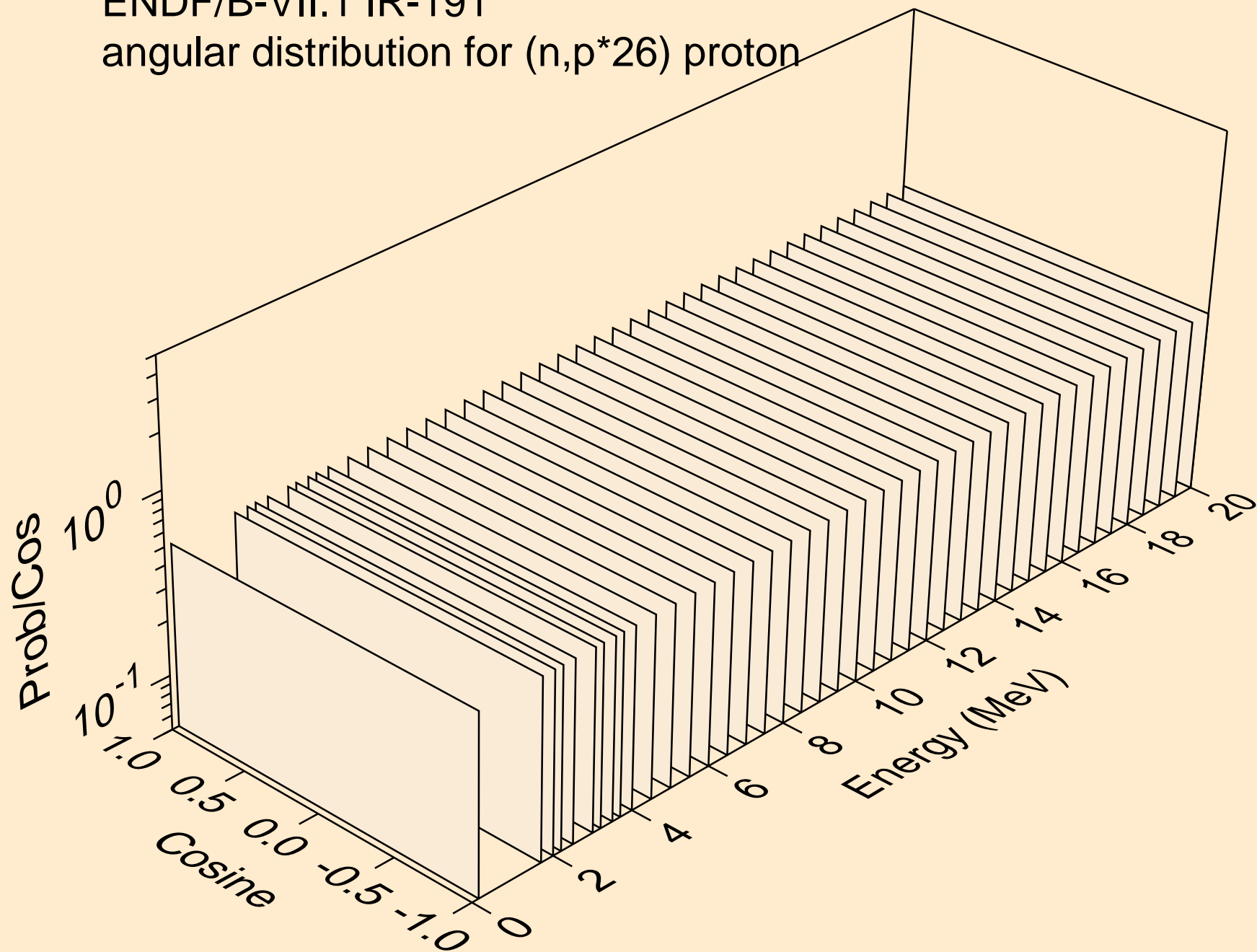

ENDF/B-VII.1 IR-191
angular distribution for (n,p*27) proton

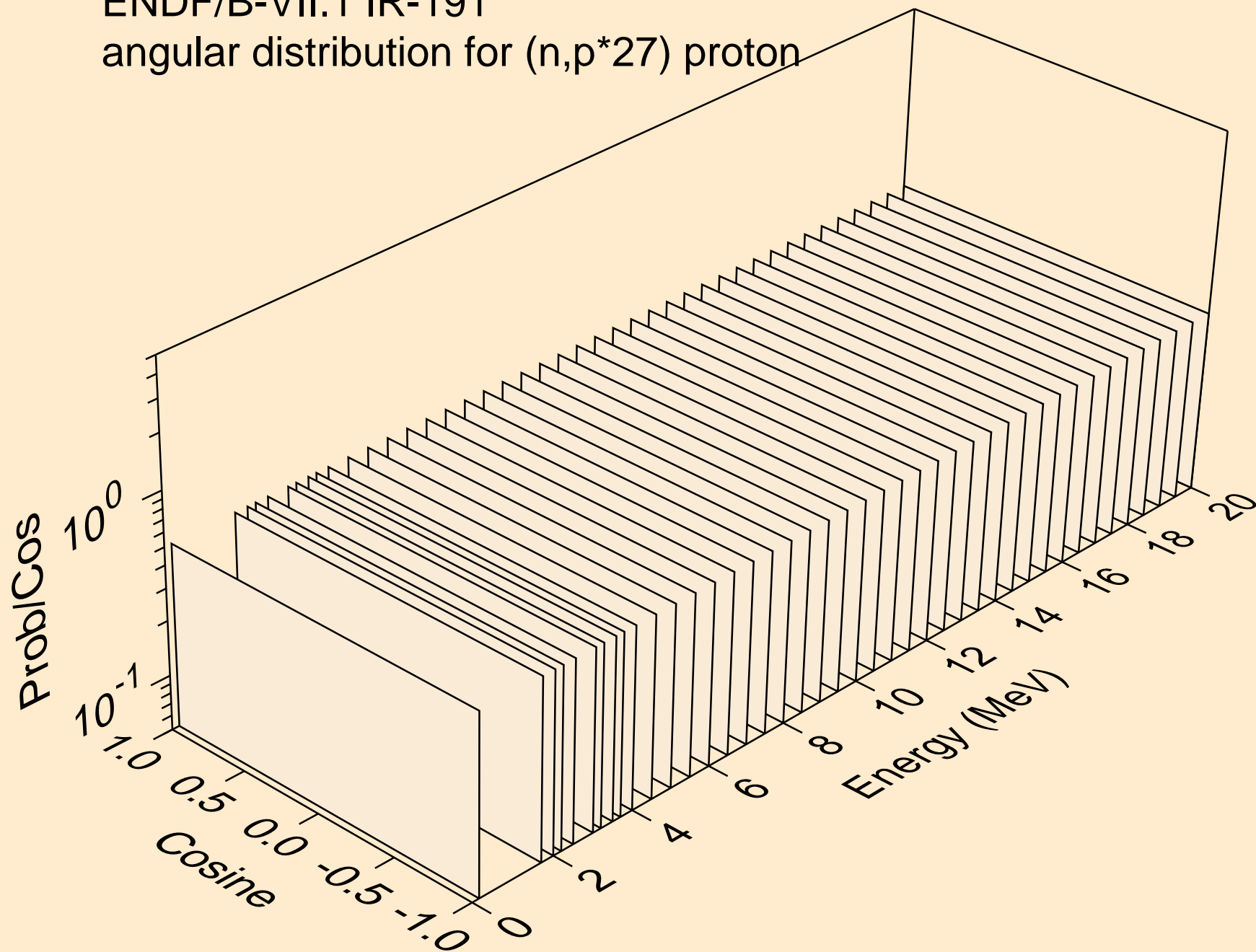

ENDF/B-VII.1 IR-191

angular distribution for (n,p*28) proton

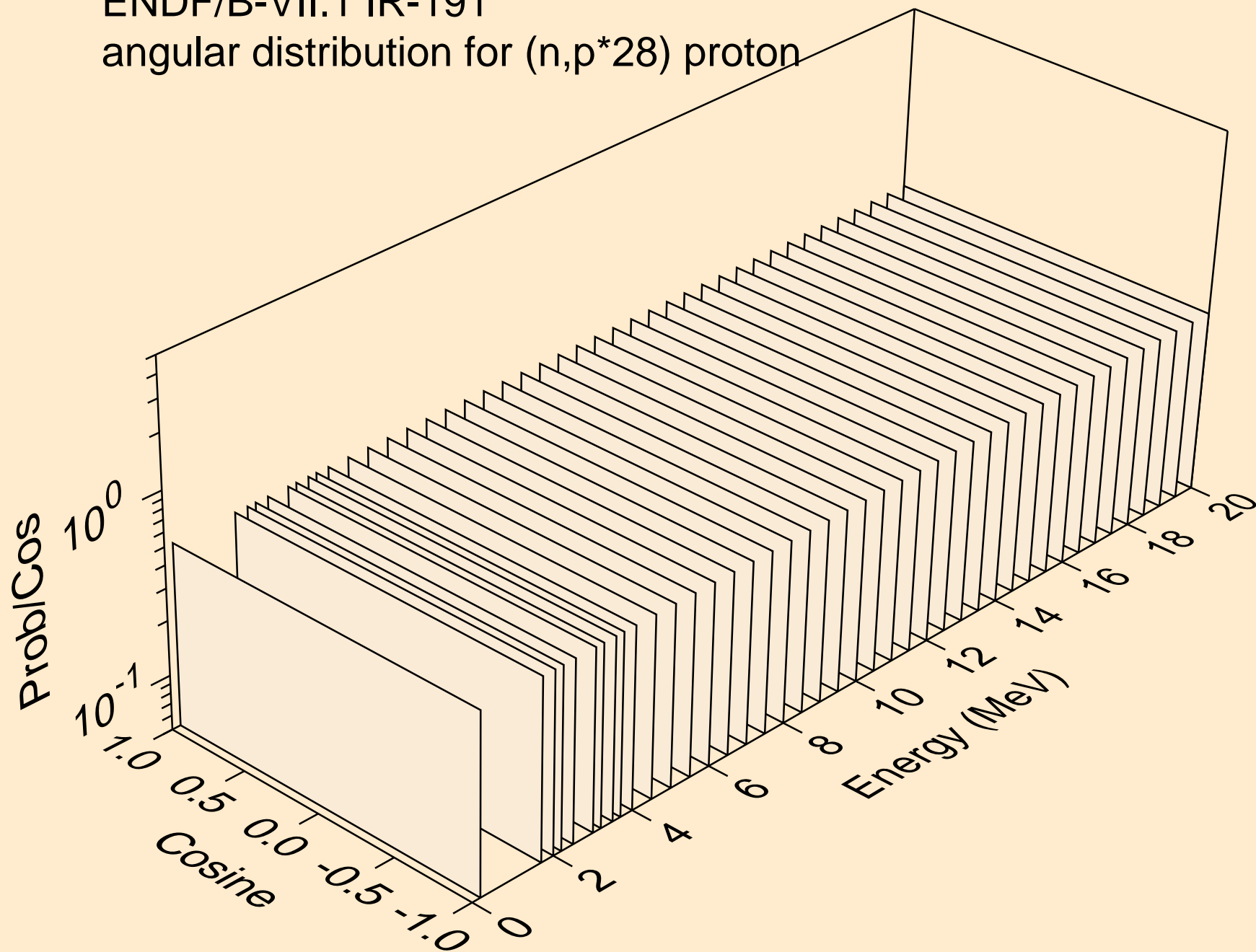

ENDF/B-VII.1 IR-191
angular distribution for (n,p*29) proton

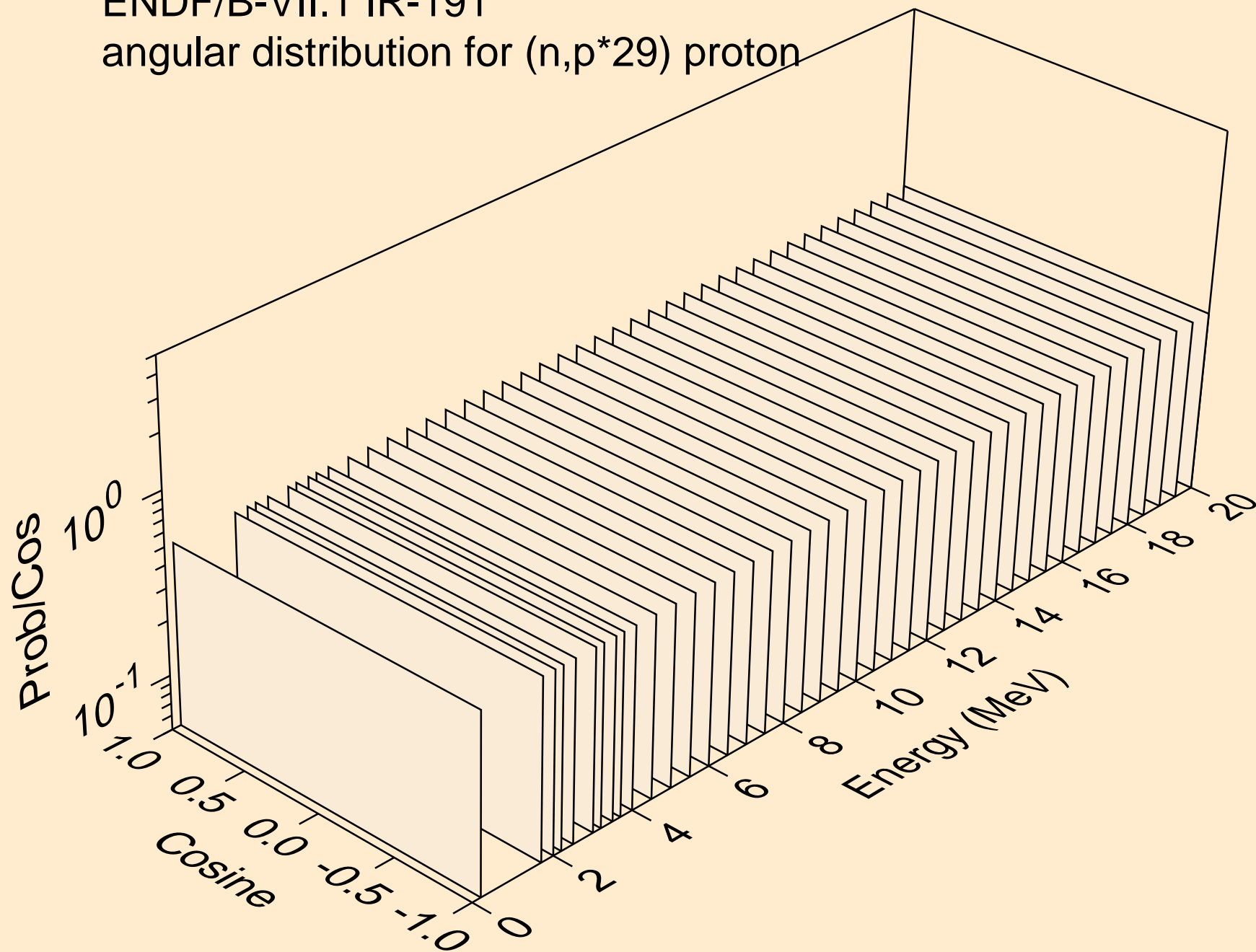

ENDF/B-VII.1 IR-191
angular distribution for (n,p*30) proton

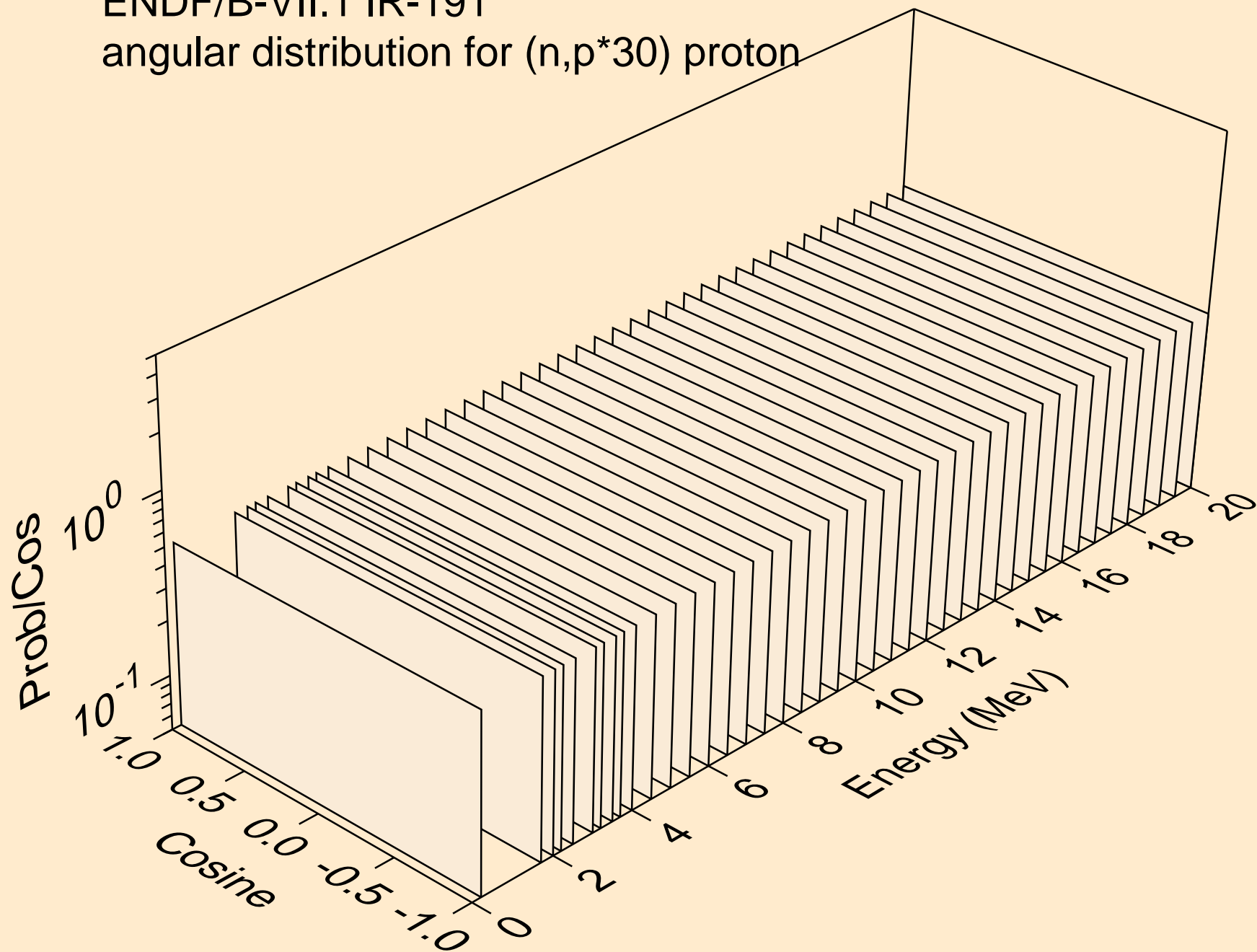

ENDF/B-VII.1 IR-191
angular distribution for (n,p*31) proton

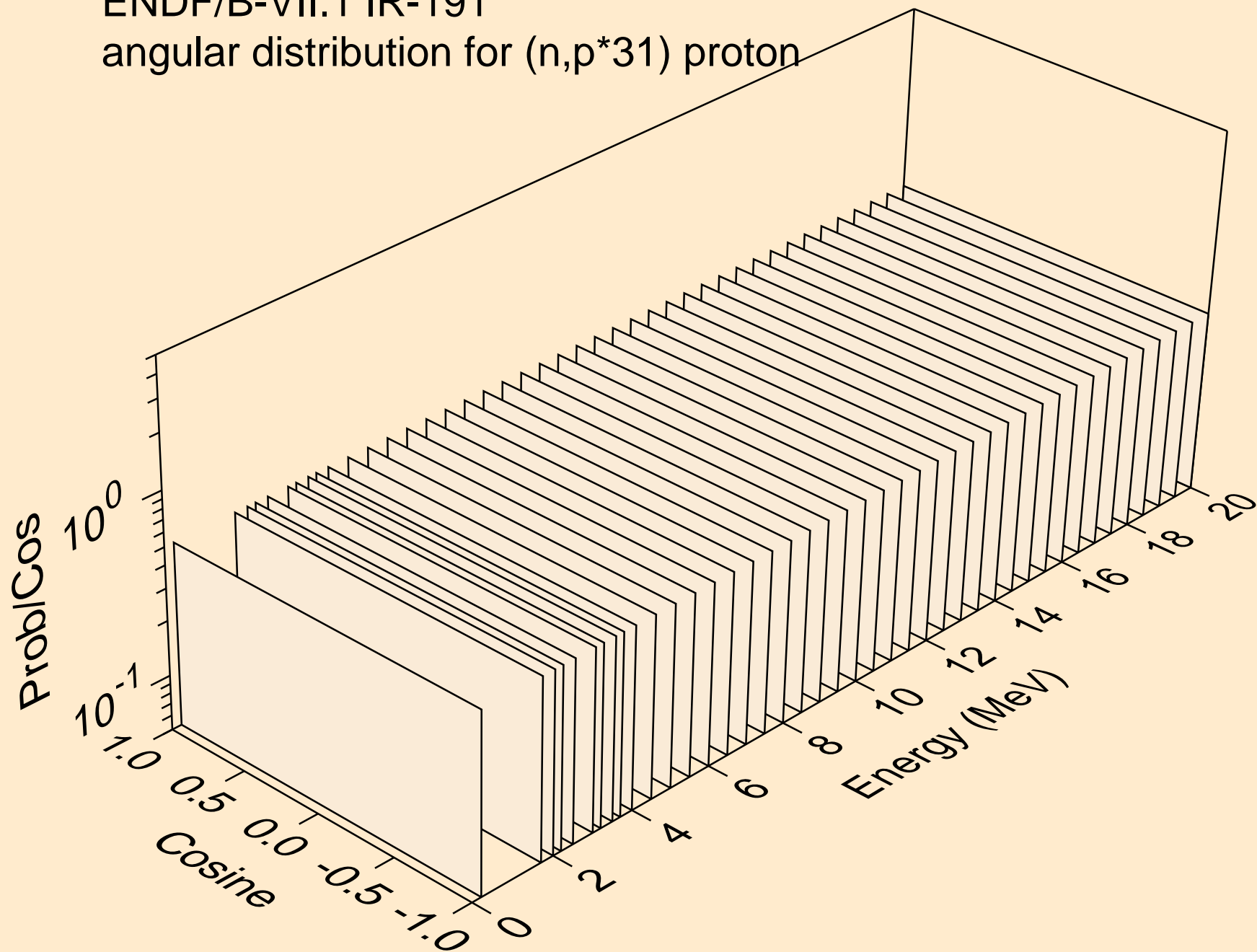

ENDF/B-VII.1 IR-191
angular distribution for (n,p*32) proton

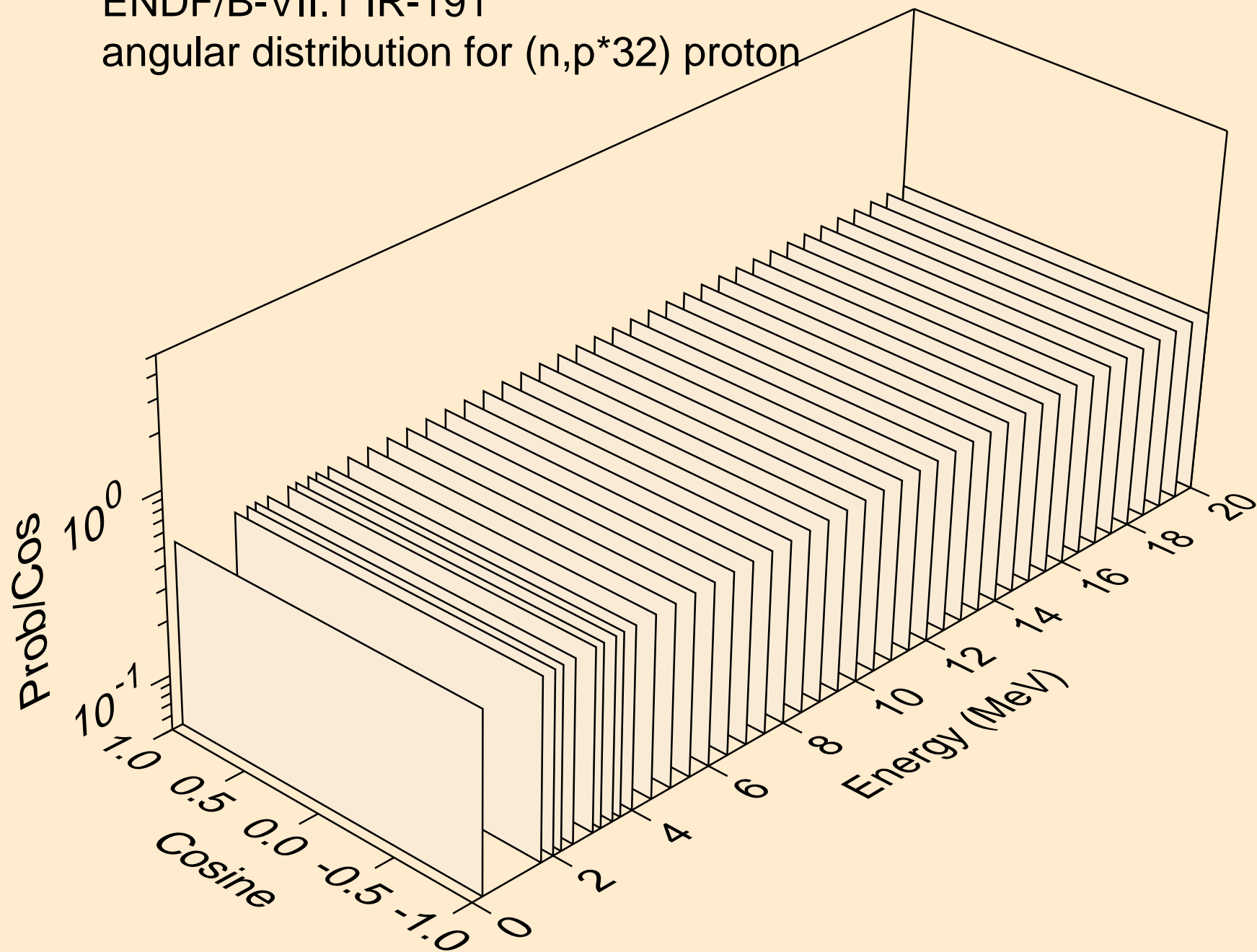

ENDF/B-VII.1 IR-191
angular distribution for (n,p*33) proton

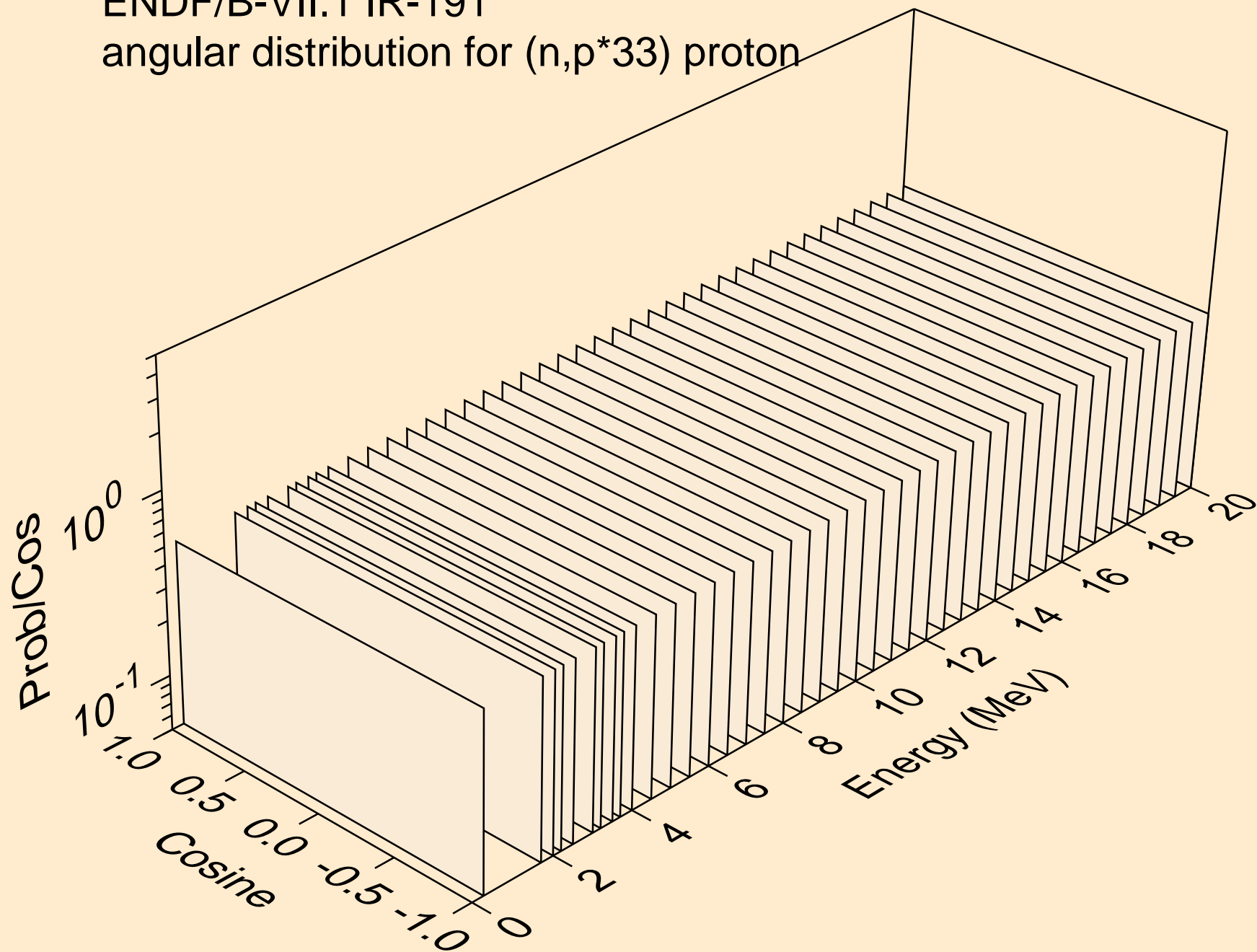

ENDF/B-VII.1 IR-191
angular distribution for (n,p*34) proton

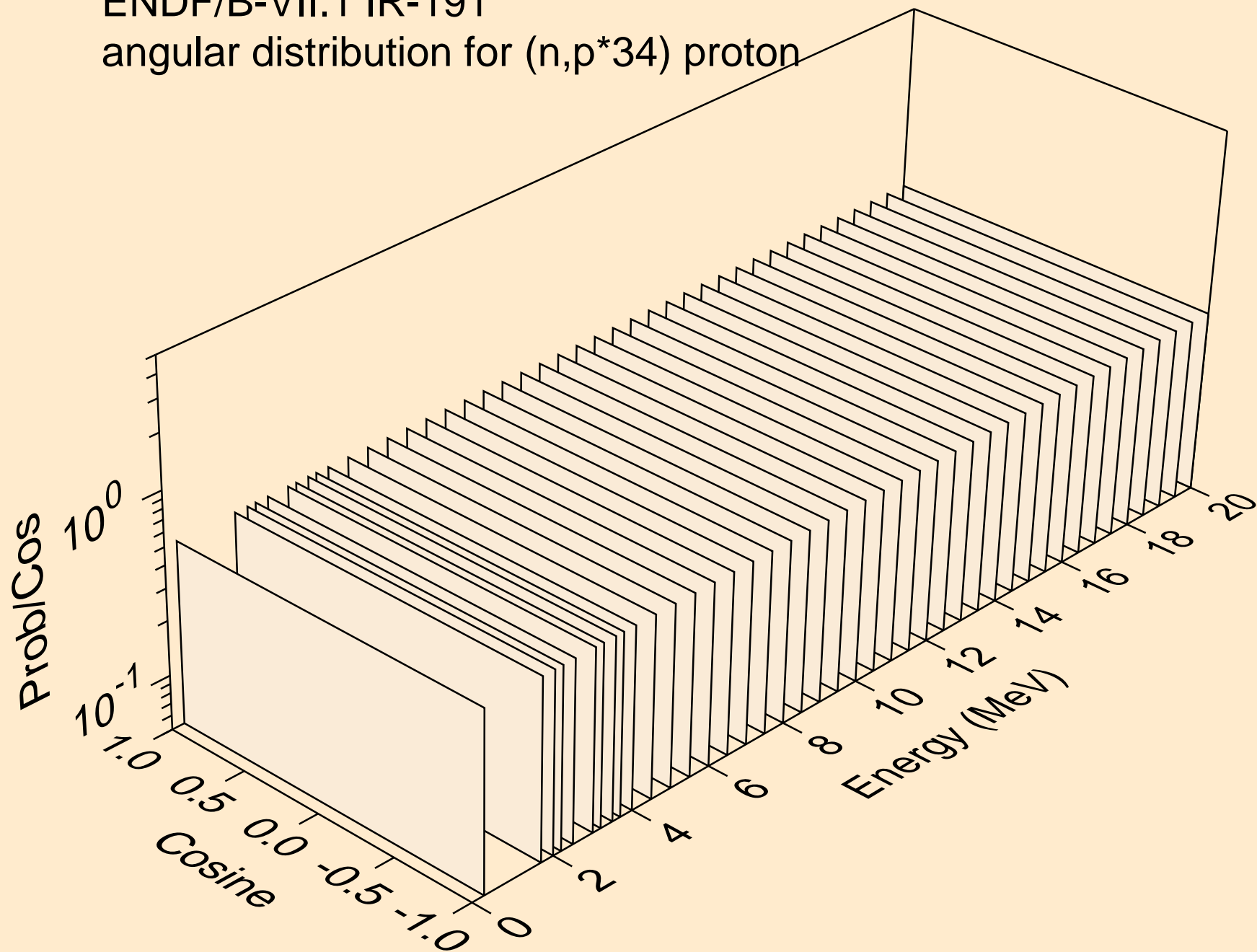

ENDF/B-VII.1 IR-191
angular distribution for (n,p*35) proton

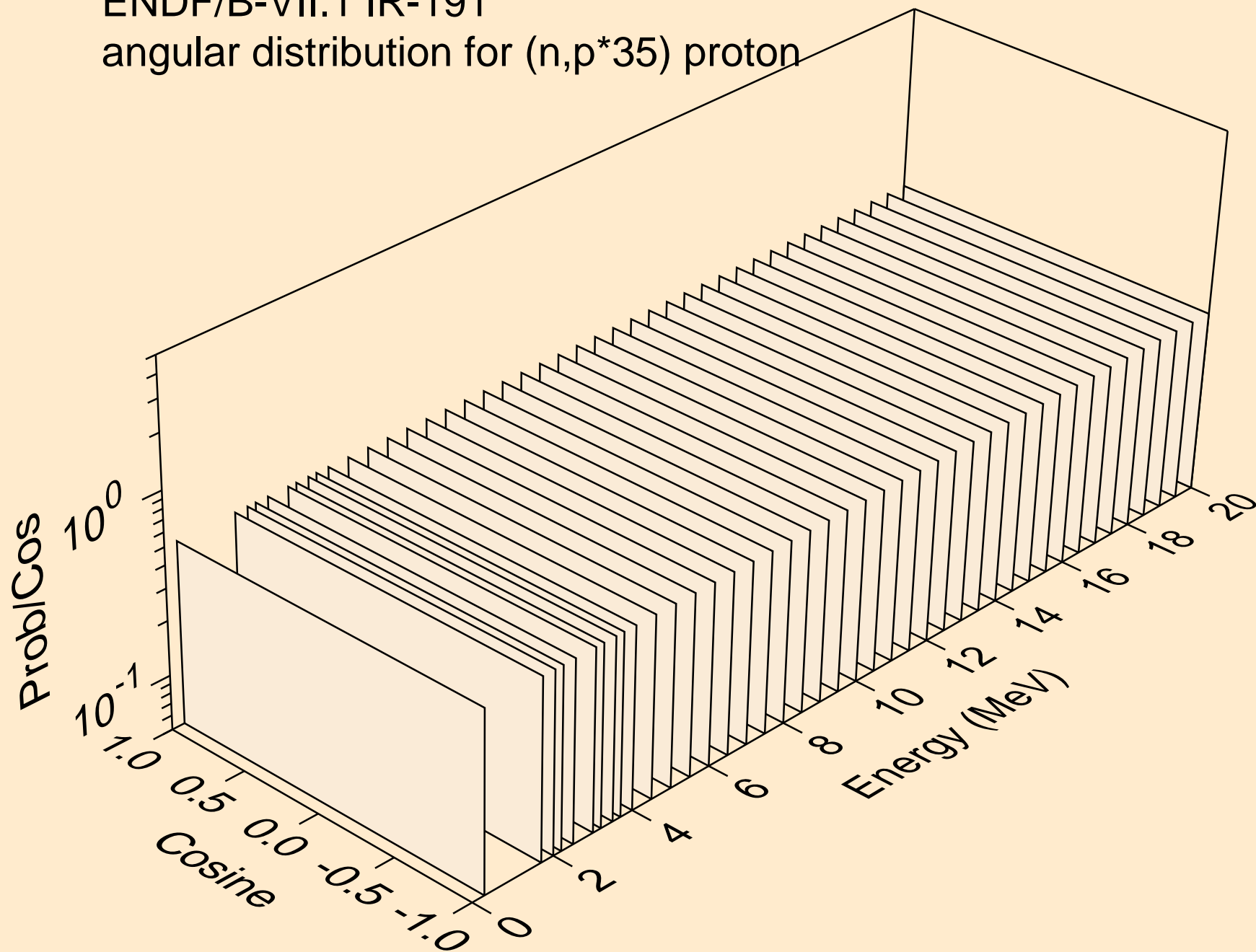

ENDF/B-VII.1 IR-191
angular distribution for (n,p*36) proton

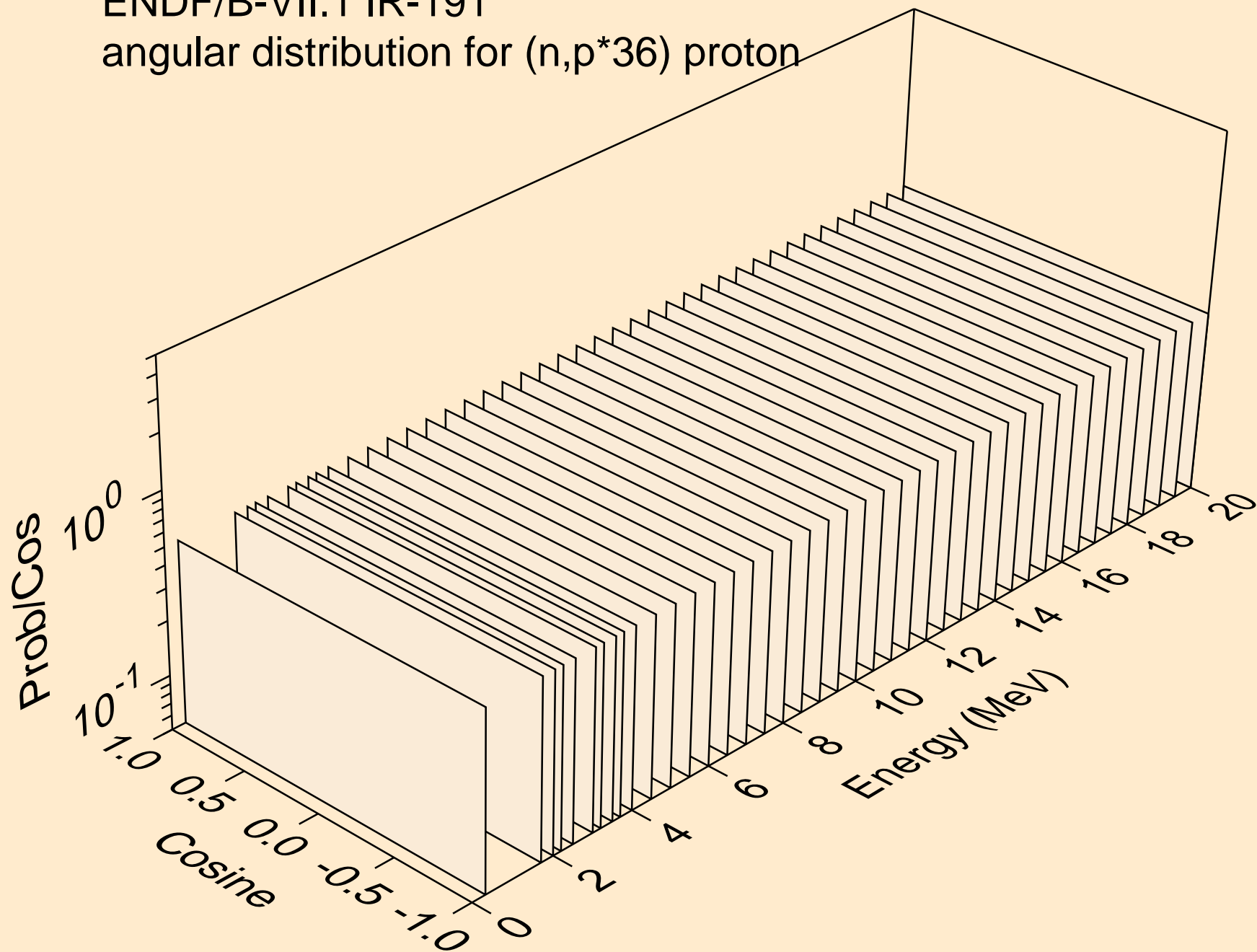

ENDF/B-VII.1 IR-191
angular distribution for (n,p*37) proton

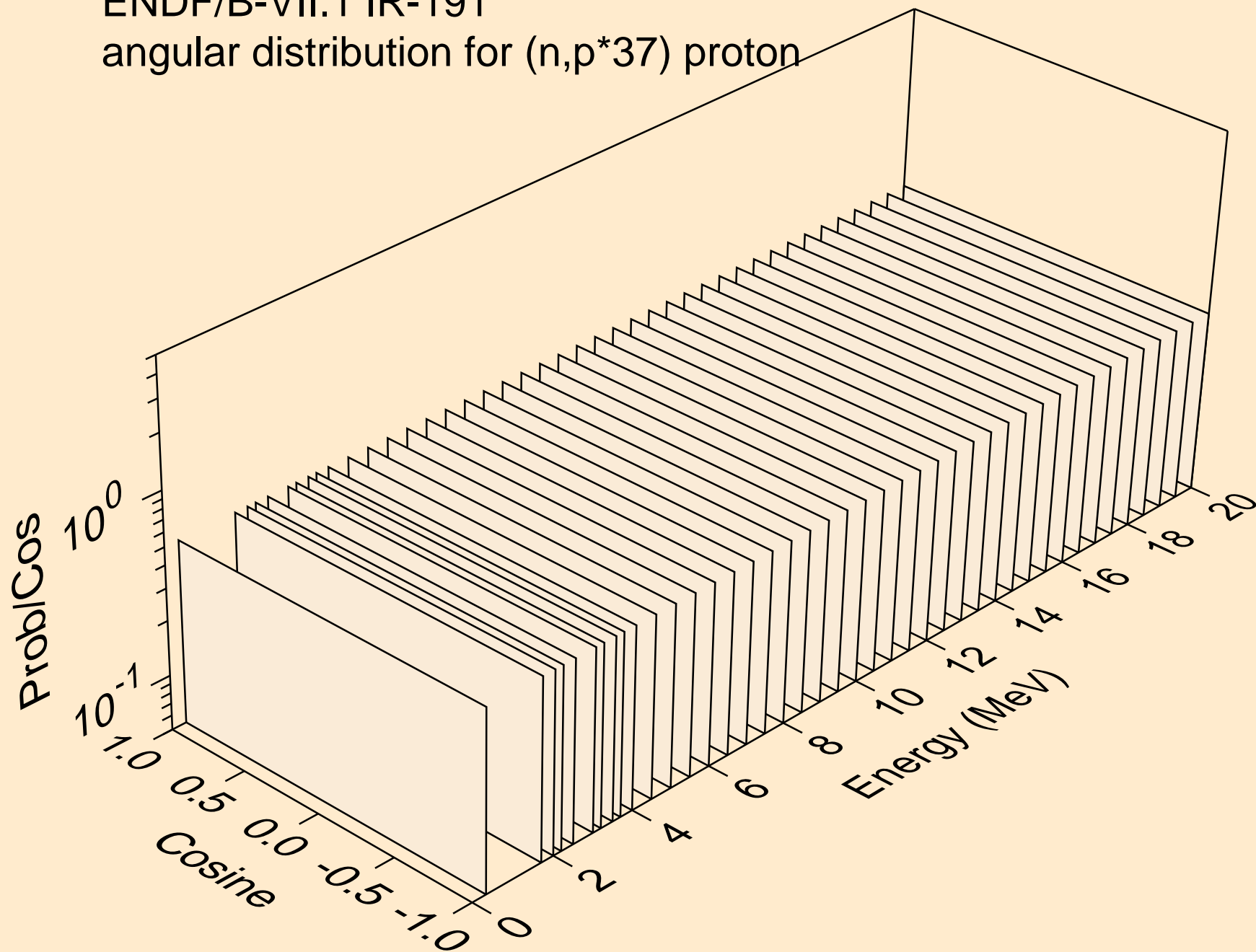

ENDF/B-VII.1 IR-191

angular distribution for (n,p*38) proton

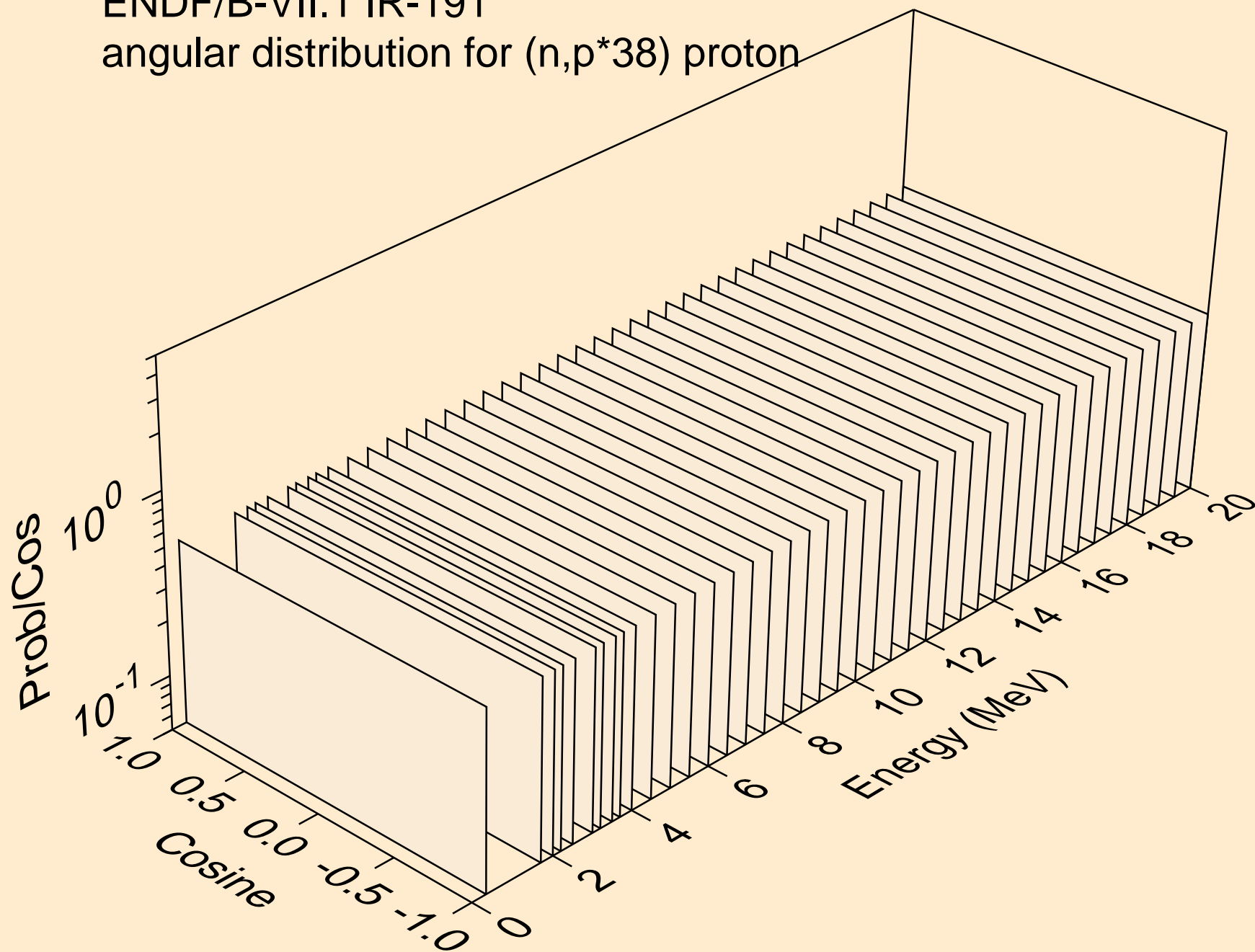

ENDF/B-VII.1 IR-191
angular distribution for (n,p*39) proton

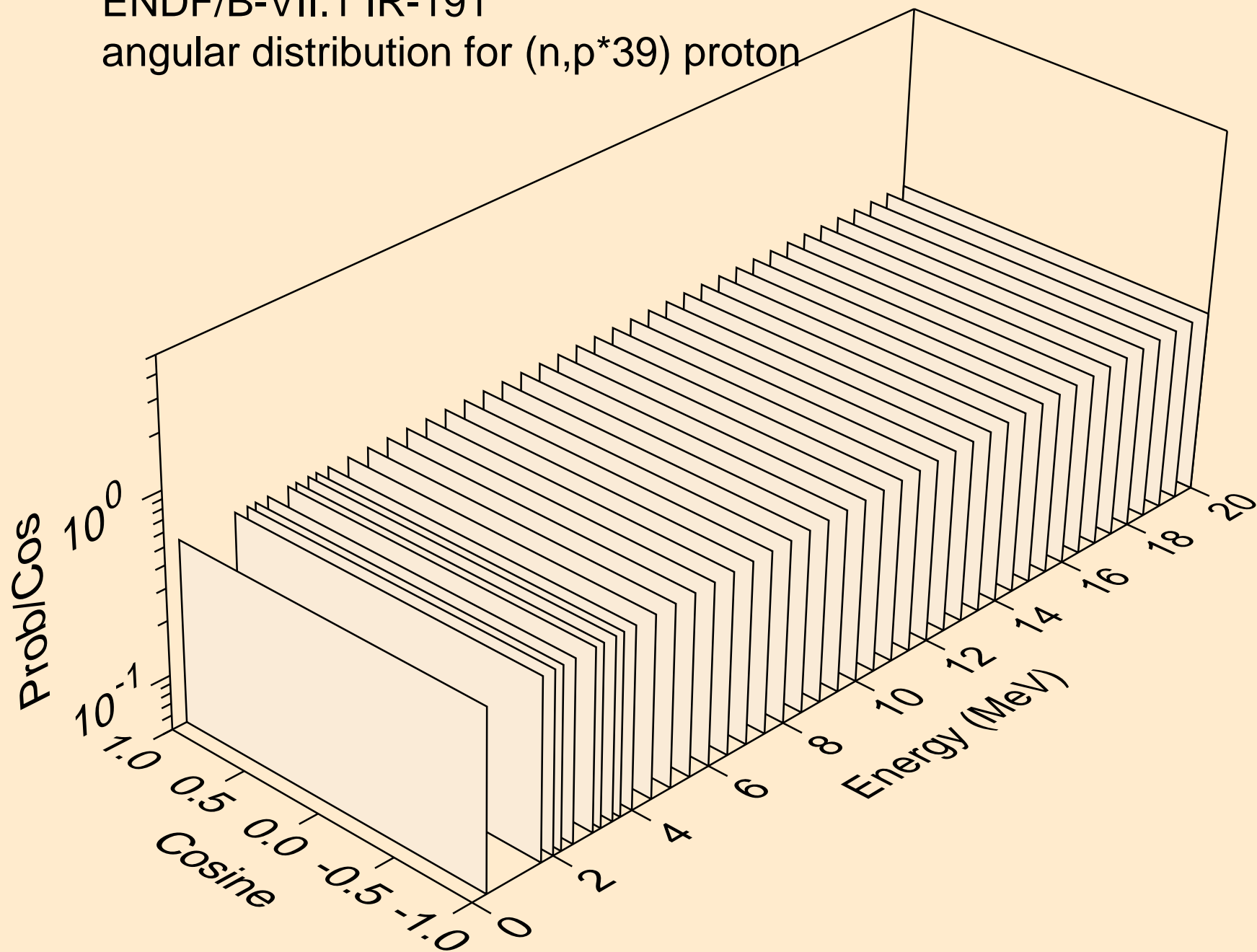

ENDF/B-VII.1 IR-191
protons from (n,p*c)

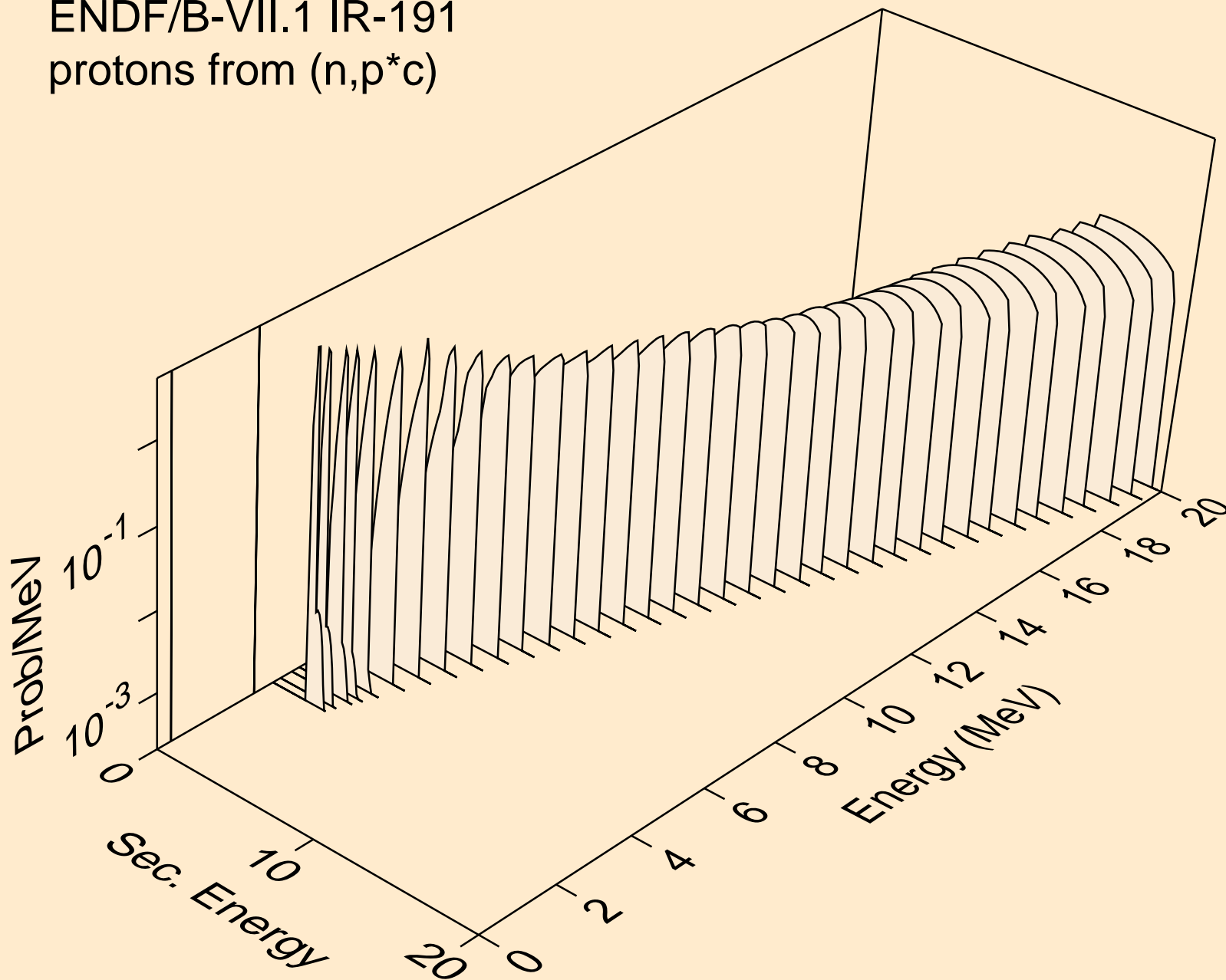

ENDF/B-VII.1 IR-191
alphas from (n,n*)a

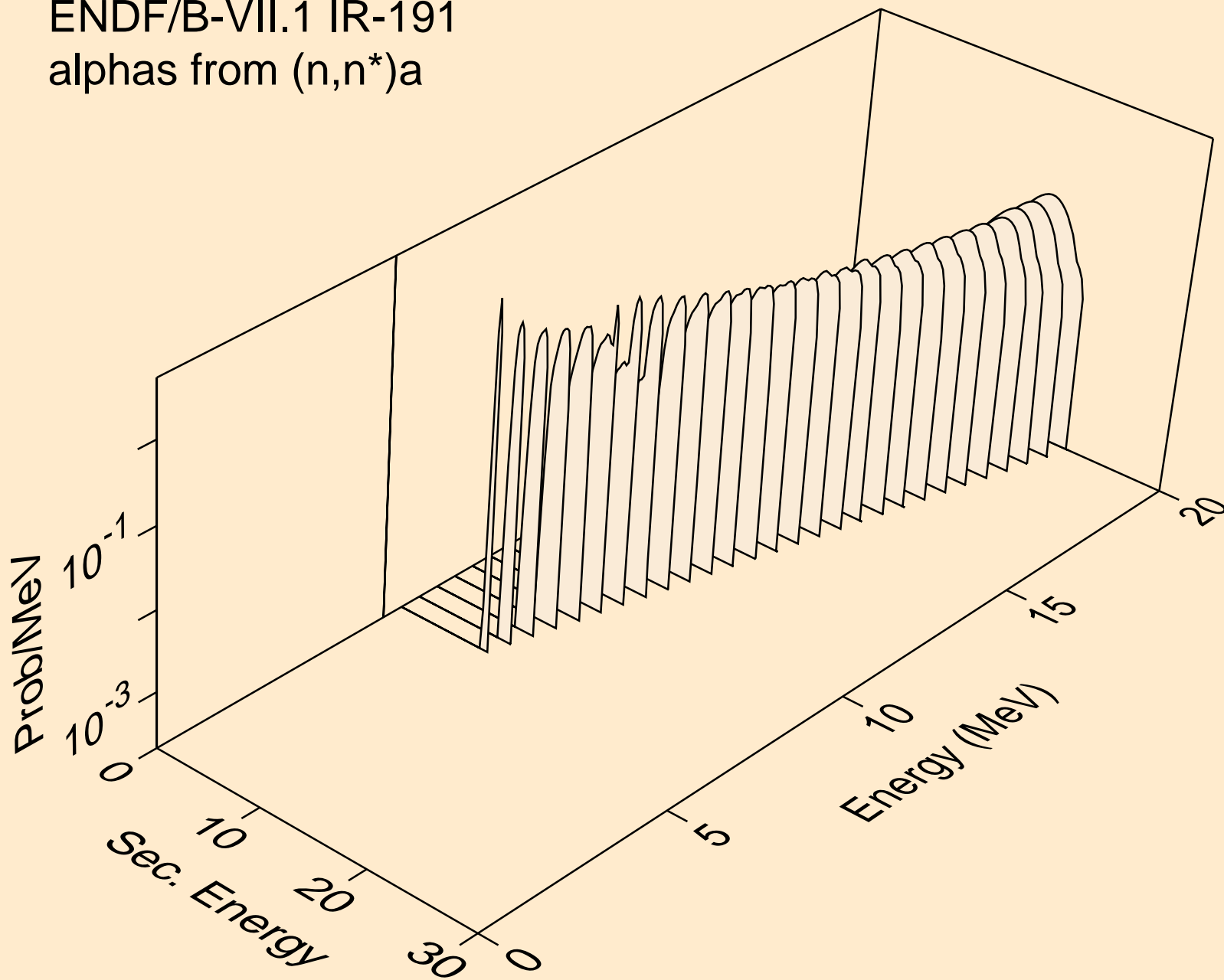

ENDF/B-VII.1 IR-191
alphas from (n,2n)a

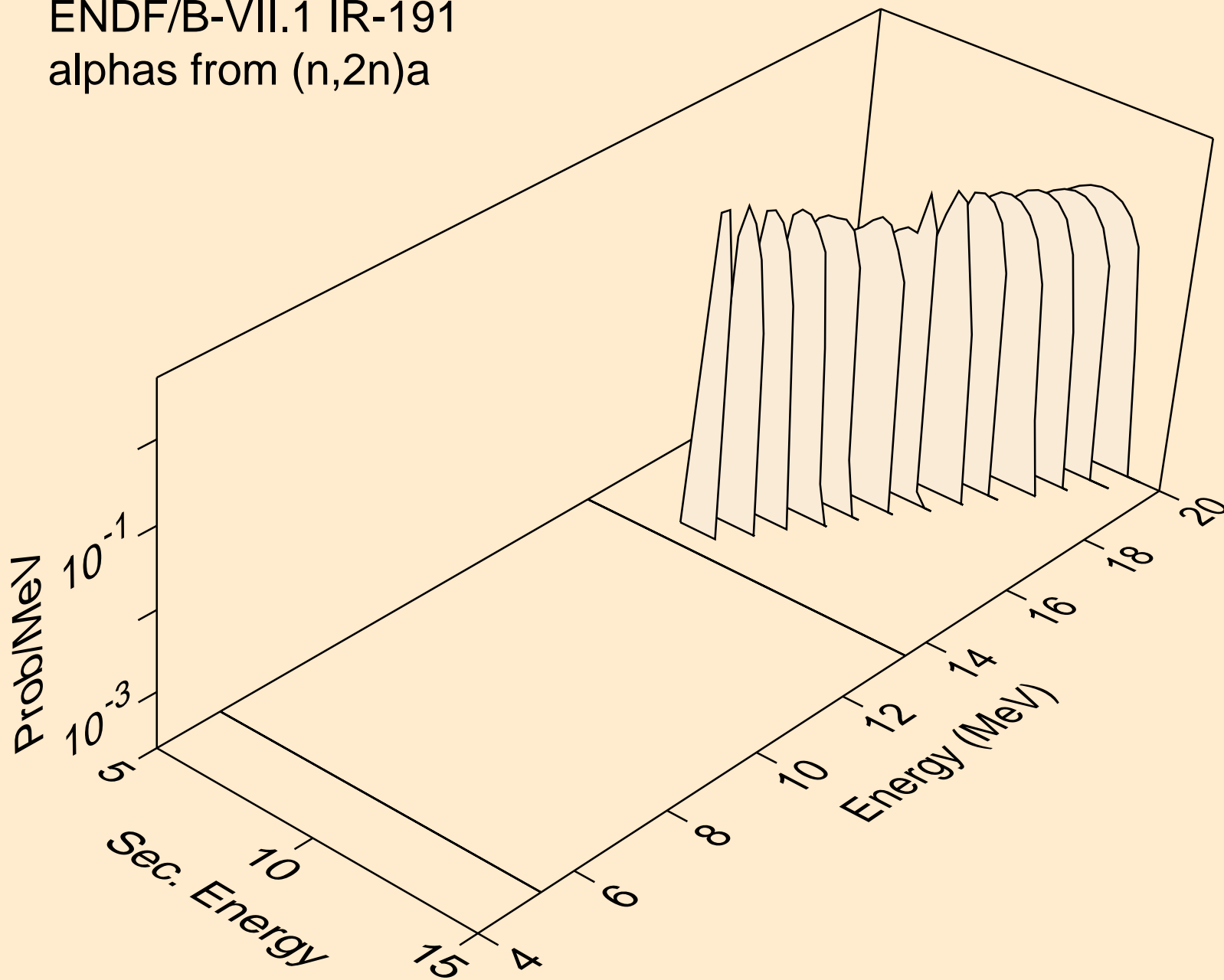

ENDF/B-VII.1 IR-191
angular distribution for (n,a*0) alpha

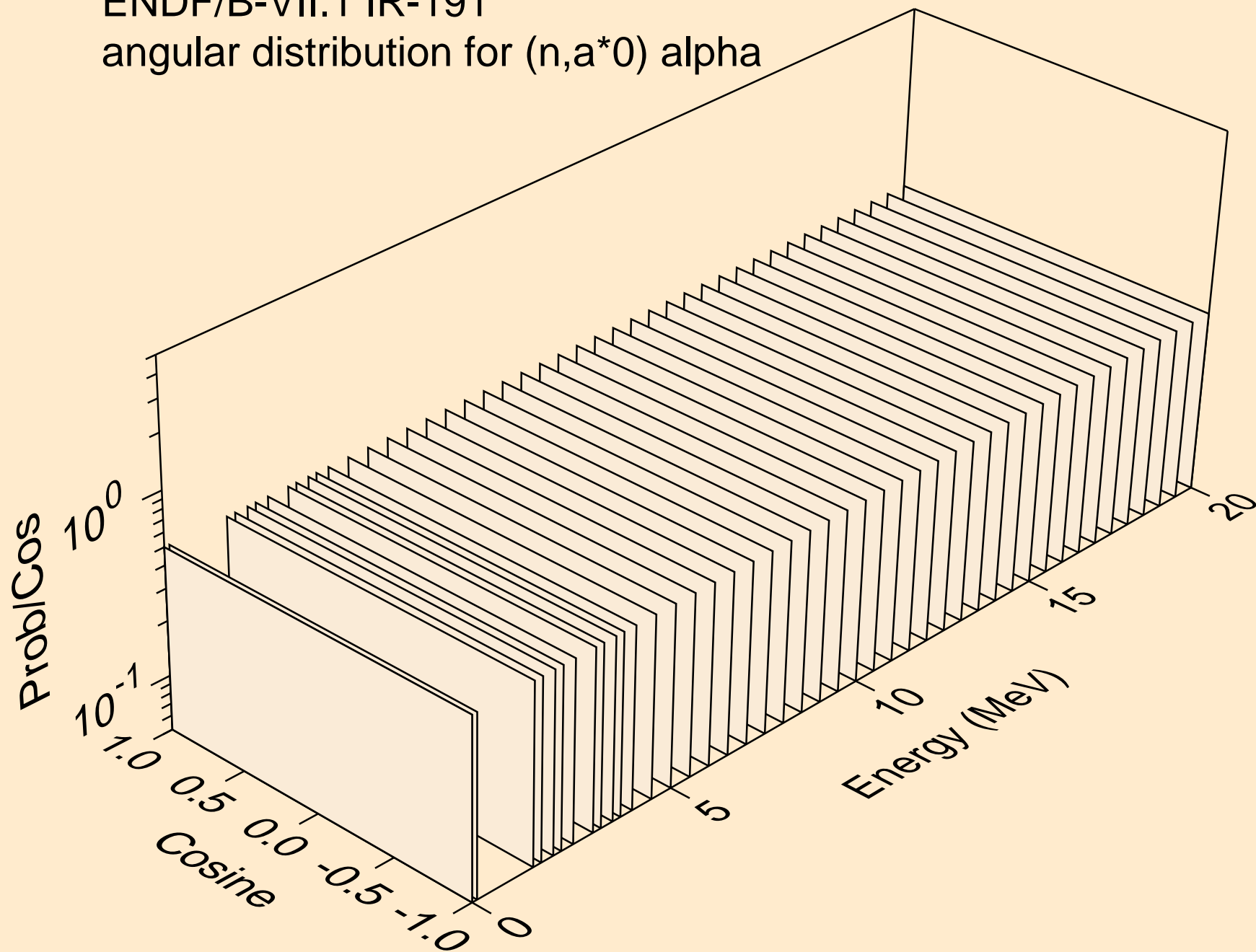

ENDF/B-VII.1 IR-191
angular distribution for (n,a*1) alpha

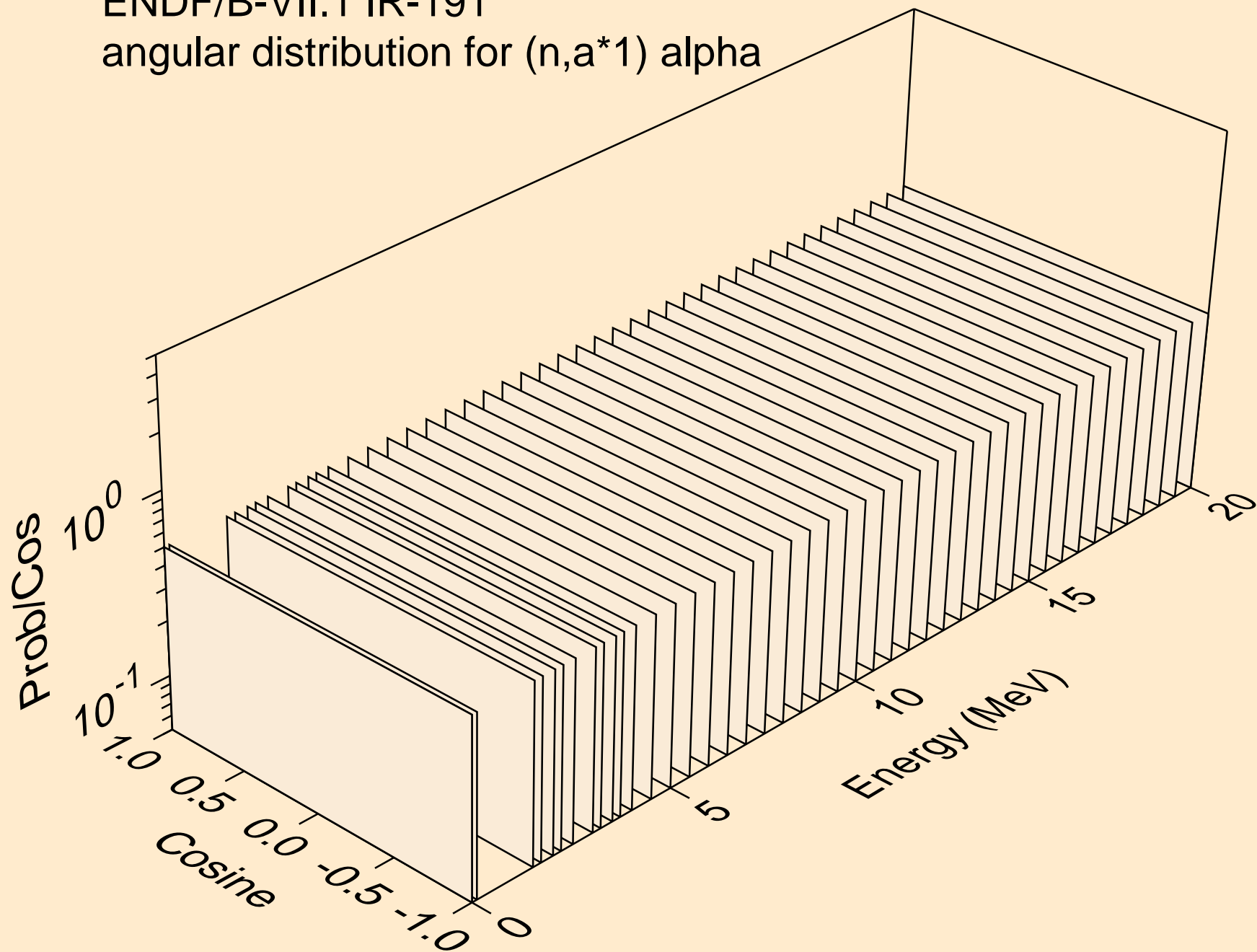

ENDF/B-VII.1 IR-191
angular distribution for (n,a*2) alpha

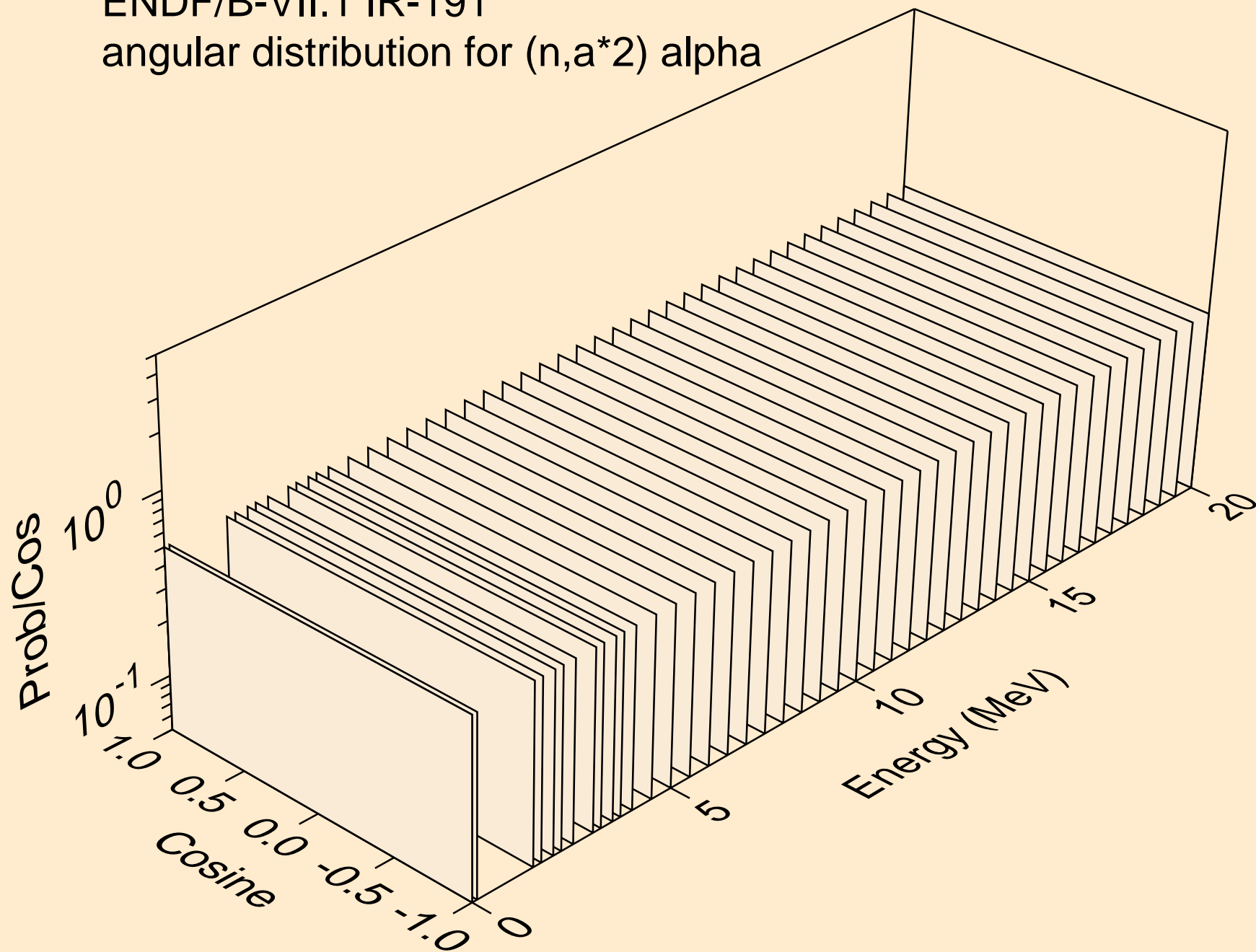

ENDF/B-VII.1 IR-191
angular distribution for (n,a*3) alpha

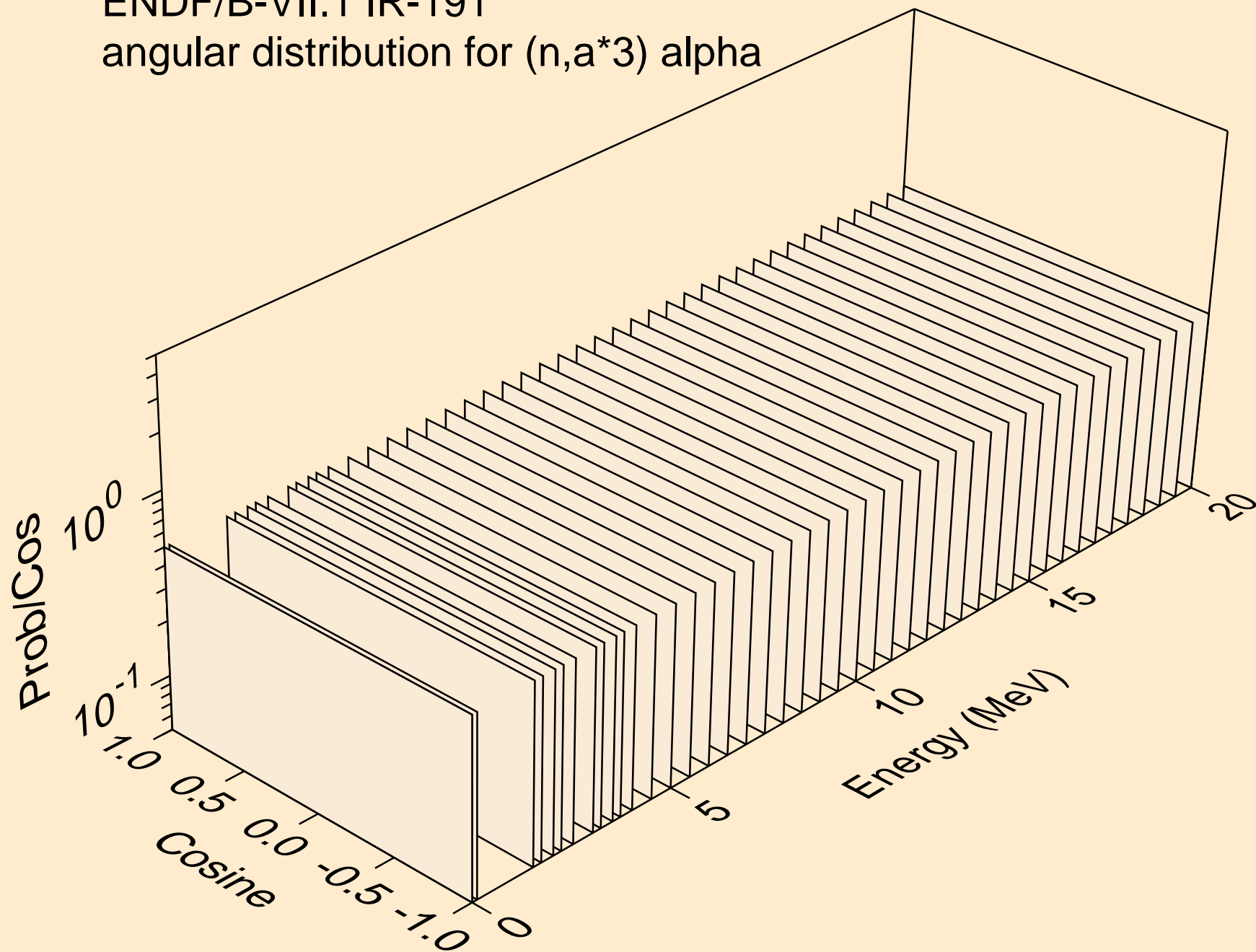

ENDF/B-VII.1 IR-191
angular distribution for (n,a*4) alpha

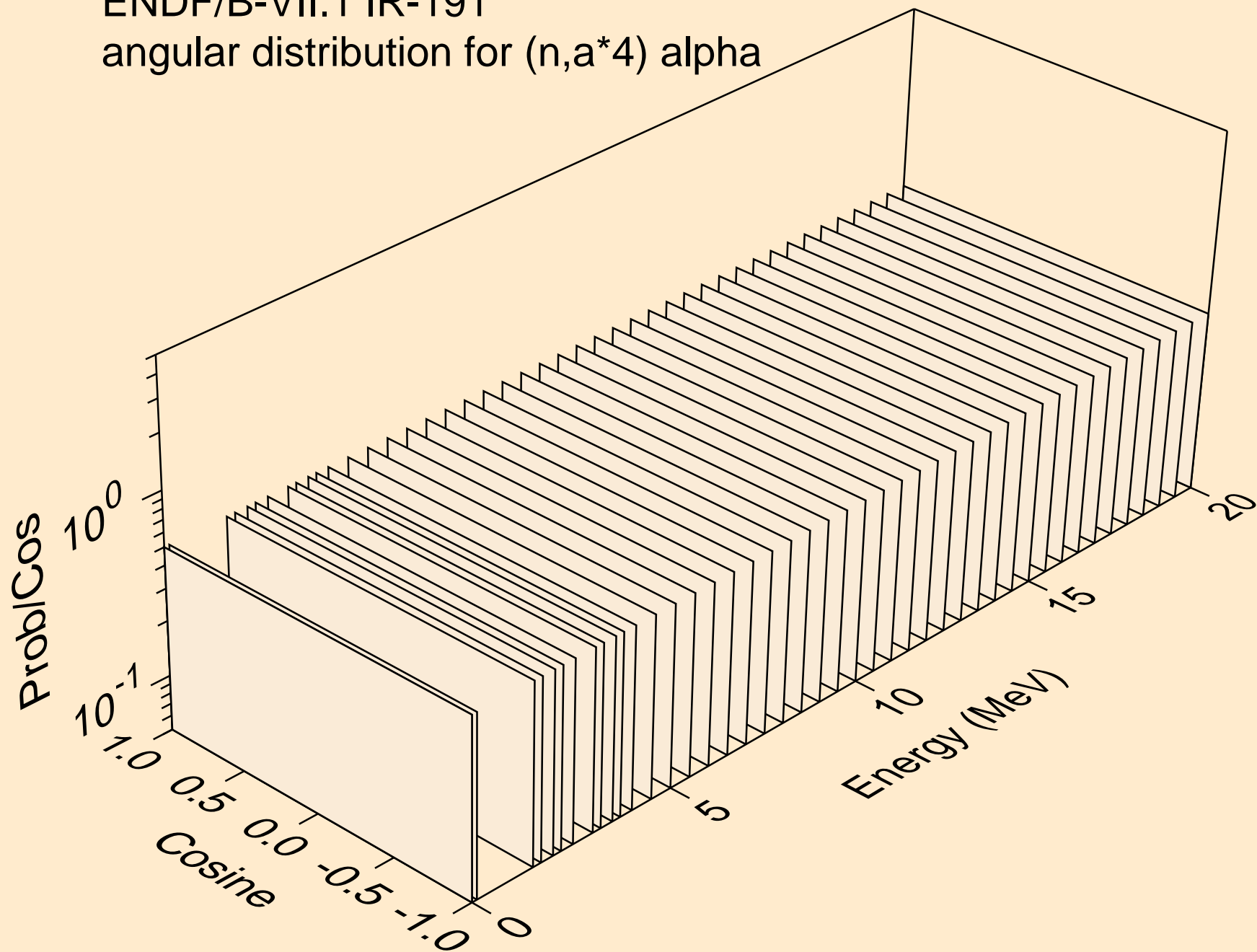

ENDF/B-VII.1 IR-191
angular distribution for (n,a*5) alpha

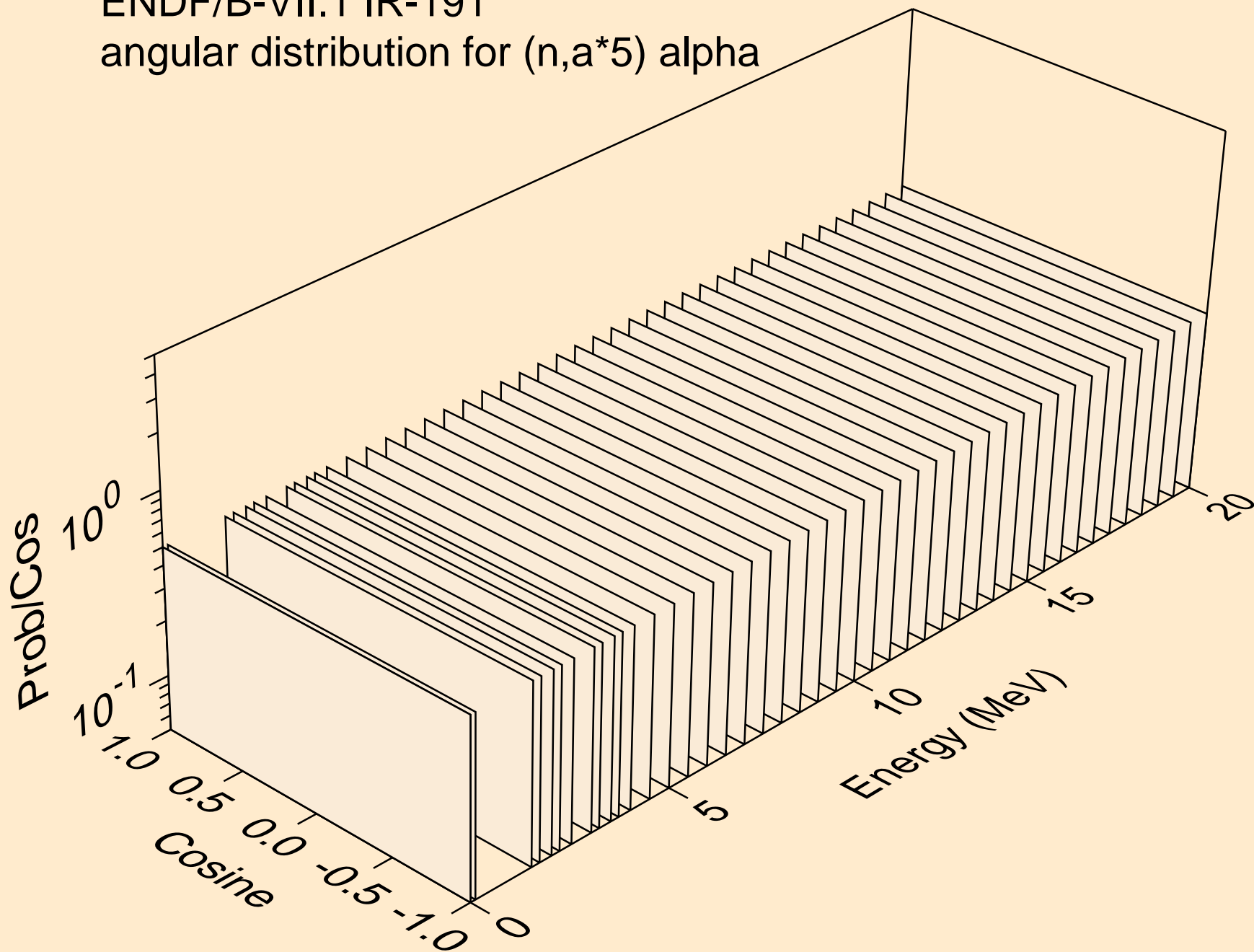

ENDF/B-VII.1 IR-191
angular distribution for (n,a*6) alpha

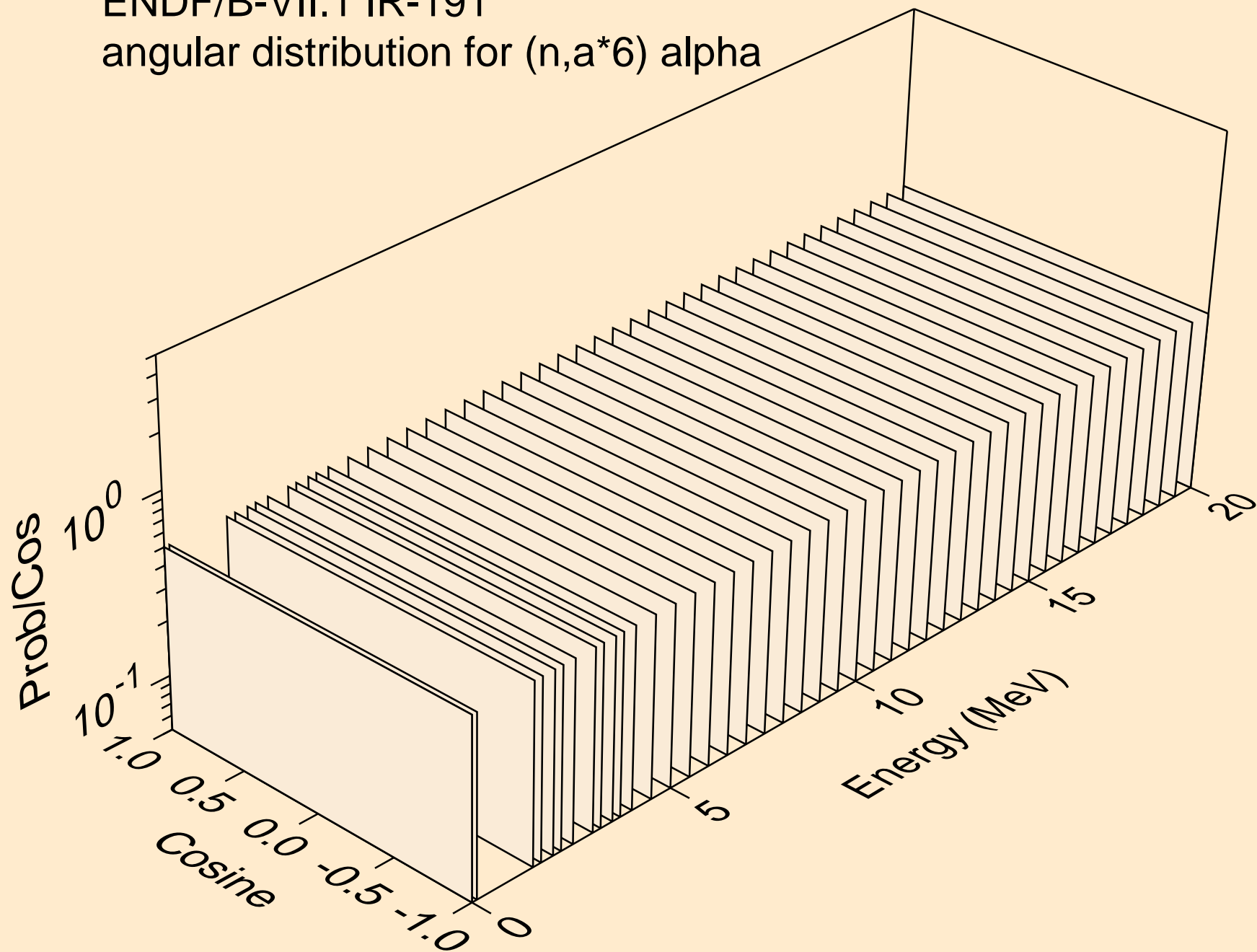

ENDF/B-VII.1 IR-191
angular distribution for (n,a*7) alpha

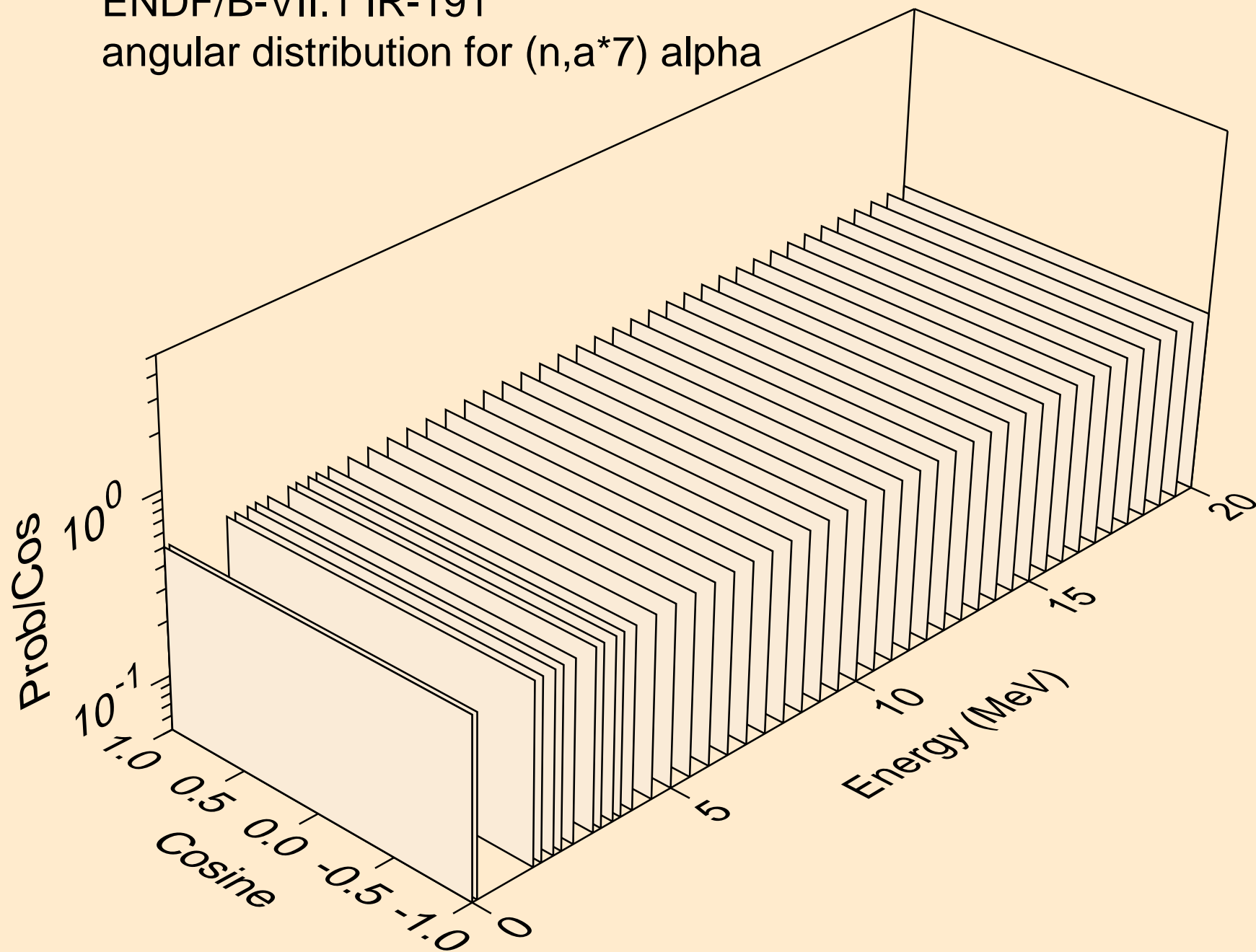

ENDF/B-VII.1 IR-191
angular distribution for (n,a*8) alpha

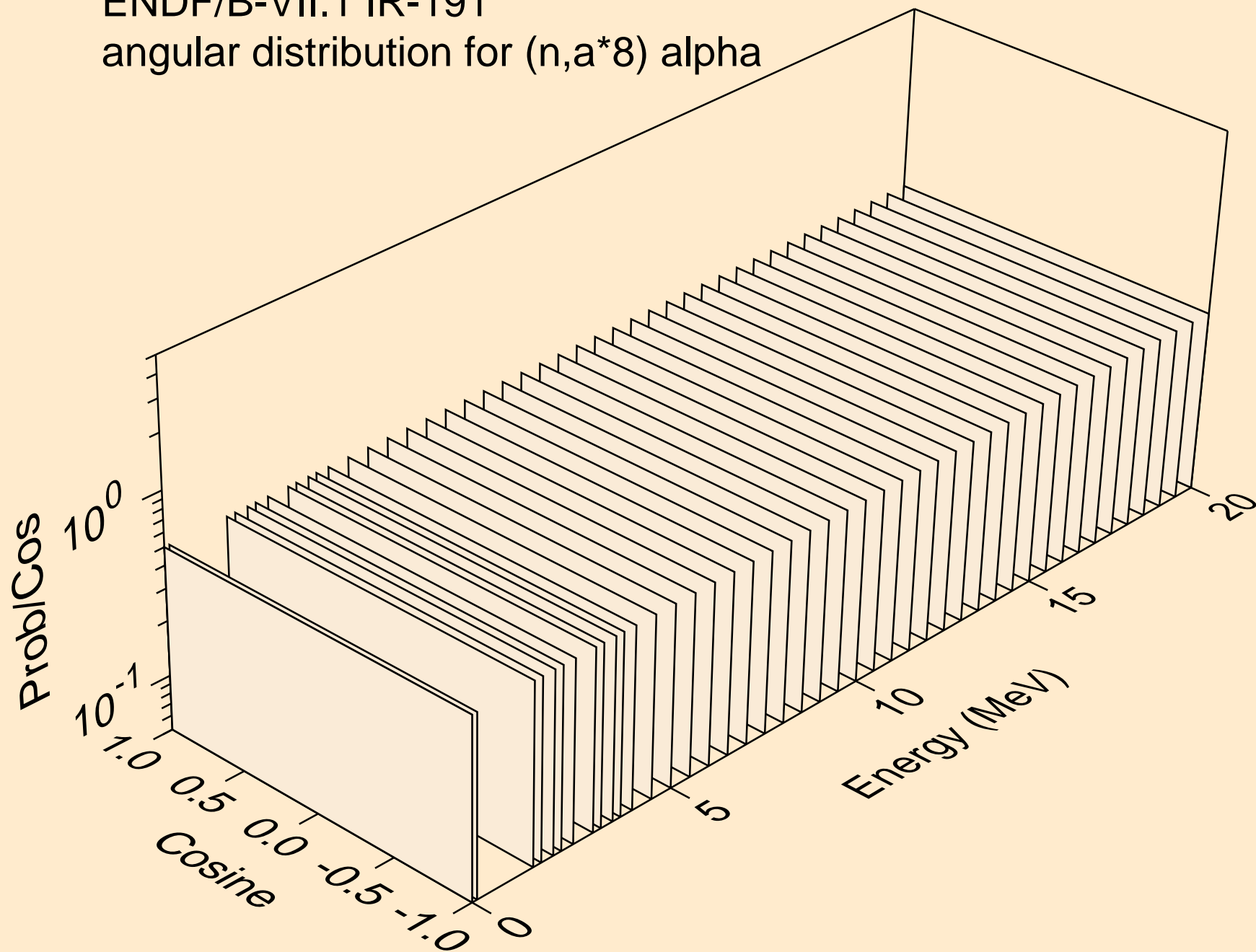

ENDF/B-VII.1 IR-191
angular distribution for (n,a*9) alpha

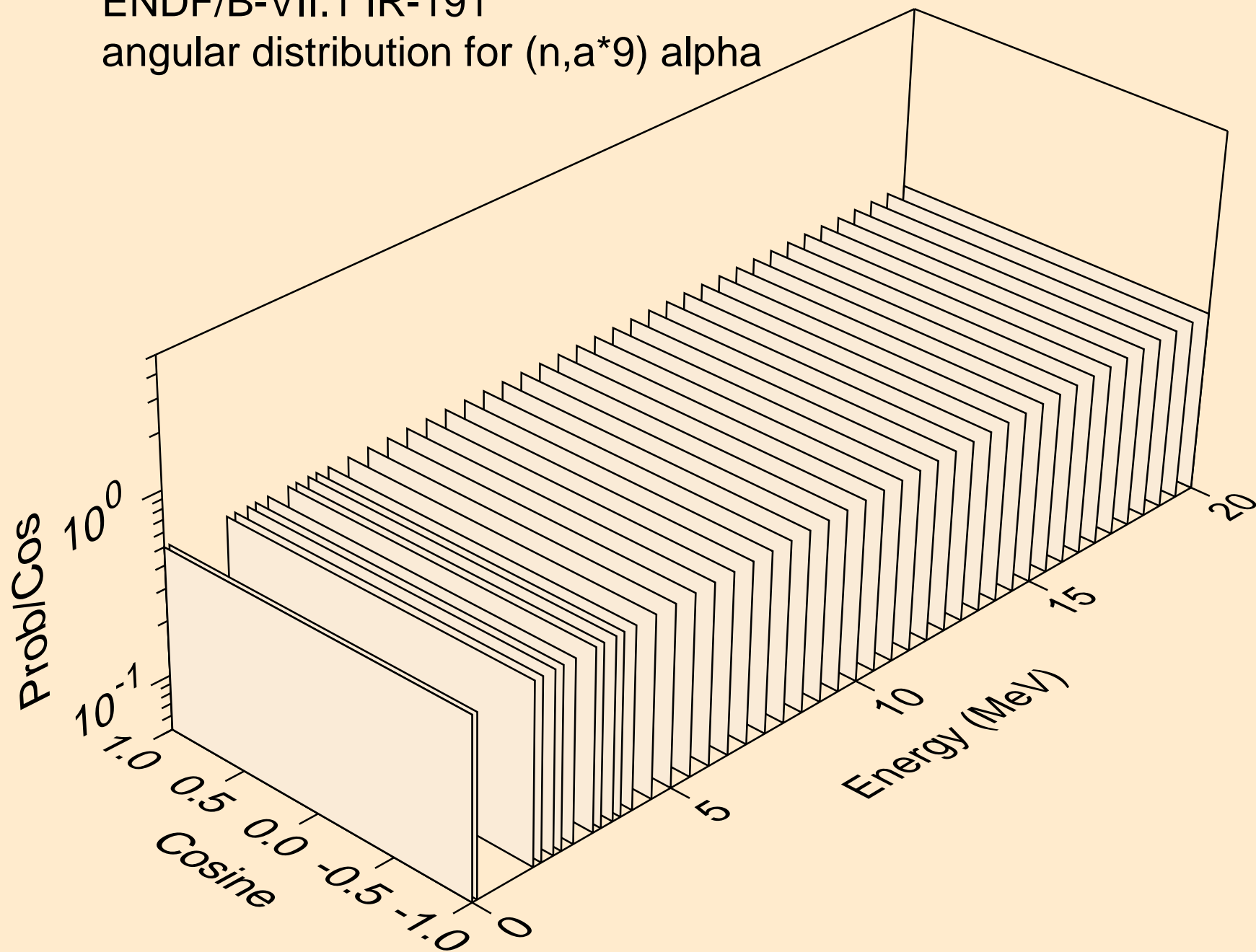

ENDF/B-VII.1 IR-191
angular distribution for (n,a*10) alpha

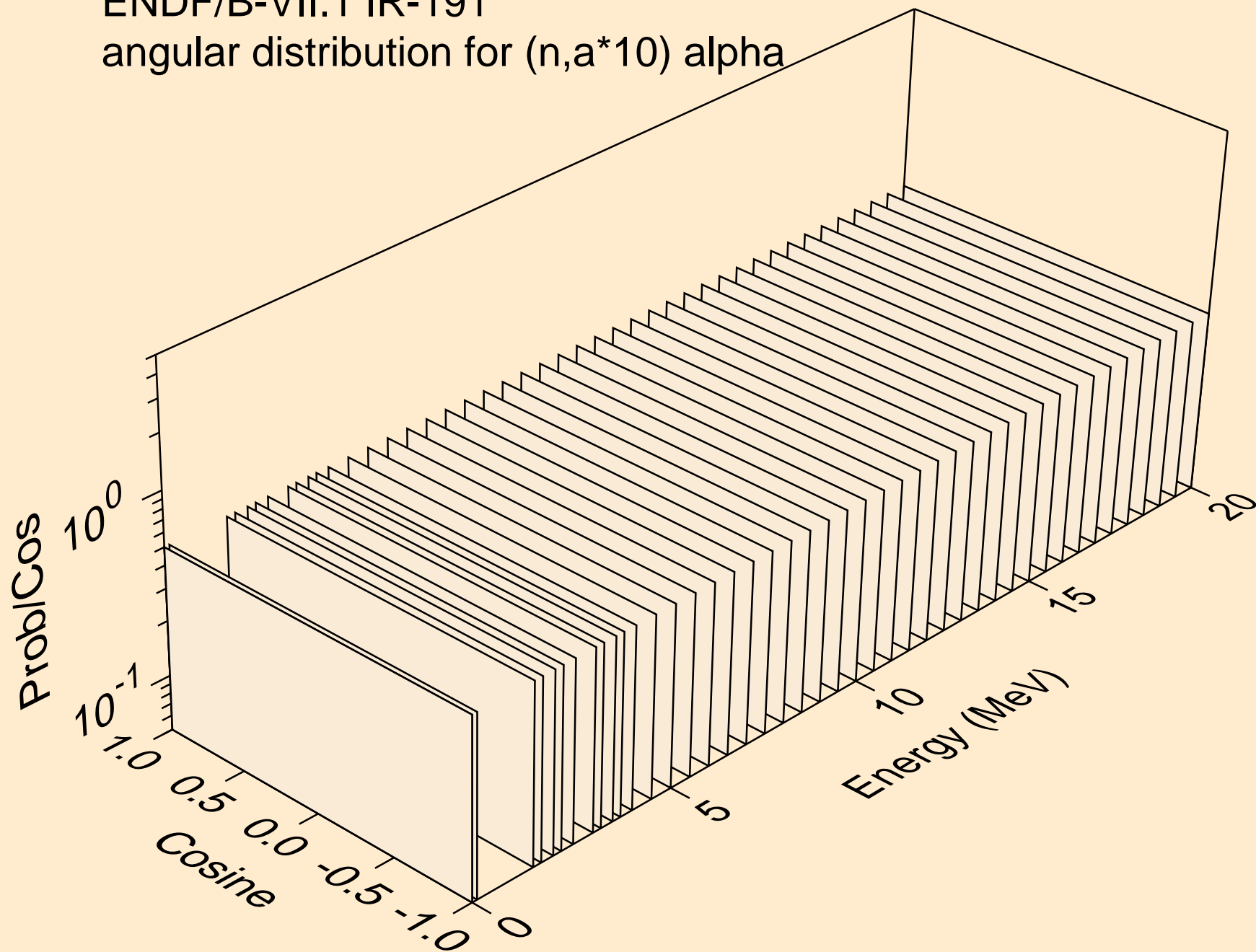

ENDF/B-VII.1 IR-191
angular distribution for (n, α *11) alpha

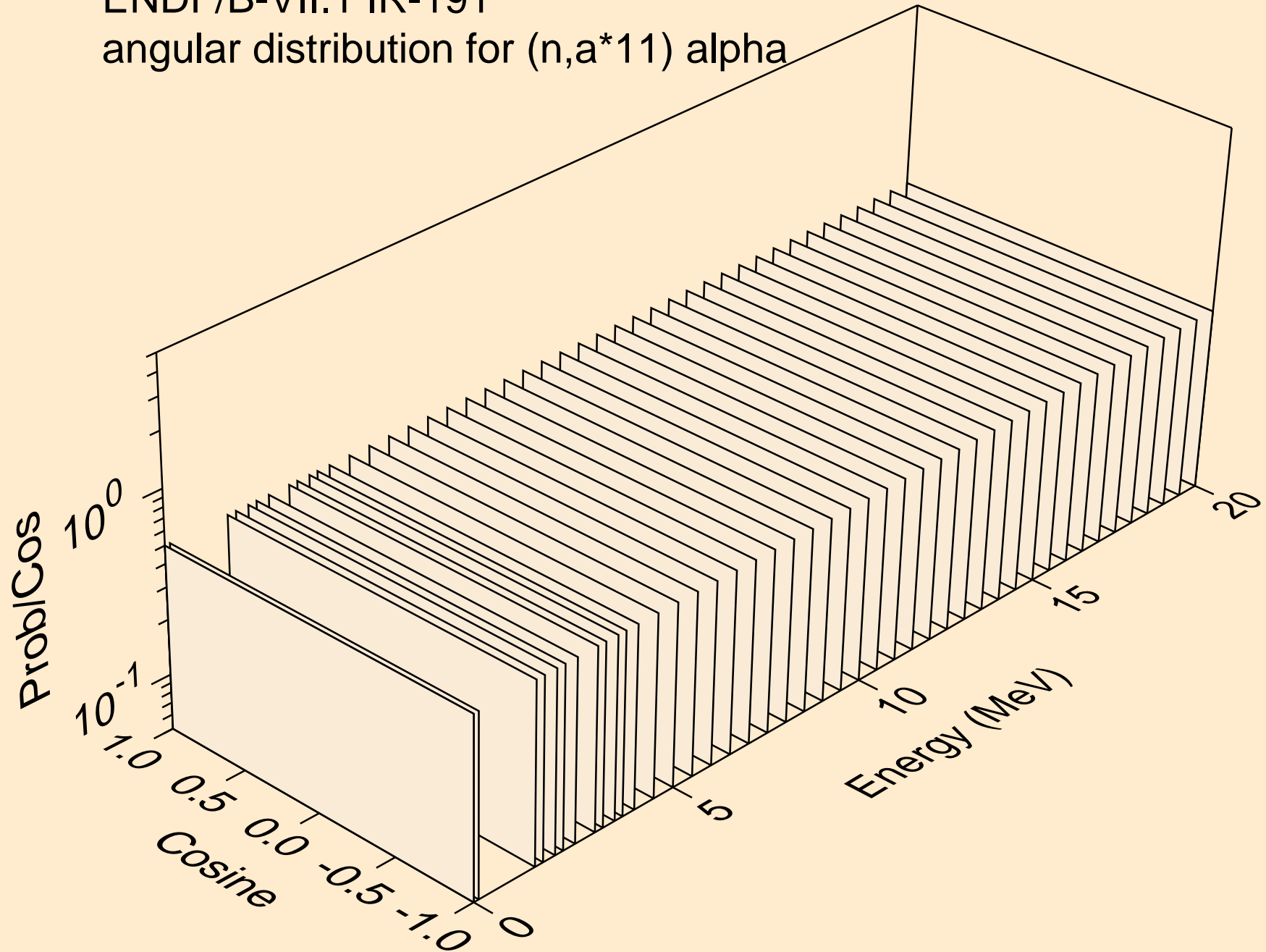

ENDF/B-VII.1 IR-191
angular distribution for (n, α *12) alpha

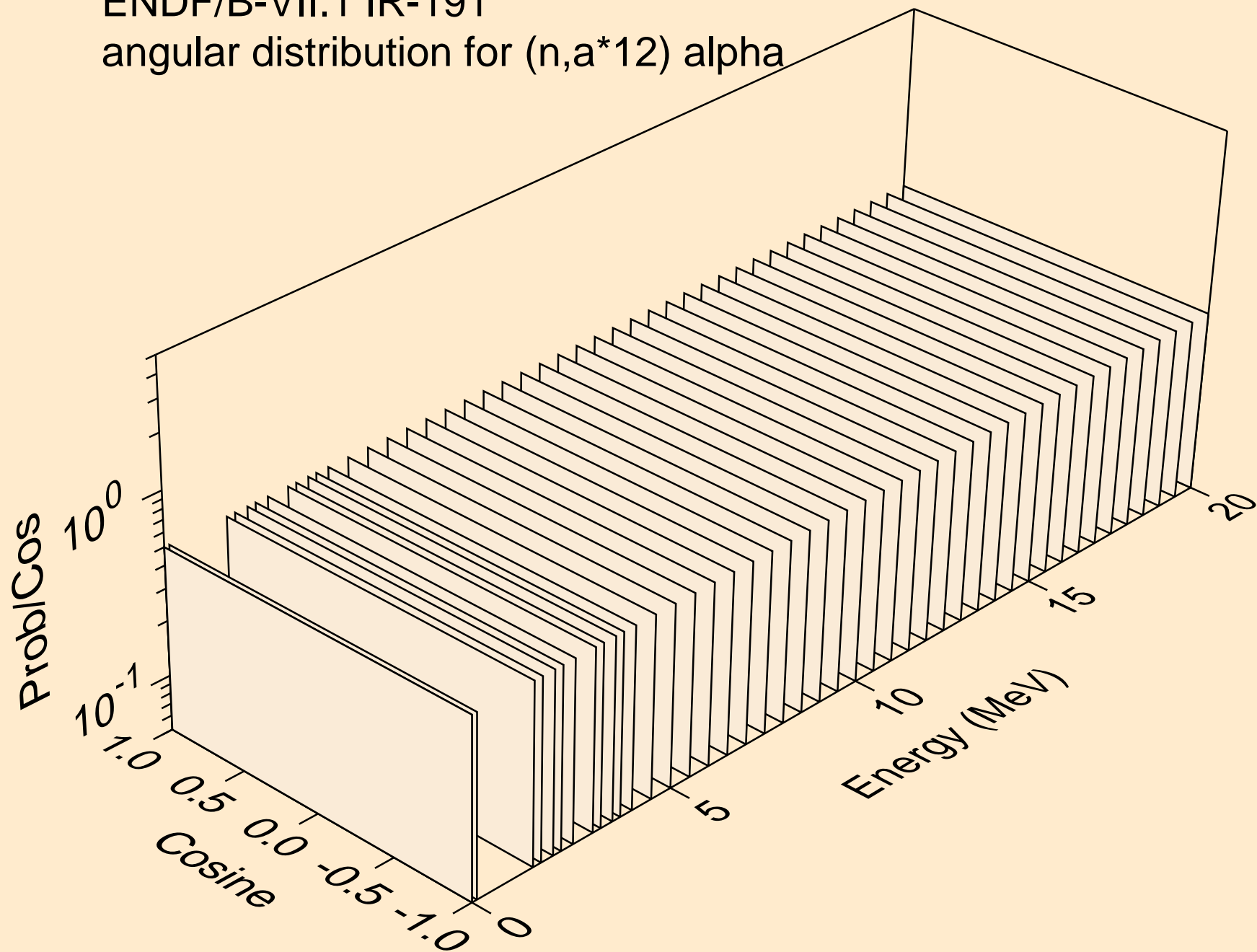

ENDF/B-VII.1 IR-191
angular distribution for (n, α *13) alpha

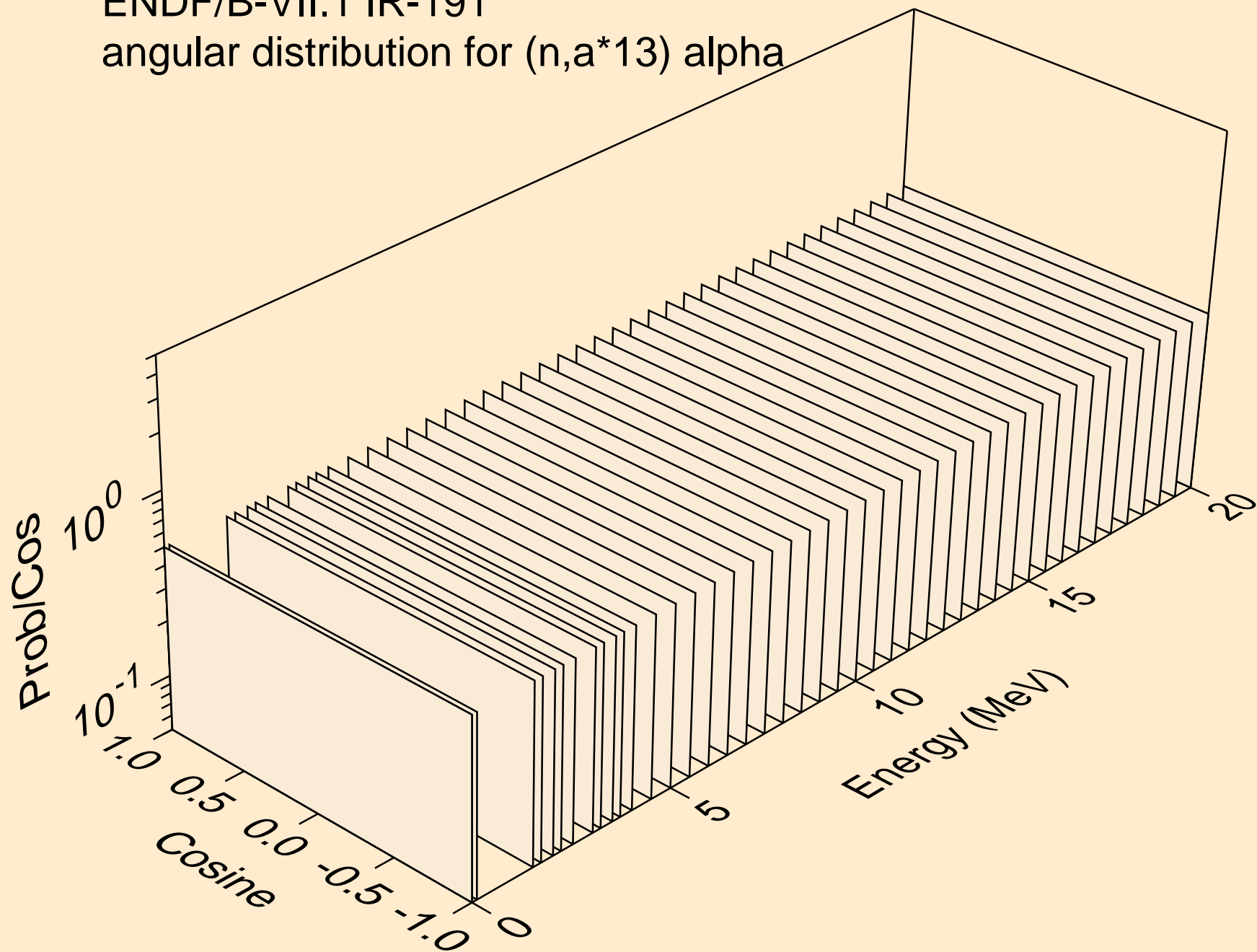

ENDF/B-VII.1 IR-191
angular distribution for (n,a*14) alpha

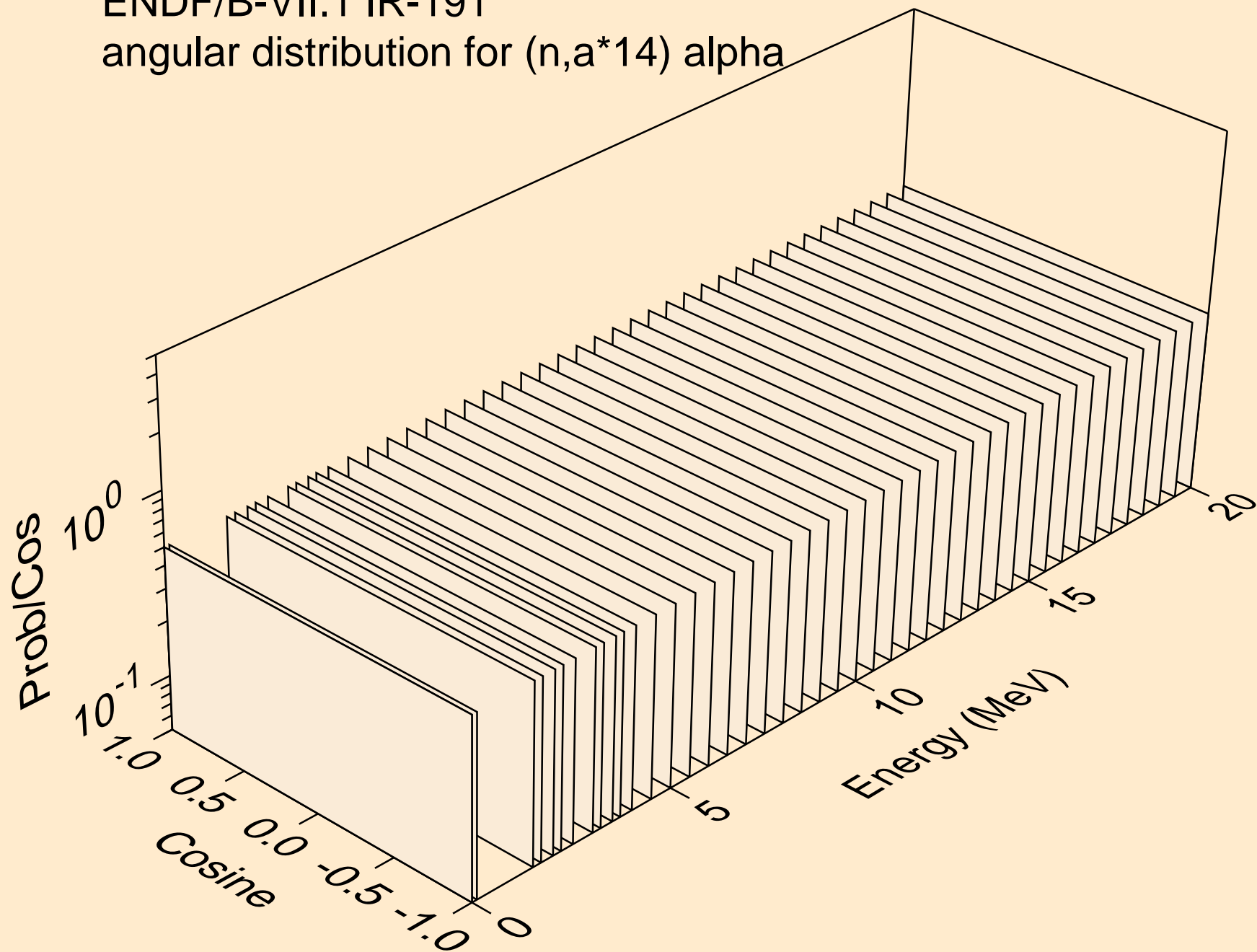

ENDF/B-VII.1 IR-191
angular distribution for (n, α *15) alpha

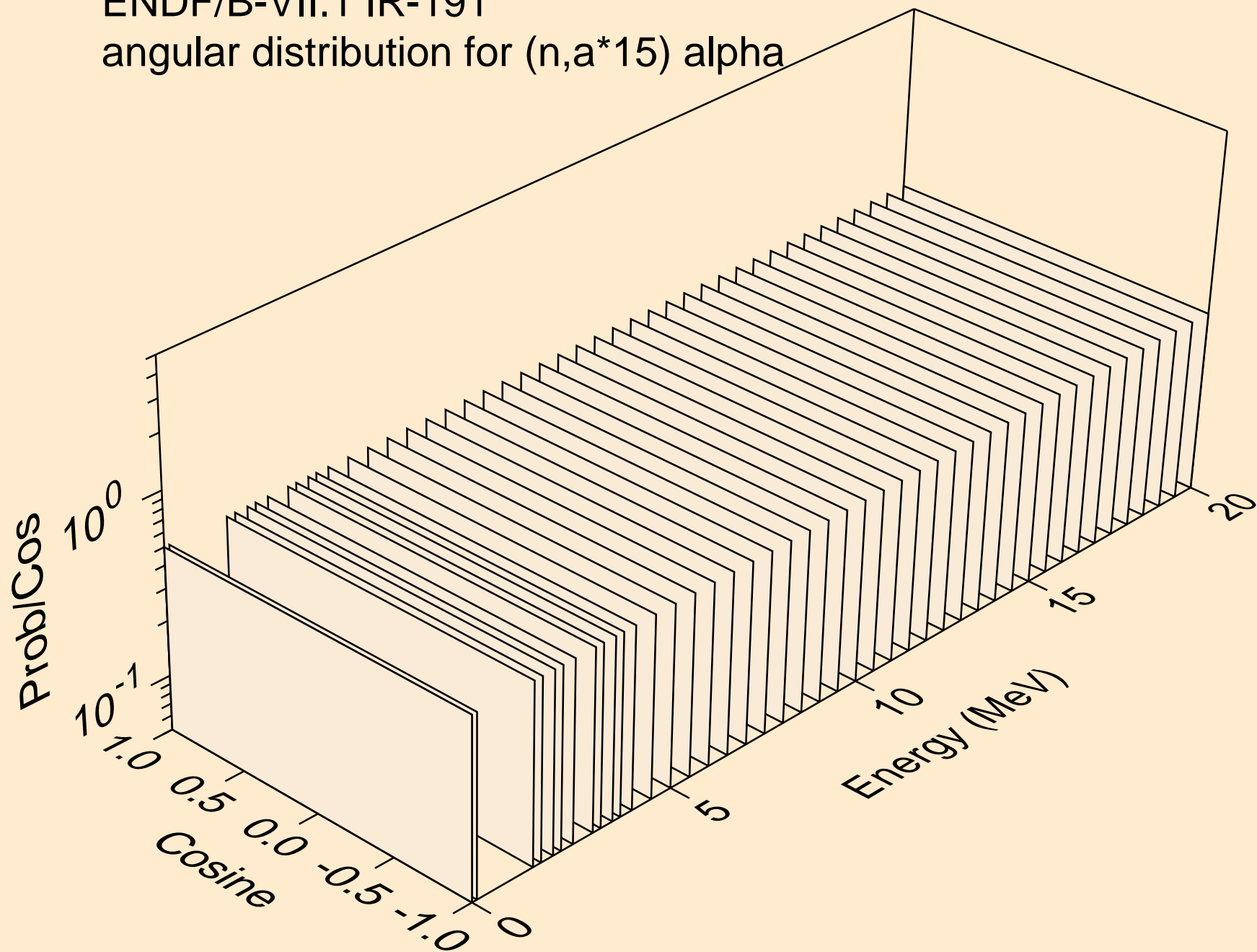

ENDF/B-VII.1 IR-191

angular distribution for (n, α *16) alpha

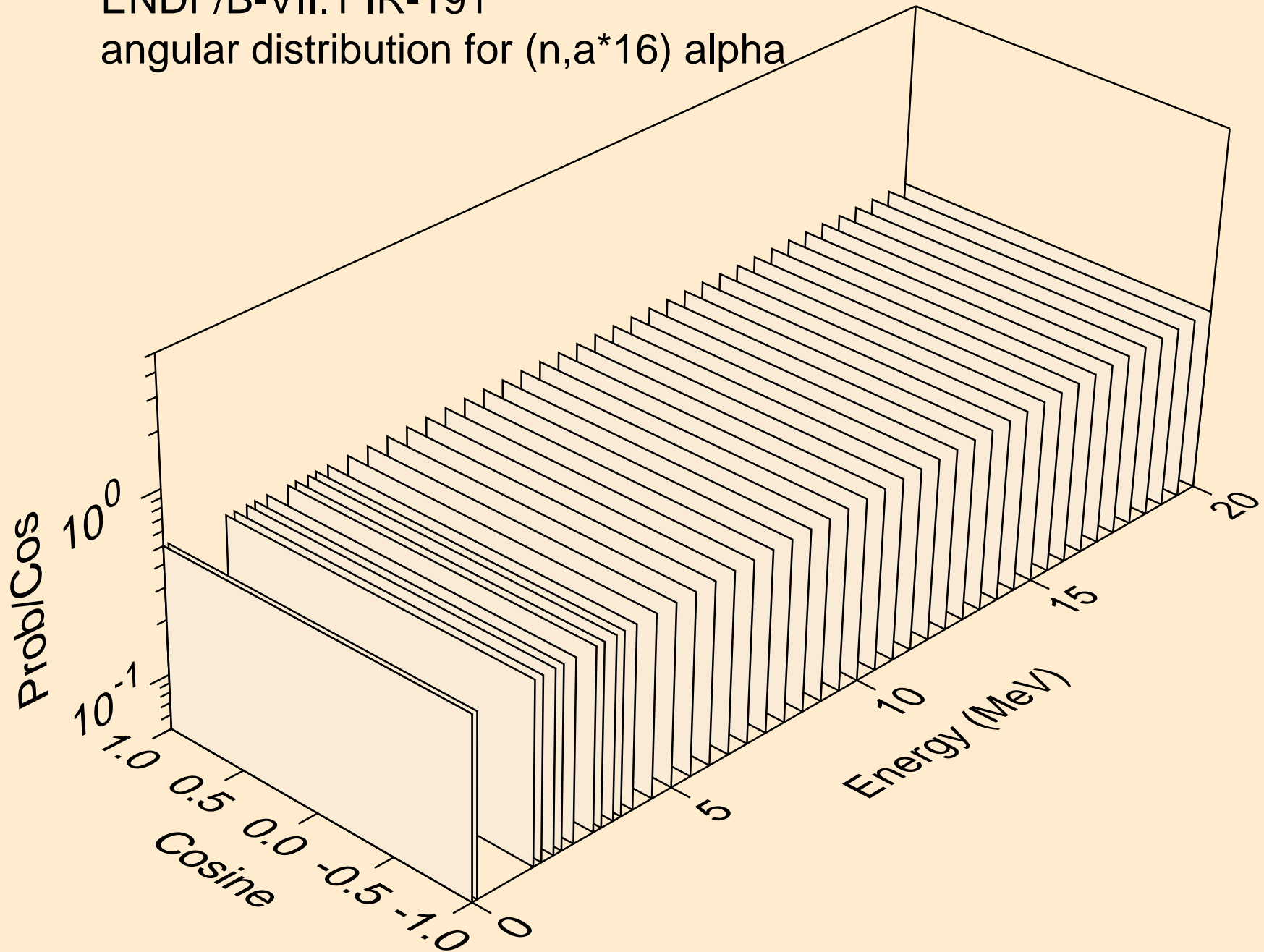

ENDF/B-VII.1 IR-191
angular distribution for (n, α *17) alpha

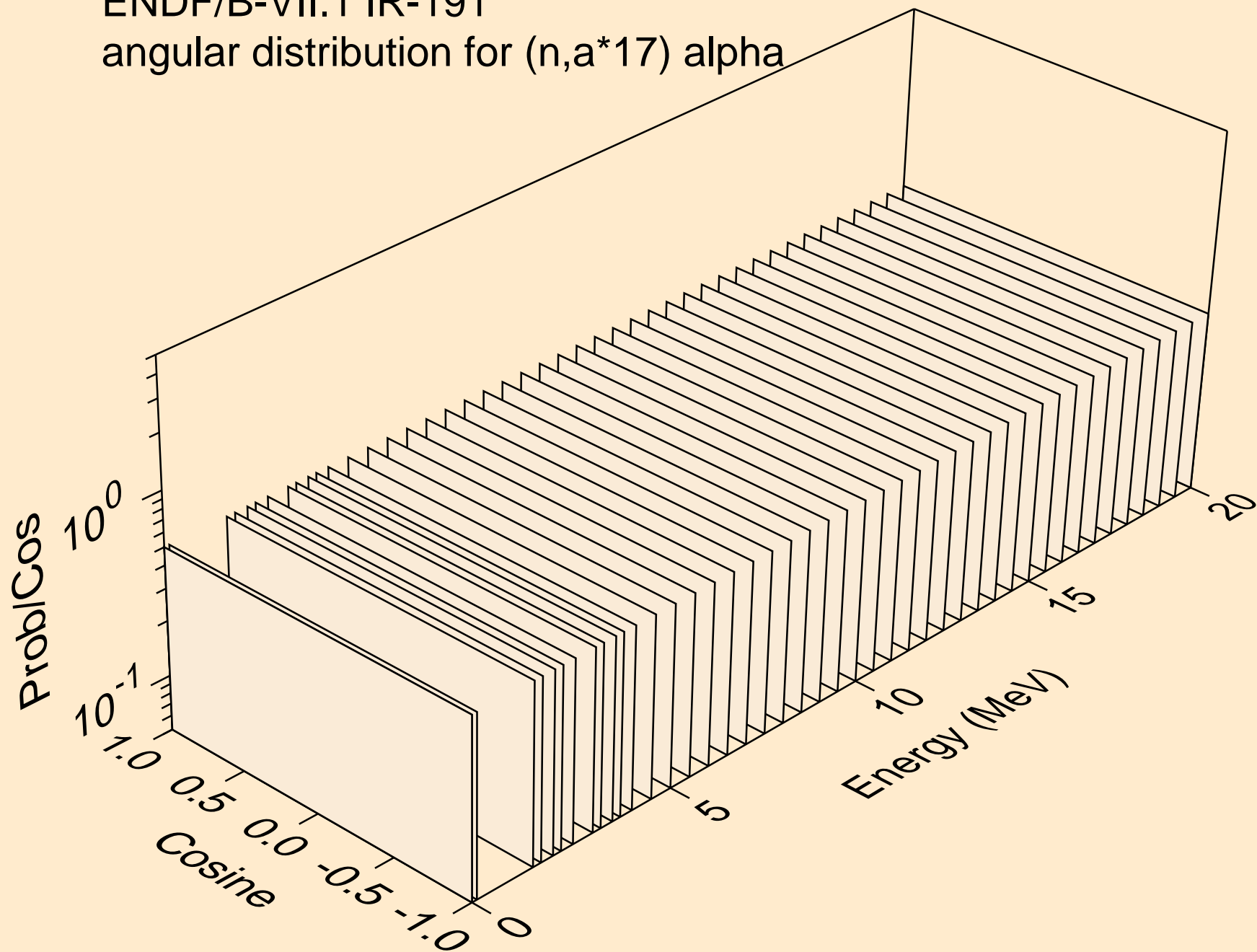

ENDF/B-VII.1 IR-191
angular distribution for (n, α *18) alpha

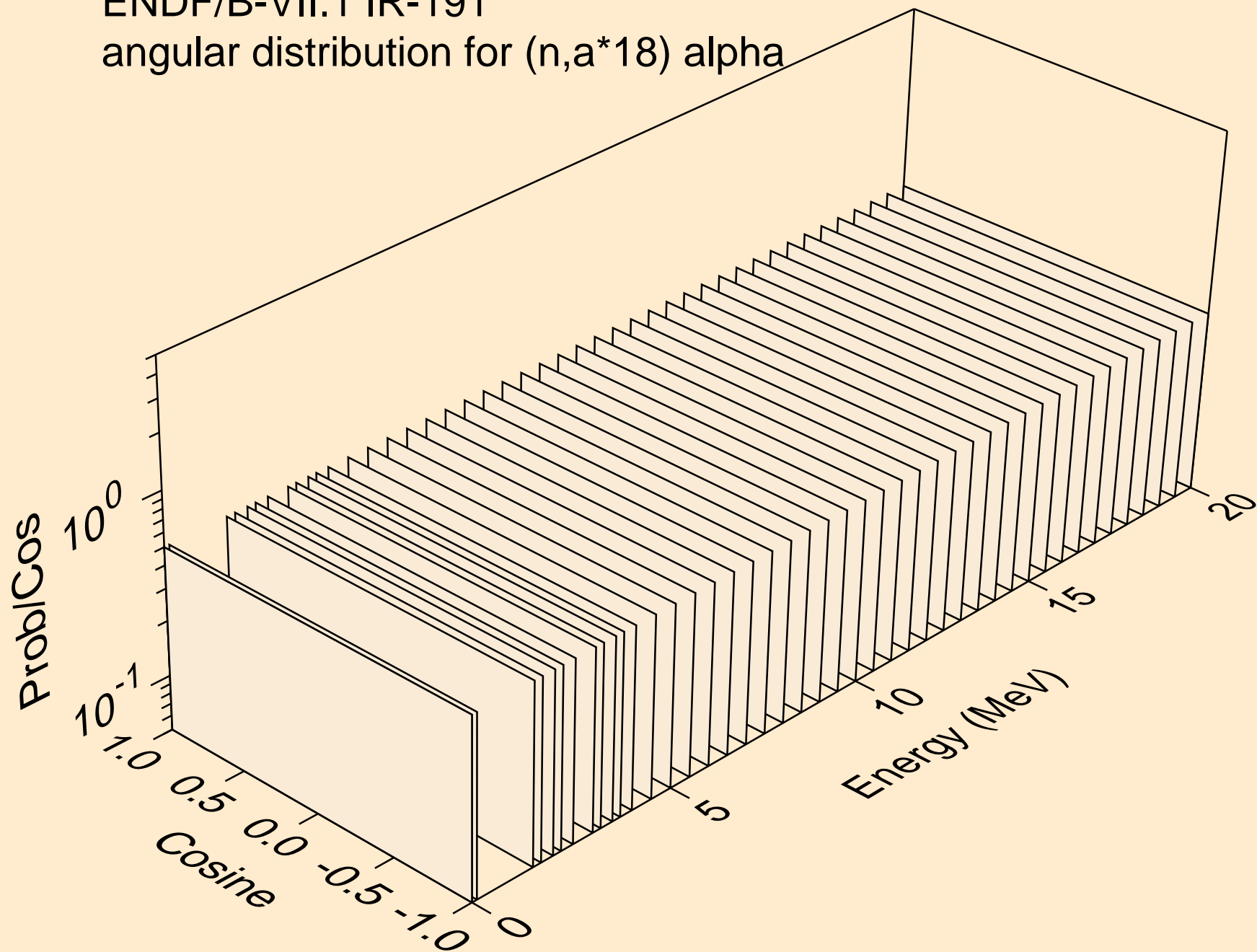

ENDF/B-VII.1 IR-191
angular distribution for (n, α *19) alpha

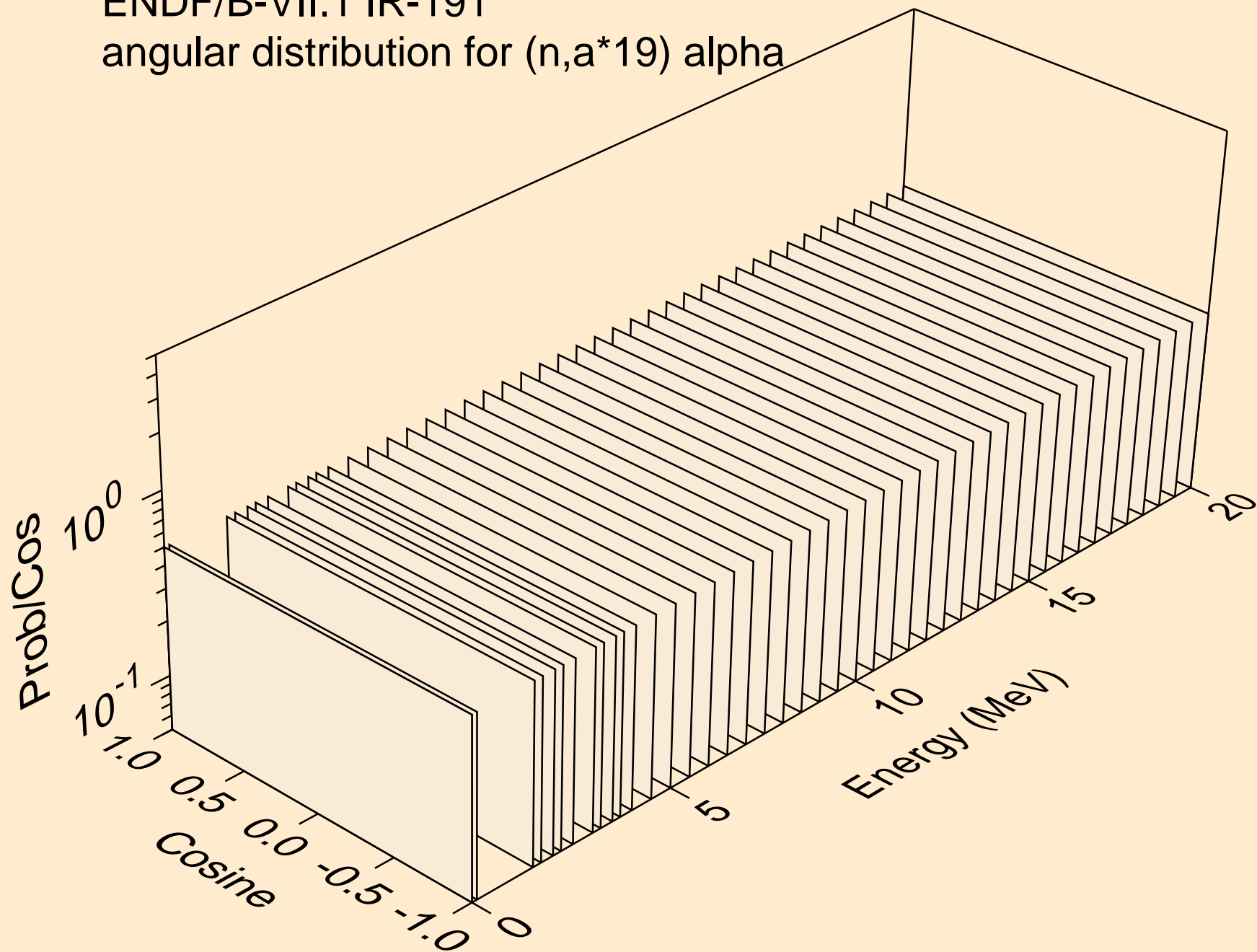

ENDF/B-VII.1 IR-191
angular distribution for (n,a*20) alpha

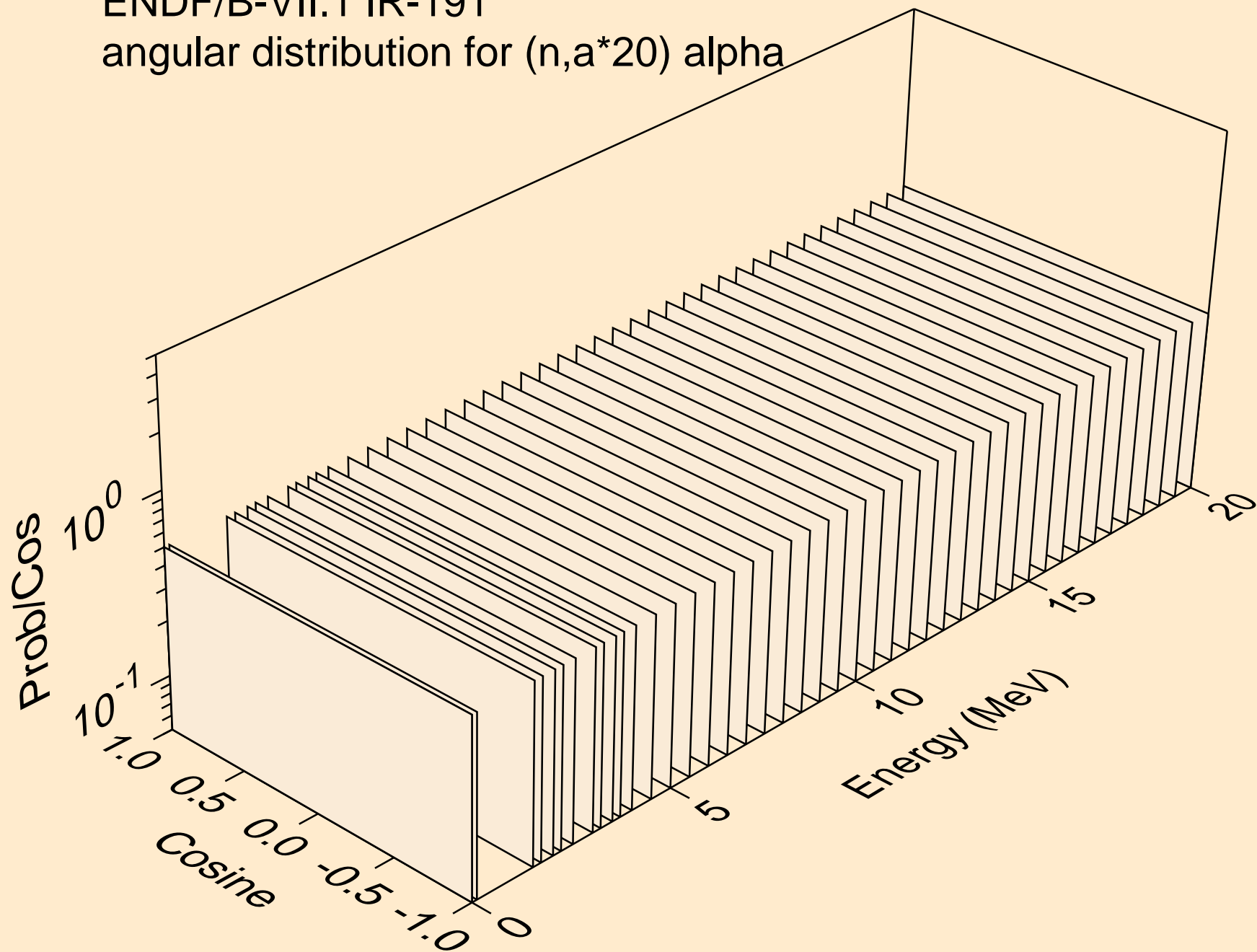

ENDF/B-VII.1 IR-191
angular distribution for (n, α *21) alpha

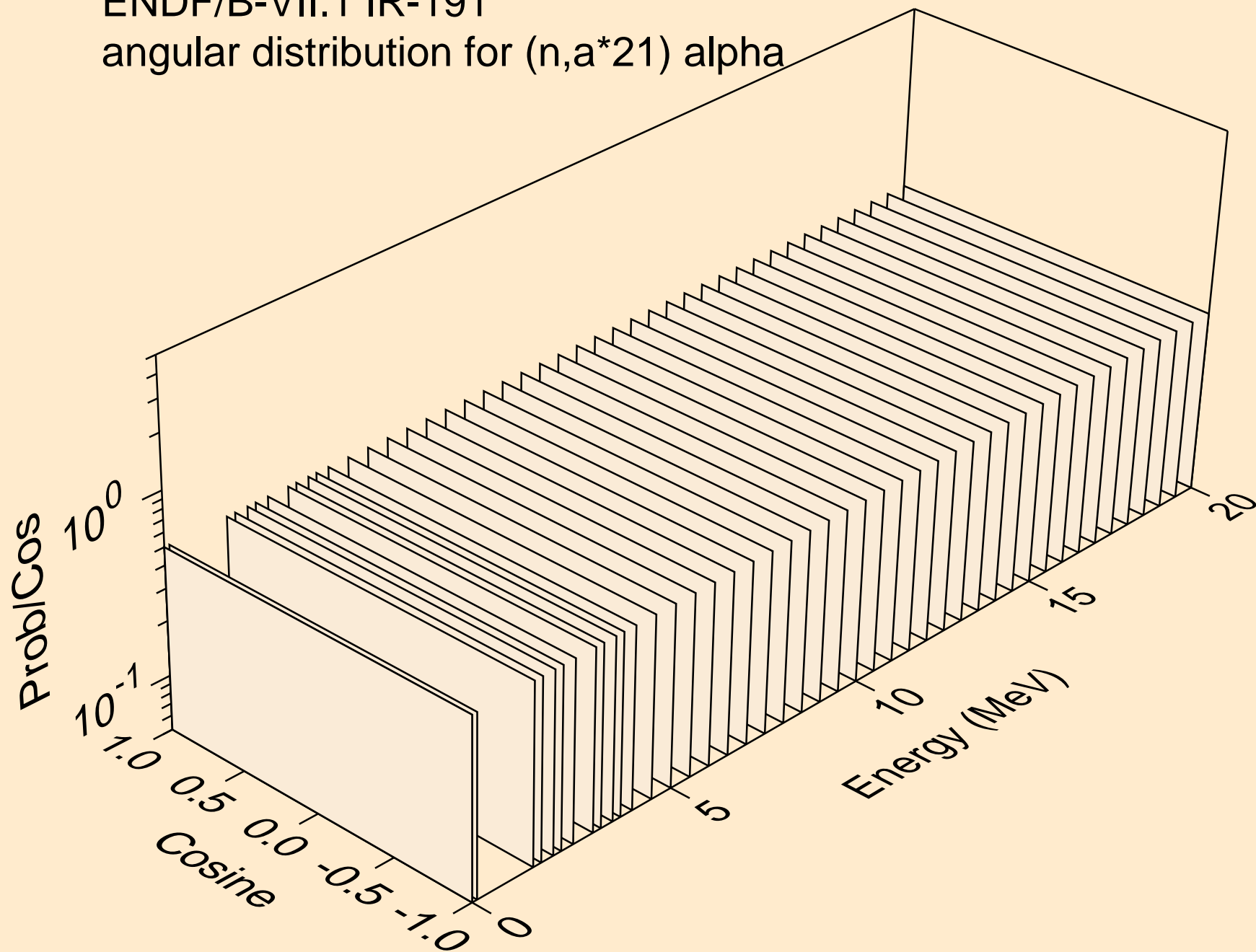

ENDF/B-VII.1 IR-191
angular distribution for (n, α *22) alpha

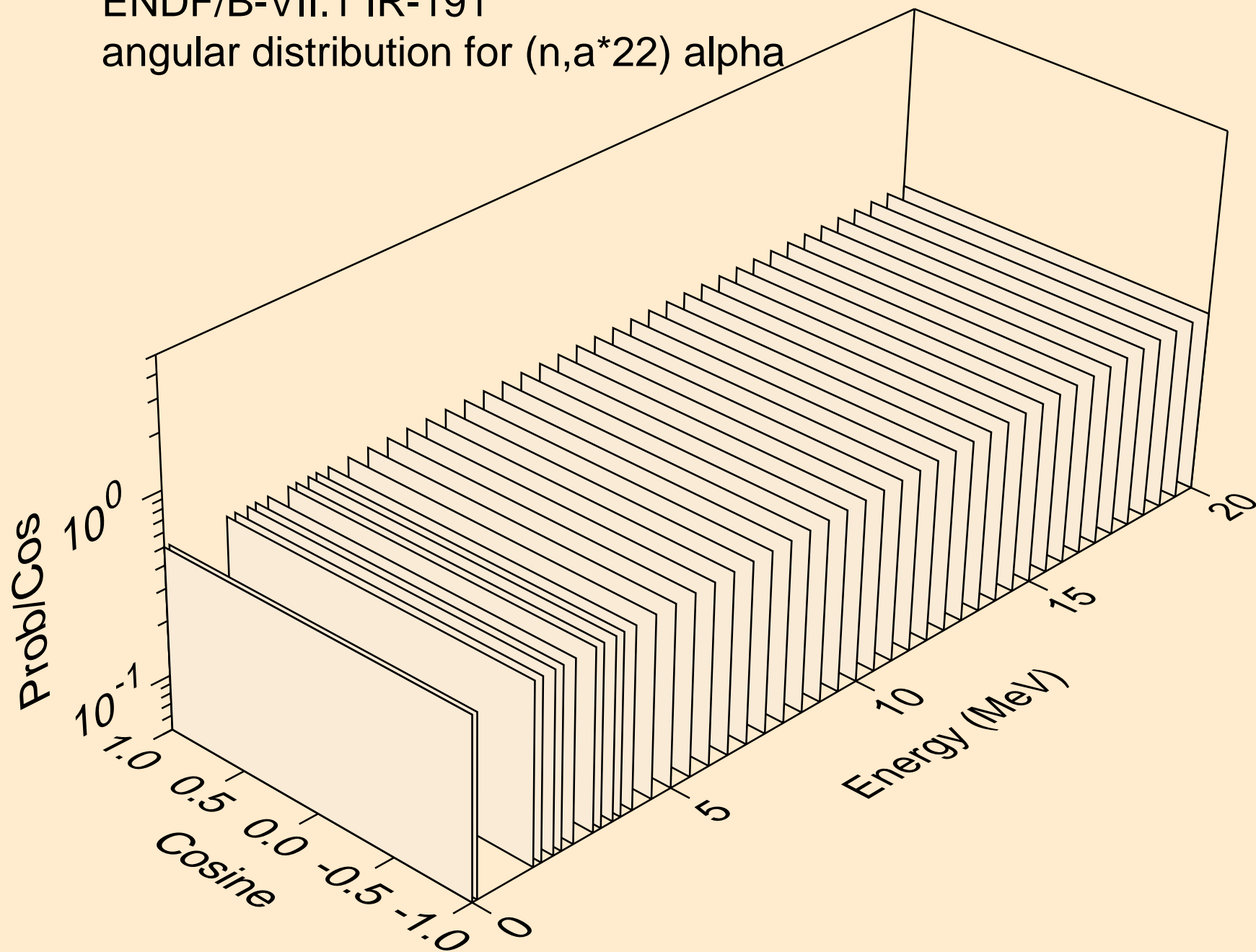

ENDF/B-VII.1 IR-191
angular distribution for (n, α *23) alpha

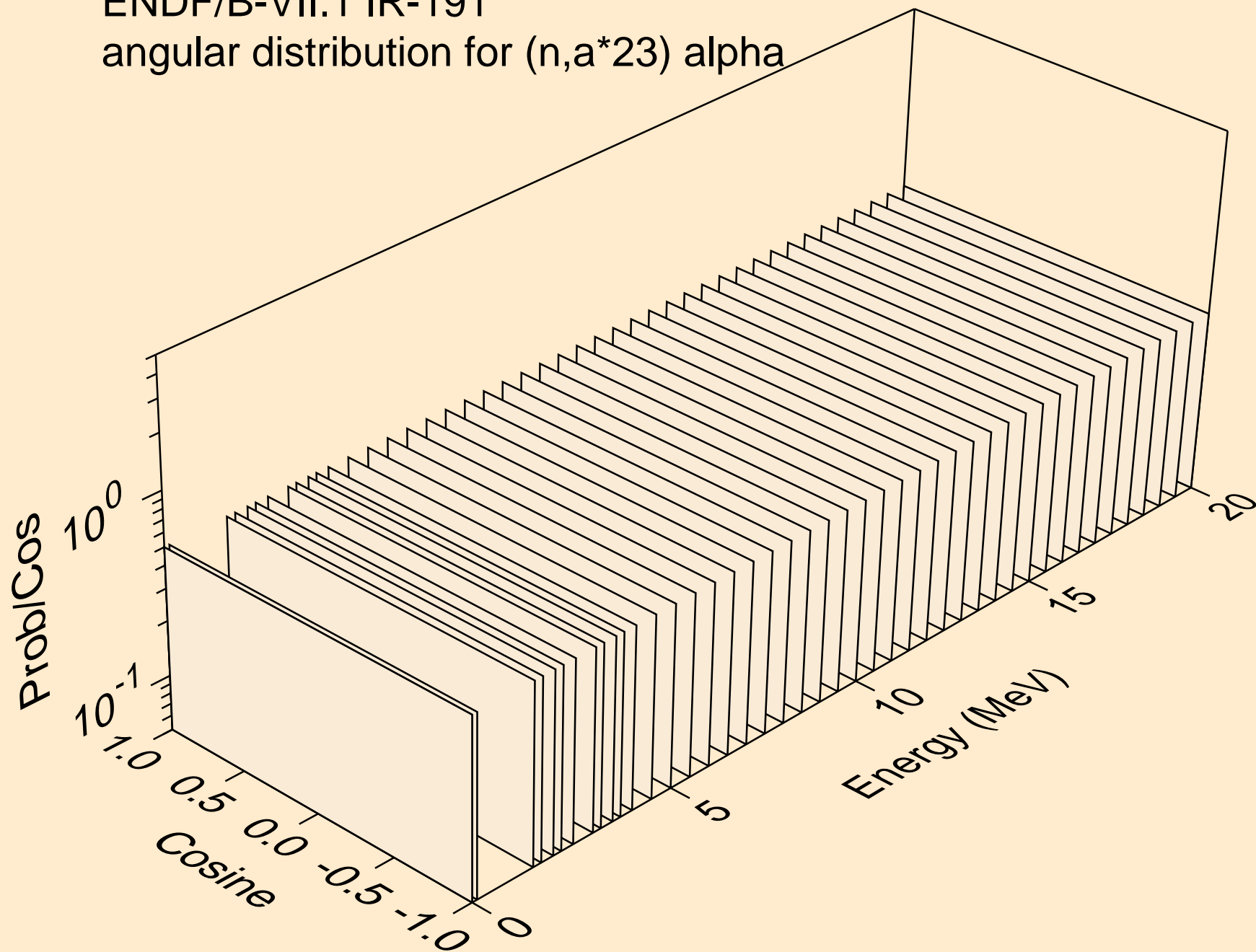

ENDF/B-VII.1 IR-191
angular distribution for (n, α *24) alpha

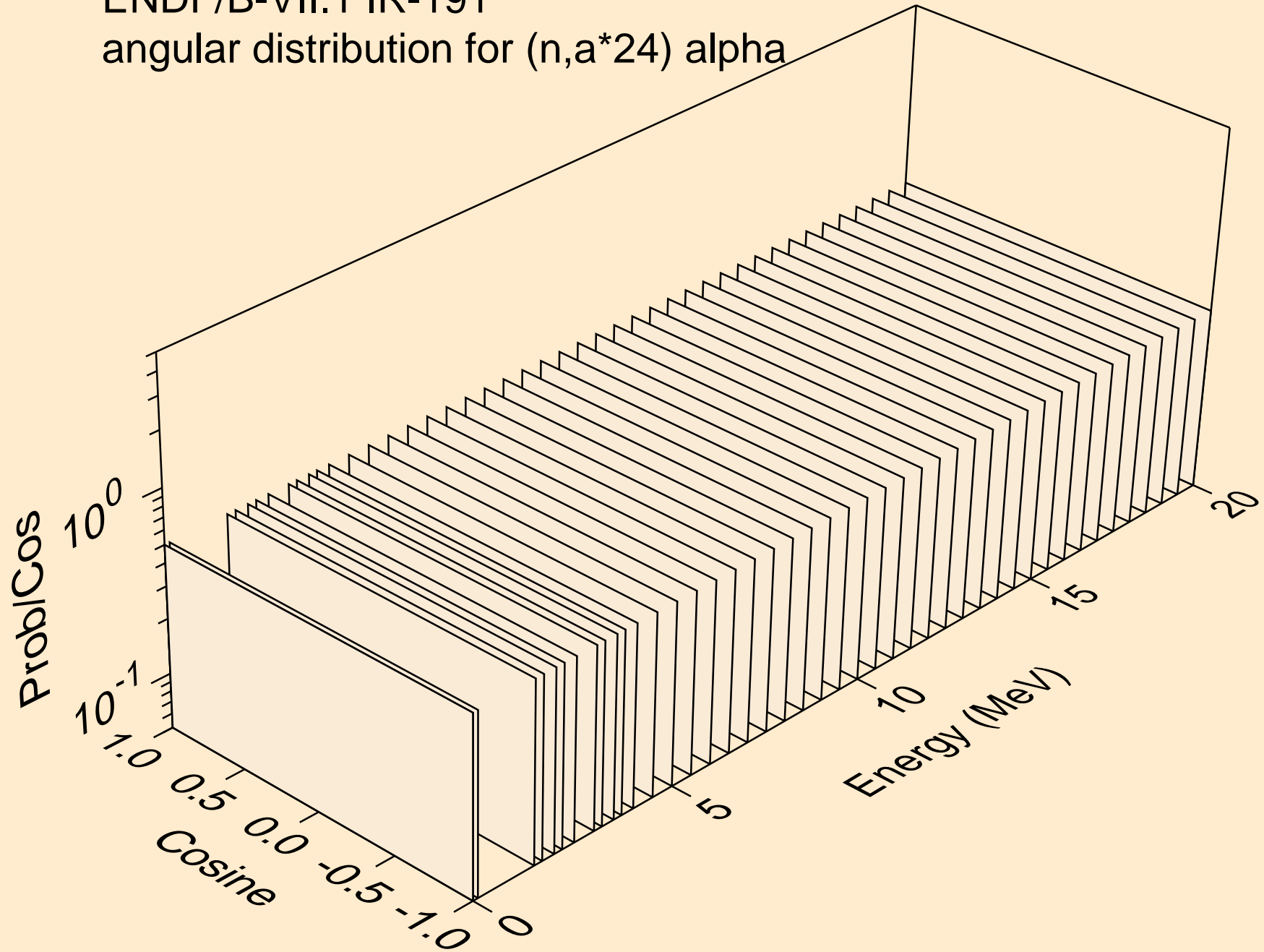

ENDF/B-VII.1 IR-191
angular distribution for (n,a*25) alpha

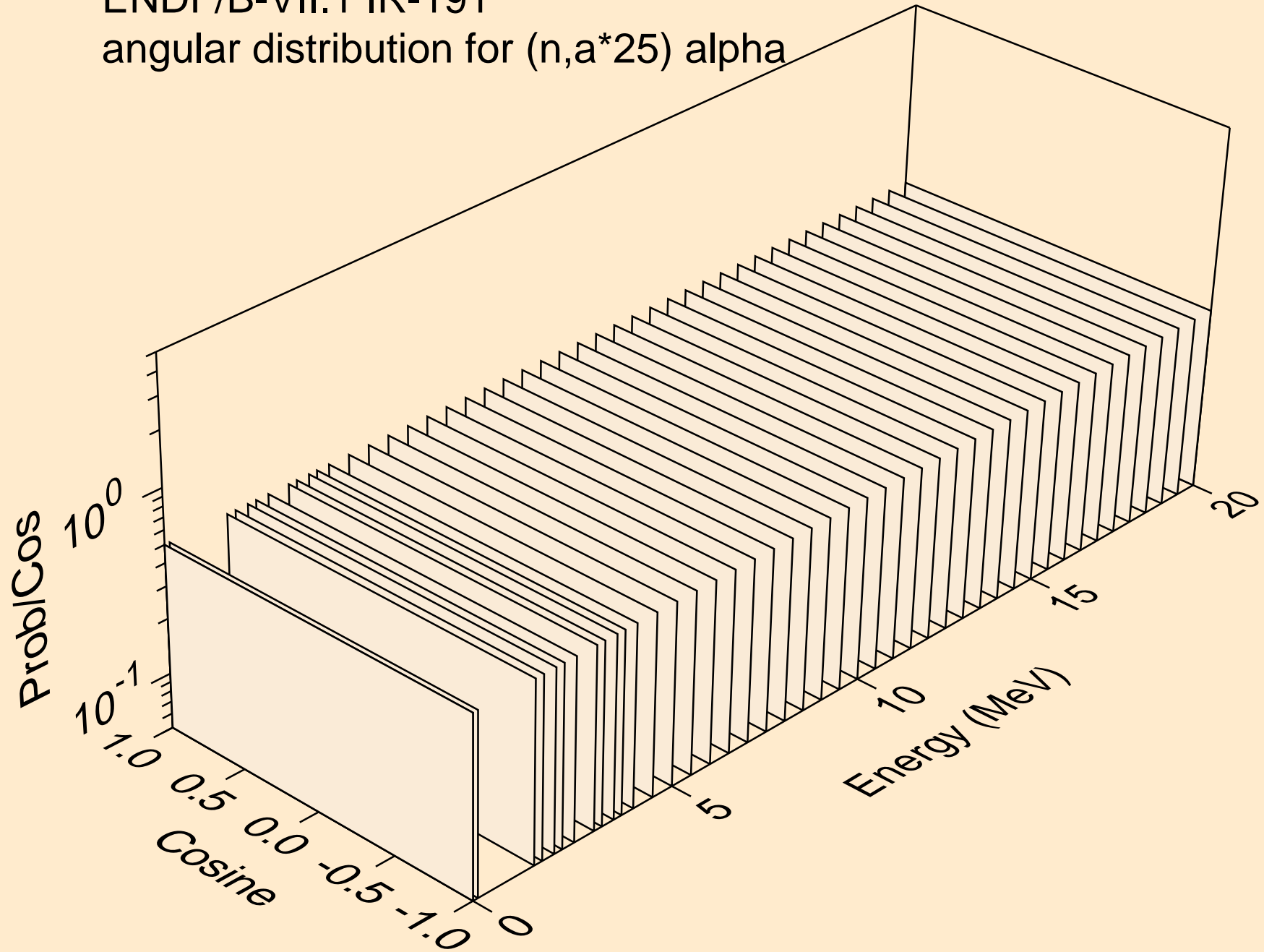

ENDF/B-VII.1 IR-191
angular distribution for (n, α *26) alpha

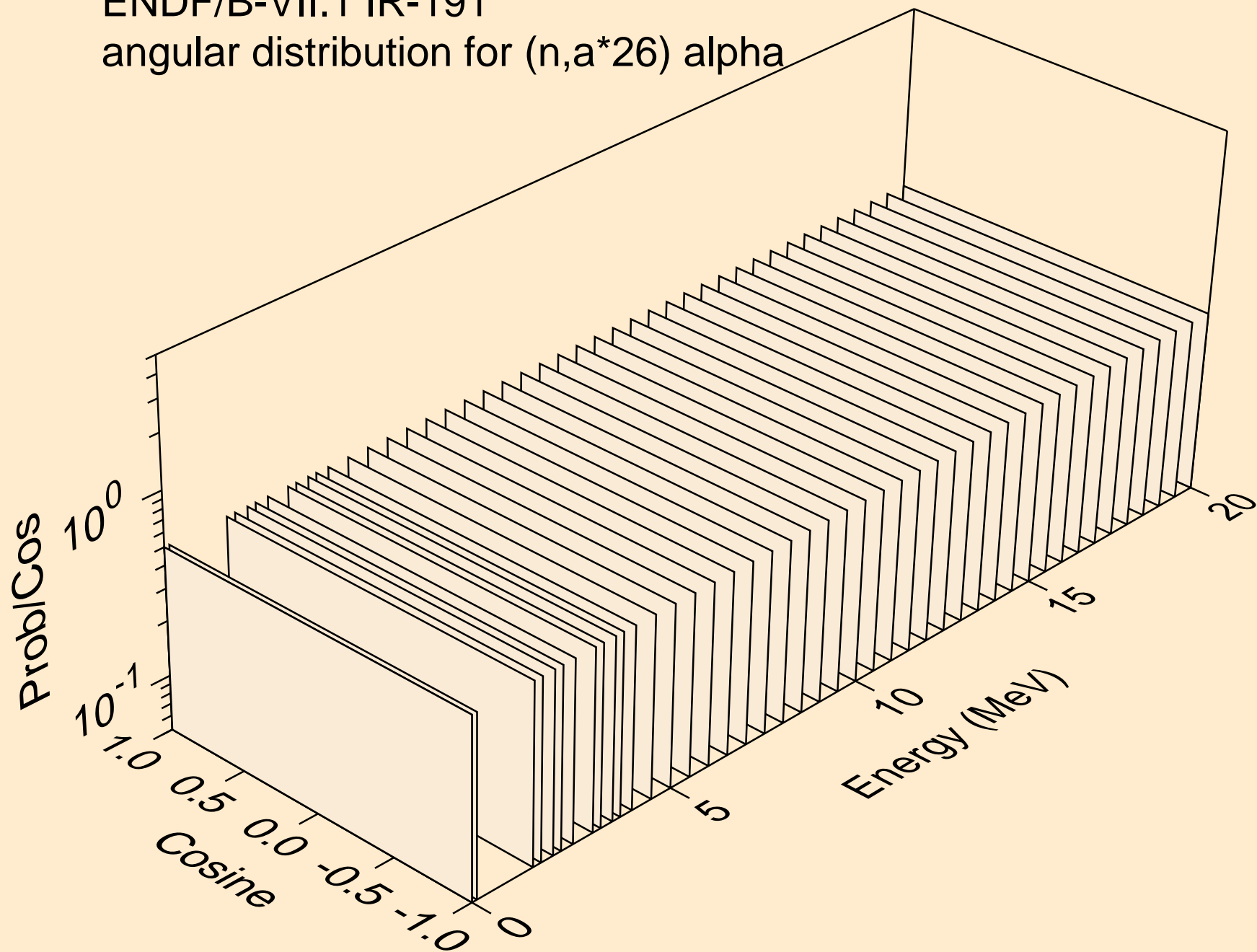

ENDF/B-VII.1 IR-191
angular distribution for (n, α *27) alpha

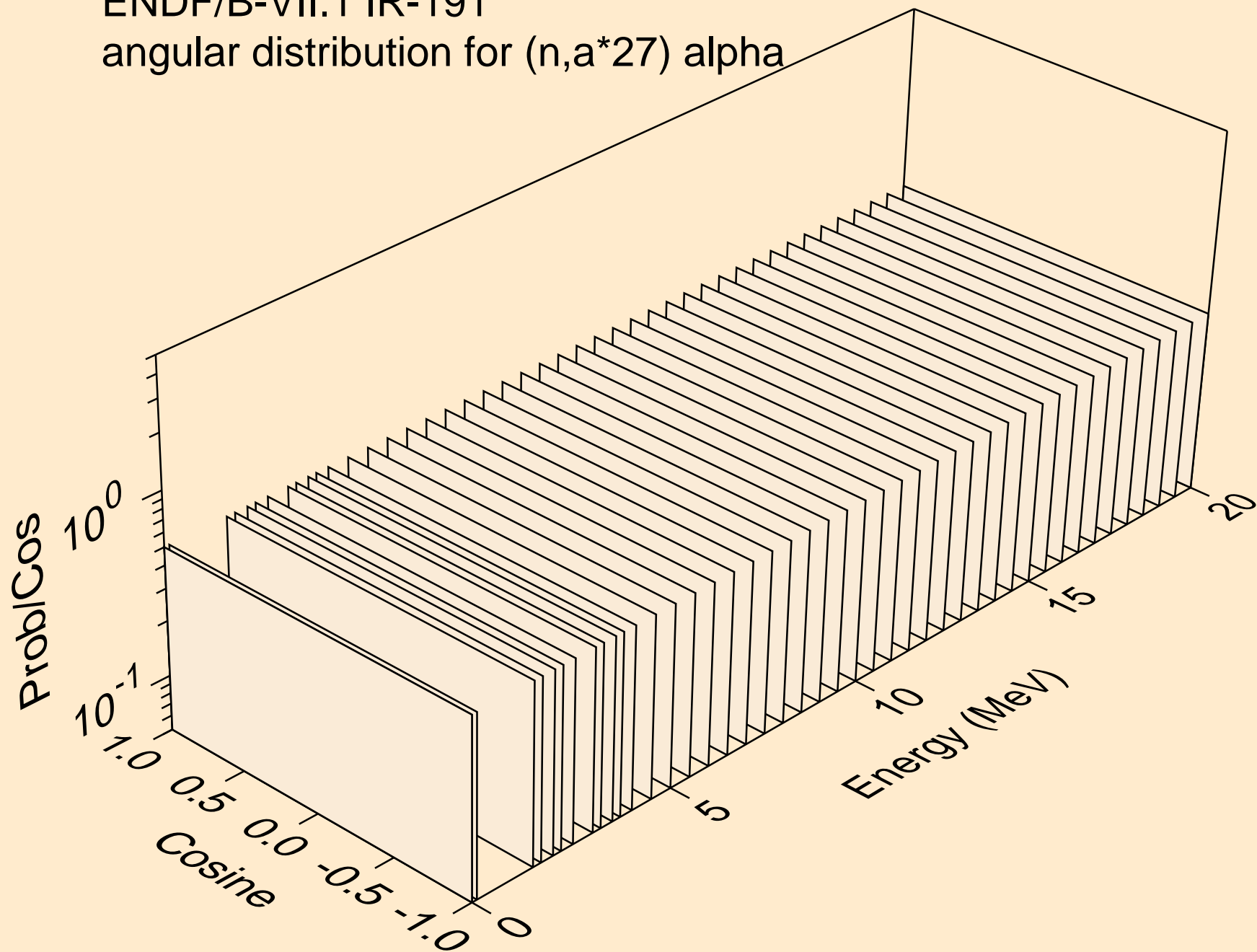

ENDF/B-VII.1 IR-191
angular distribution for (n, α *28) alpha

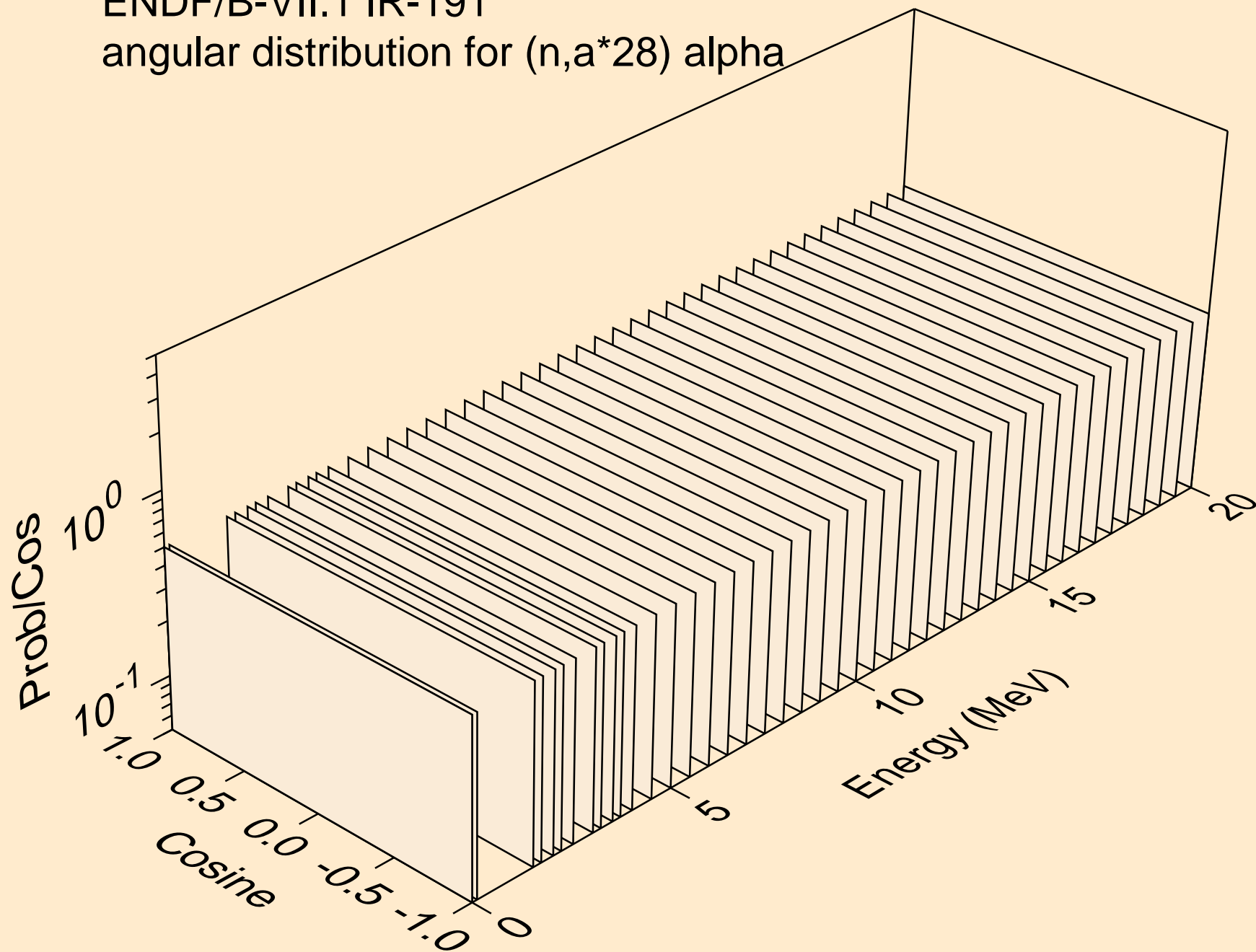

ENDF/B-VII.1 IR-191
angular distribution for (n, α *29) alpha

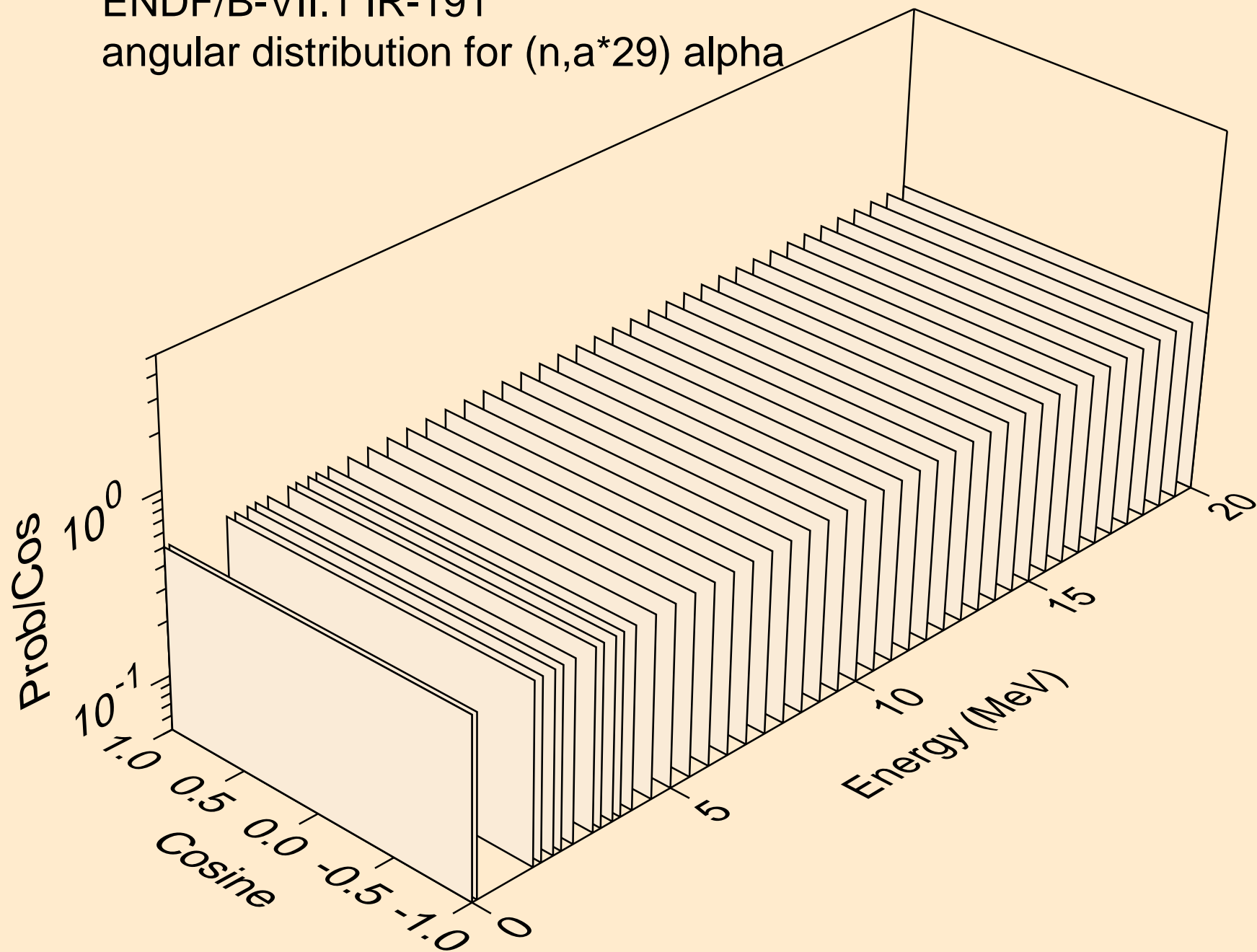

ENDF/B-VII.1 IR-191
angular distribution for (n,a*30) alpha

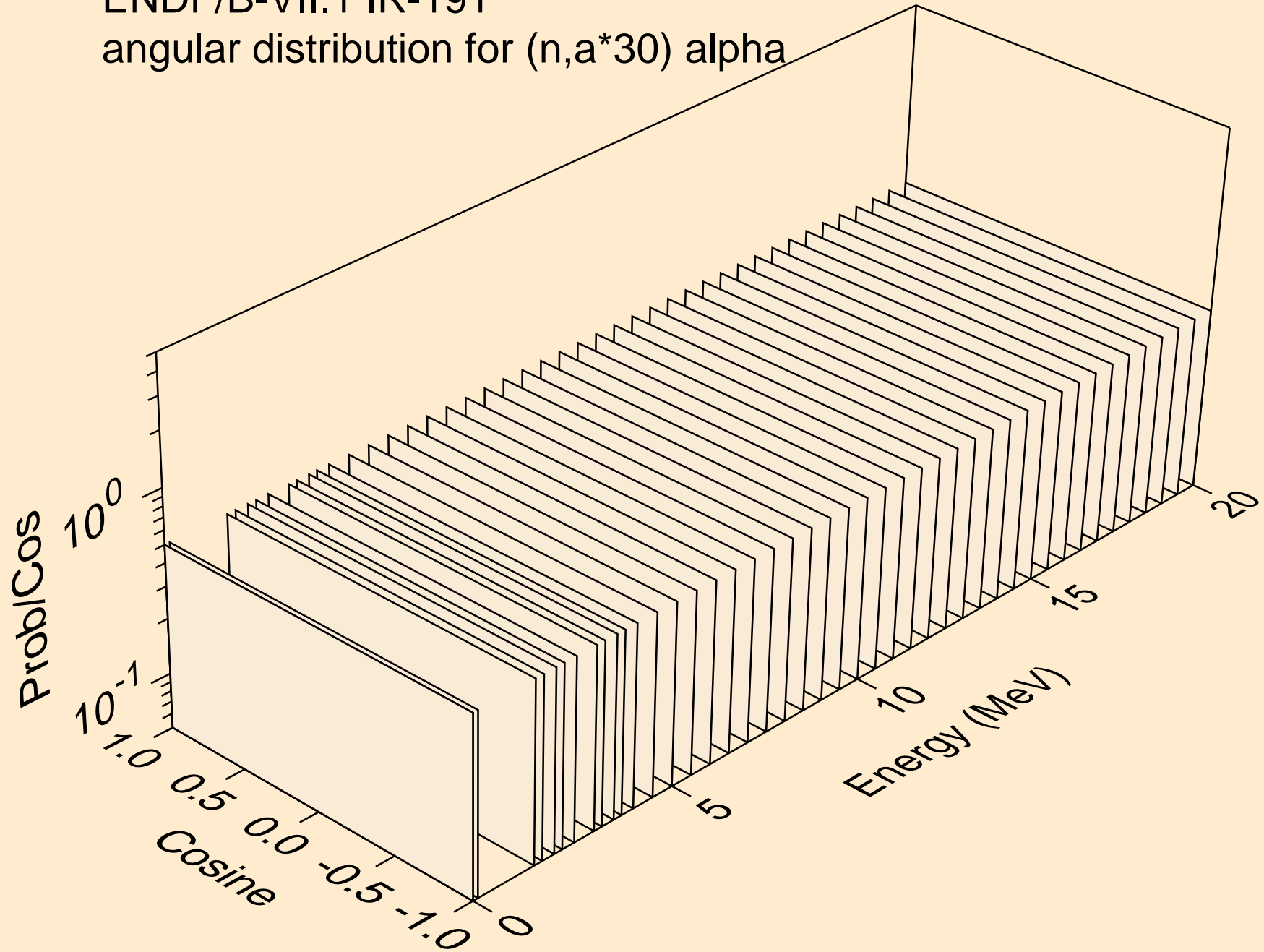

ENDF/B-VII.1 IR-191
angular distribution for (n,a*31) alpha

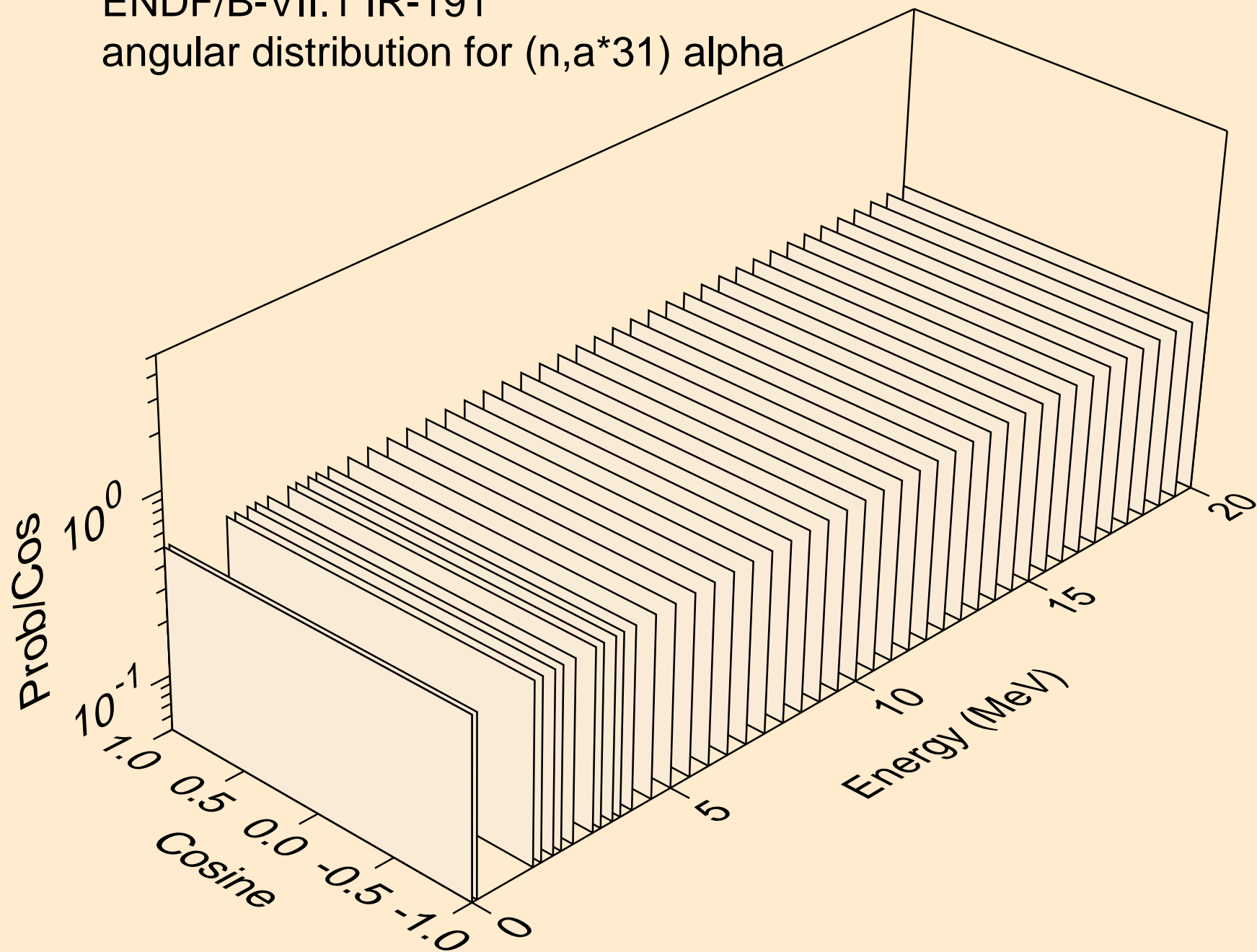

ENDF/B-VII.1 IR-191
angular distribution for (n, α *32) alpha

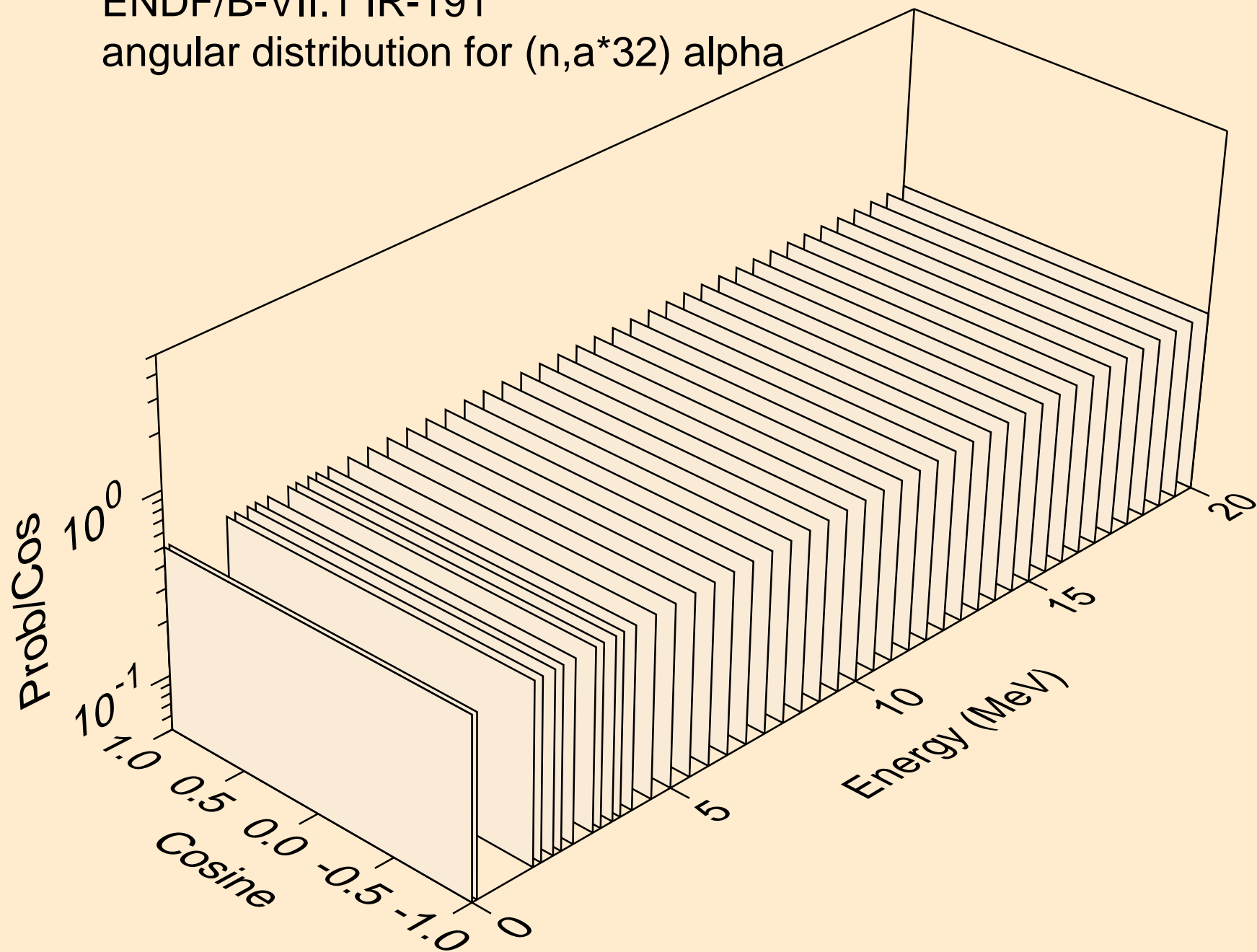

ENDF/B-VII.1 IR-191
angular distribution for (n, α *33) alpha

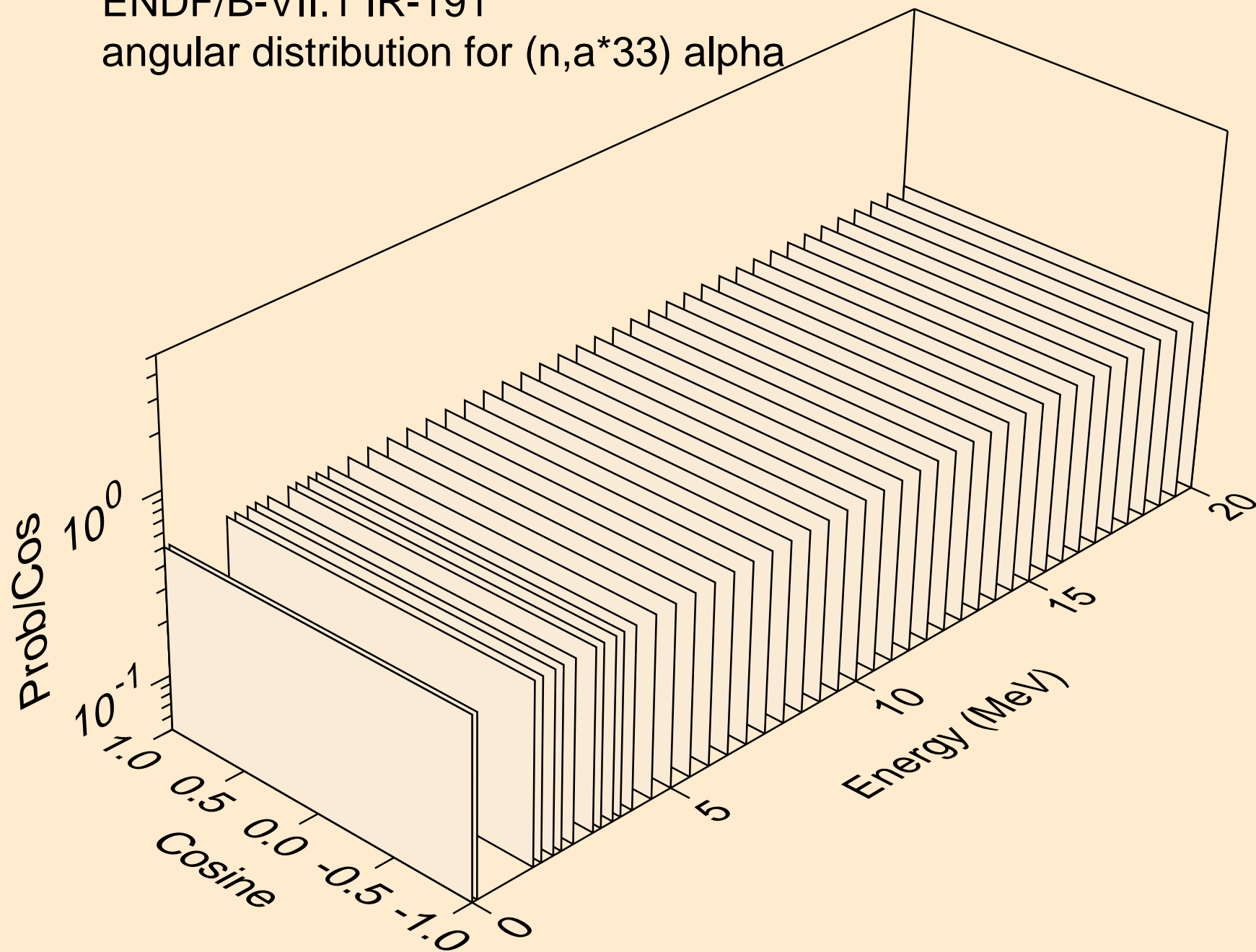

ENDF/B-VII.1 IR-191
angular distribution for (n, α *34) alpha

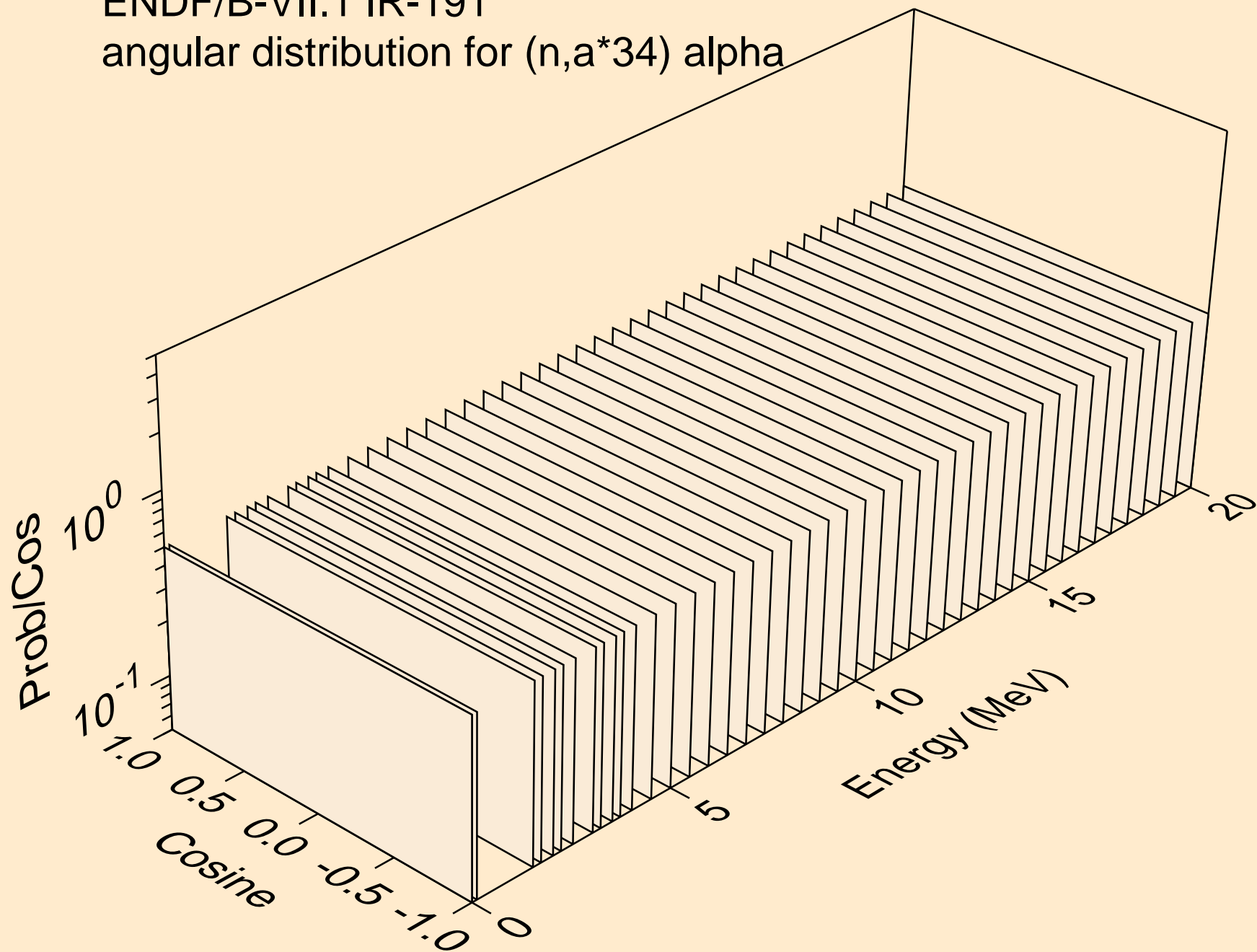

ENDF/B-VII.1 IR-191
angular distribution for (n, α *35) alpha

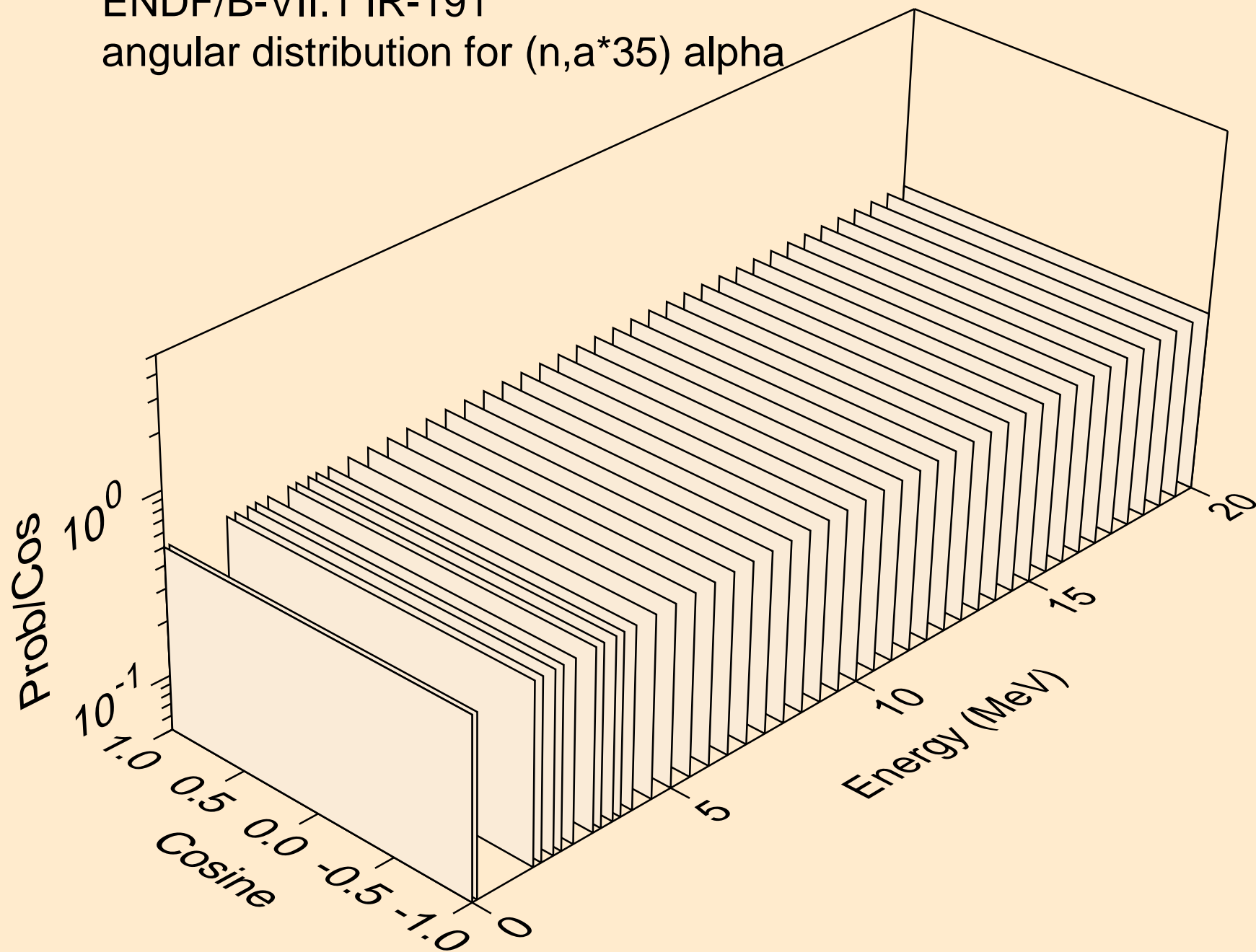

ENDF/B-VII.1 IR-191
angular distribution for (n, α *36) alpha

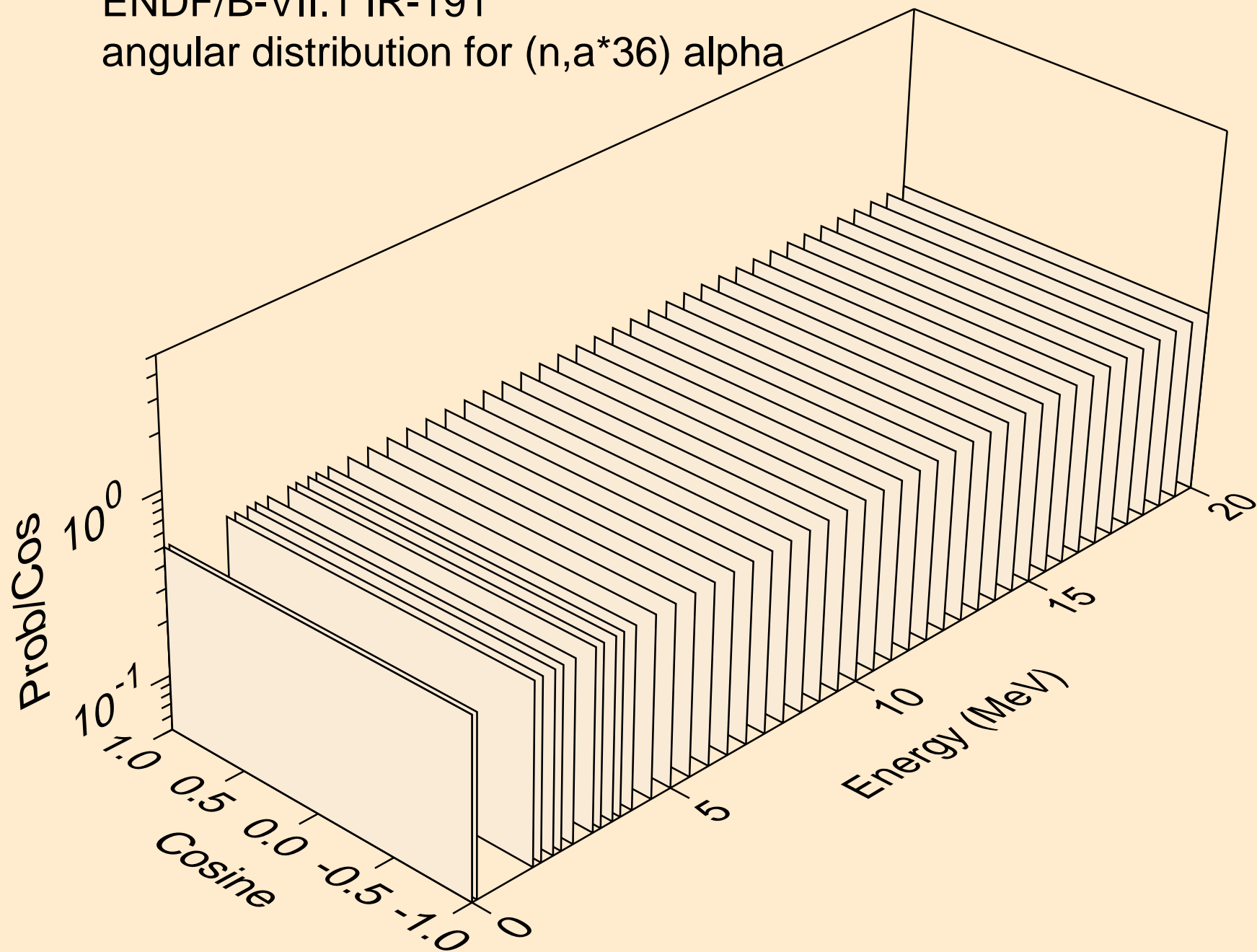

ENDF/B-VII.1 IR-191
angular distribution for (n, α *37) alpha

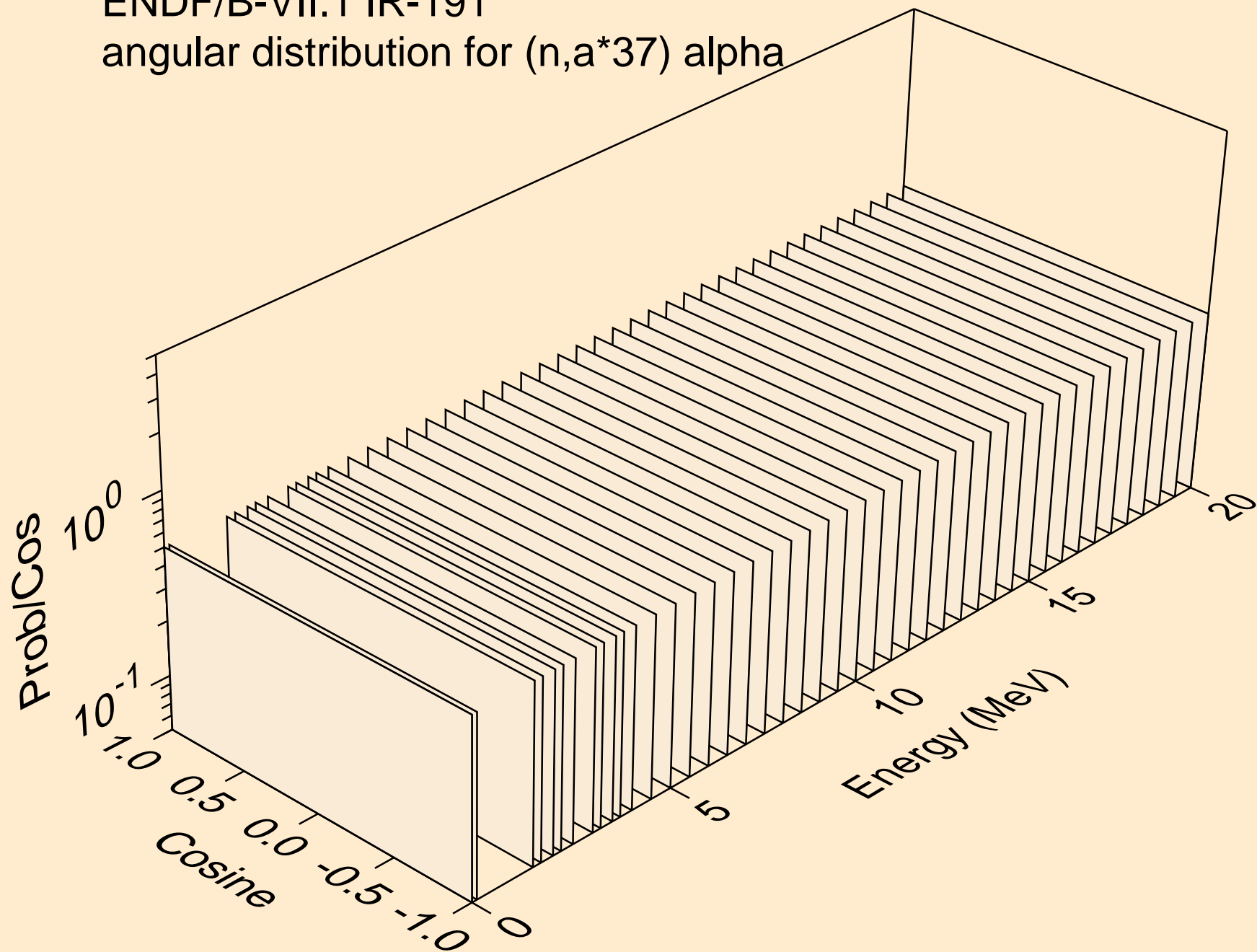

ENDF/B-VII.1 IR-191
angular distribution for (n, α *38) alpha

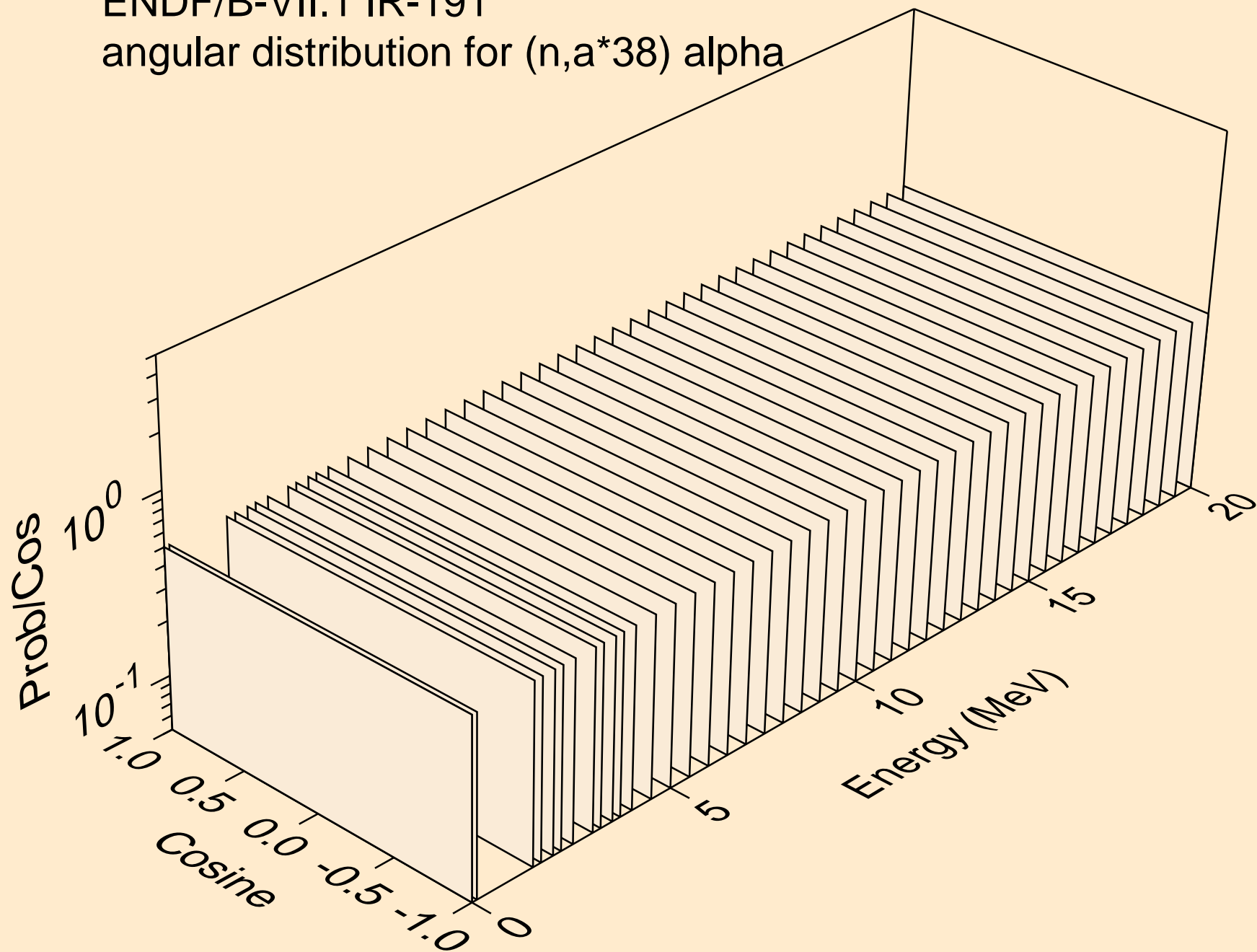

ENDF/B-VII.1 IR-191
angular distribution for (n, α *39) alpha

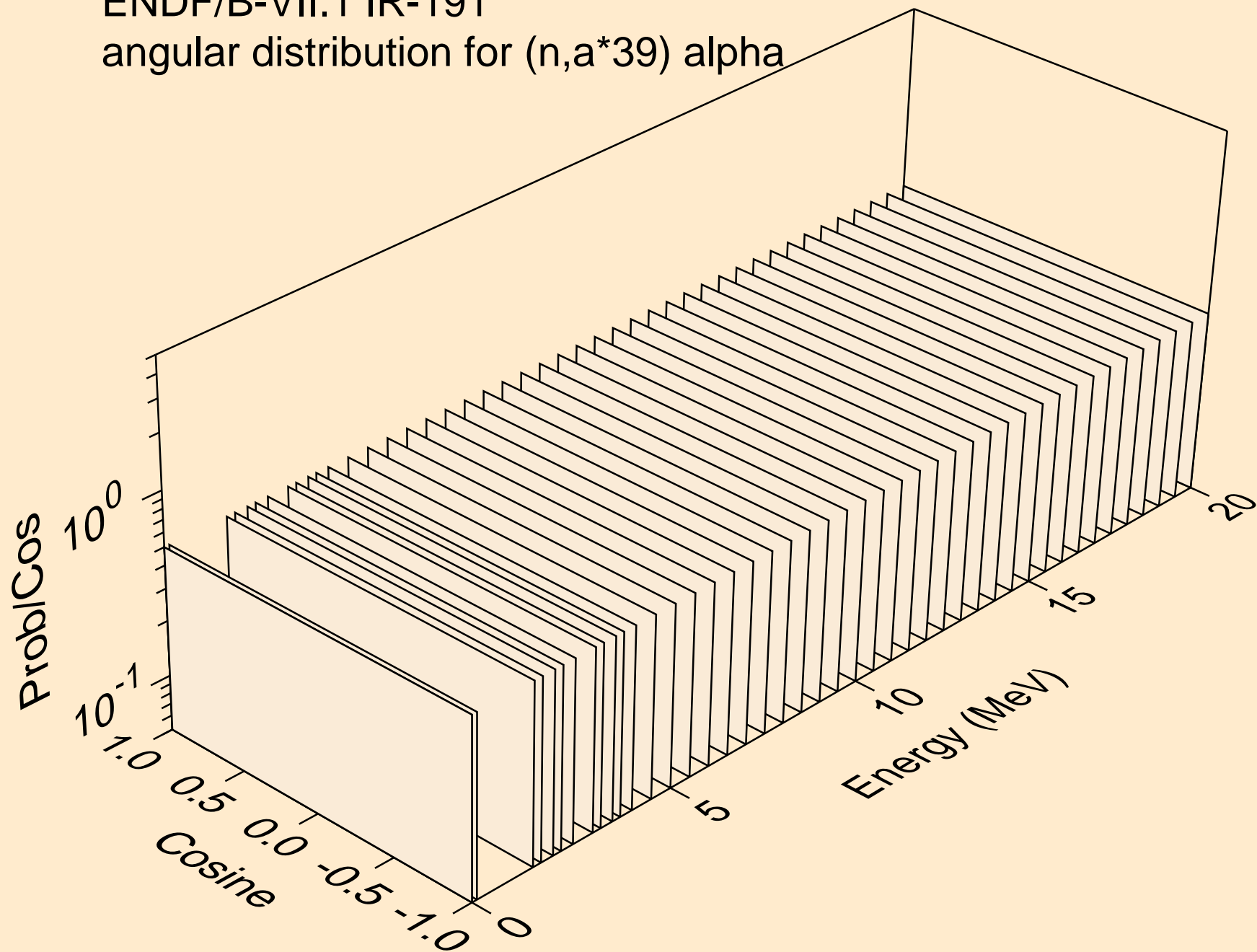

ENDF/B-VII.1 IR-191
alphas from (n,a*c)

