

ENDF/B-VII.1 HF-178

Principal cross sections

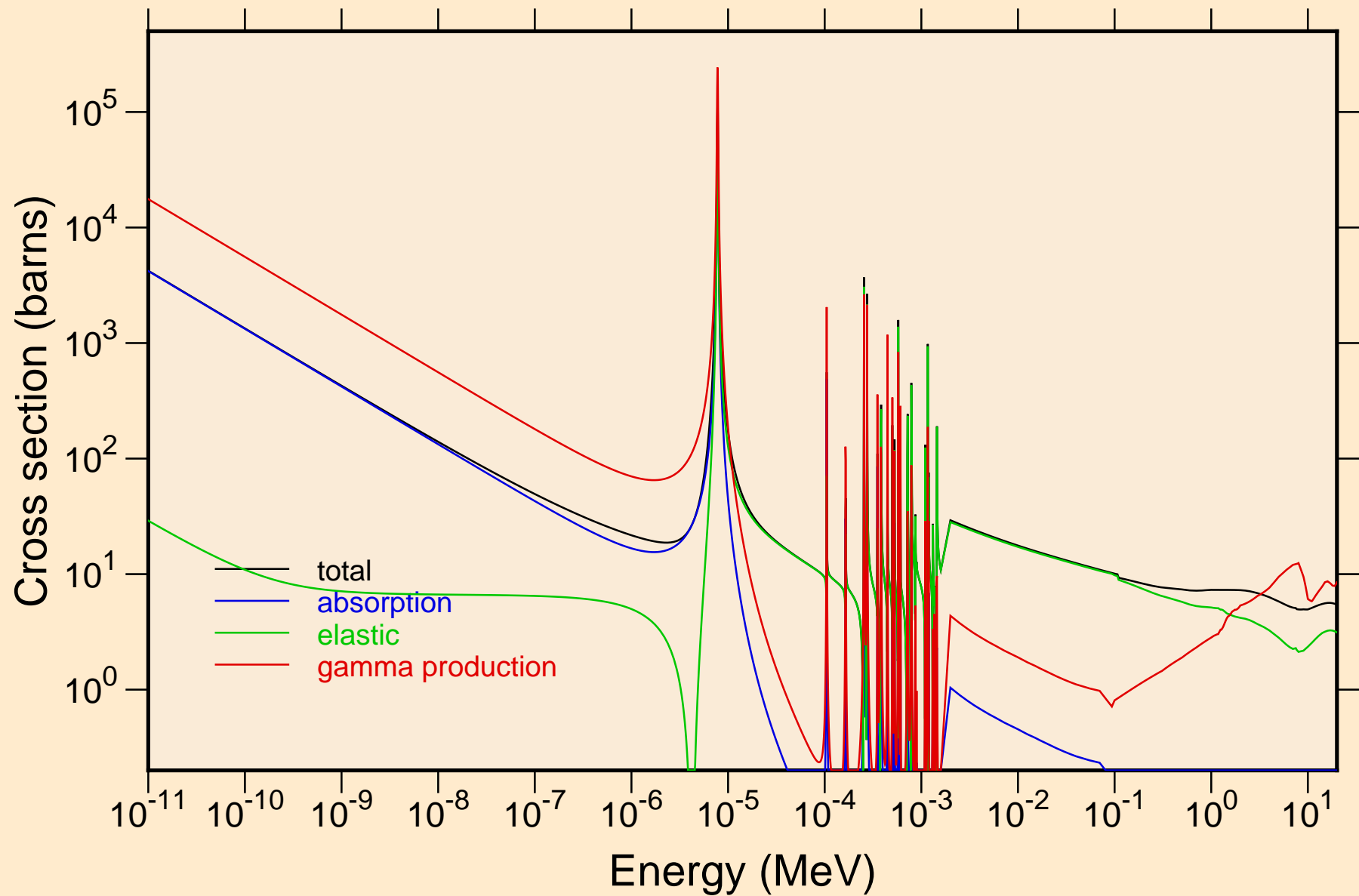

ENDF/B-VII.1 HF-178
resonance total cross section

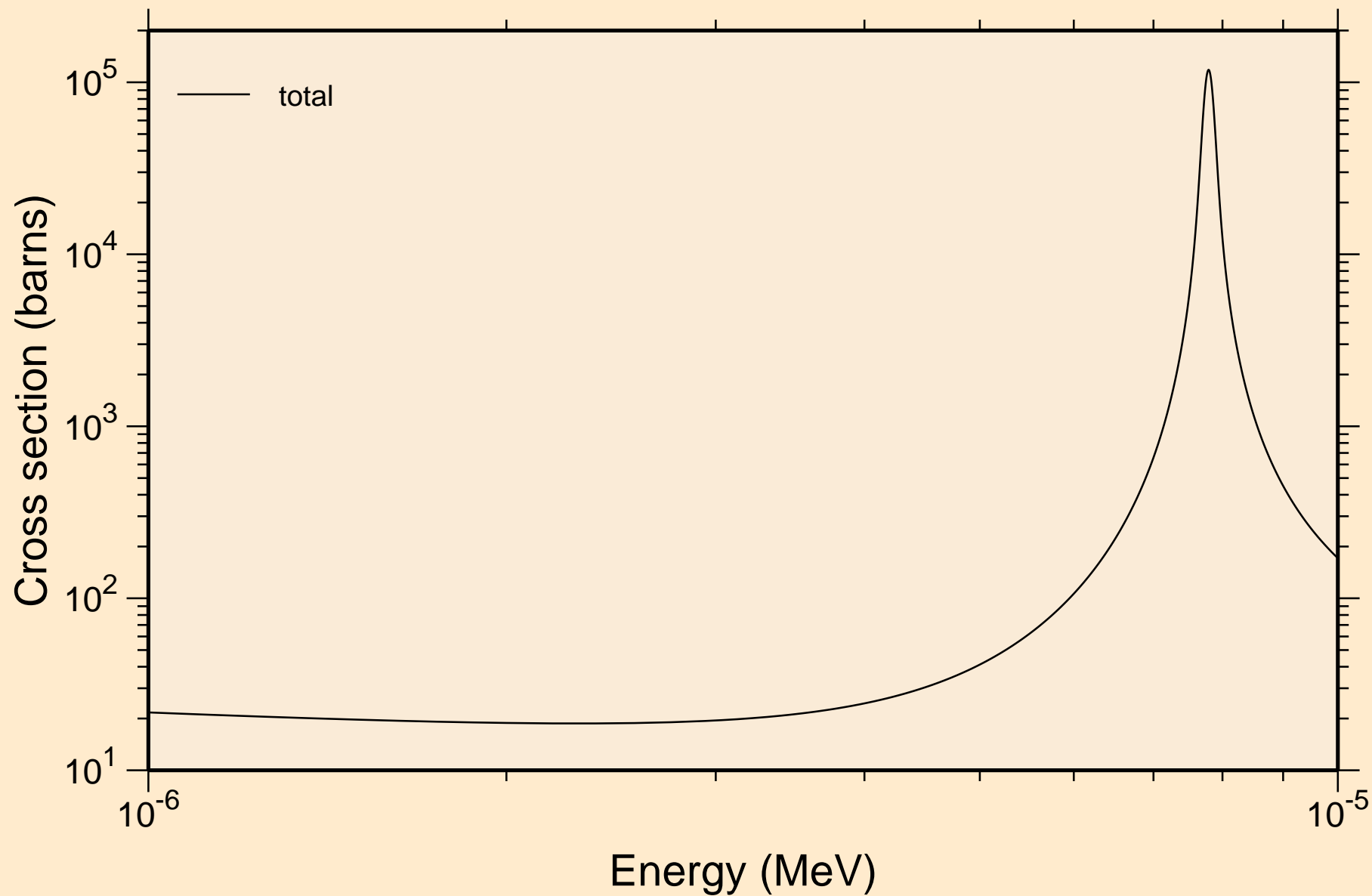

ENDF/B-VII.1 HF-178
resonance total cross section

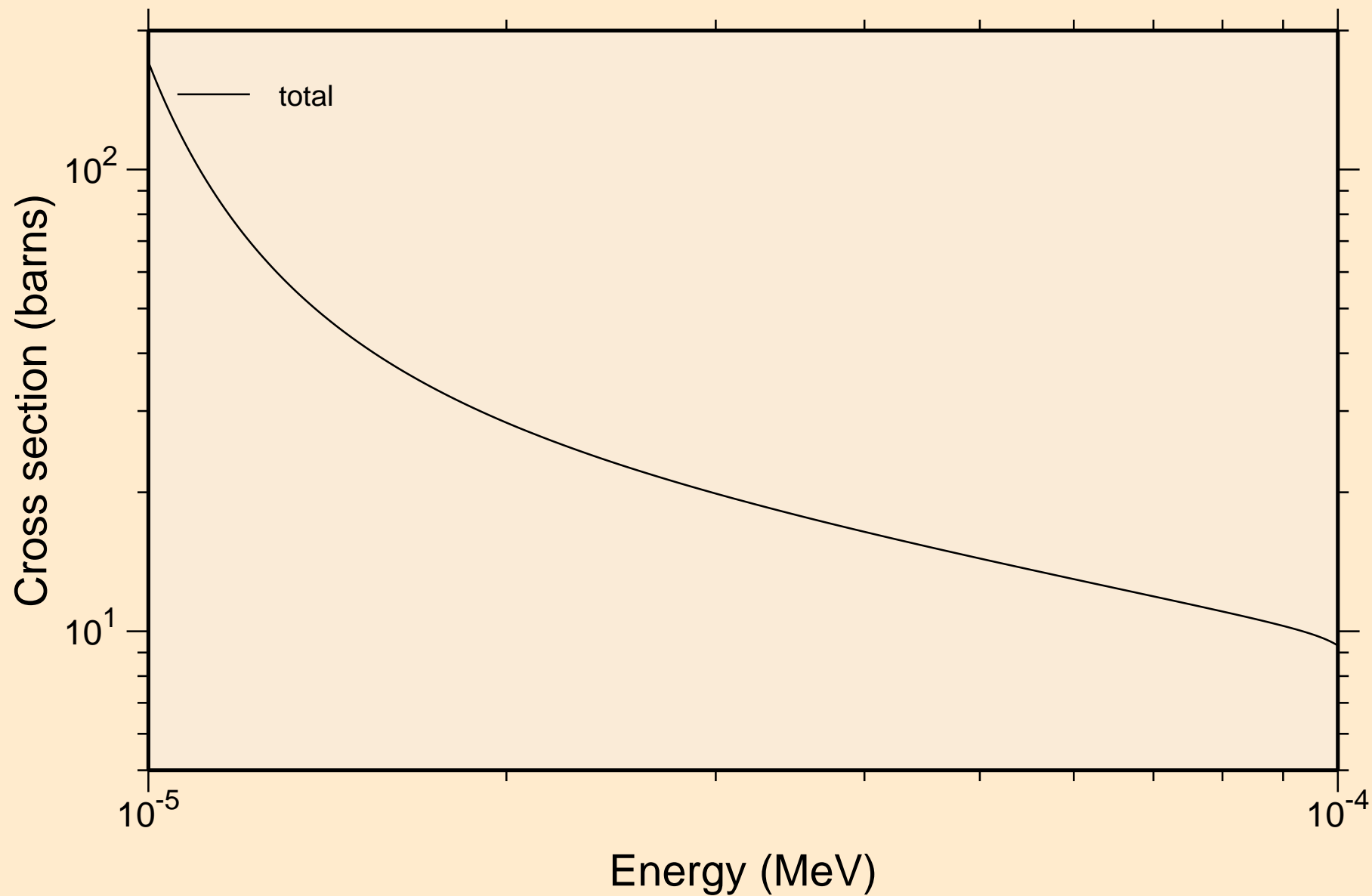

ENDF/B-VII.1 HF-178
resonance total cross section

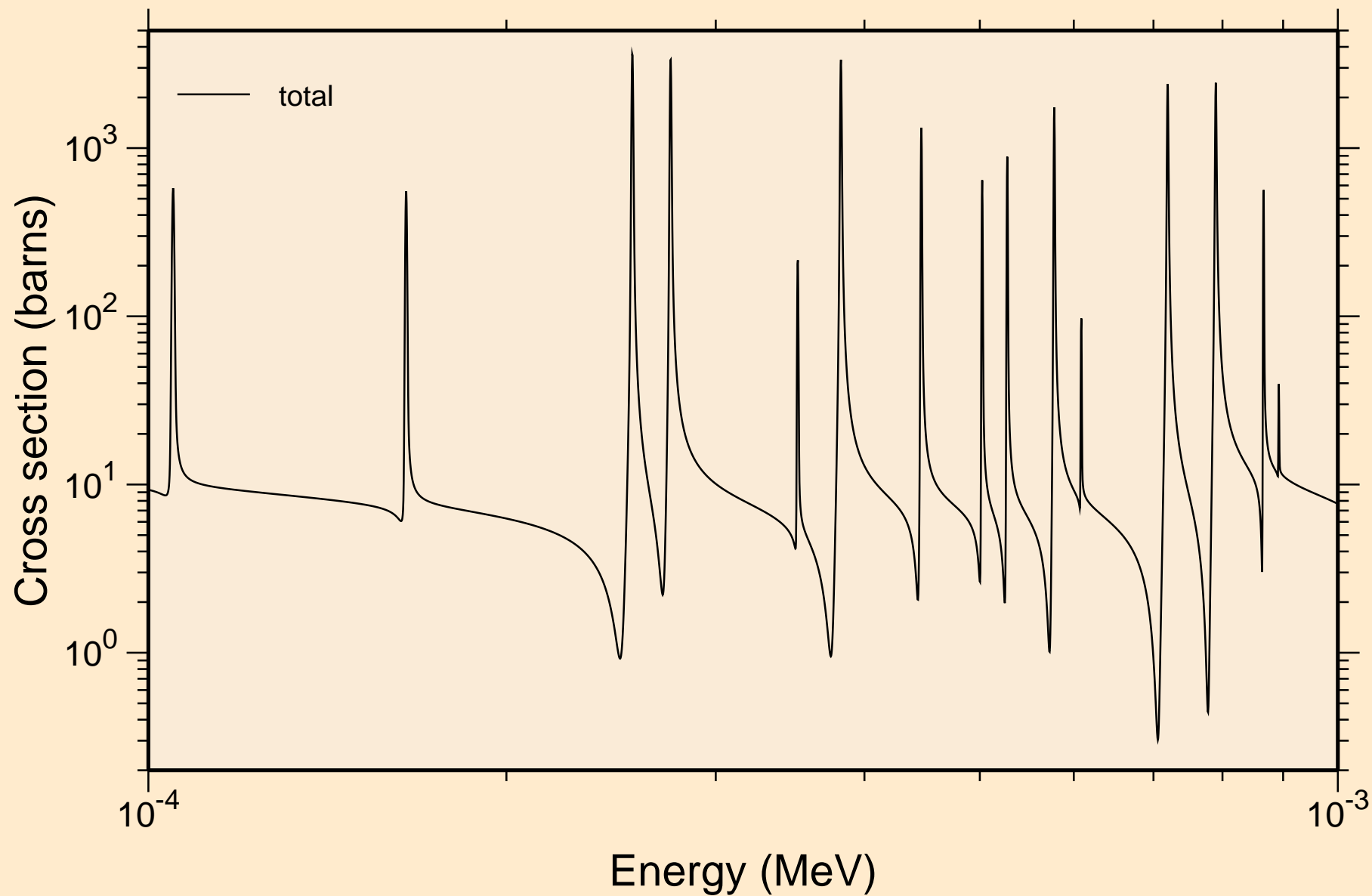

ENDF/B-VII.1 HF-178
resonance total cross section

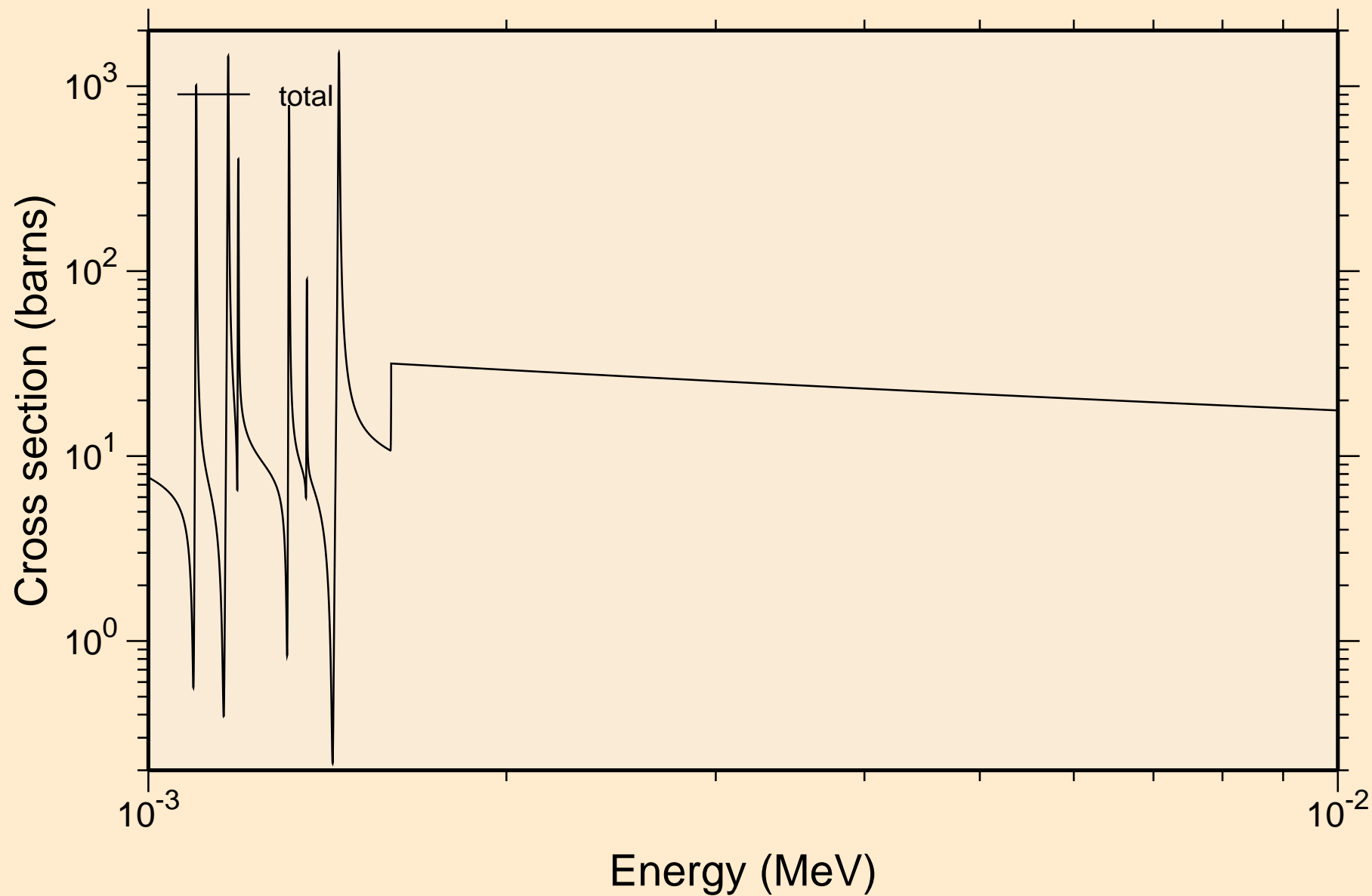

ENDF/B-VII.1 HF-178
resonance total cross section

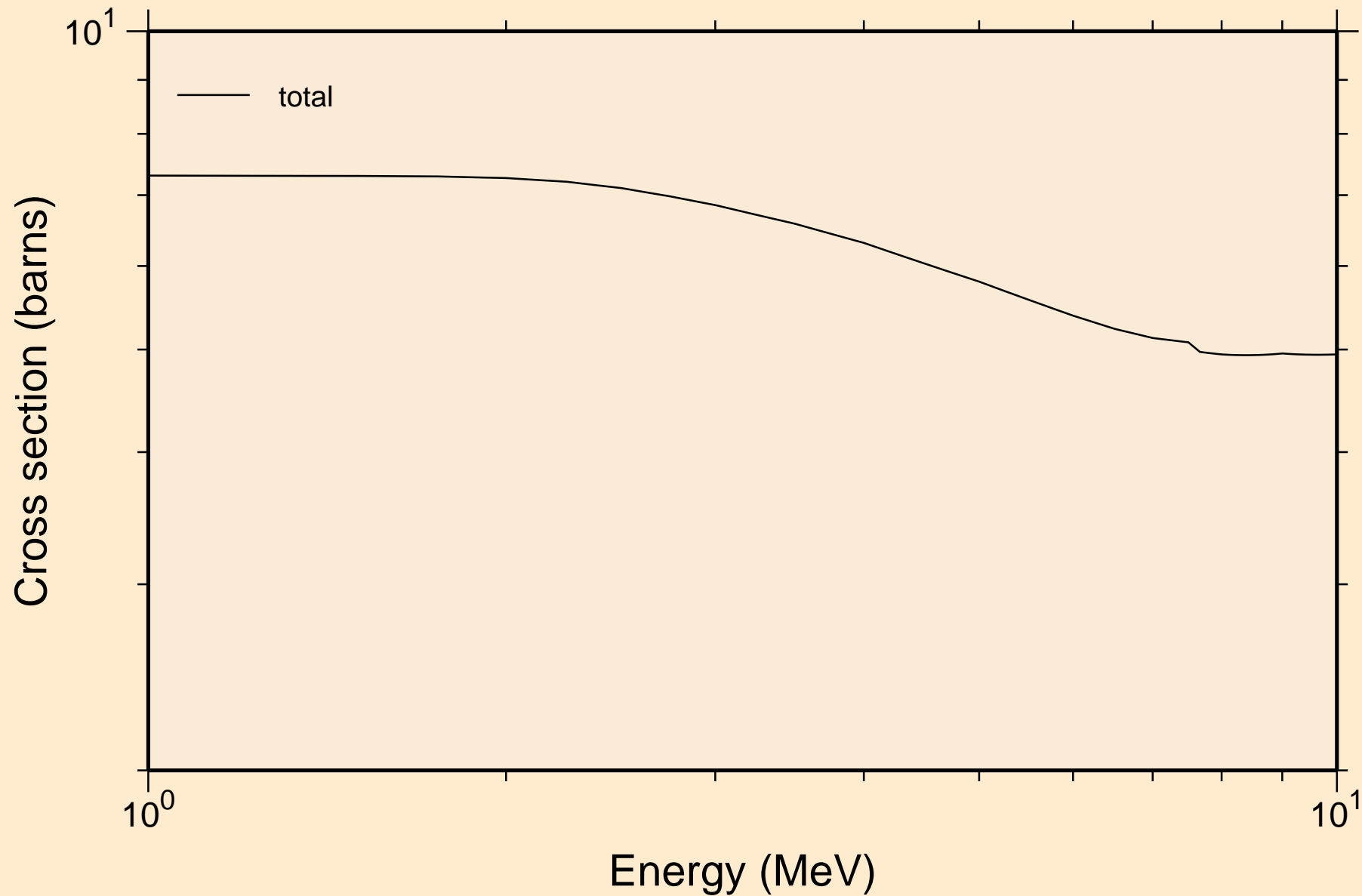

ENDF/B-VII.1 HF-178
resonance absorption cross sections

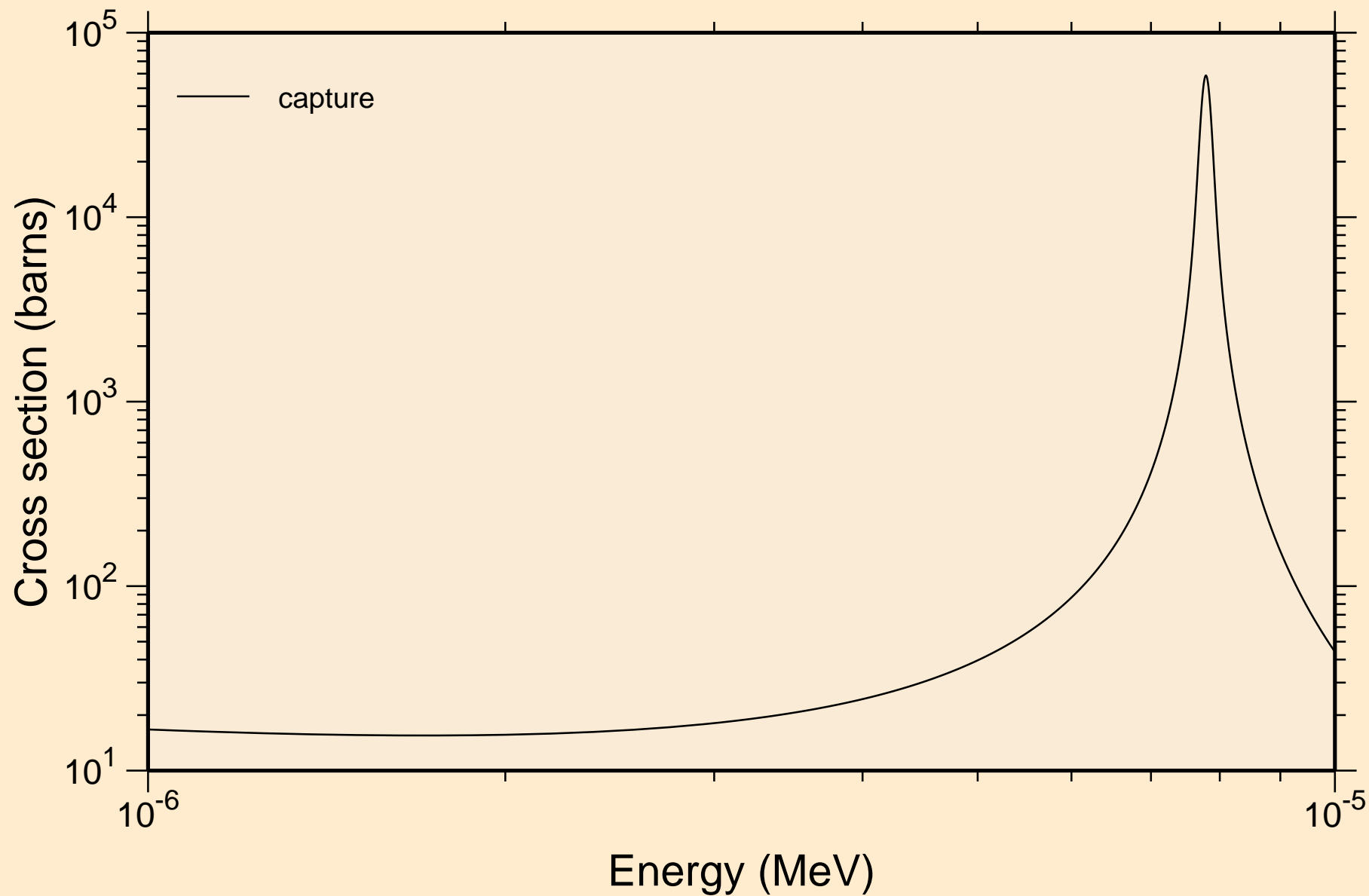

ENDF/B-VII.1 HF-178
resonance absorption cross sections

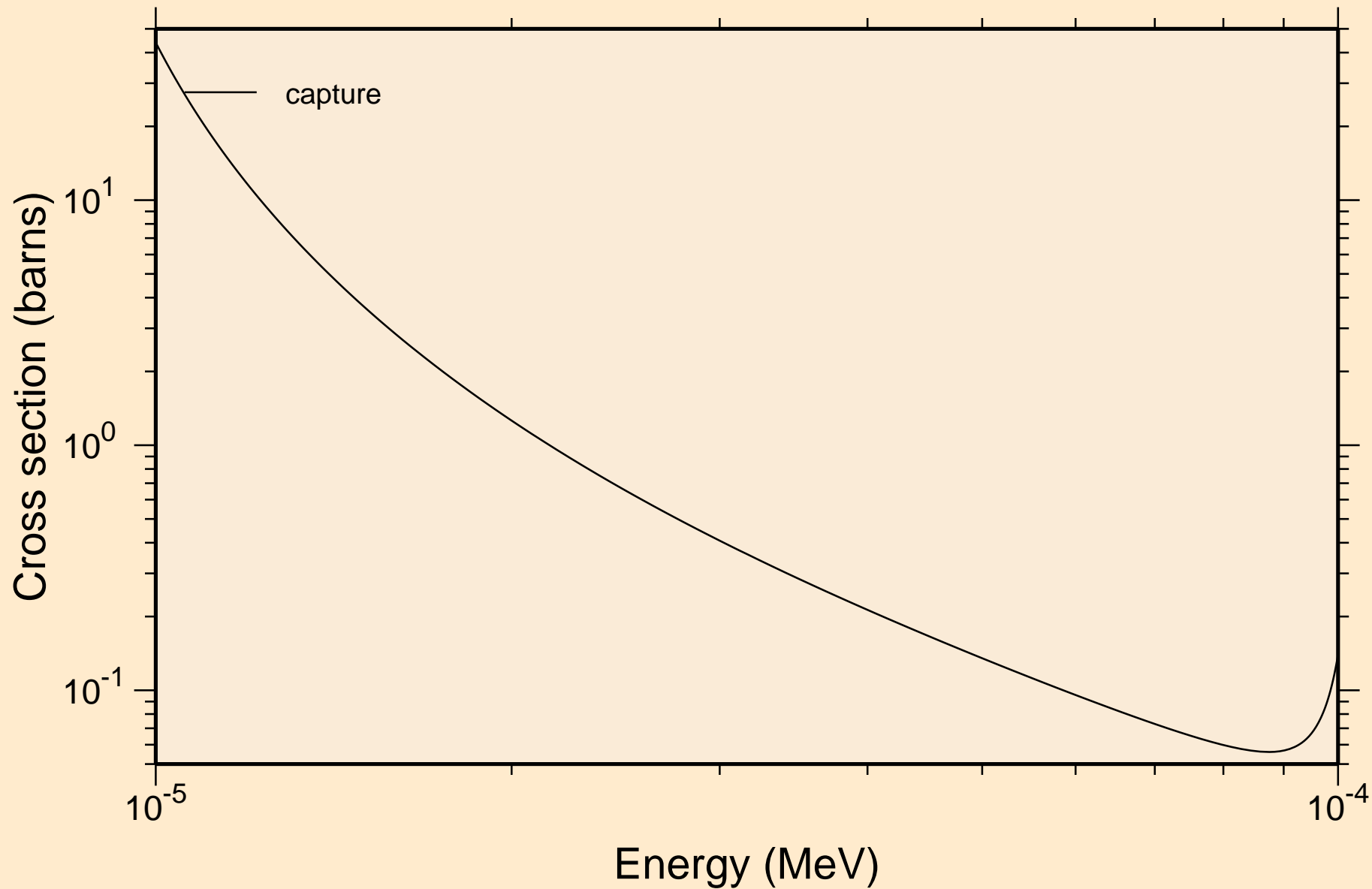

ENDF/B-VII.1 HF-178 resonance absorption cross sections

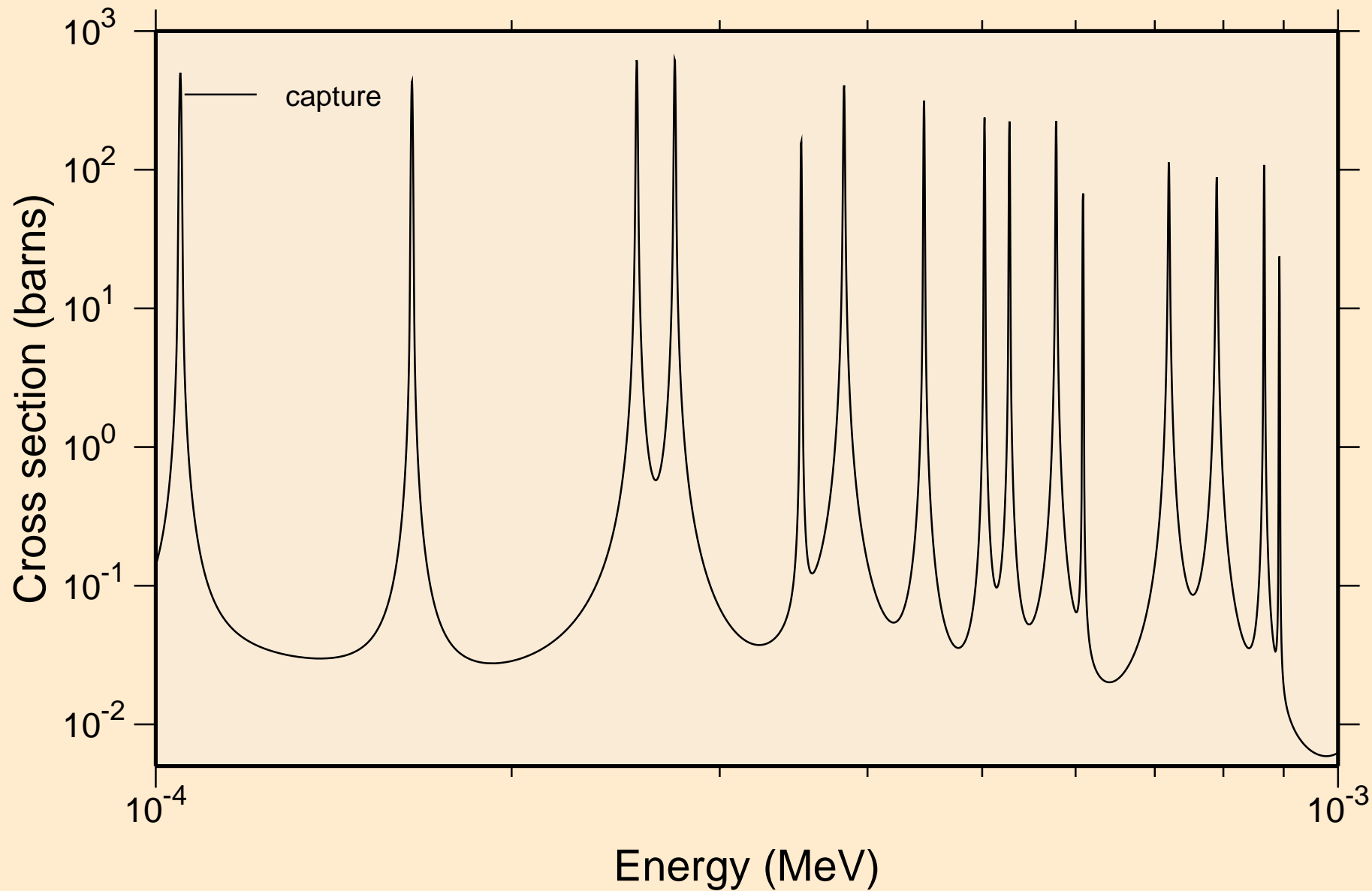

ENDF/B-VII.1 HF-178 resonance absorption cross sections

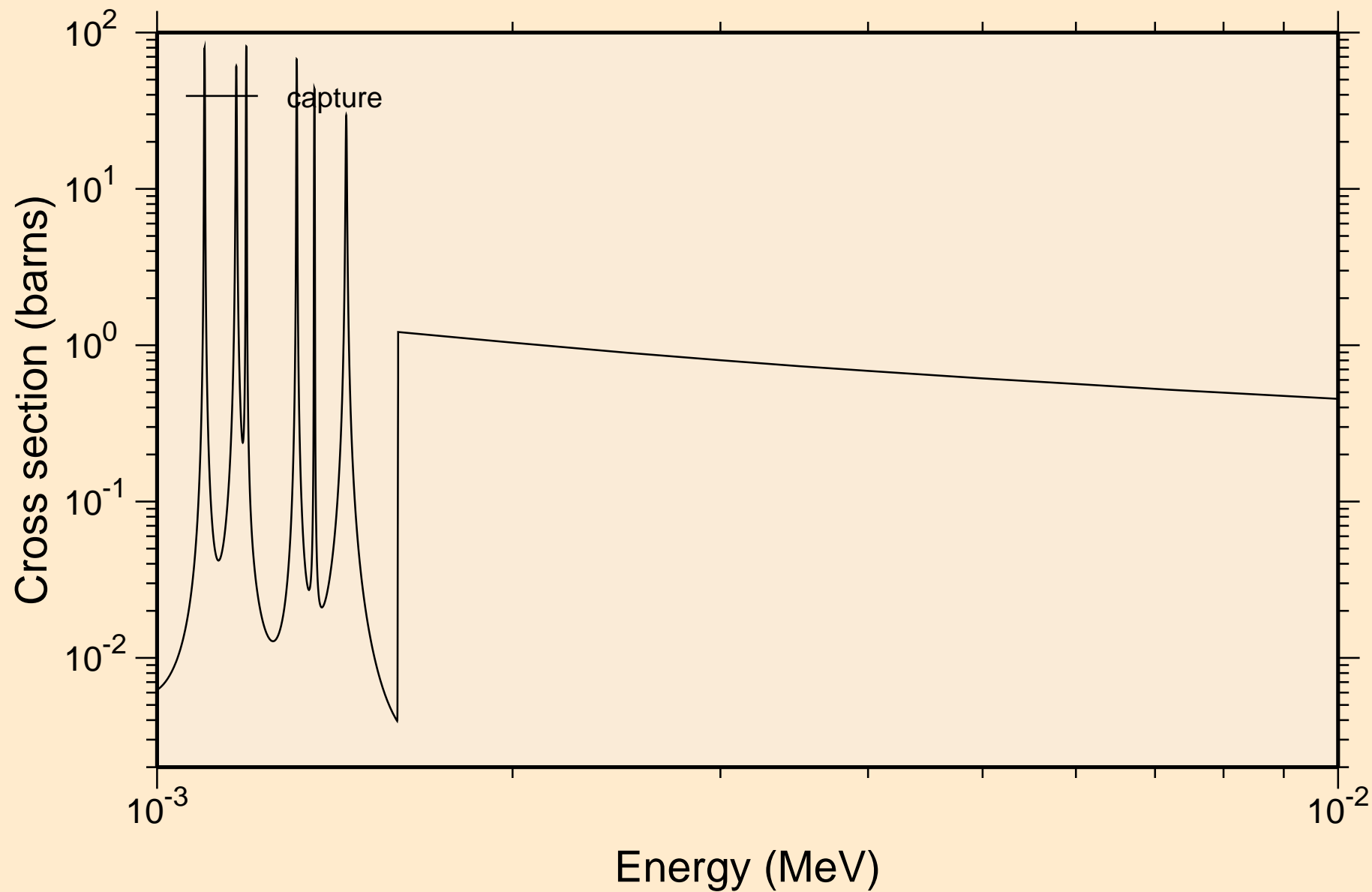

ENDF/B-VII.1 HF-178
resonance absorption cross sections

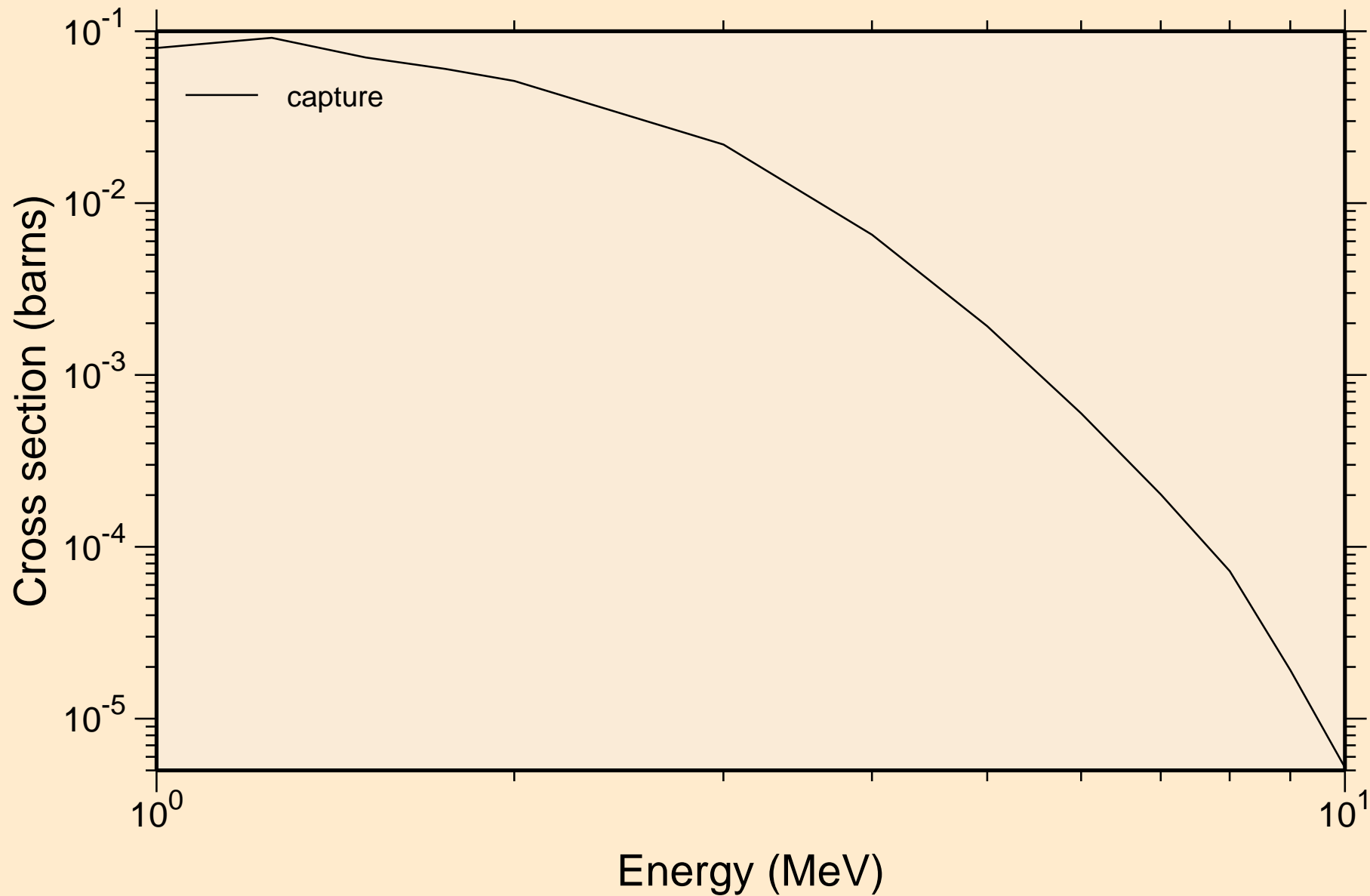

ENDF/B-VII.1 HF-178

UR total cross section

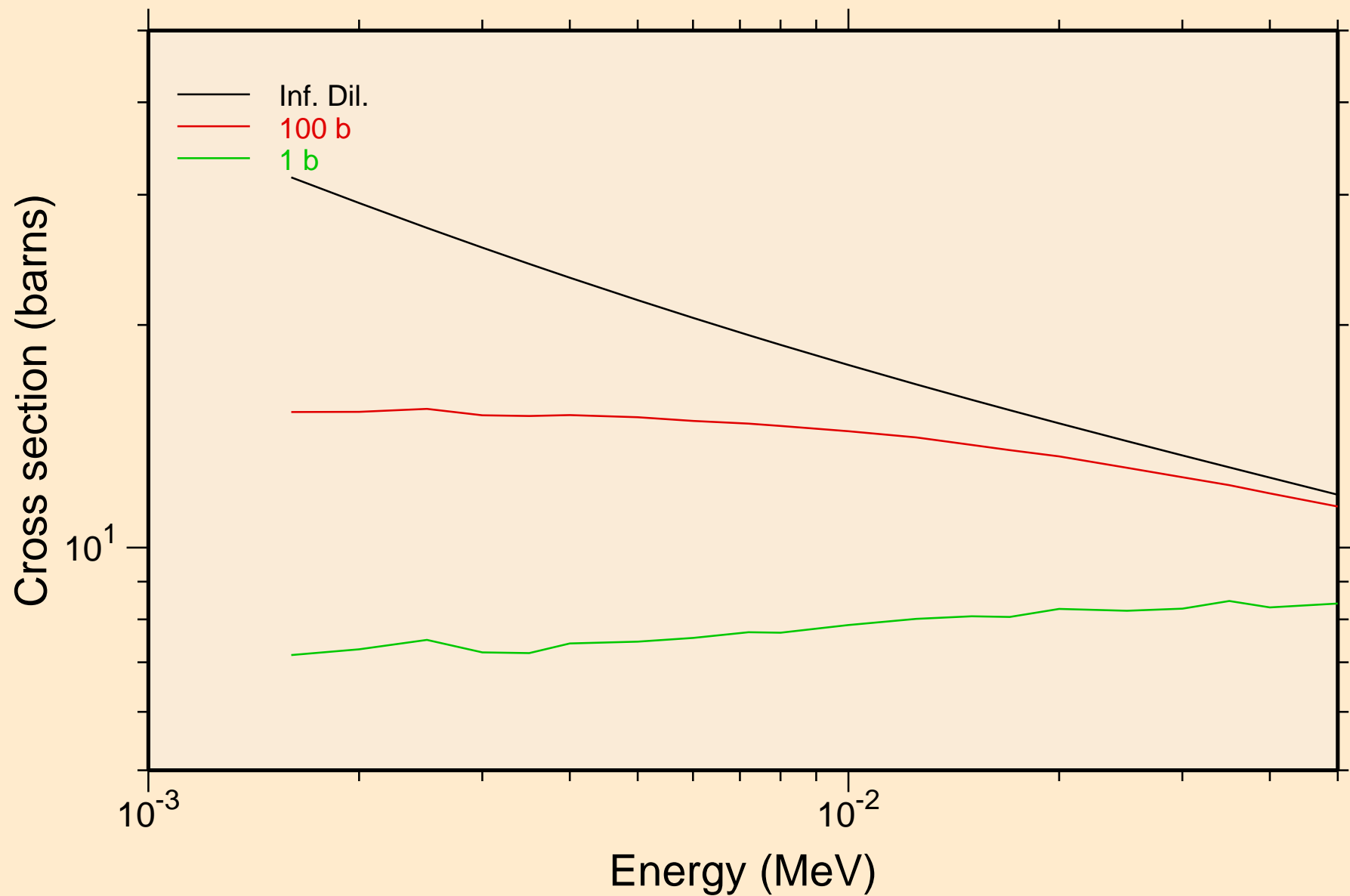

ENDF/B-VII.1 HF-178
UR elastic cross section

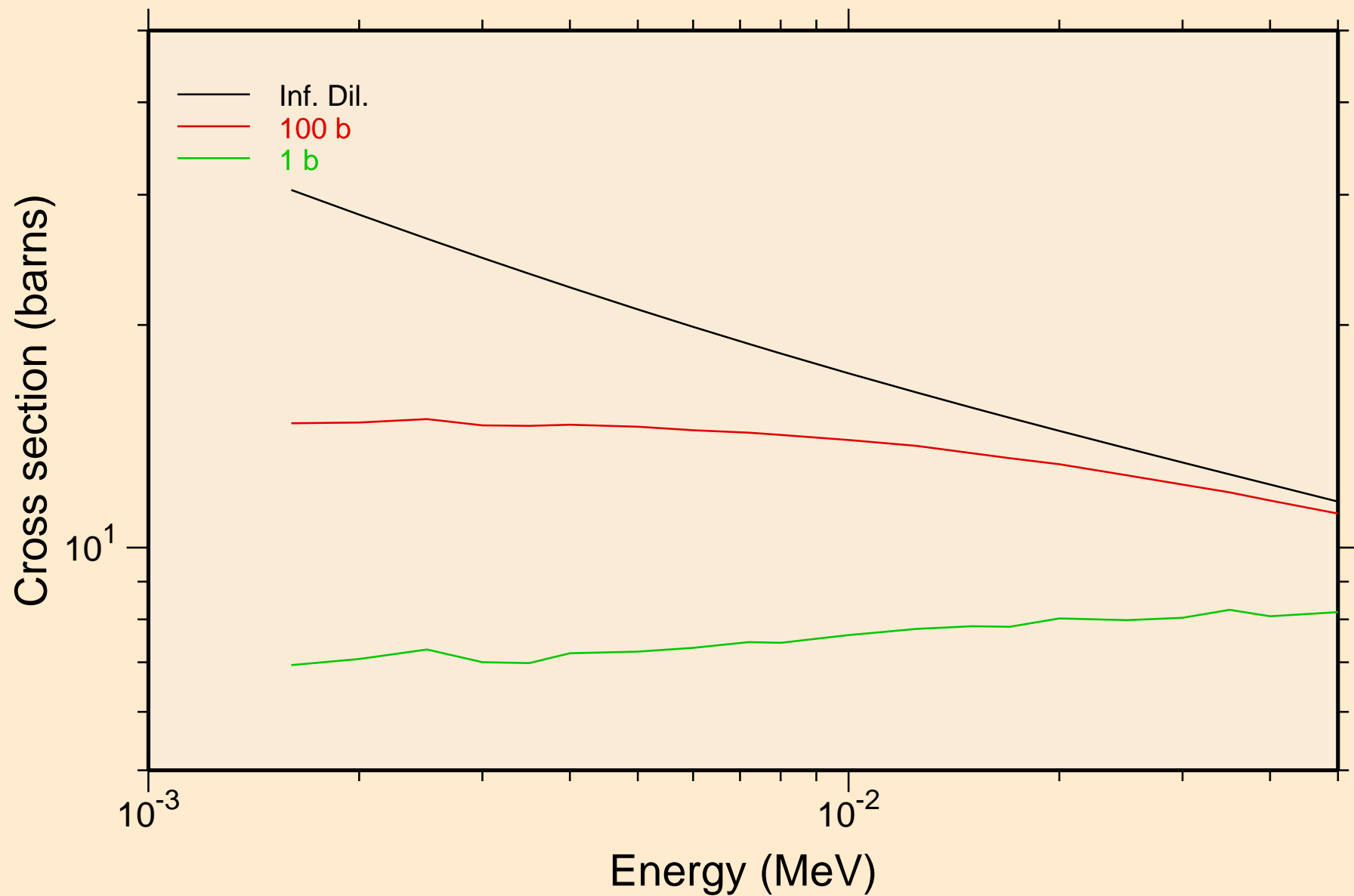

ENDF/B-VII.1 HF-178
UR capture cross section

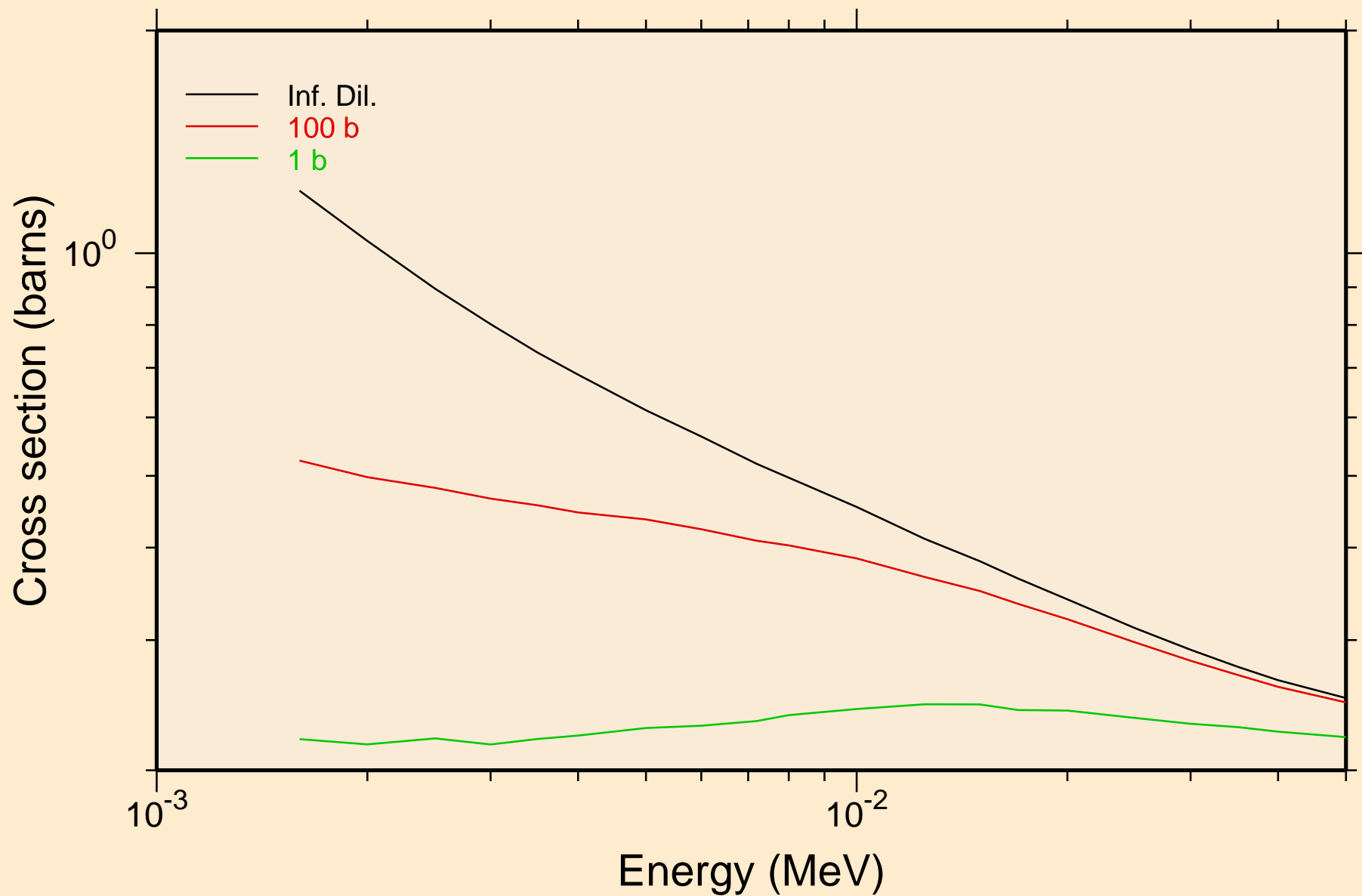

ENDF/B-VII.1 HF-178

Heating

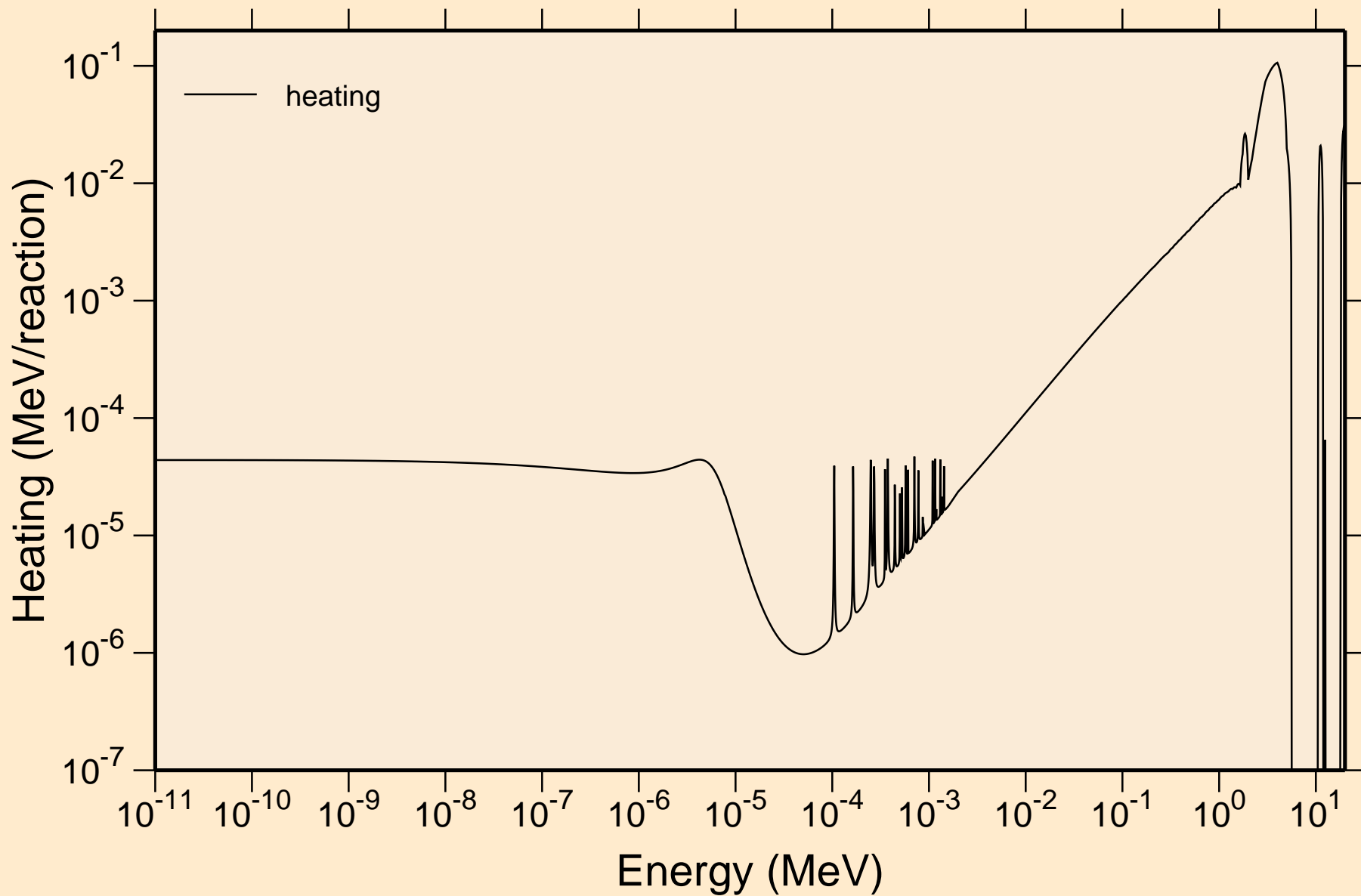

ENDF/B-VII.1 HF-178

Damage

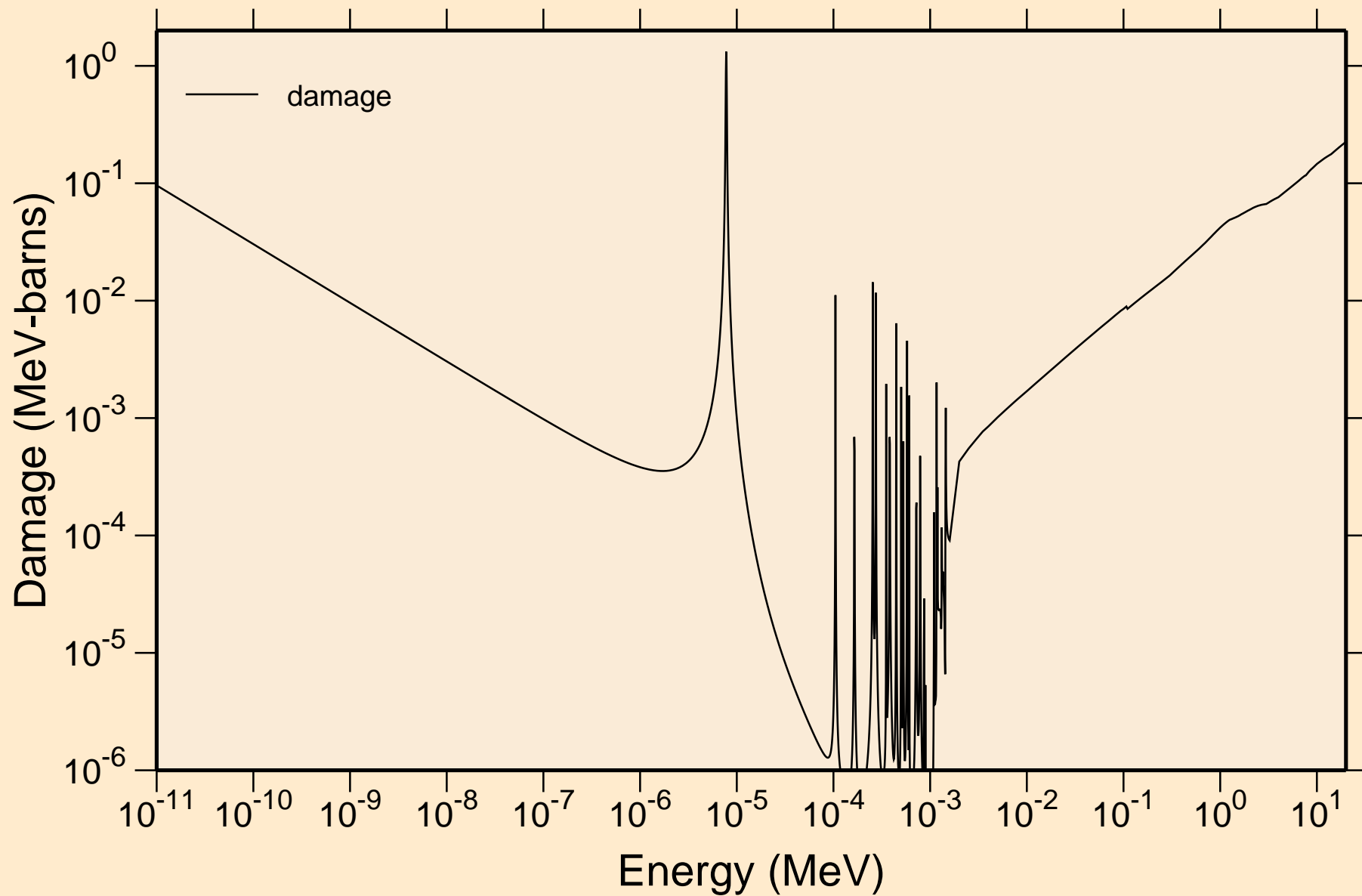

ENDF/B-VII.1 HF-178

Non-threshold reactions

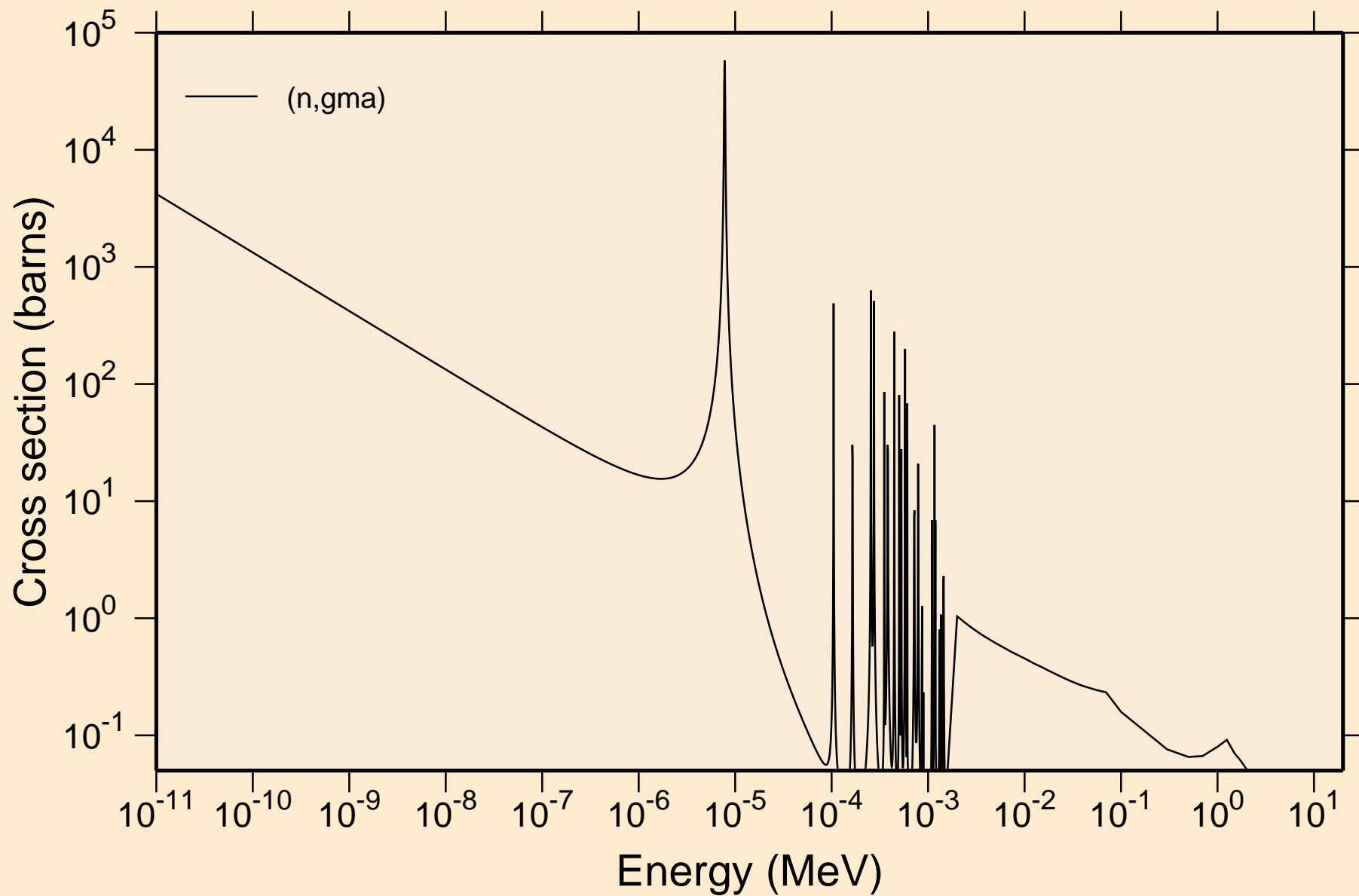

ENDF/B-VII.1 HF-178

Principal cross sections

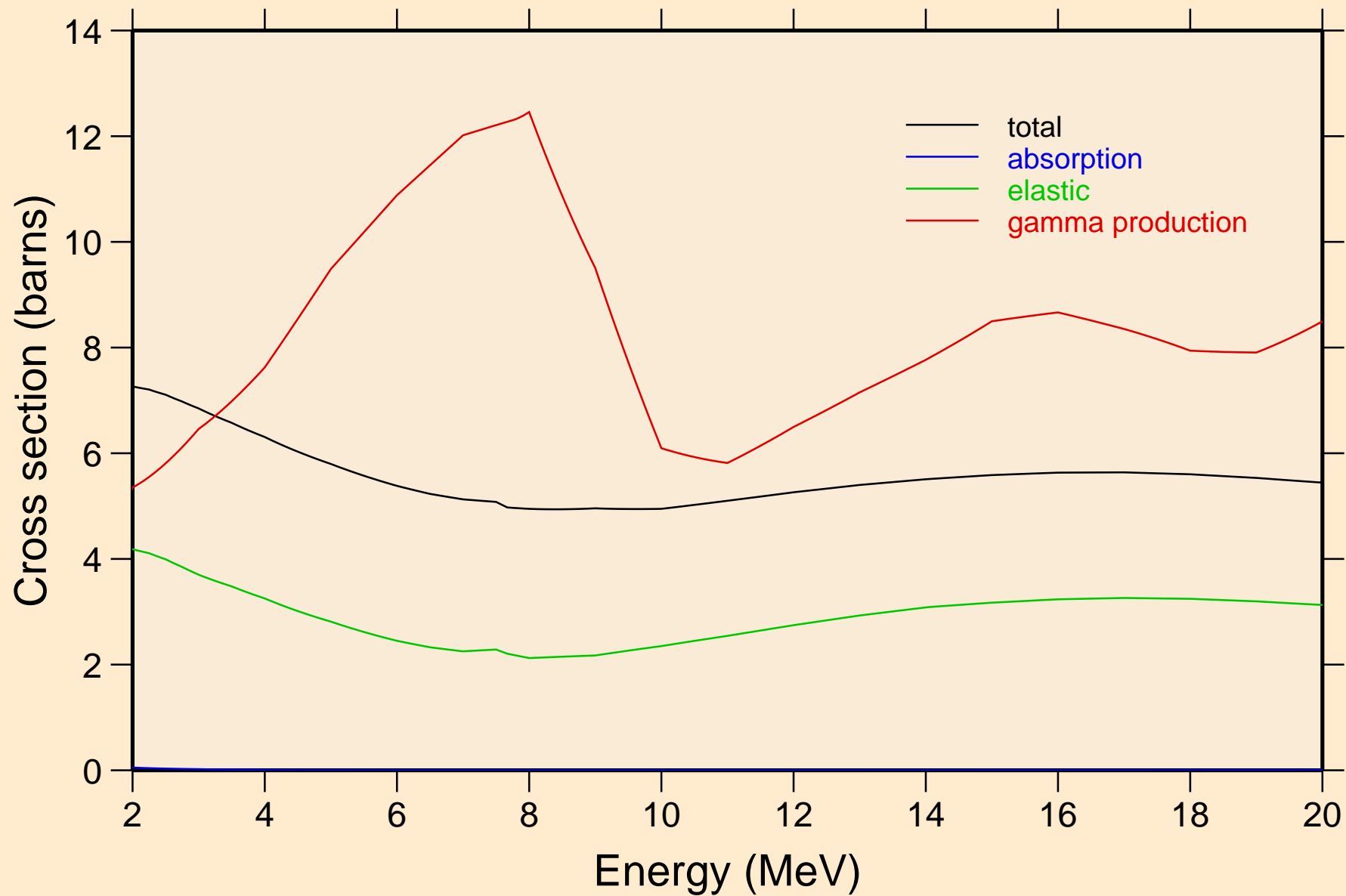

ENDF/B-VII.1 HF-178

Heating

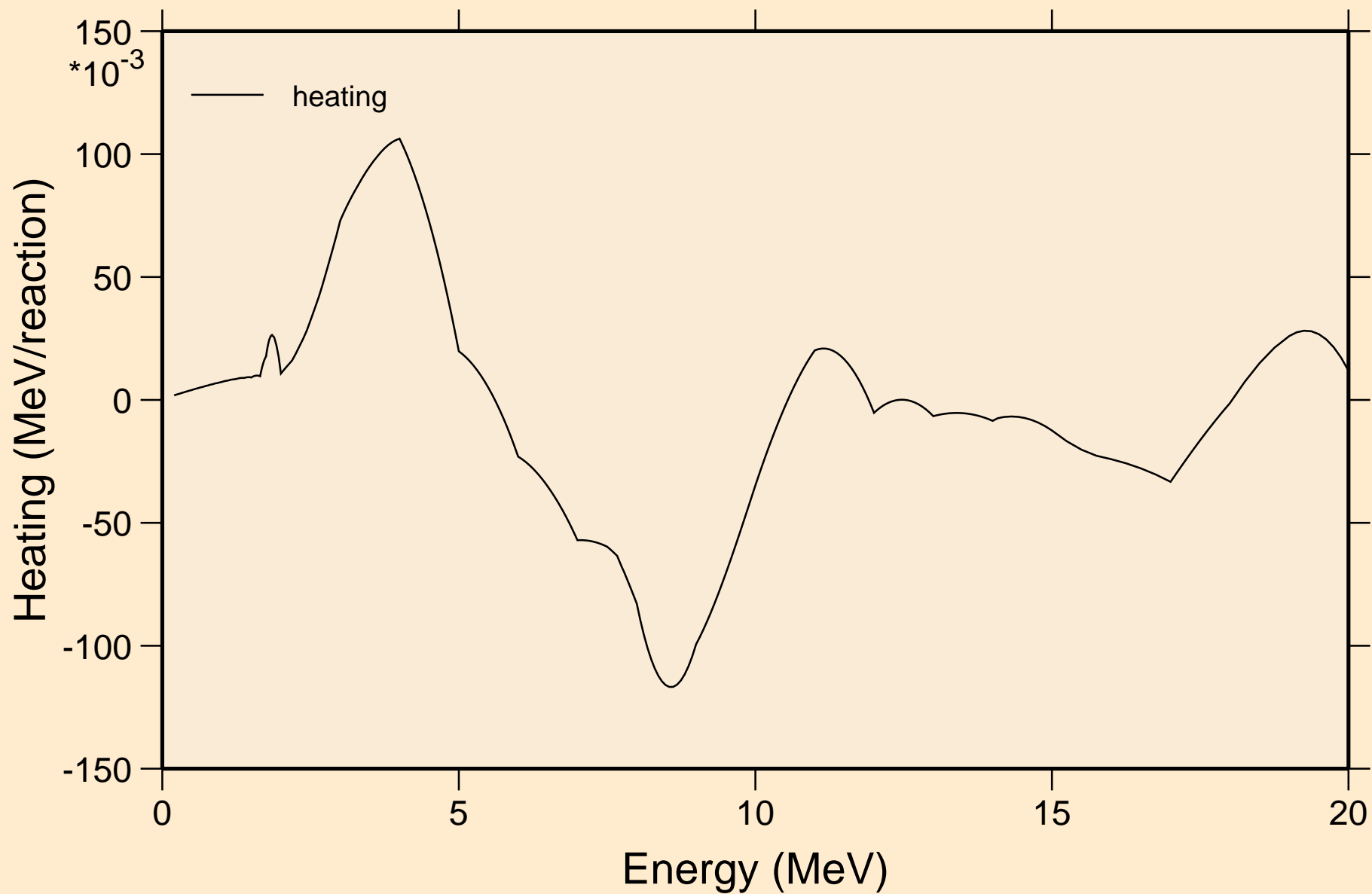

ENDF/B-VII.1 HF-178

Damage

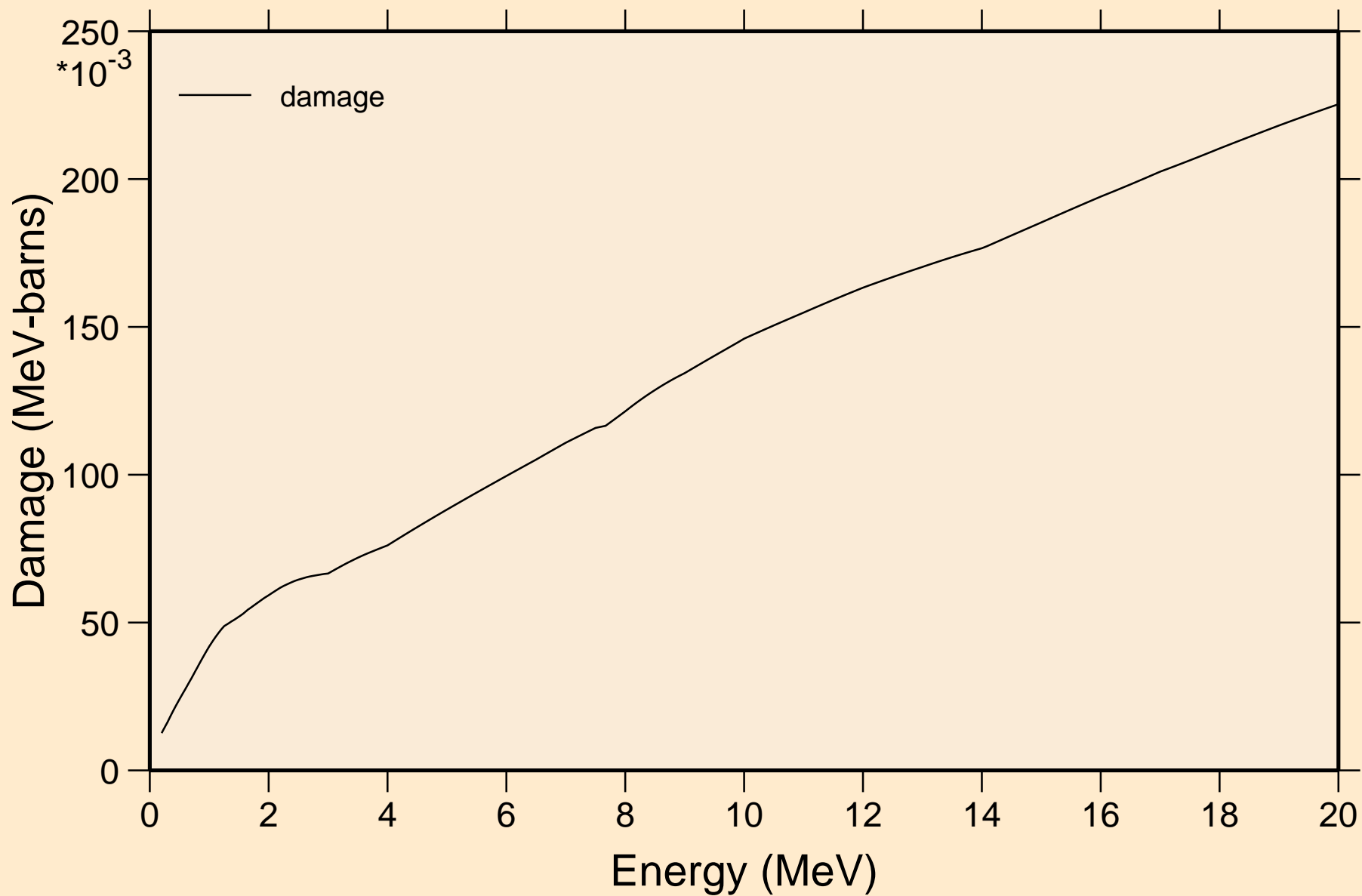

ENDF/B-VII.1 HF-178
Non-threshold reactions

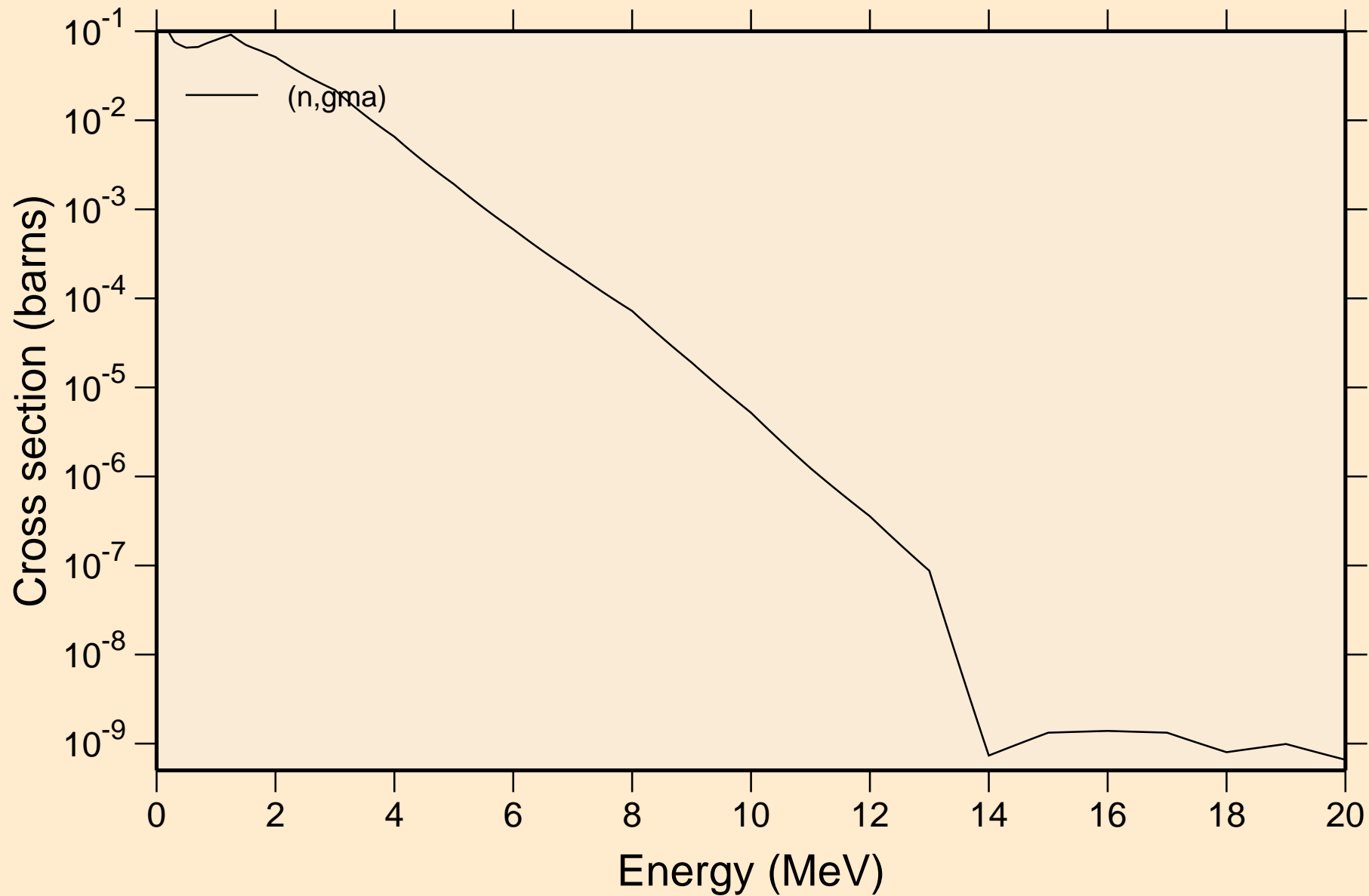

ENDF/B-VII.1 HF-178

Inelastic levels

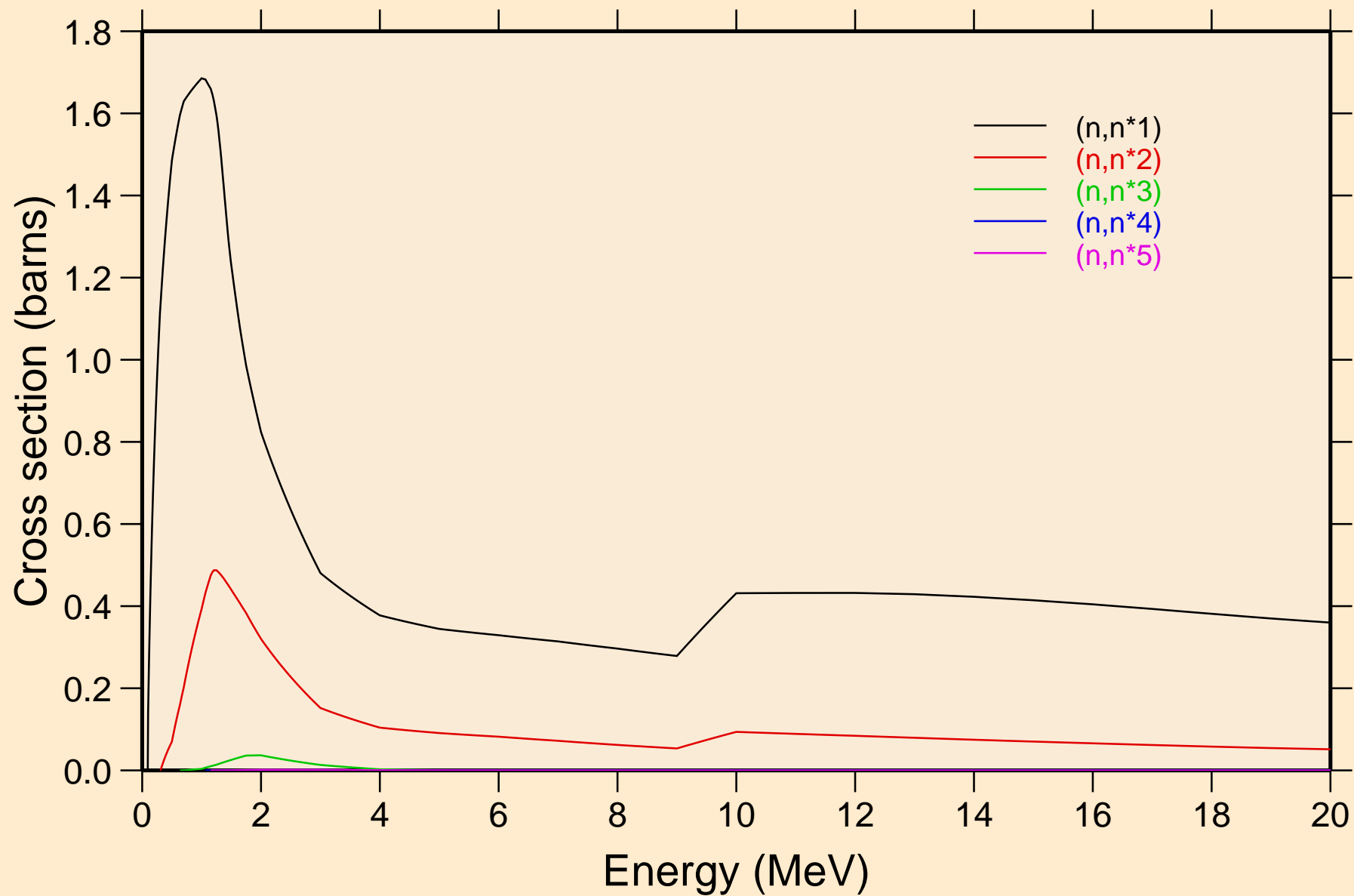

ENDF/B-VII.1 HF-178

Inelastic levels

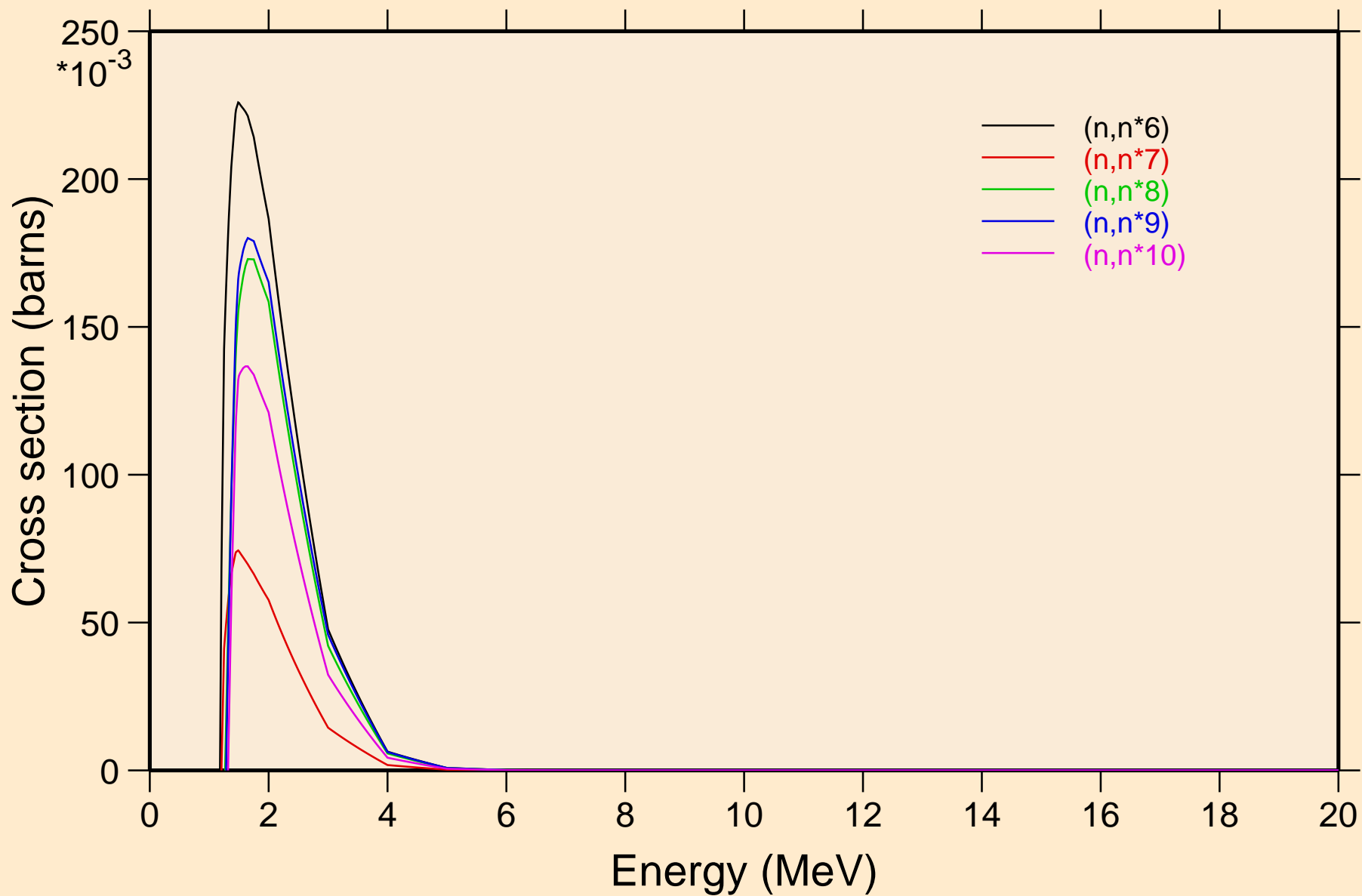

ENDF/B-VII.1 HF-178

Inelastic levels

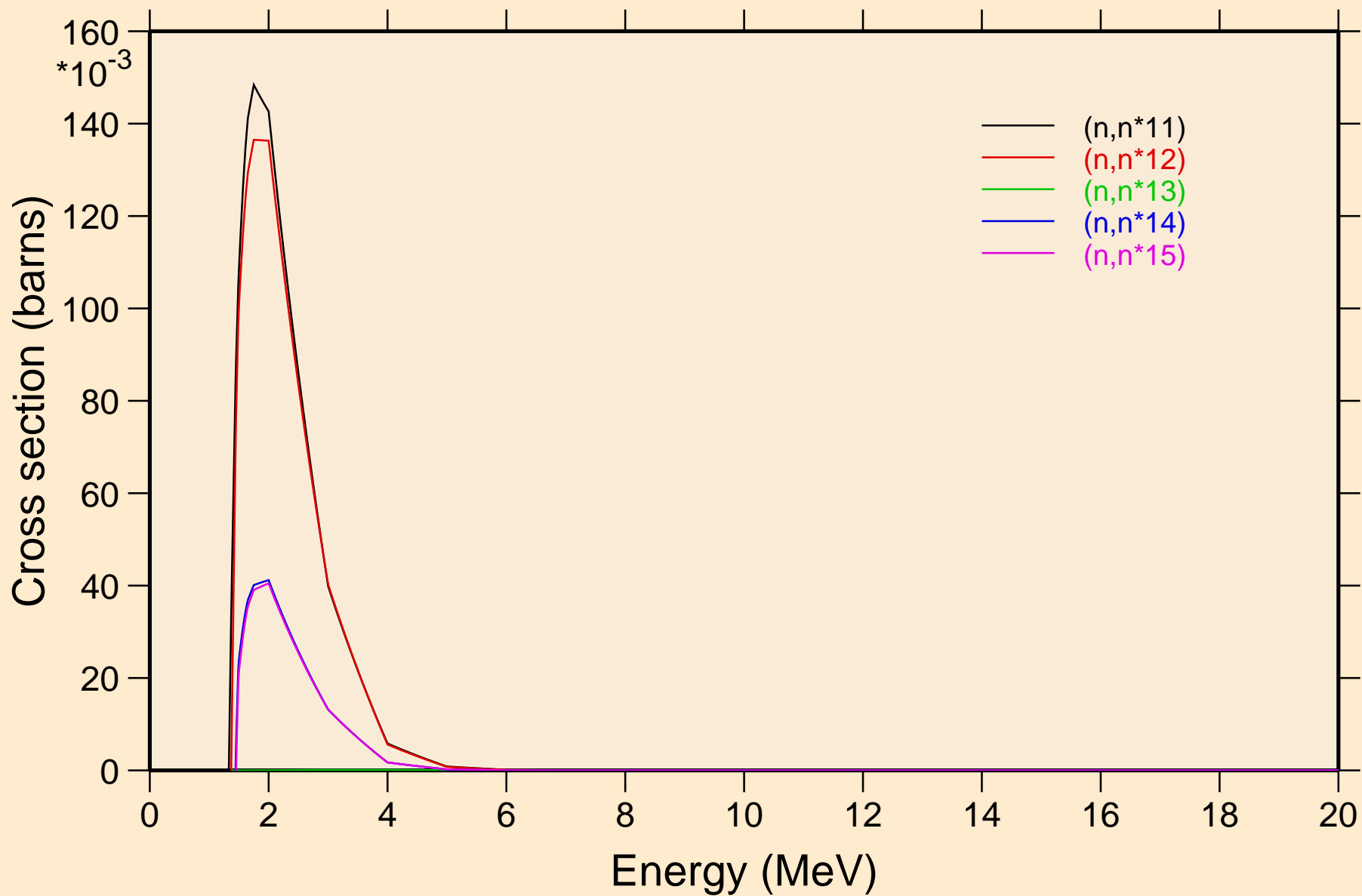

ENDF/B-VII.1 HF-178

Inelastic levels

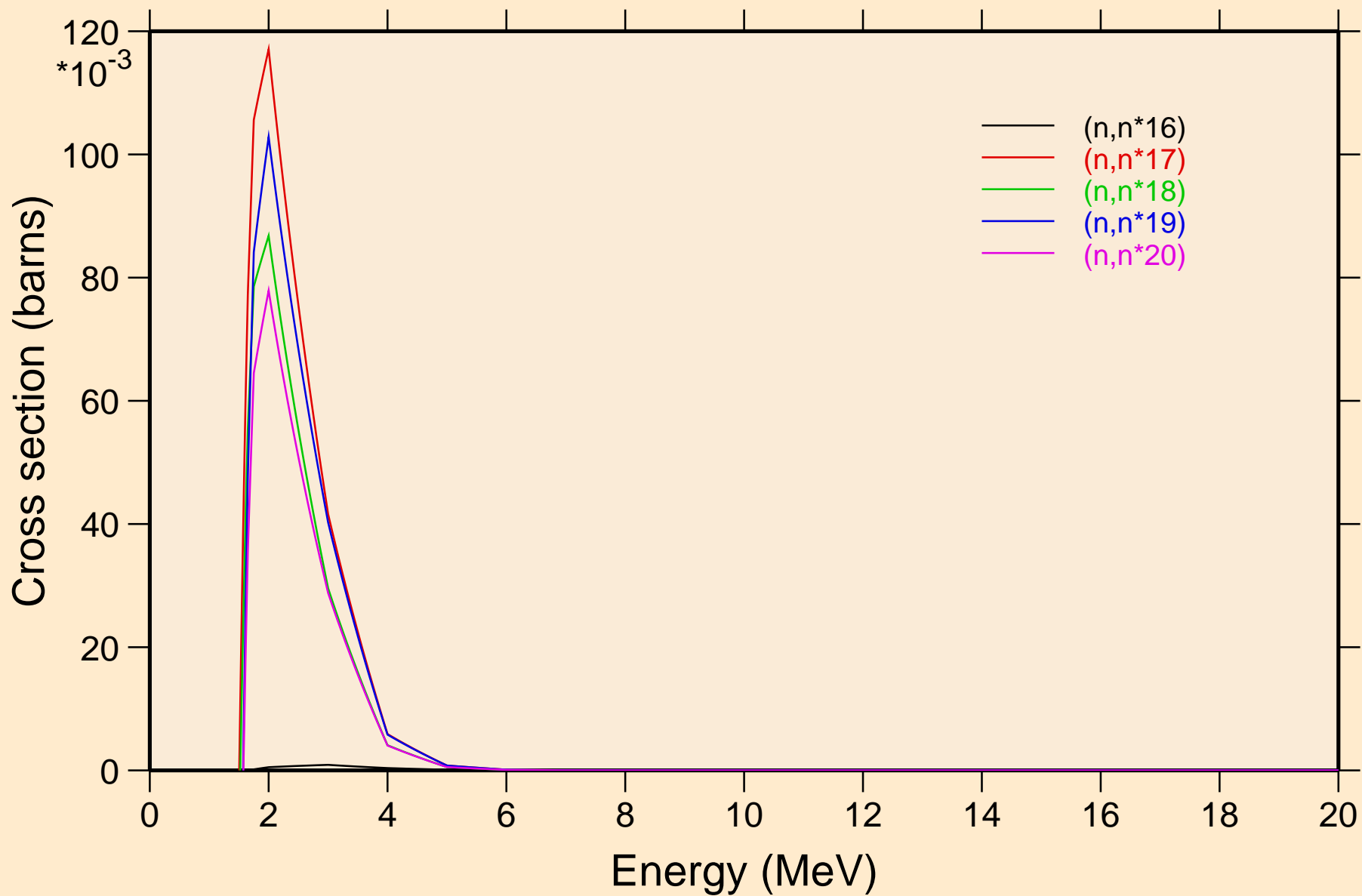

ENDF/B-VII.1 HF-178

Inelastic levels

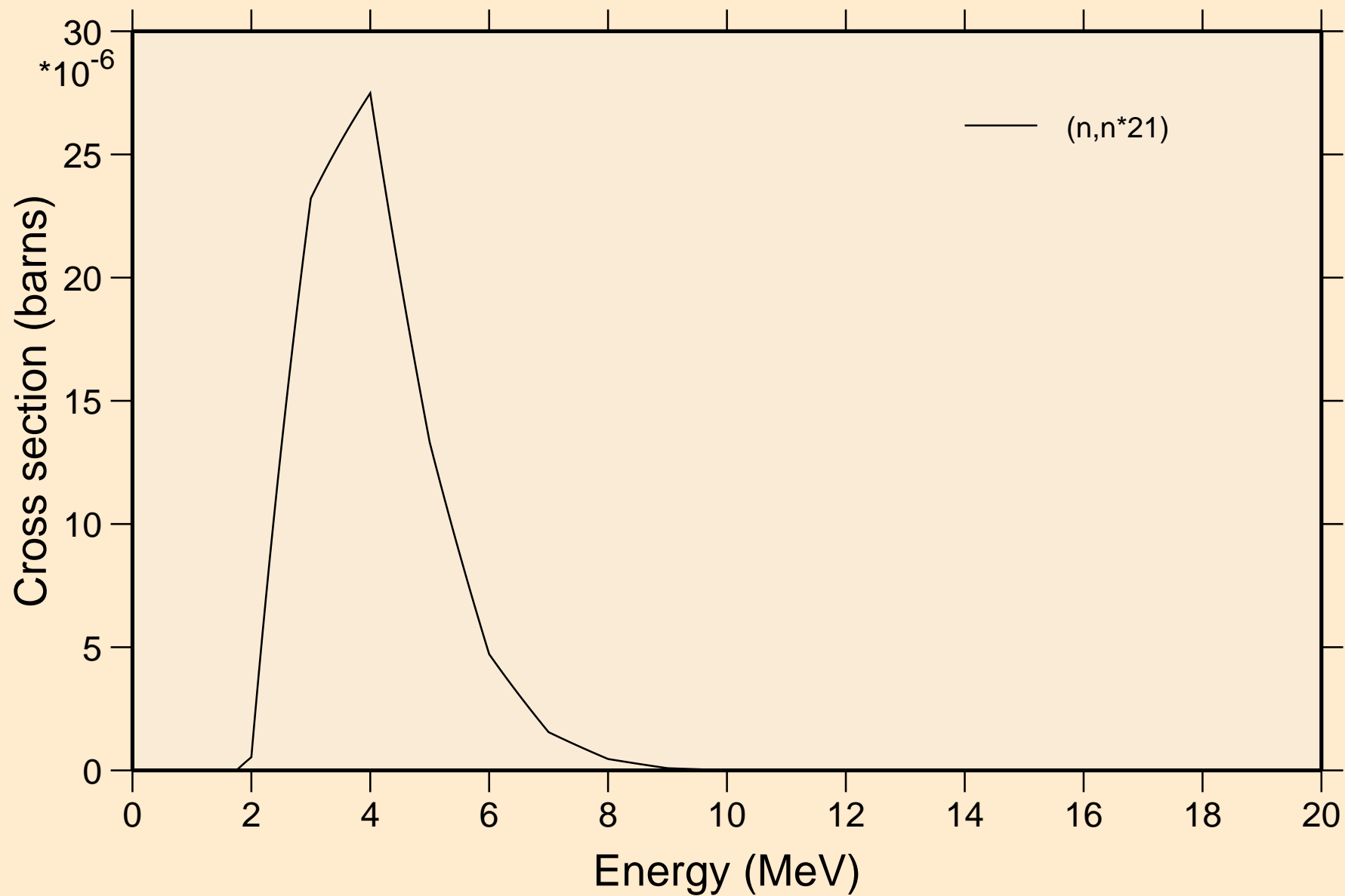

ENDF/B-VII.1 HF-178

Threshold reactions

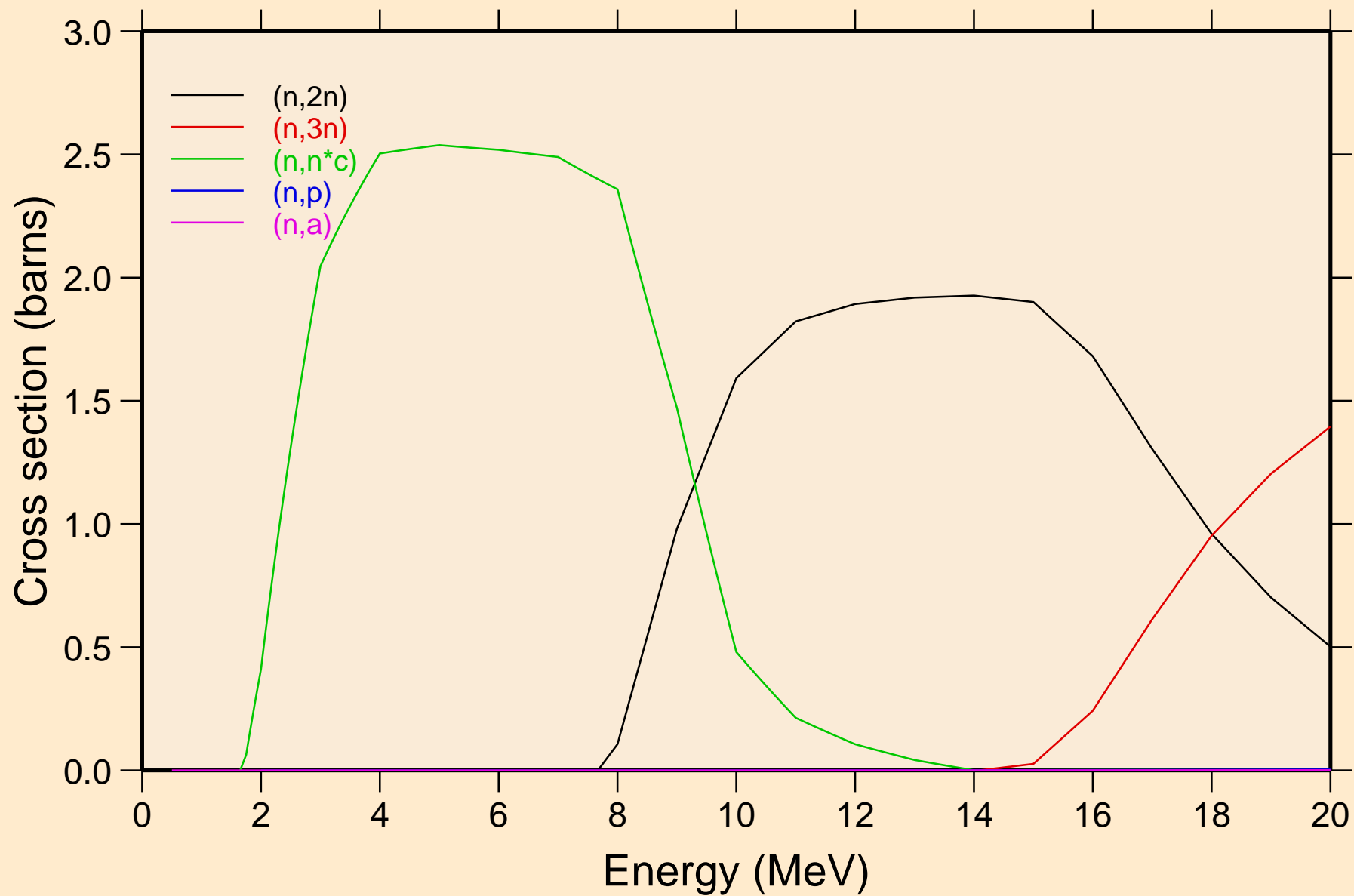

ENDF/B-VII.1 HF-178

Threshold reactions

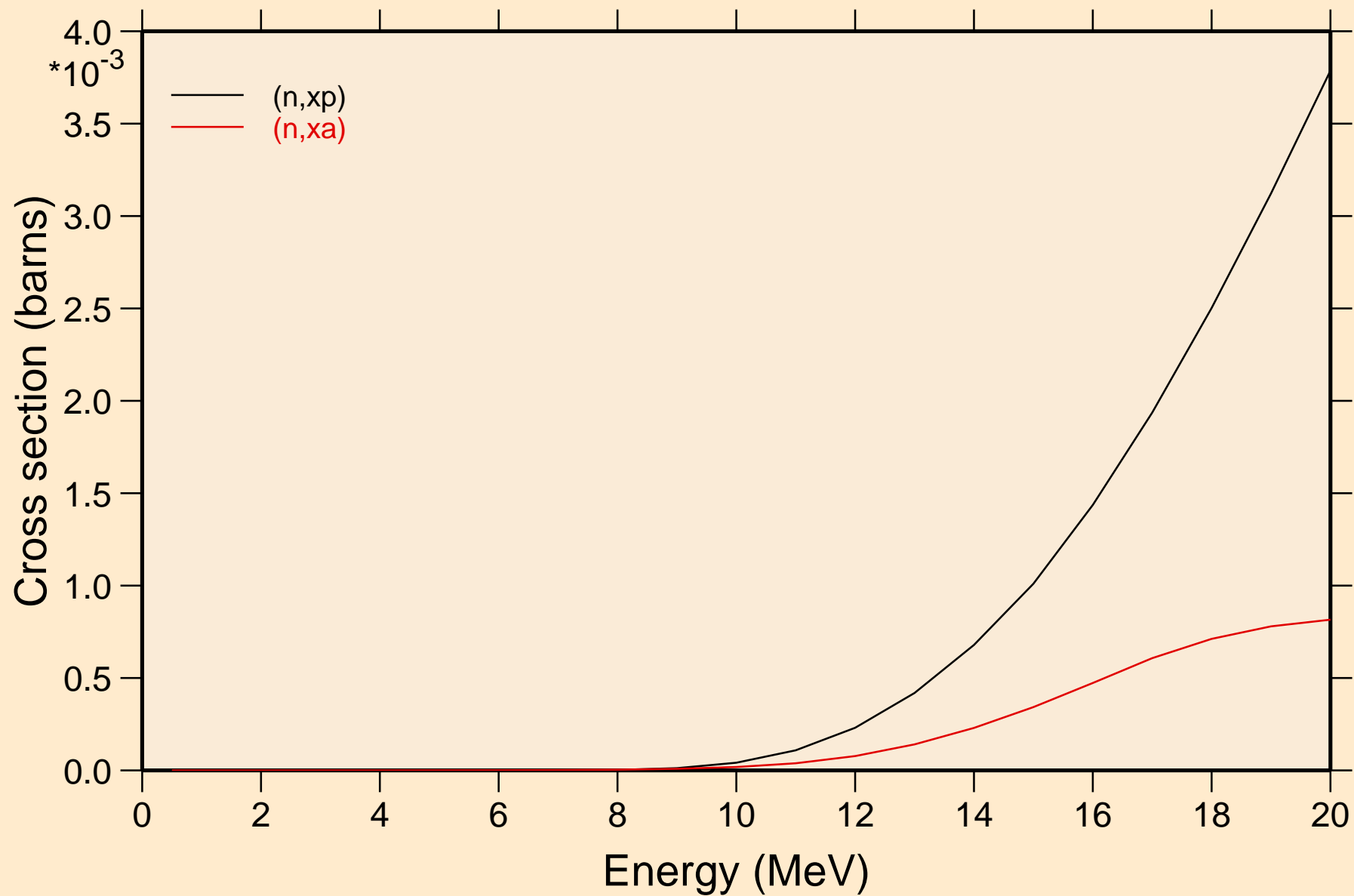

ENDF/B-VII.1 HF-178
angular distribution for elastic

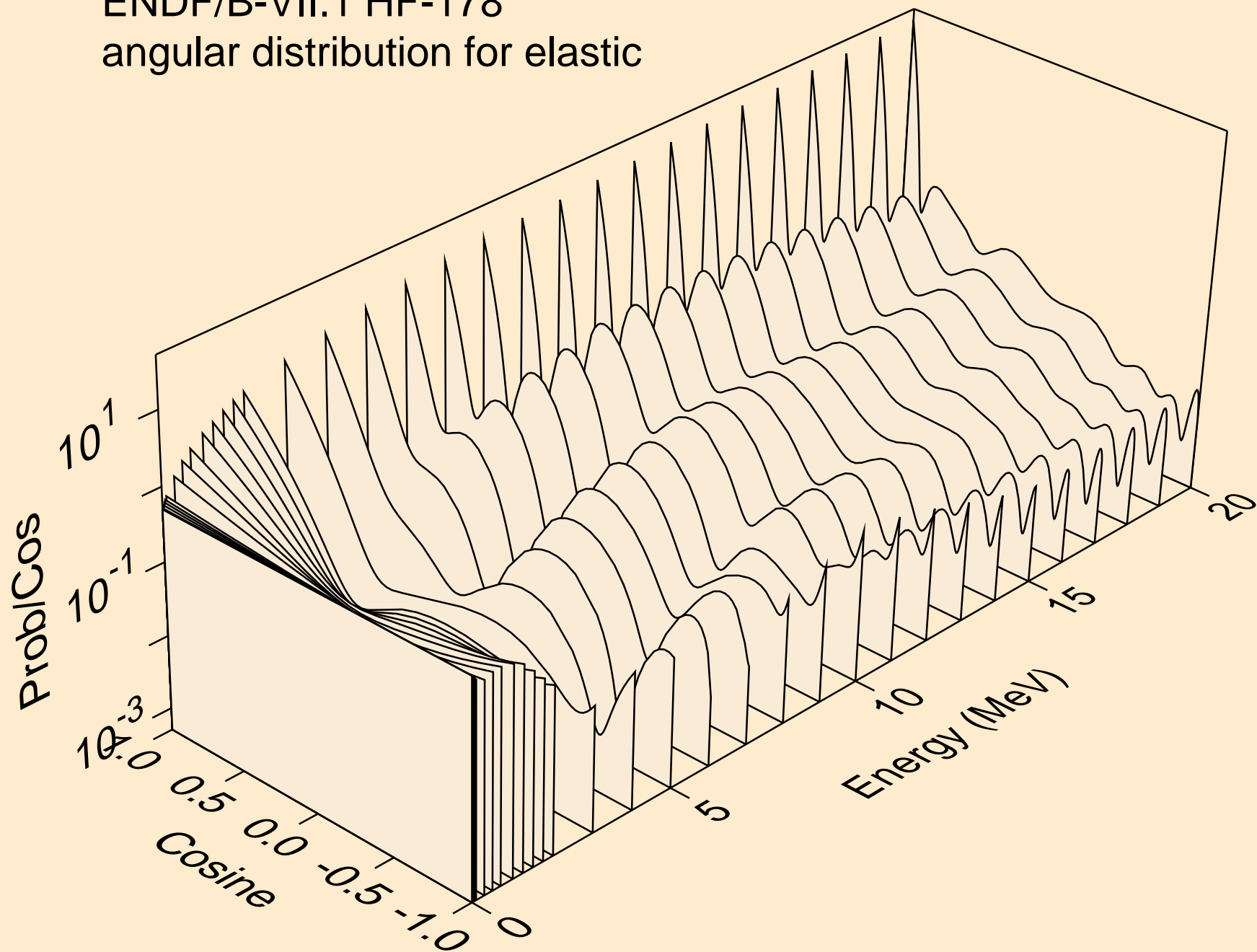

ENDF/B-VII.1 HF-178
angular distribution for (n,n*1)

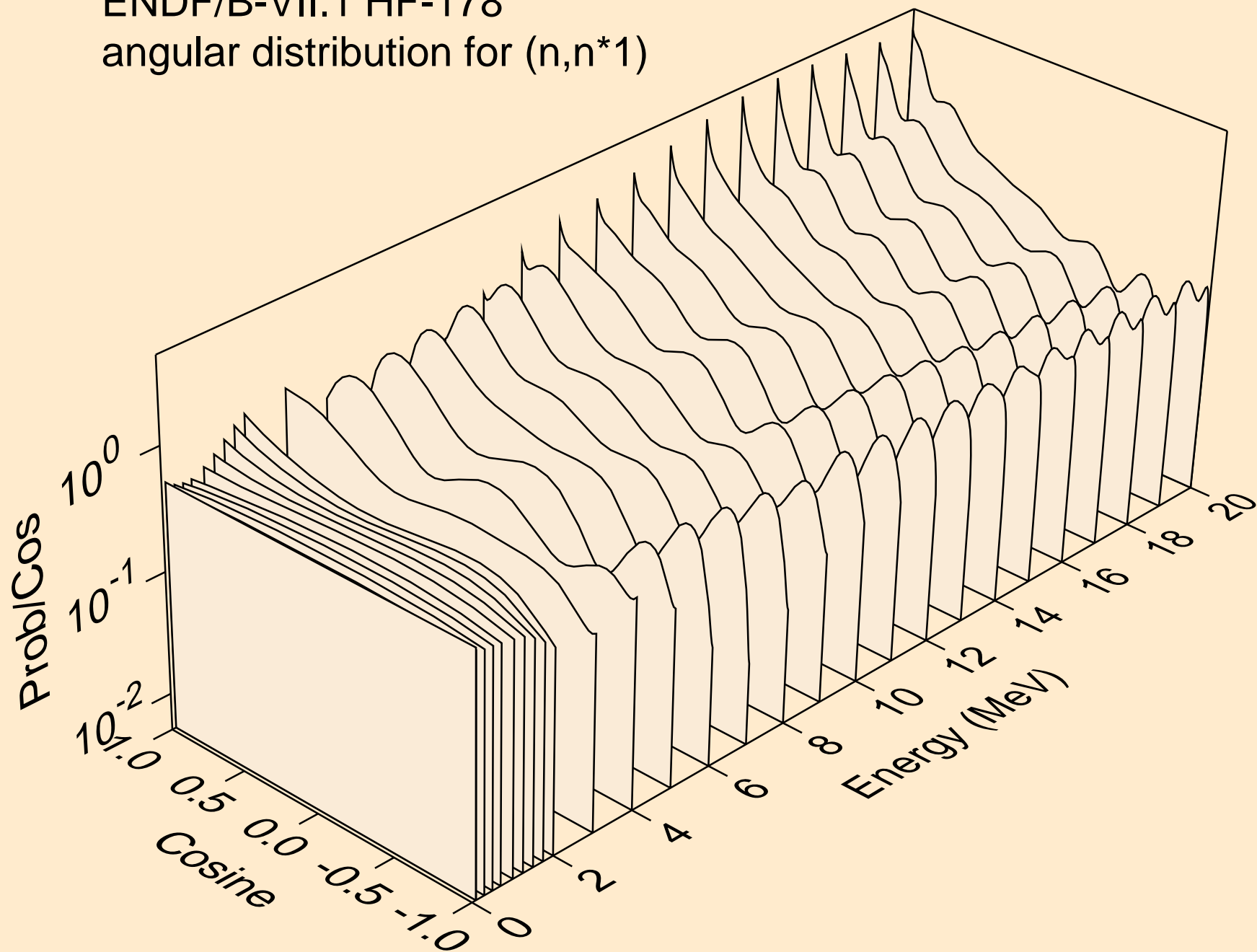

ENDF/B-VII.1 HF-178
angular distribution for (n,n*2)

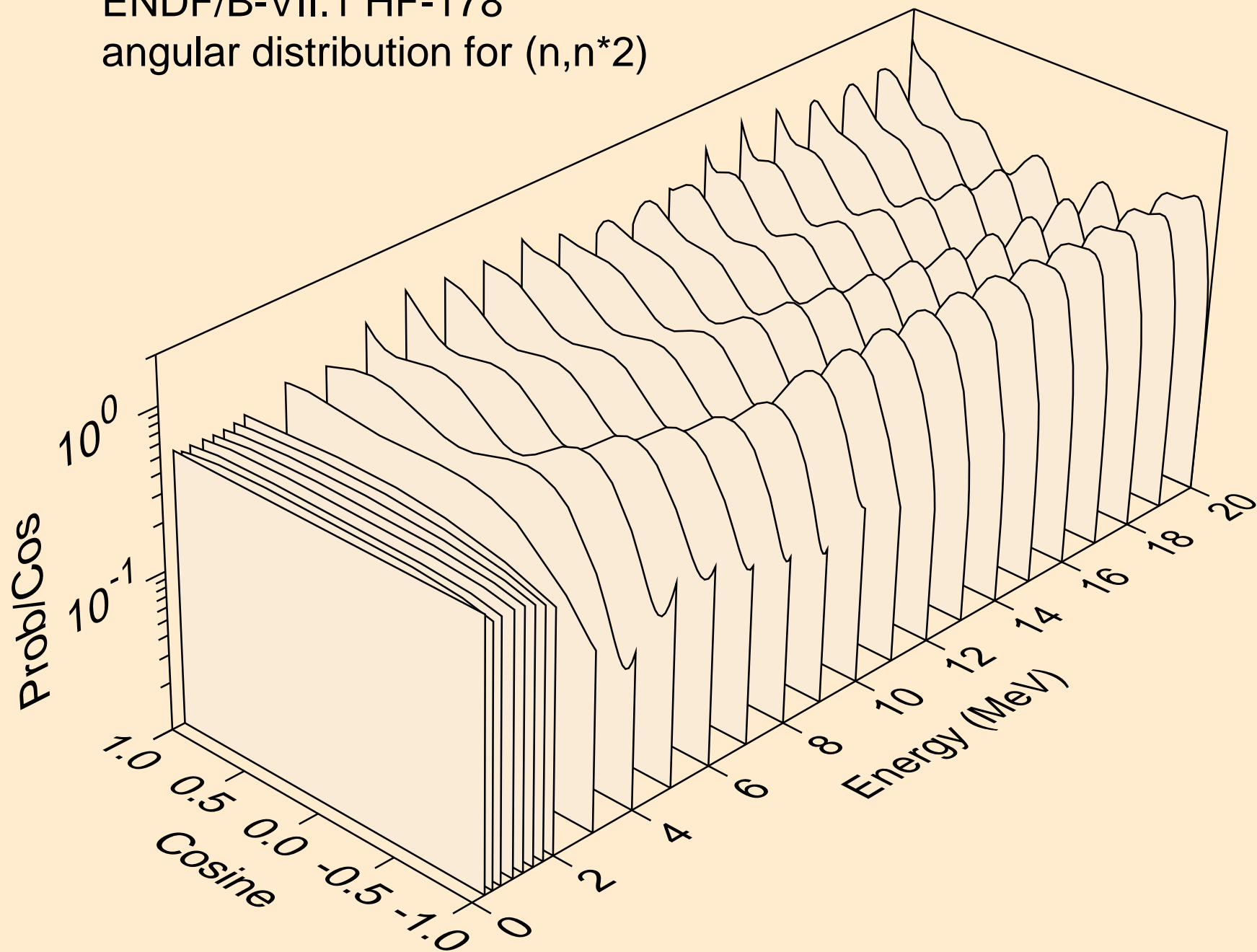

ENDF/B-VII.1 HF-178
angular distribution for (n,n*3)

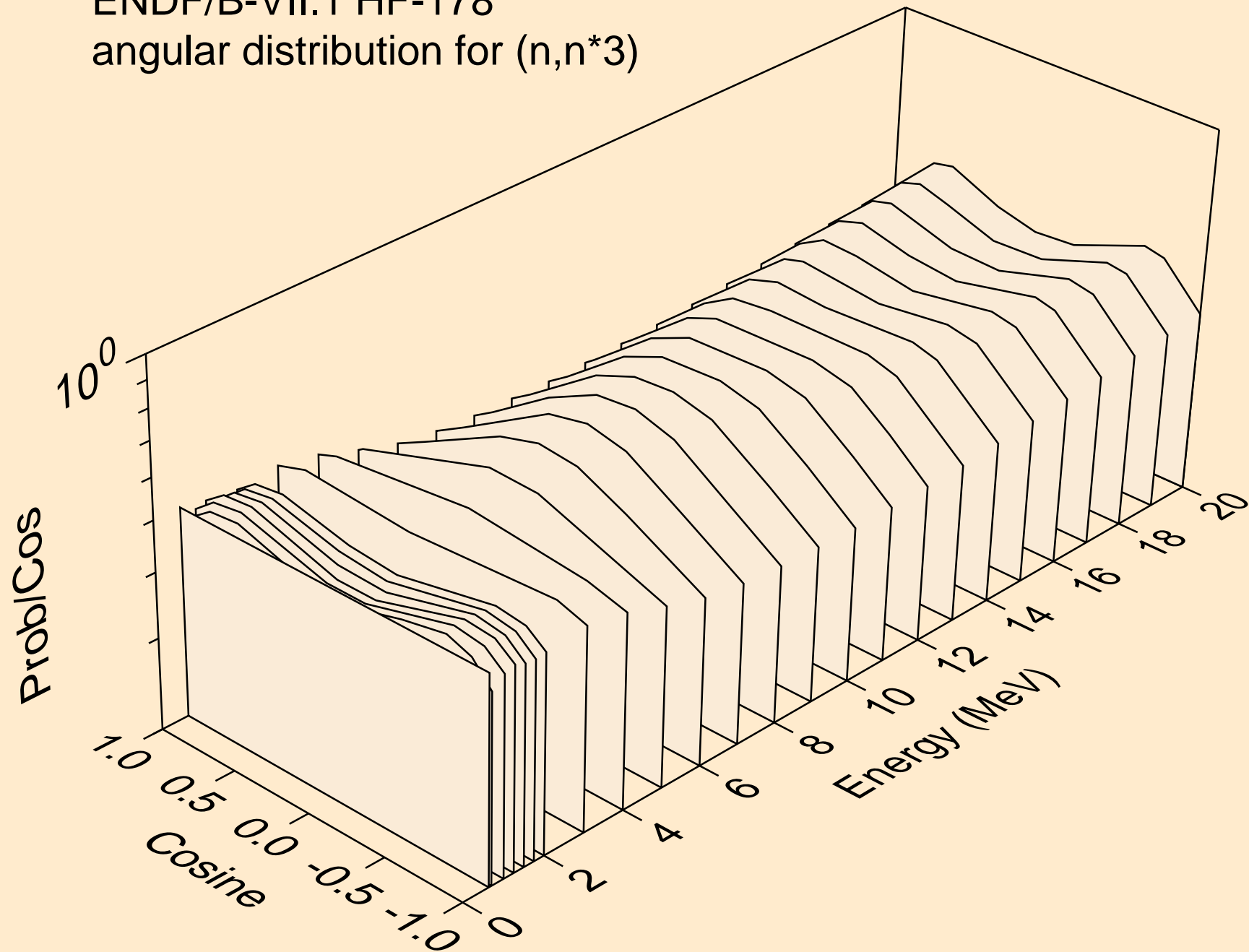

ENDF/B-VII.1 HF-178
angular distribution for (n,n*4)

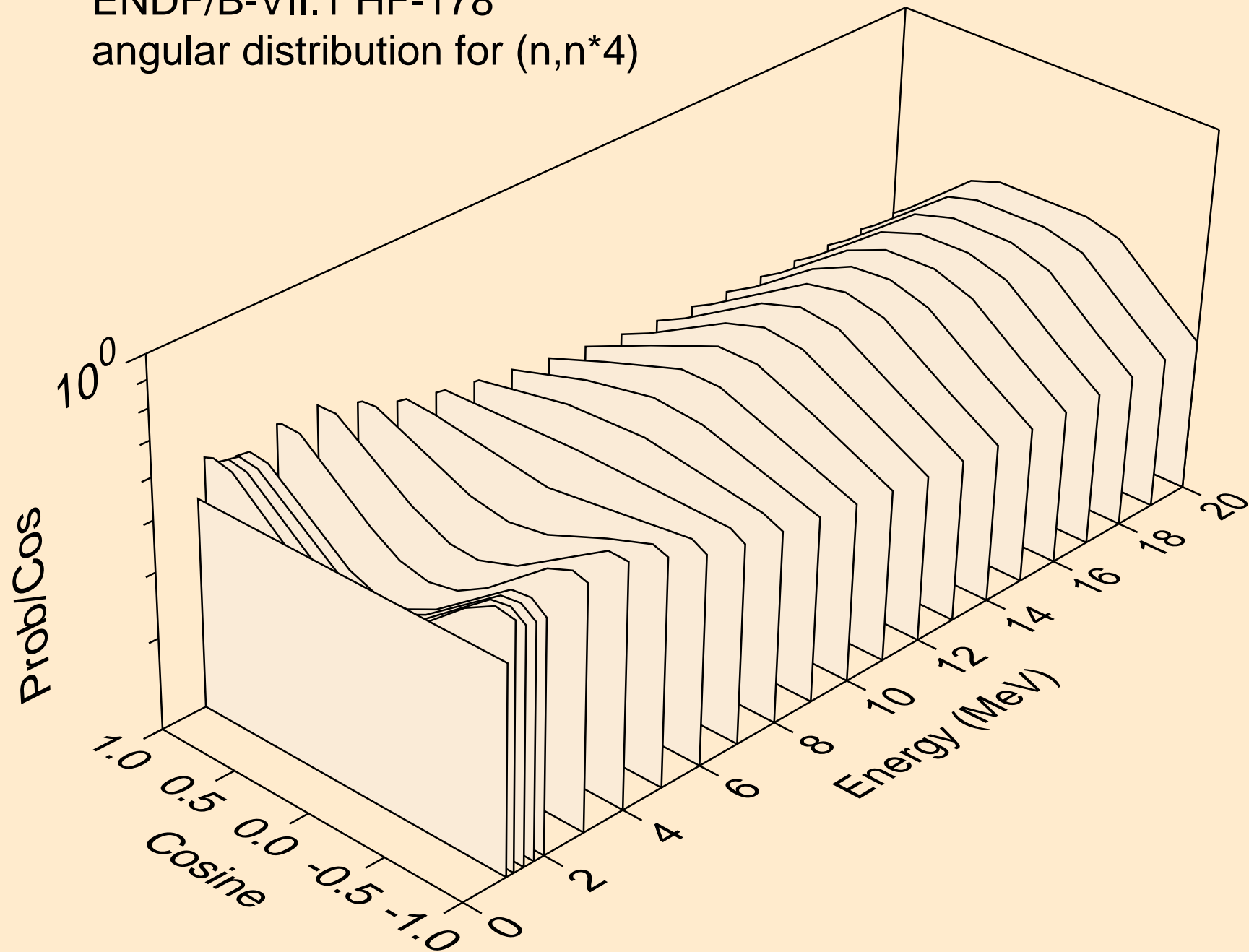

ENDF/B-VII.1 HF-178
angular distribution for (n,n*5)

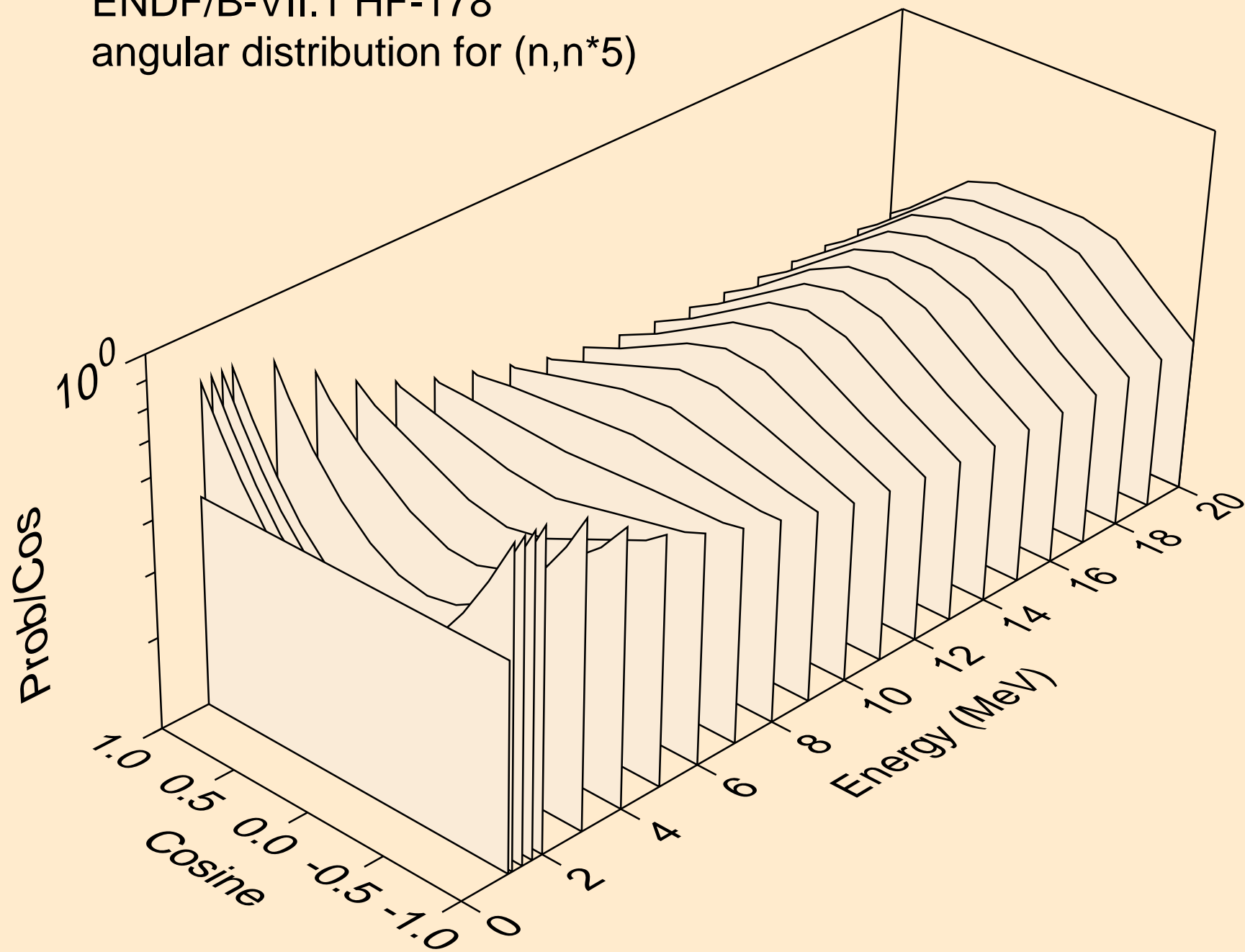

ENDF/B-VII.1 HF-178
angular distribution for (n,n*6)

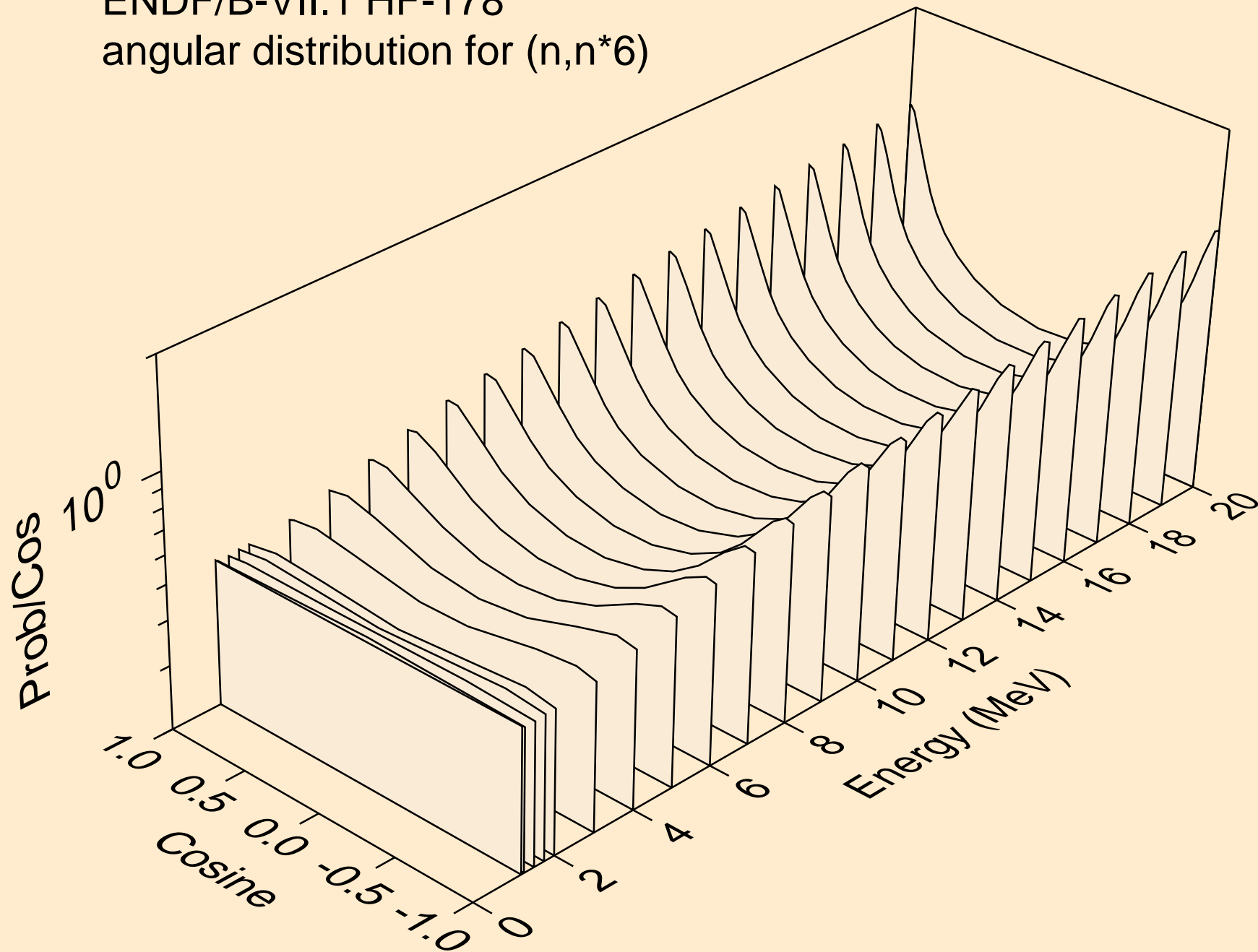

ENDF/B-VII.1 HF-178
angular distribution for (n,n*7)

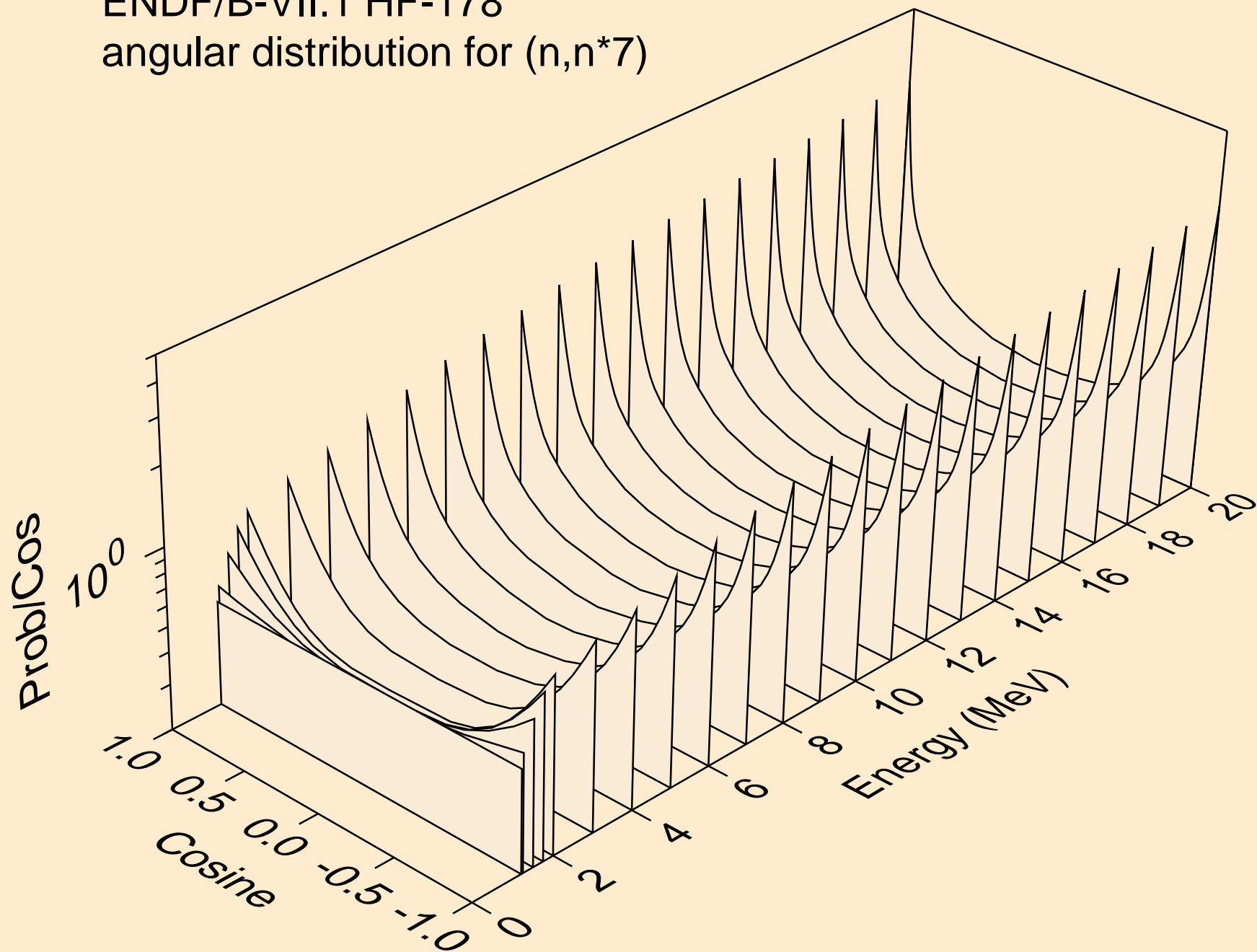

ENDF/B-VII.1 HF-178
angular distribution for (n,n*8)

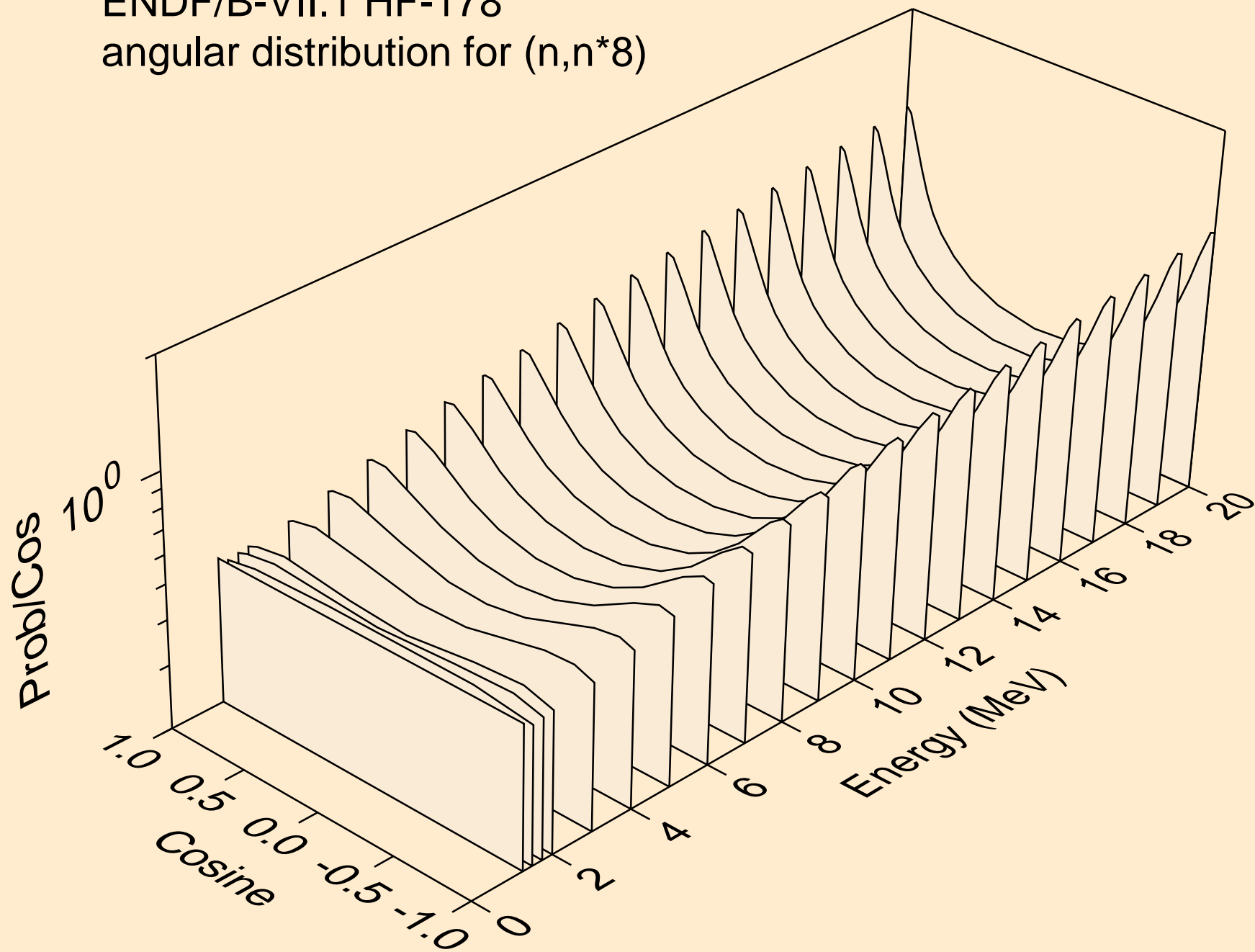

ENDF/B-VII.1 HF-178
angular distribution for (n,n*9)

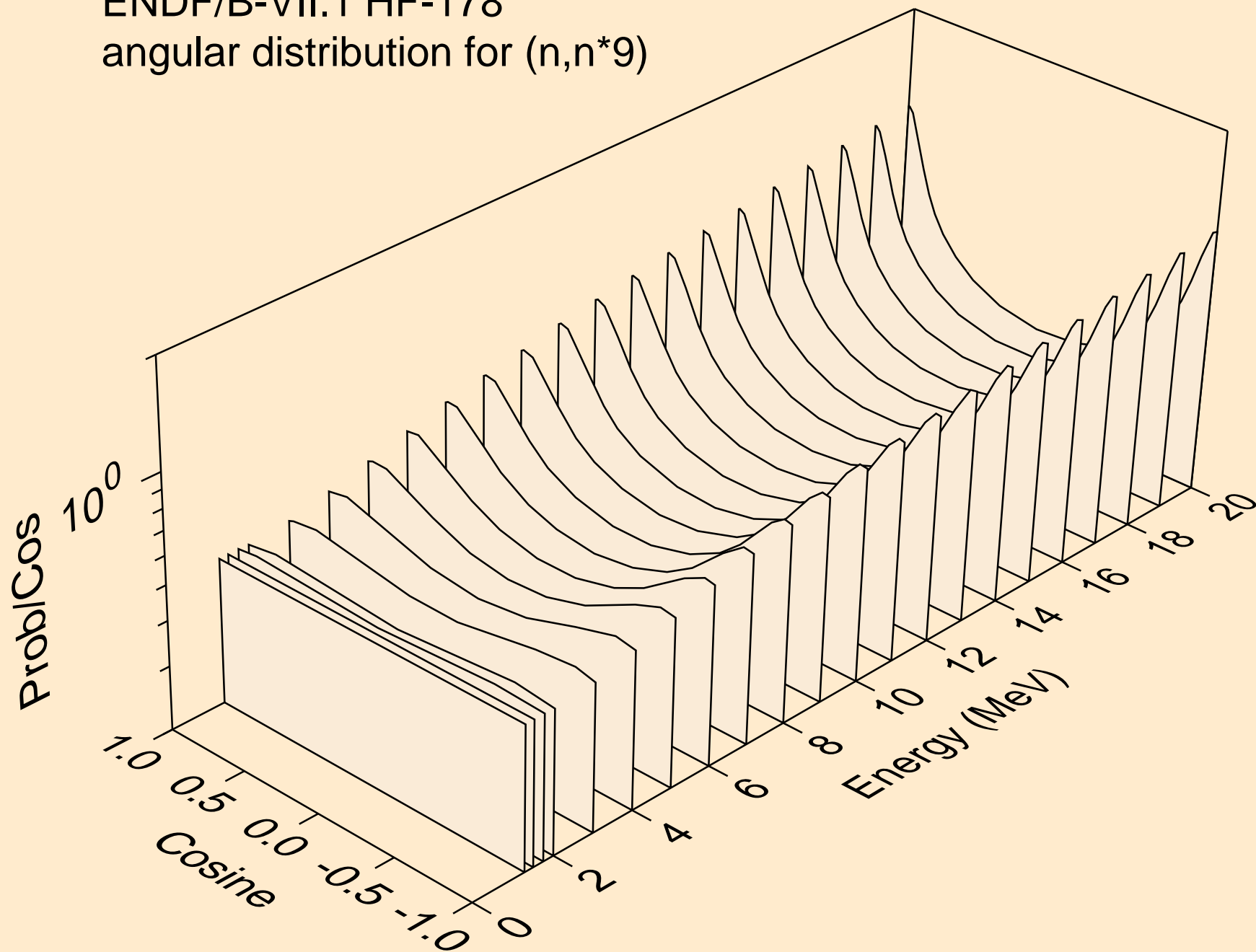

ENDF/B-VII.1 HF-178
angular distribution for (n,n*10)

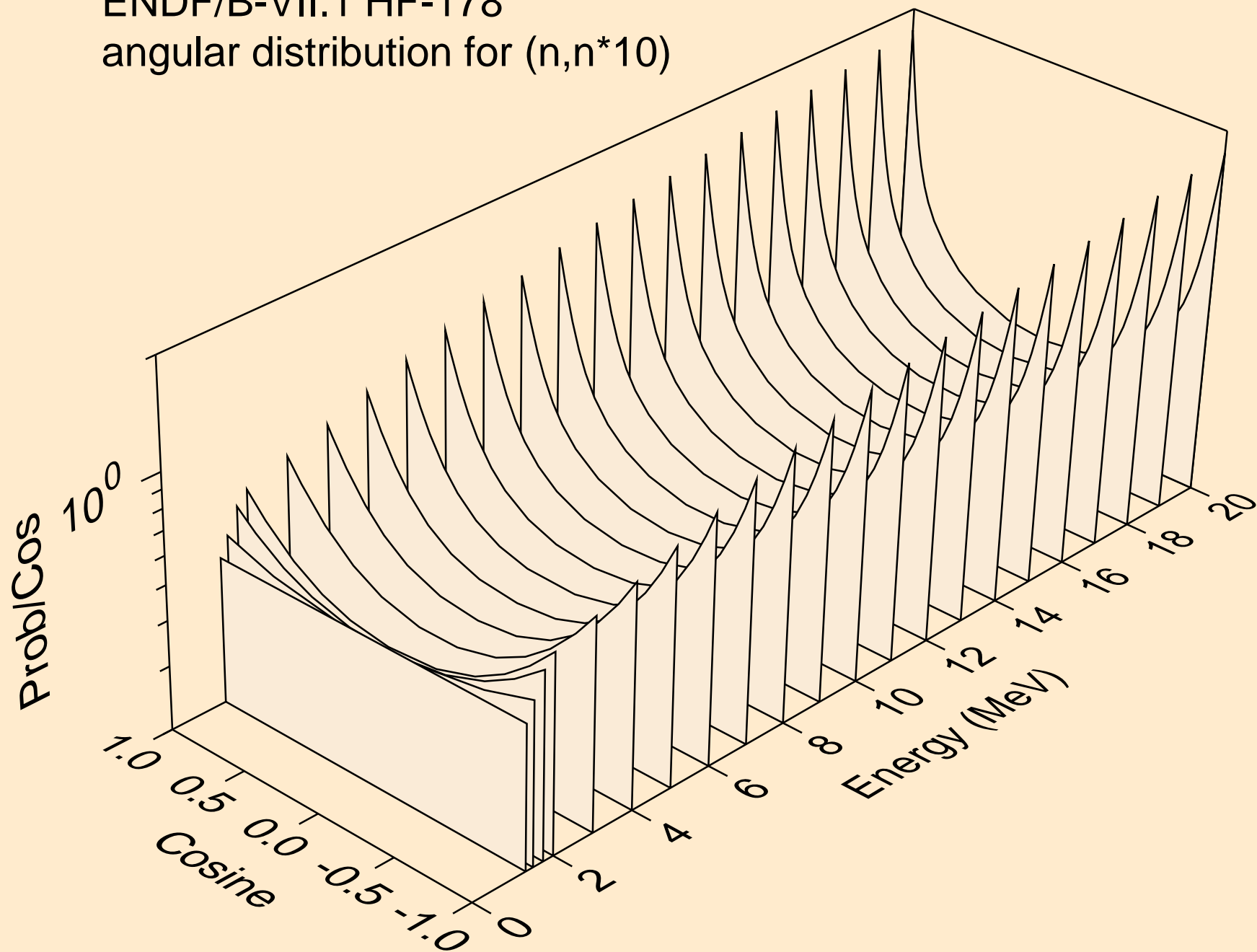

ENDF/B-VII.1 HF-178
angular distribution for (n,n*11)

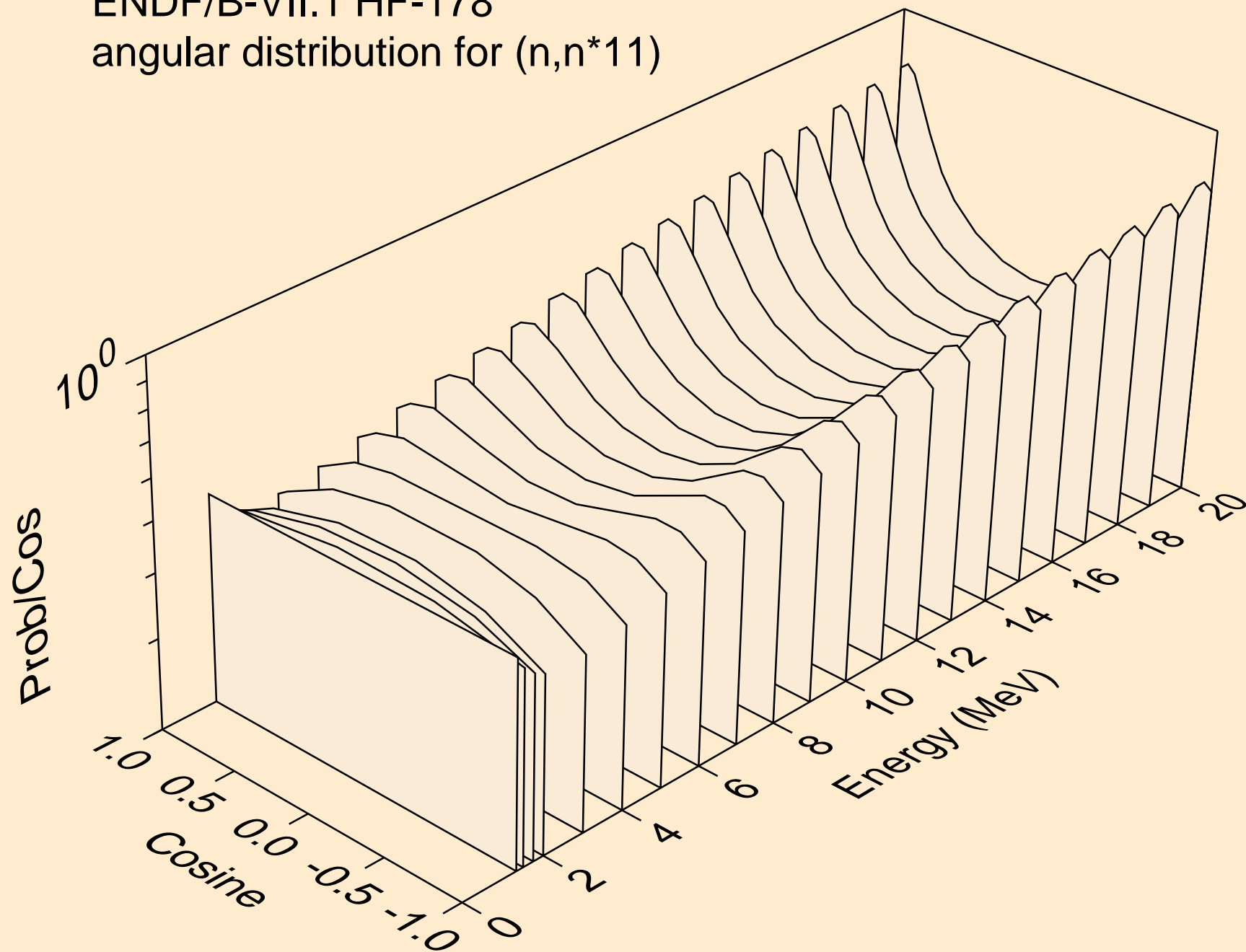

ENDF/B-VII.1 HF-178
angular distribution for (n,n*12)

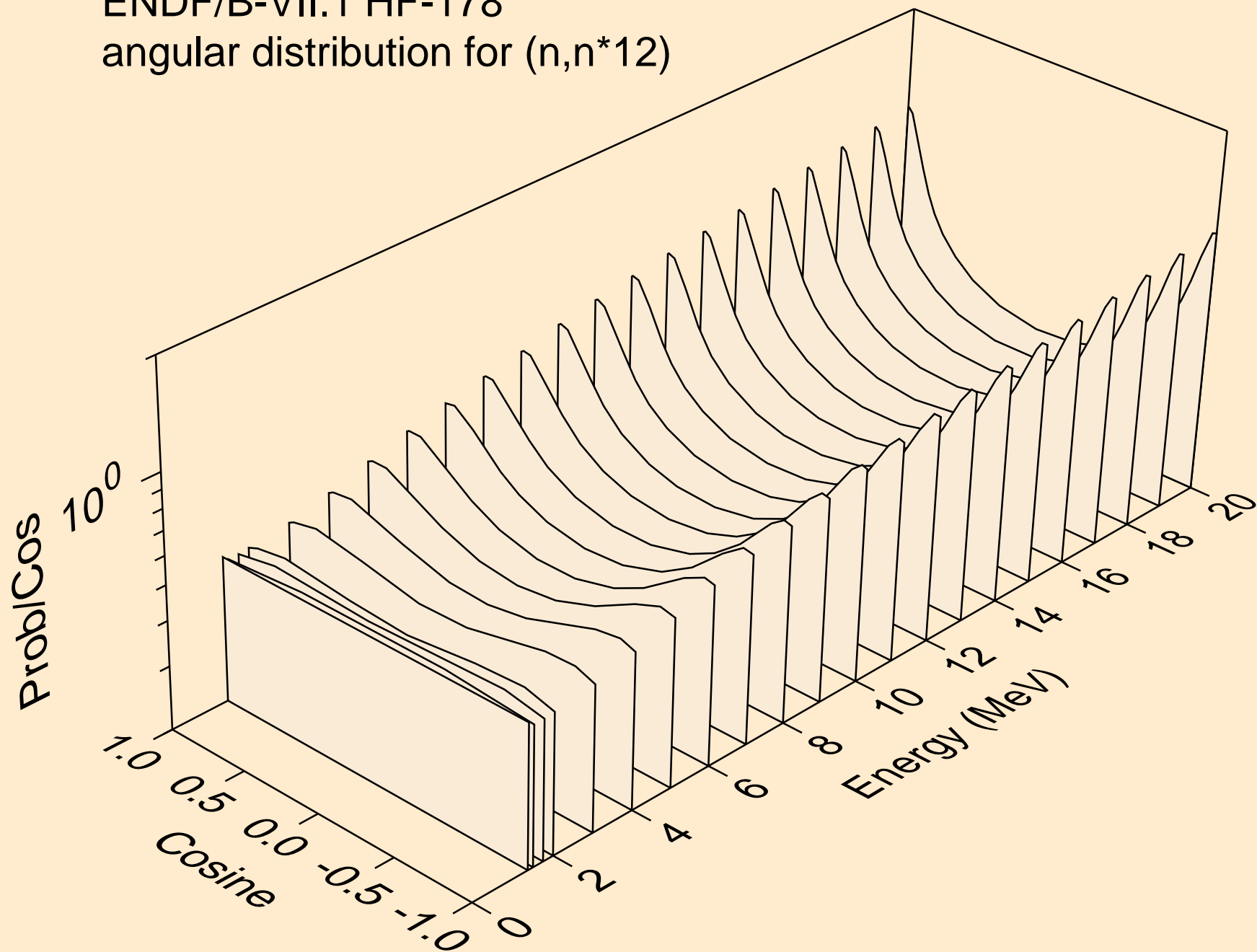

ENDF/B-VII.1 HF-178
angular distribution for (n,n*13)

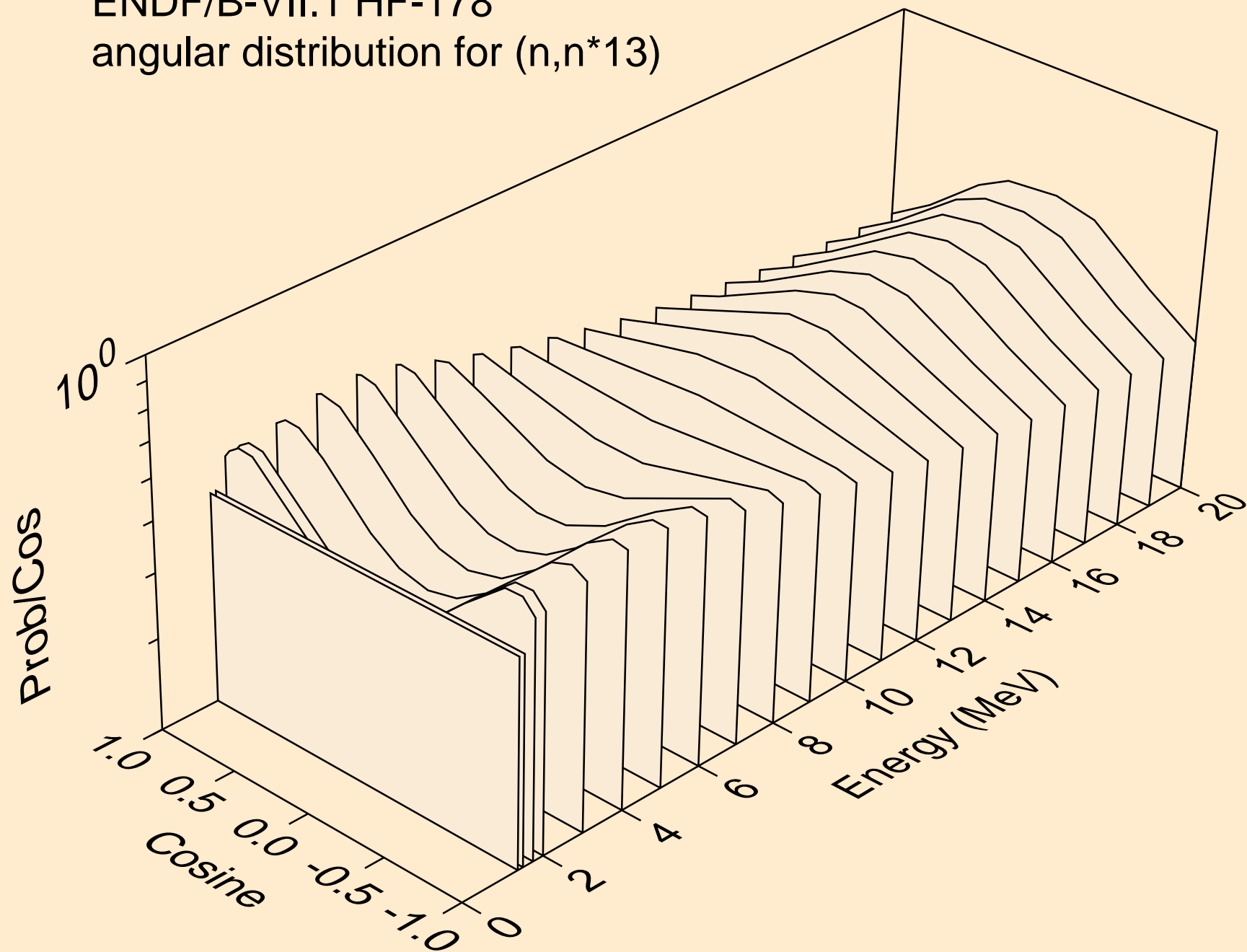

ENDF/B-VII.1 HF-178
angular distribution for (n,n*14)

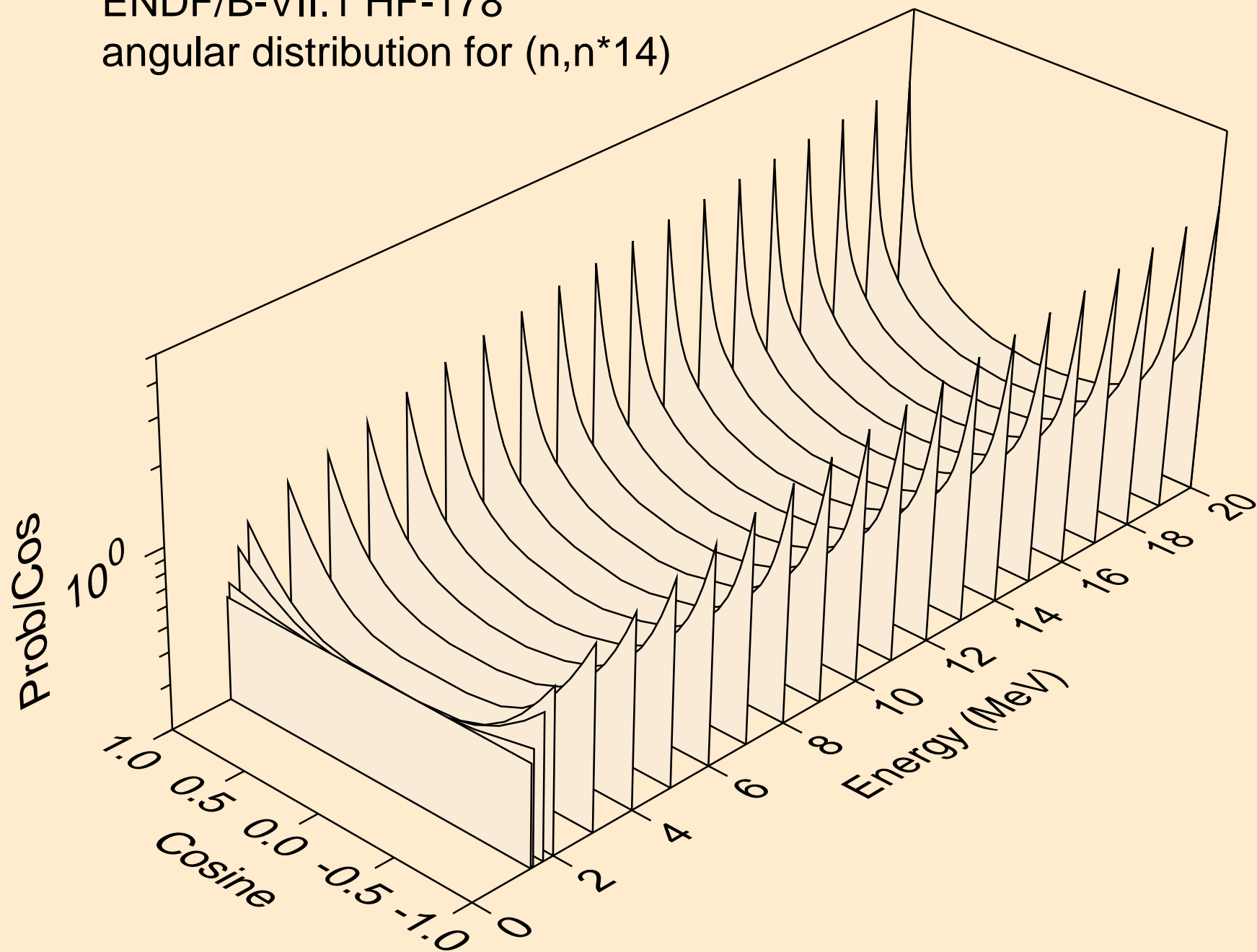

ENDF/B-VII.1 HF-178
angular distribution for (n,n*15)

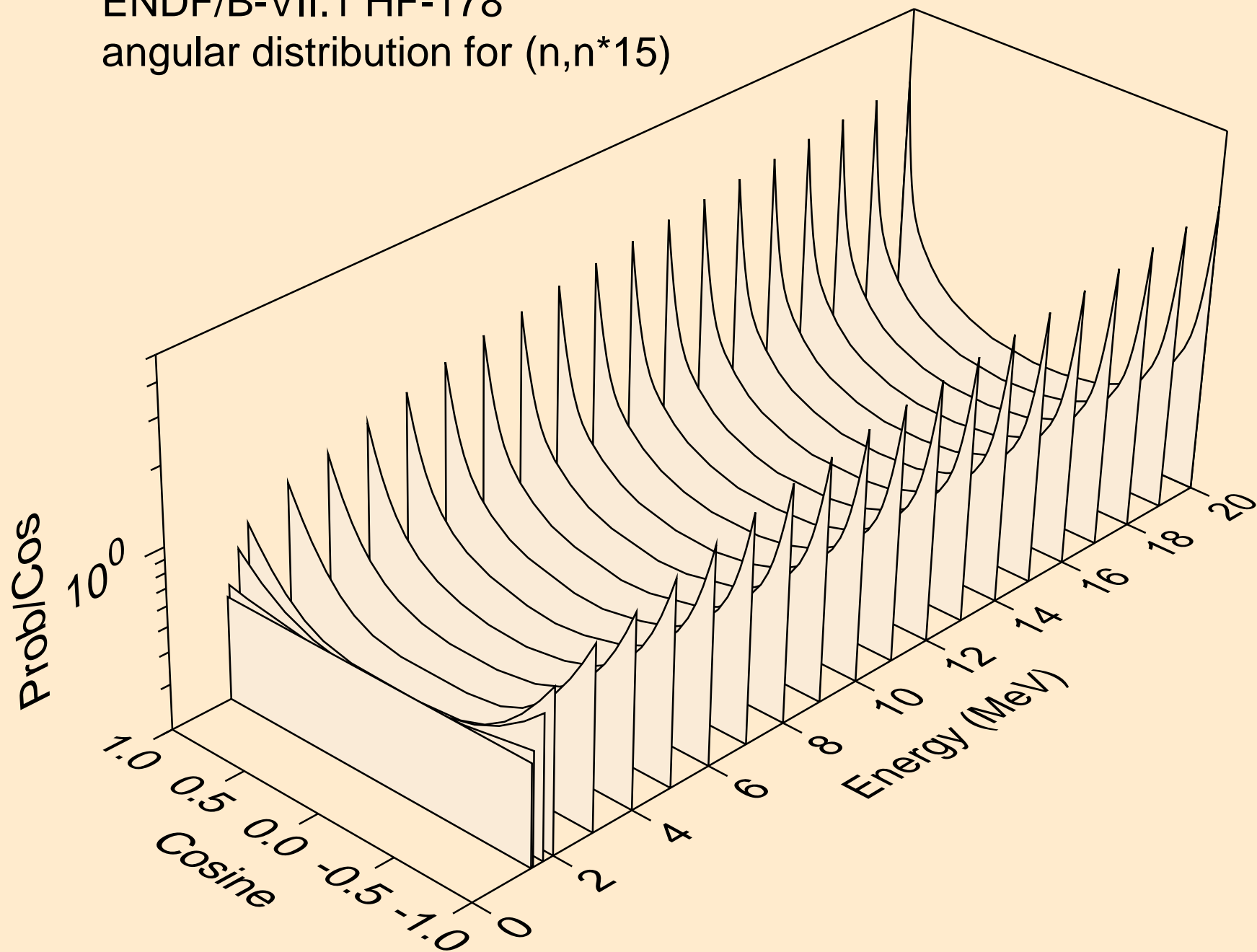

ENDF/B-VII.1 HF-178
angular distribution for (n,n*16)

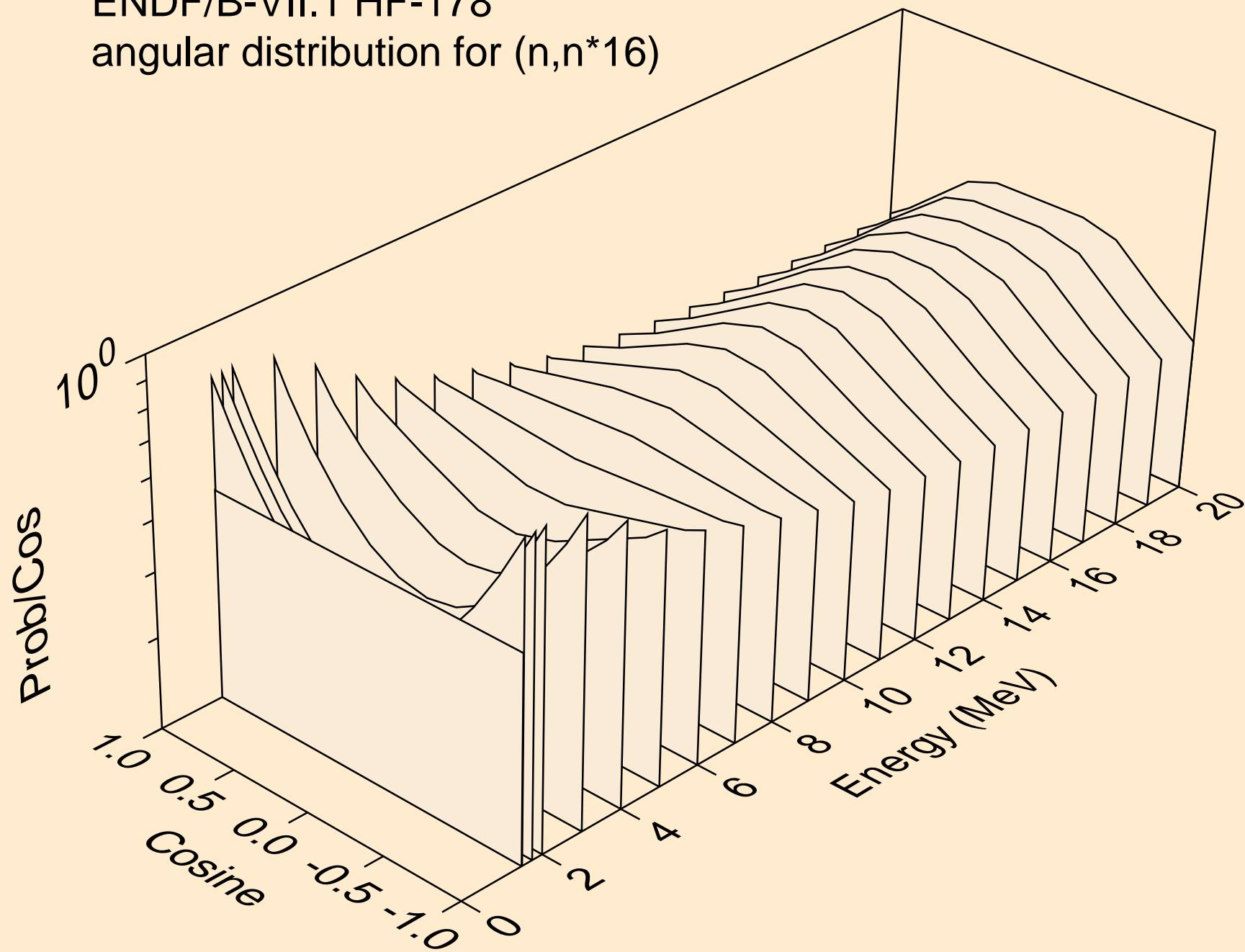

ENDF/B-VII.1 HF-178
angular distribution for (n,n*17)

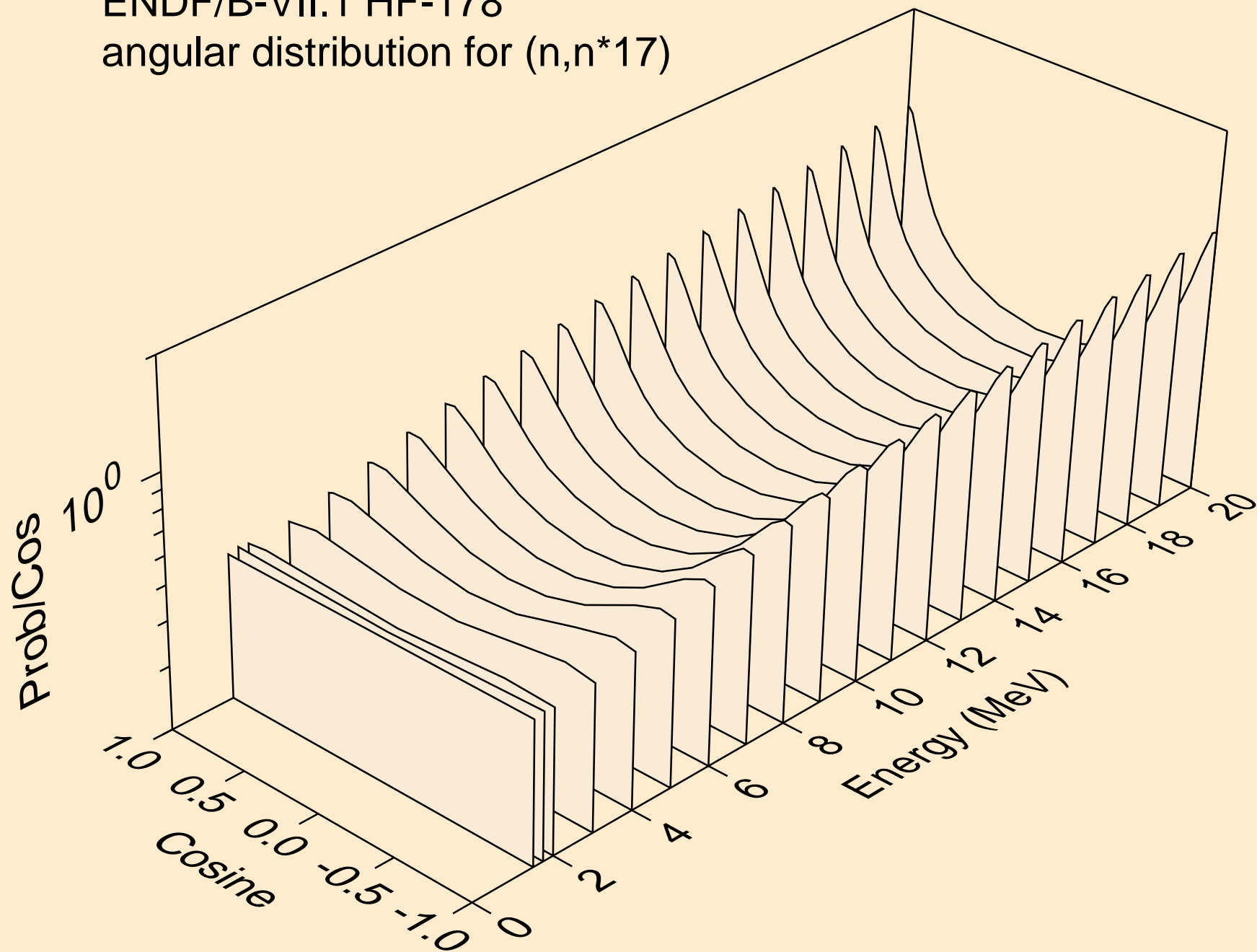

ENDF/B-VII.1 HF-178
angular distribution for (n,n*18)

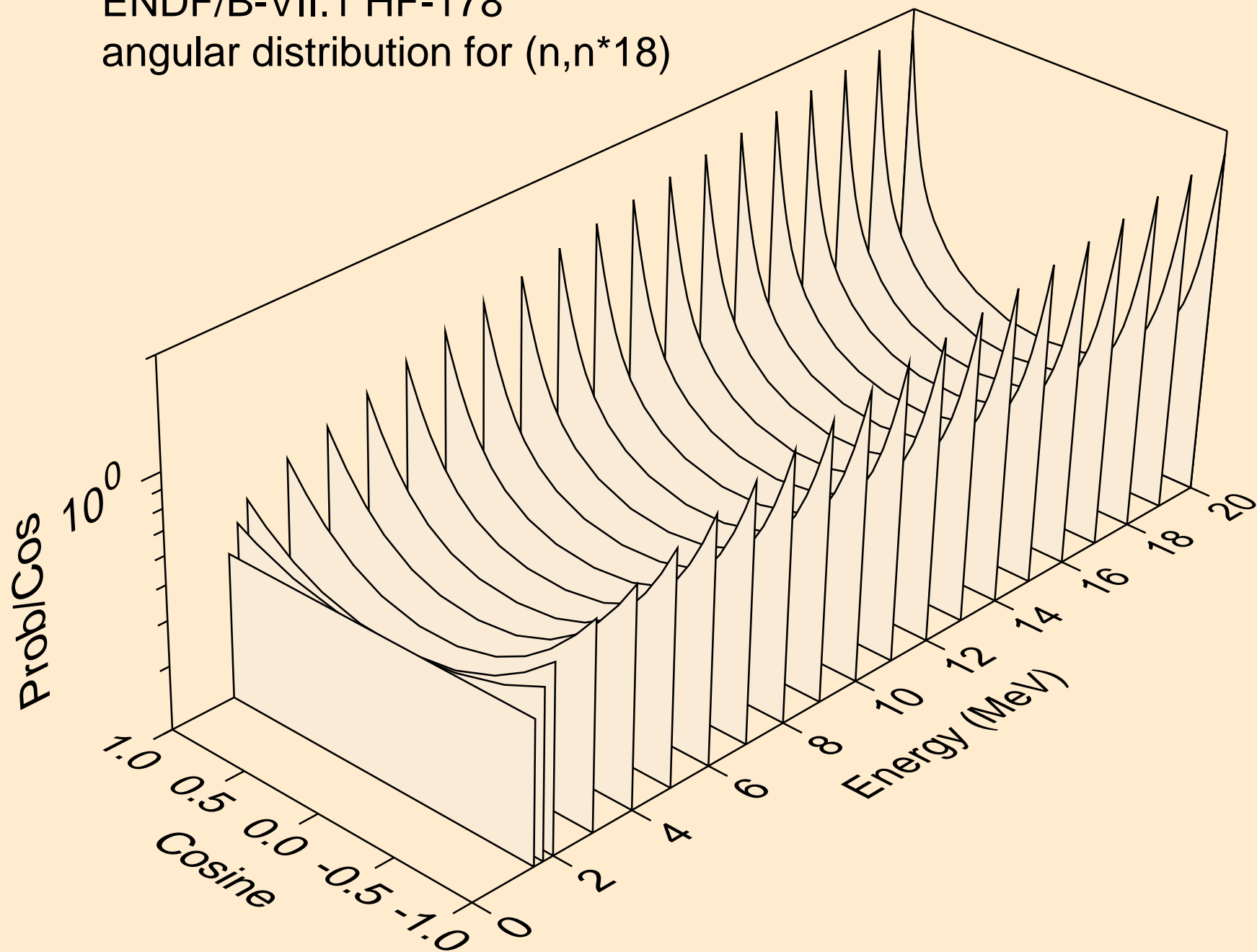

ENDF/B-VII.1 HF-178
angular distribution for (n,n*19)

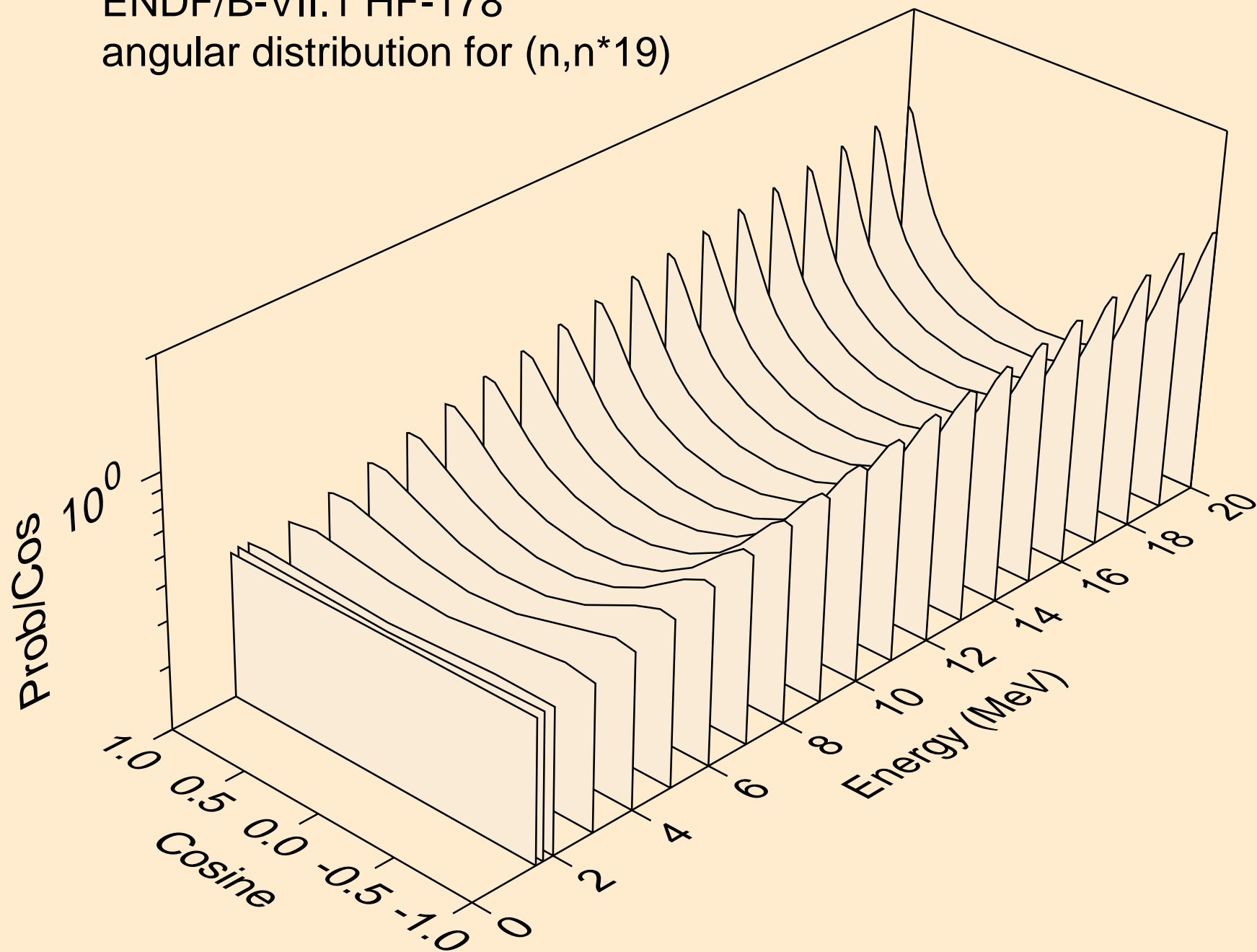

ENDF/B-VII.1 HF-178
angular distribution for (n,n*20)

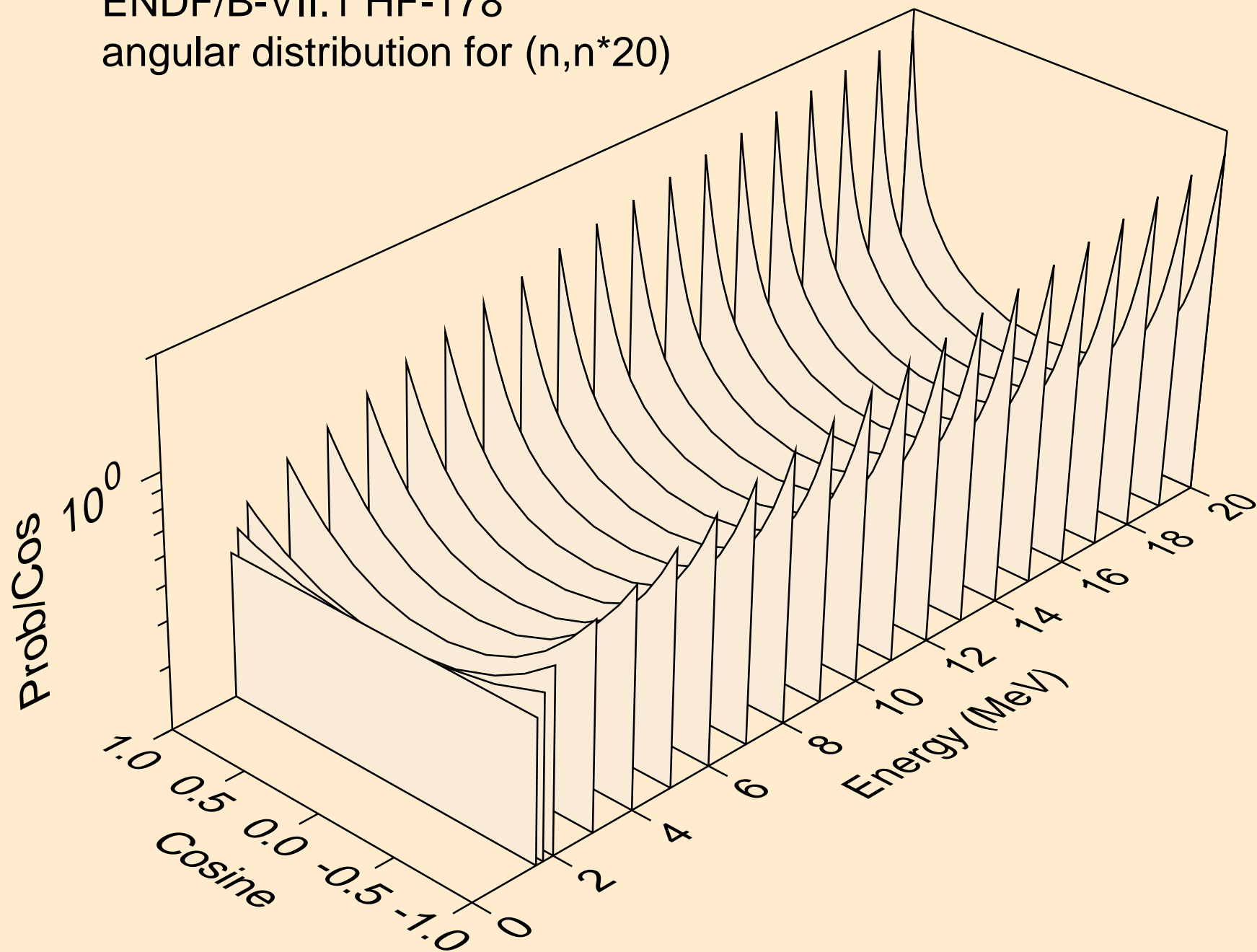

ENDF/B-VII.1 HF-178
angular distribution for (n,n*21)

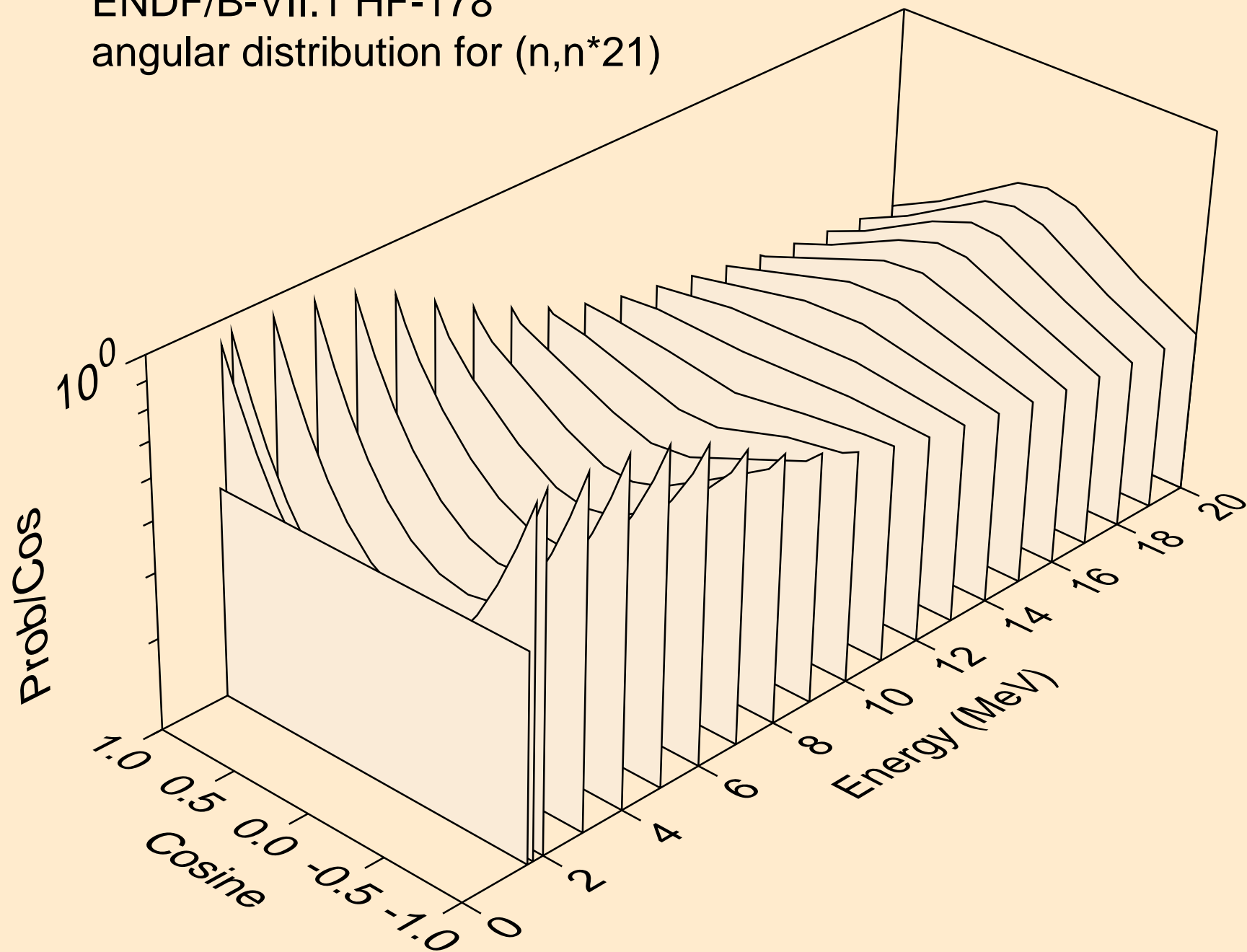

ENDF/B-VII.1 HF-178
Neutron emission for (n,2n)

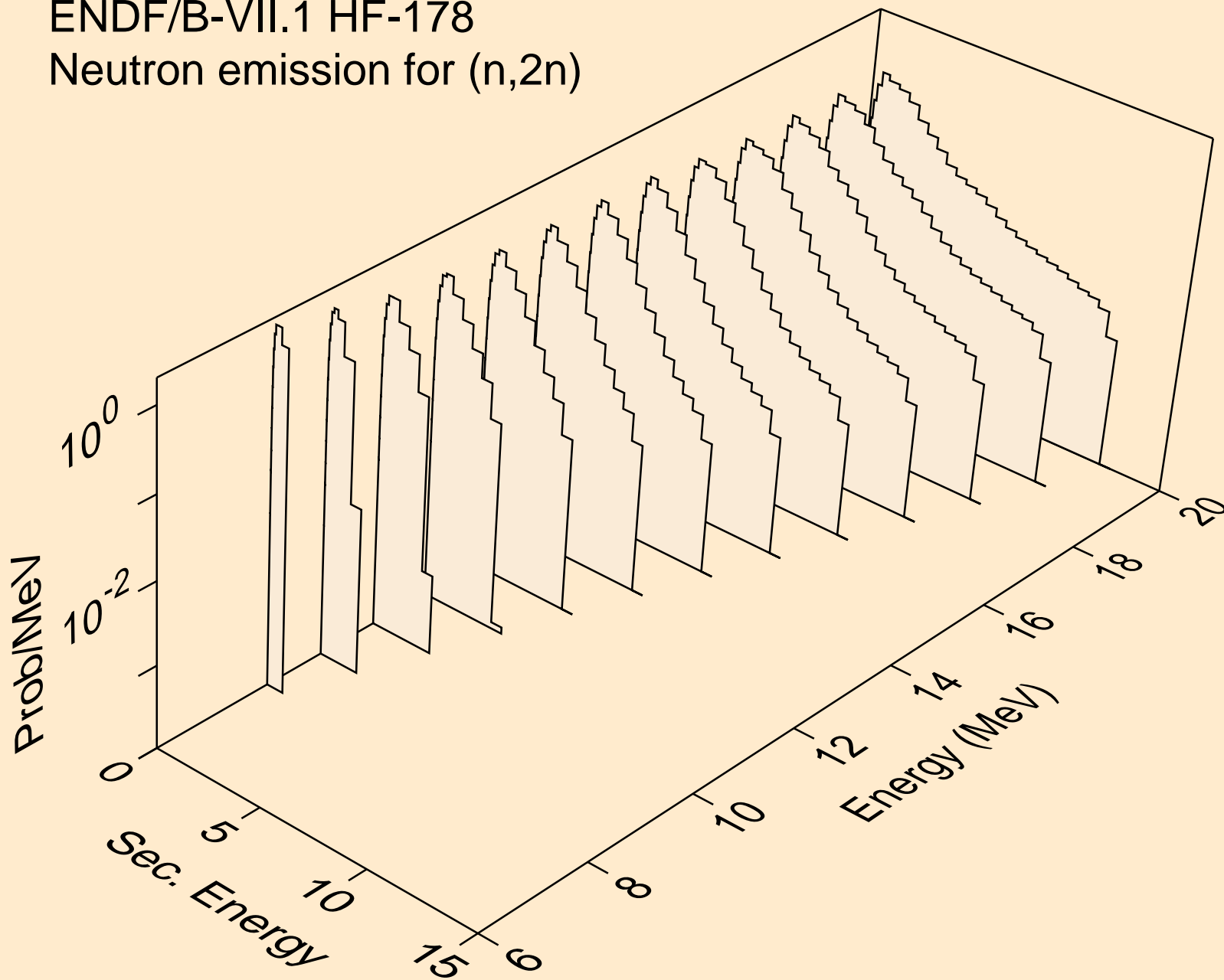

ENDF/B-VII.1 HF-178
Neutron emission for (n,3n)

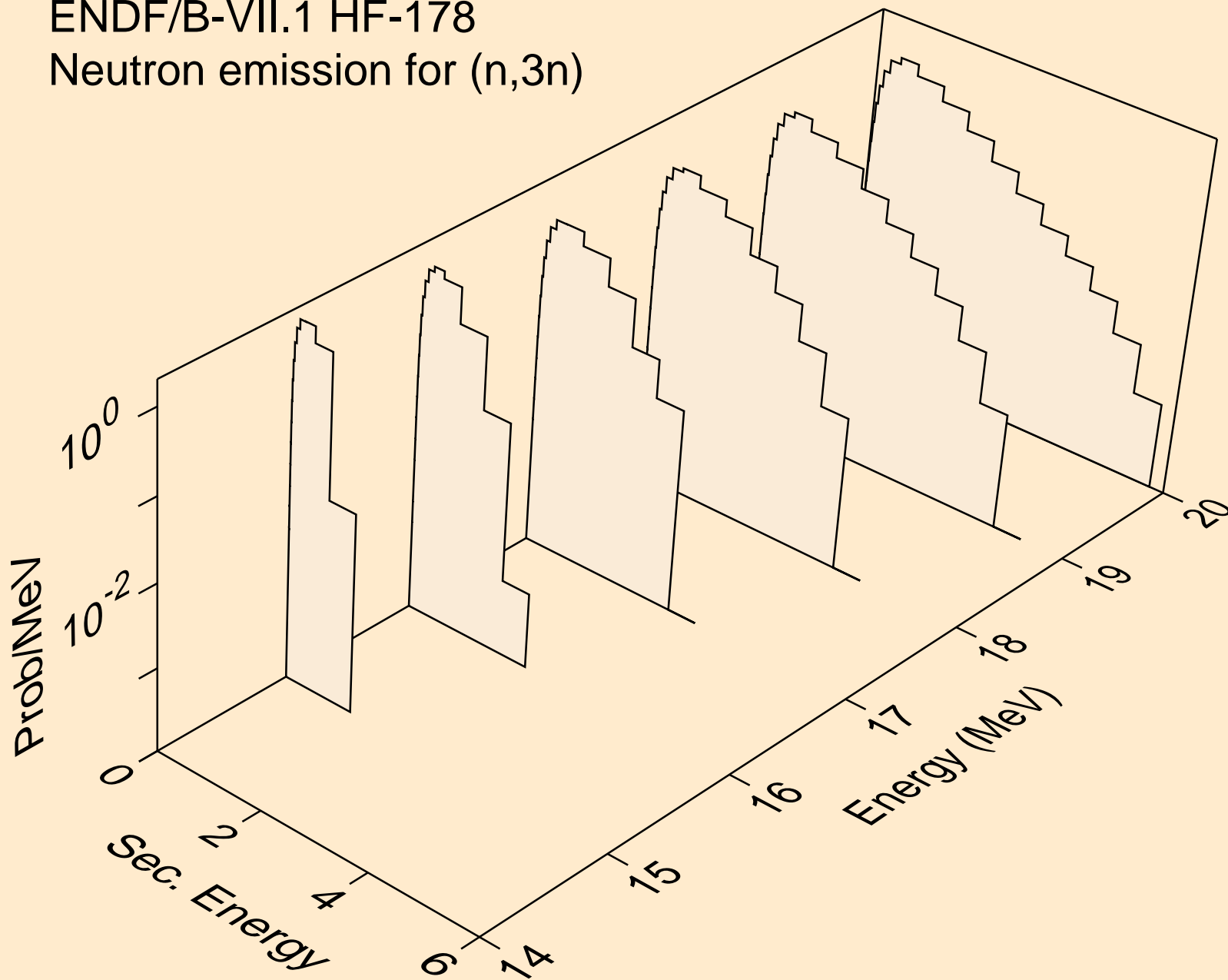

ENDF/B-VII.1 HF-178
Neutron emission for (n,n*c)

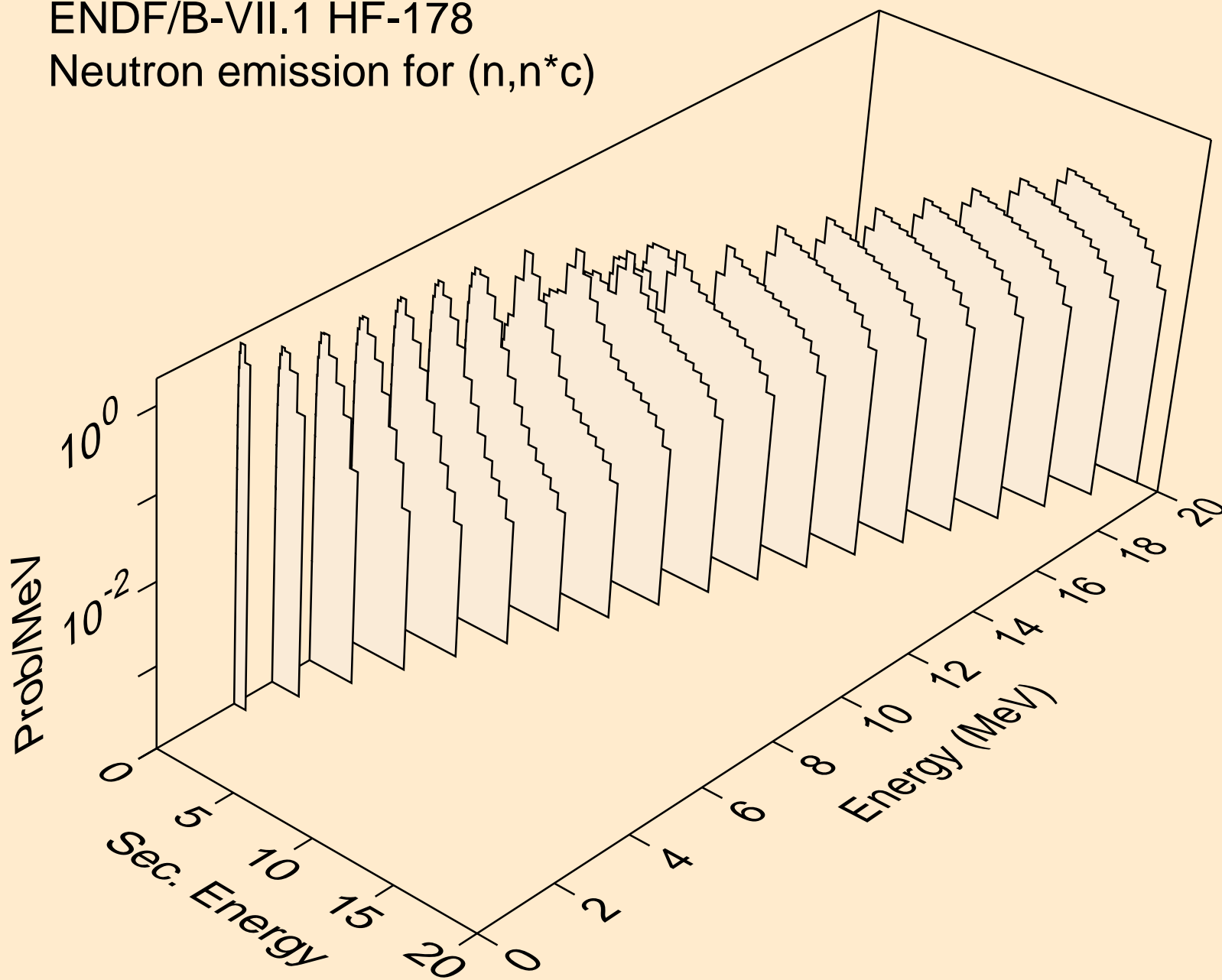

ENDF/B-VII.1 HF-178
Photon emission for (n,2n)

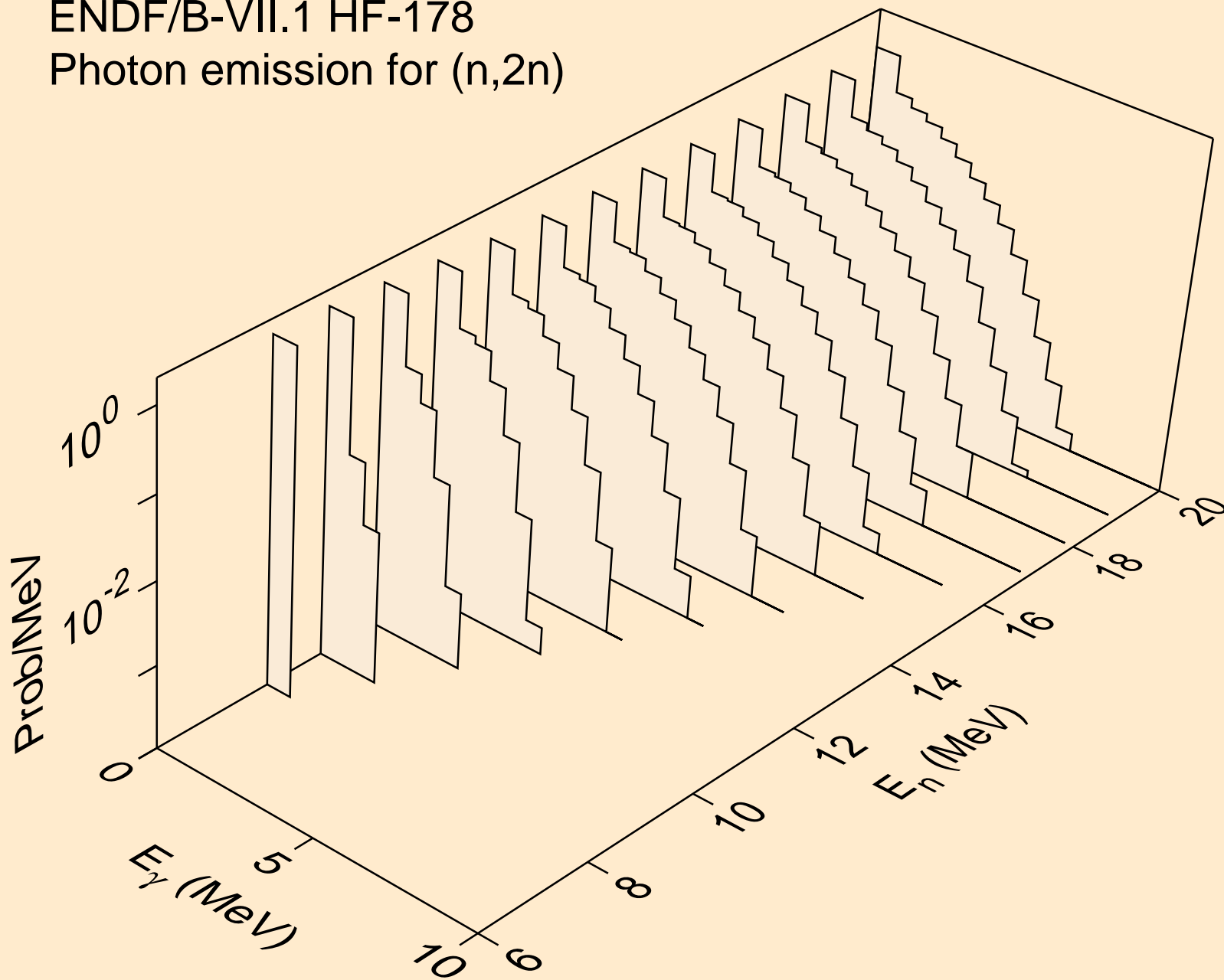

ENDF/B-VII.1 HF-178
Photon emission for (n,3n)

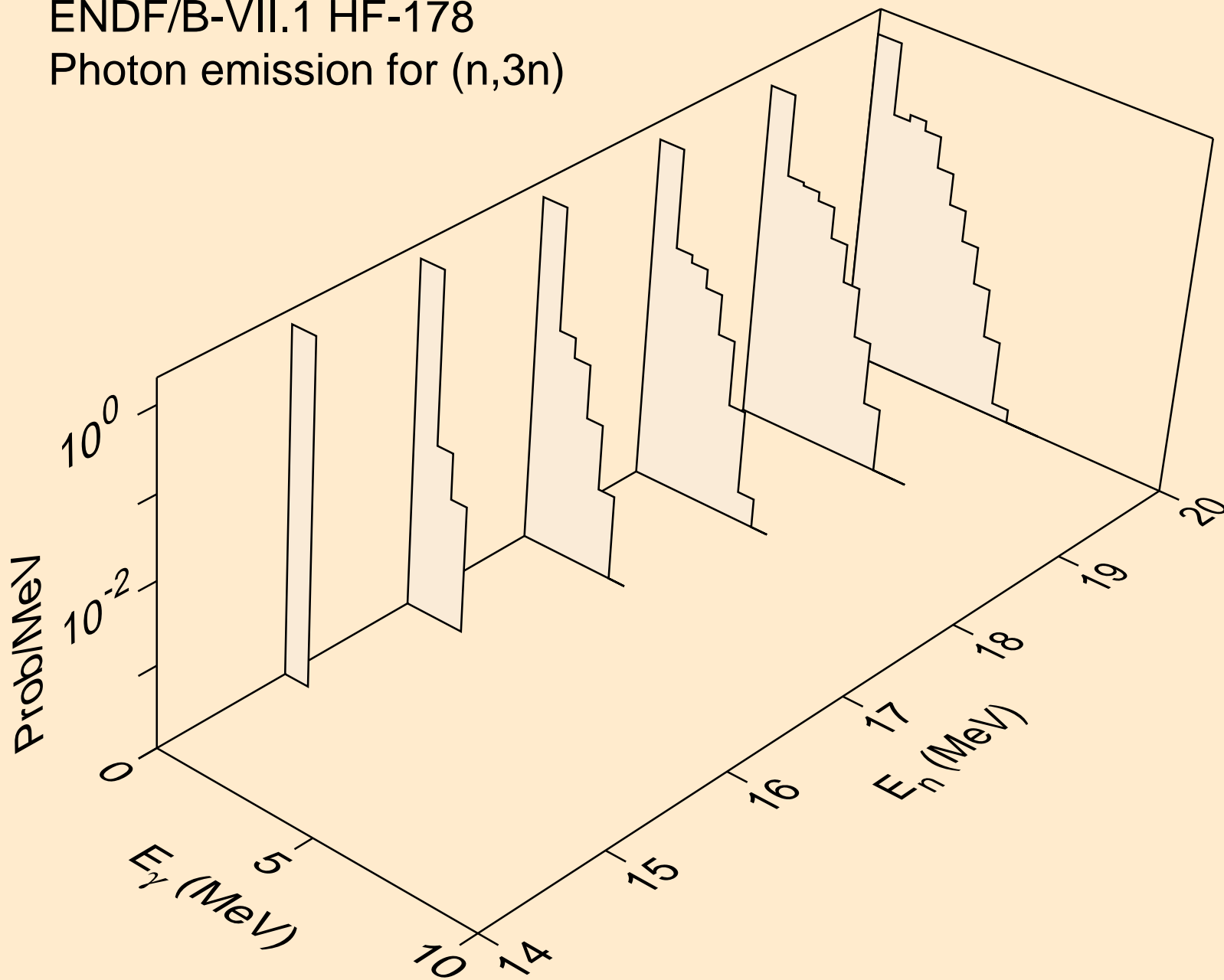

ENDF/B-VII.1 HF-178
Photon emission for (n,n*c)

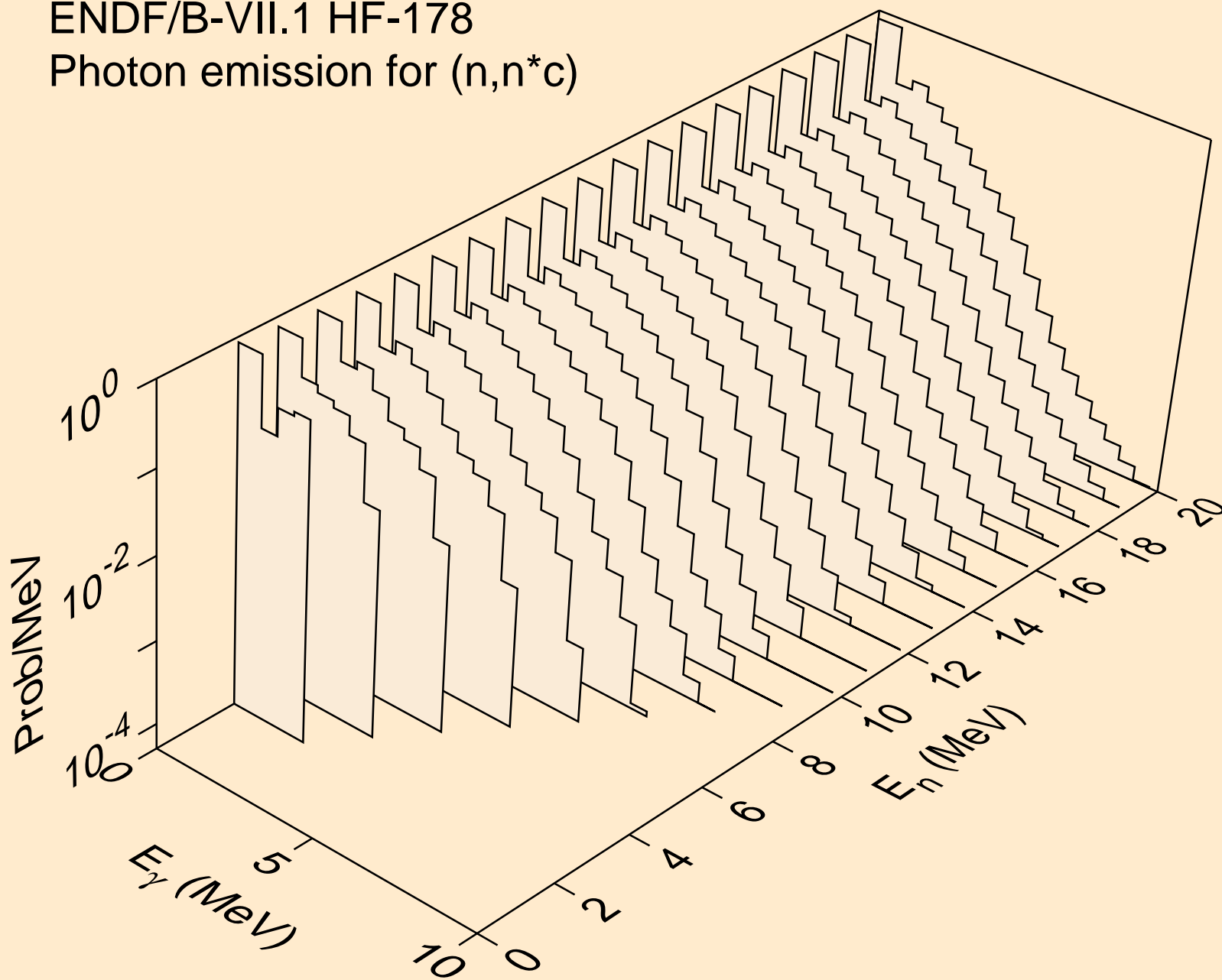

ENDF/B-VII.1 HF-178
Photon emission for (n,gma)

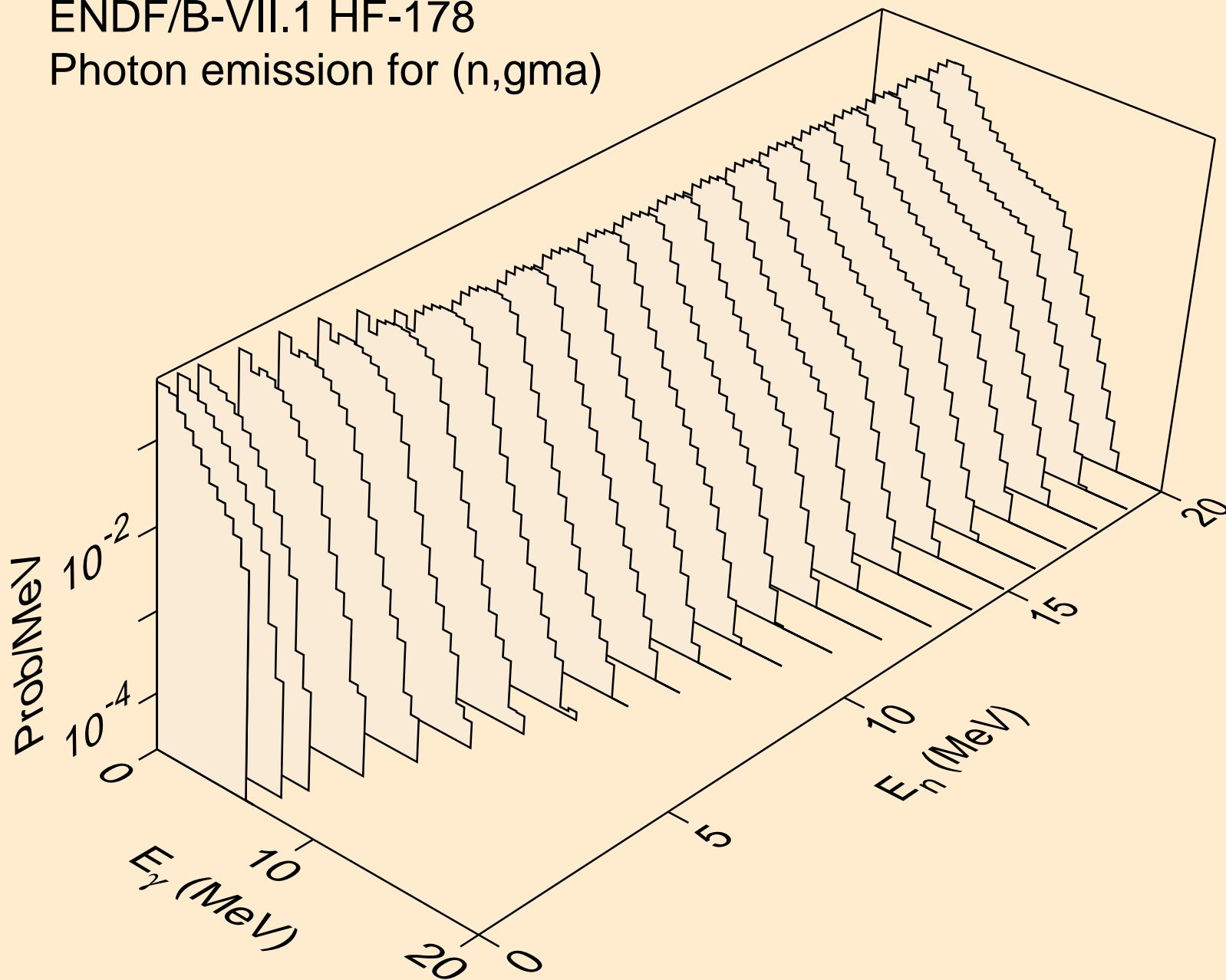

ENDF/B-VII.1 HF-178
Photon emission for (n,p)

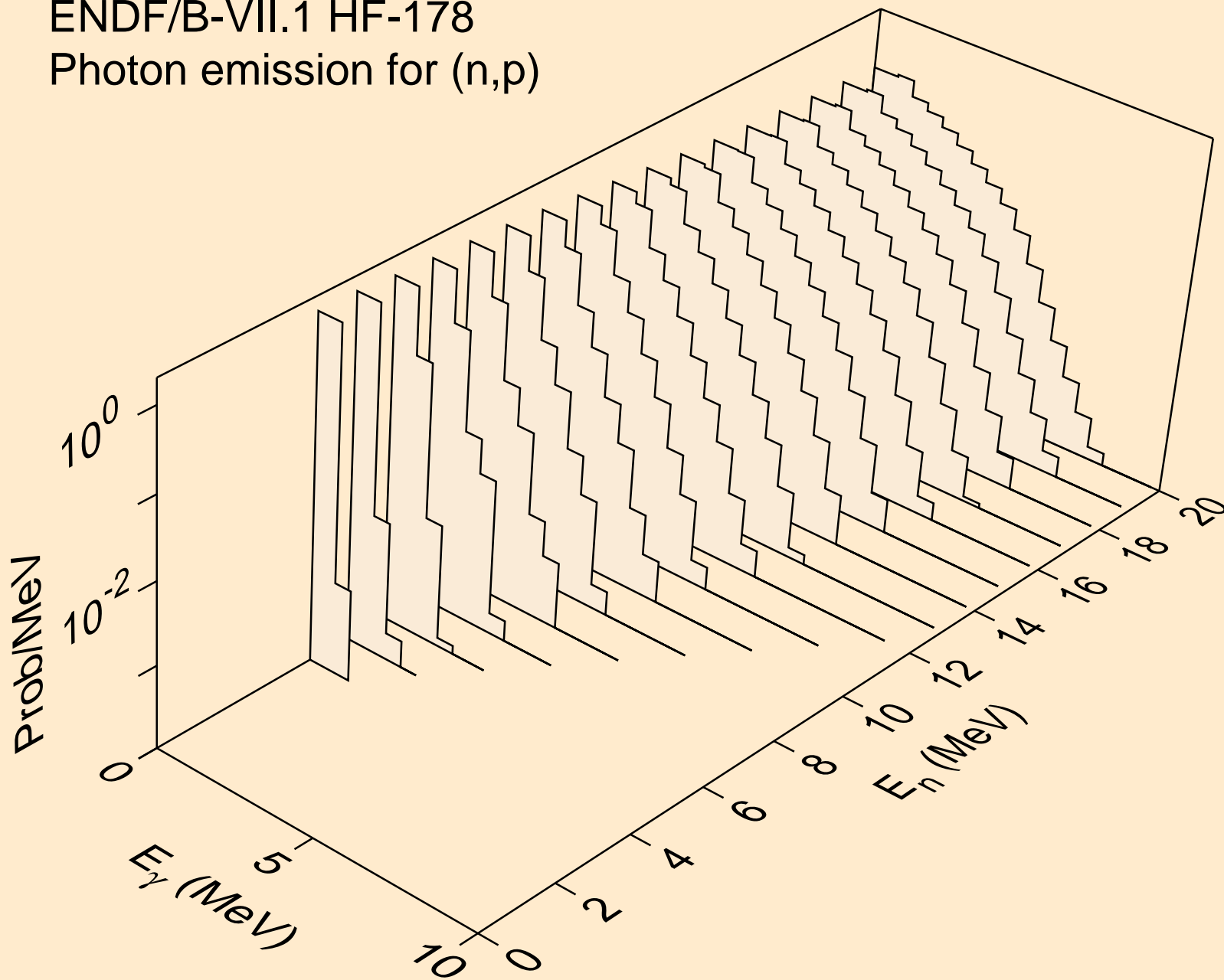

ENDF/B-VII.1 HF-178
Photon emission for (n,a)

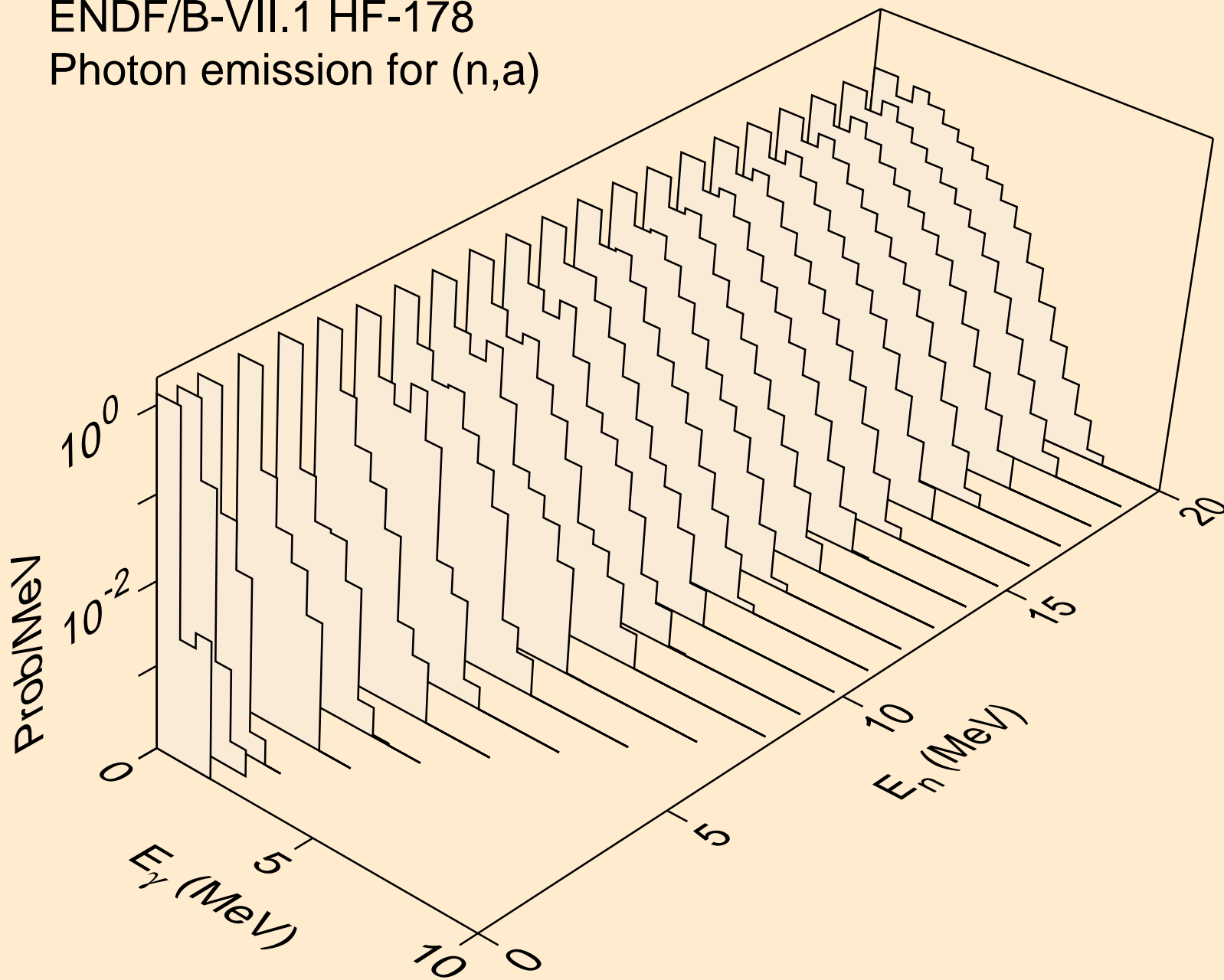

ENDF/B-VII.1 HF-178
thermal capture photon spectrum

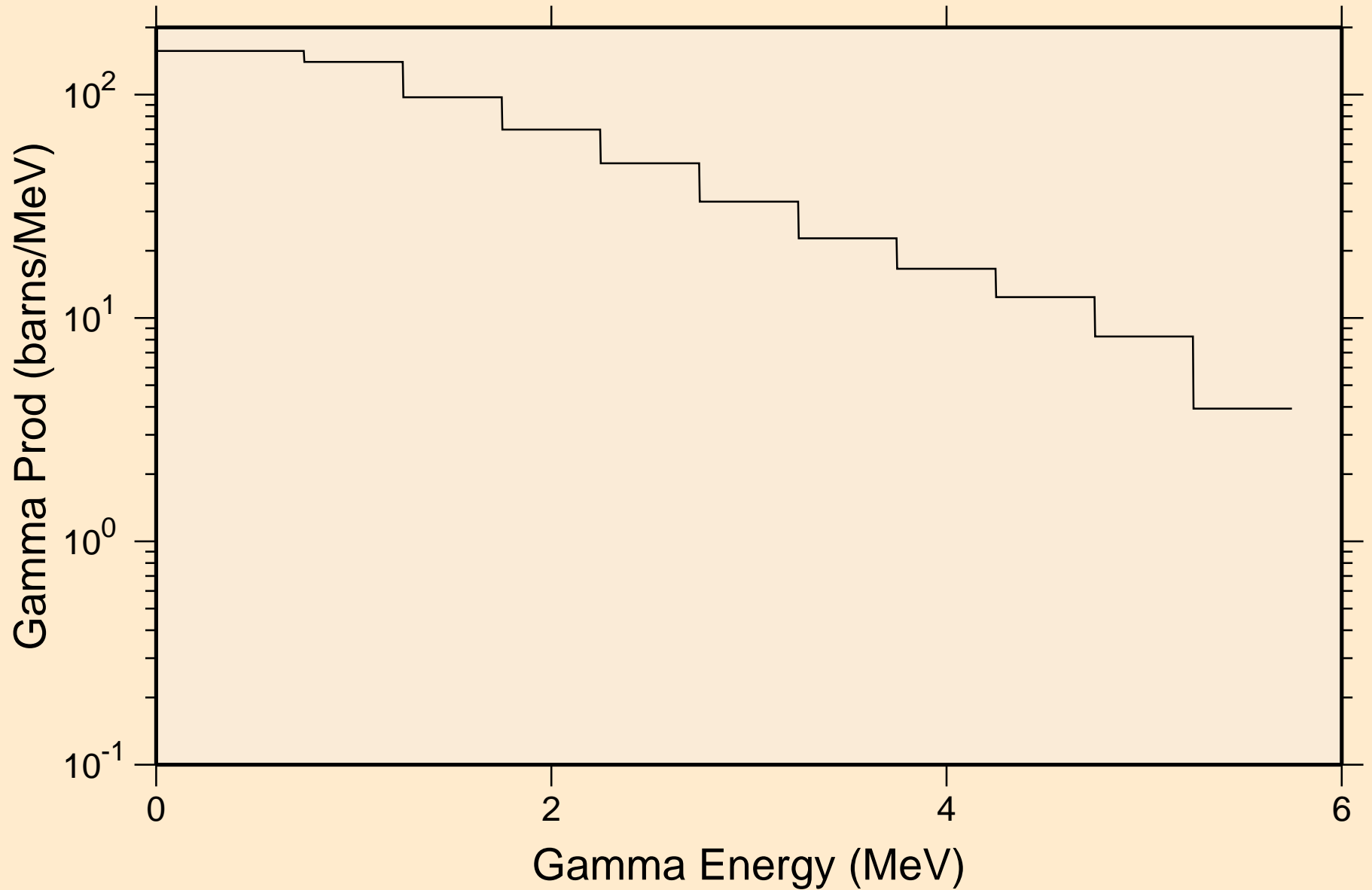

ENDF/B-VII.1 HF-178
14 MeV photon spectrum

