

ENDF/B-VII.1 HF-176

Principal cross sections

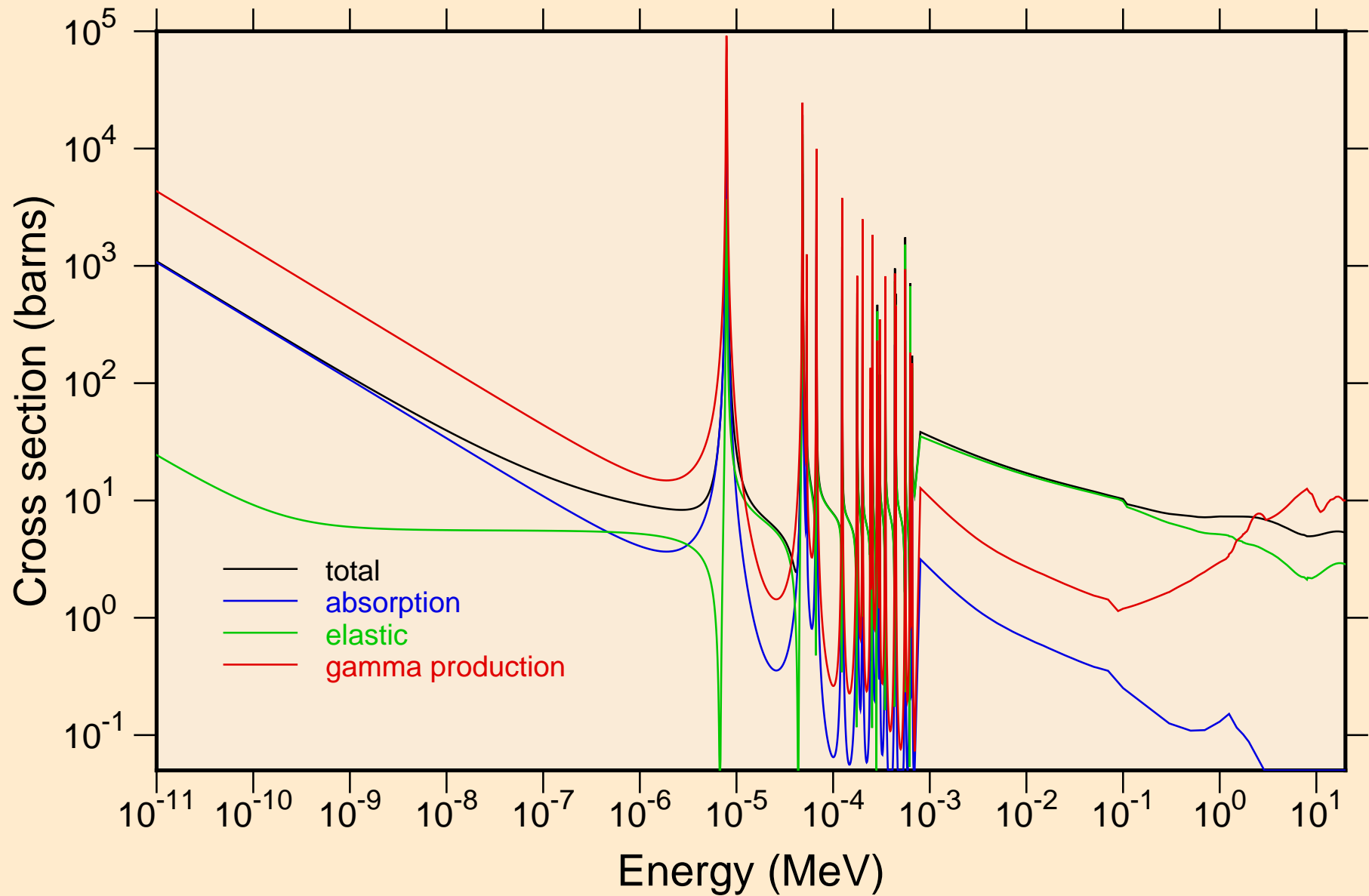

ENDF/B-VII.1 HF-176
resonance total cross section

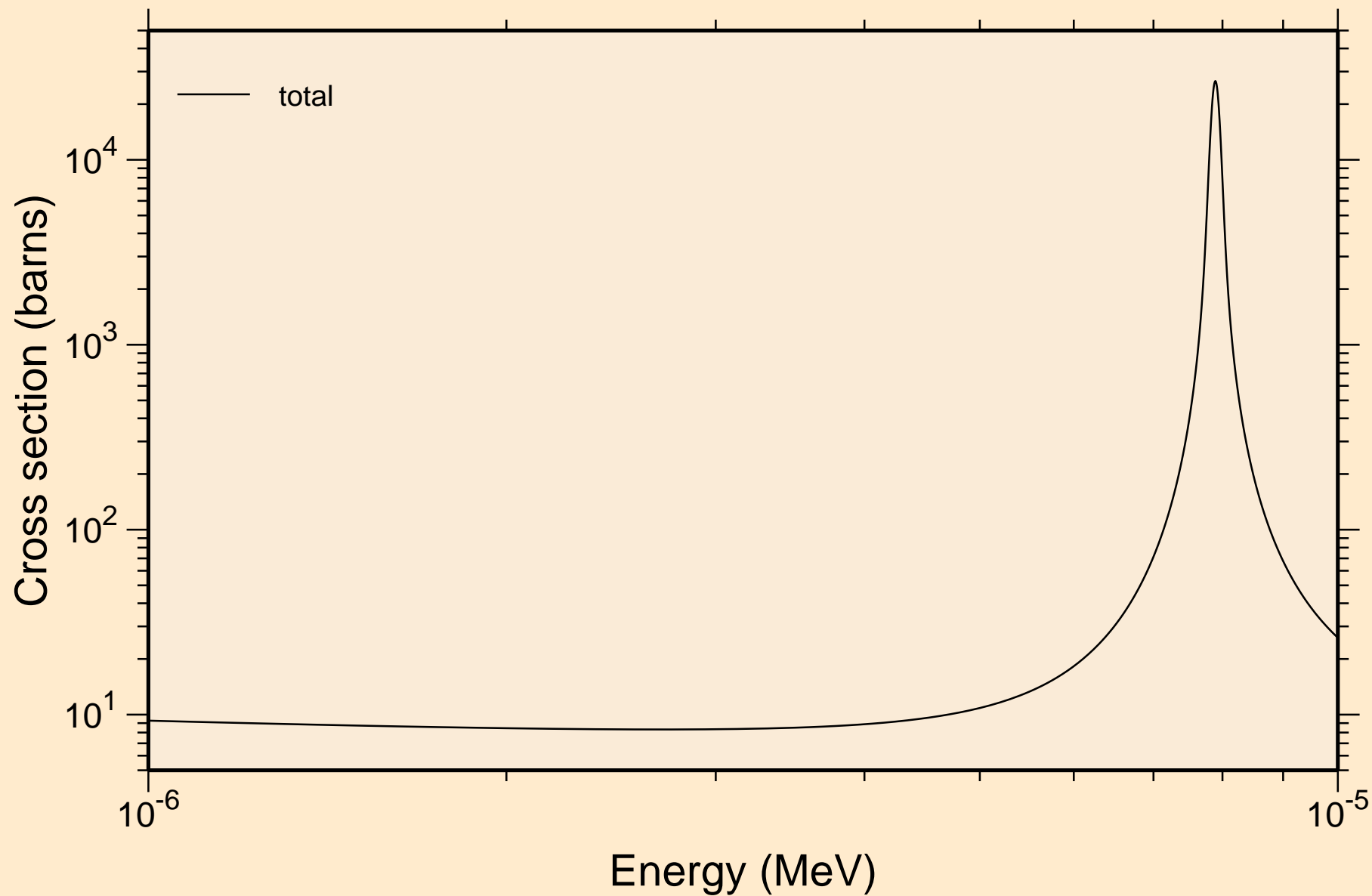

ENDF/B-VII.1 HF-176
resonance total cross section

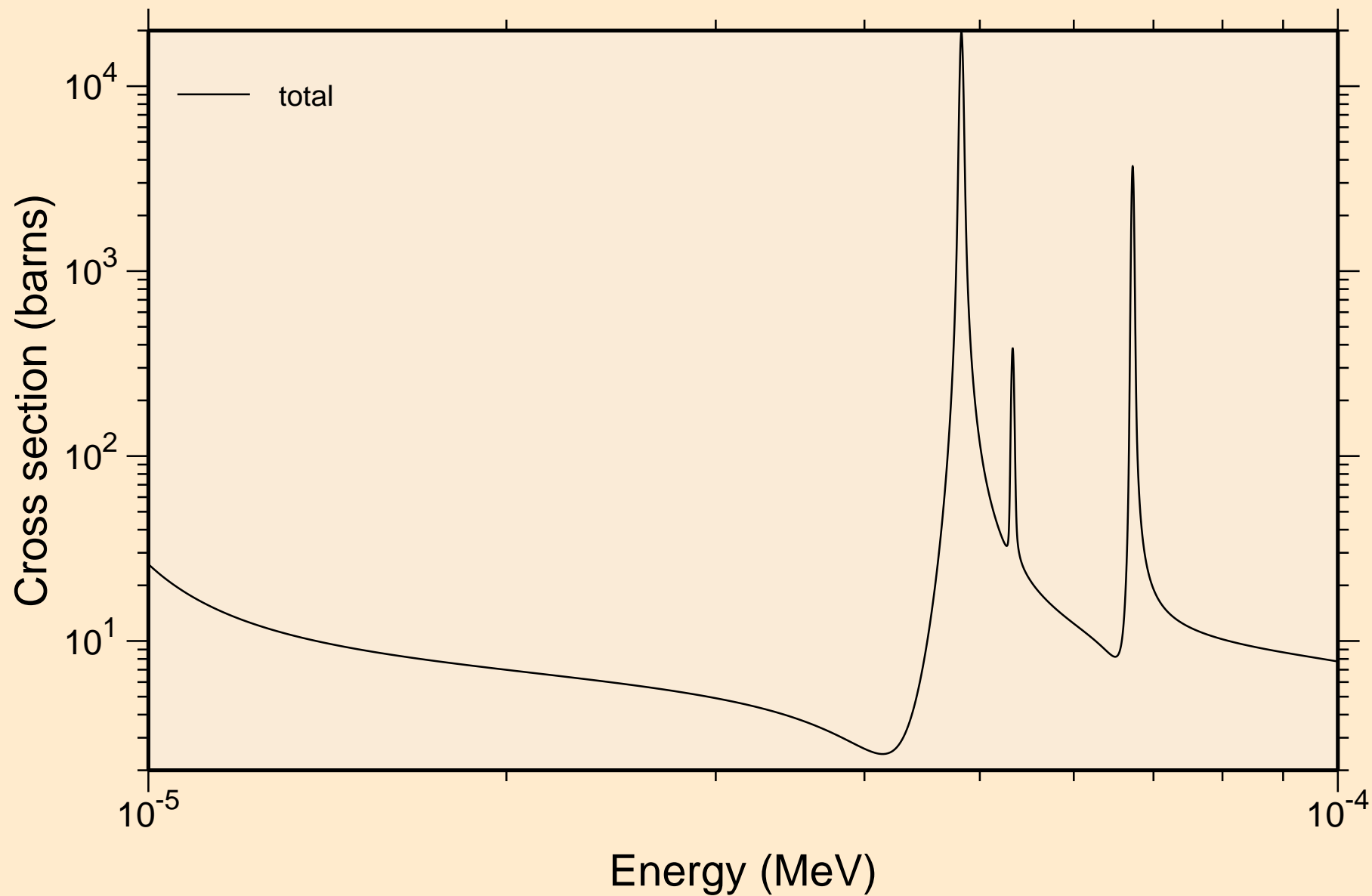

ENDF/B-VII.1 HF-176
resonance total cross section

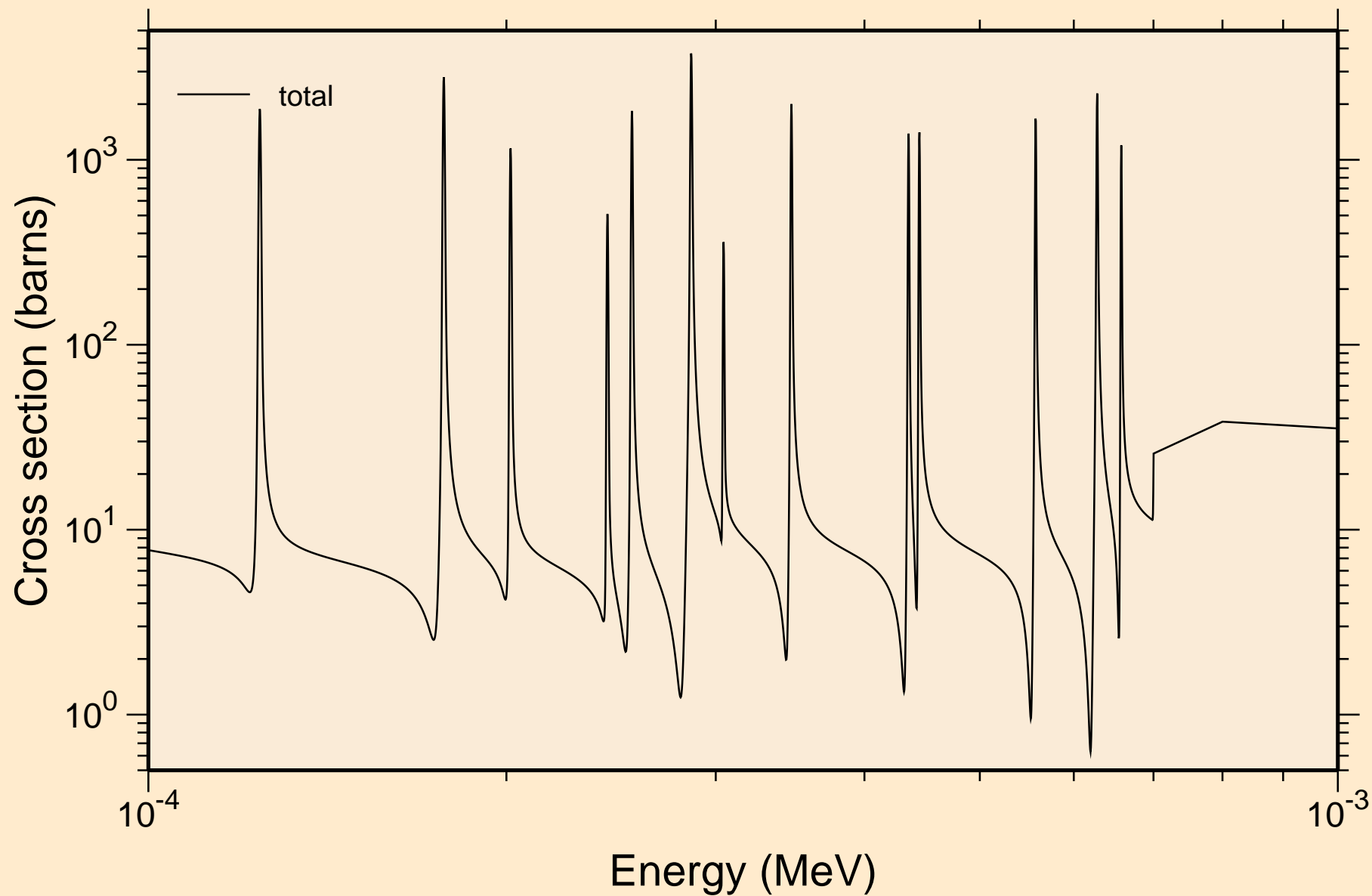

ENDF/B-VII.1 HF-176
resonance total cross section

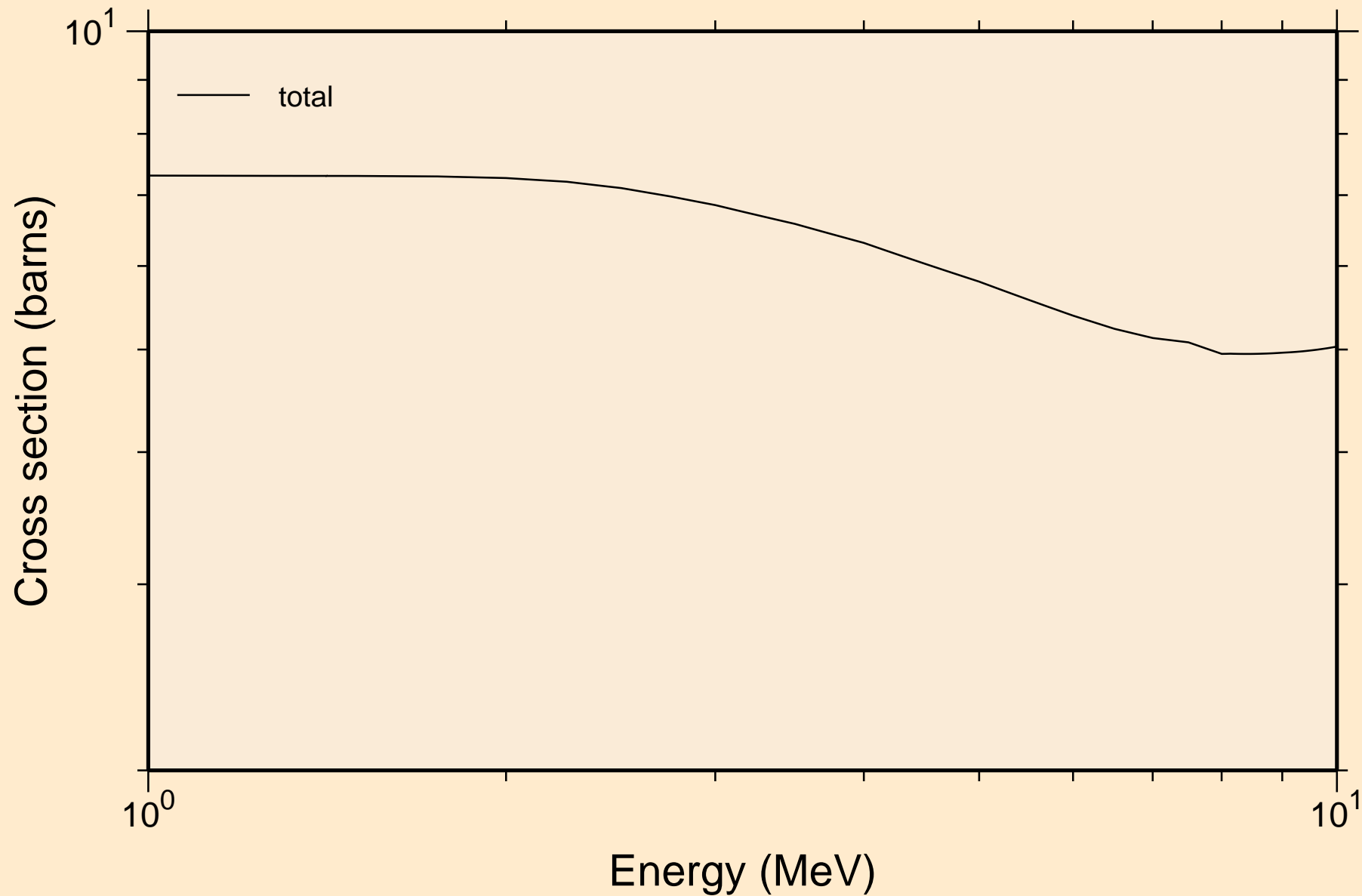

ENDF/B-VII.1 HF-176
resonance absorption cross sections

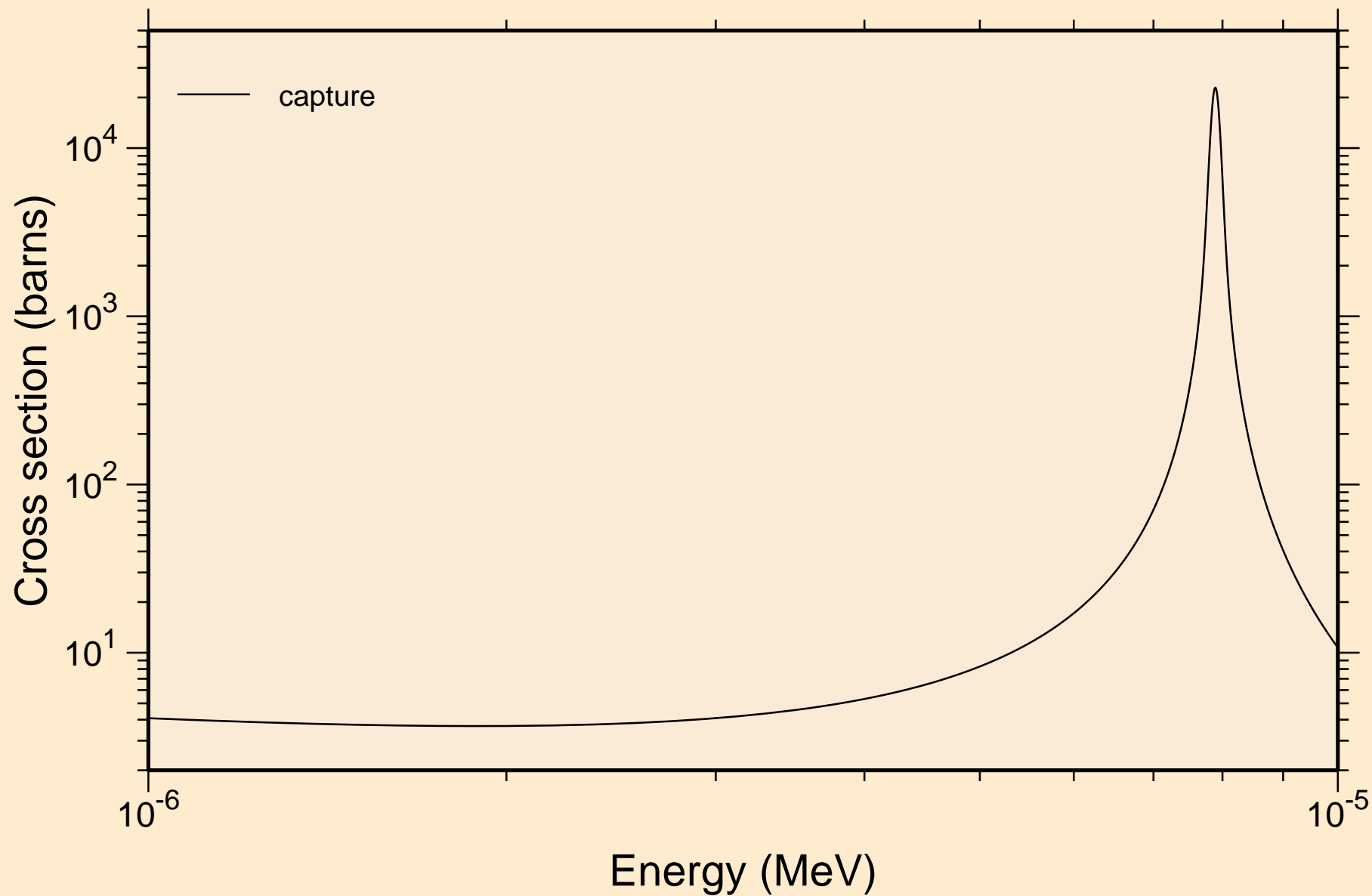

ENDF/B-VII.1 HF-176
resonance absorption cross sections

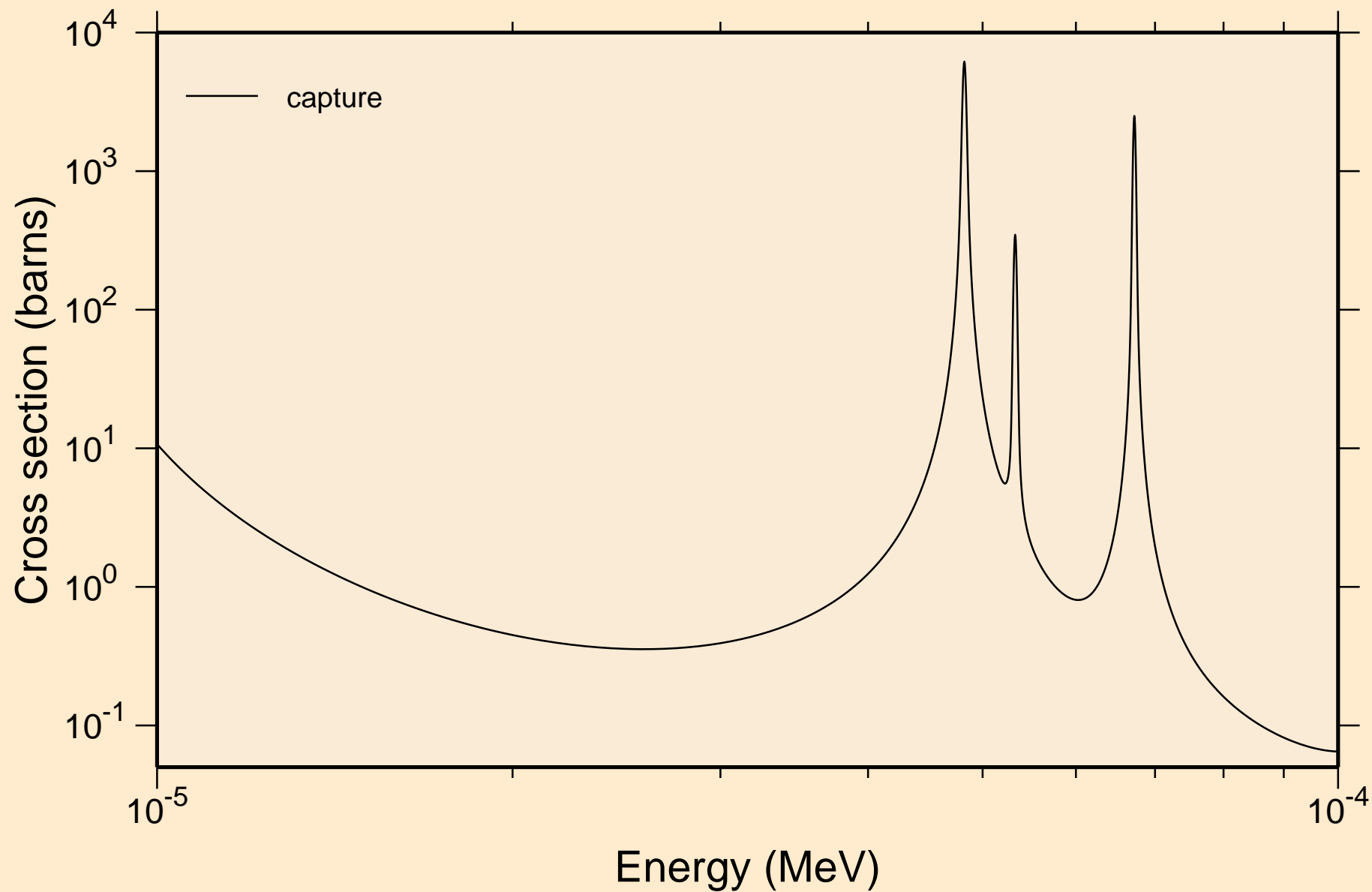

ENDF/B-VII.1 HF-176
resonance absorption cross sections

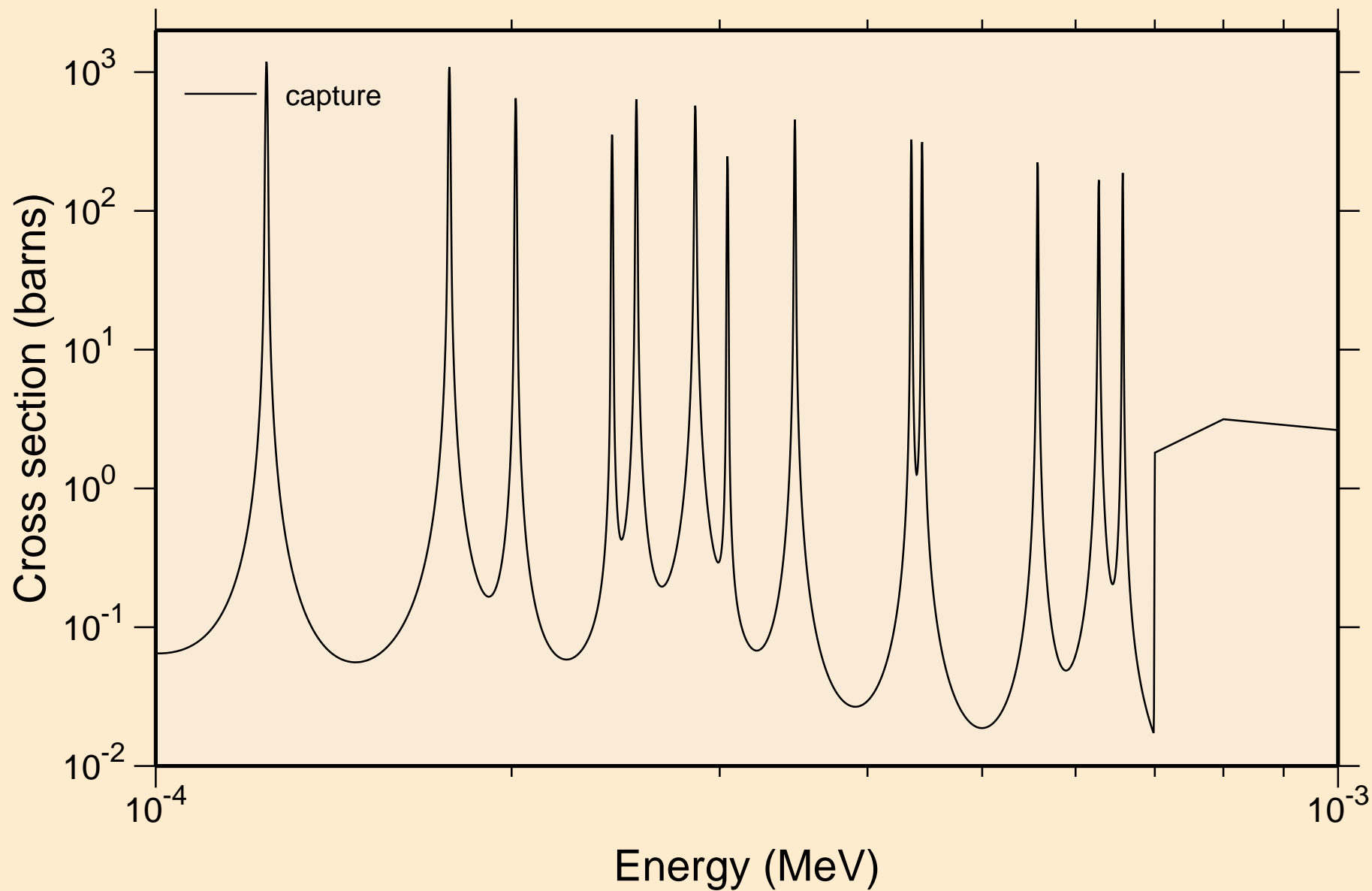

ENDF/B-VII.1 HF-176
resonance absorption cross sections

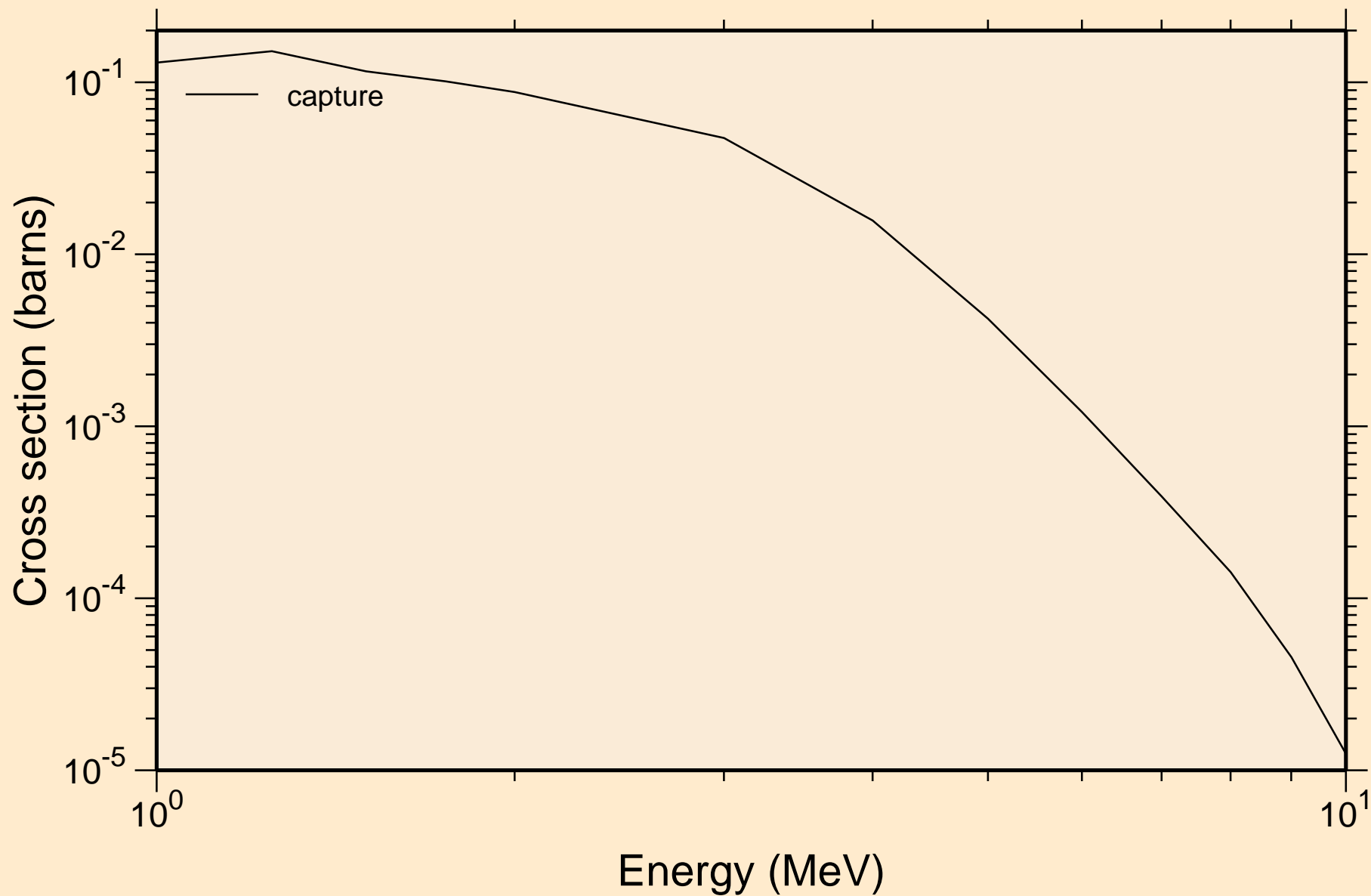

ENDF/B-VII.1 HF-176

UR total cross section

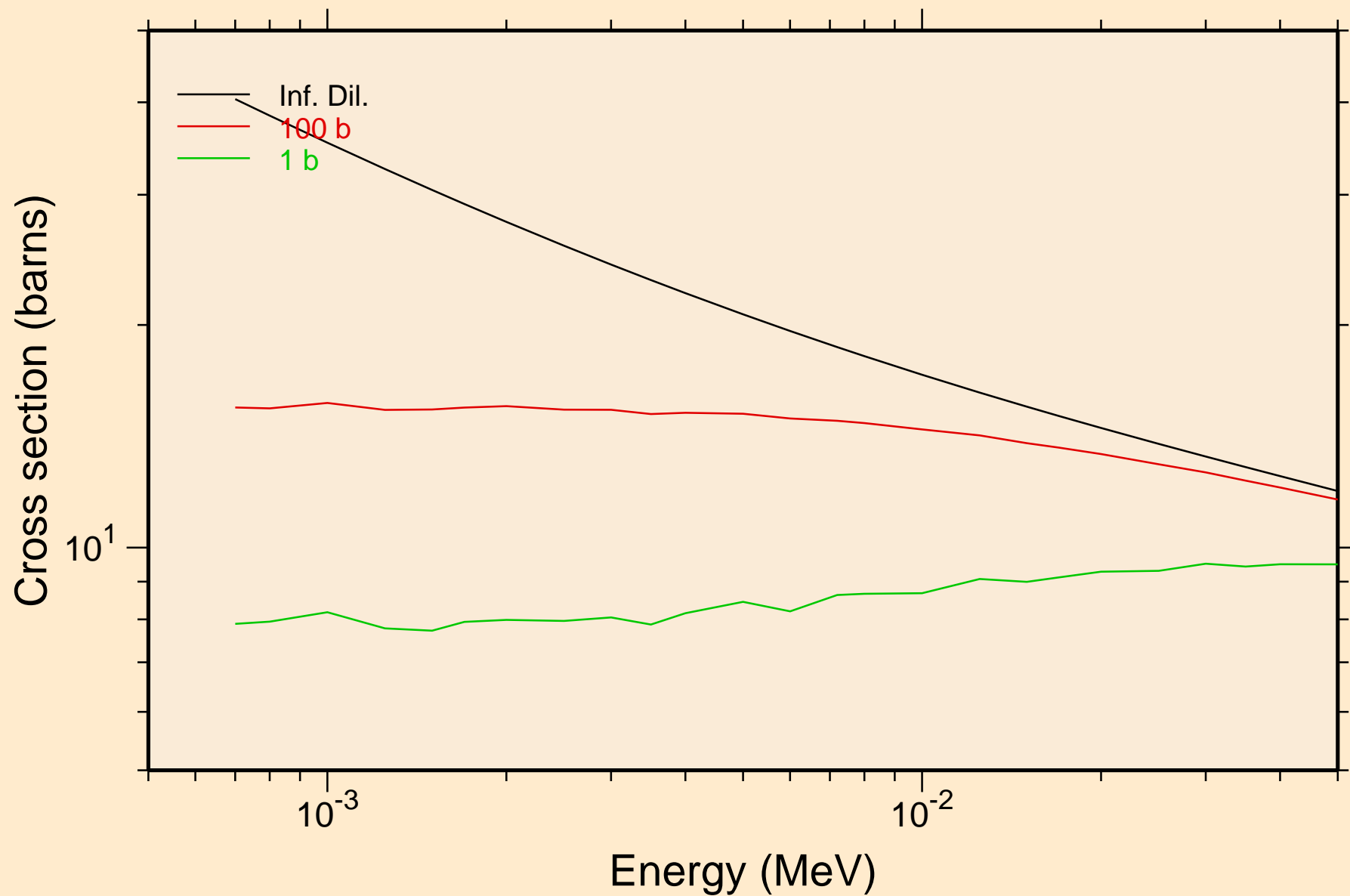

ENDF/B-VII.1 HF-176

UR elastic cross section

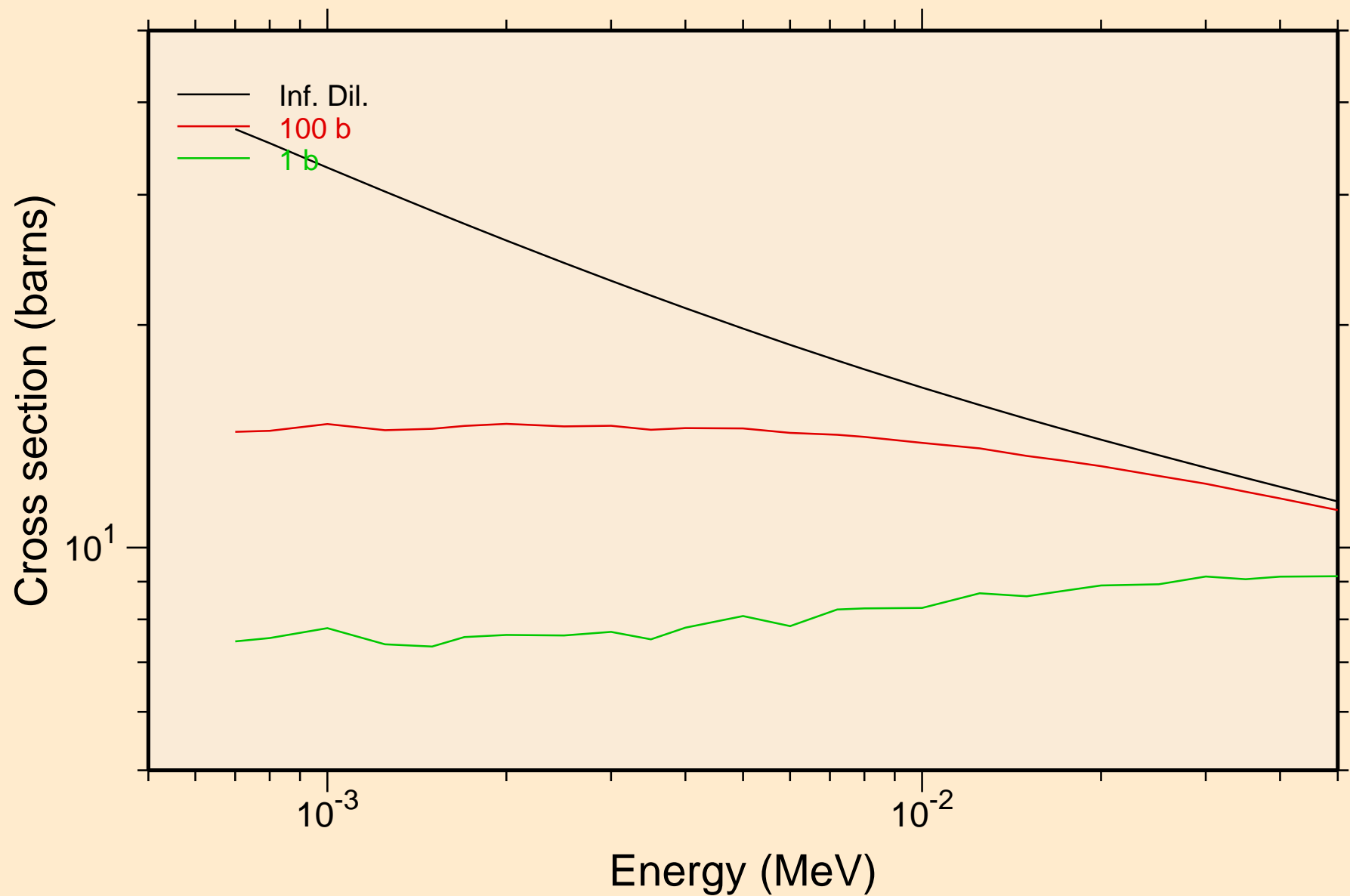

ENDF/B-VII.1 HF-176
UR capture cross section

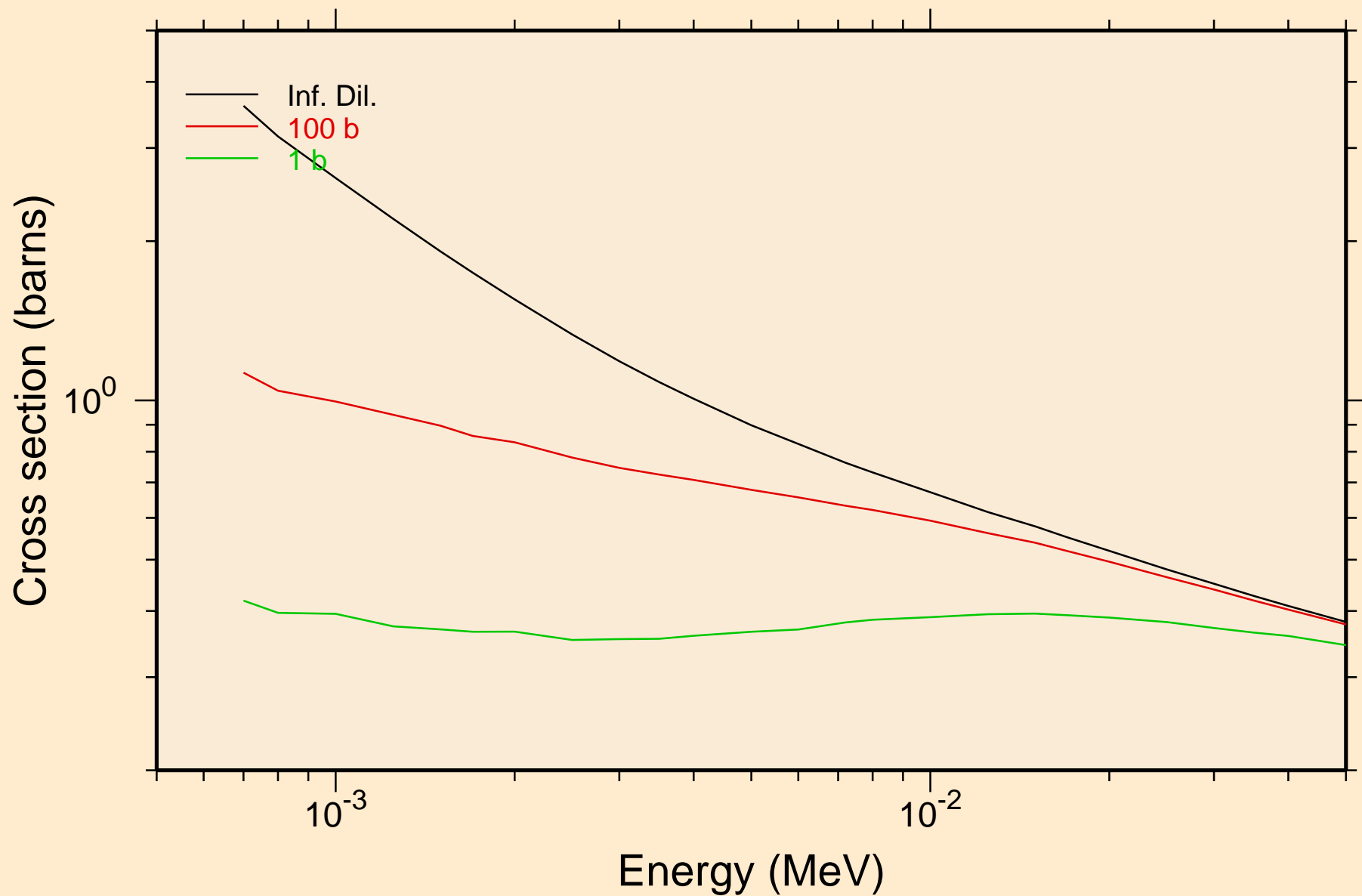

ENDF/B-VII.1 HF-176

Heating

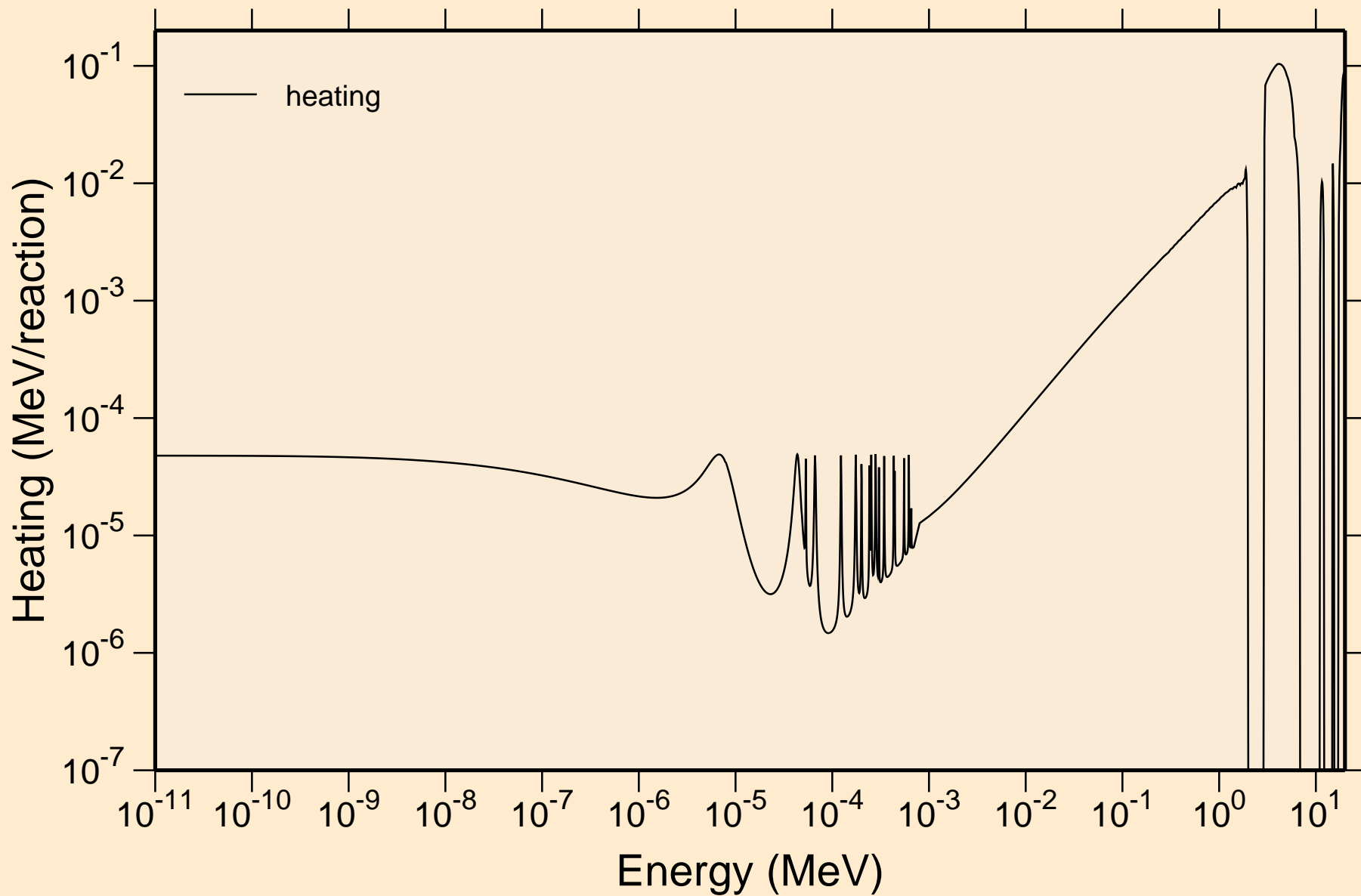

ENDF/B-VII.1 HF-176

Damage

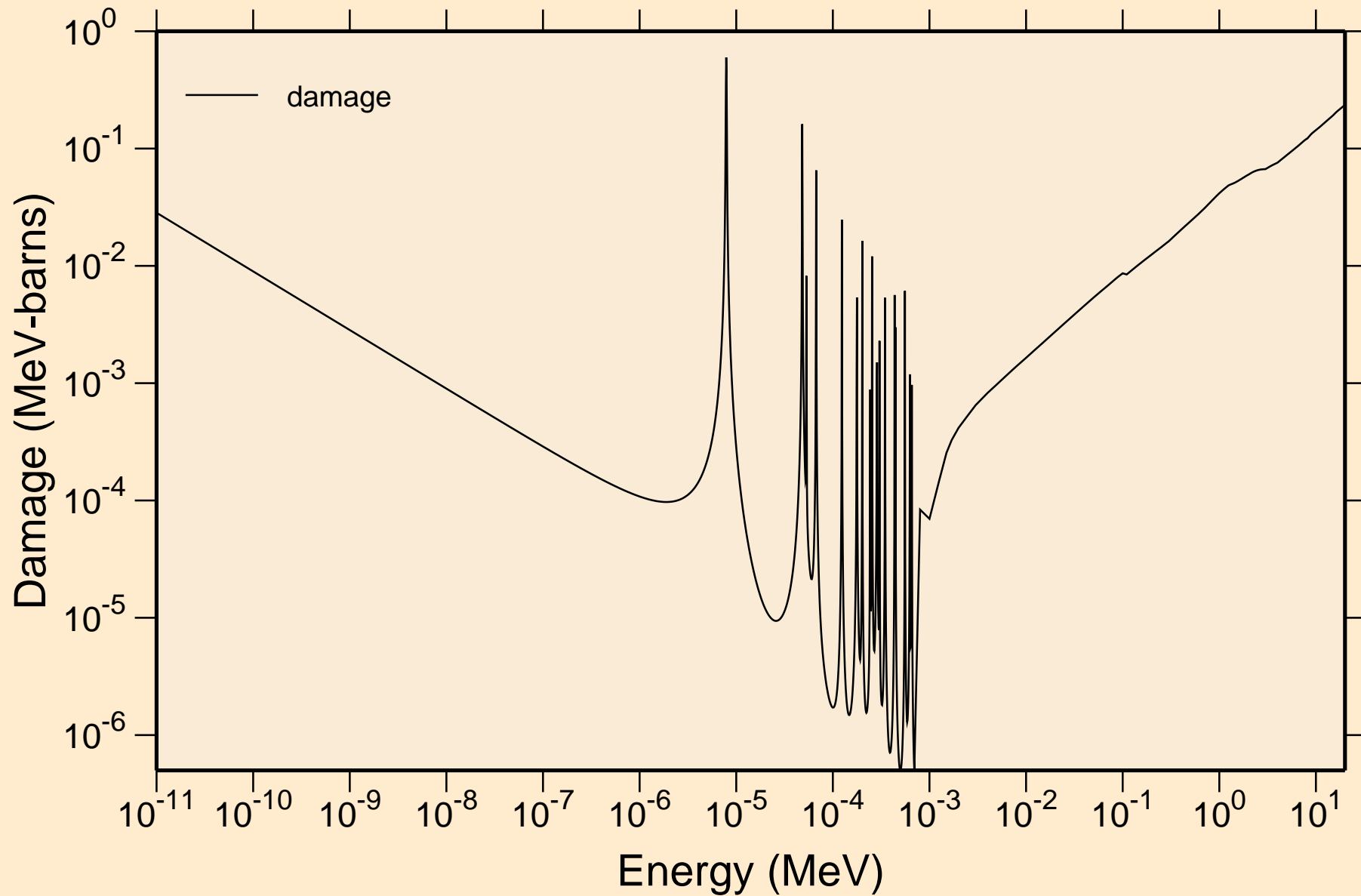

ENDF/B-VII.1 HF-176
Non-threshold reactions

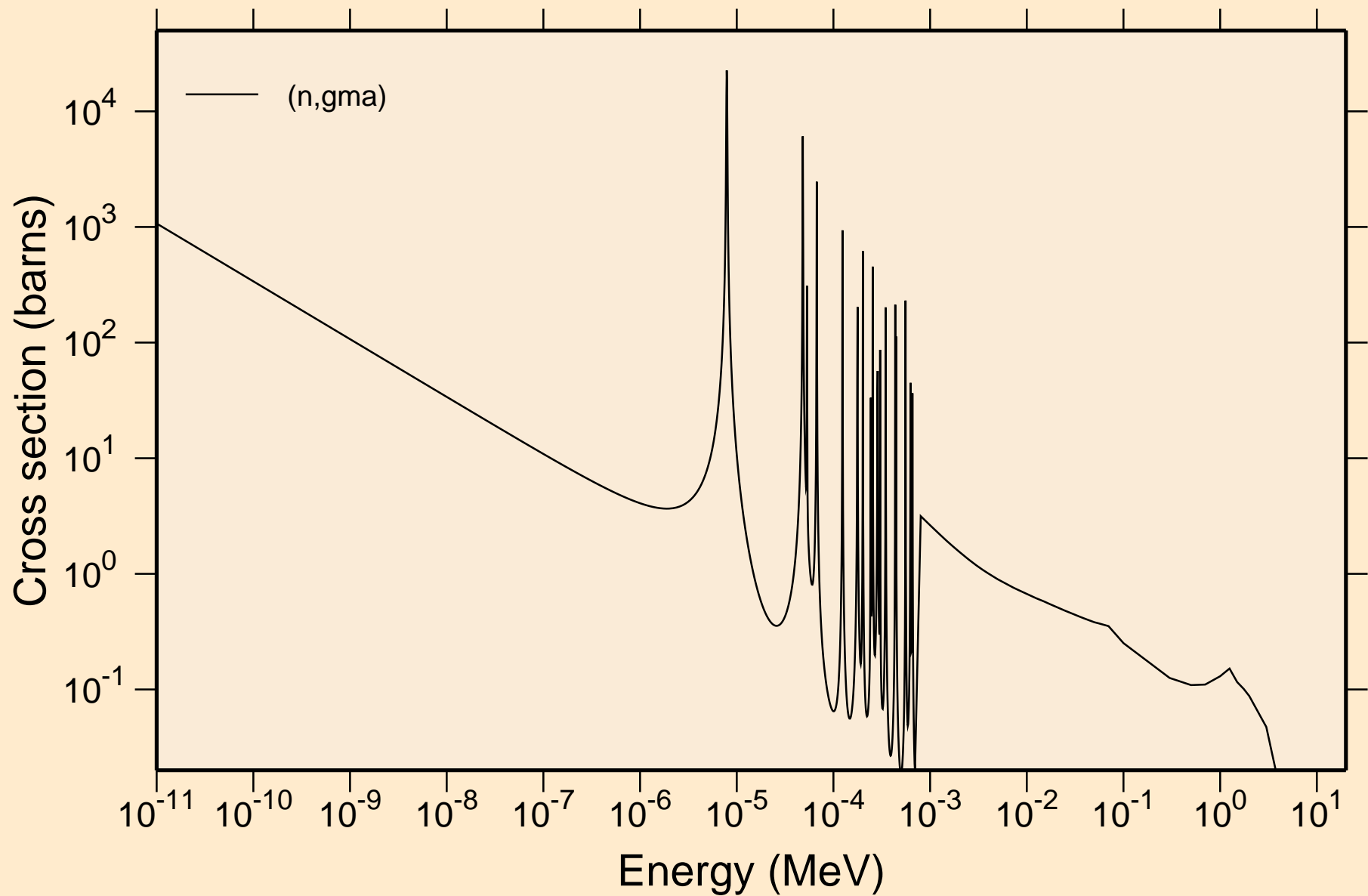

ENDF/B-VII.1 HF-176

Principal cross sections

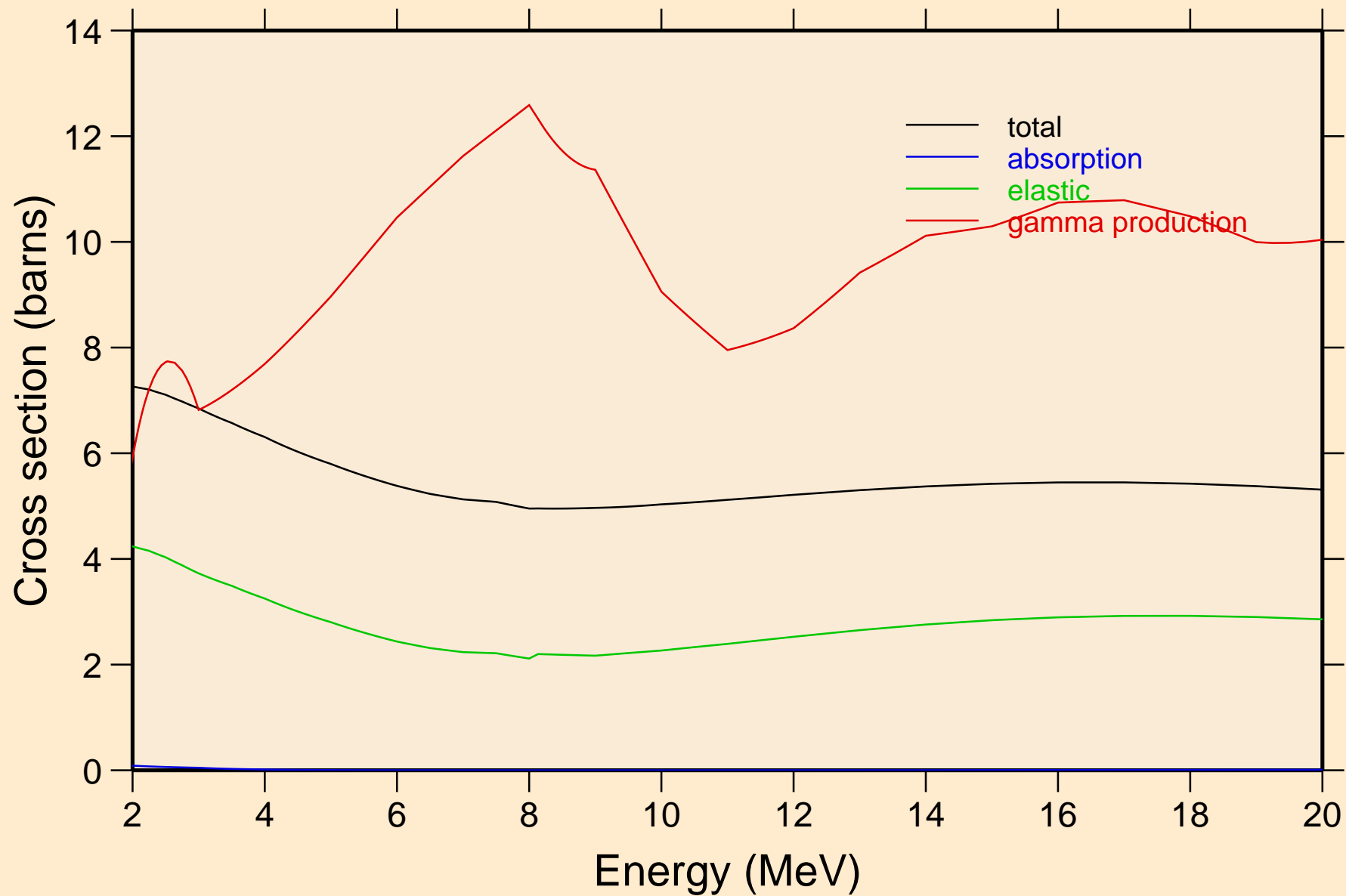

ENDF/B-VII.1 HF-176

Heating

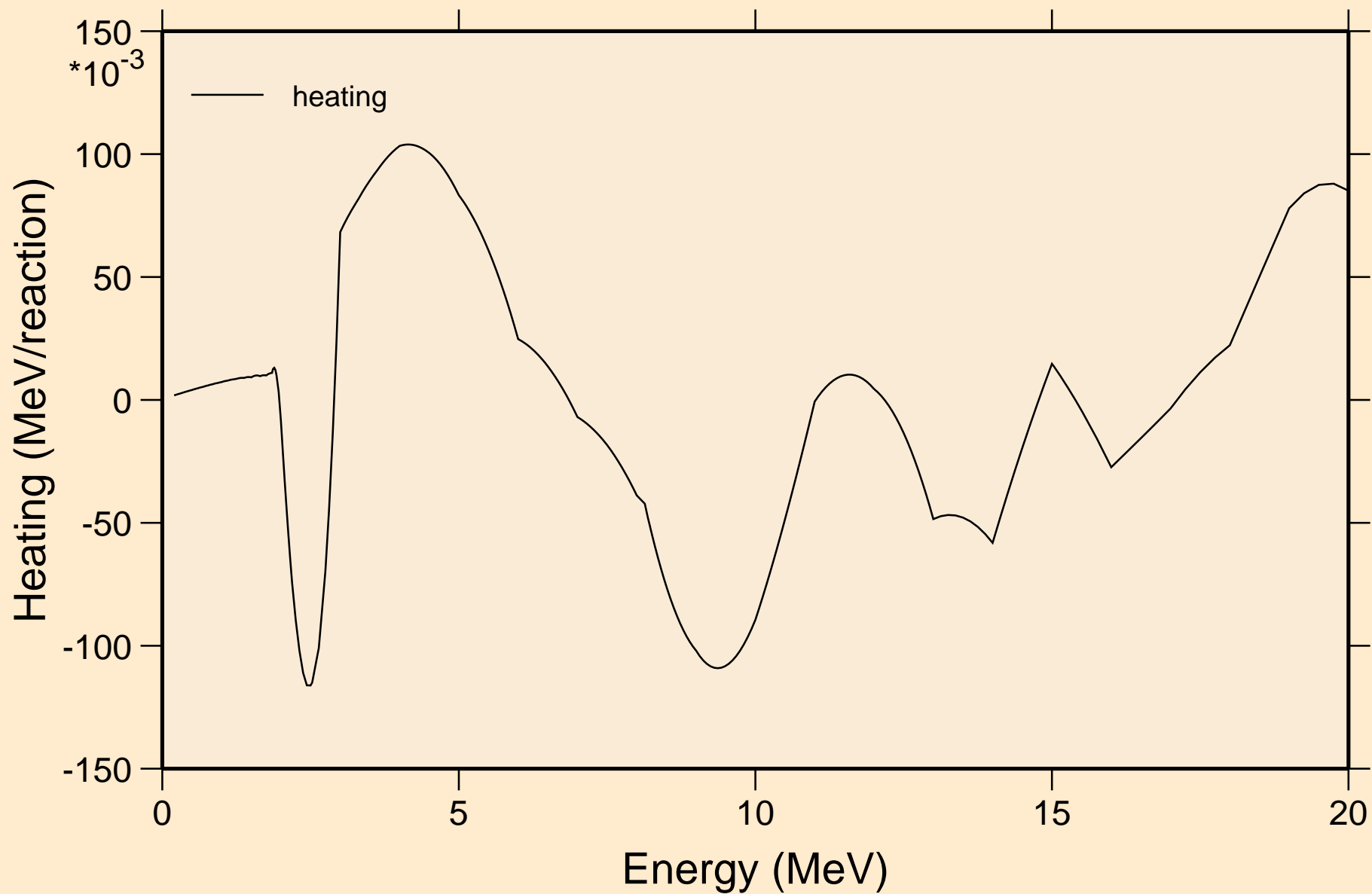

ENDF/B-VII.1 HF-176

Damage

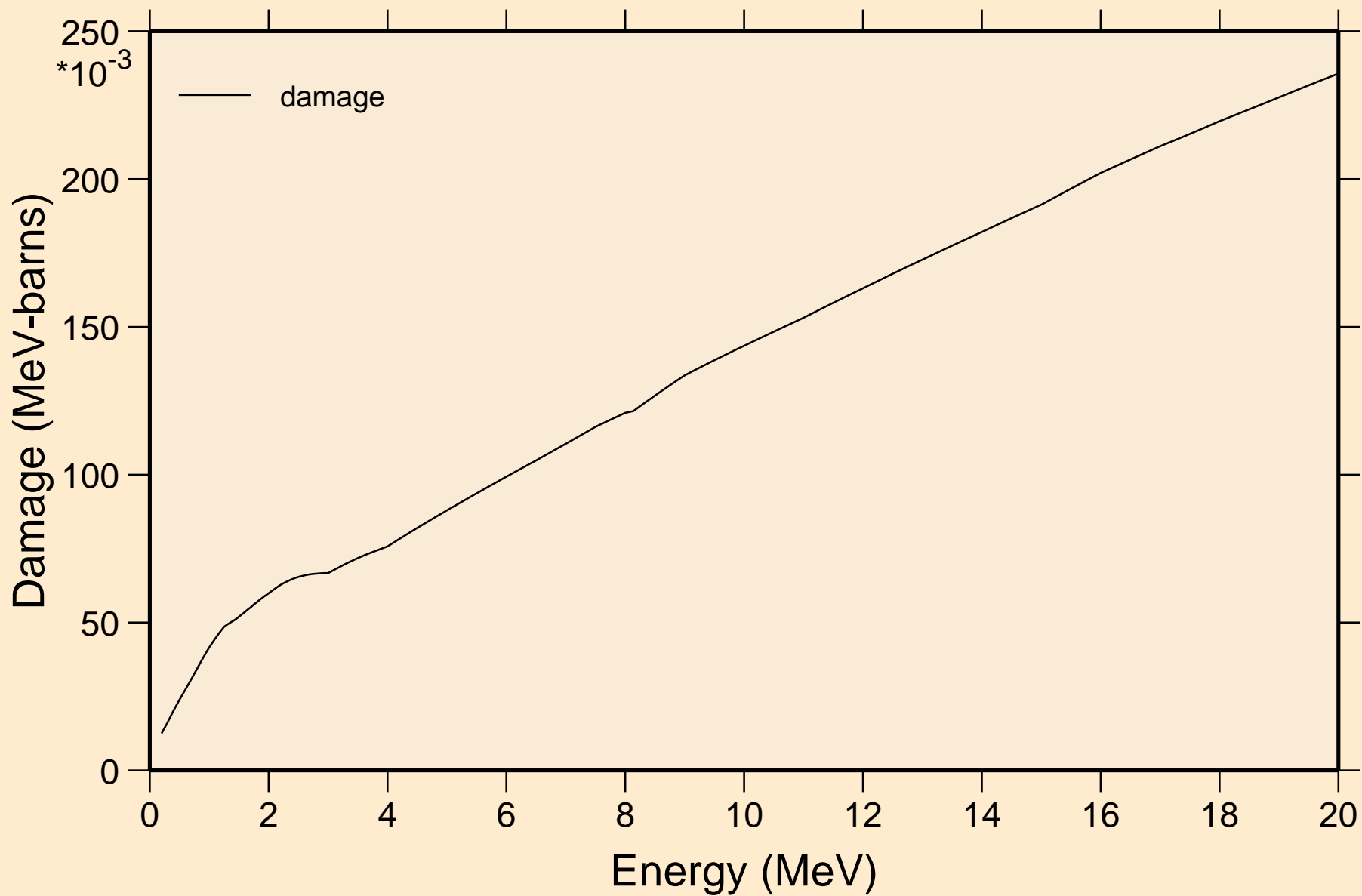

ENDF/B-VII.1 HF-176
Non-threshold reactions

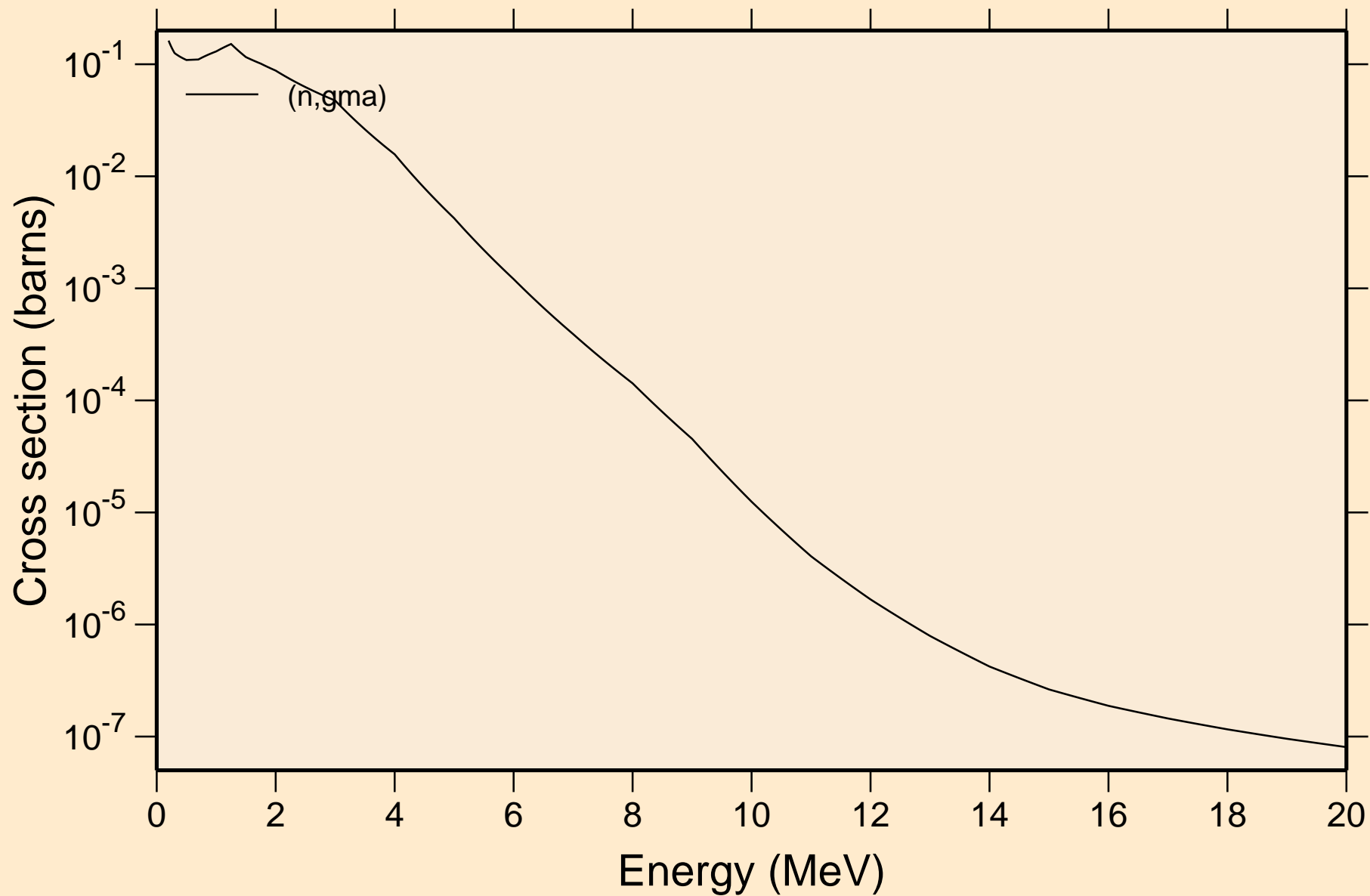

ENDF/B-VII.1 HF-176

Inelastic levels

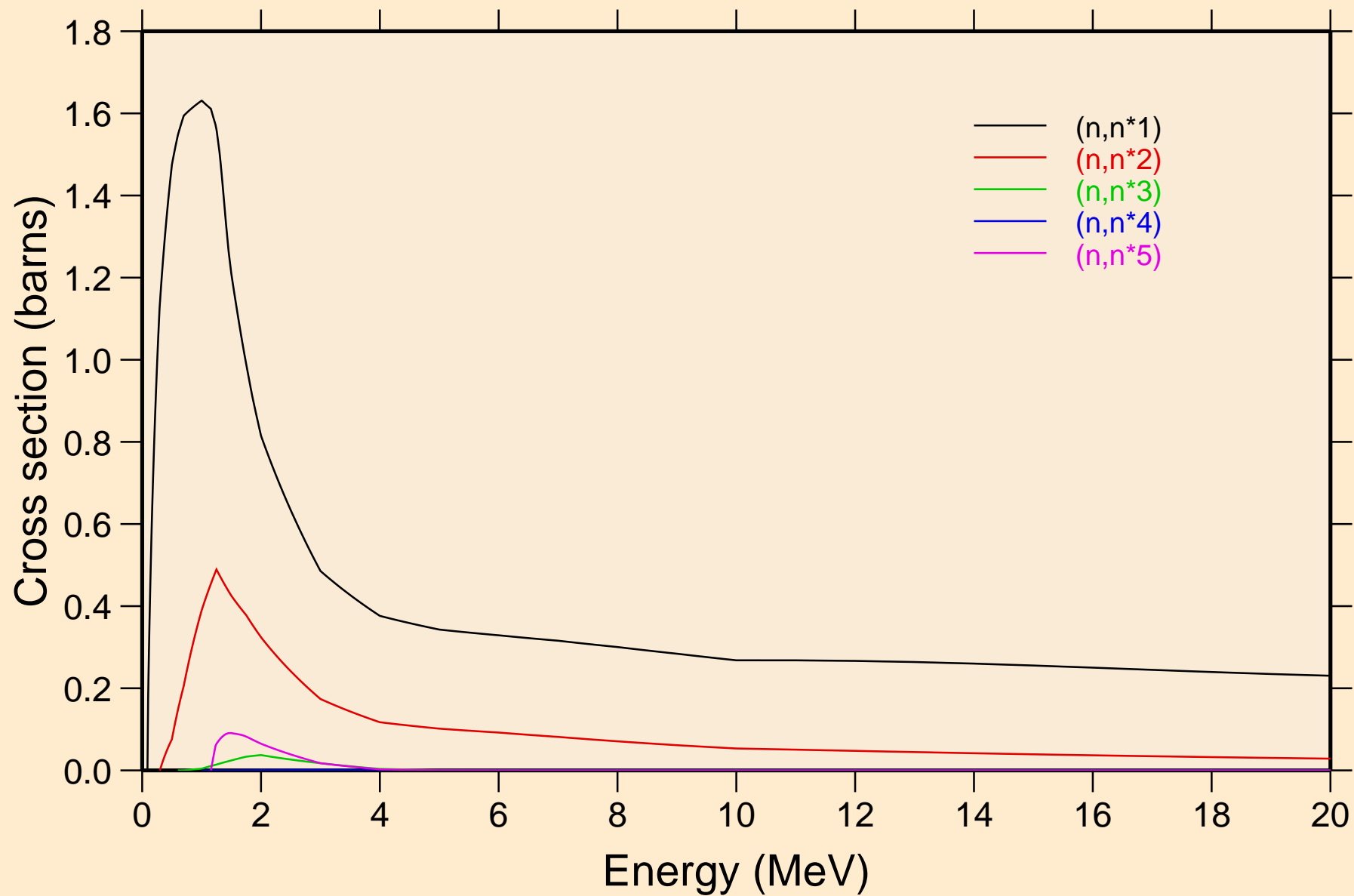

ENDF/B-VII.1 HF-176

Inelastic levels

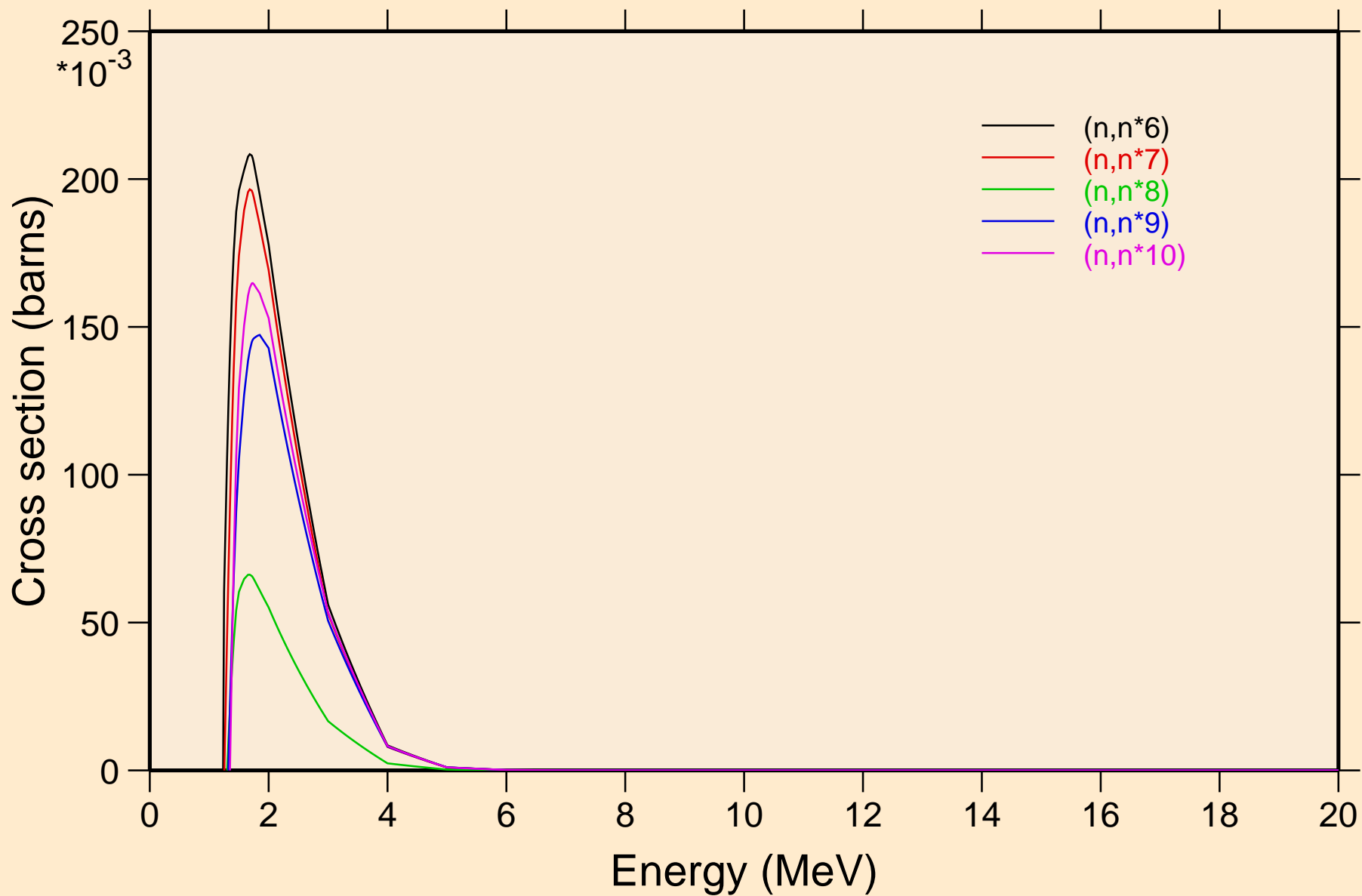

ENDF/B-VII.1 HF-176

Inelastic levels

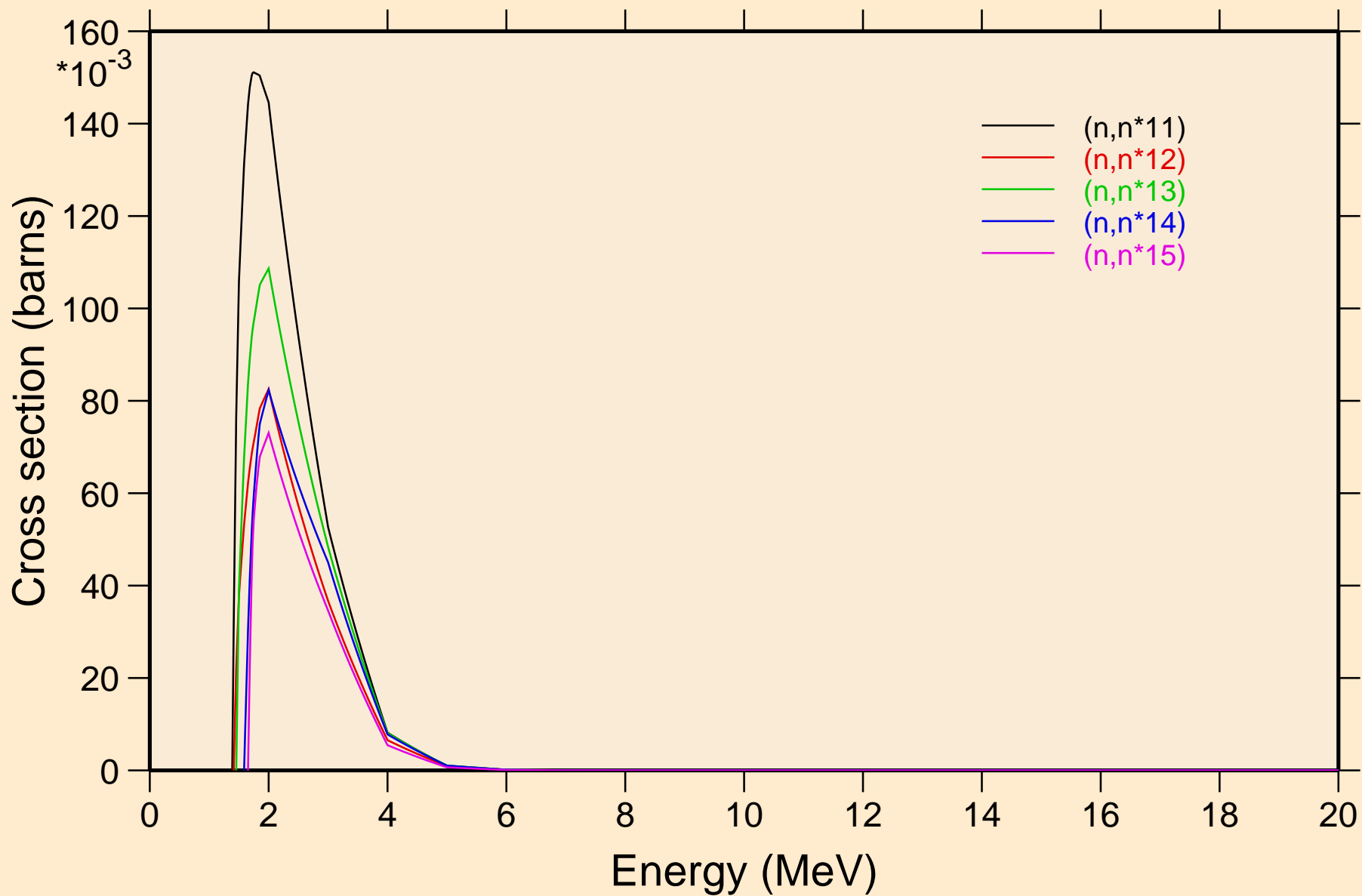

ENDF/B-VII.1 HF-176

Inelastic levels

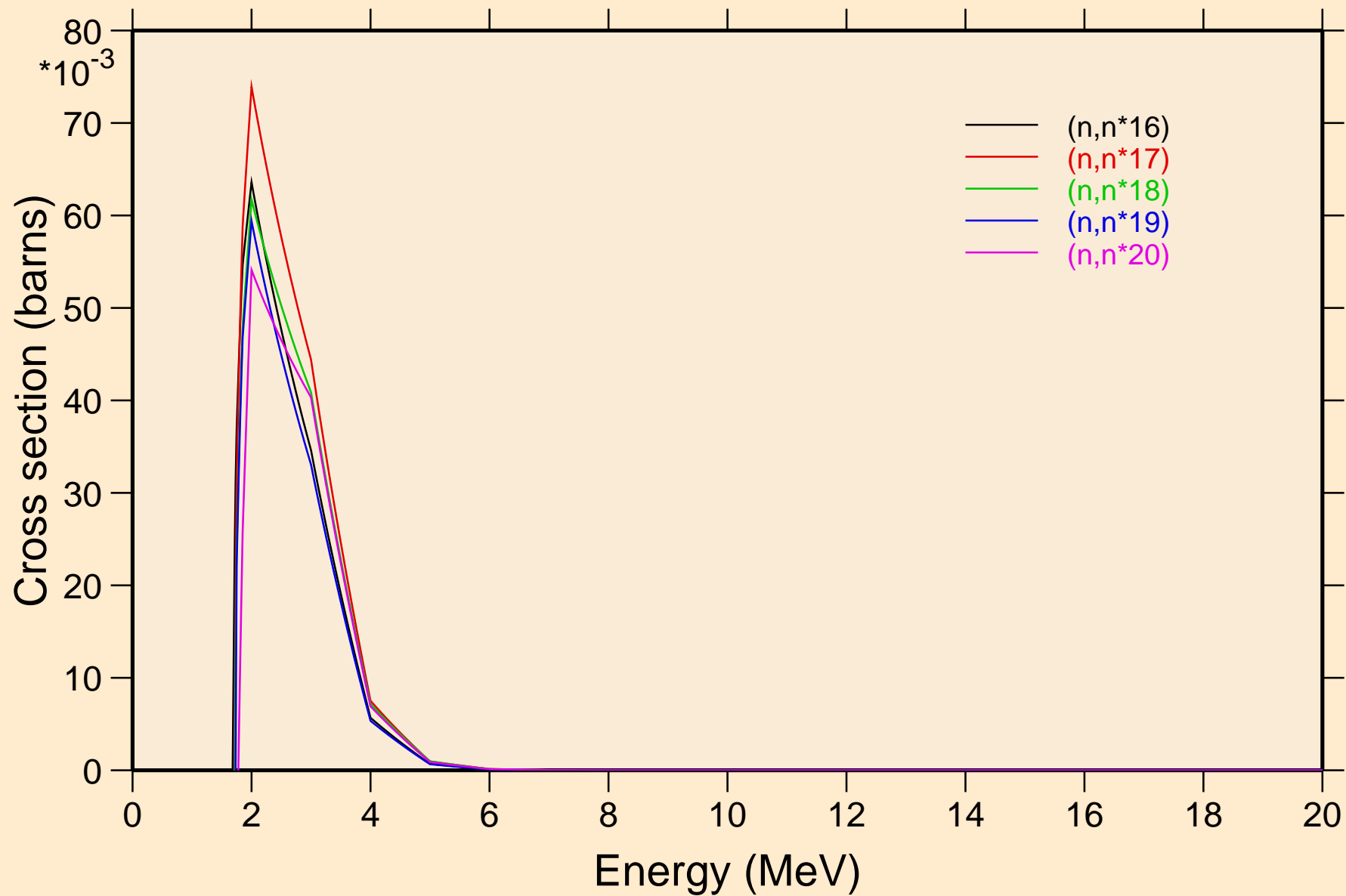

ENDF/B-VII.1 HF-176

Inelastic levels

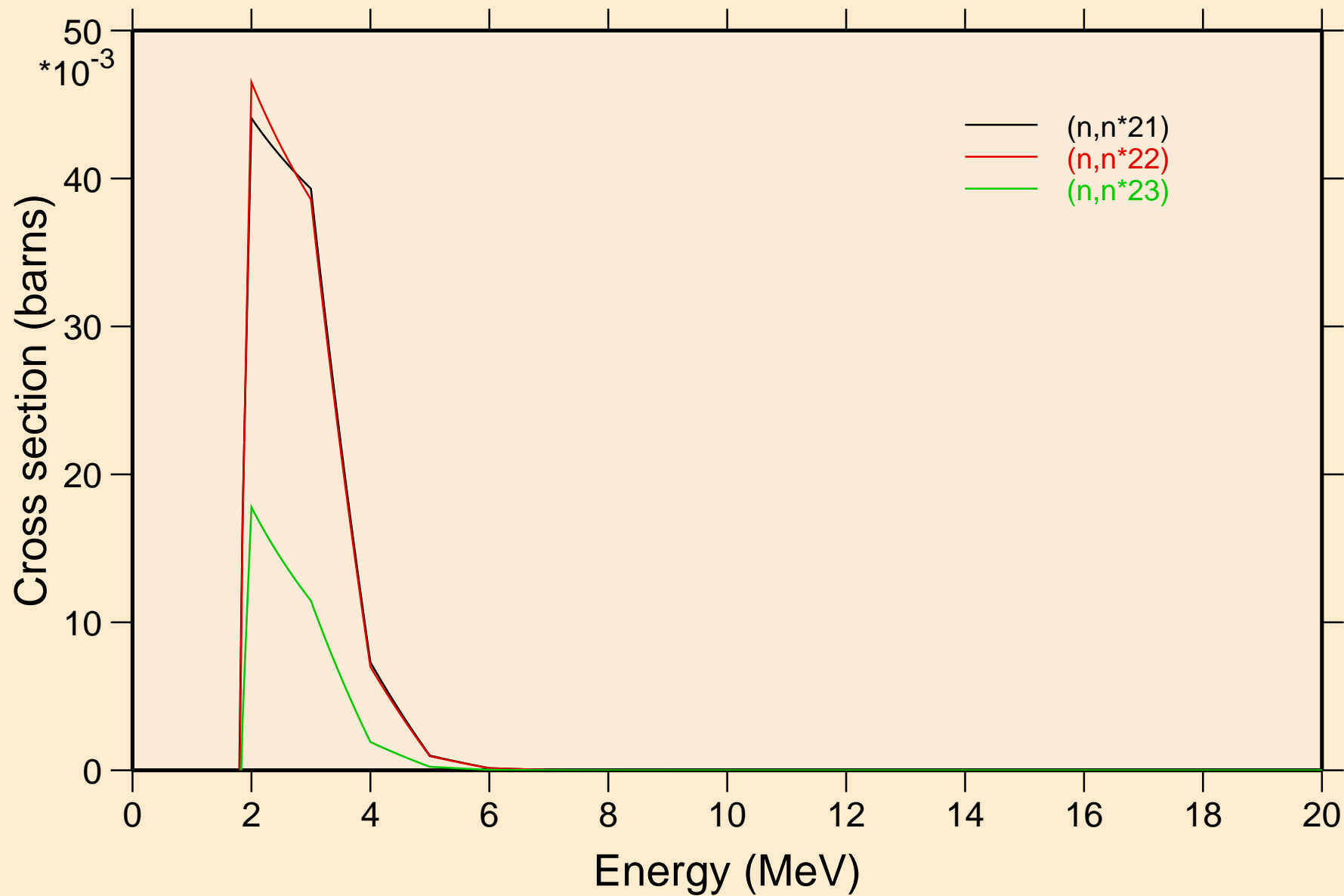

ENDF/B-VII.1 HF-176

Threshold reactions

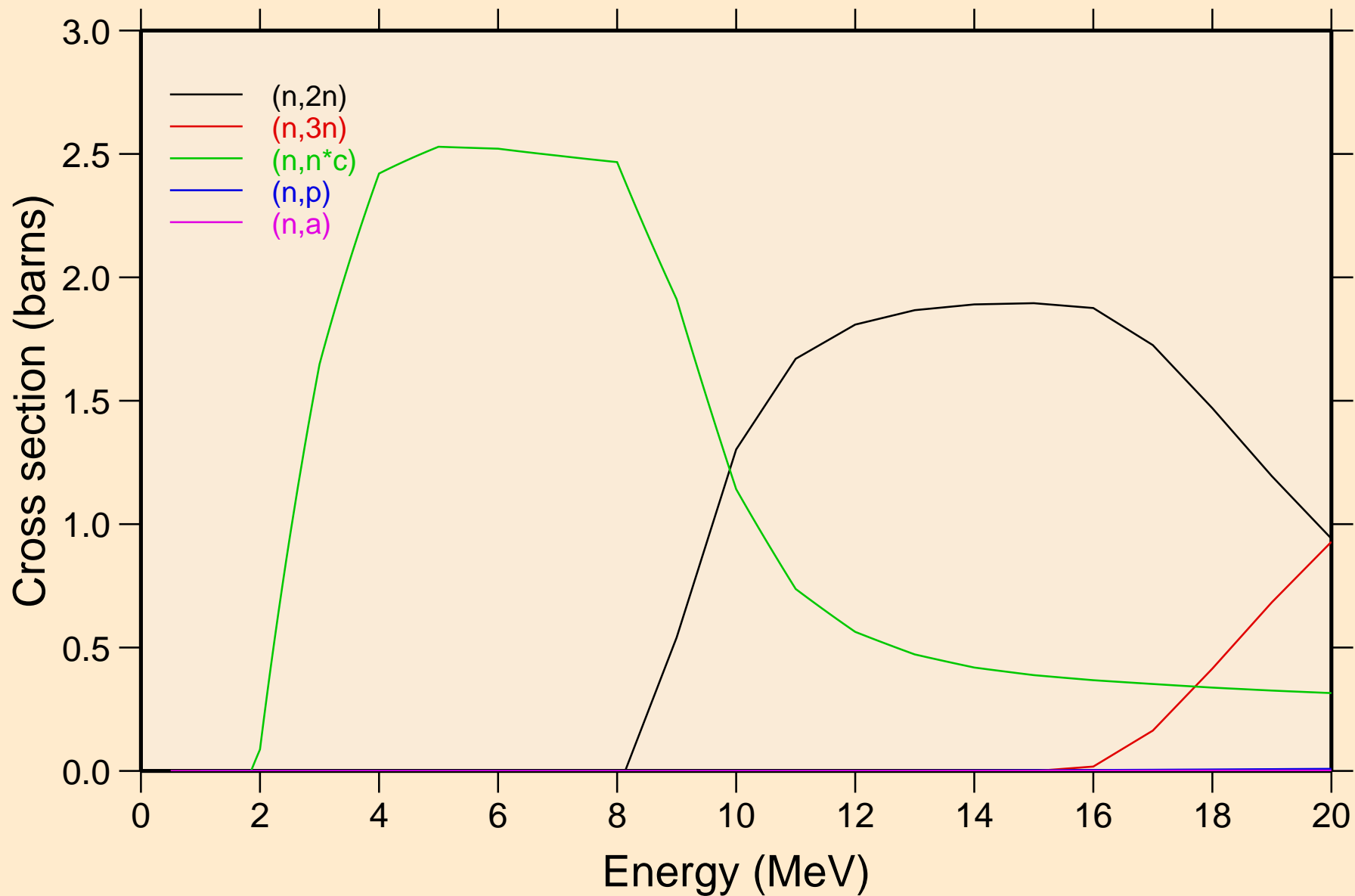

ENDF/B-VII.1 HF-176

Threshold reactions

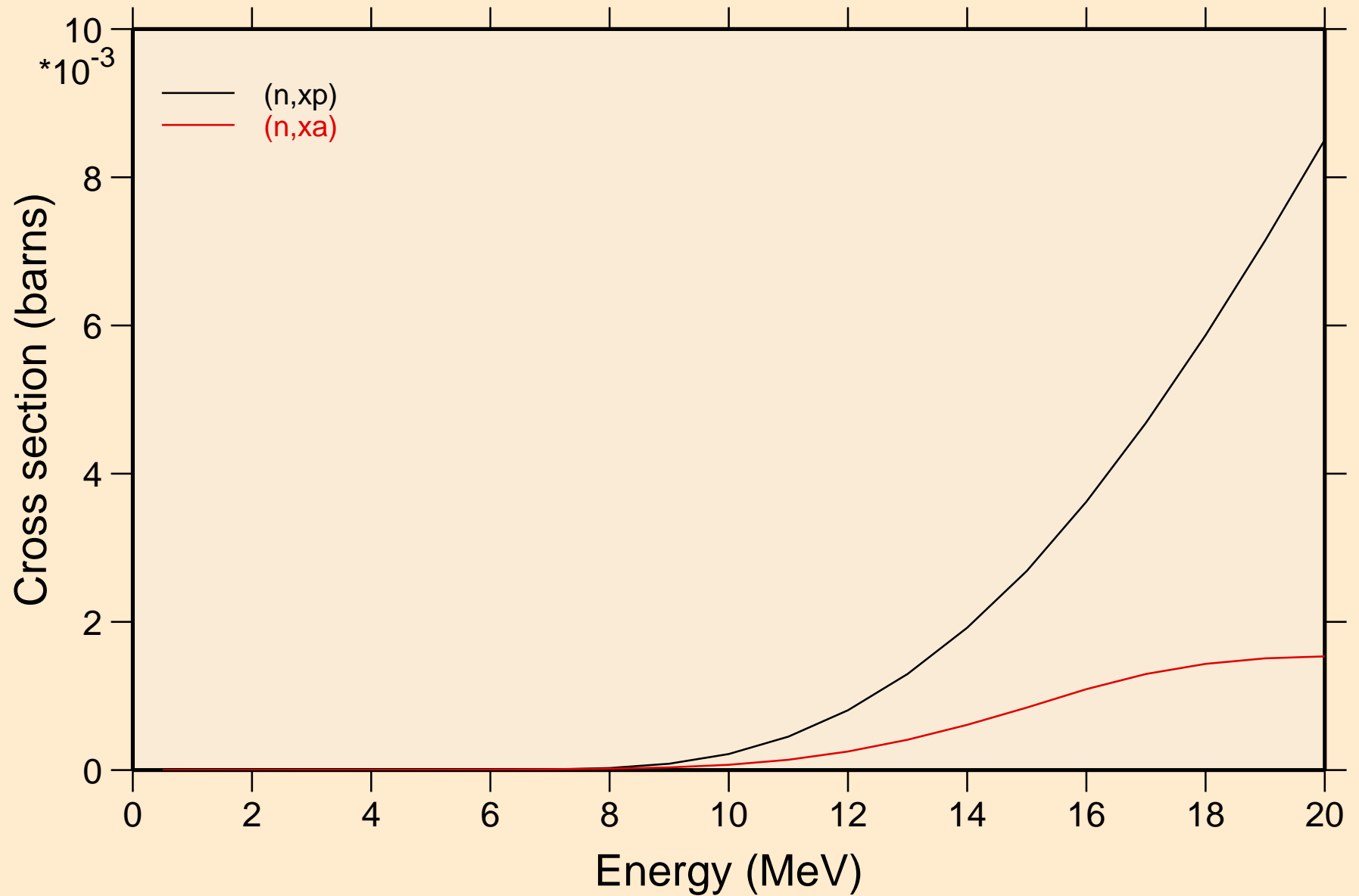

ENDF/B-VII.1 HF-176
angular distribution for elastic

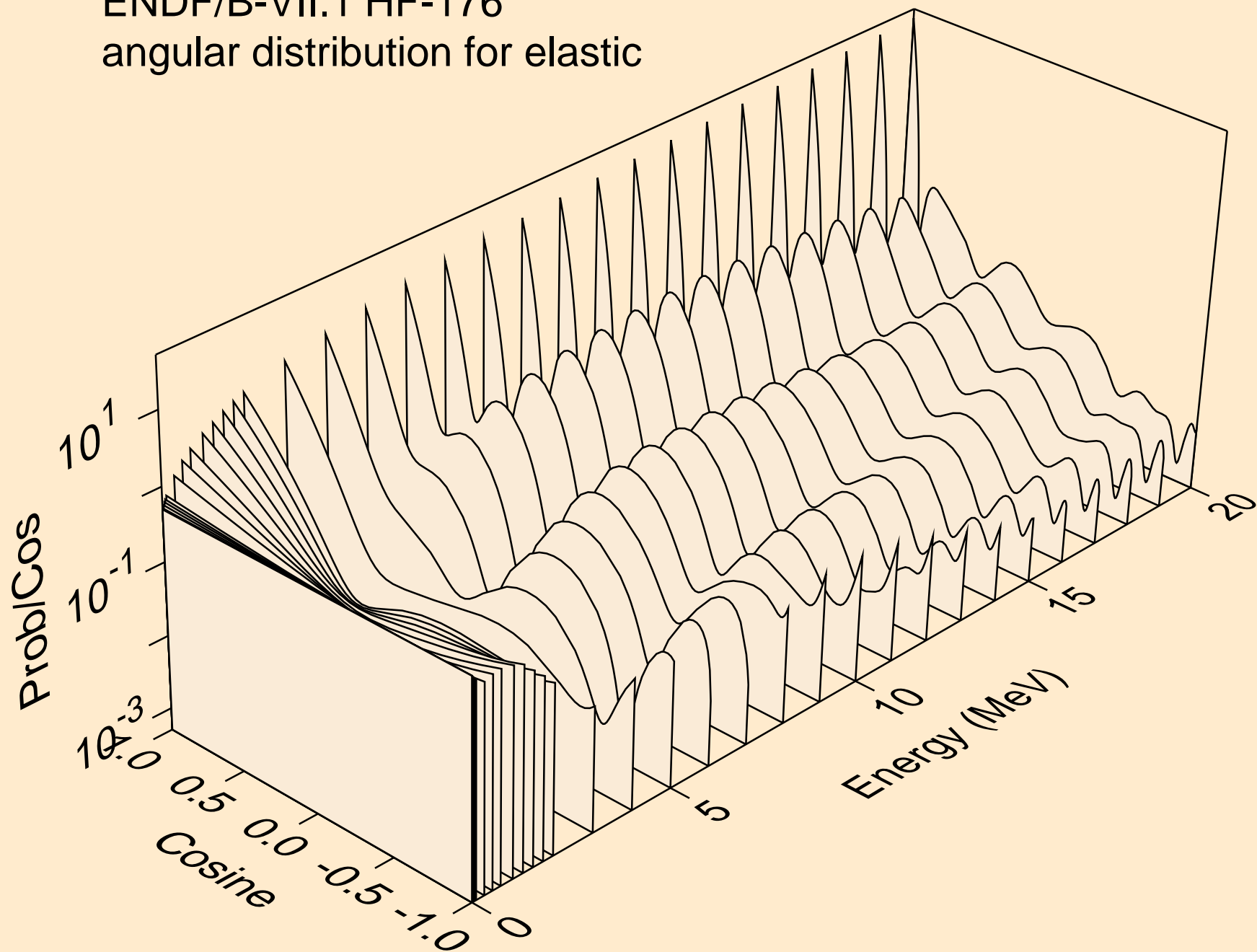

ENDF/B-VII.1 HF-176
angular distribution for (n,n*1)

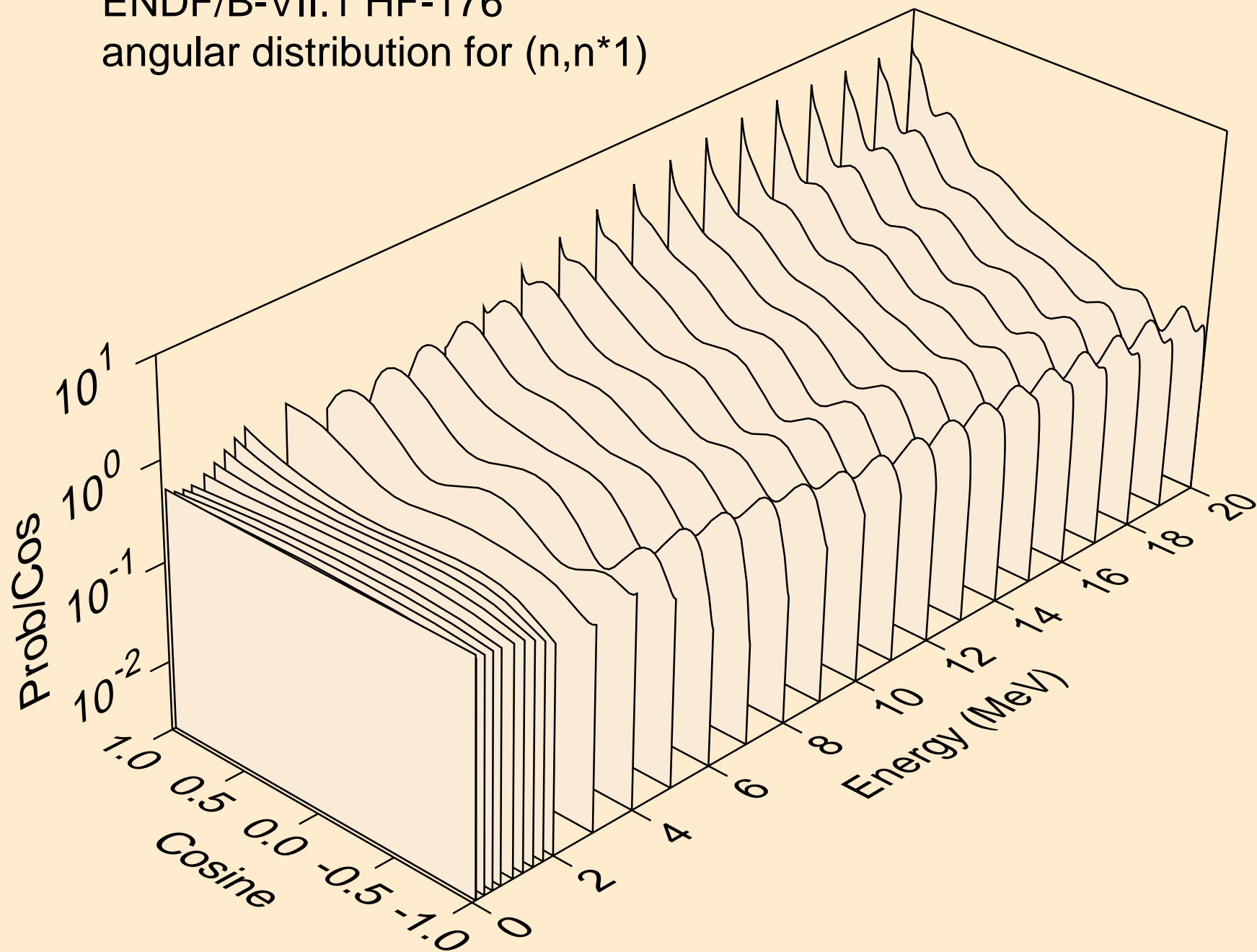

ENDF/B-VII.1 HF-176
angular distribution for (n,n*2)

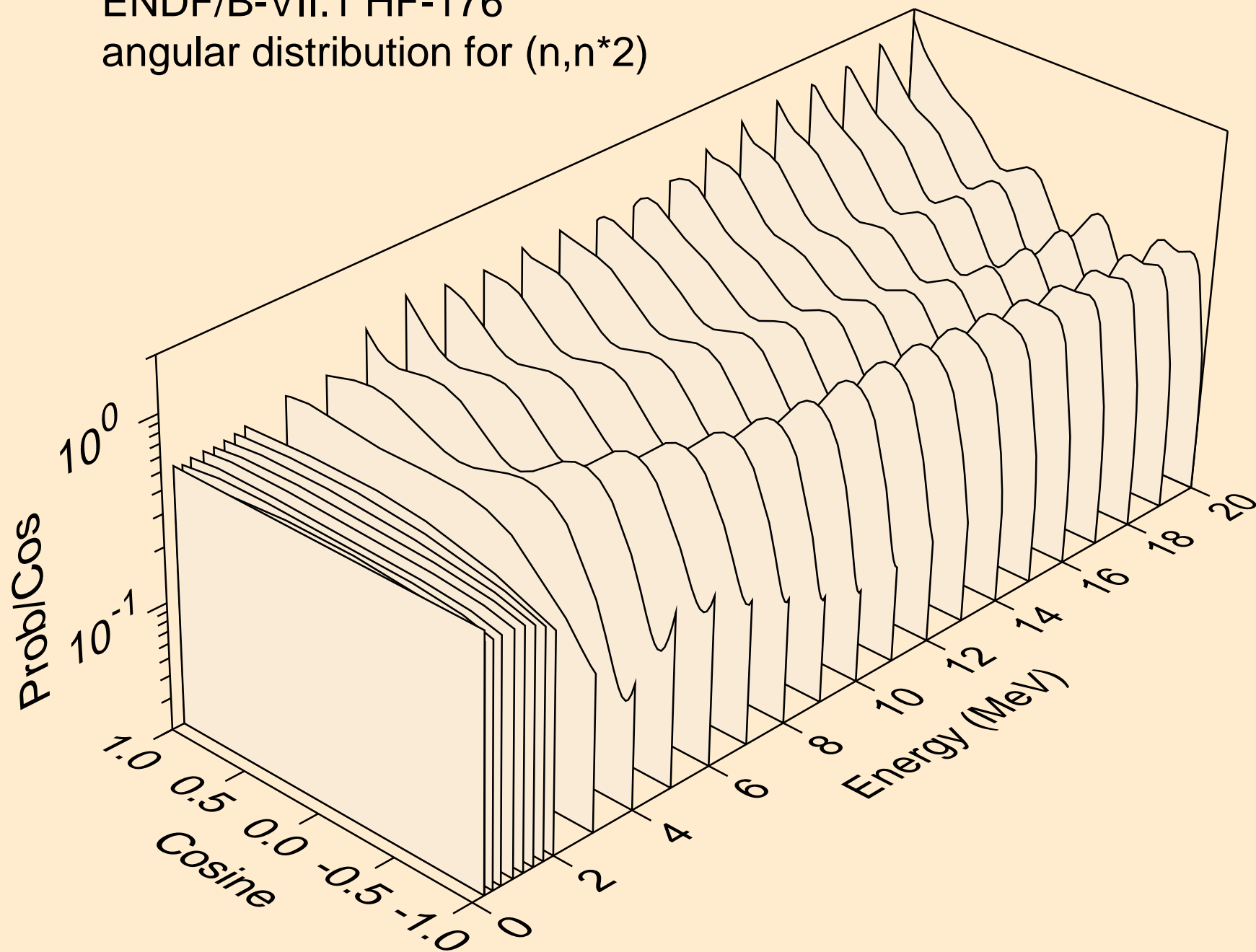

ENDF/B-VII.1 HF-176
angular distribution for (n,n*3)

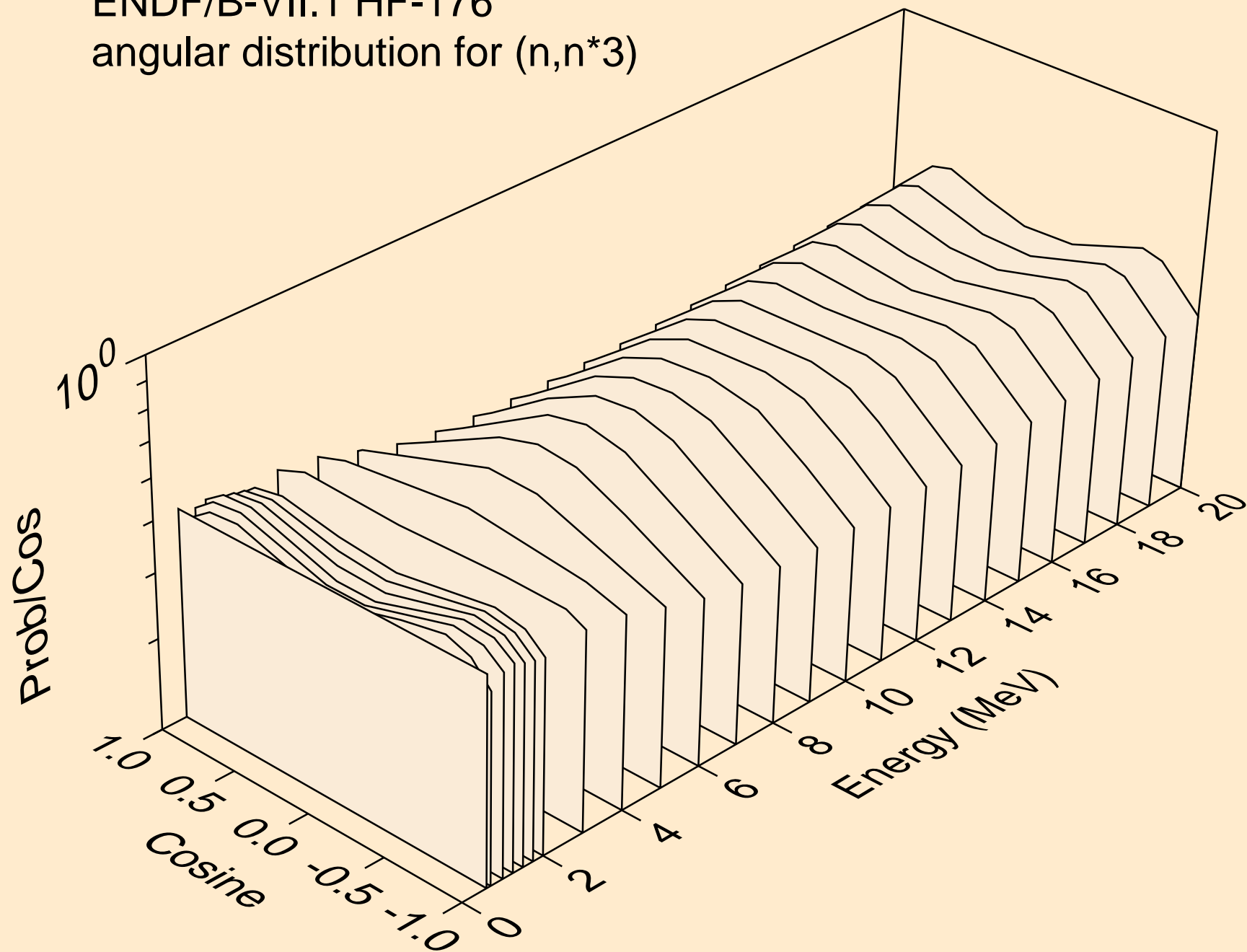

ENDF/B-VII.1 HF-176
angular distribution for (n,n*4)

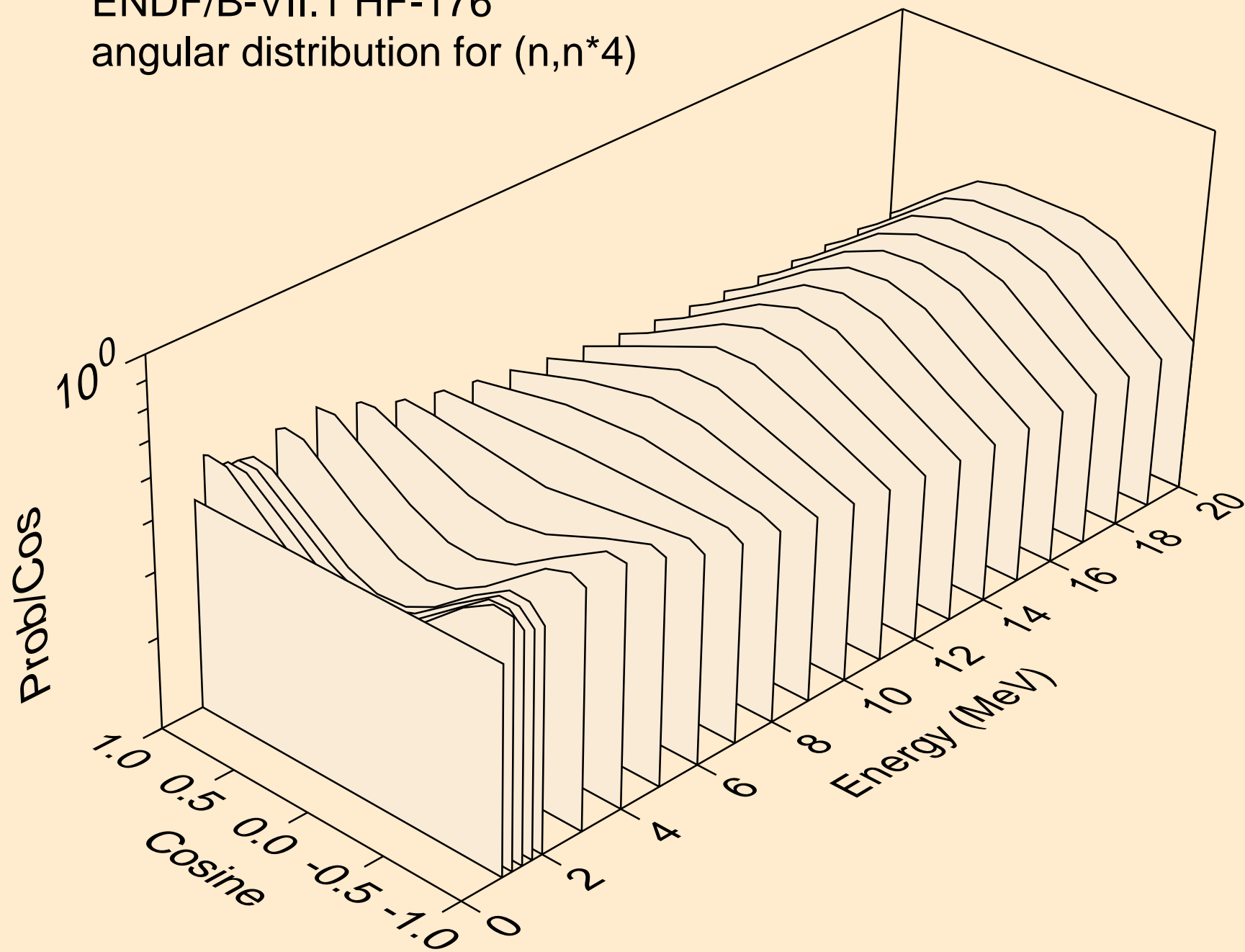

ENDF/B-VII.1 HF-176
angular distribution for (n,n*5)

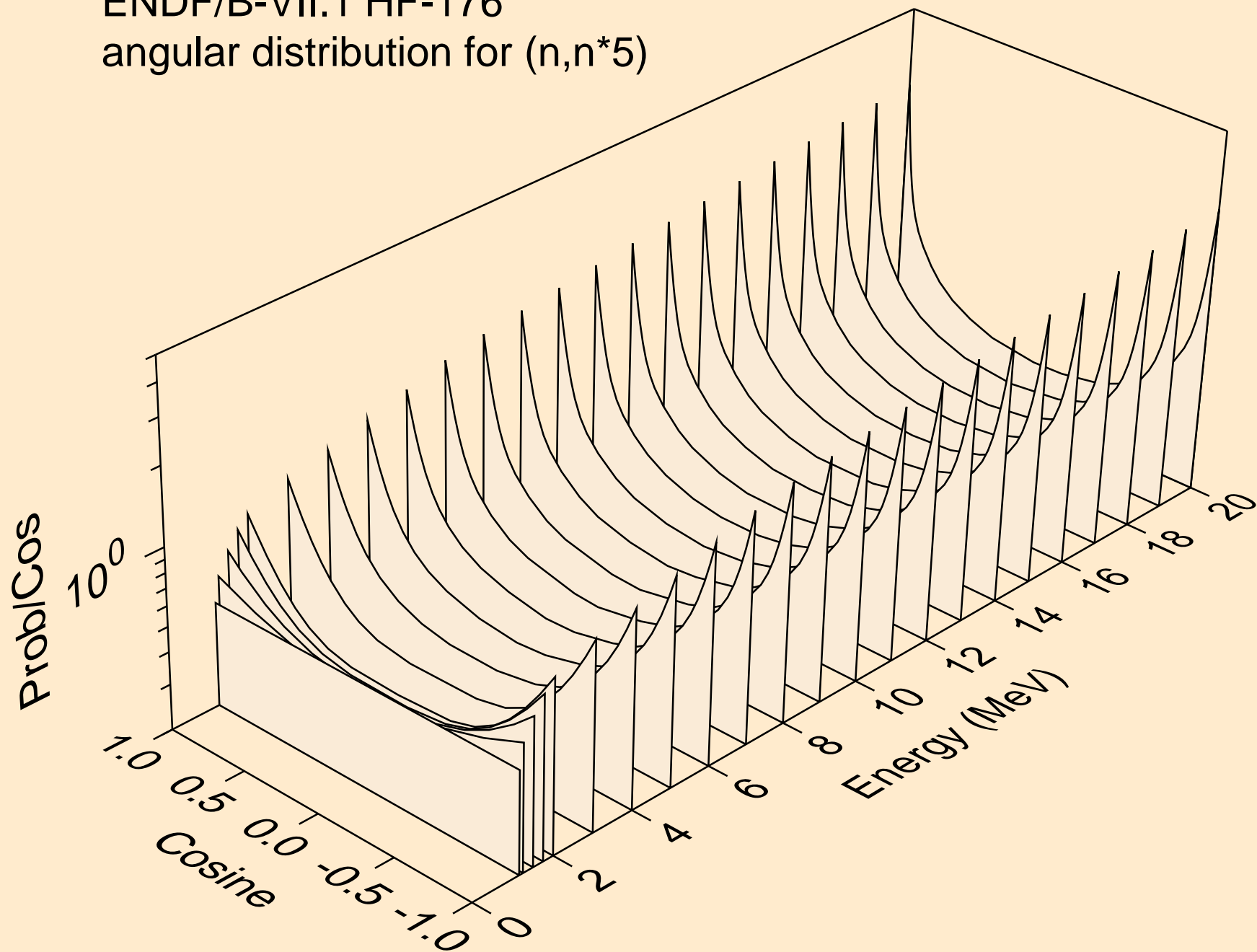

ENDF/B-VII.1 HF-176
angular distribution for (n,n*6)

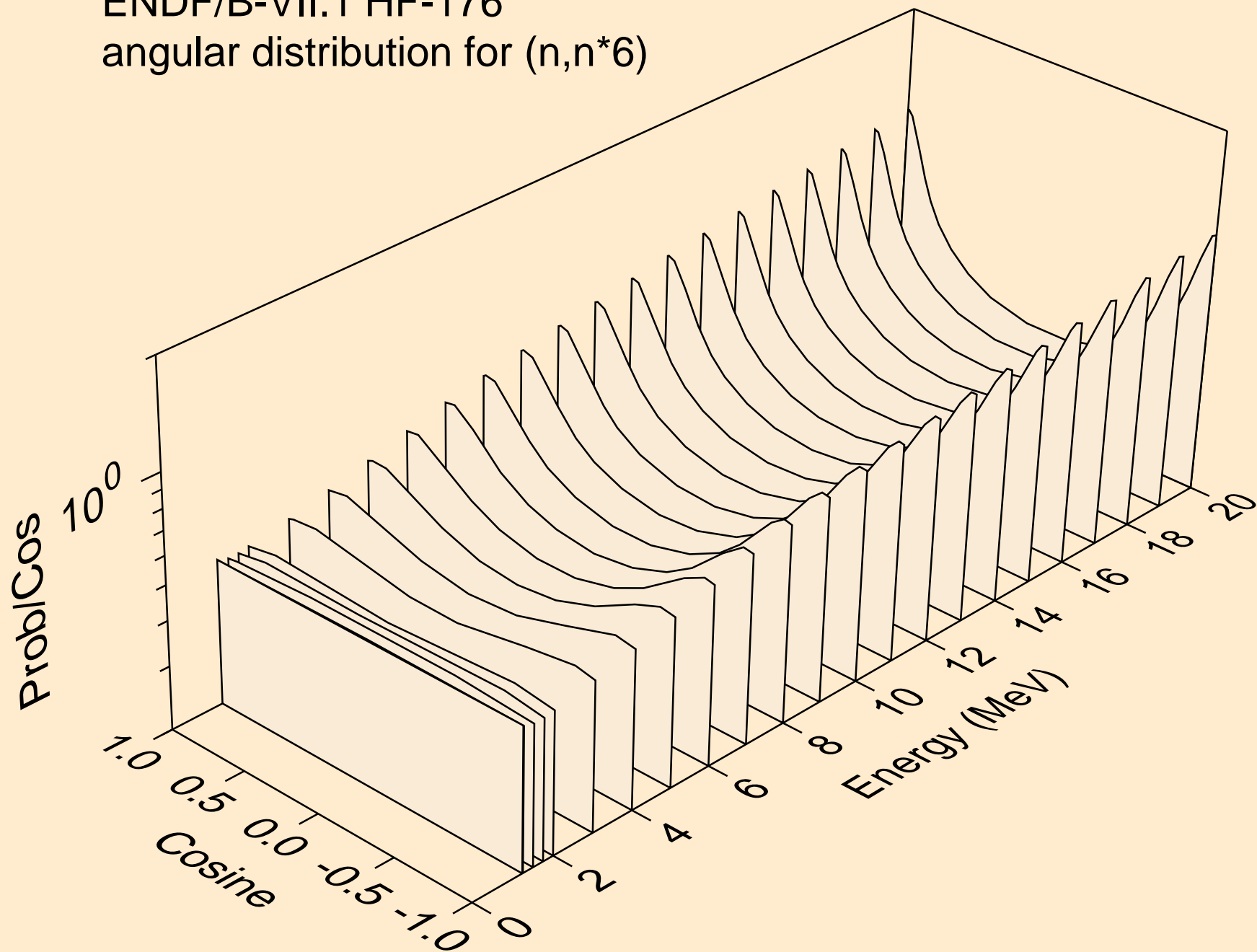

ENDF/B-VII.1 HF-176
angular distribution for (n,n*7)

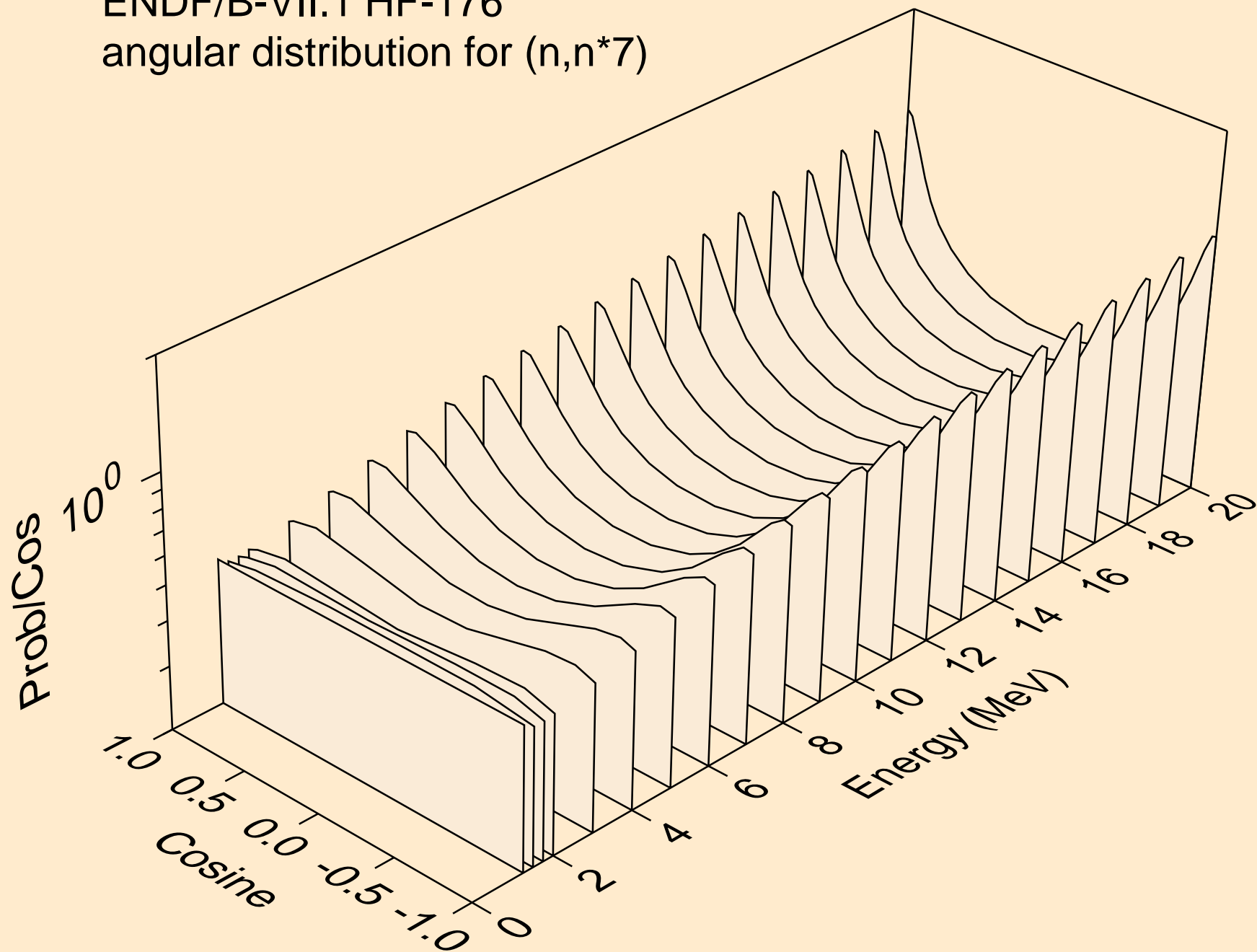

ENDF/B-VII.1 HF-176
angular distribution for (n,n*8)

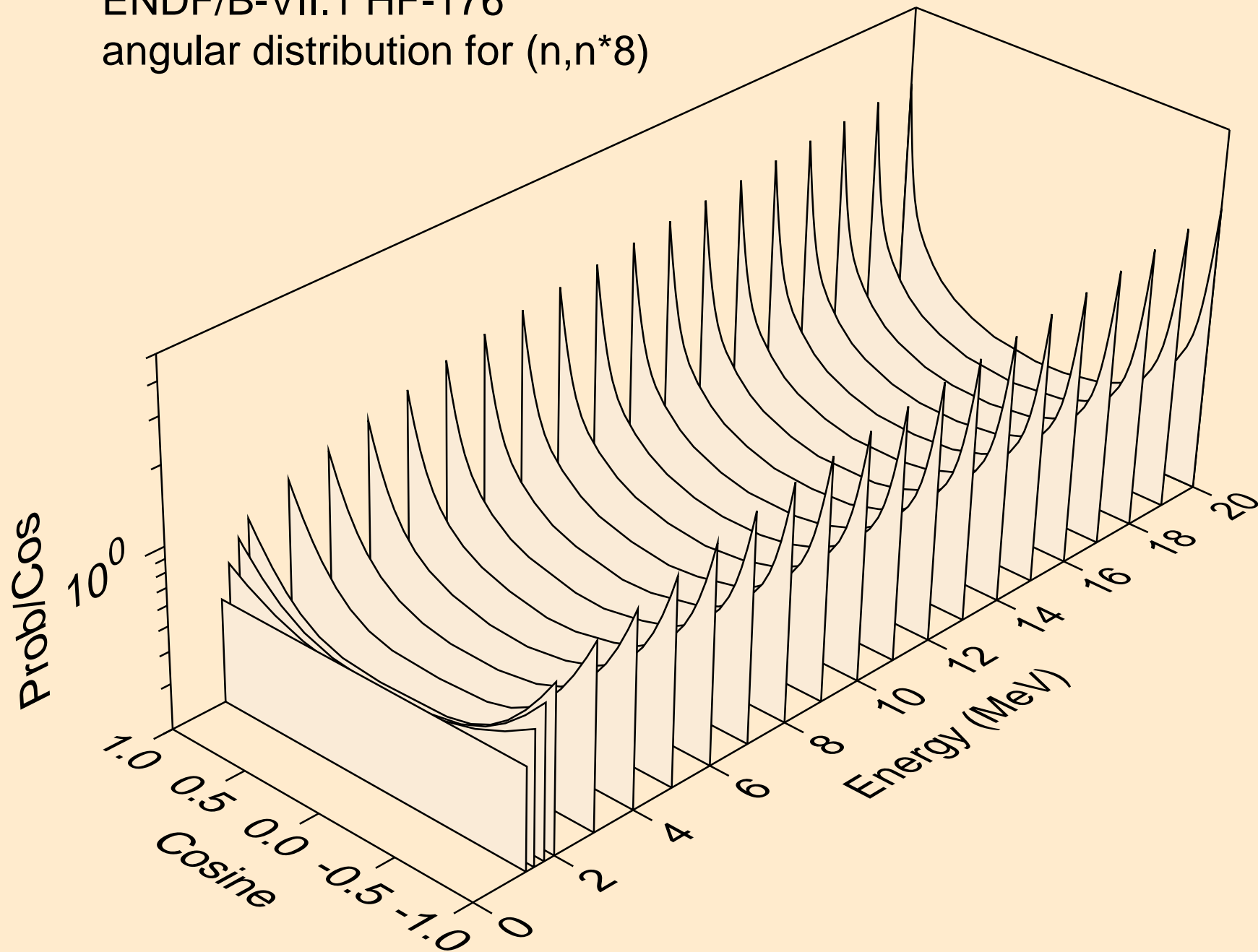

ENDF/B-VII.1 HF-176
angular distribution for (n,n*9)

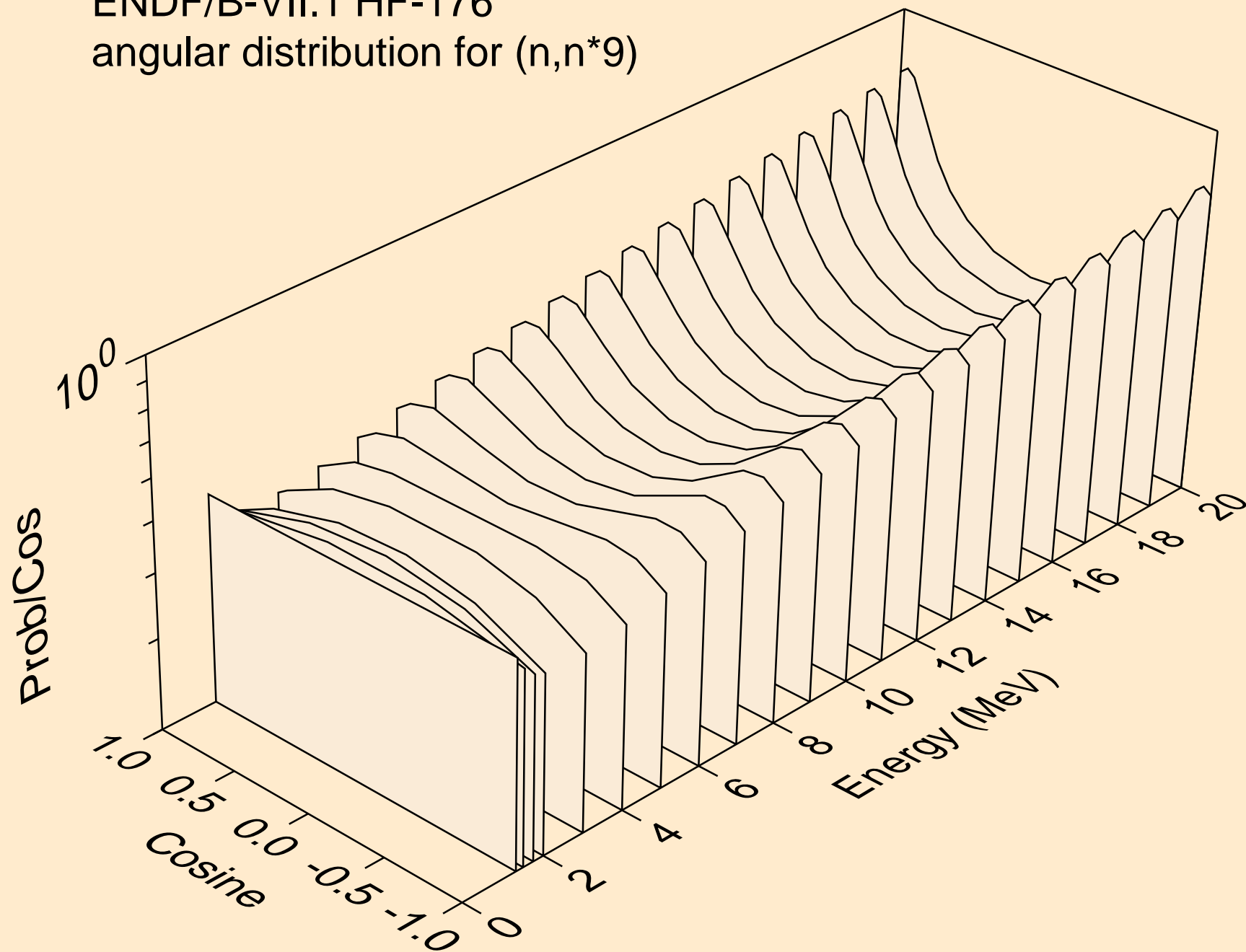

ENDF/B-VII.1 HF-176
angular distribution for (n,n*10)

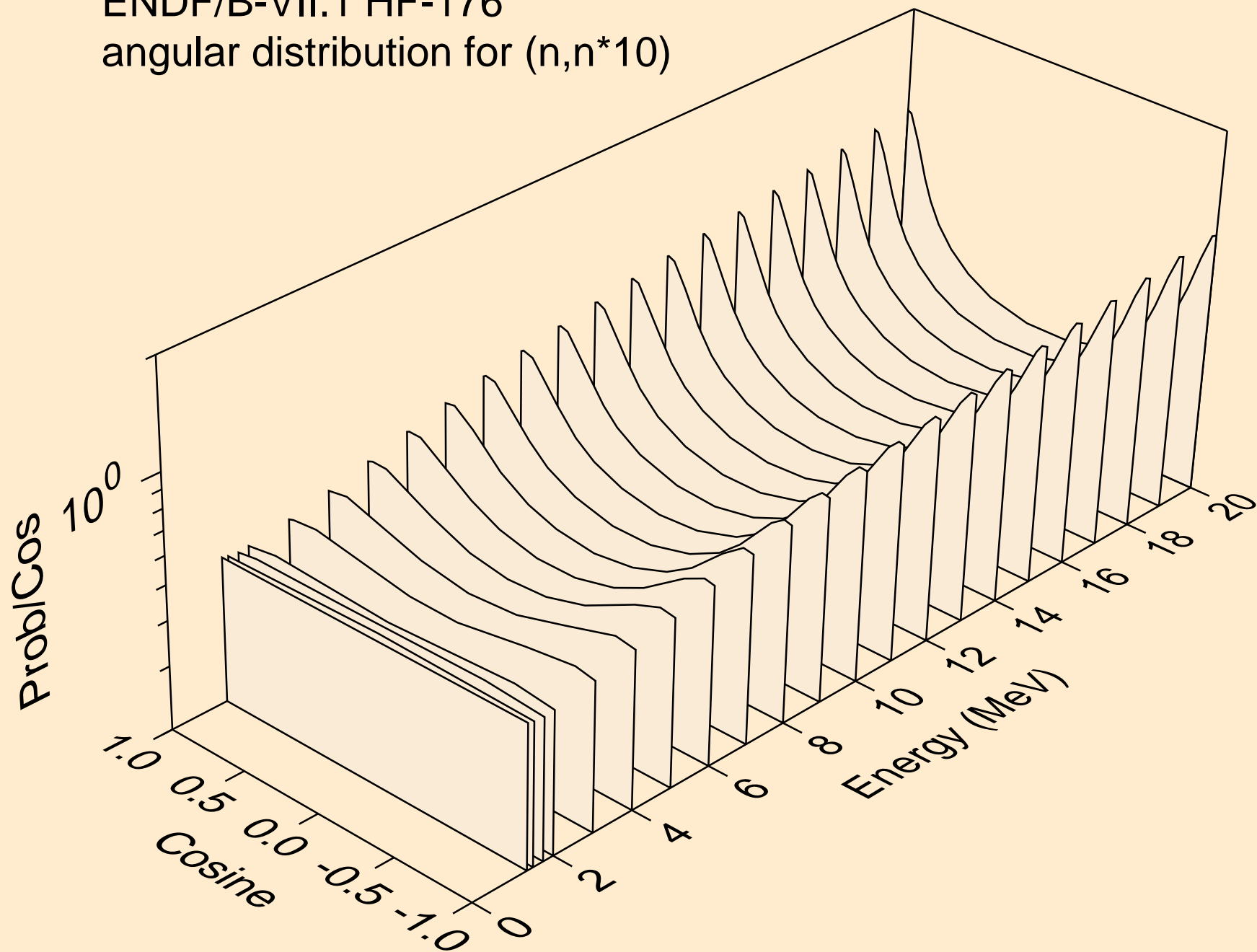

ENDF/B-VII.1 HF-176
angular distribution for (n,n*11)

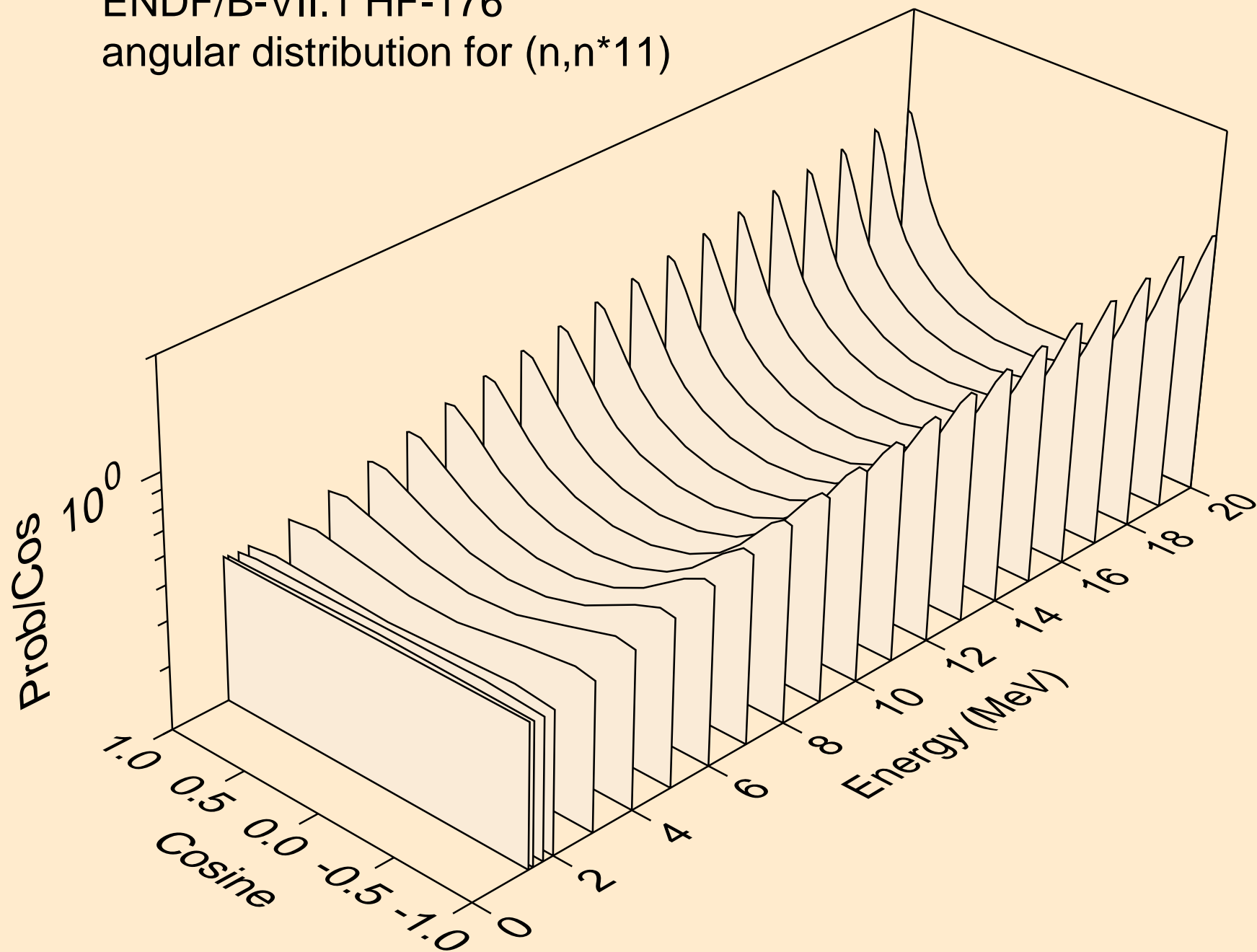

ENDF/B-VII.1 HF-176
angular distribution for (n,n*12)

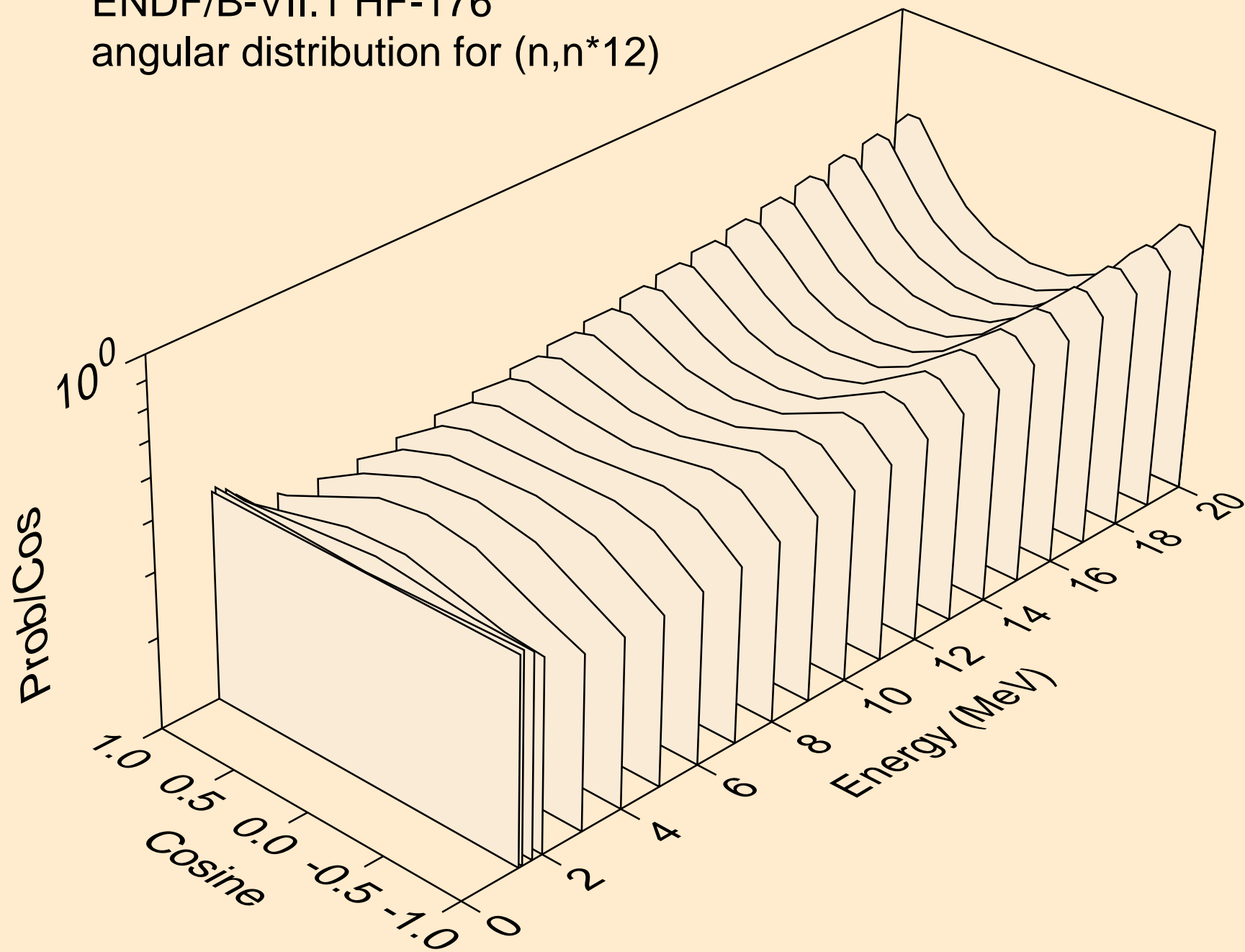

ENDF/B-VII.1 HF-176
angular distribution for (n,n*13)

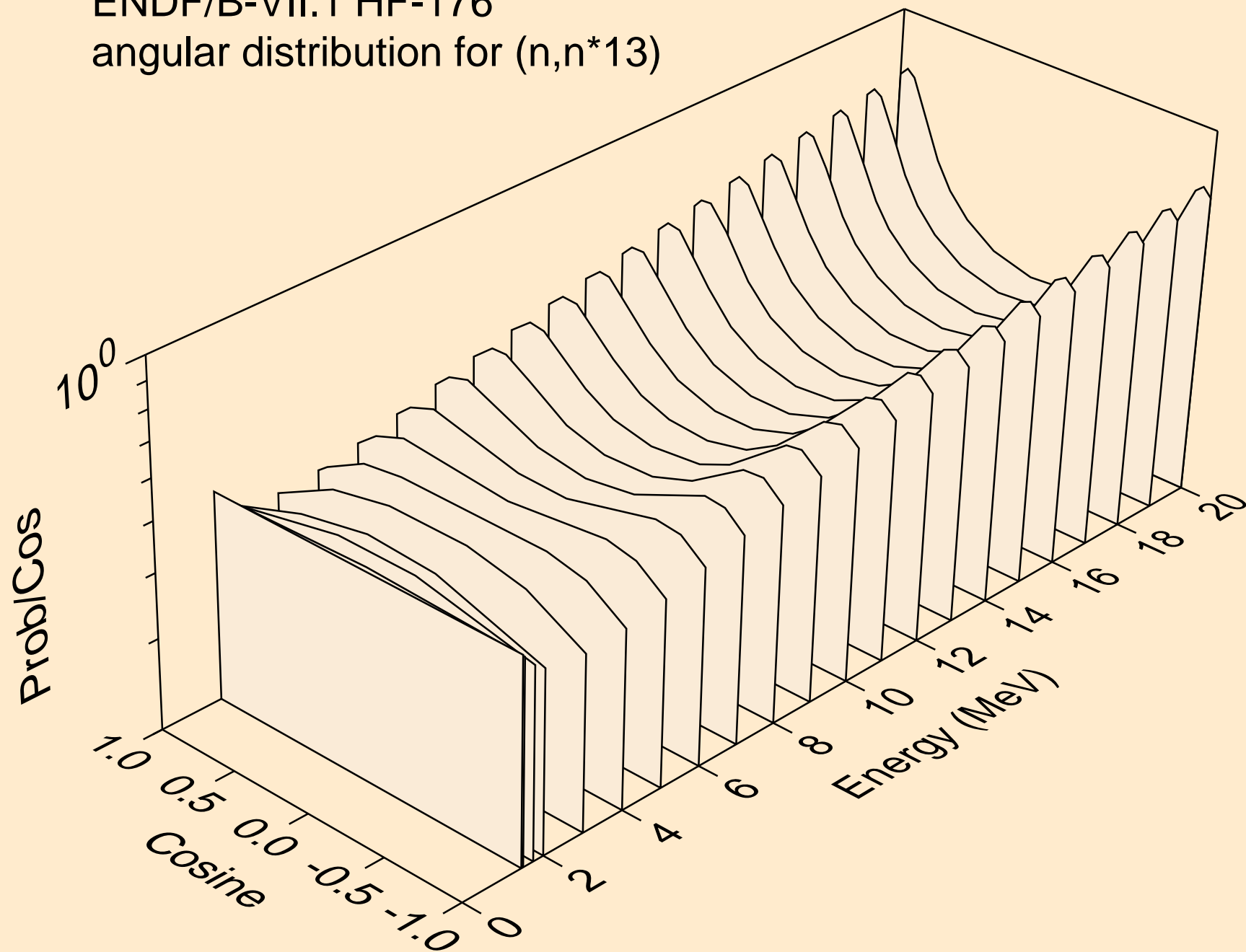

ENDF/B-VII.1 HF-176
angular distribution for (n,n*14)

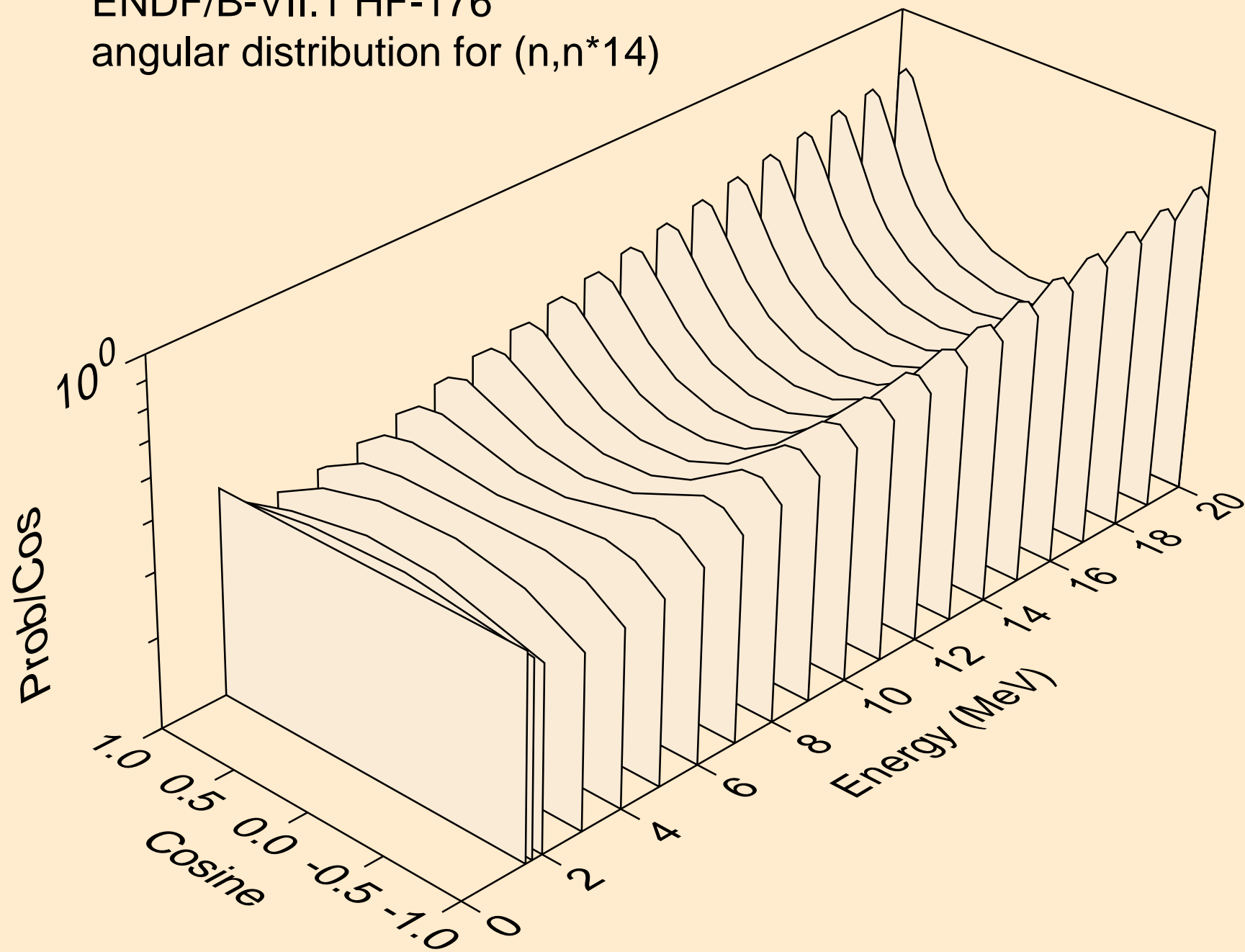

ENDF/B-VII.1 HF-176
angular distribution for (n,n*15)

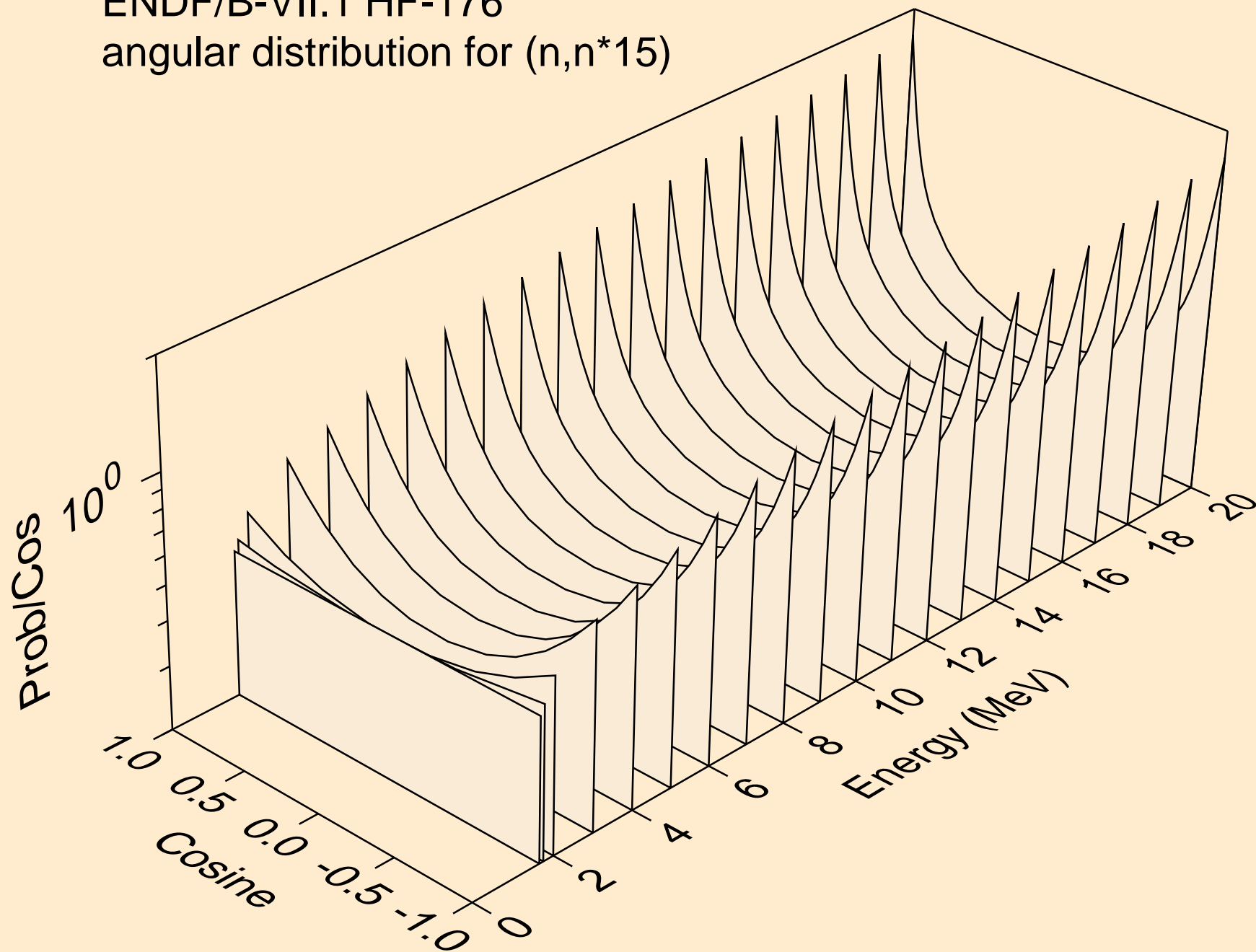

ENDF/B-VII.1 HF-176
angular distribution for (n,n*16)

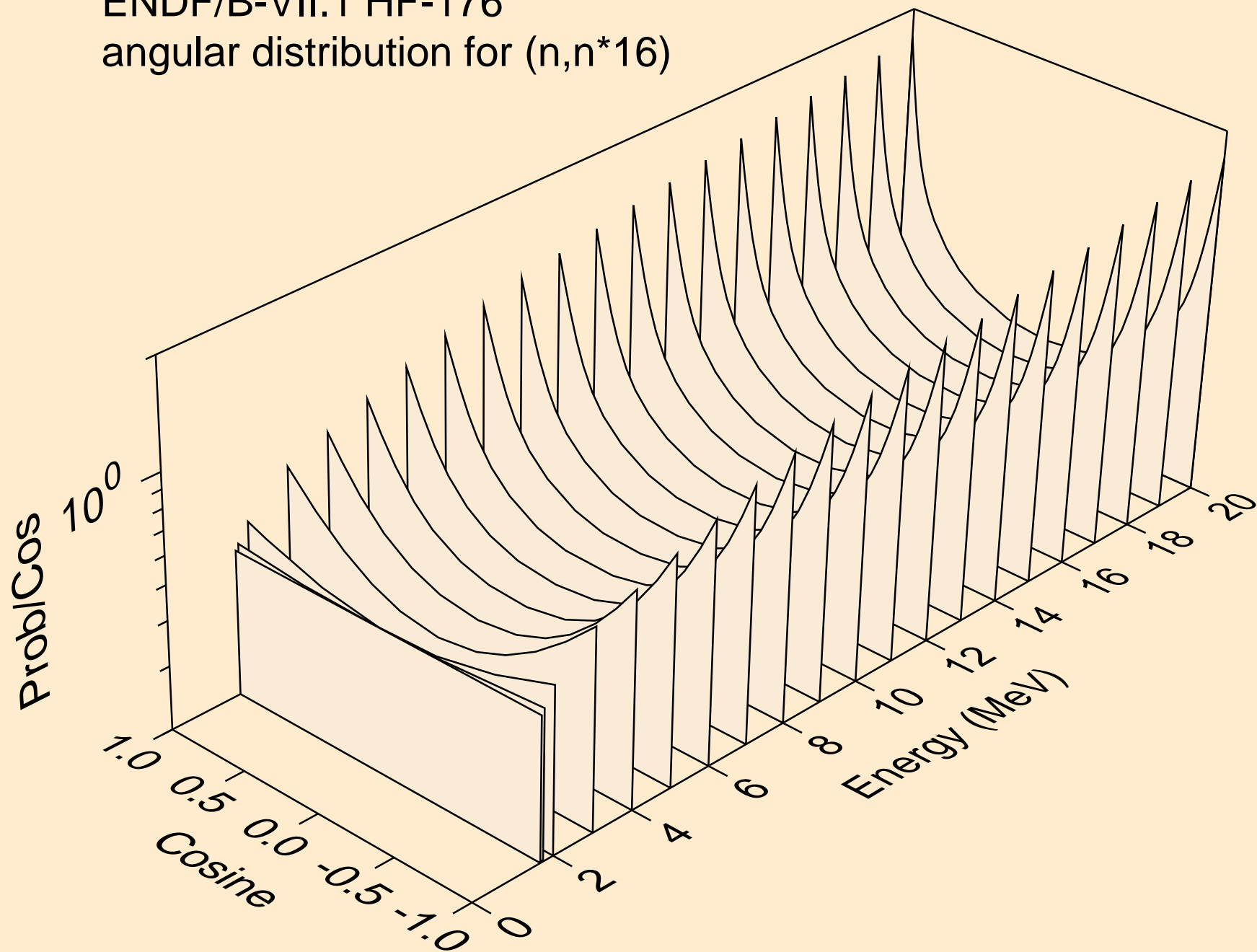

ENDF/B-VII.1 HF-176
angular distribution for (n,n*17)

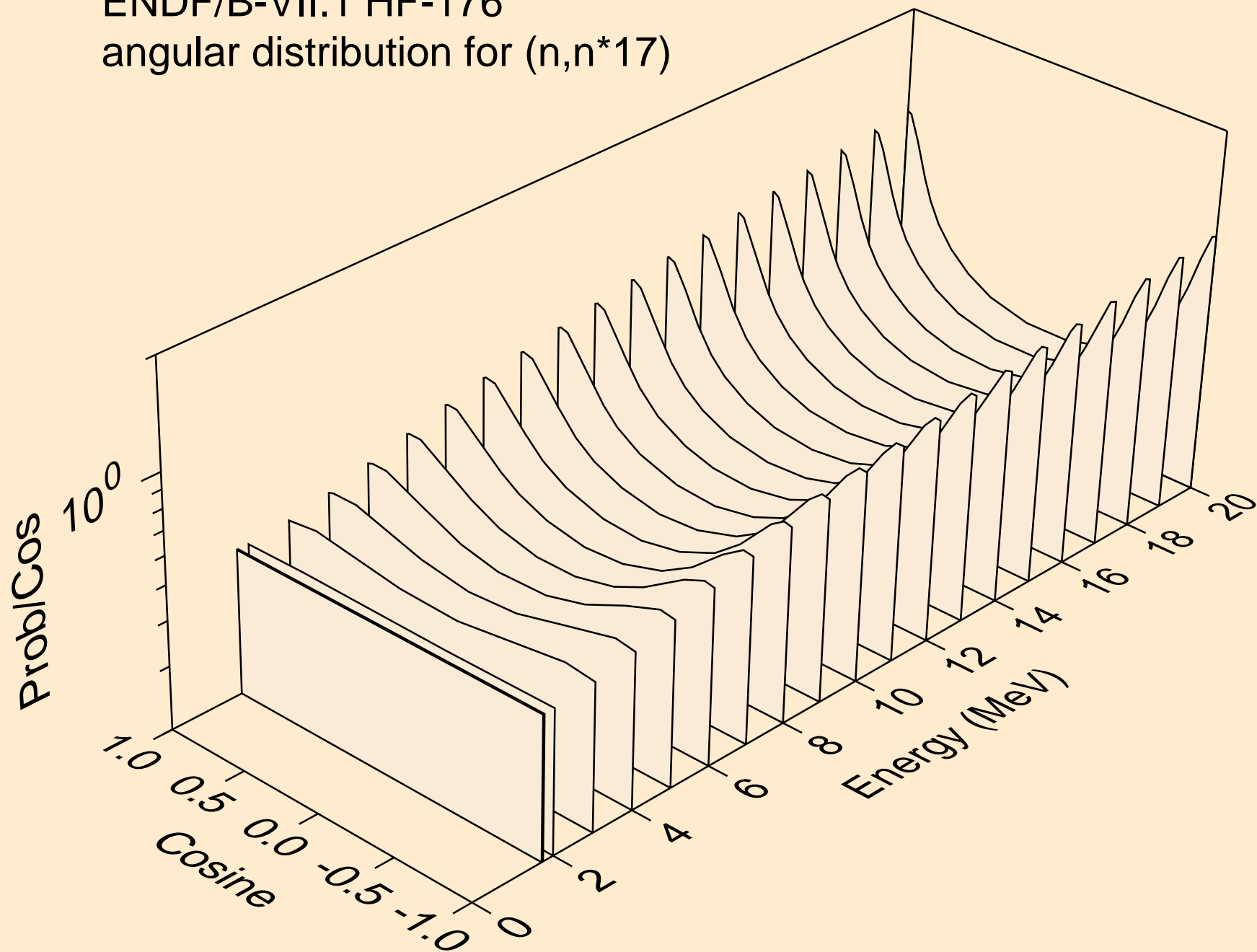

ENDF/B-VII.1 HF-176
angular distribution for (n,n*18)

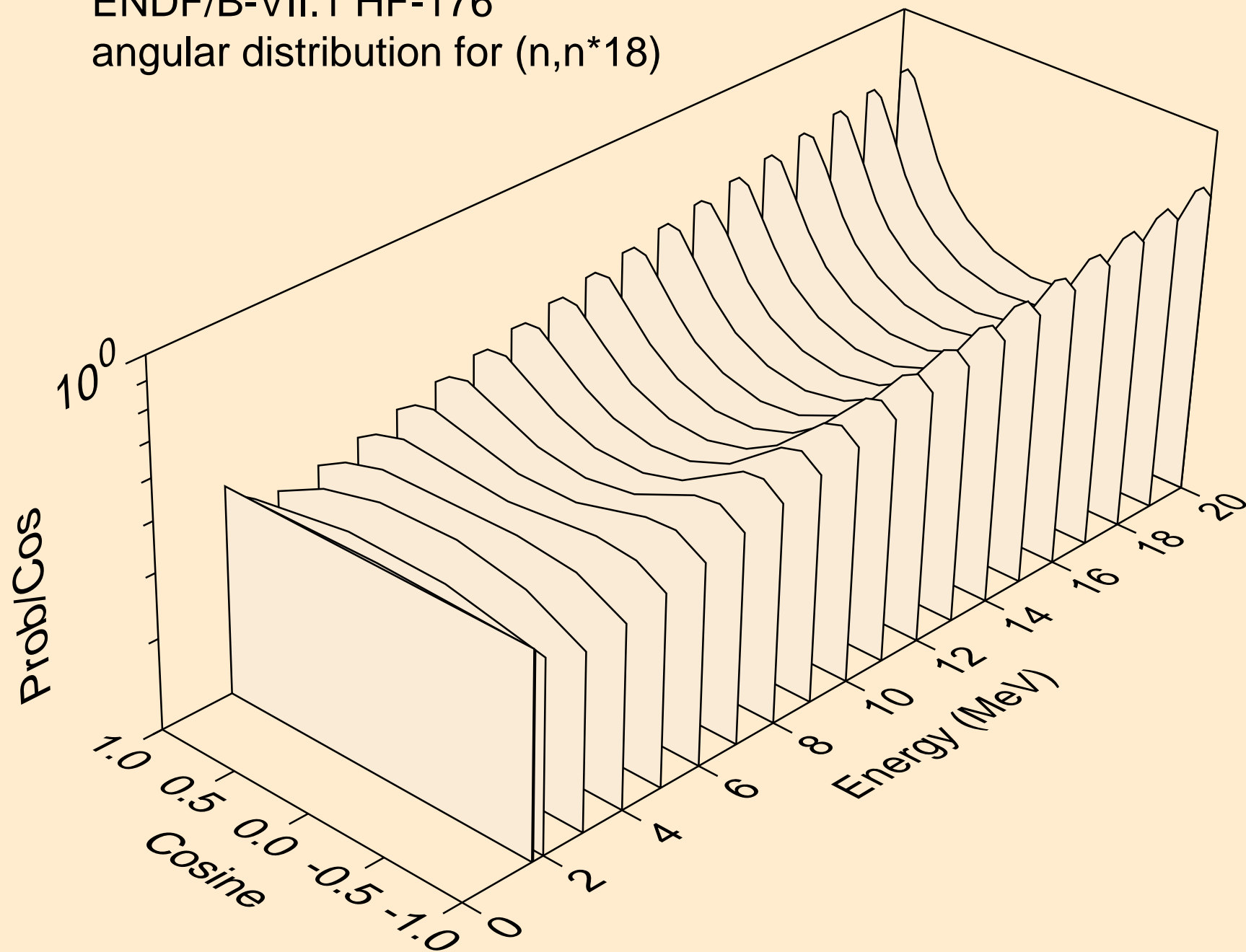

ENDF/B-VII.1 HF-176
angular distribution for (n,n*19)

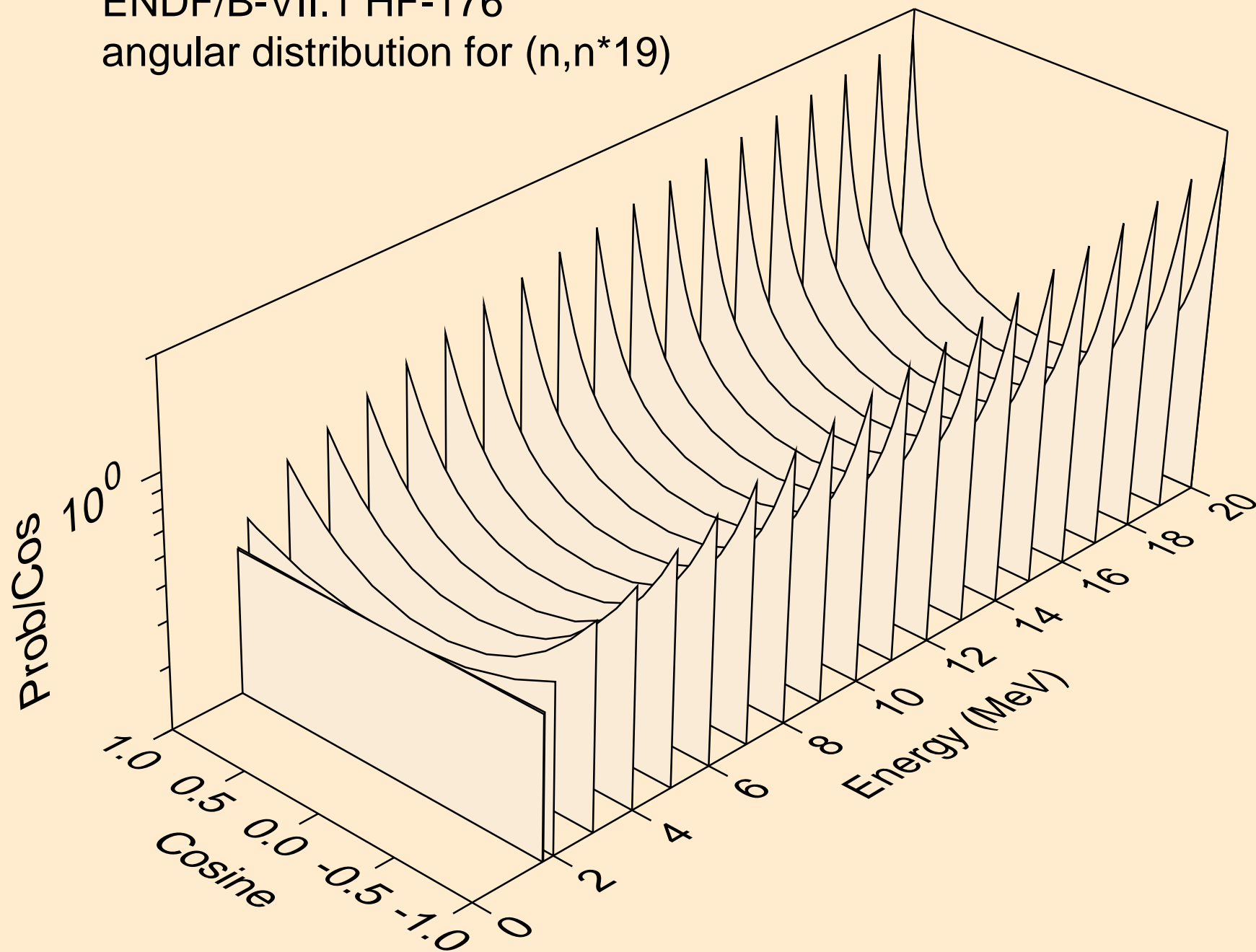

ENDF/B-VII.1 HF-176
angular distribution for (n,n*20)

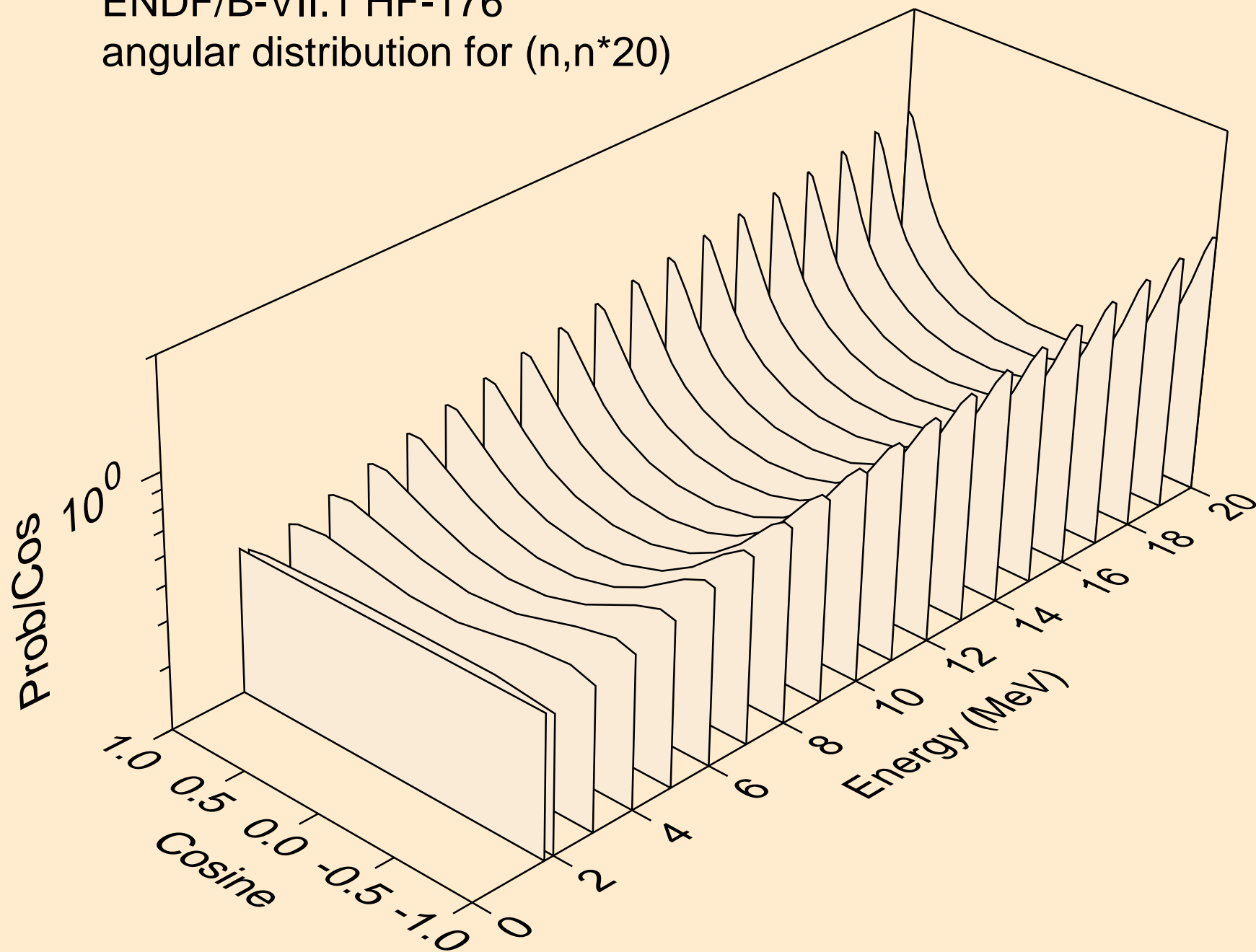

ENDF/B-VII.1 HF-176
angular distribution for (n,n*21)

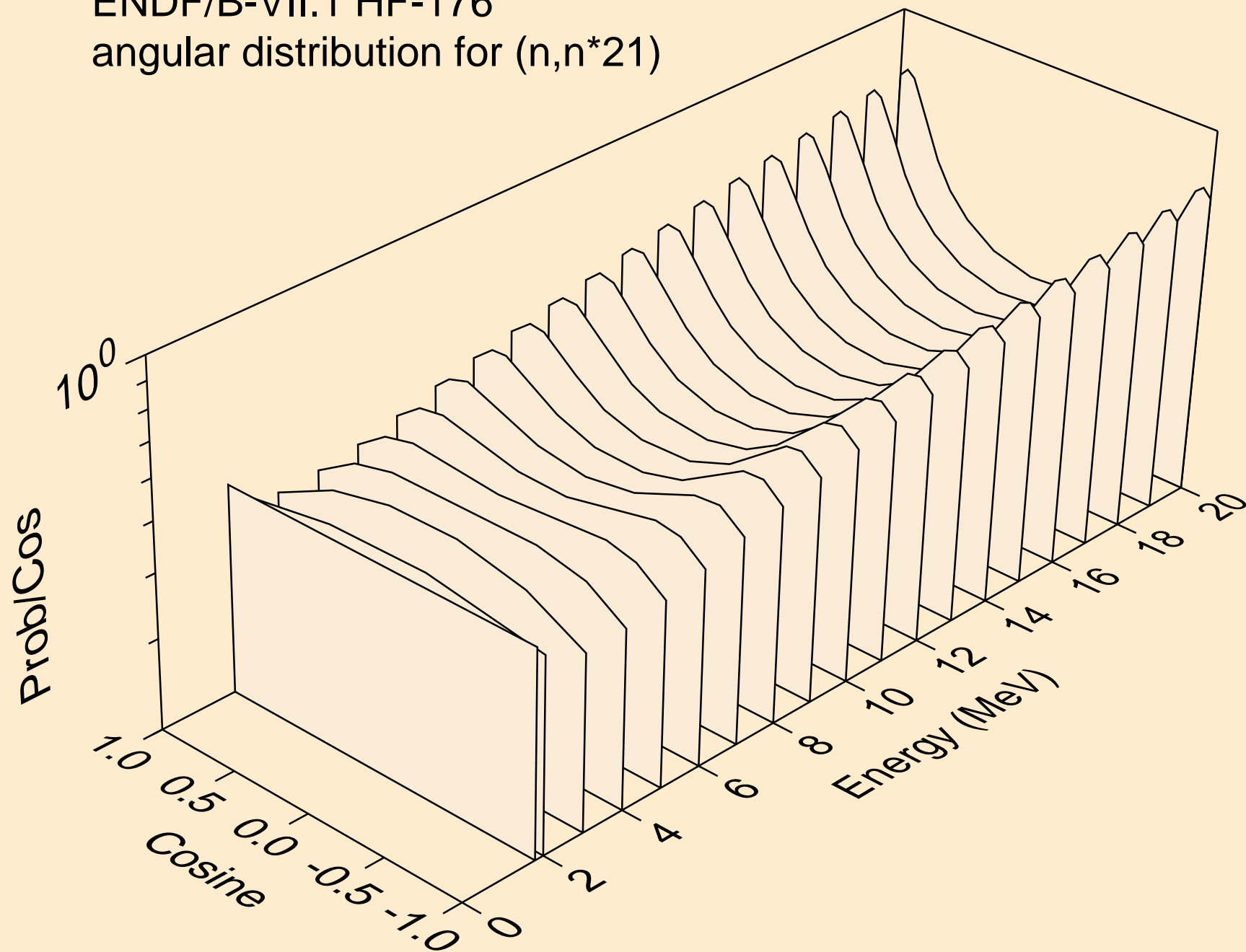

ENDF/B-VII.1 HF-176
angular distribution for (n,n*22)

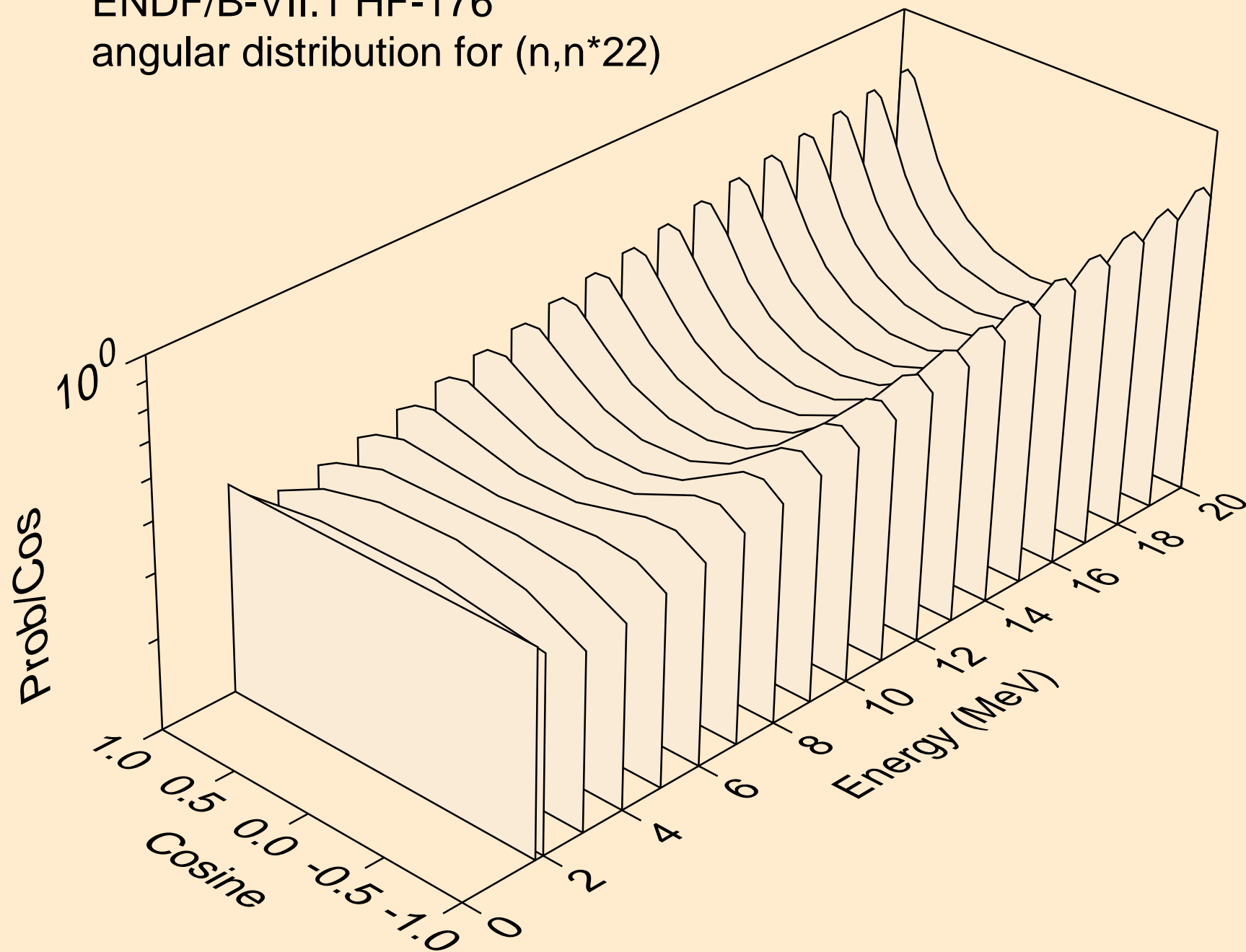

ENDF/B-VII.1 HF-176
angular distribution for (n,n*23)

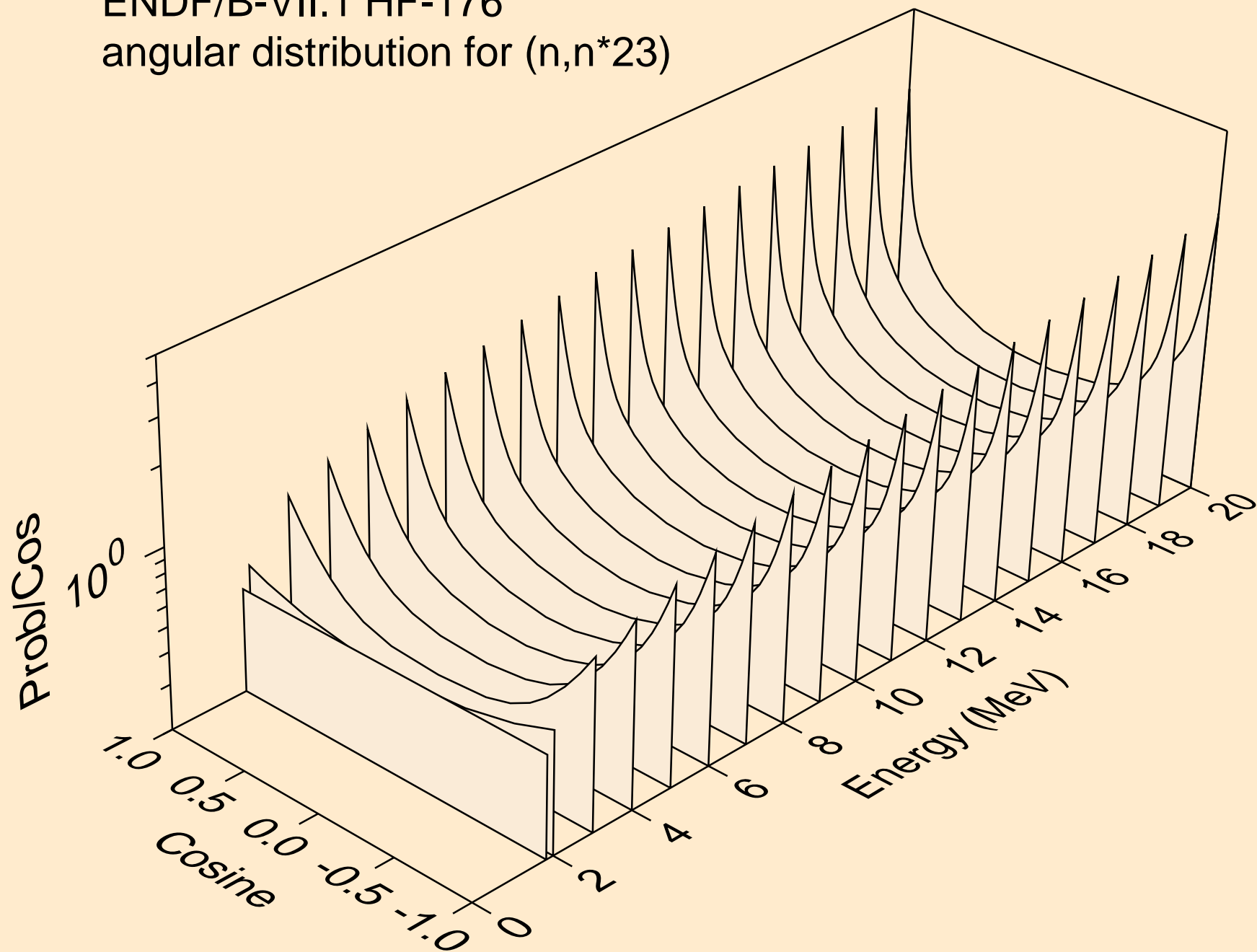

ENDF/B-VII.1 HF-176
Neutron emission for (n,2n)

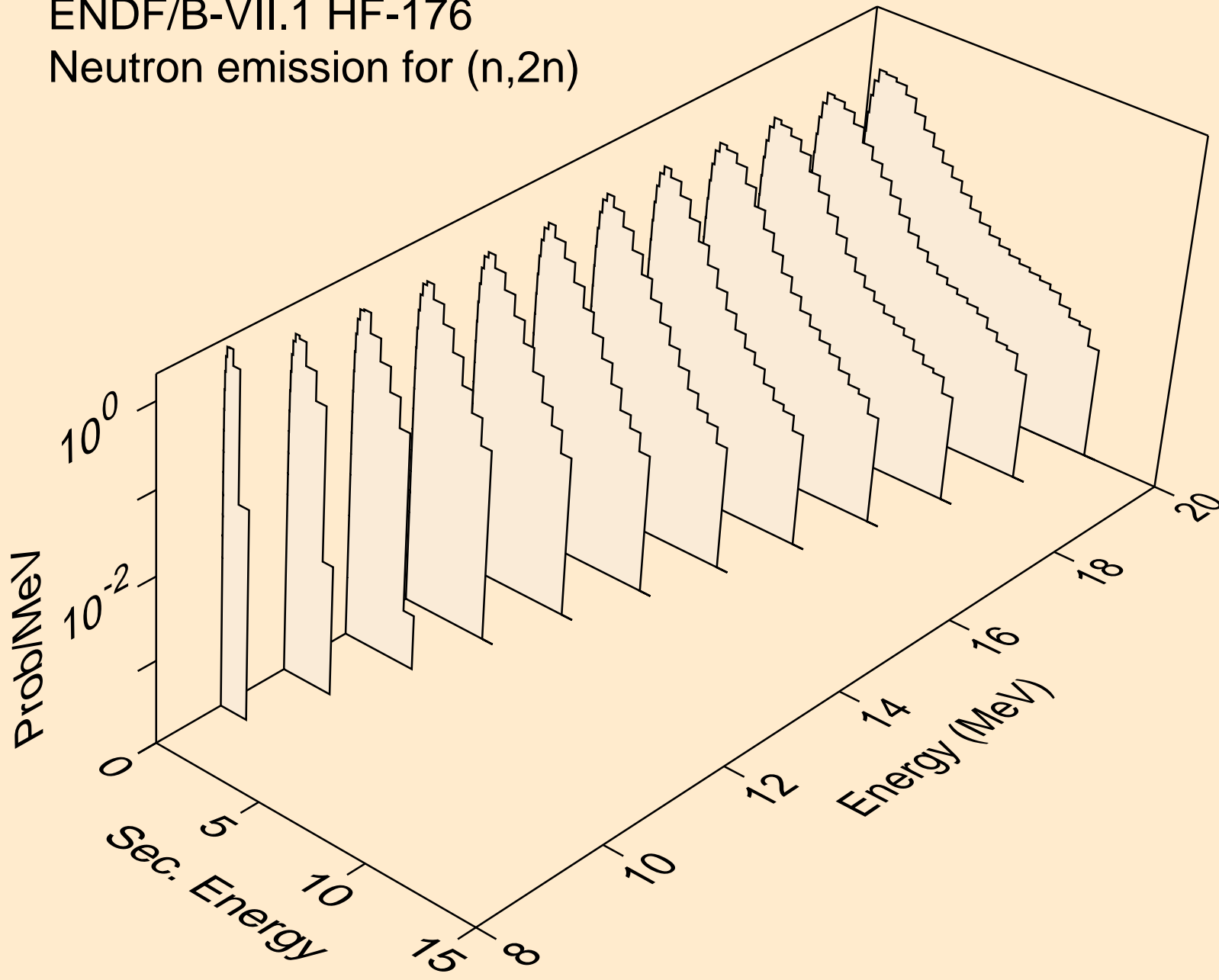

ENDF/B-VII.1 HF-176
Neutron emission for (n,3n)

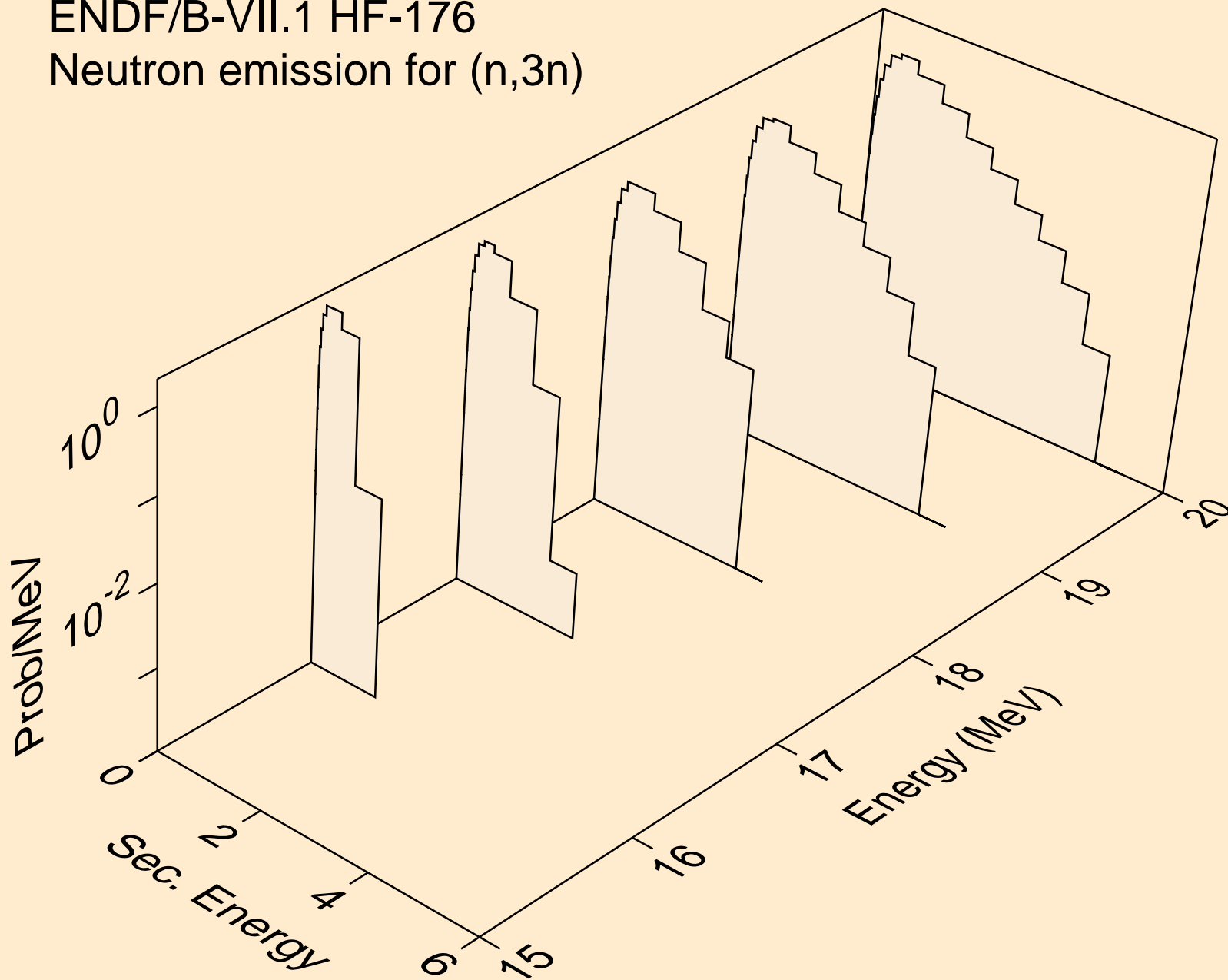

ENDF/B-VII.1 HF-176
Neutron emission for (n,n*c)

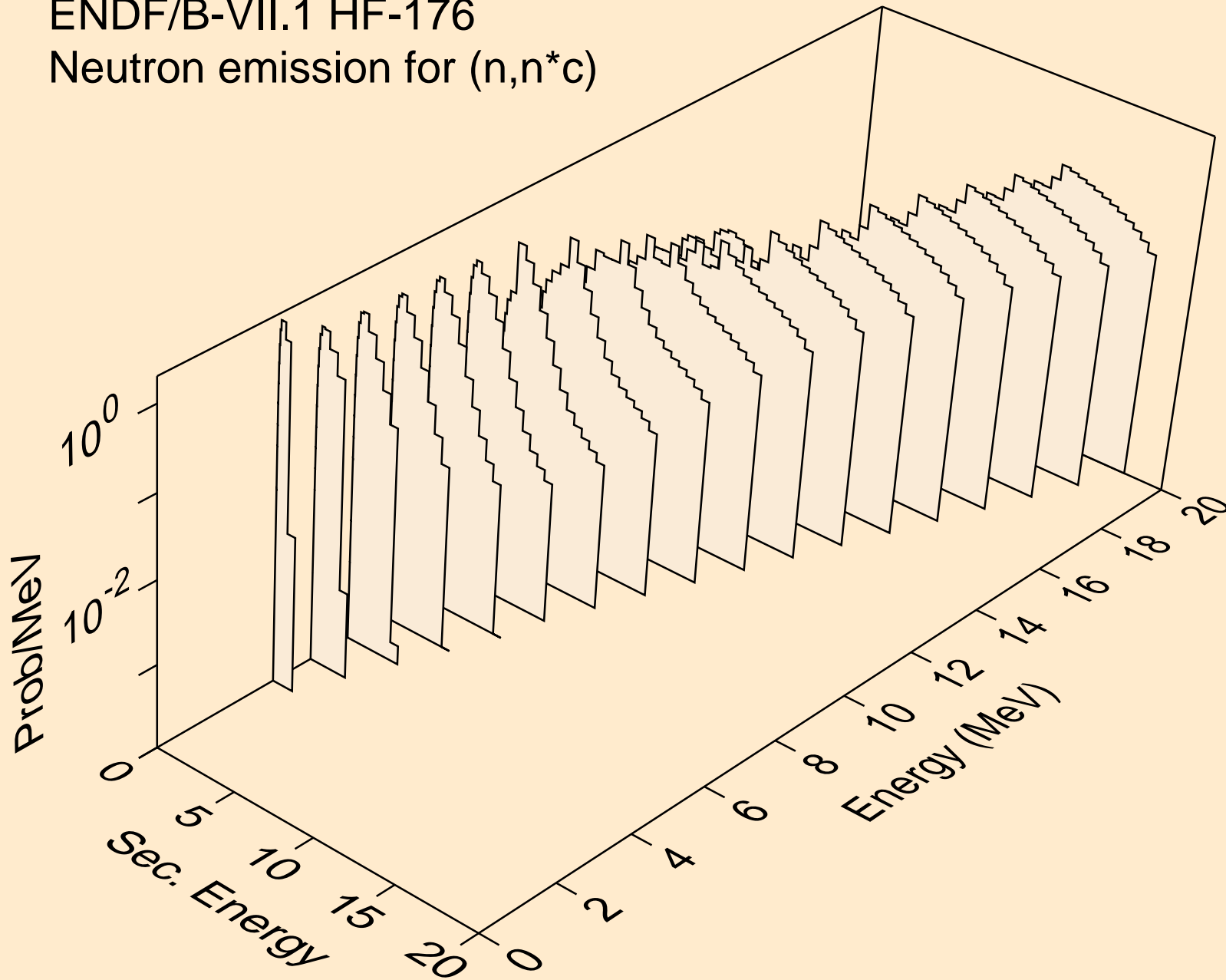

ENDF/B-VII.1 HF-176
Photon emission for (n,2n)

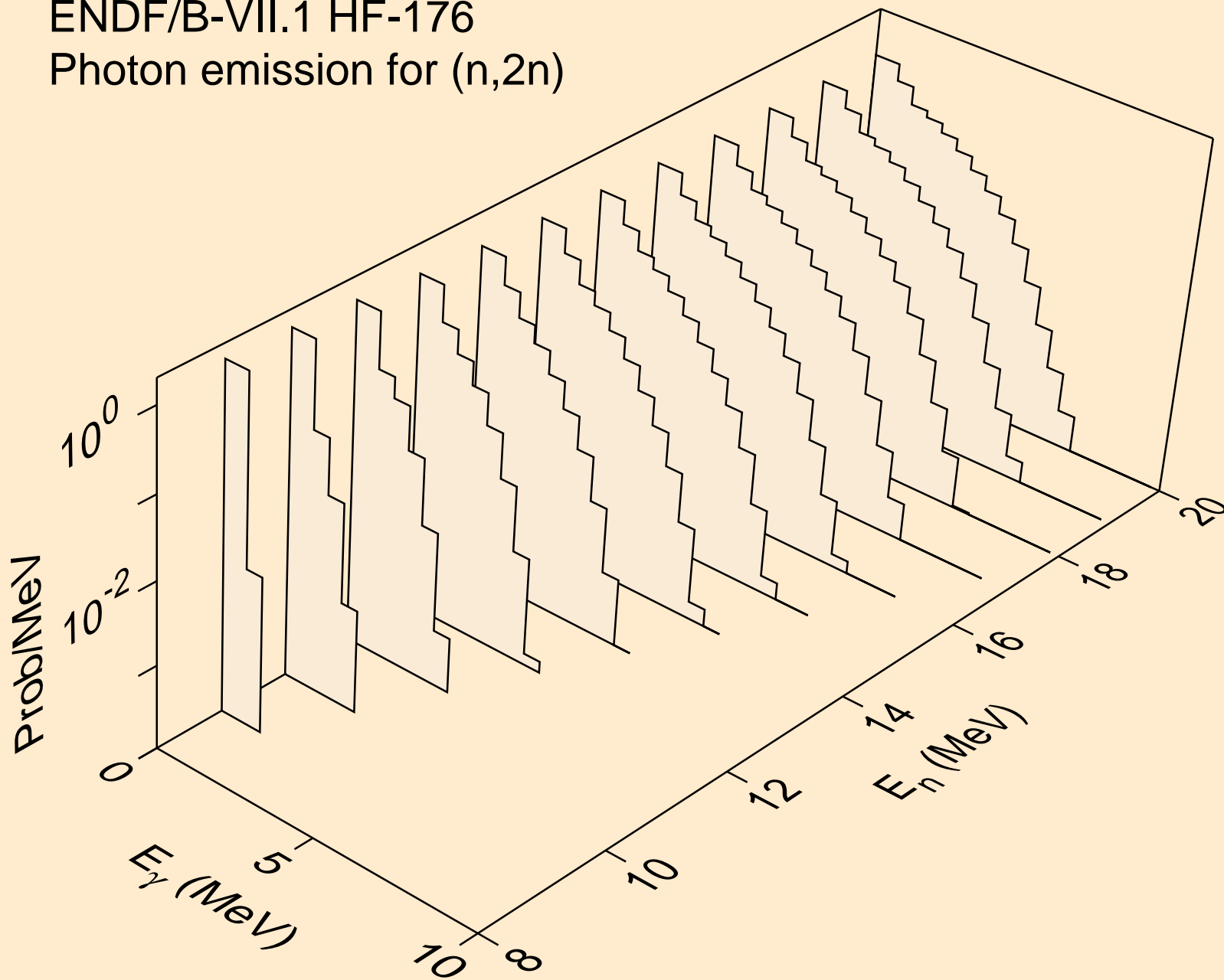

ENDF/B-VII.1 HF-176
Photon emission for (n,3n)

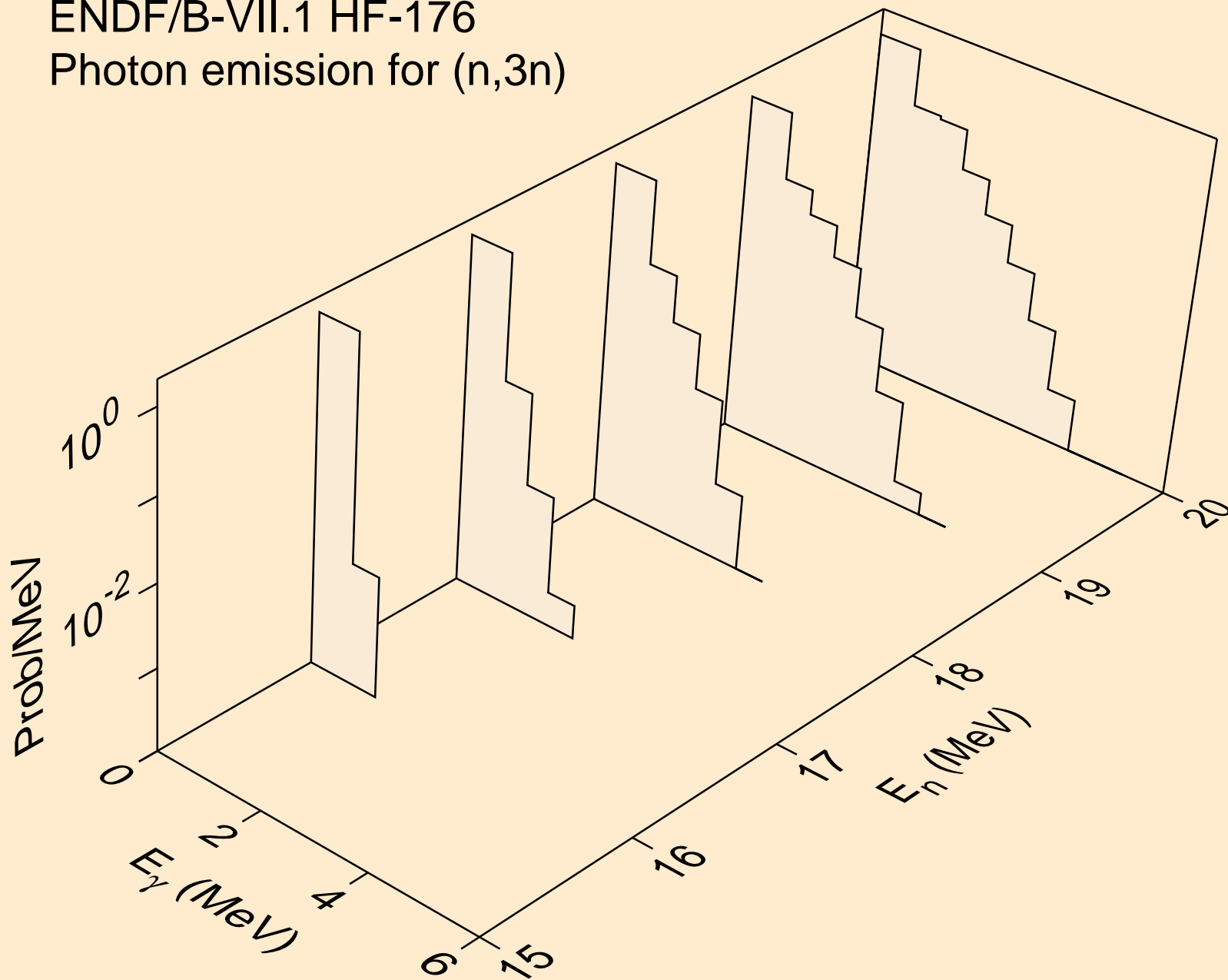

ENDF/B-VII.1 HF-176
Photon emission for (n,n*c)

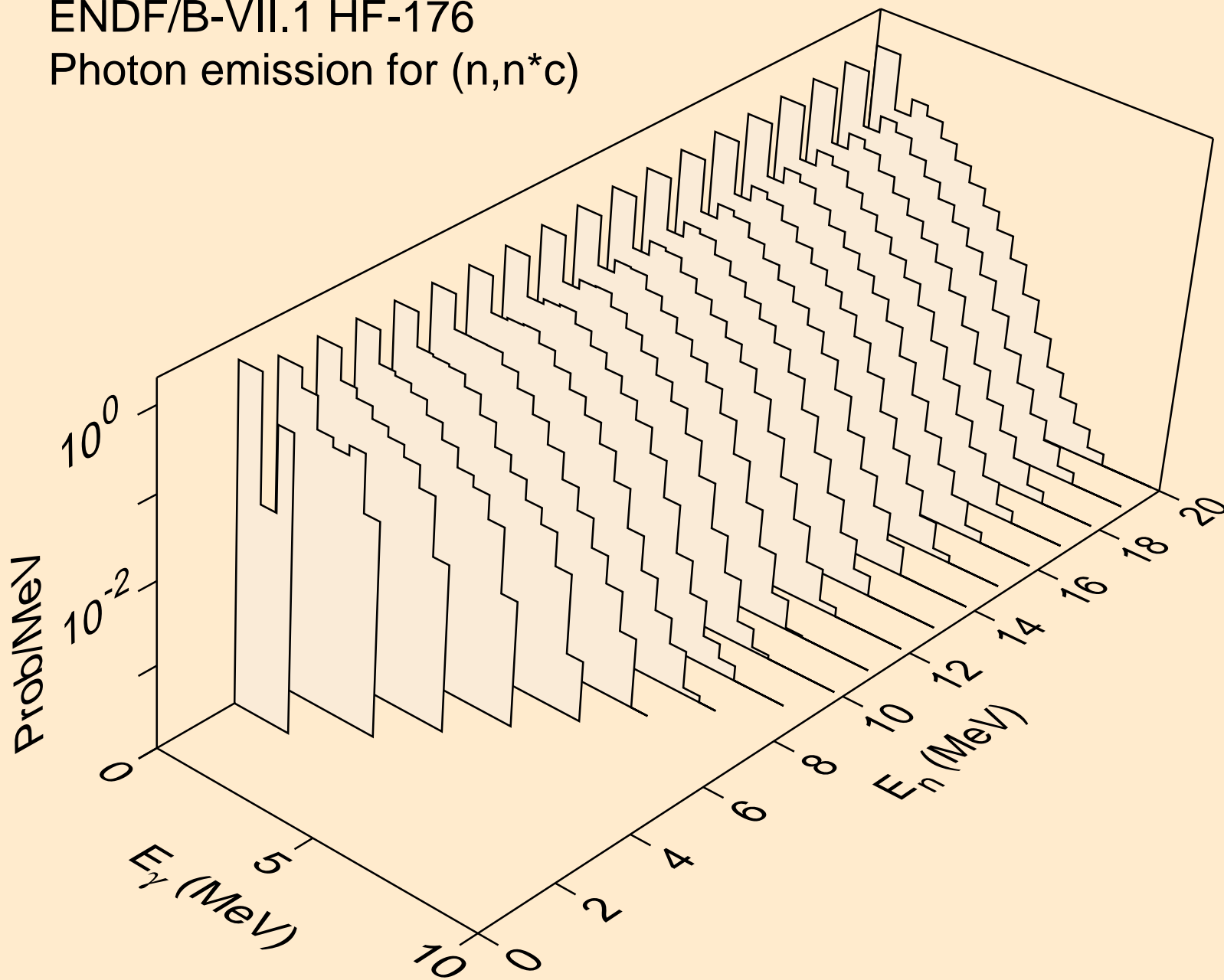

ENDF/B-VII.1 HF-176
Photon emission for (n,gma)

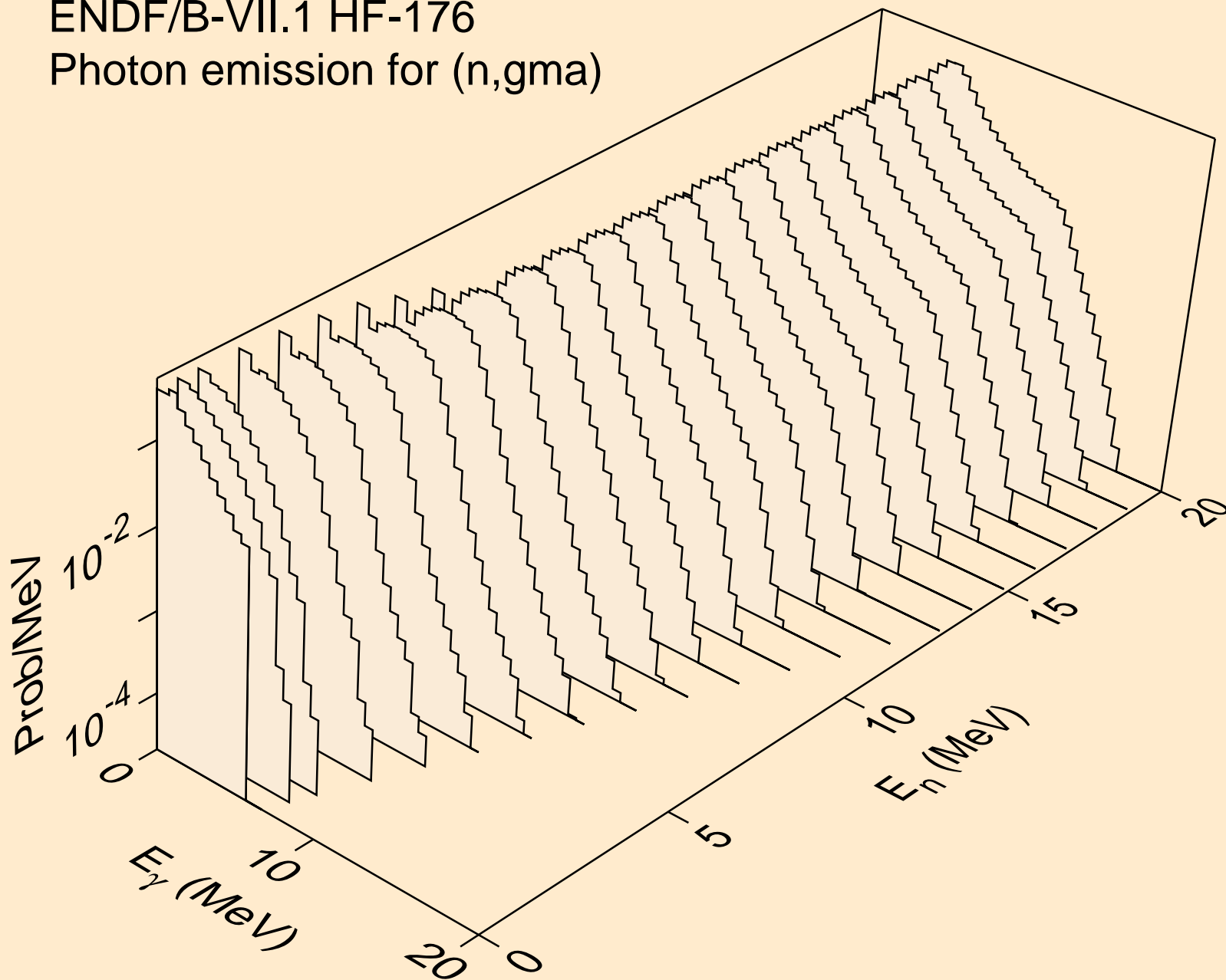

ENDF/B-VII.1 HF-176
Photon emission for (n,p)

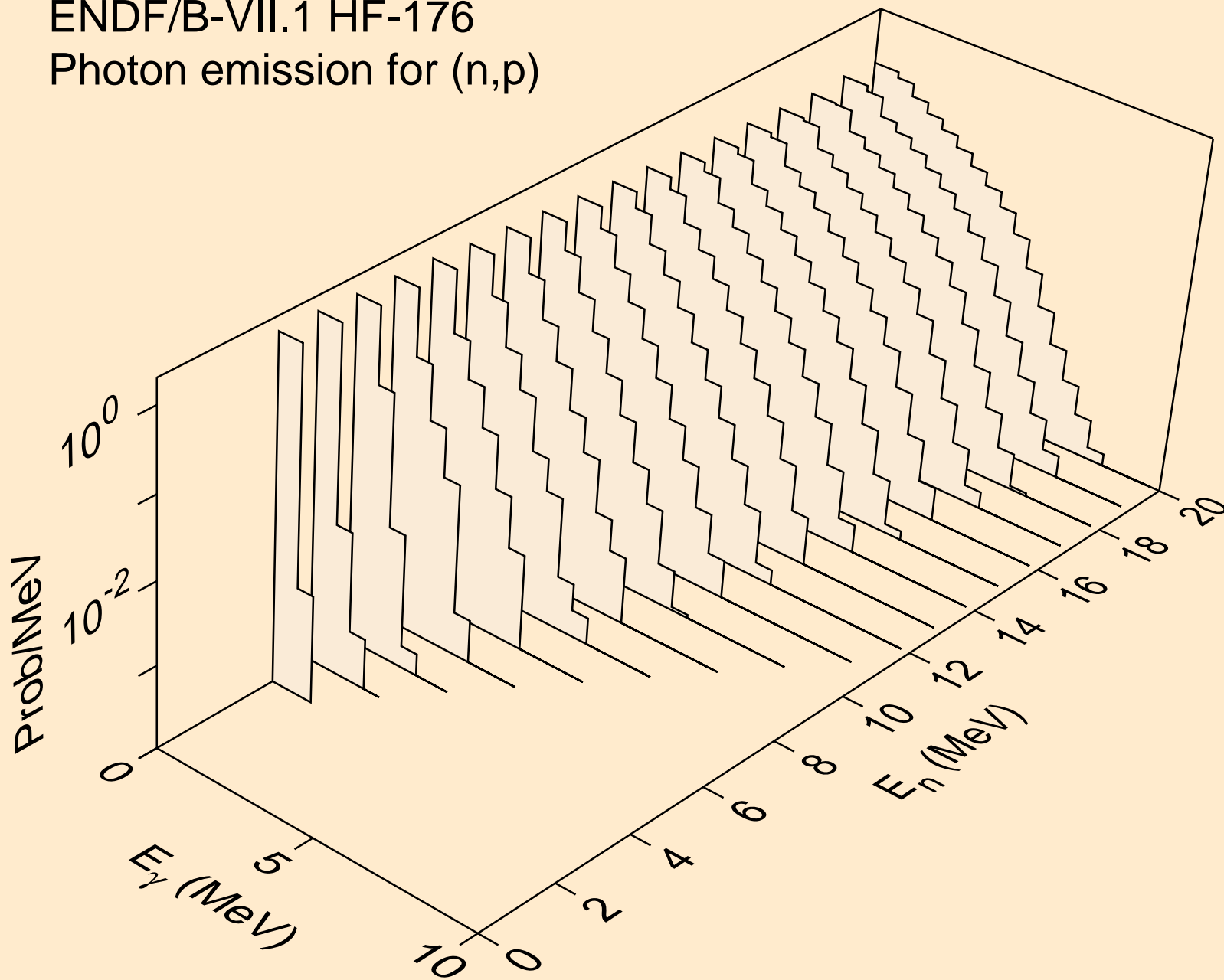

ENDF/B-VII.1 HF-176
Photon emission for (n,a)

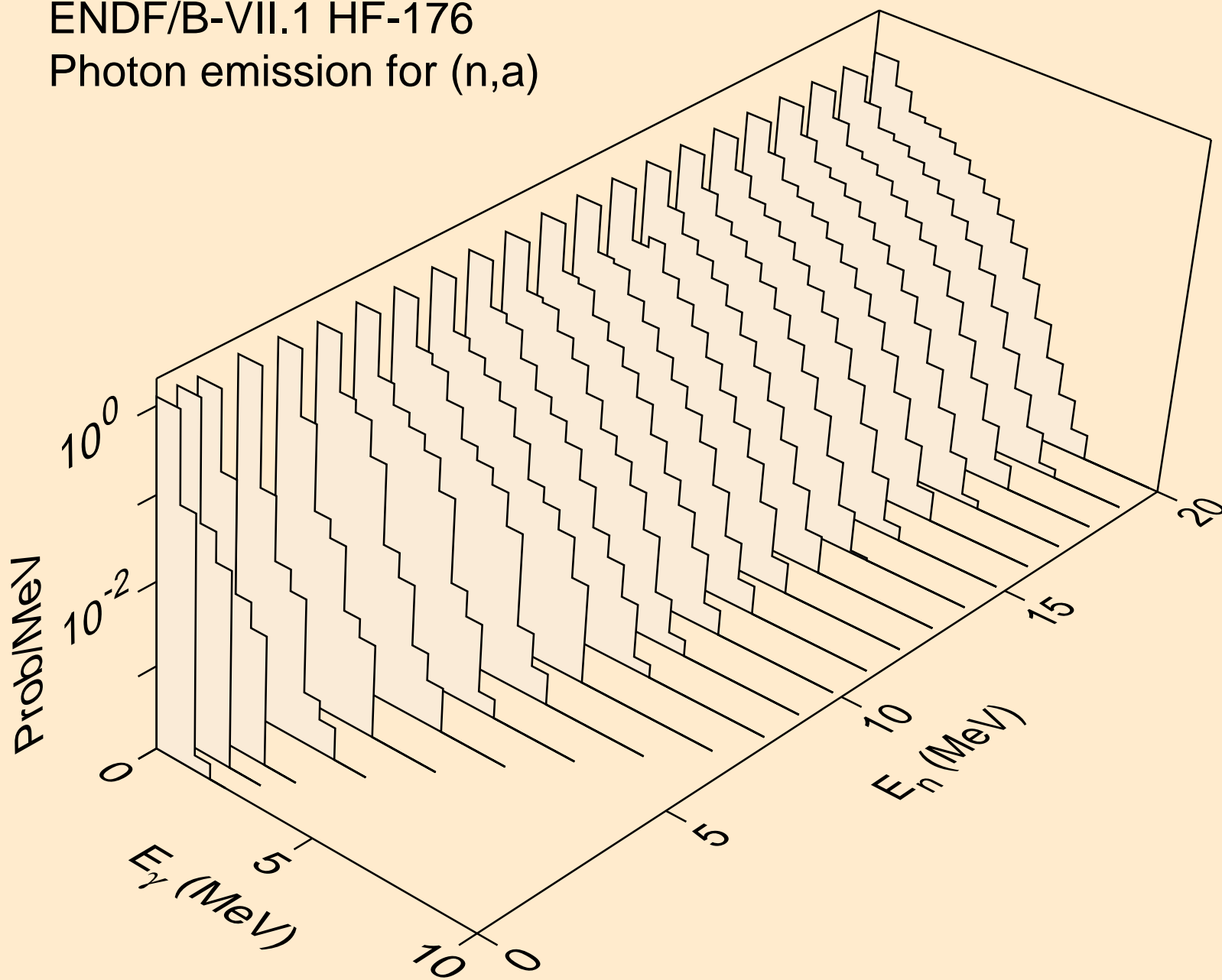

ENDF/B-VII.1 HF-176
thermal capture photon spectrum

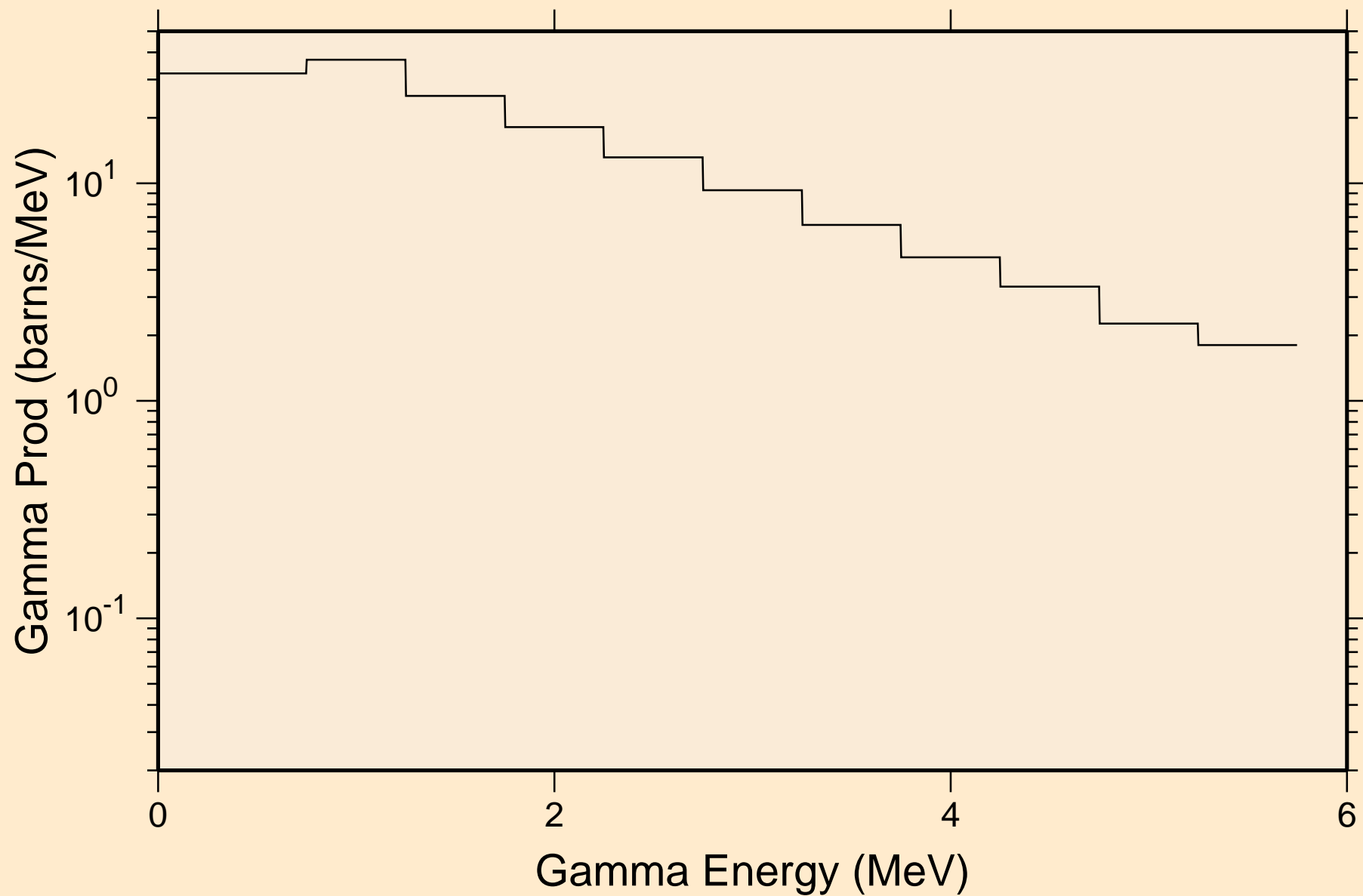

ENDF/B-VII.1 HF-176
14 MeV photon spectrum

