

# ENDF/B-VII.1 GD-154

## Principal cross sections

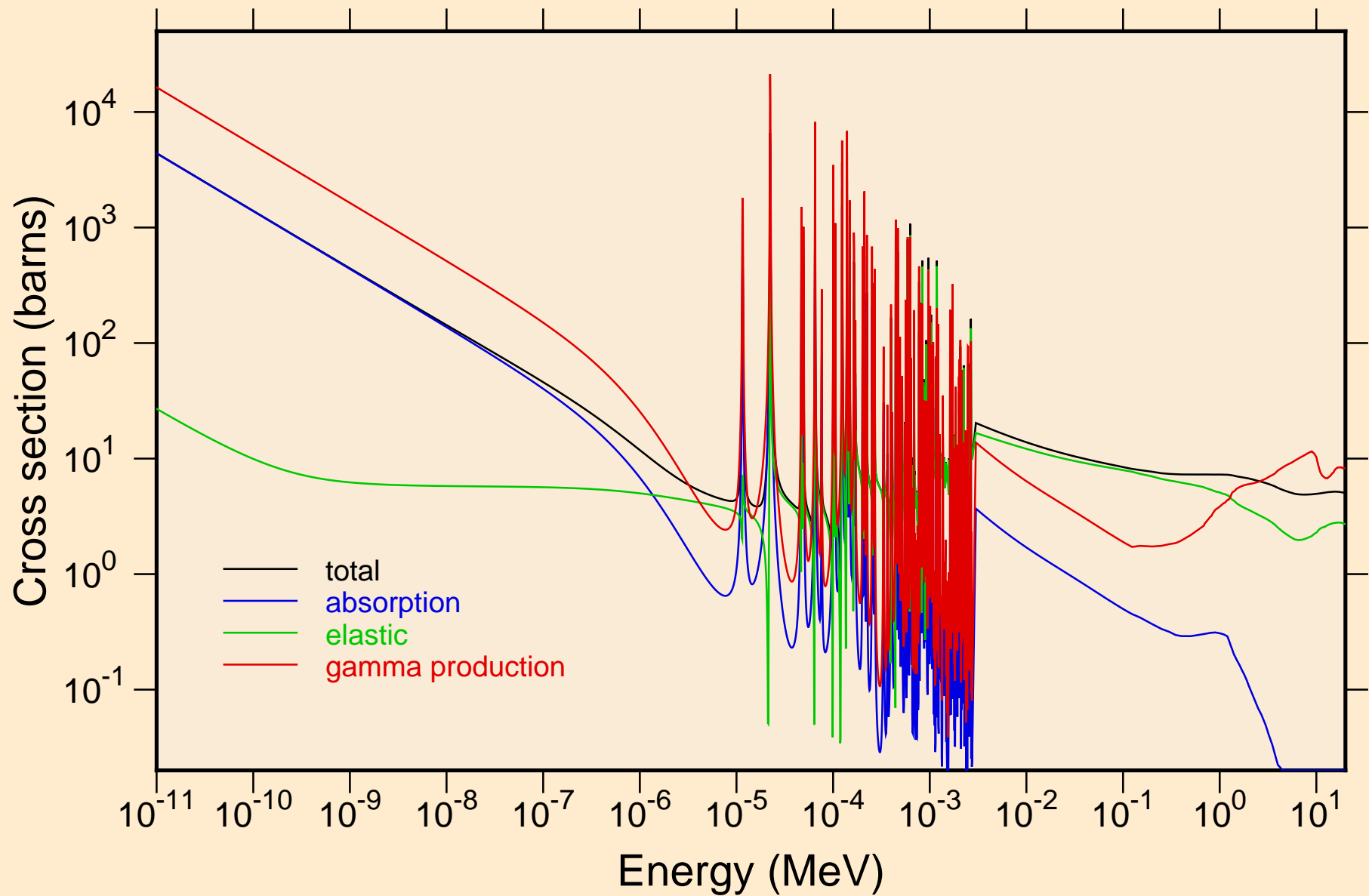

ENDF/B-VII.1 GD-154  
resonance total cross section

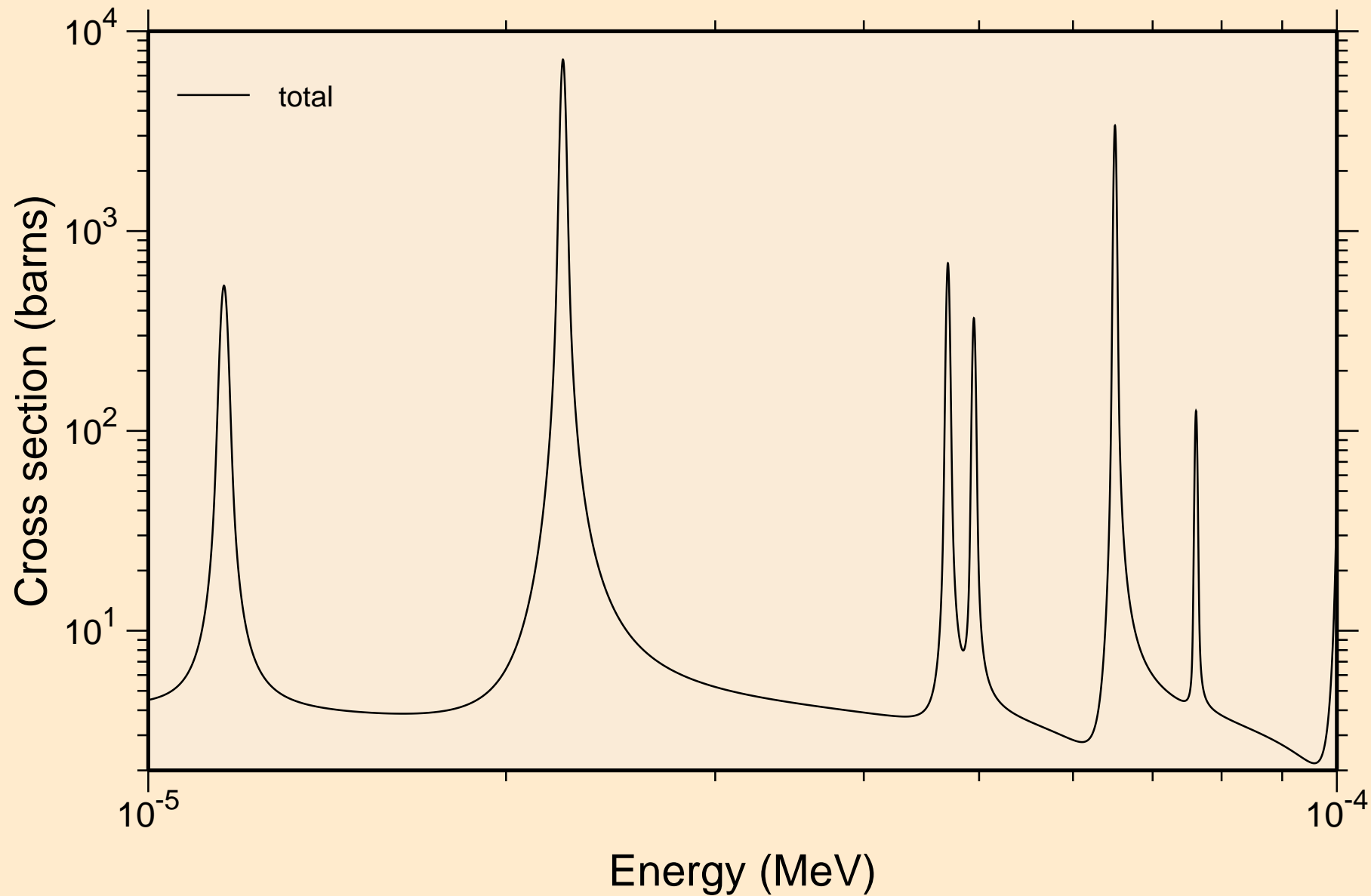

ENDF/B-VII.1 GD-154  
resonance total cross section

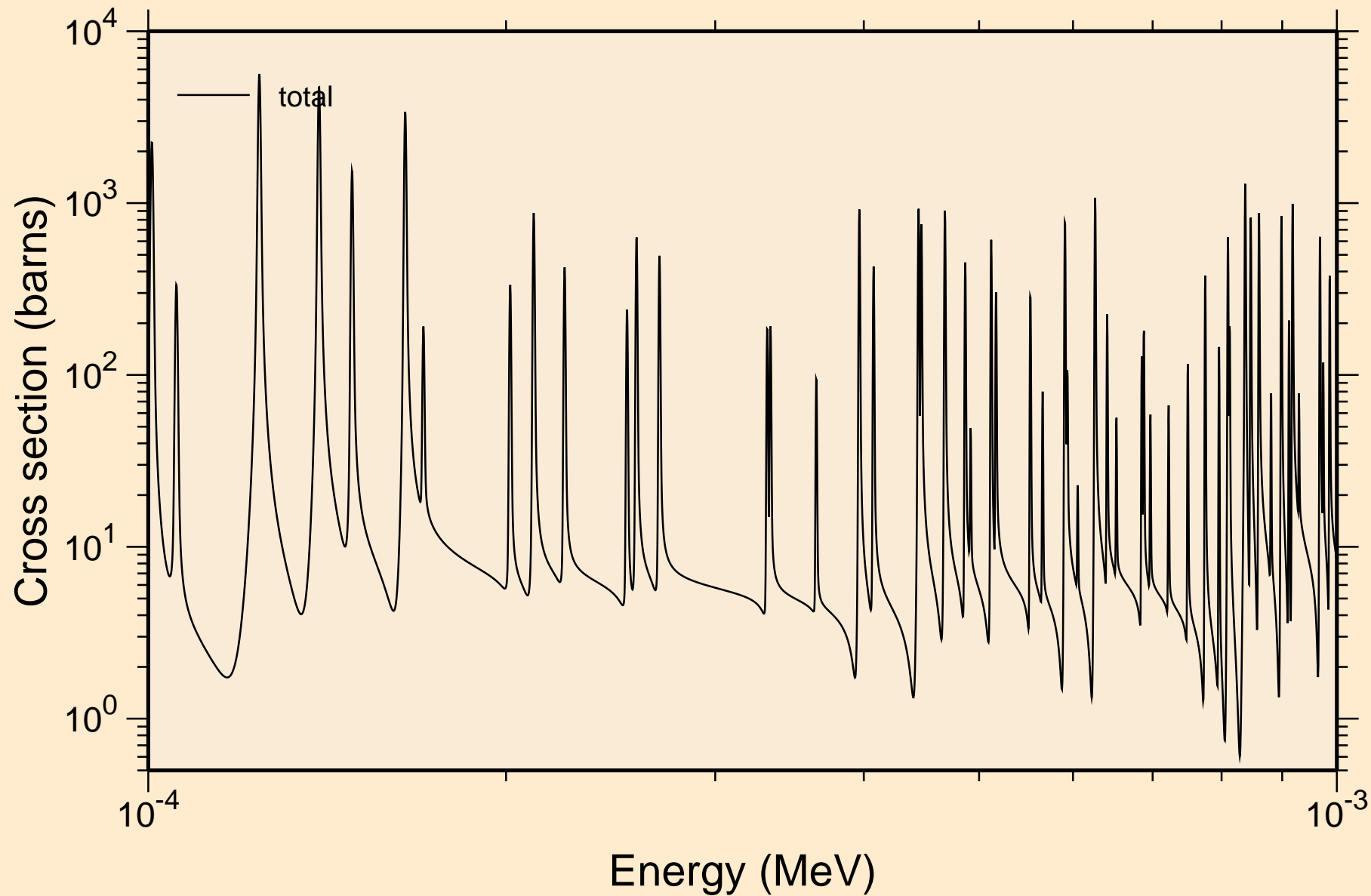

ENDF/B-VII.1 GD-154  
resonance total cross section

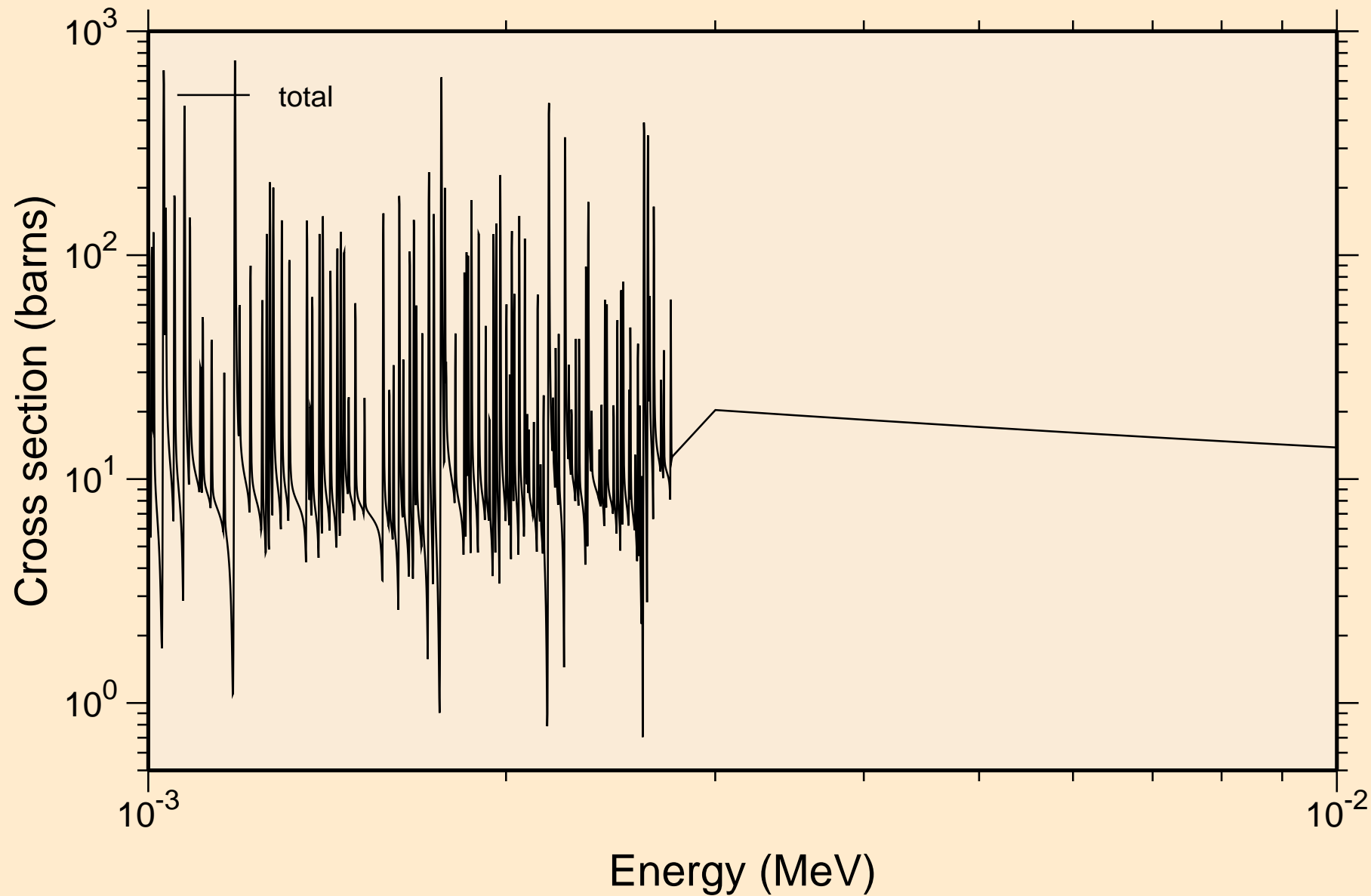

ENDF/B-VII.1 GD-154  
resonance total cross section

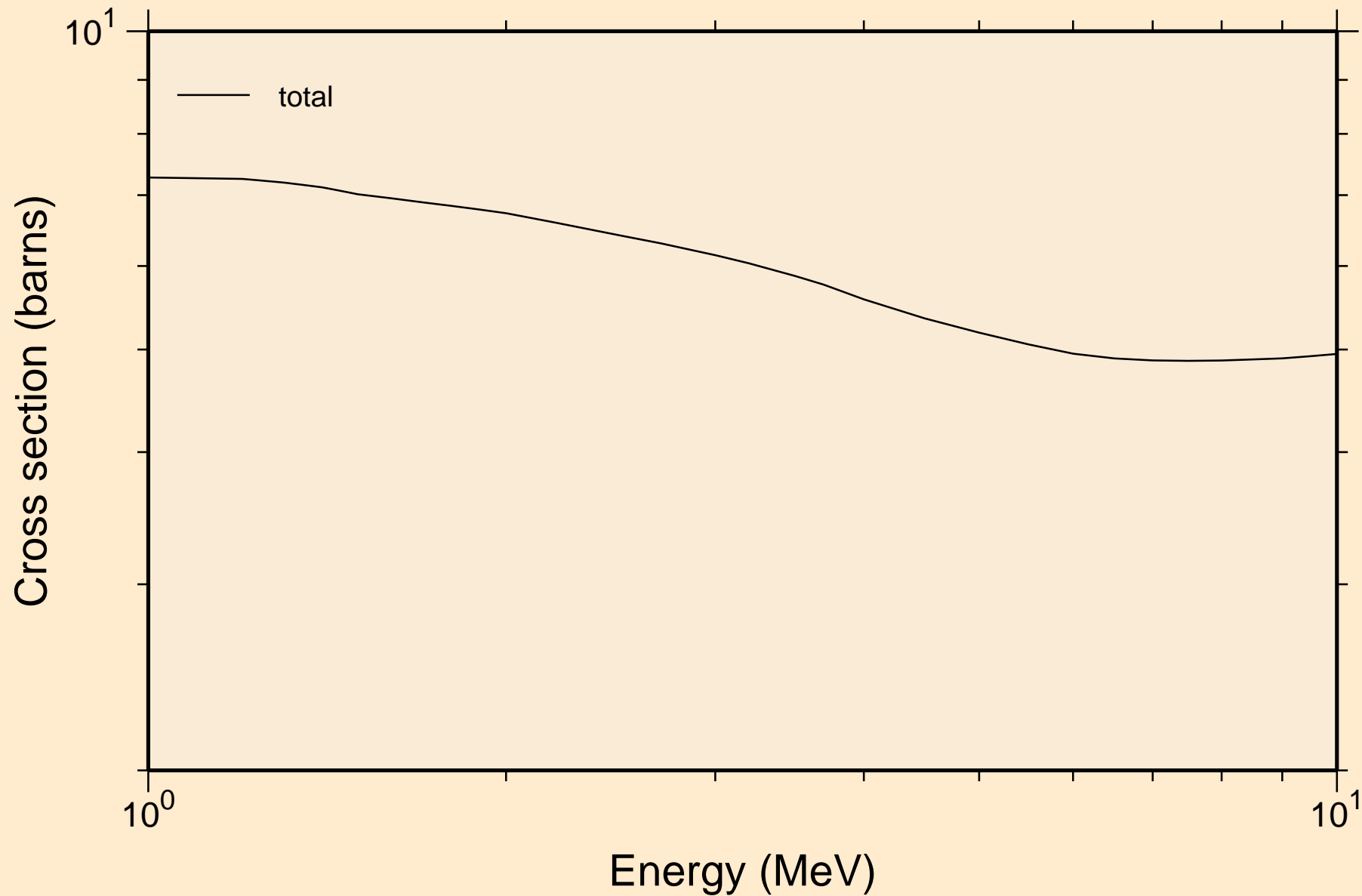

# ENDF/B-VII.1 GD-154 resonance absorption cross sections

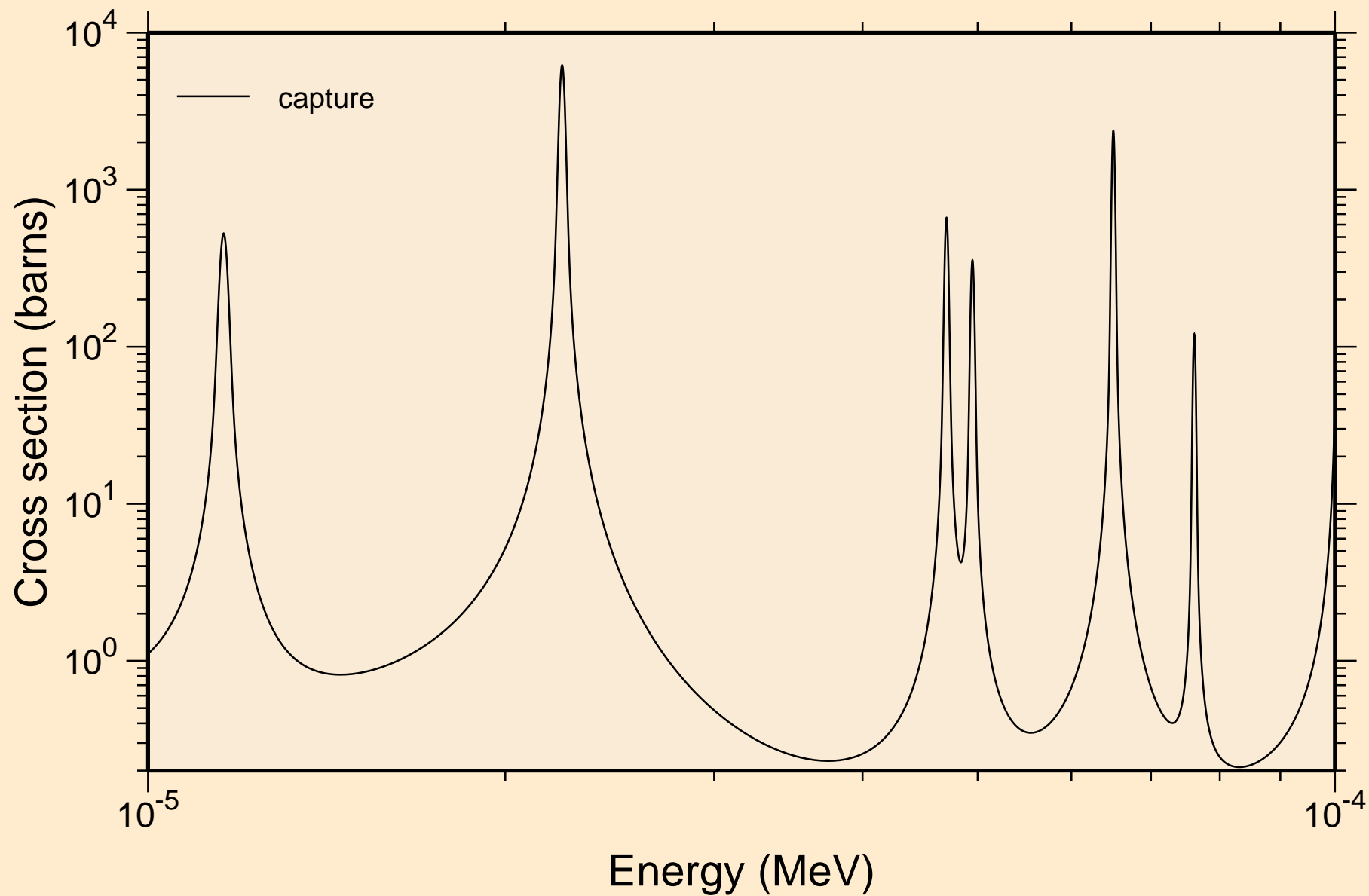

ENDF/B-VII.1 GD-154  
resonance absorption cross sections

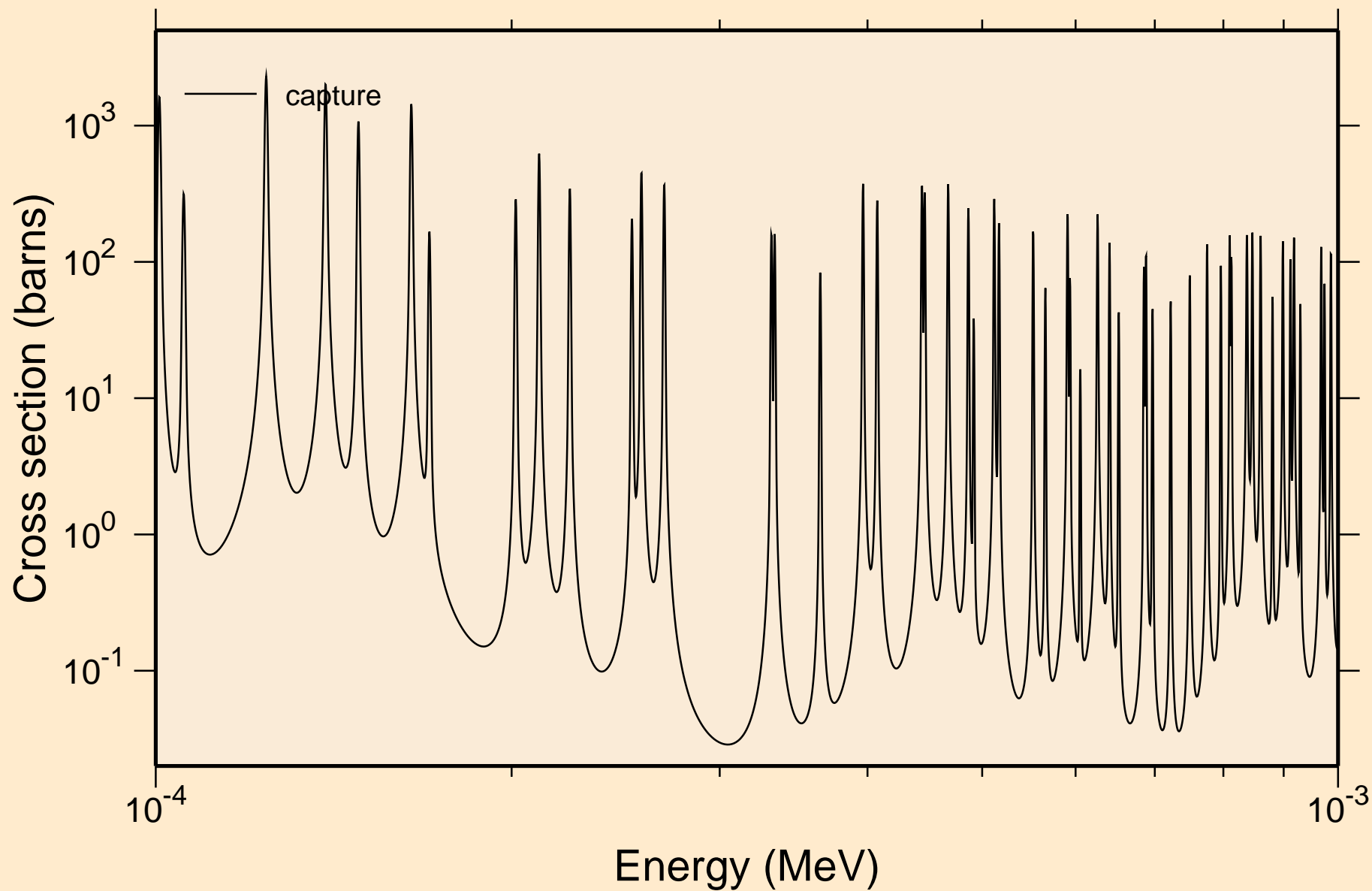

ENDF/B-VII.1 GD-154  
resonance absorption cross sections

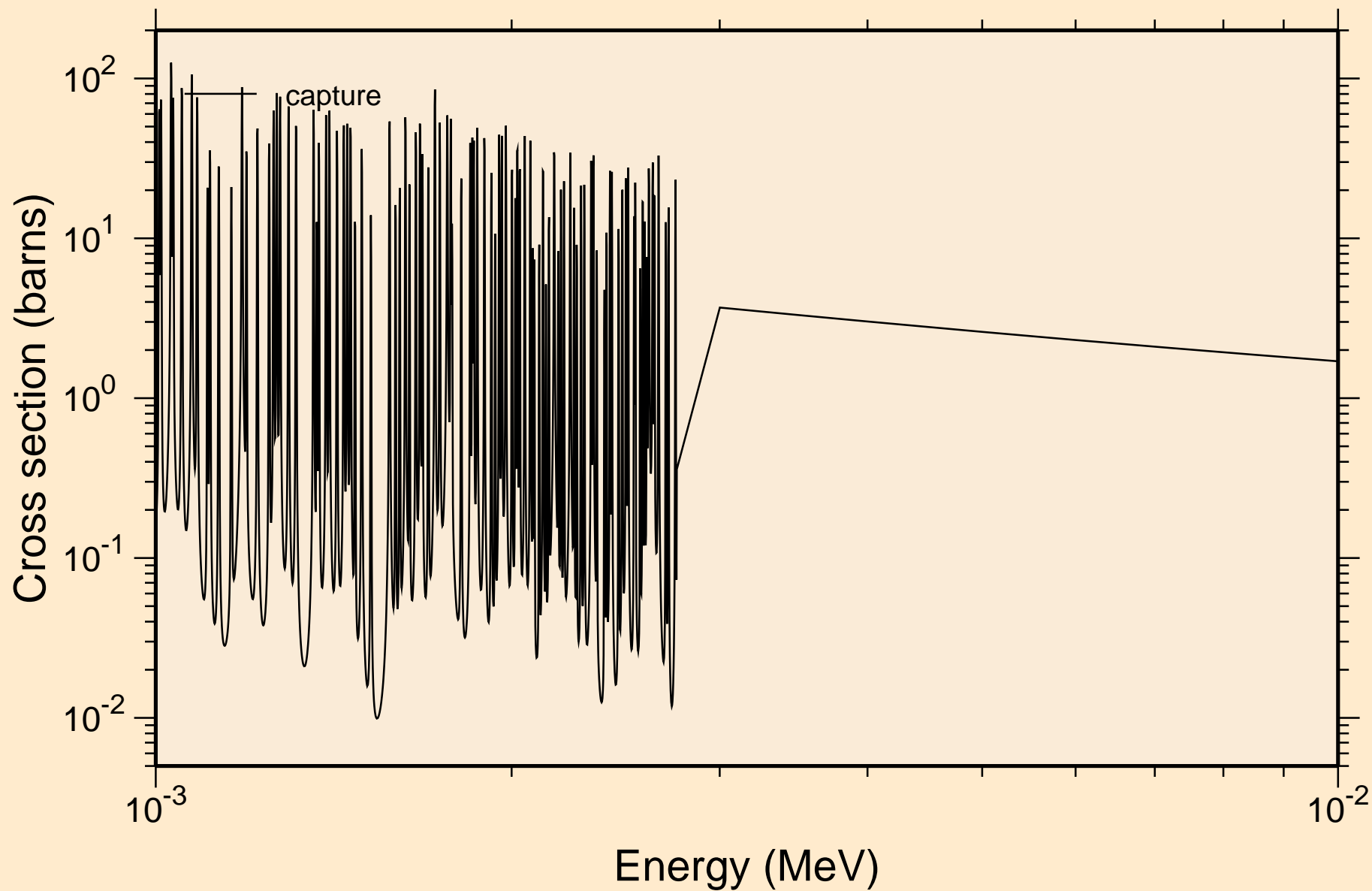



ENDF/B-VII.1 GD-154  
resonance absorption cross sections

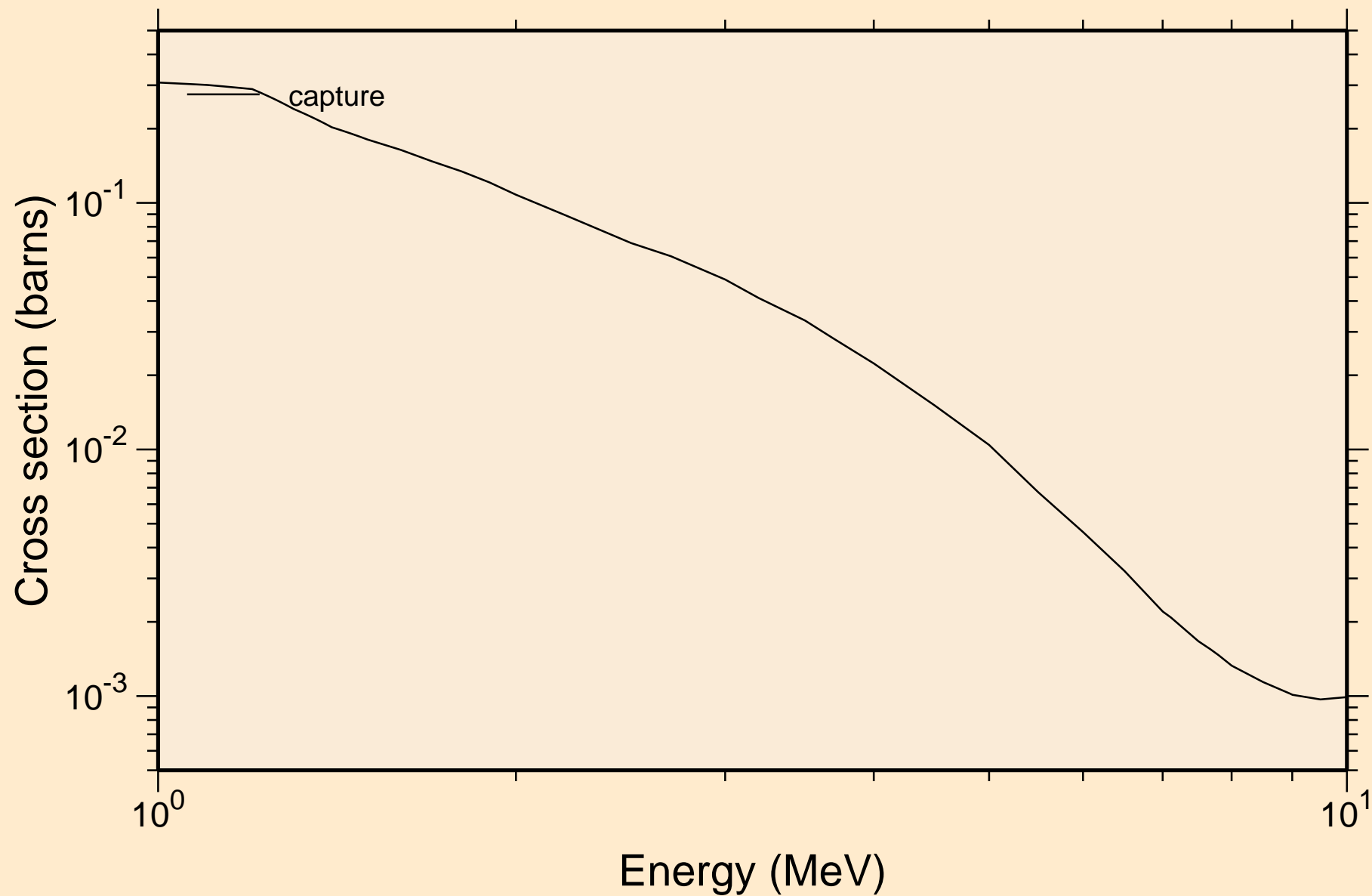

ENDF/B-VII.1 GD-154  
UR total cross section

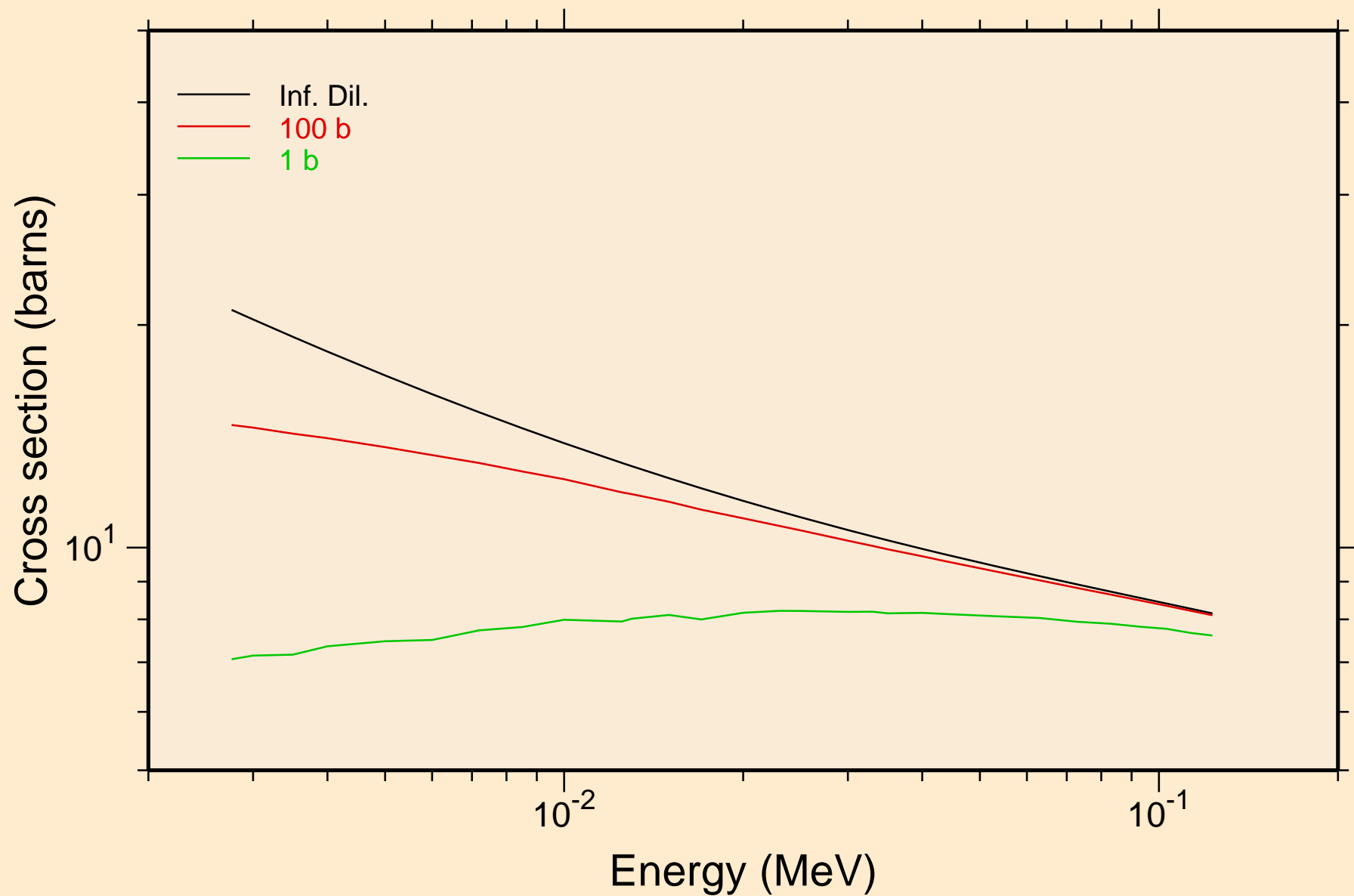

ENDF/B-VII.1 GD-154  
UR elastic cross section

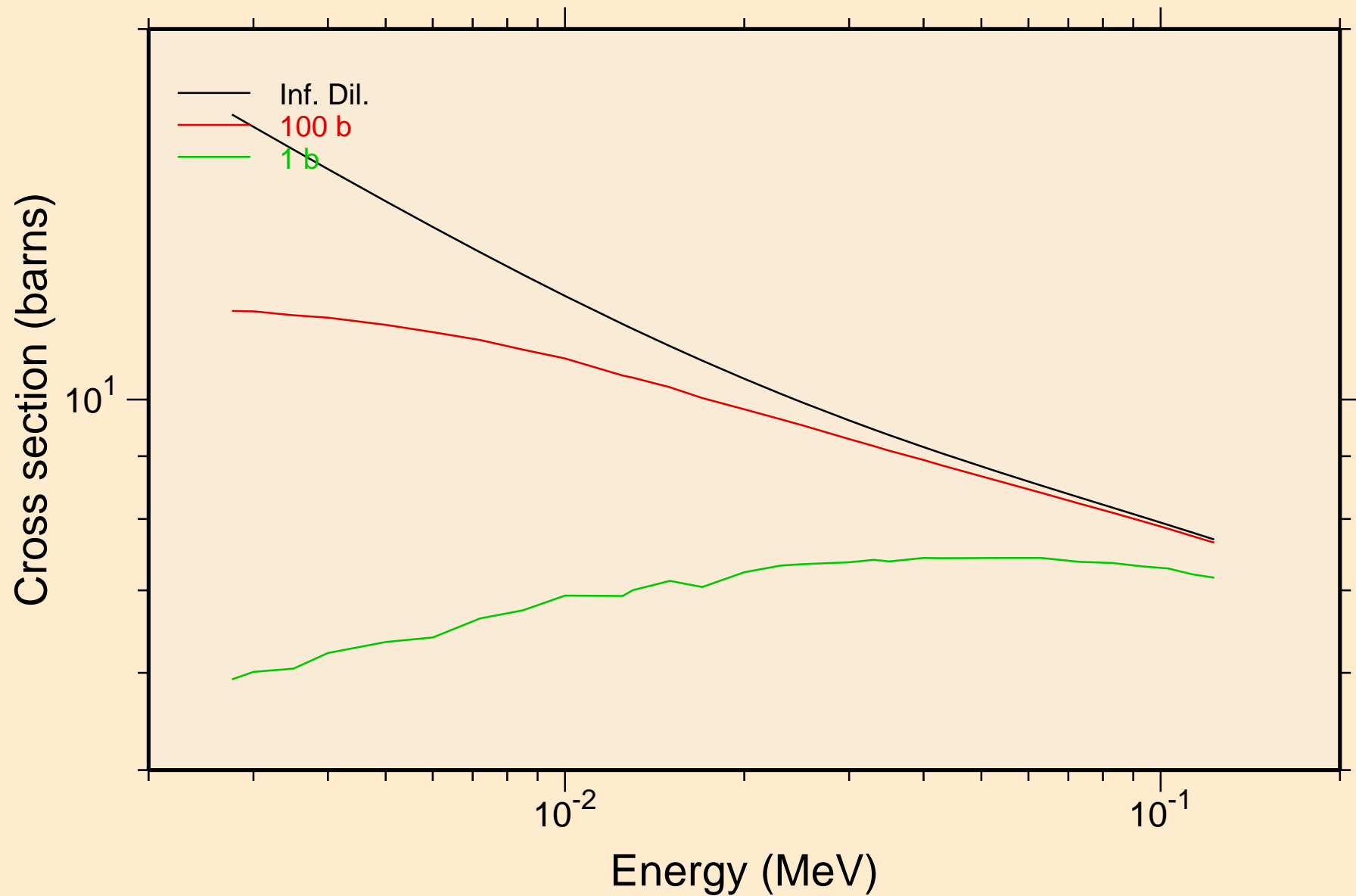

ENDF/B-VII.1 GD-154  
UR capture cross section

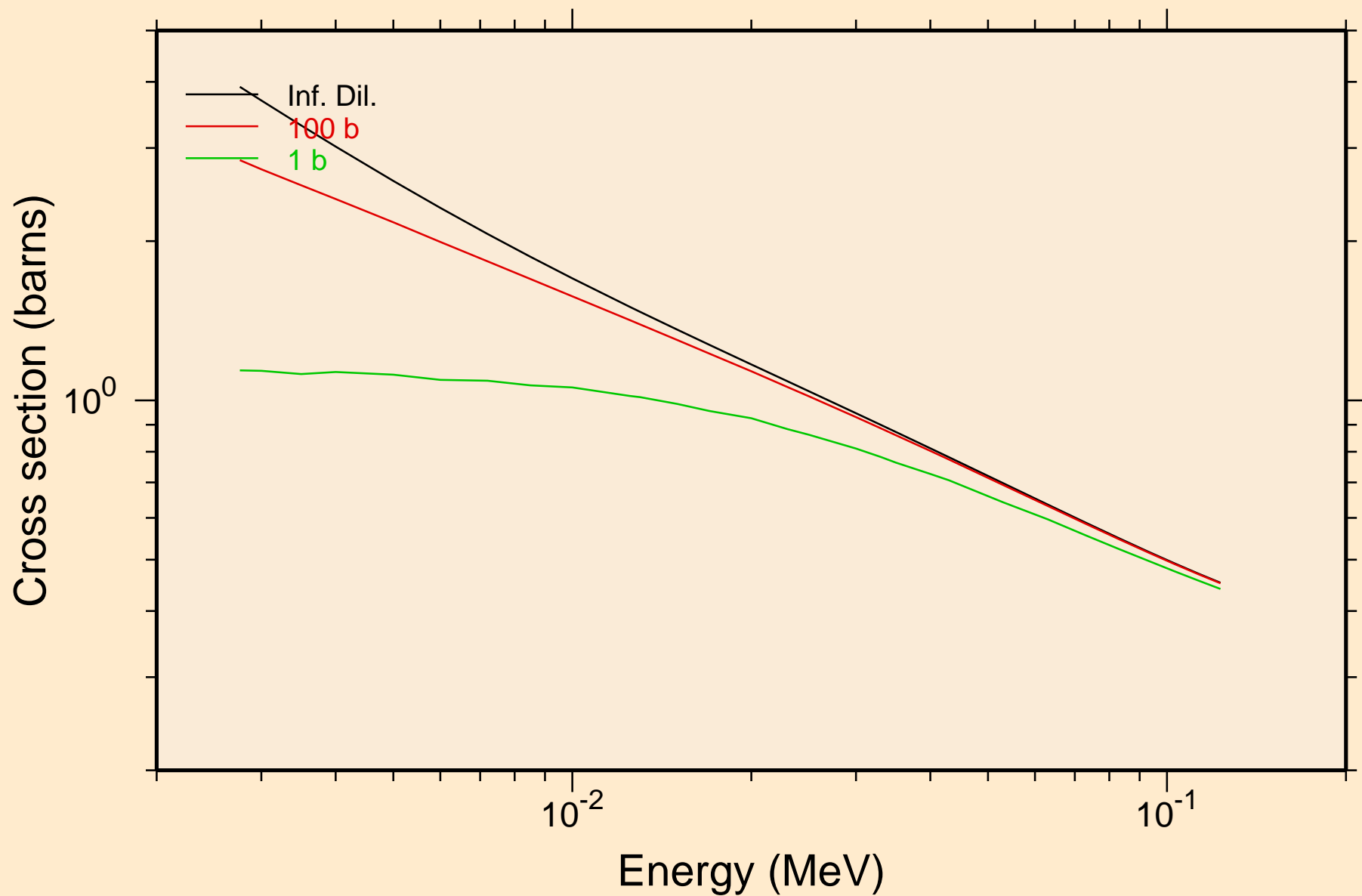

# ENDF/B-VII.1 GD-154

## Heating

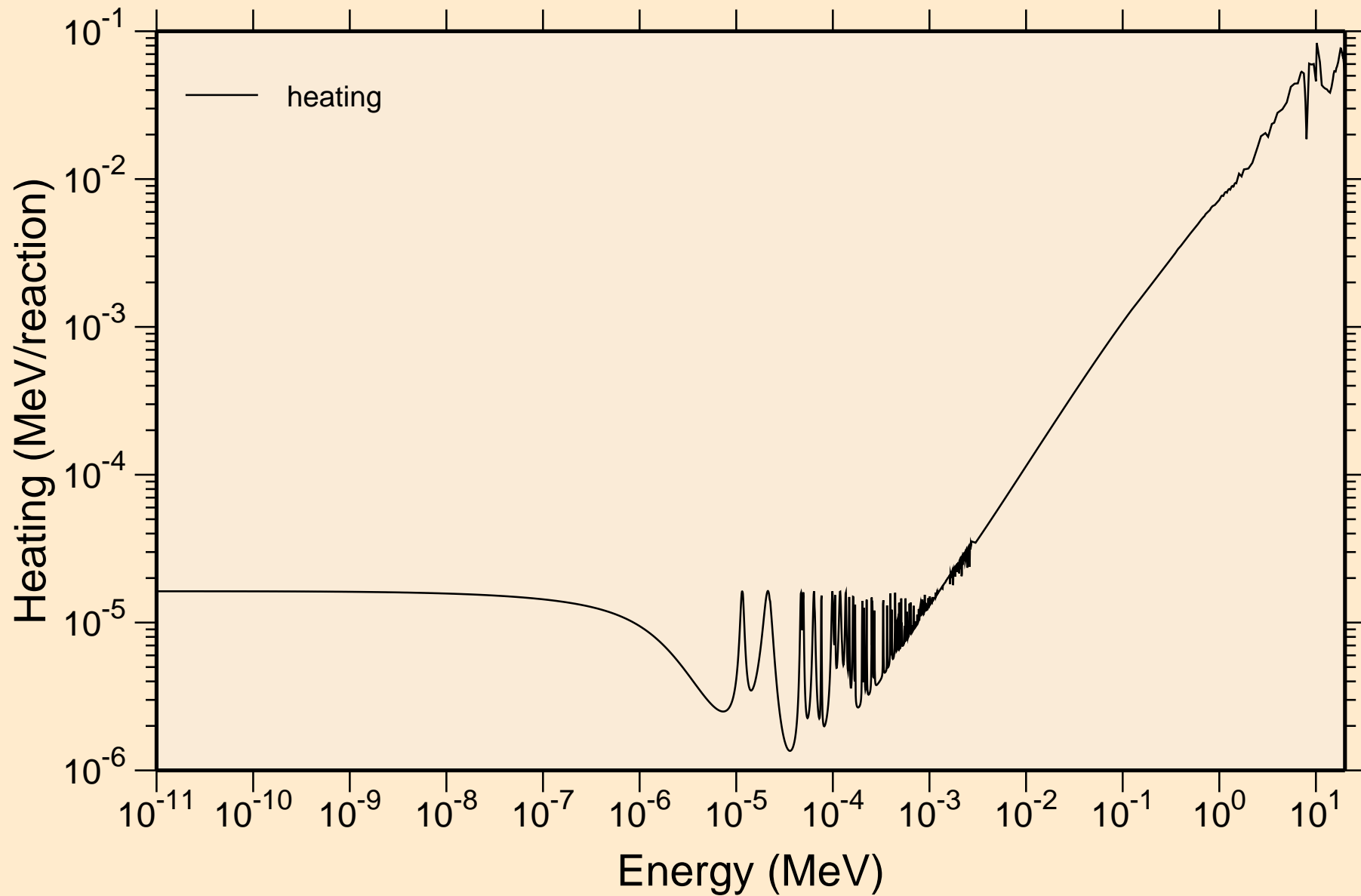

# ENDF/B-VII.1 GD-154 Damage

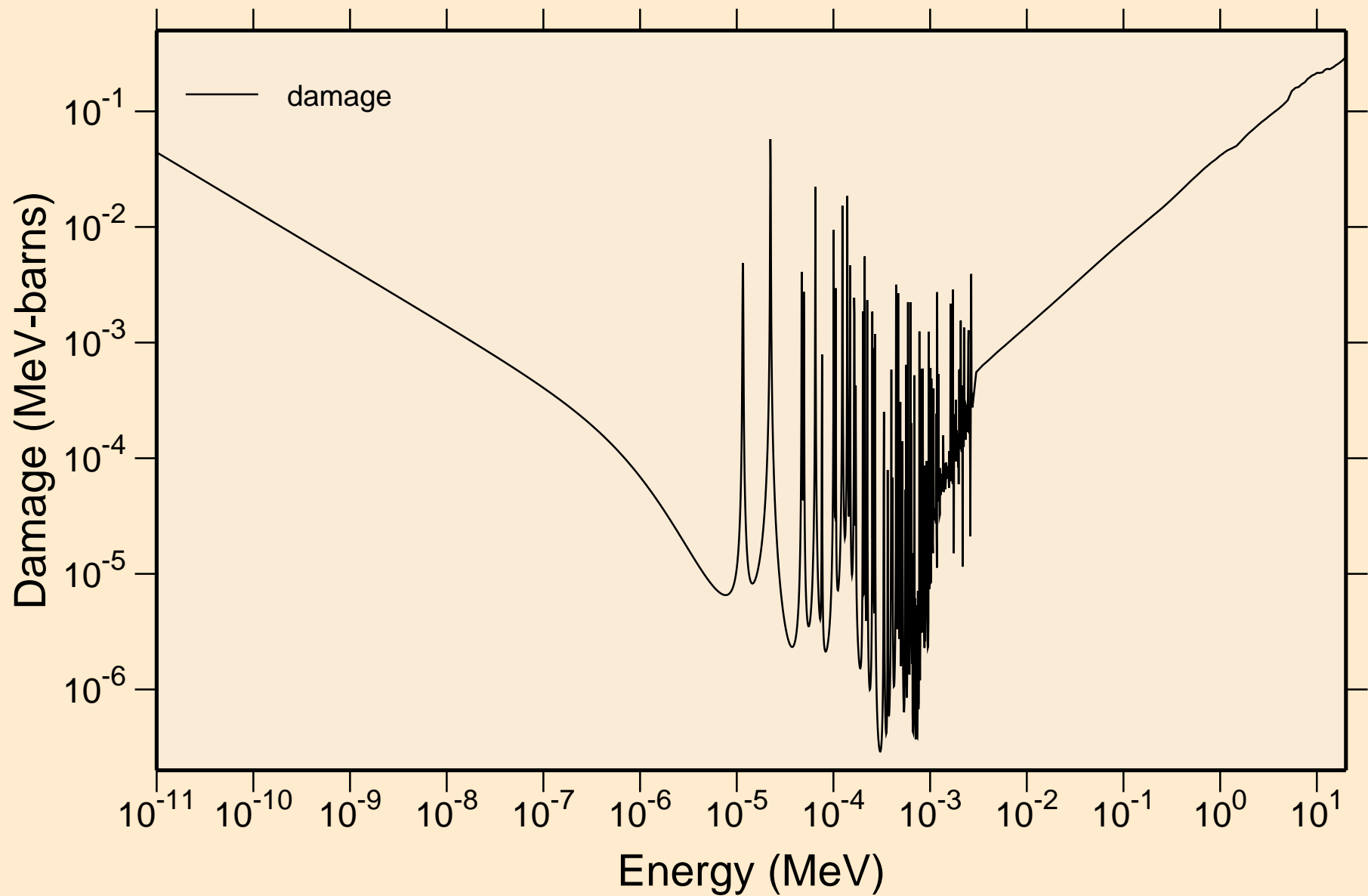

ENDF/B-VII.1 GD-154  
Non-threshold reactions

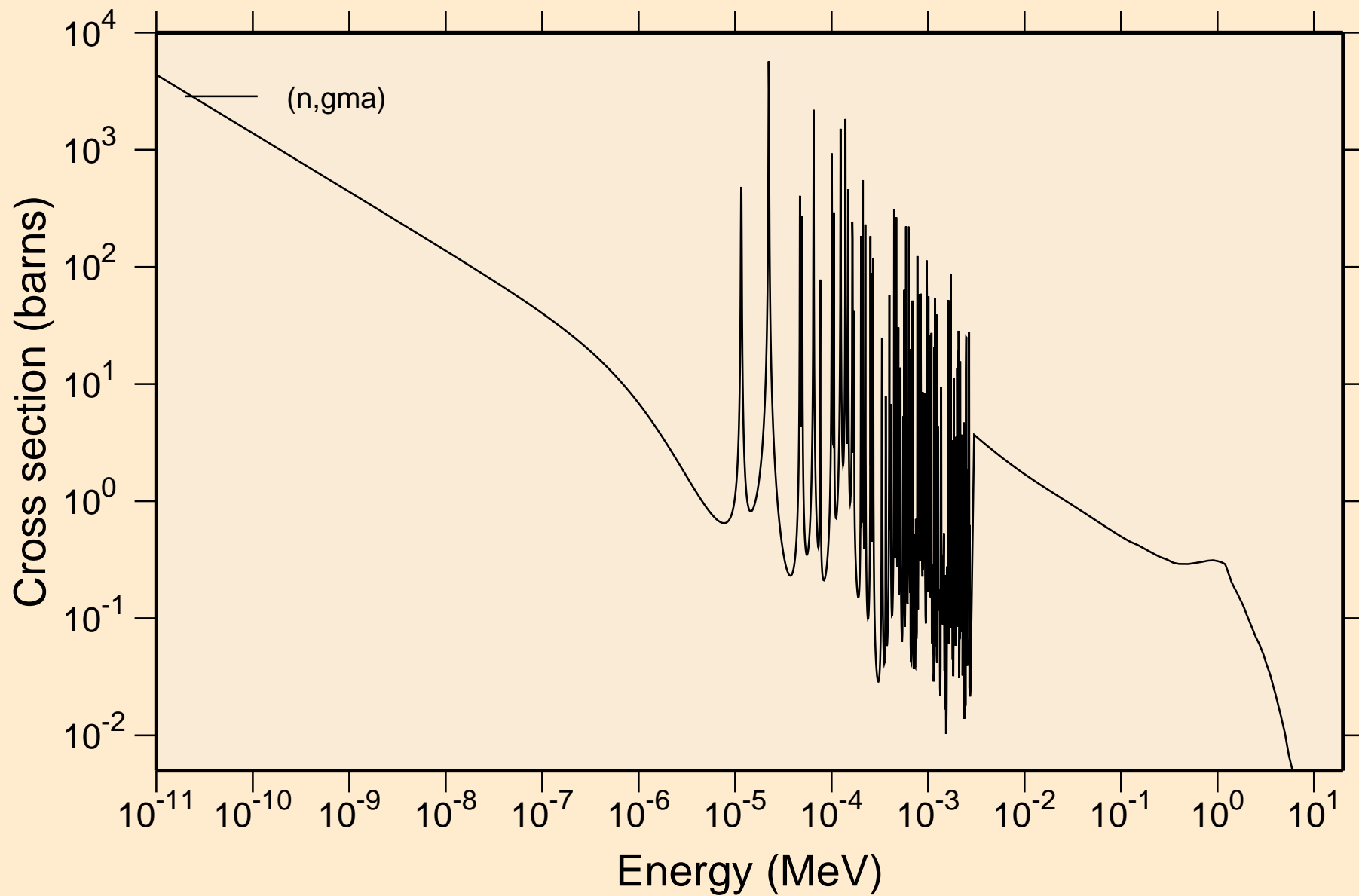

ENDF/B-VII.1 GD-154  
Principal cross sections

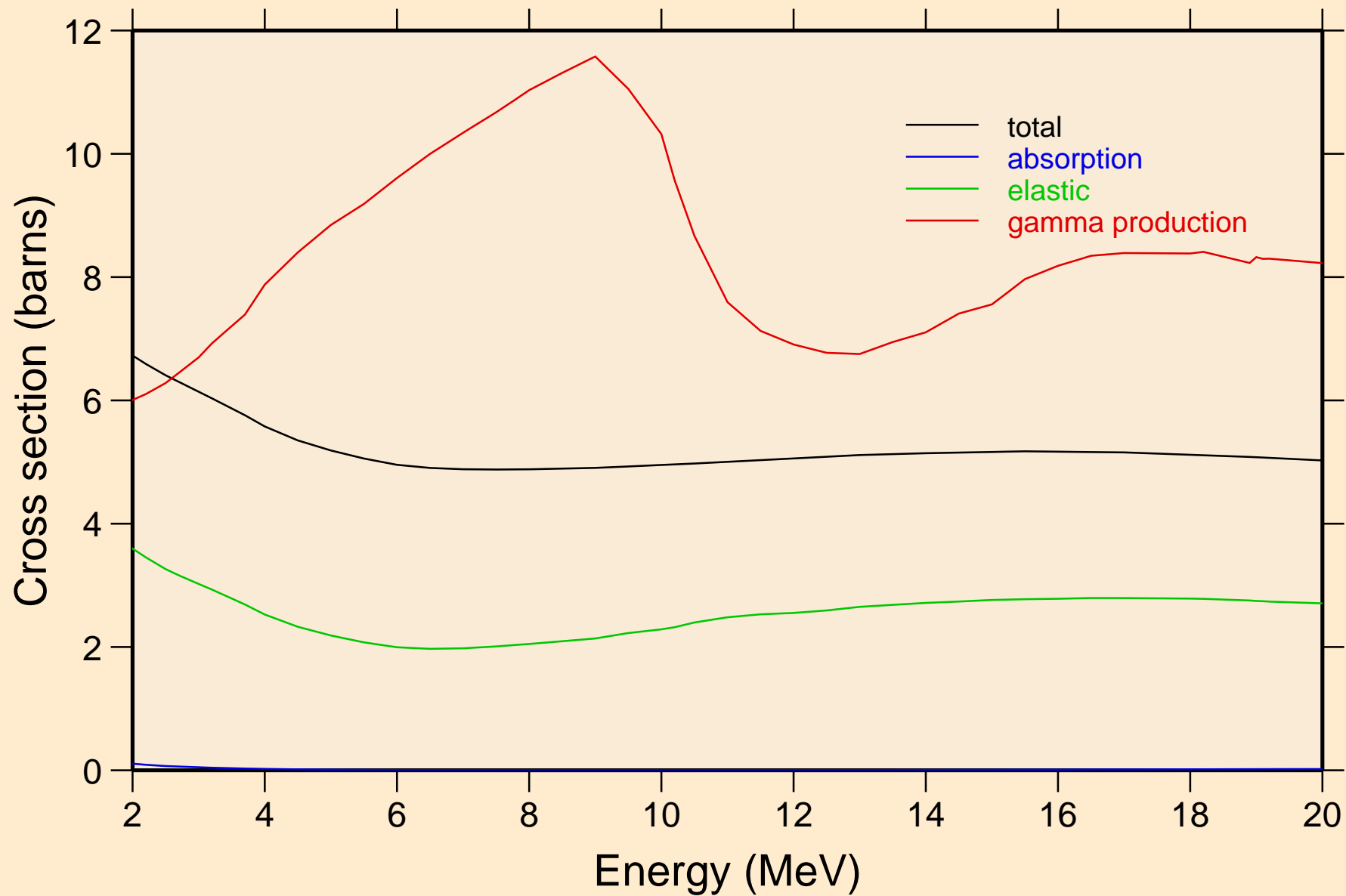



# ENDF/B-VII.1 GD-154

## Heating

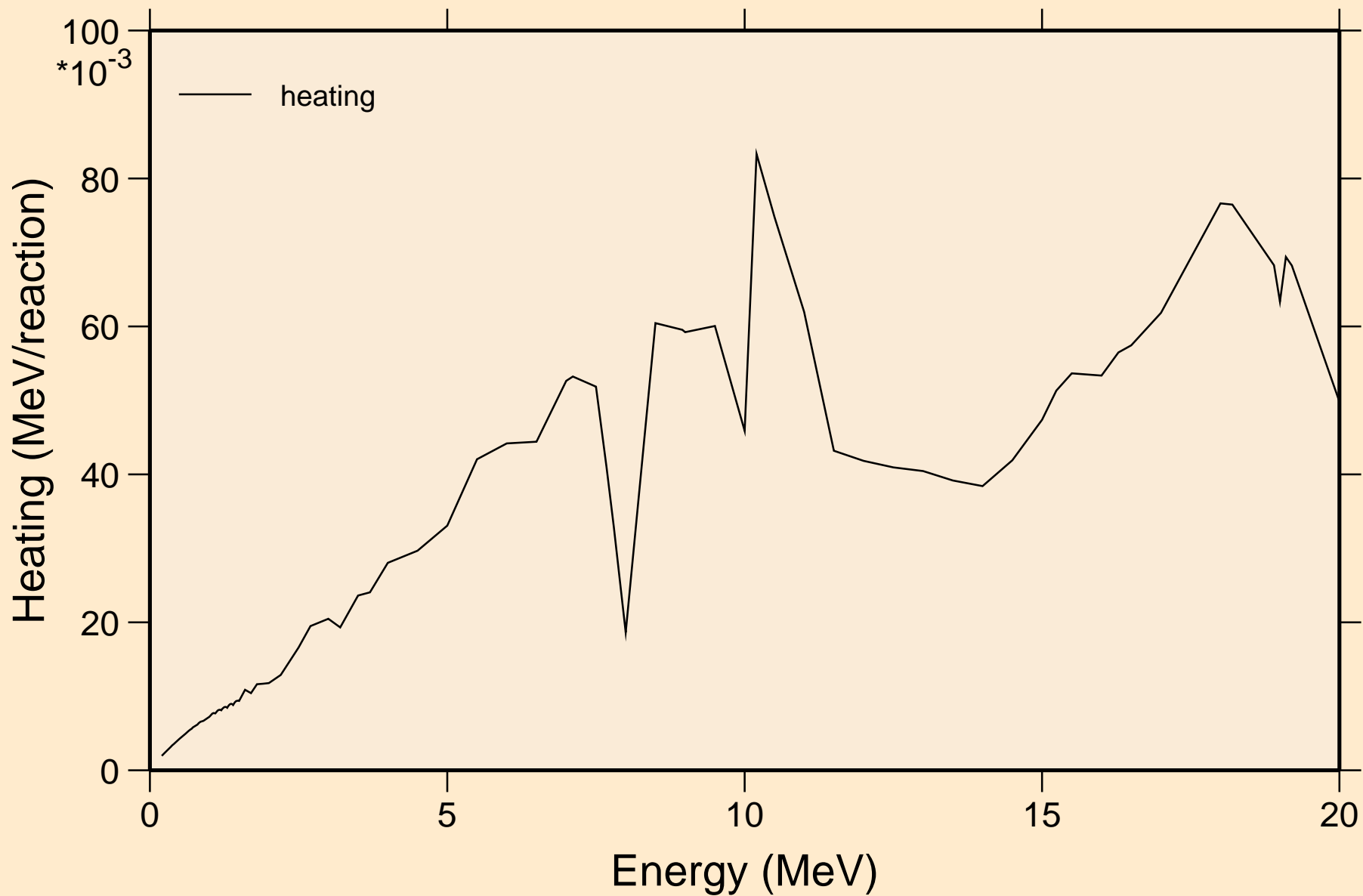

# ENDF/B-VII.1 GD-154

## Damage

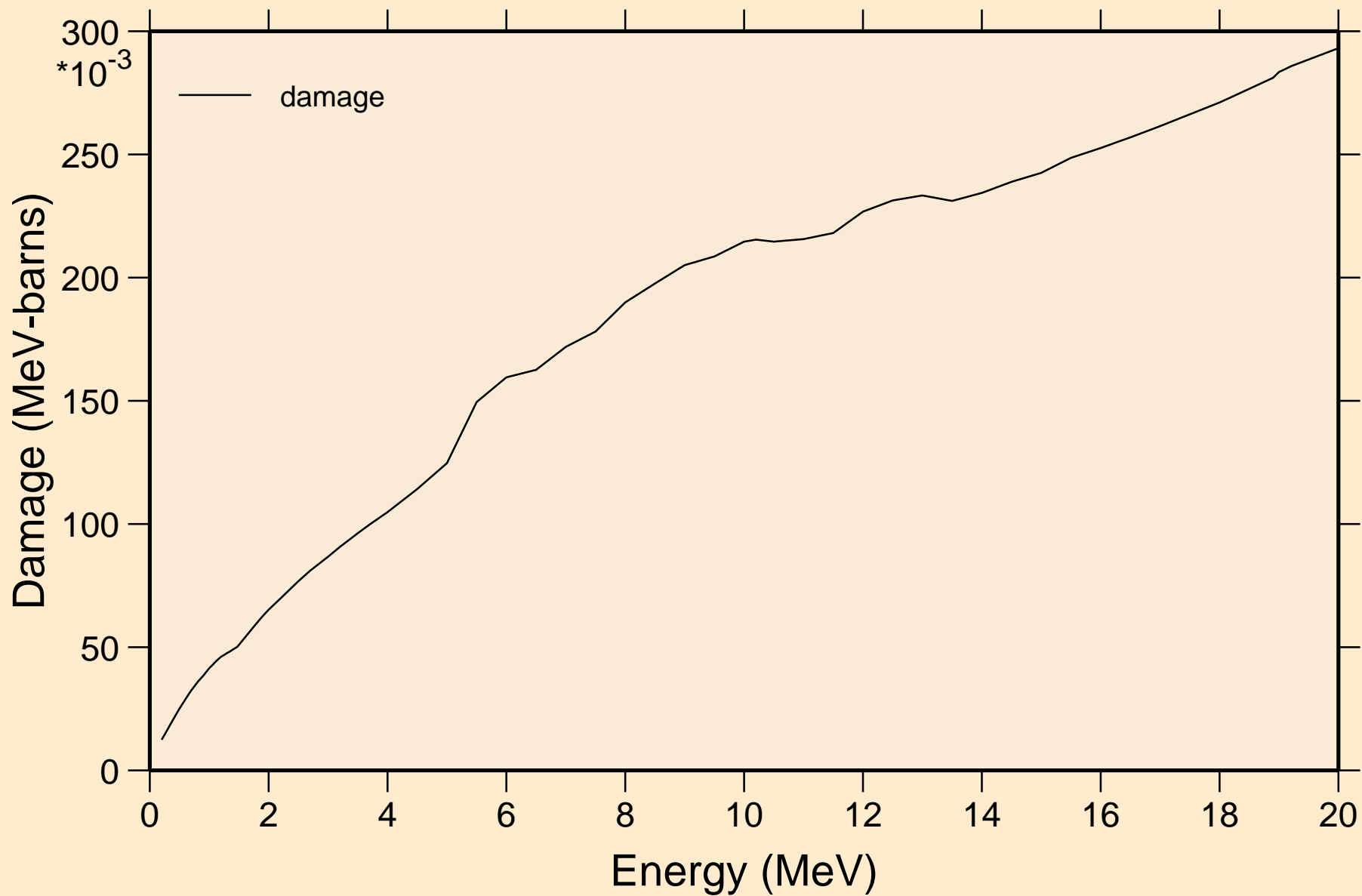

ENDF/B-VII.1 GD-154  
Non-threshold reactions

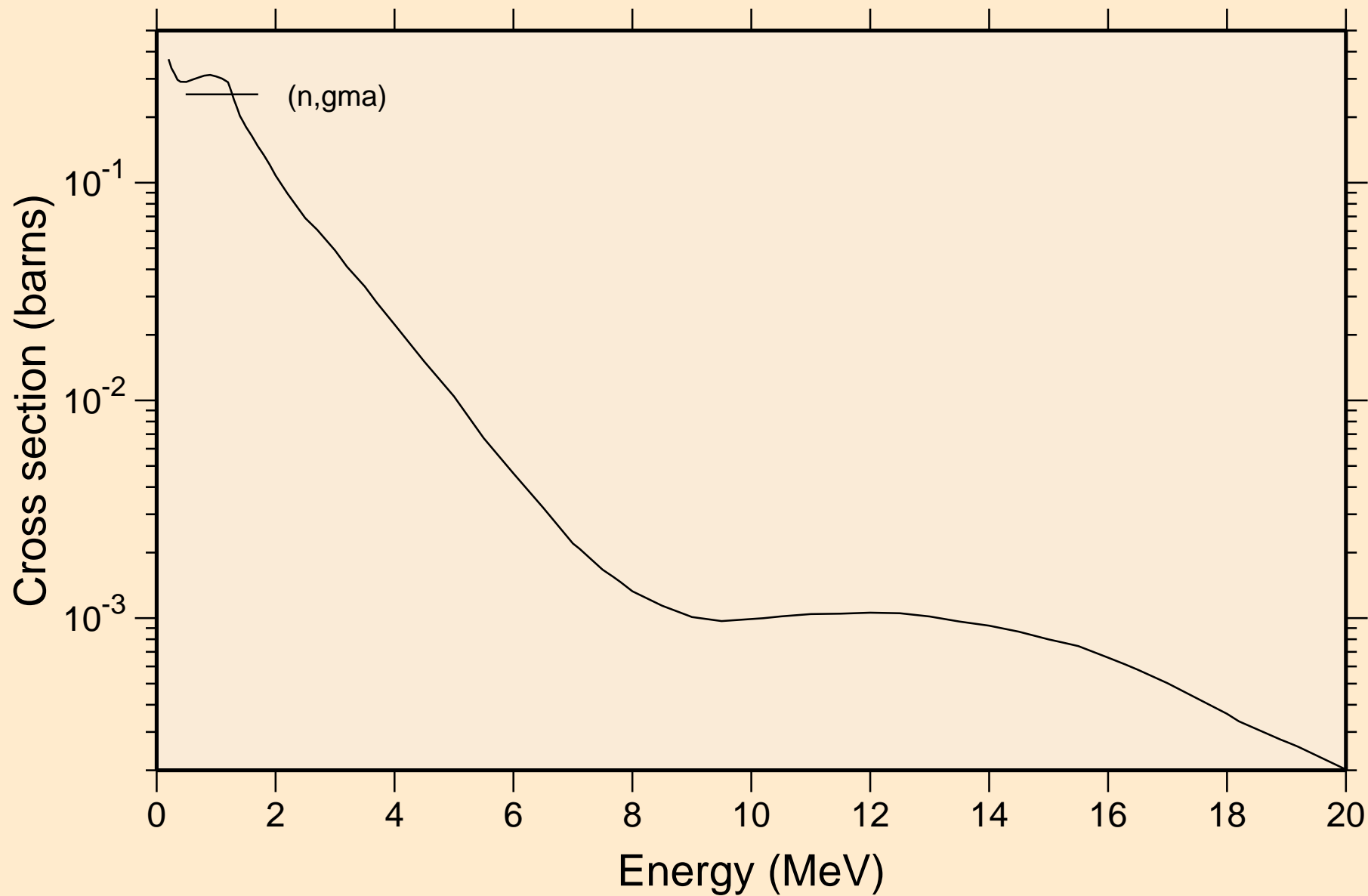

# ENDF/B-VII.1 GD-154

## Inelastic levels

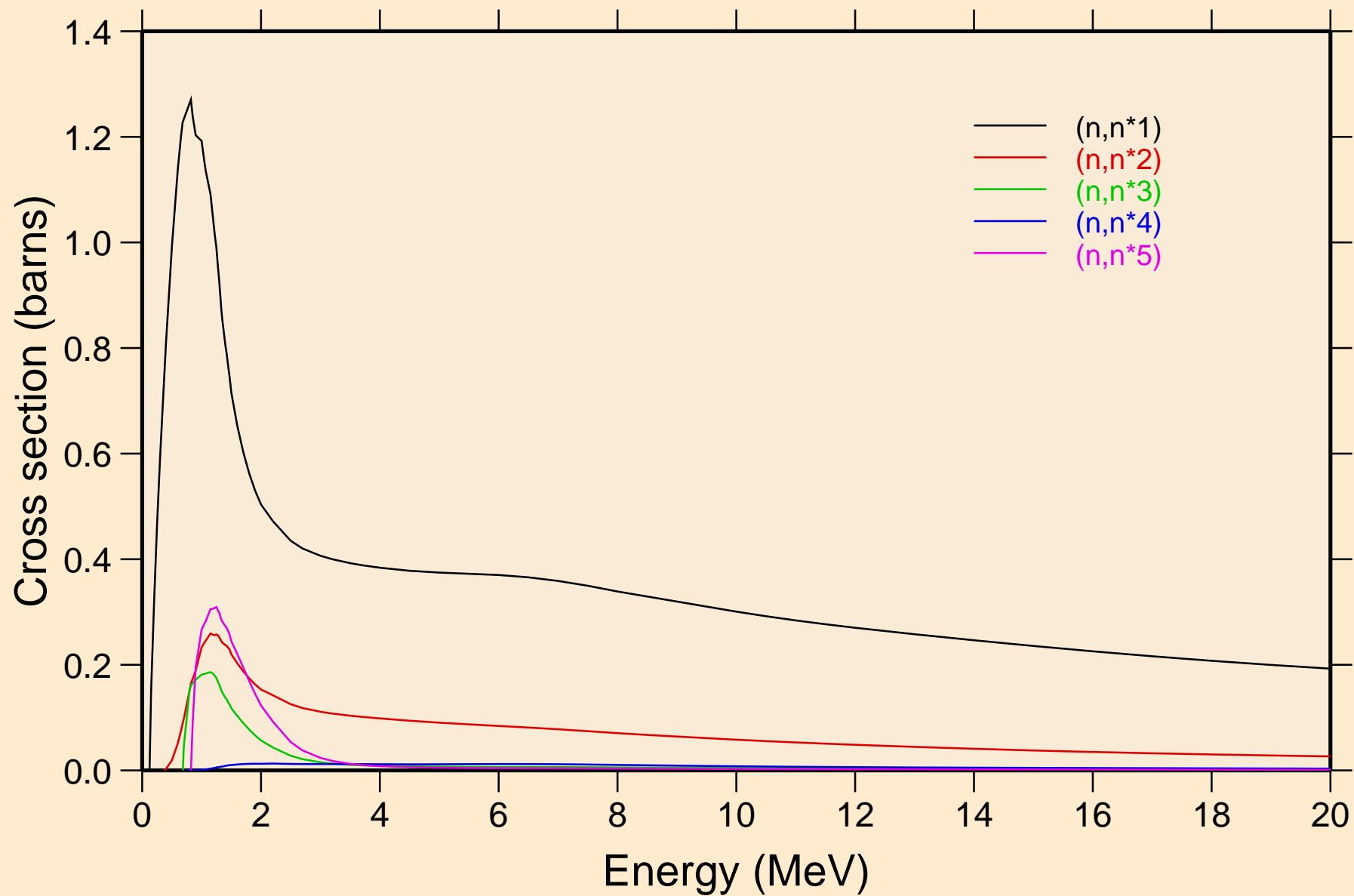

# ENDF/B-VII.1 GD-154

## Inelastic levels

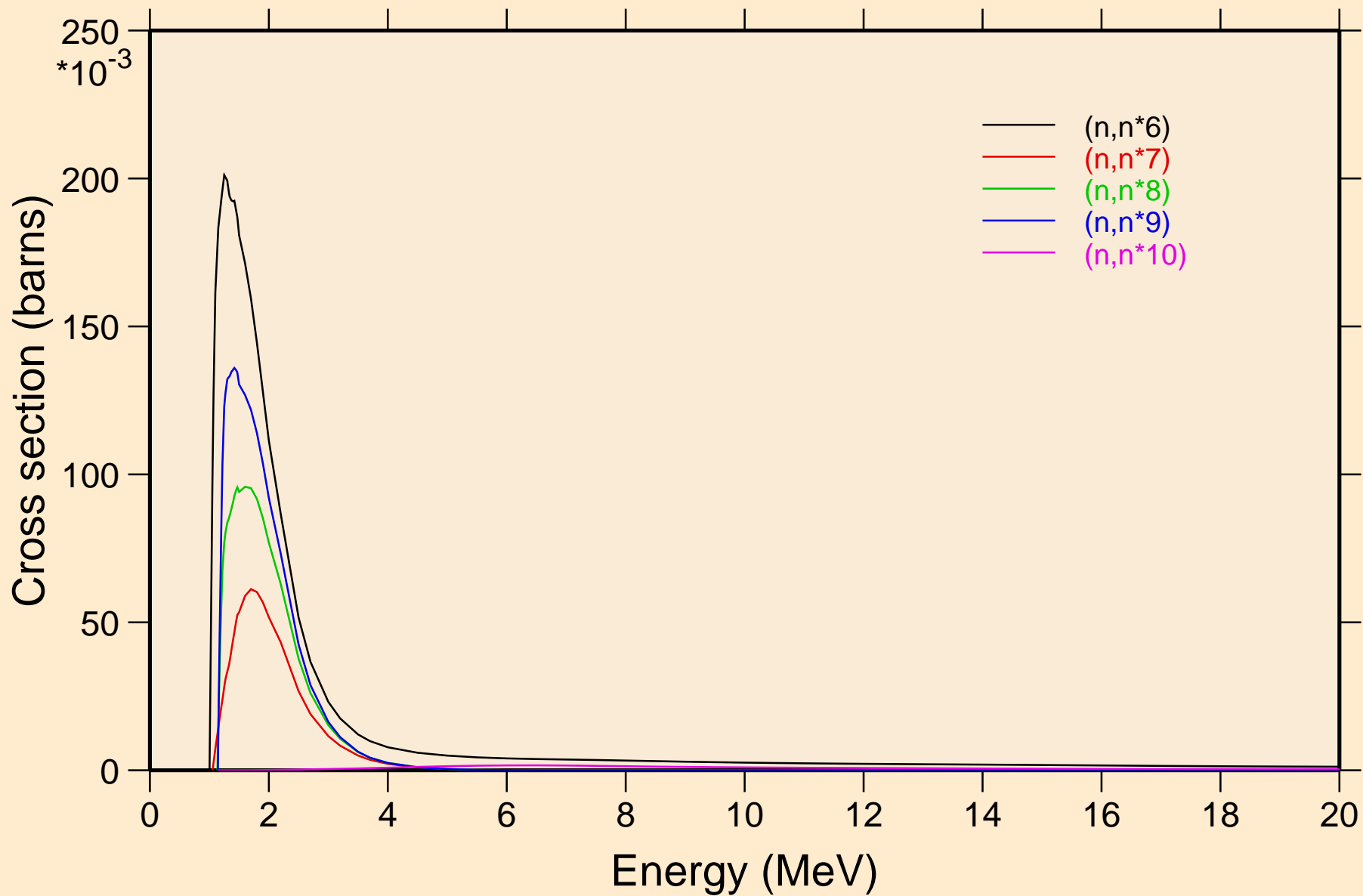

# ENDF/B-VII.1 GD-154

## Inelastic levels

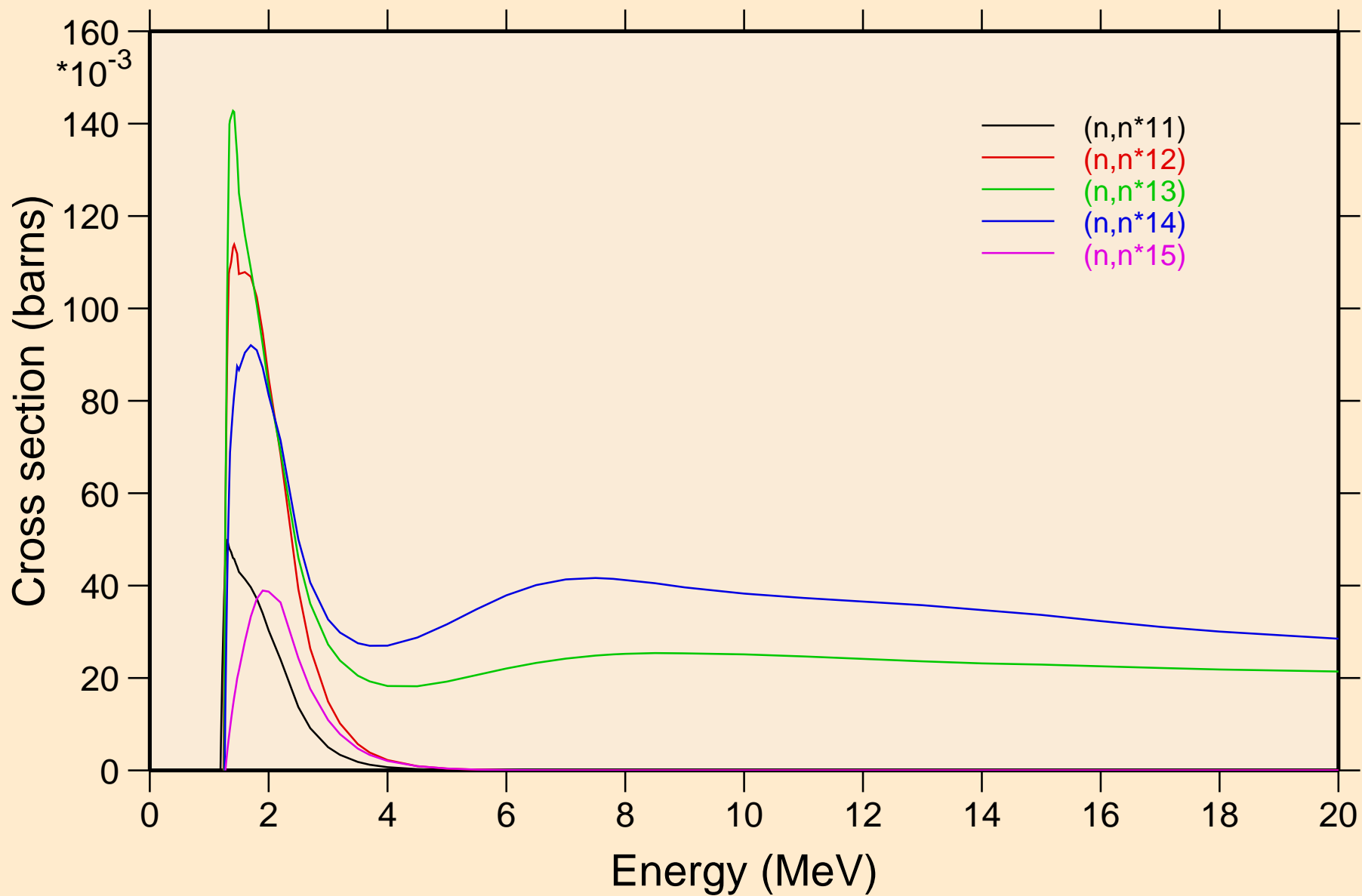

# ENDF/B-VII.1 GD-154

## Inelastic levels

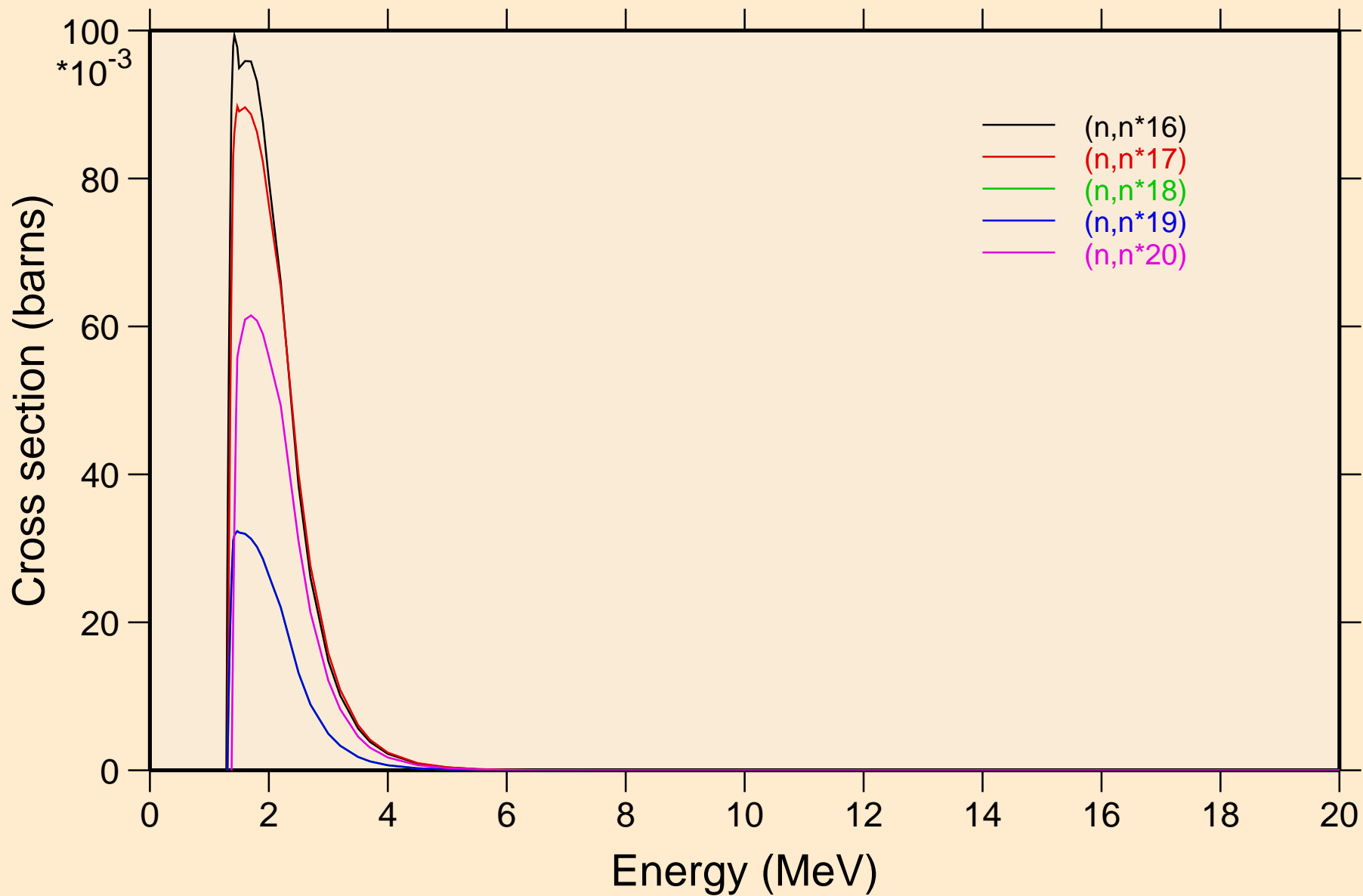

# ENDF/B-VII.1 GD-154

## Inelastic levels

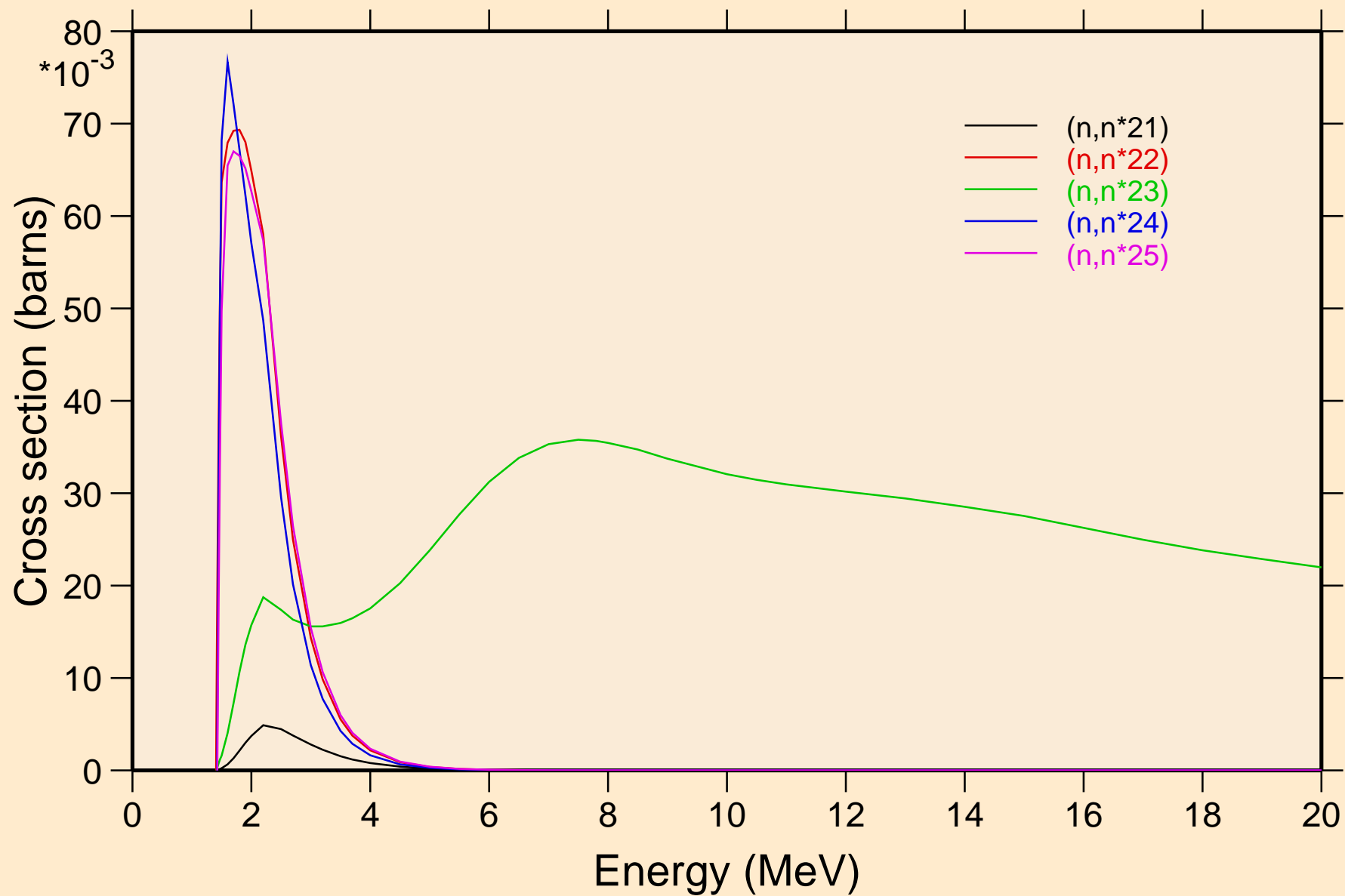



# ENDF/B-VII.1 GD-154

## Inelastic levels

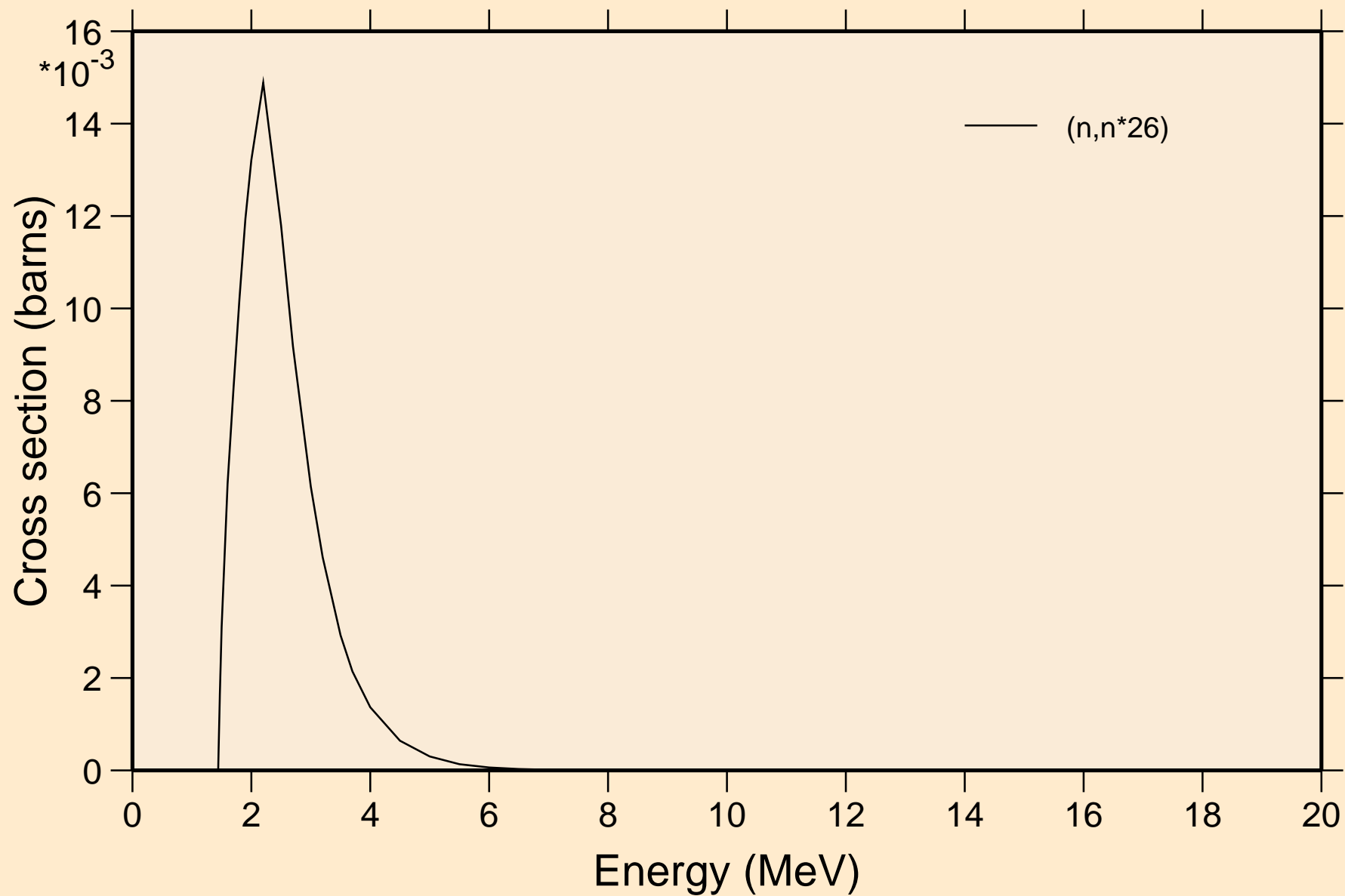

# ENDF/B-VII.1 GD-154

## Threshold reactions

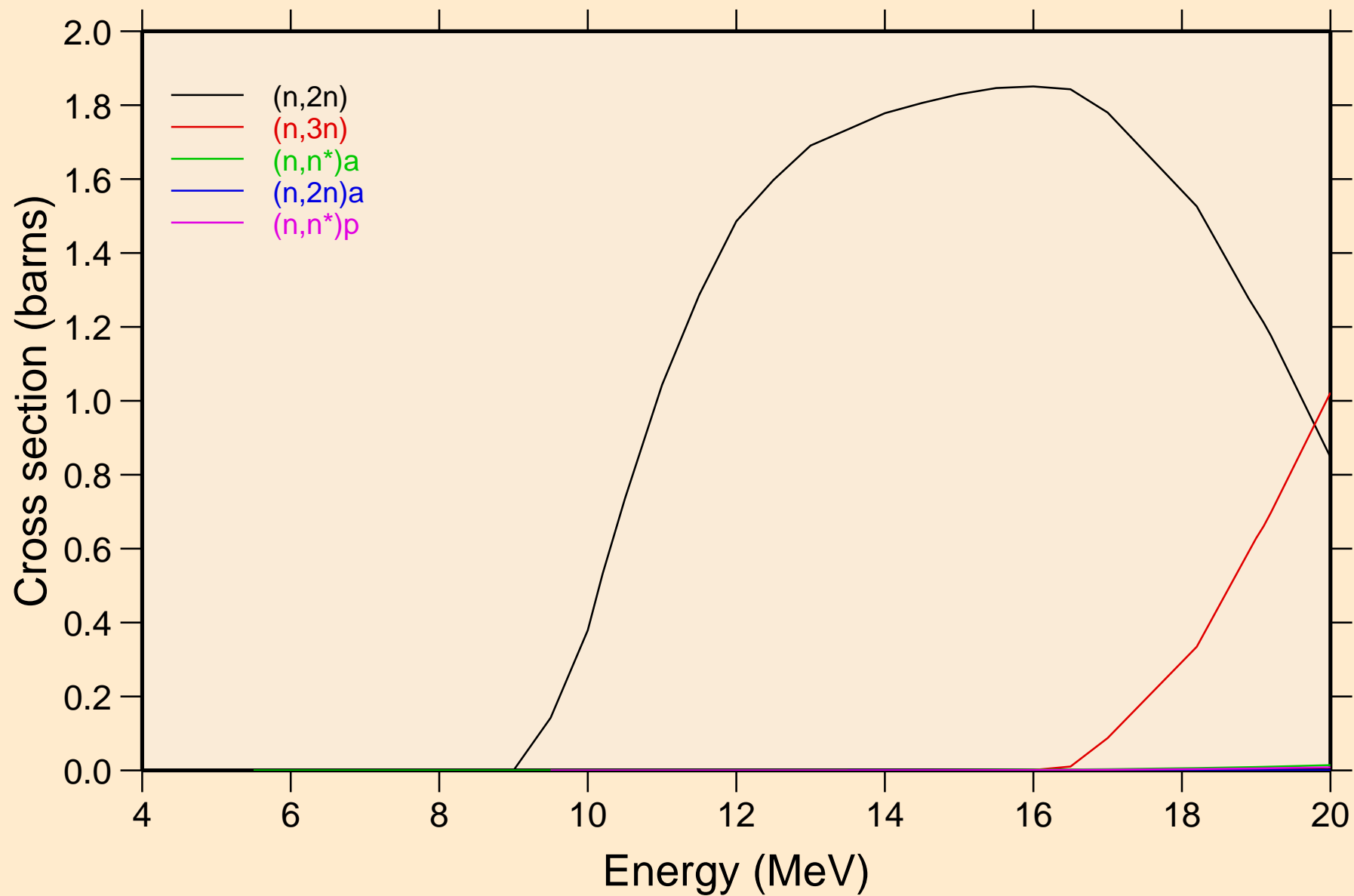

# ENDF/B-VII.1 GD-154

## Threshold reactions

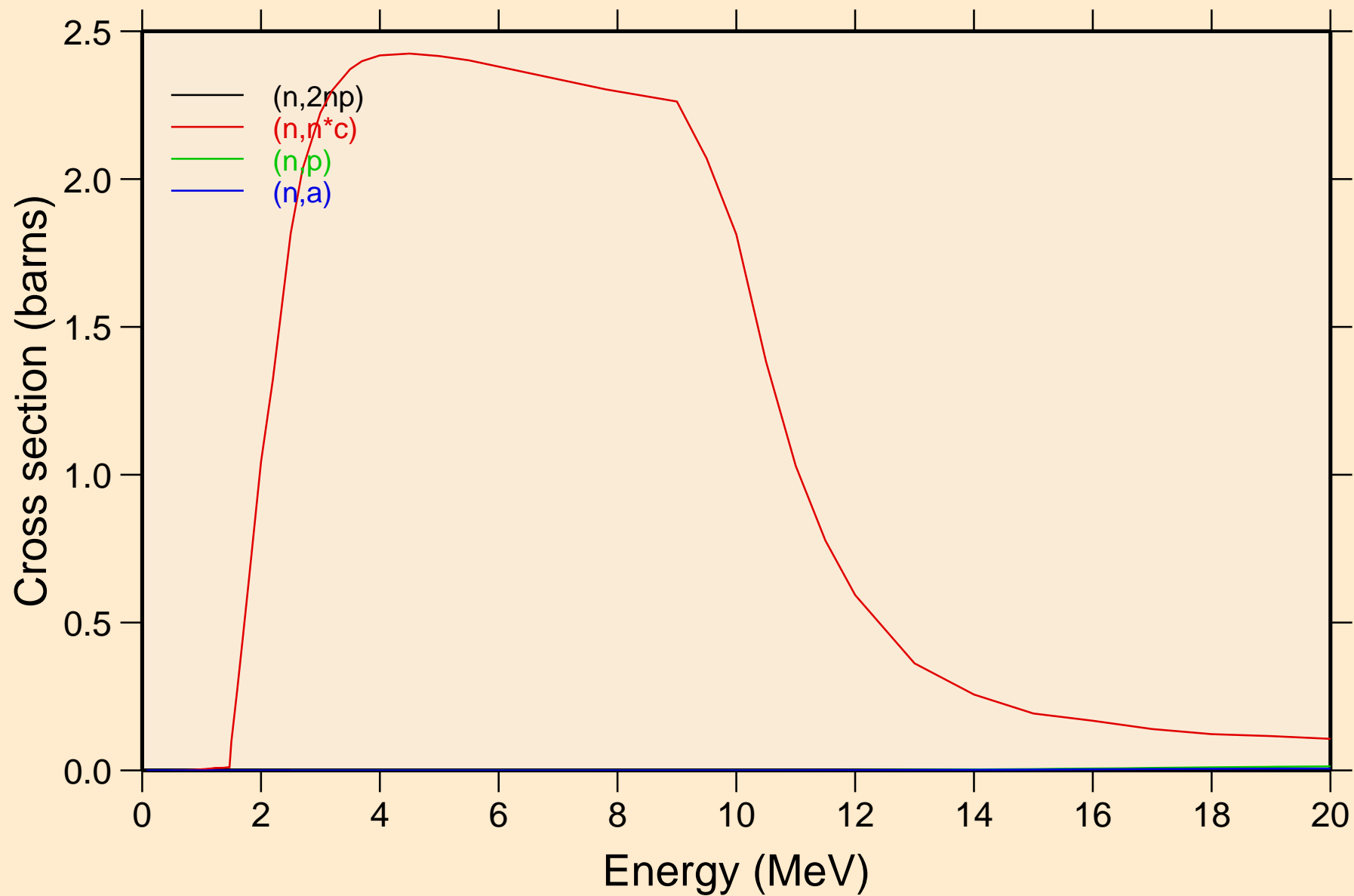

# ENDF/B-VII.1 GD-154

## Threshold reactions

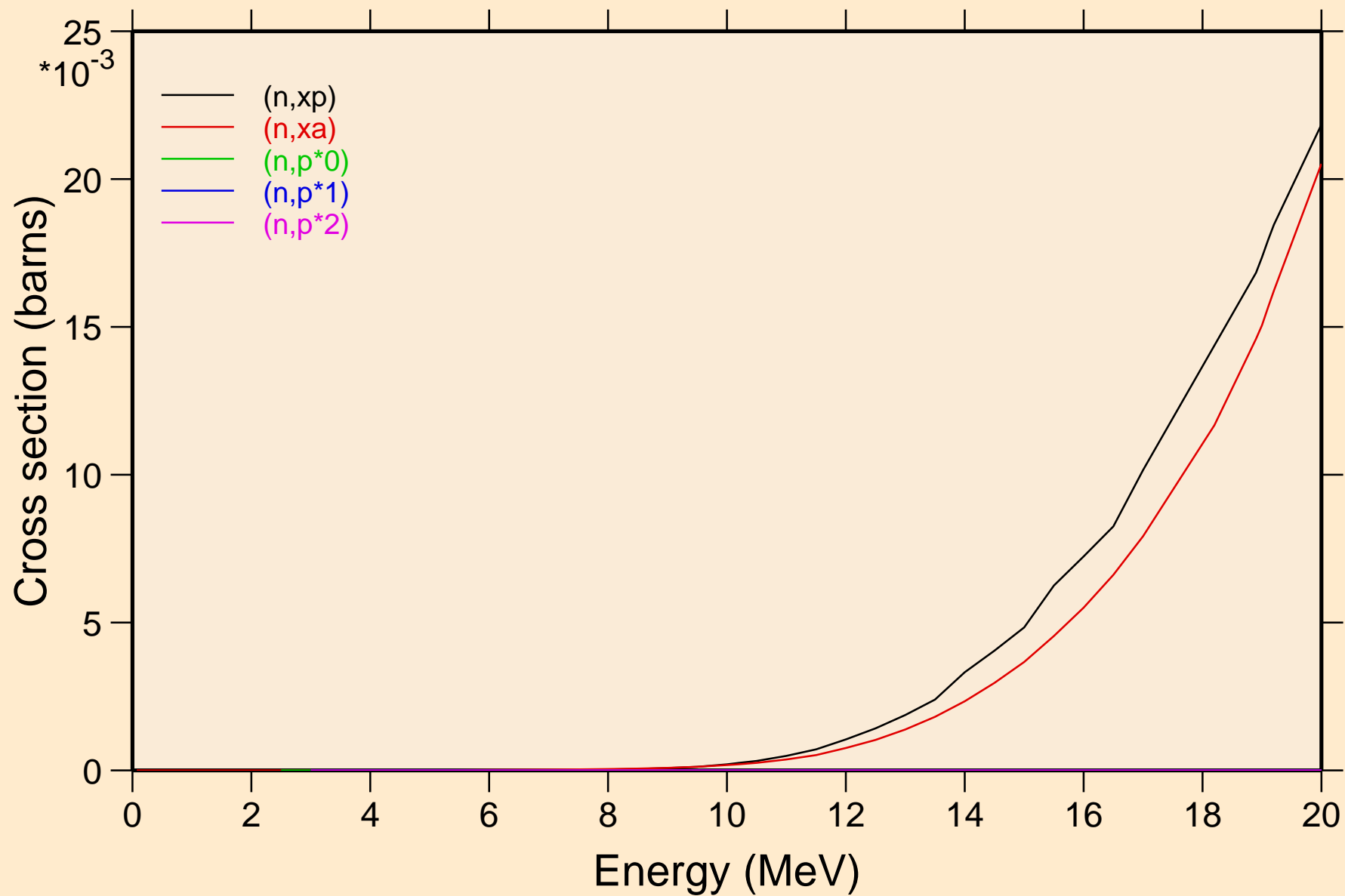

# ENDF/B-VII.1 GD-154

## Threshold reactions

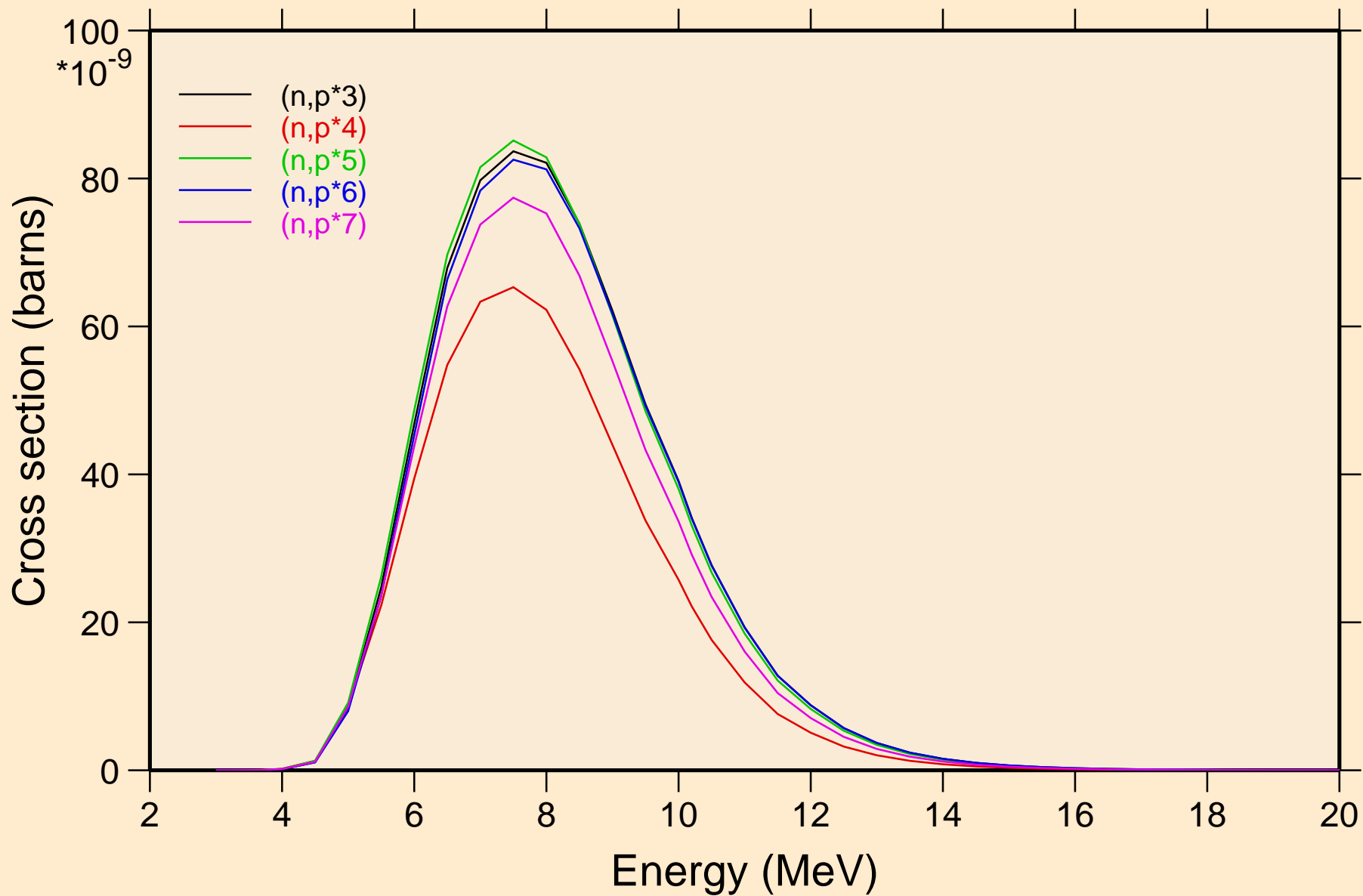

# ENDF/B-VII.1 GD-154

## Threshold reactions

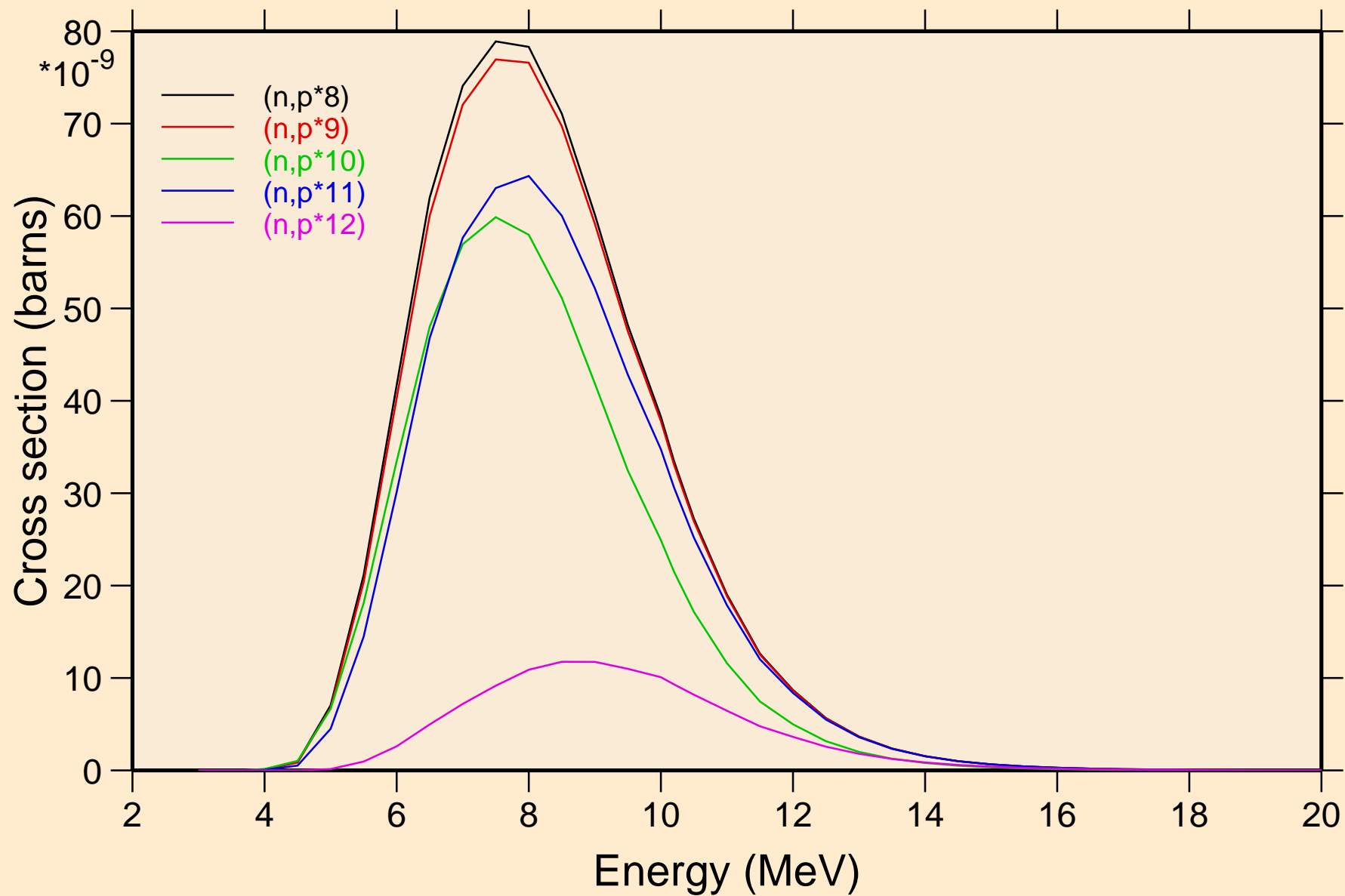

# ENDF/B-VII.1 GD-154

## Threshold reactions

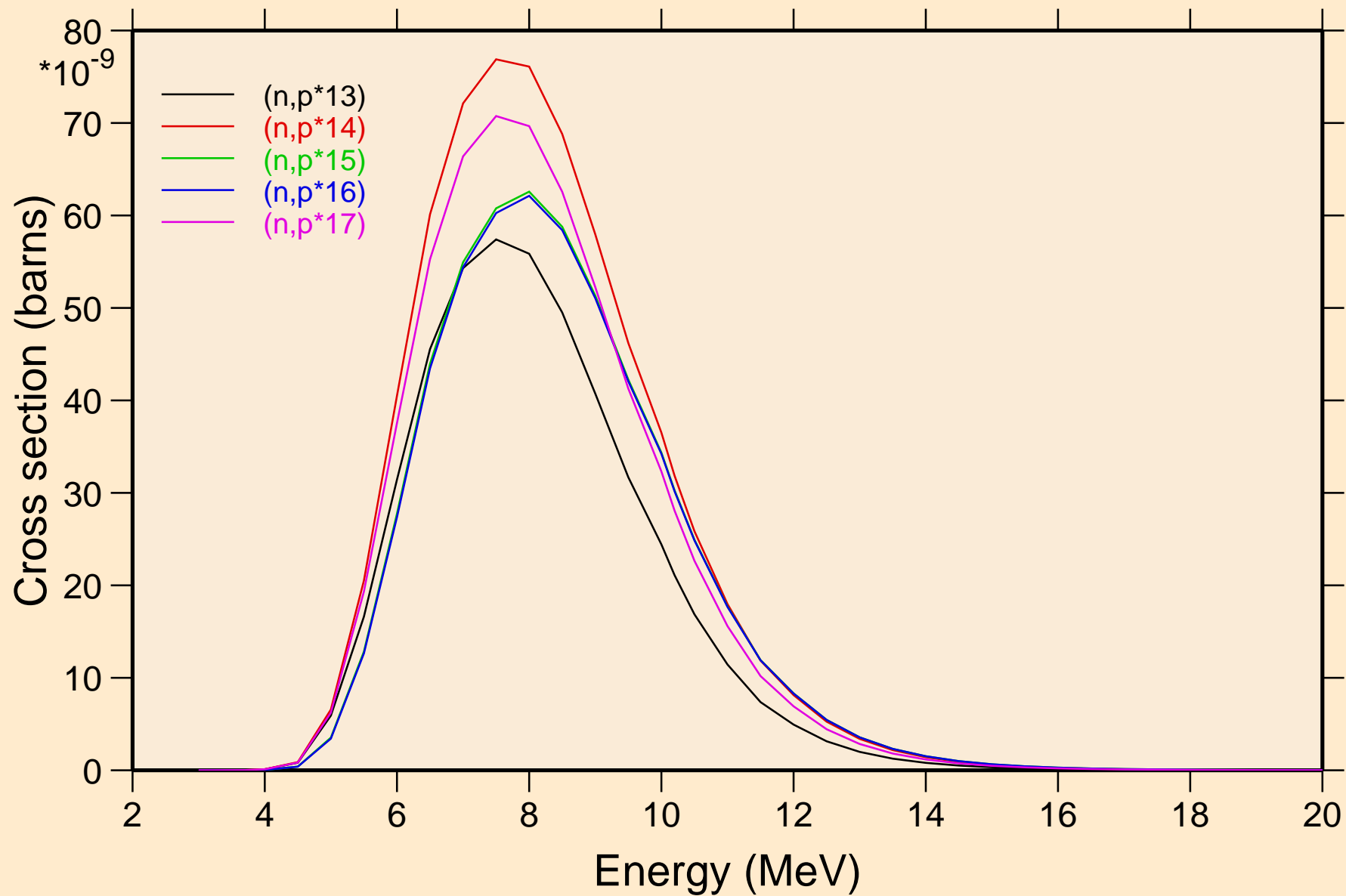

# ENDF/B-VII.1 GD-154

## Threshold reactions

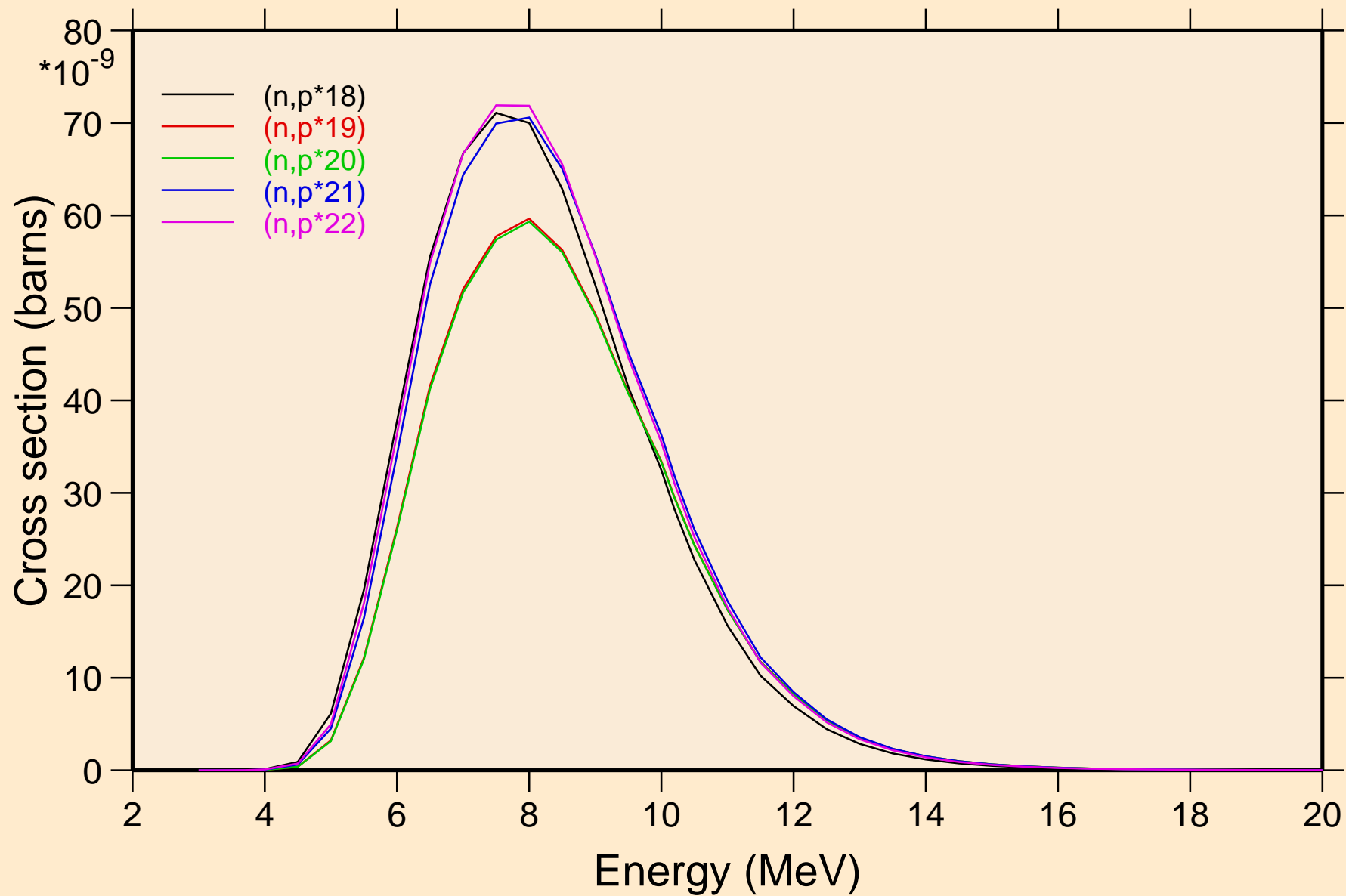



# ENDF/B-VII.1 GD-154

## Threshold reactions

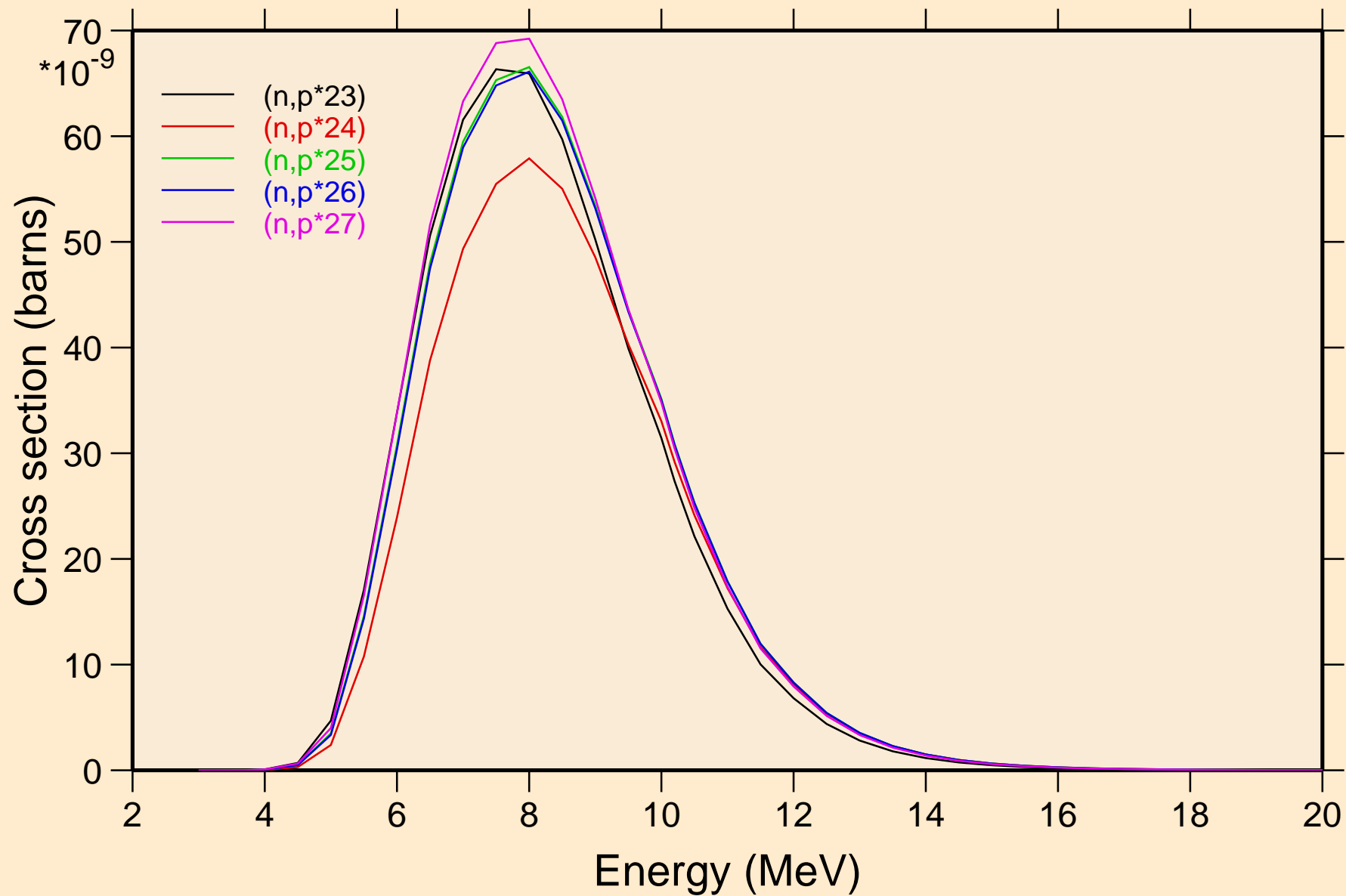

# ENDF/B-VII.1 GD-154

## Threshold reactions

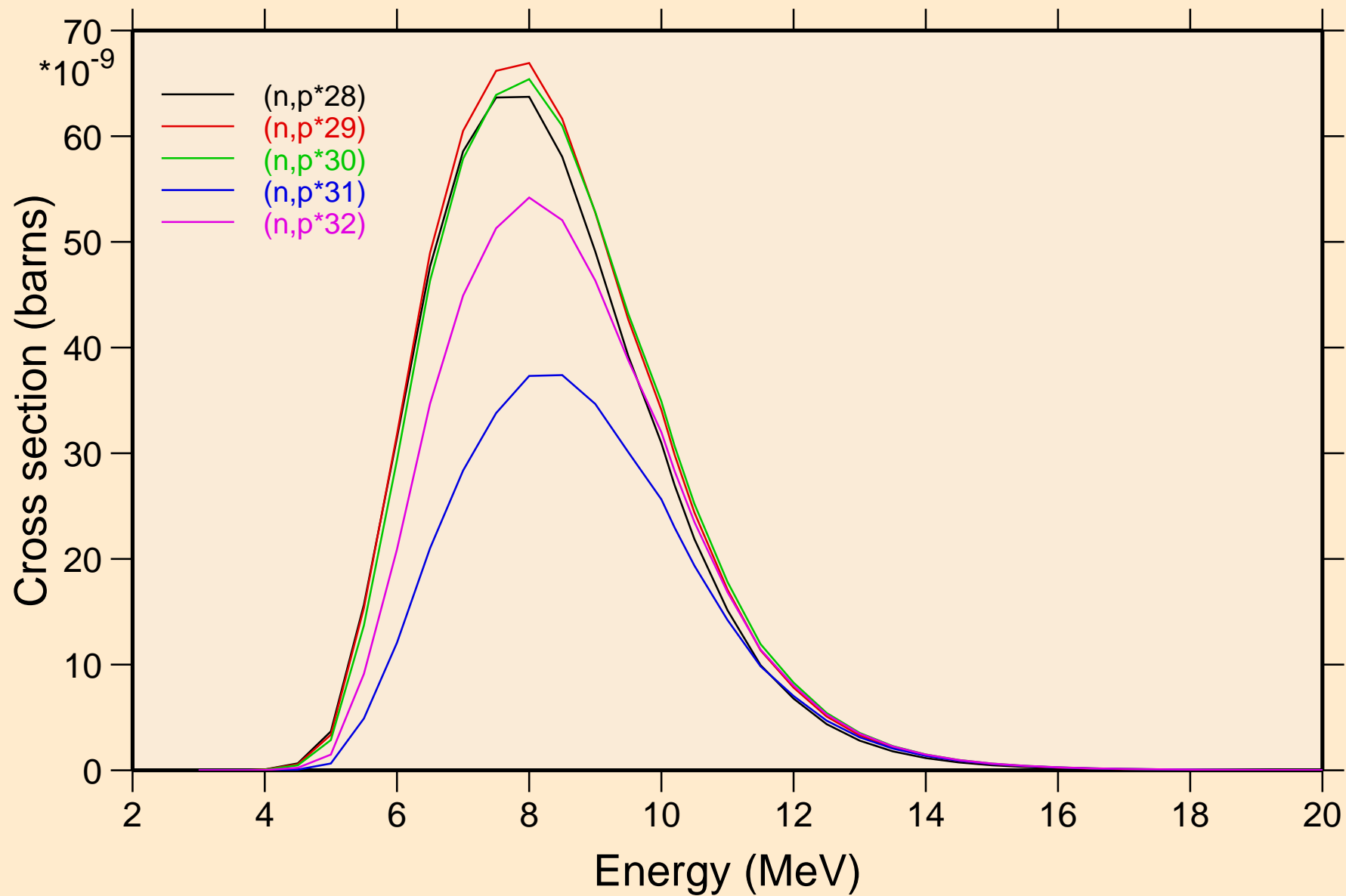

# ENDF/B-VII.1 GD-154

## Threshold reactions

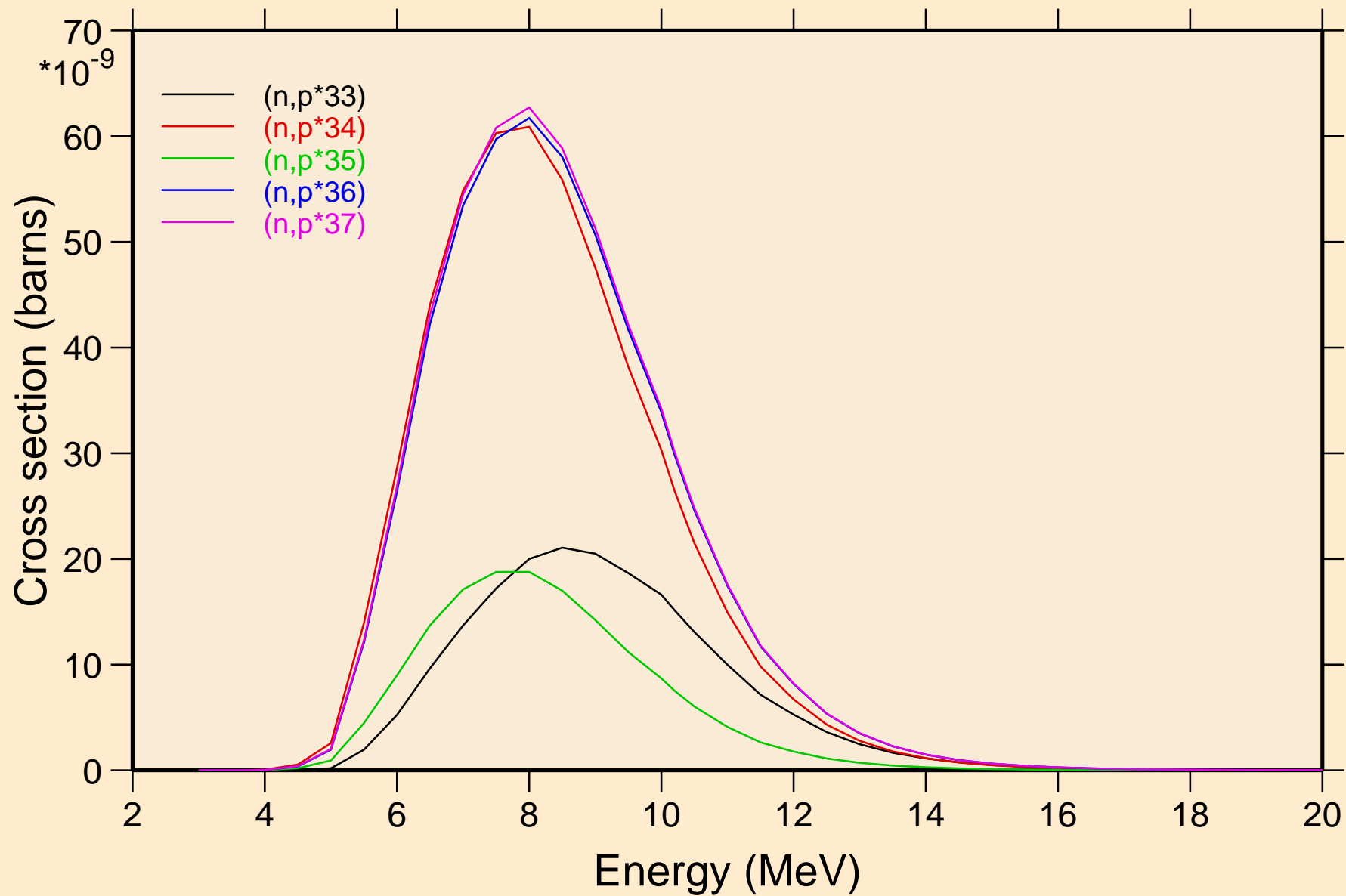

# ENDF/B-VII.1 GD-154

## Threshold reactions

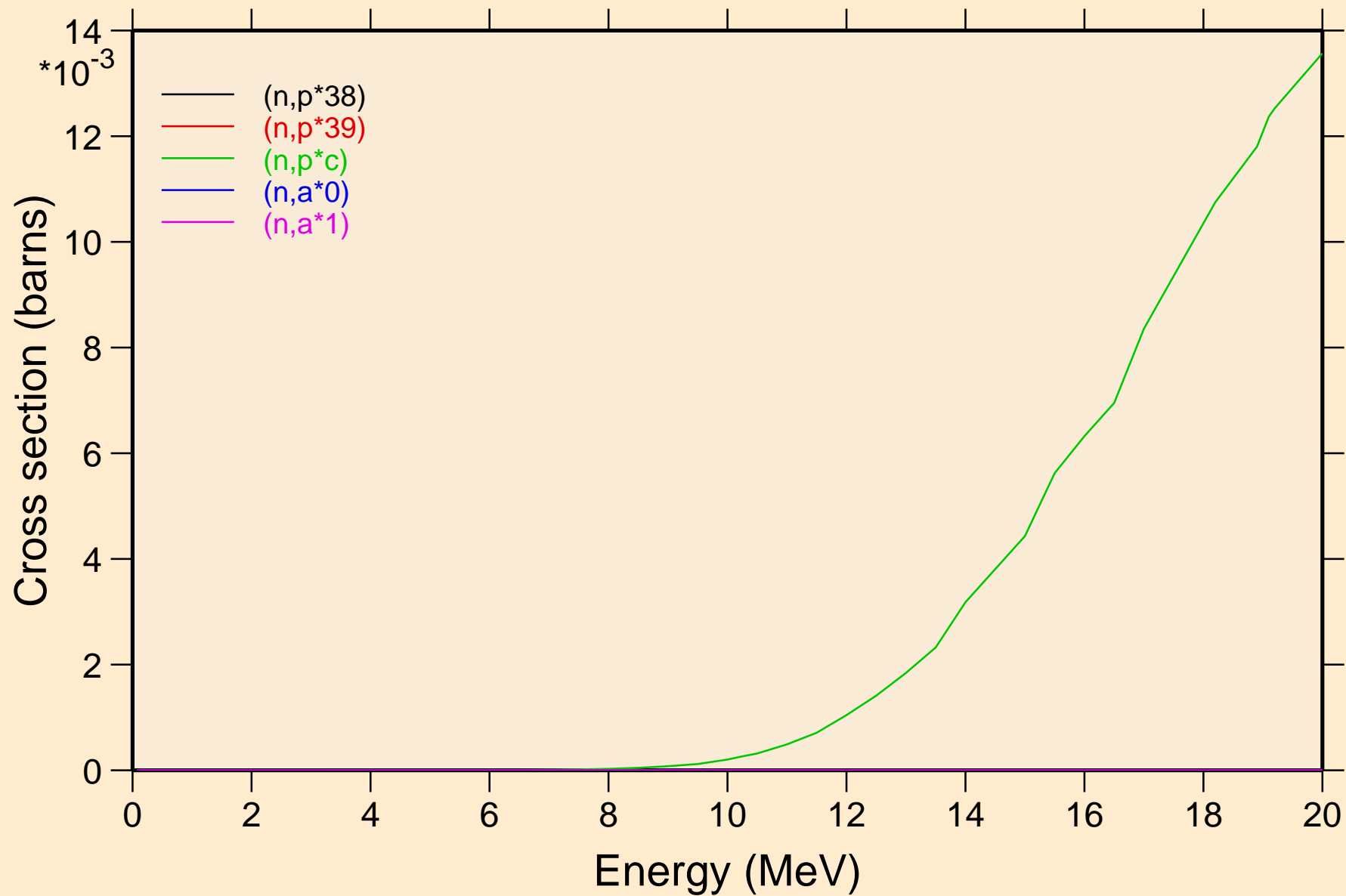

# ENDF/B-VII.1 GD-154

## Threshold reactions

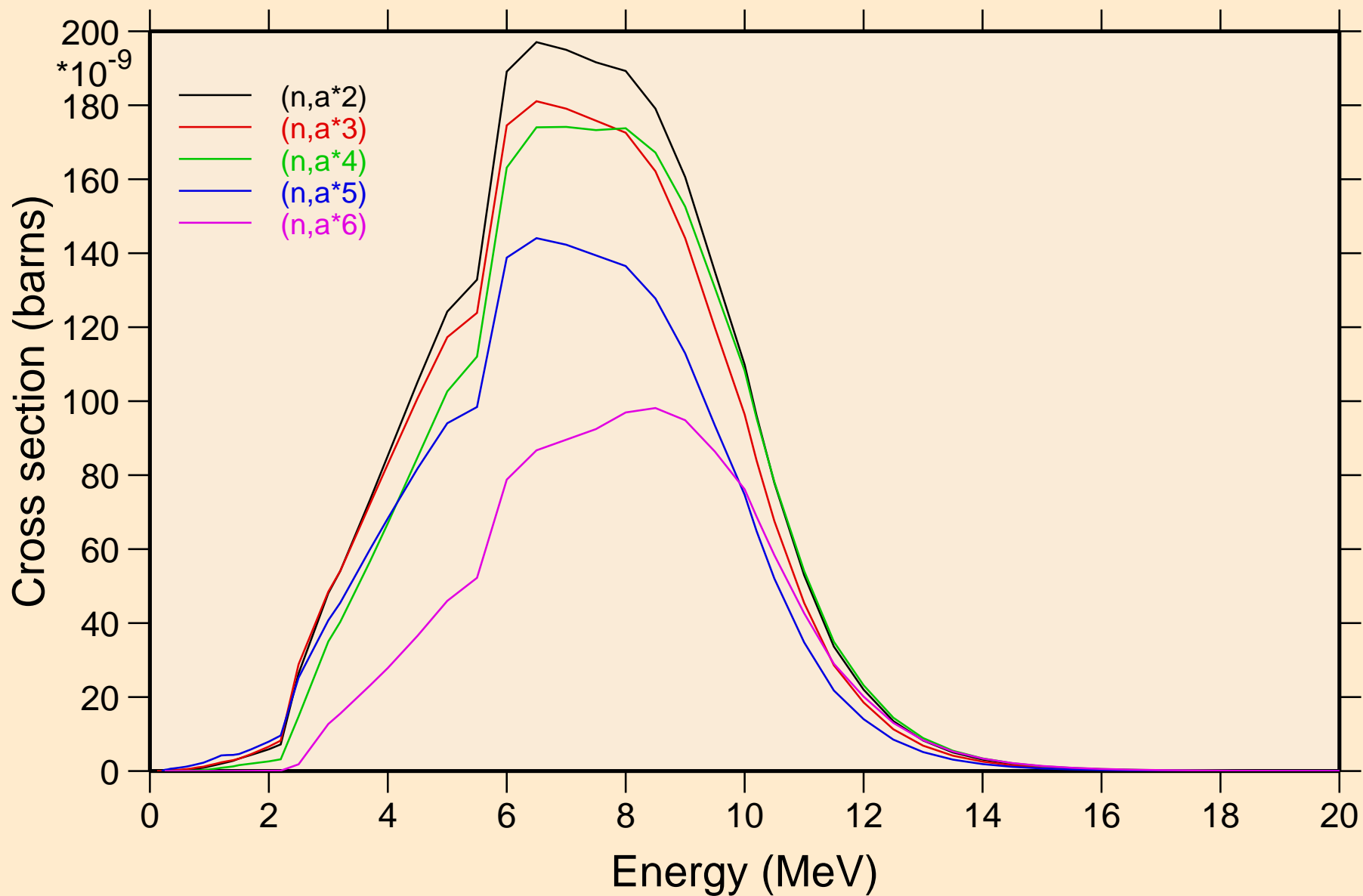

# ENDF/B-VII.1 GD-154

## Threshold reactions

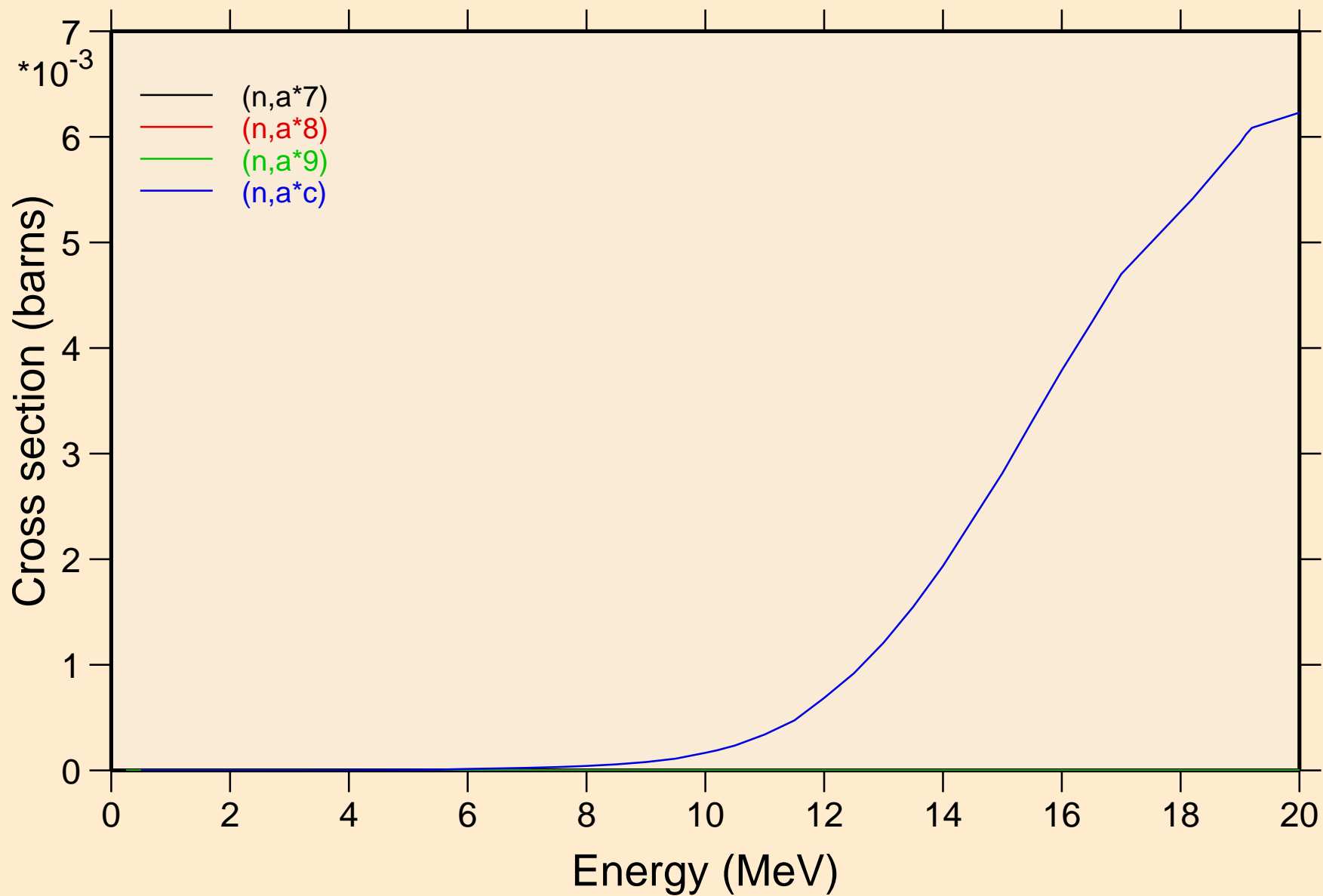

ENDF/B-VII.1 GD-154  
angular distribution for elastic

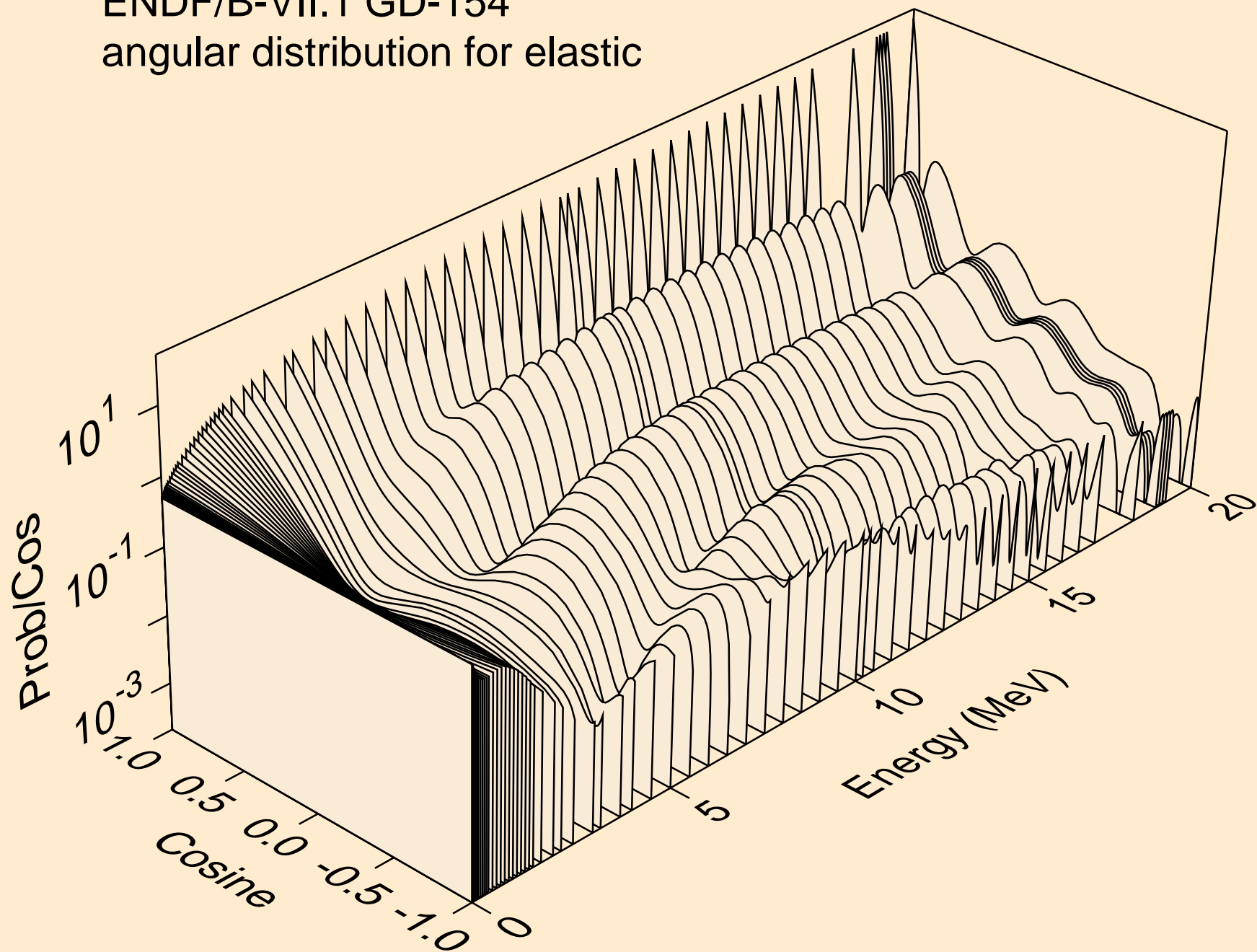

ENDF/B-VII.1 GD-154  
angular distribution for (n,n\*1)

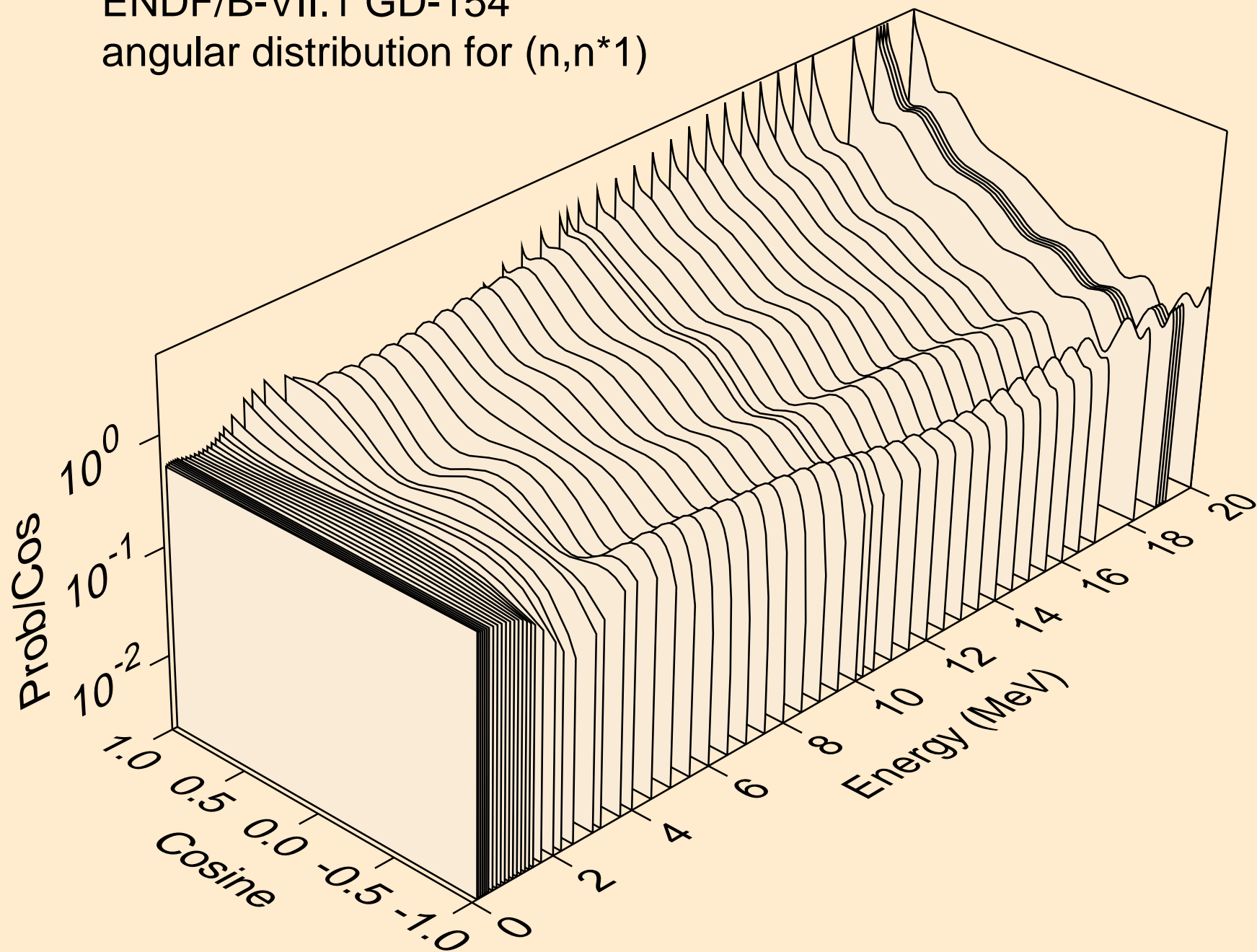



ENDF/B-VII.1 GD-154  
angular distribution for (n,n\*2)

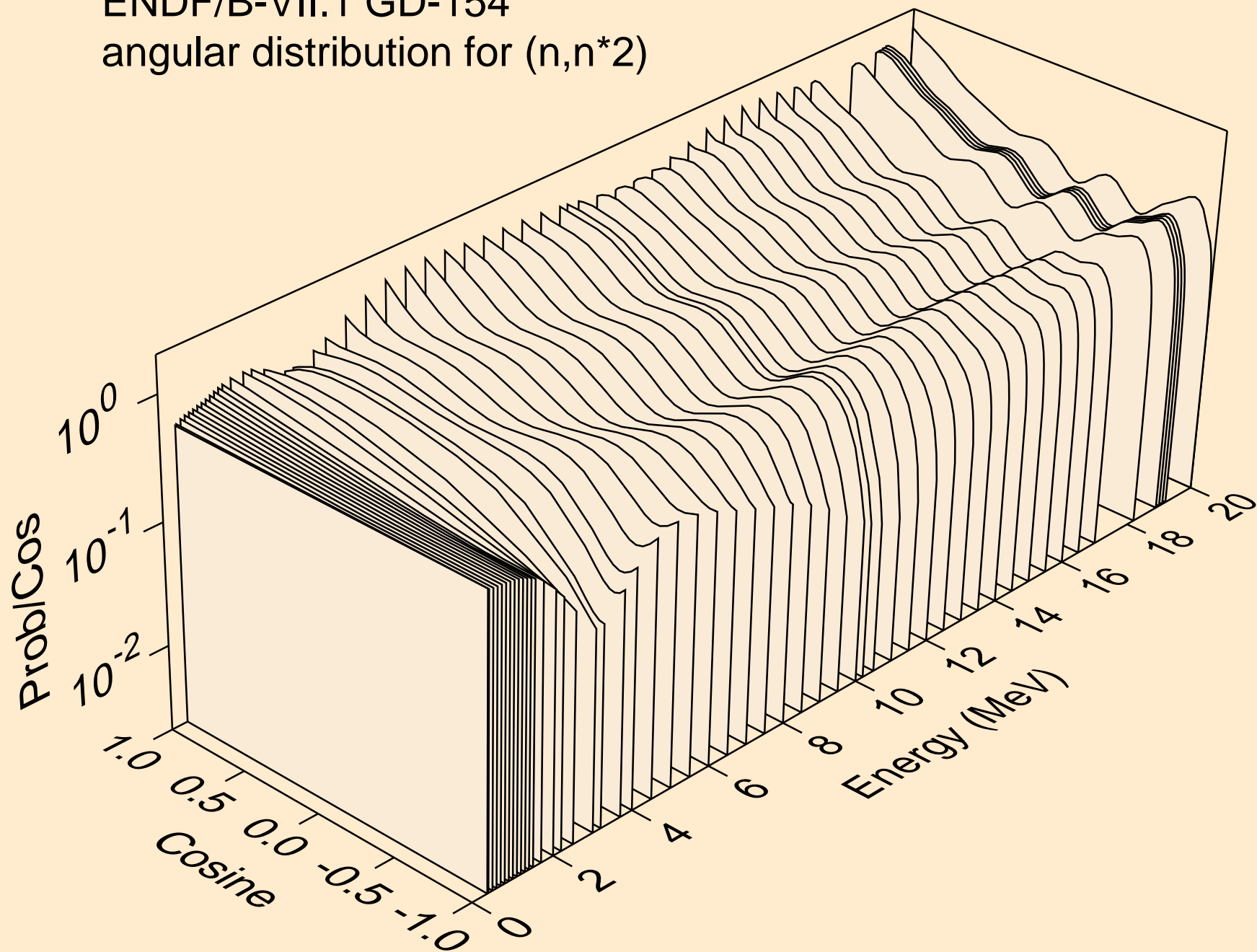

ENDF/B-VII.1 GD-154  
angular distribution for (n,n\*3)

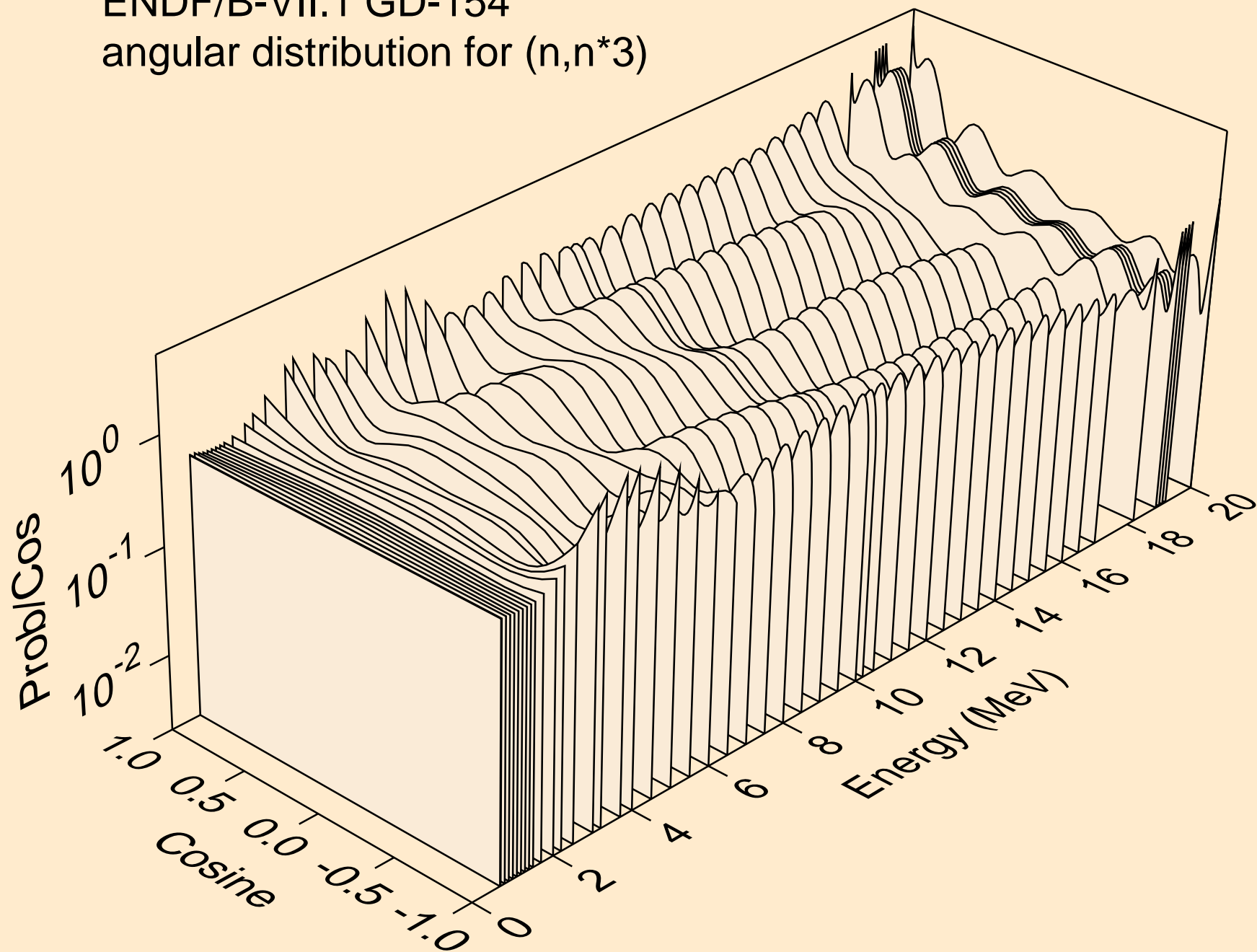

ENDF/B-VII.1 GD-154  
angular distribution for (n,n\*4)

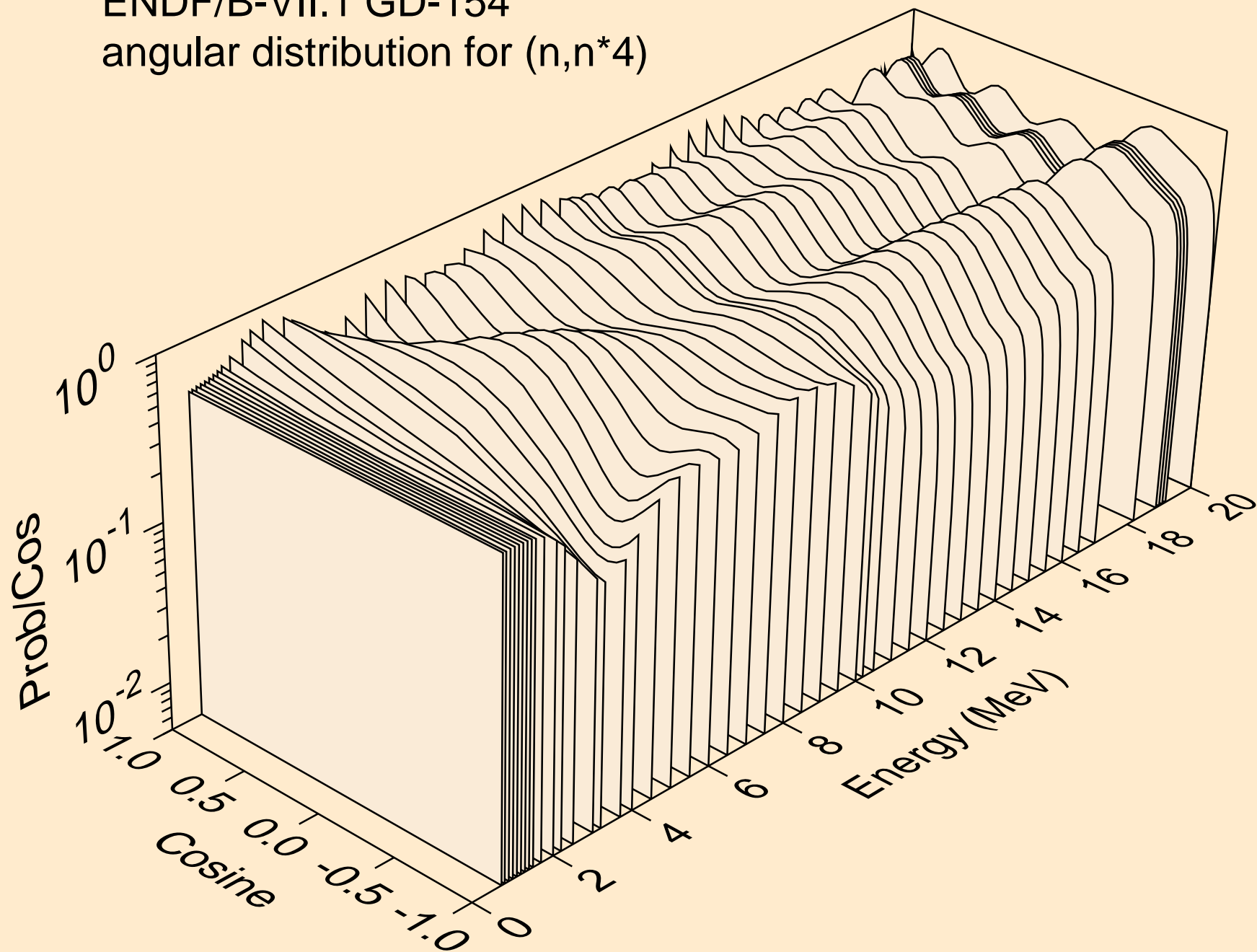

ENDF/B-VII.1 GD-154  
angular distribution for (n,n\*5)

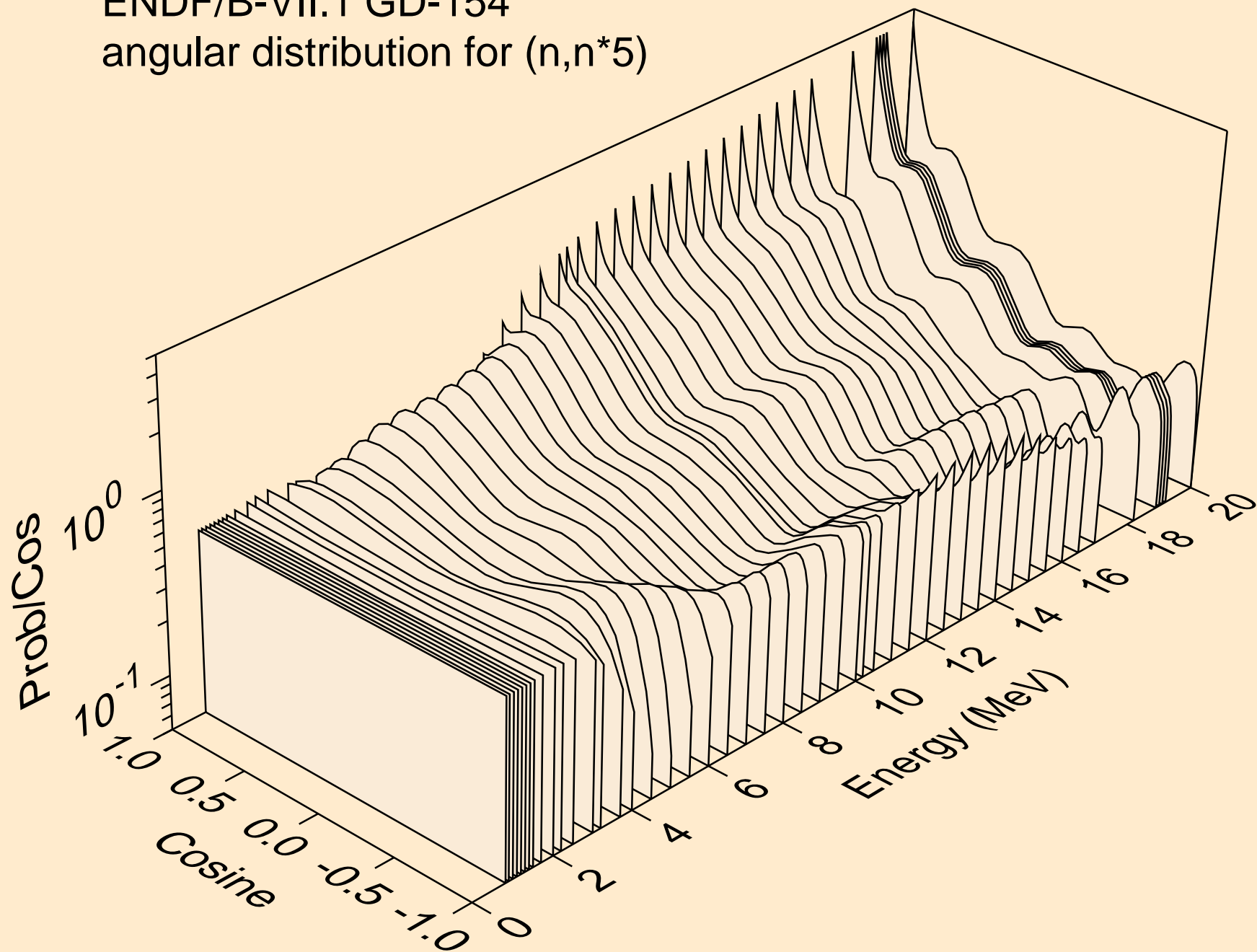

ENDF/B-VII.1 GD-154  
angular distribution for (n,n\*6)

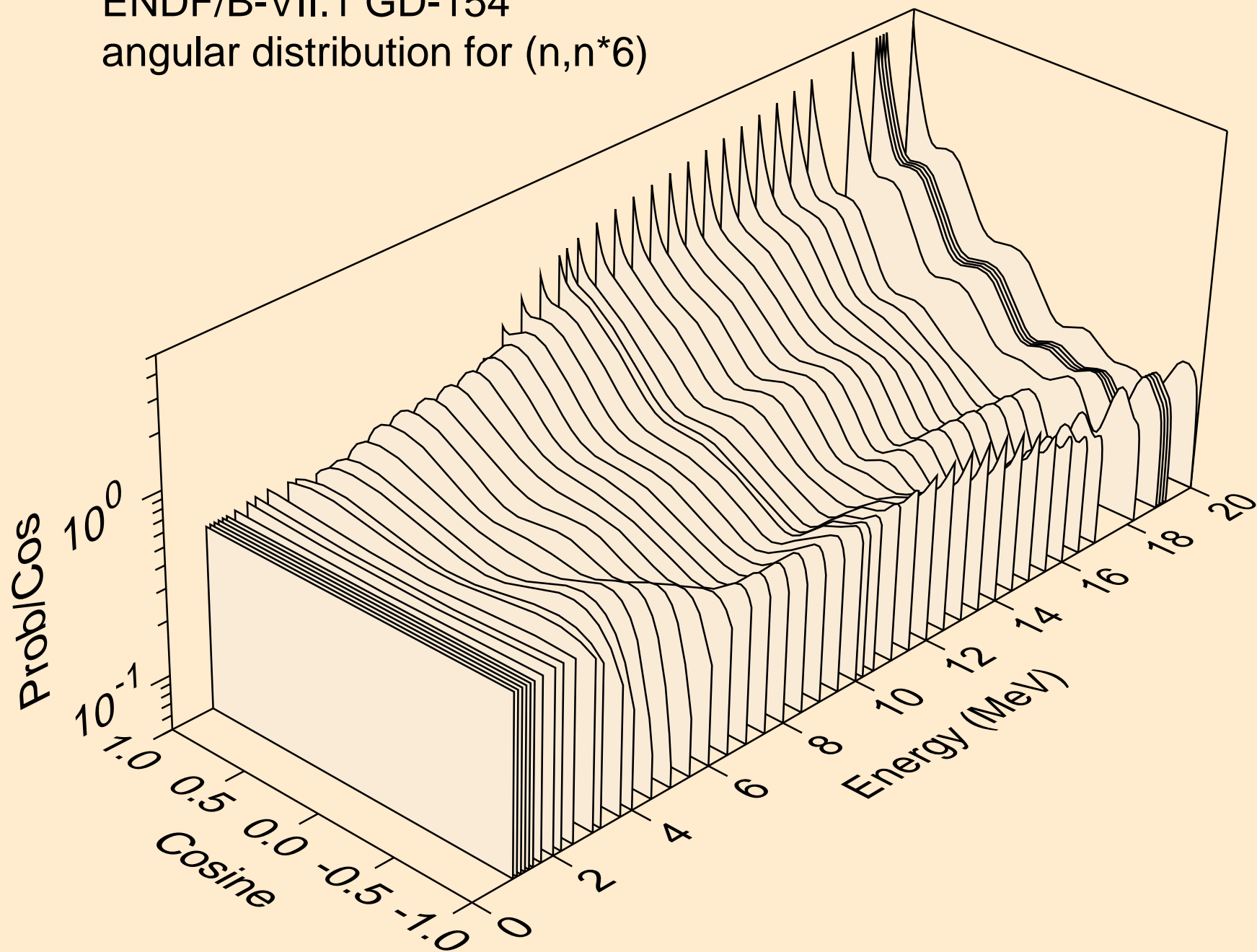

ENDF/B-VII.1 GD-154  
angular distribution for (n,n\*7)

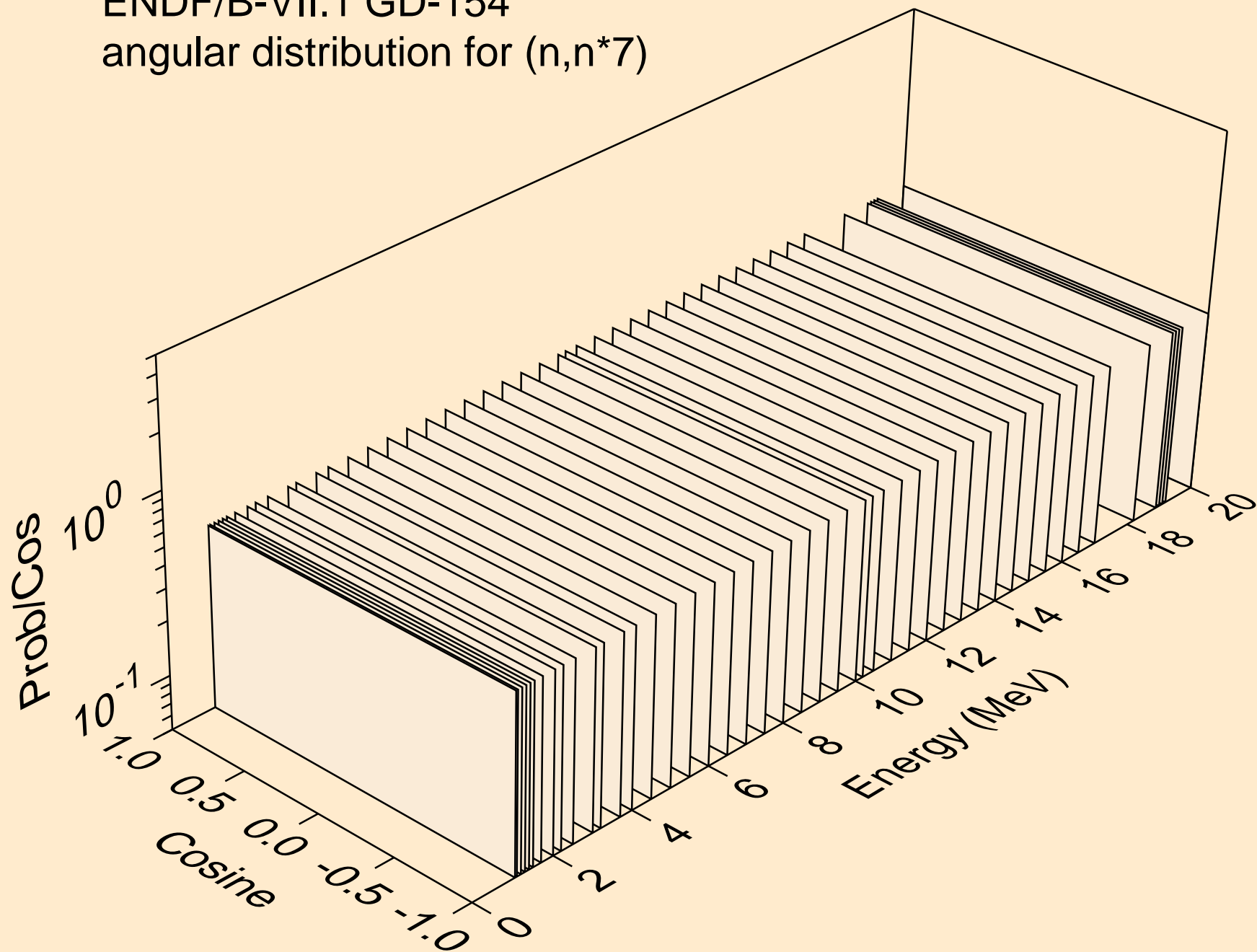



ENDF/B-VII.1 GD-154  
angular distribution for (n,n\*8)

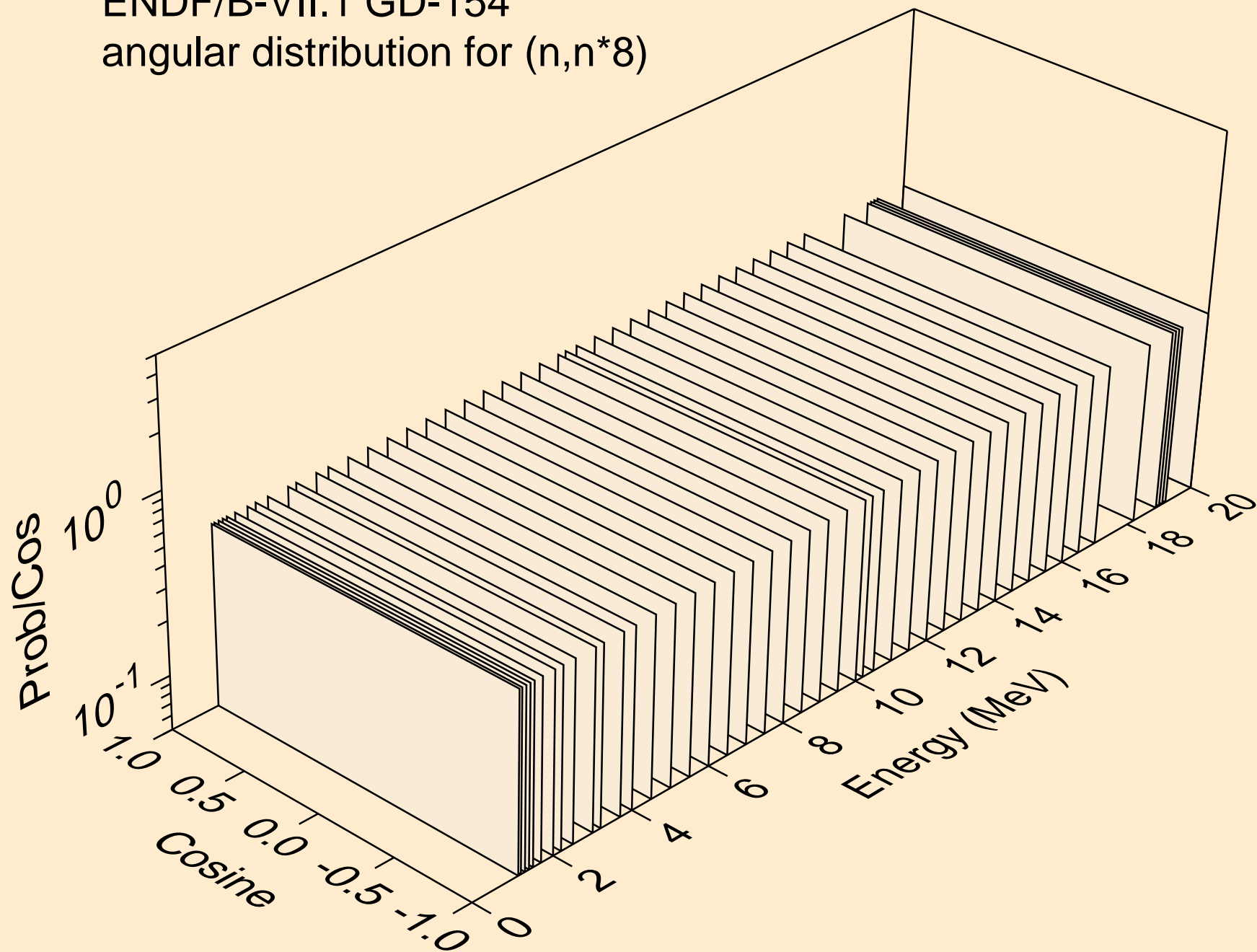

ENDF/B-VII.1 GD-154  
angular distribution for (n,n\*9)

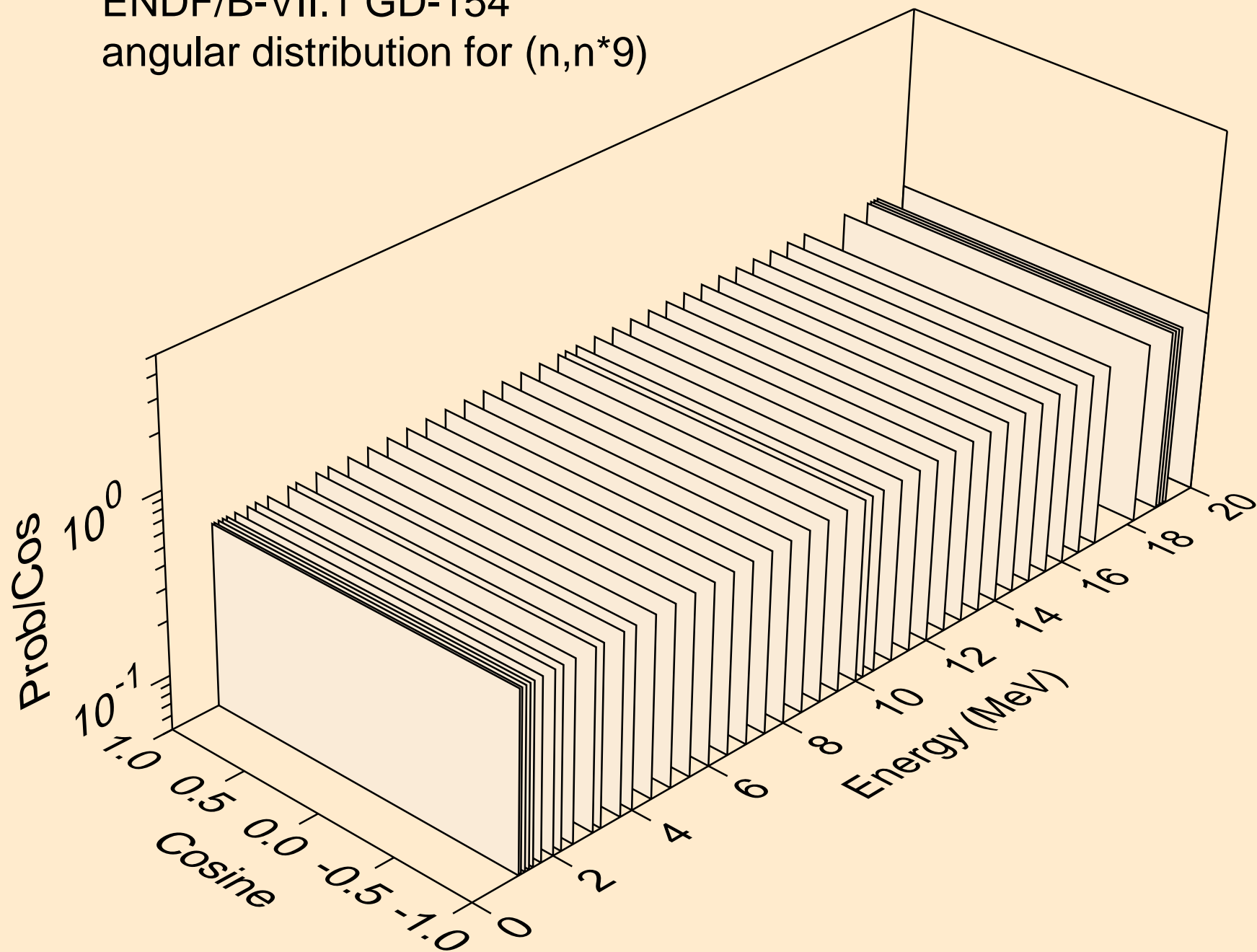



ENDF/B-VII.1 GD-154  
angular distribution for (n,n\*10)

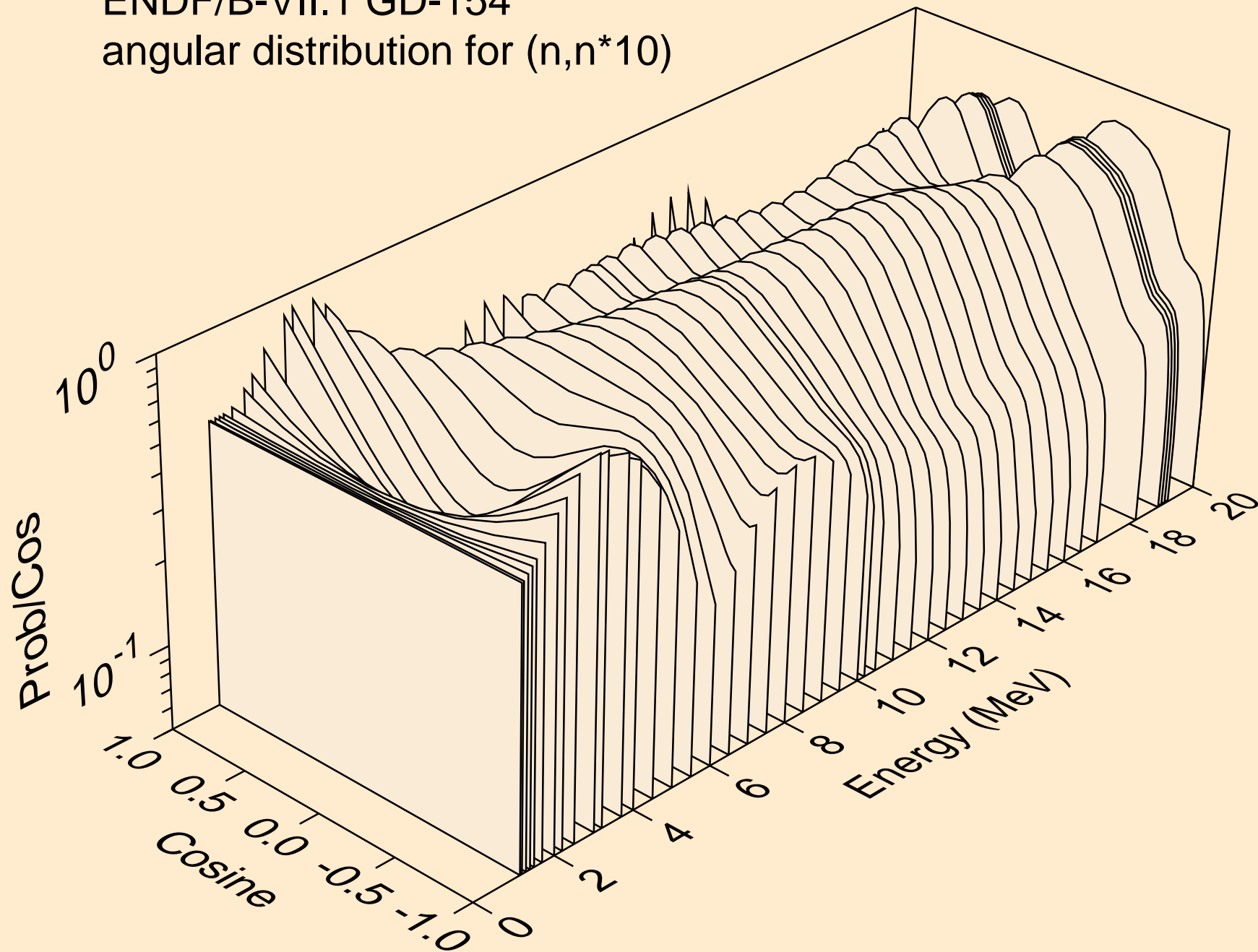

ENDF/B-VII.1 GD-154  
angular distribution for (n,n\*11)

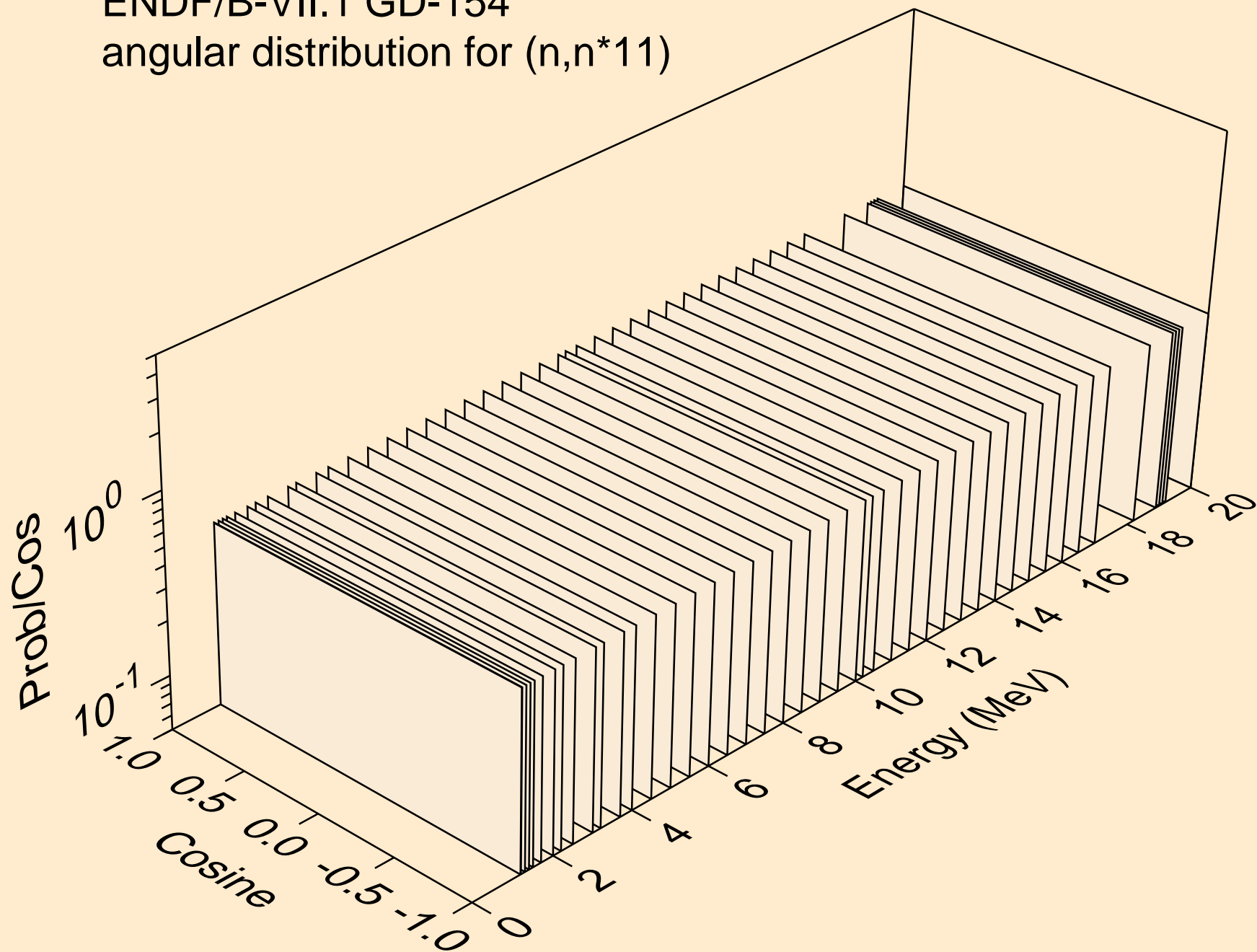

ENDF/B-VII.1 GD-154  
angular distribution for (n,n\*12)

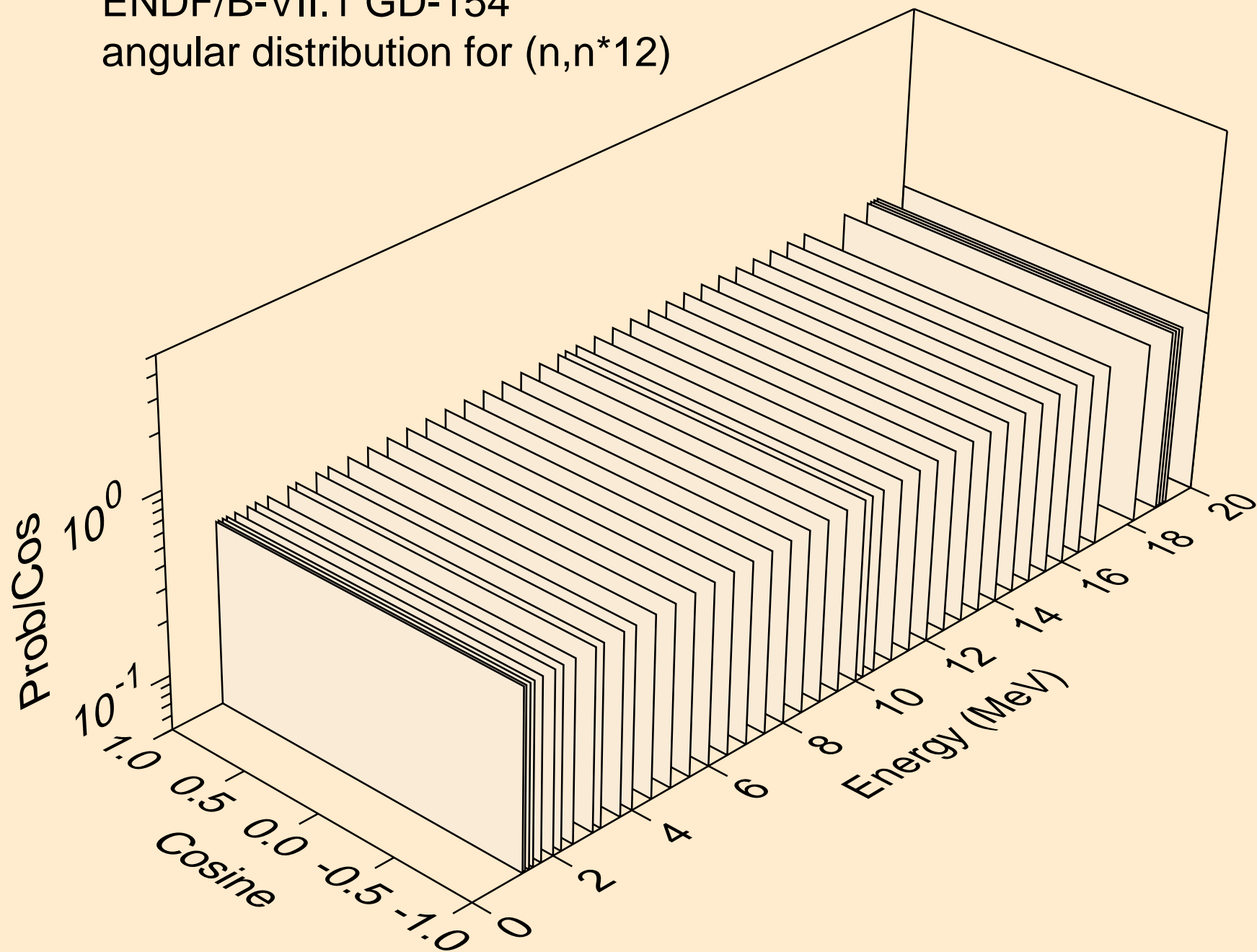

ENDF/B-VII.1 GD-154  
angular distribution for (n,n\*13)

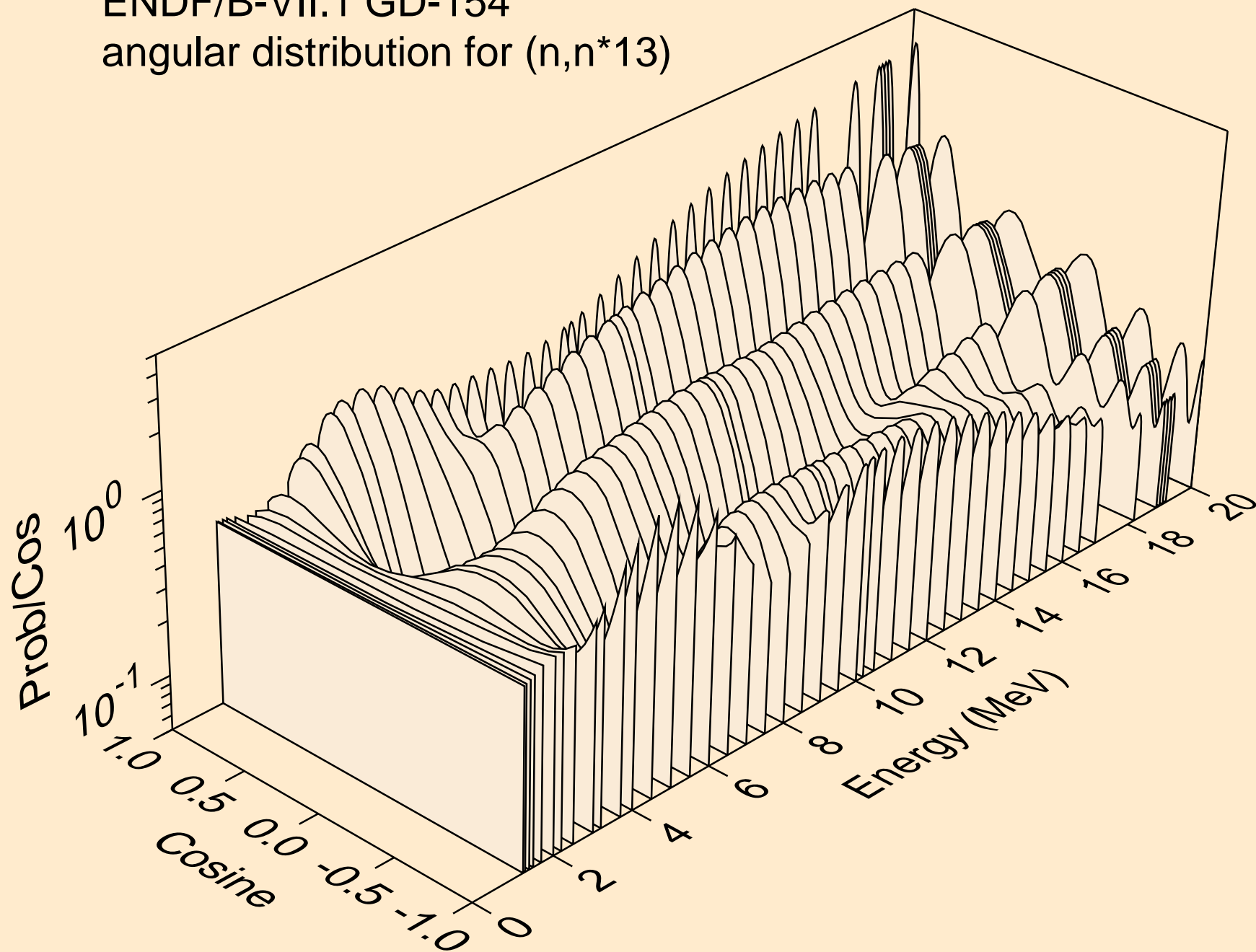

ENDF/B-VII.1 GD-154  
angular distribution for (n,n\*14)

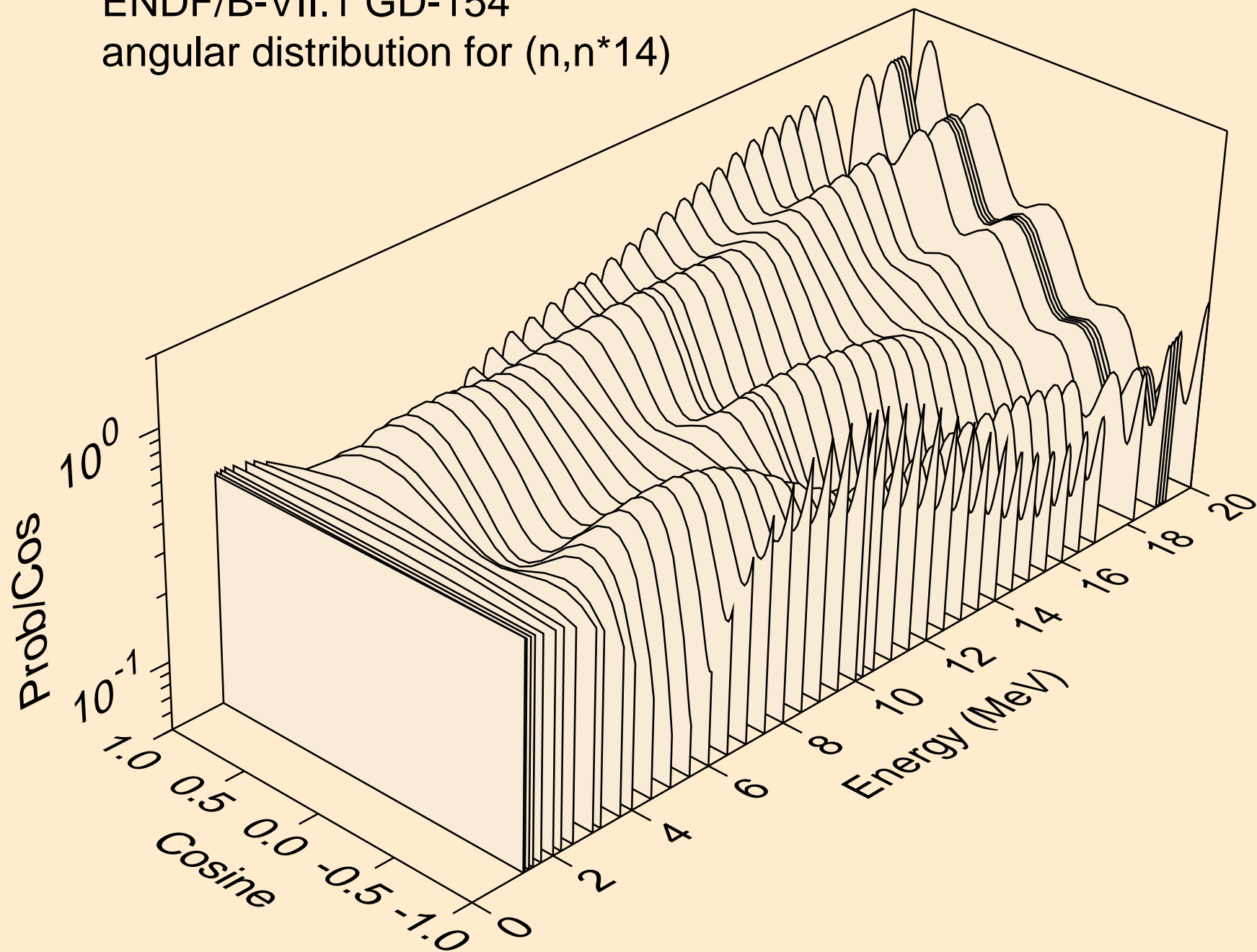

ENDF/B-VII.1 GD-154  
angular distribution for (n,n\*15)

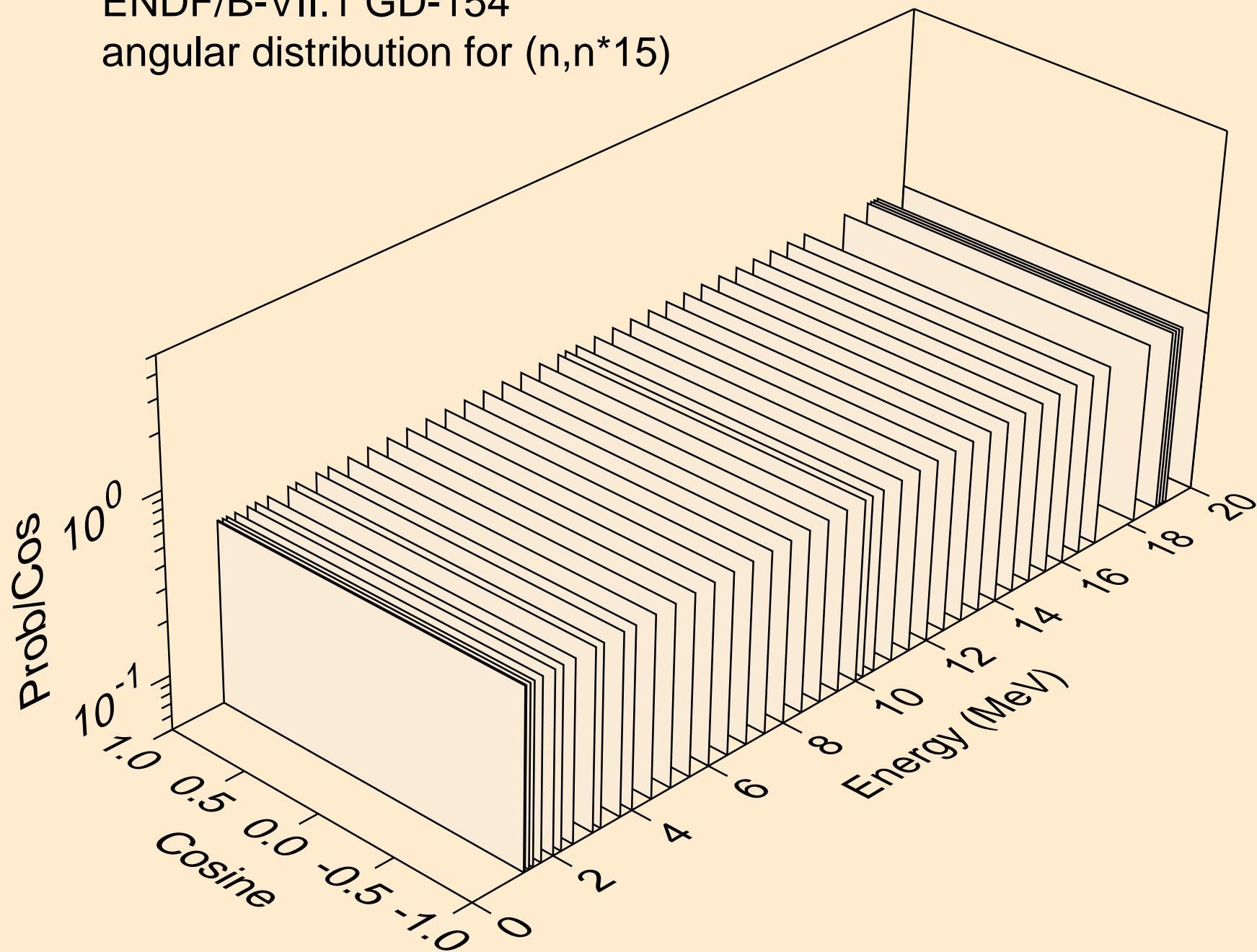

ENDF/B-VII.1 GD-154  
angular distribution for (n,n\*16)

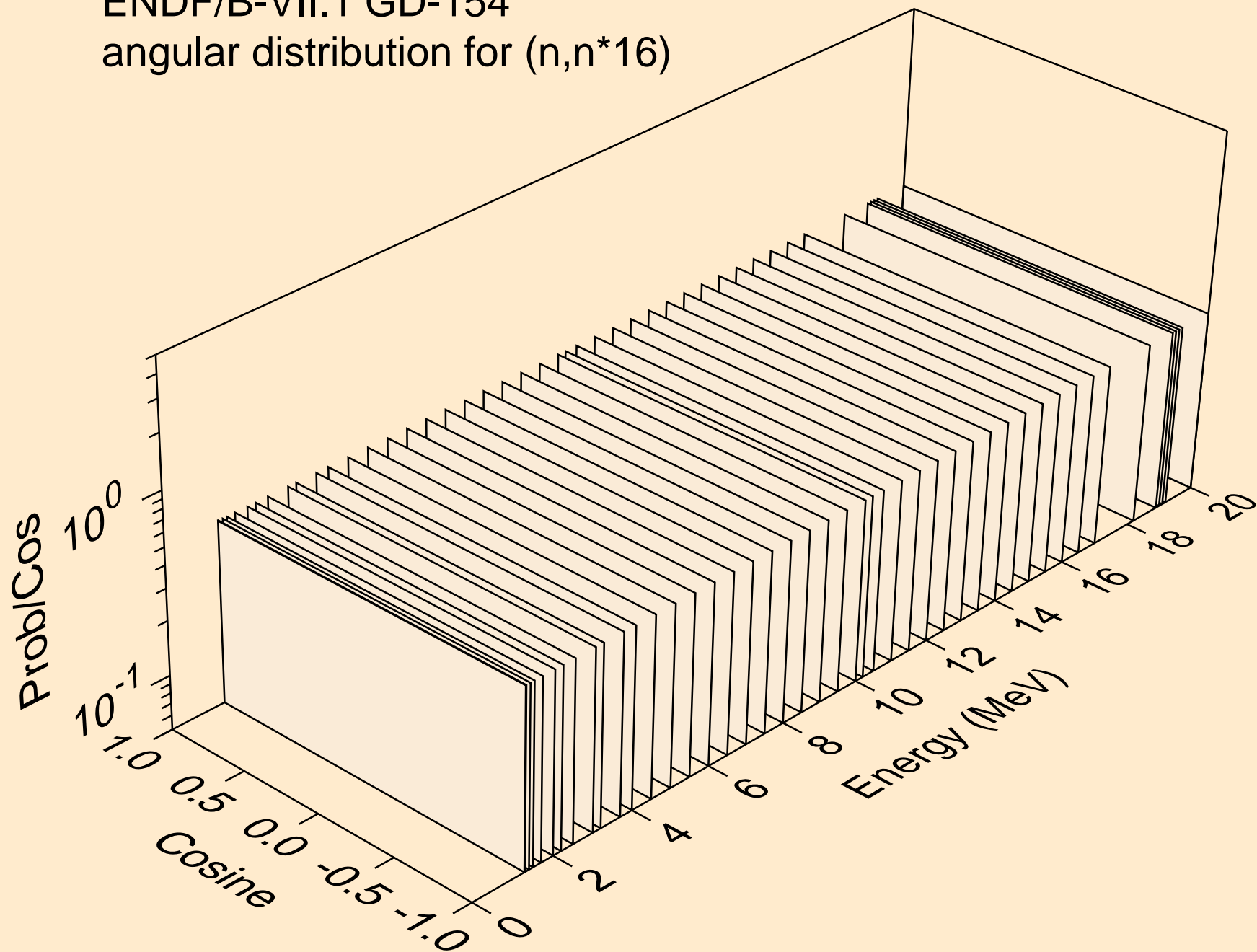



ENDF/B-VII.1 GD-154  
angular distribution for (n,n\*17)

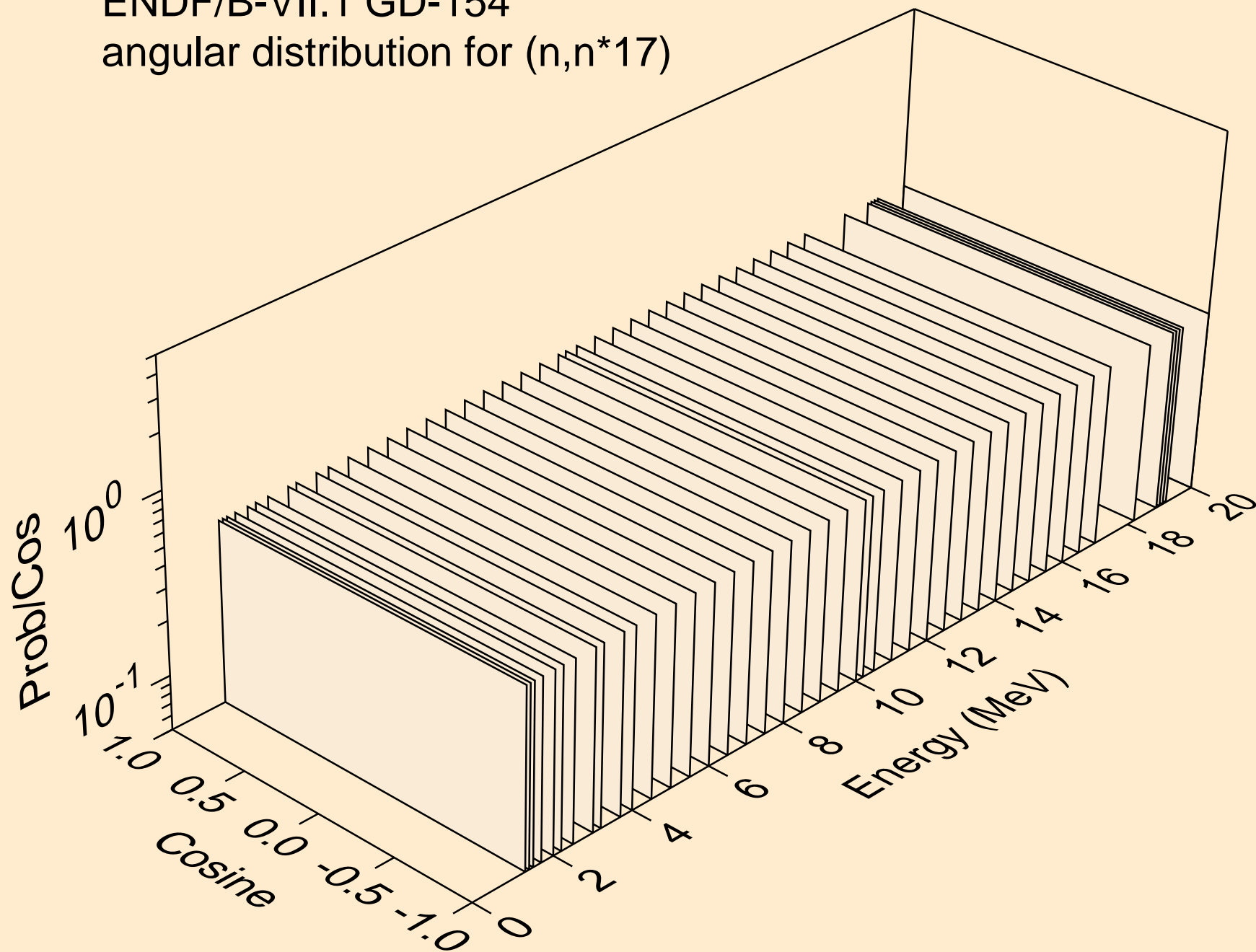



ENDF/B-VII.1 GD-154  
angular distribution for (n,n\*18)

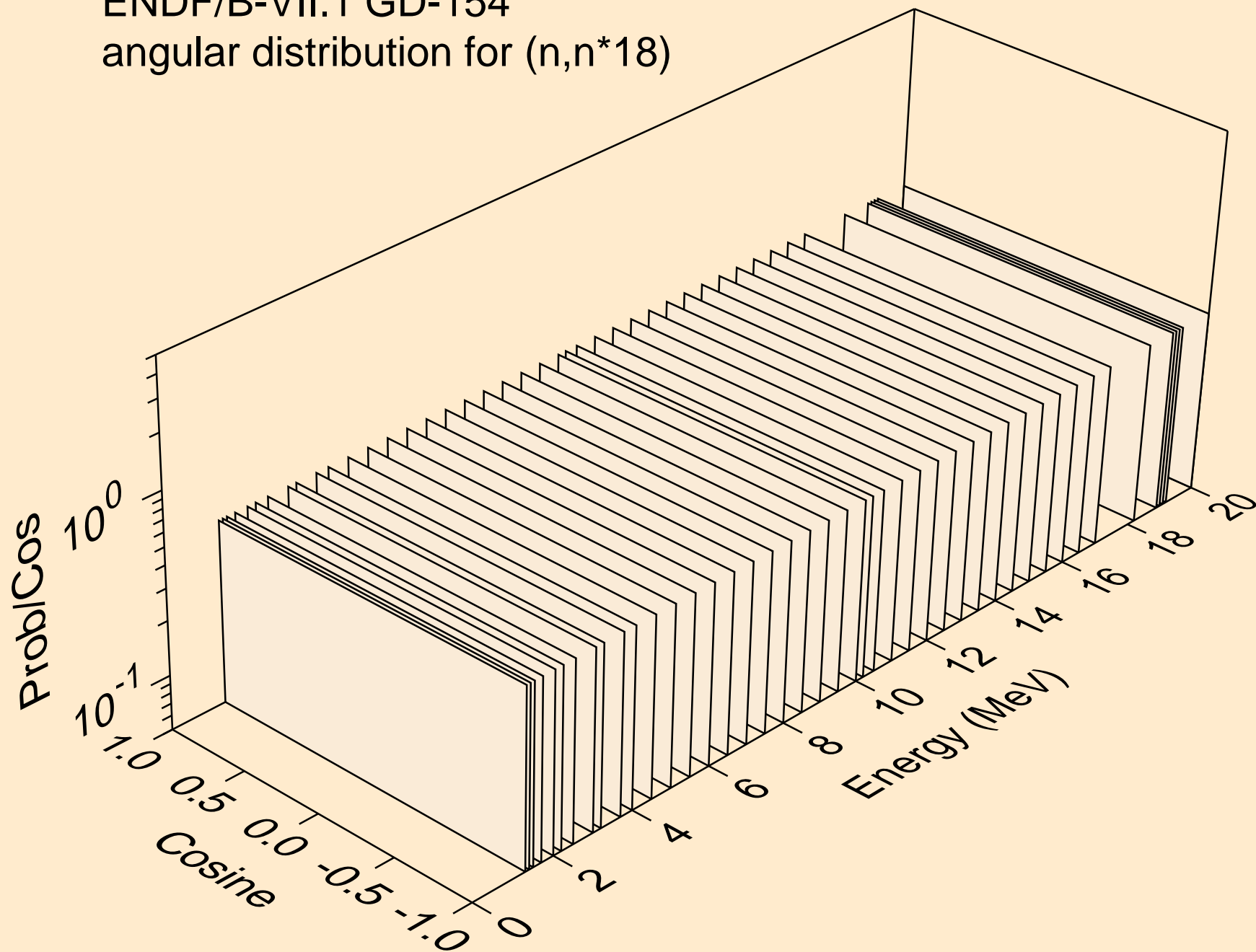

ENDF/B-VII.1 GD-154  
angular distribution for (n,n\*19)

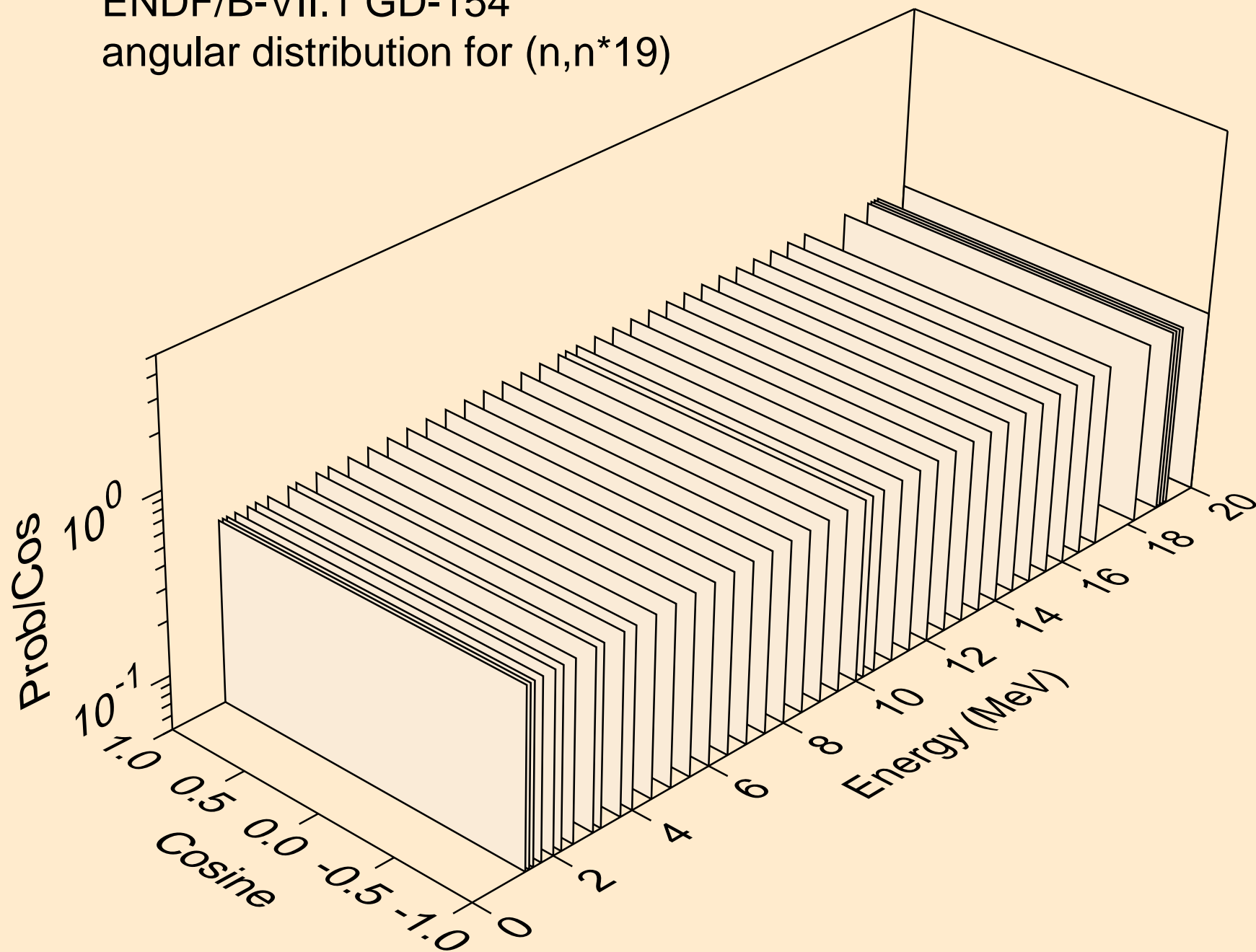

ENDF/B-VII.1 GD-154  
angular distribution for (n,n\*20)

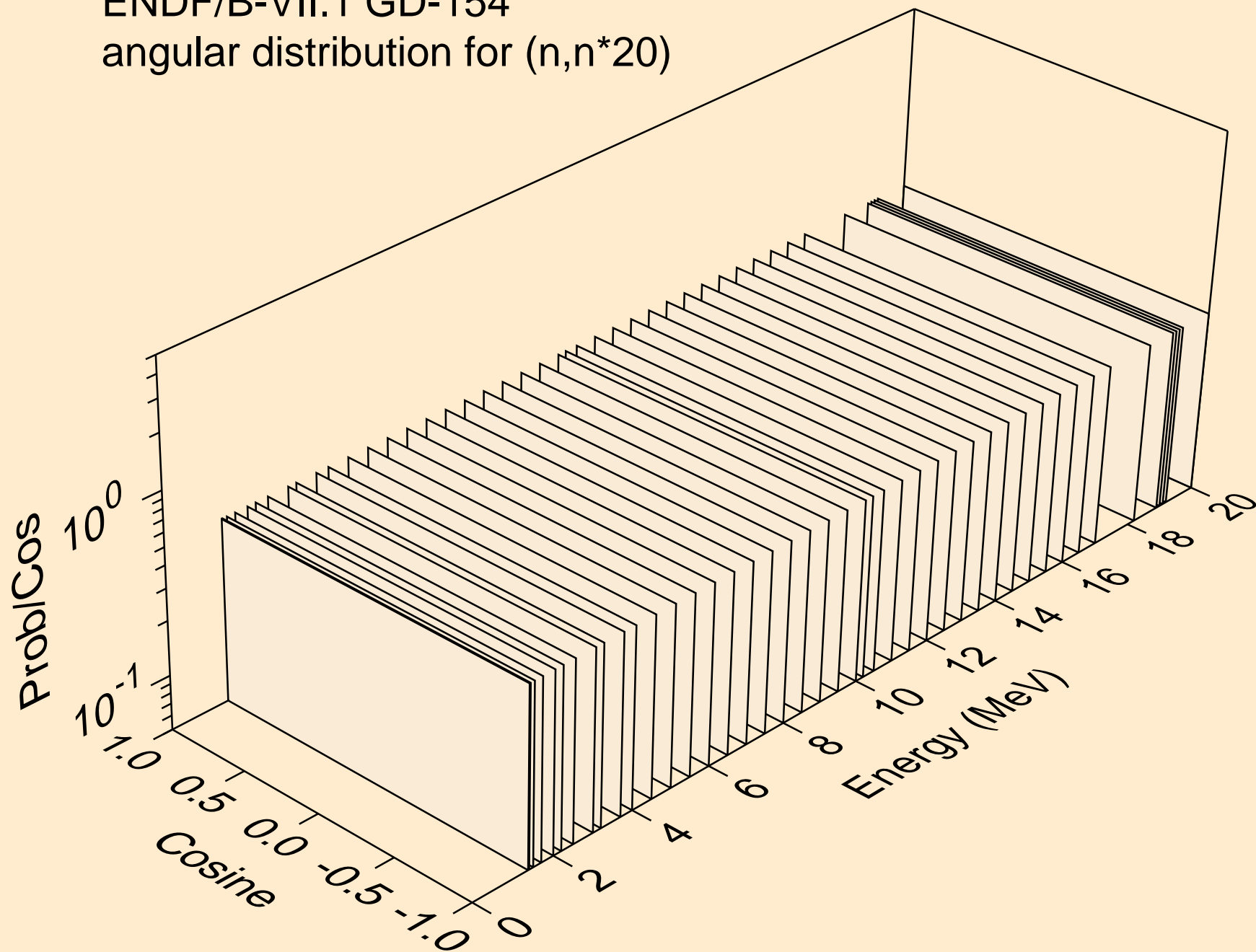

ENDF/B-VII.1 GD-154  
angular distribution for (n,n\*21)

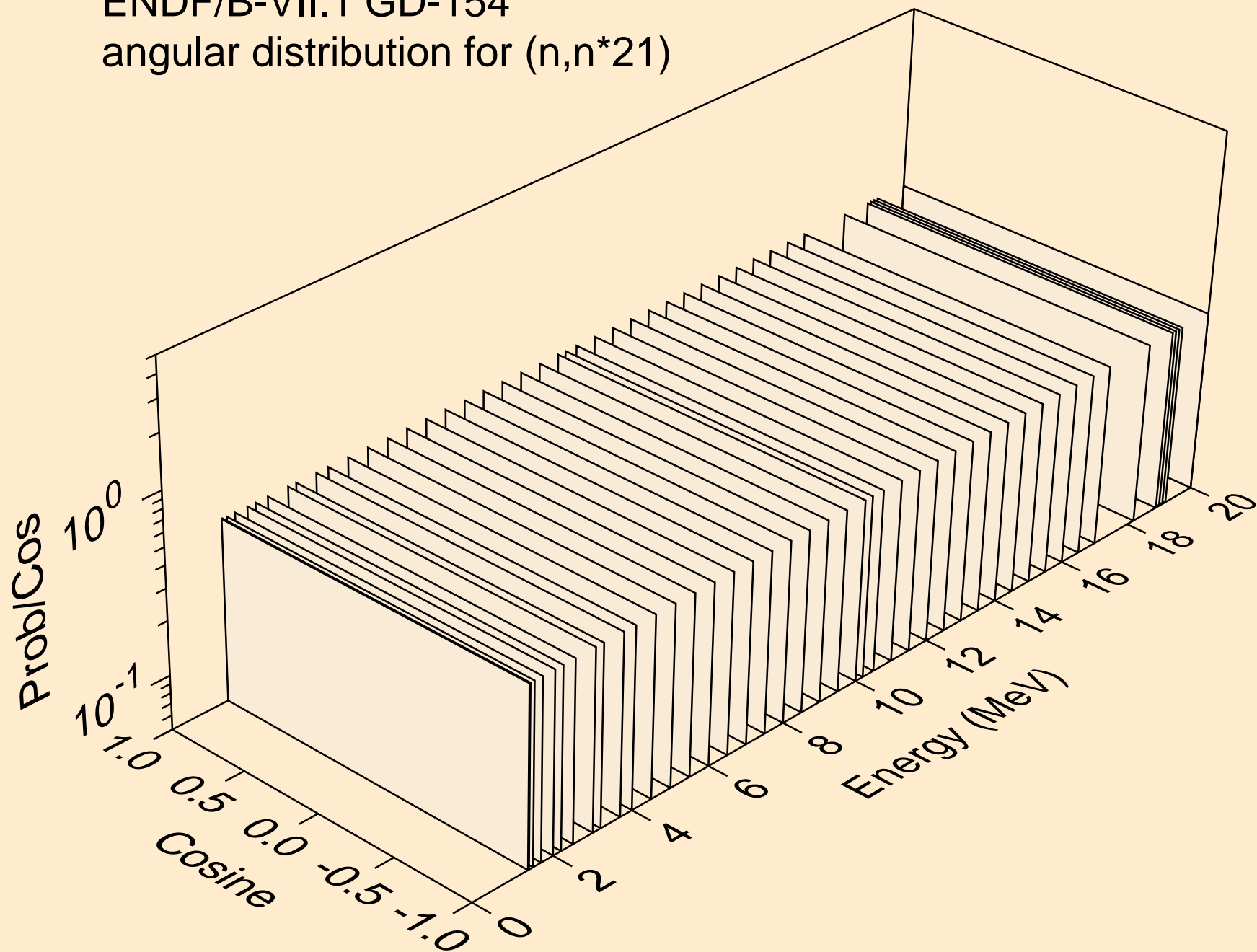

ENDF/B-VII.1 GD-154  
angular distribution for (n,n\*22)

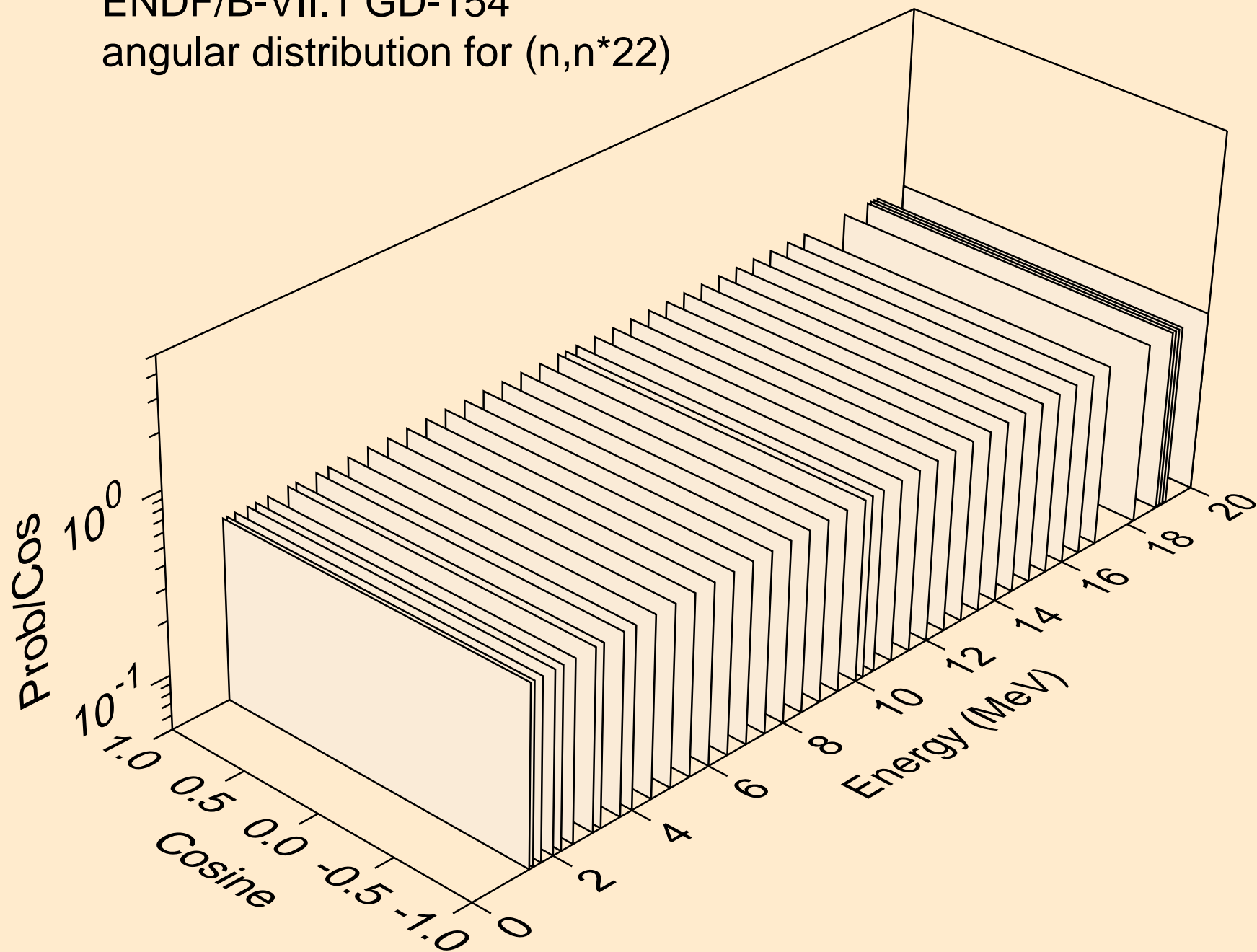

ENDF/B-VII.1 GD-154  
angular distribution for (n,n\*23)

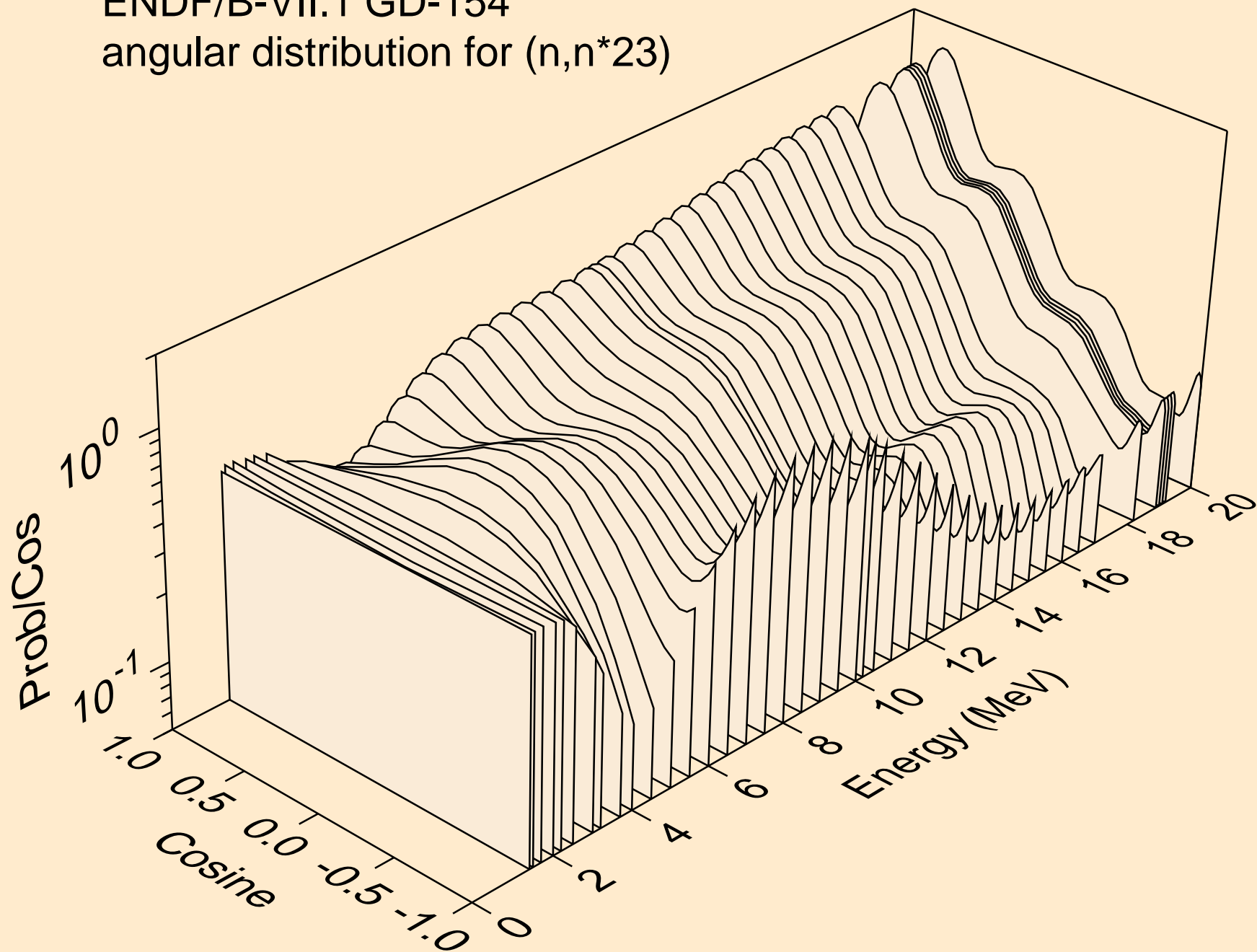

ENDF/B-VII.1 GD-154  
angular distribution for (n,n\*24)

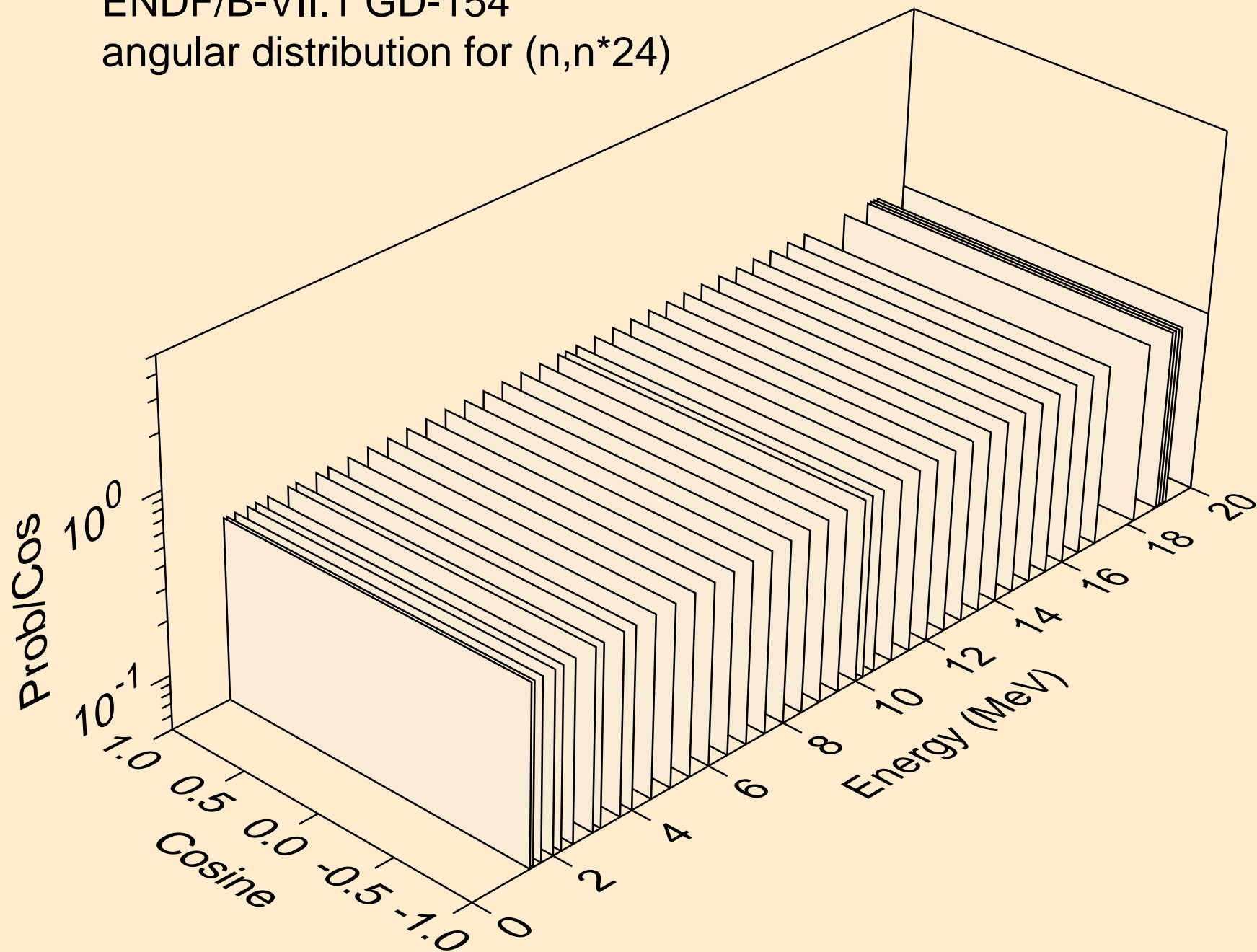

ENDF/B-VII.1 GD-154  
angular distribution for (n,n\*25)

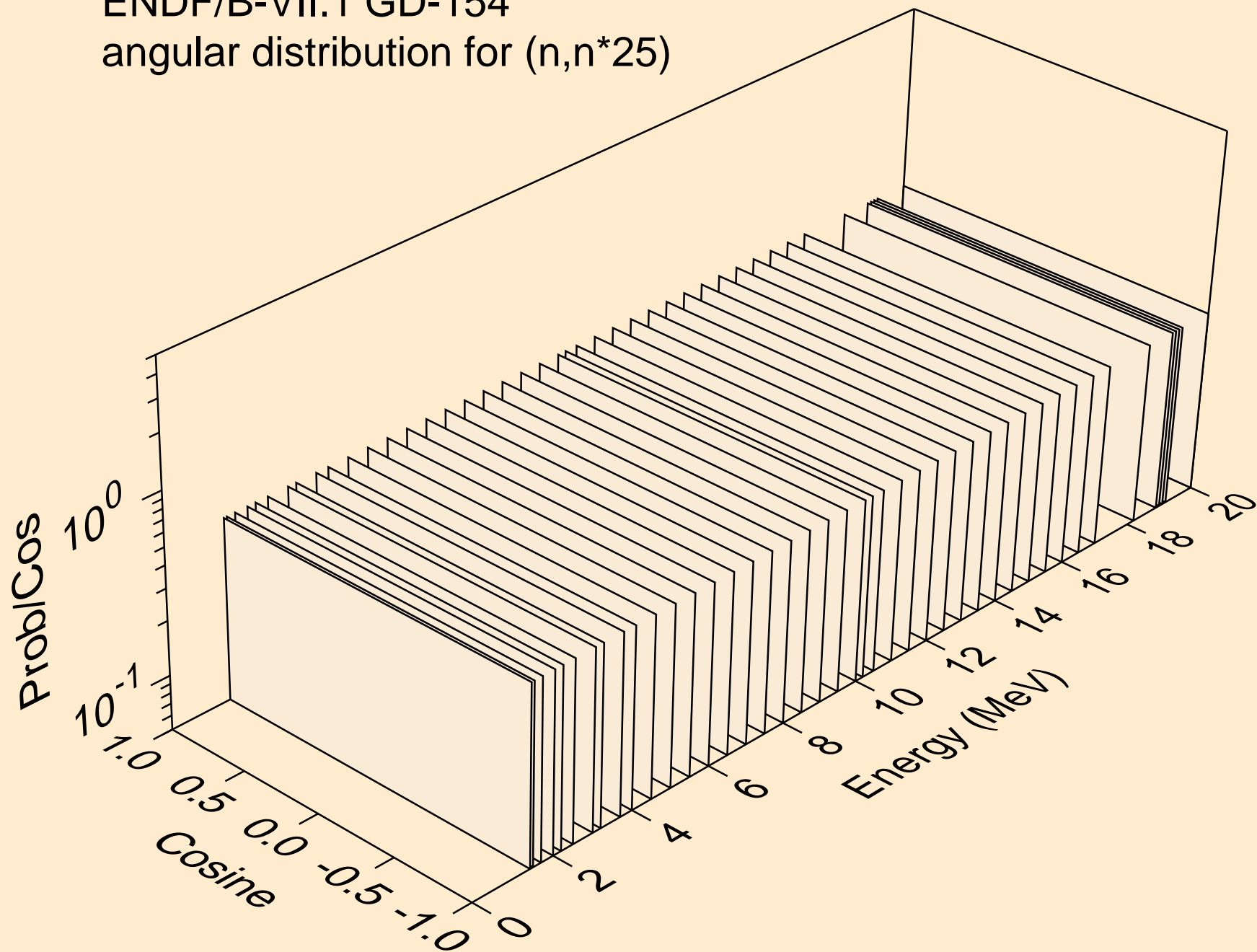



ENDF/B-VII.1 GD-154  
angular distribution for (n,n\*26)

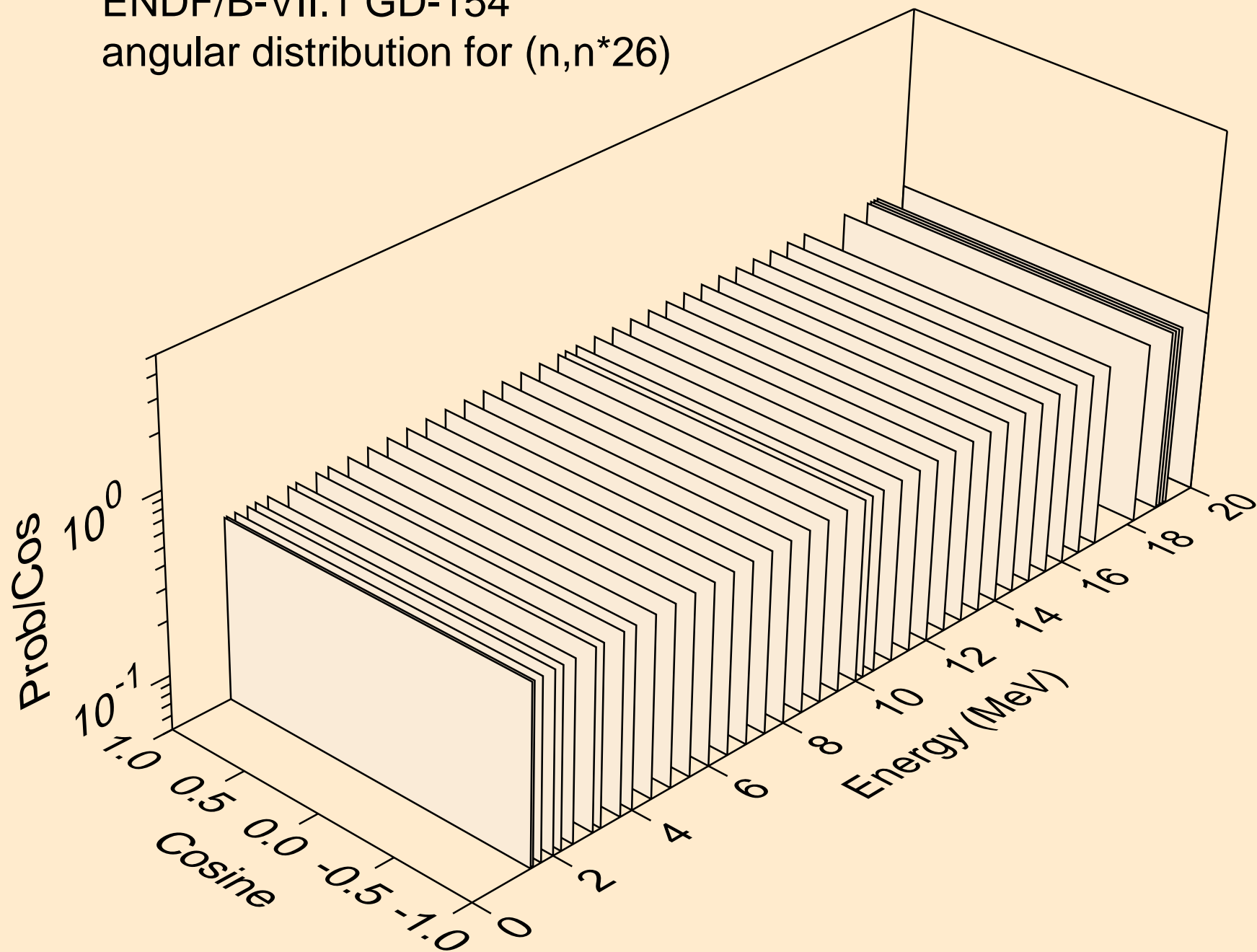

ENDF/B-VII.1 GD-154  
Neutron emission for (n,2n)

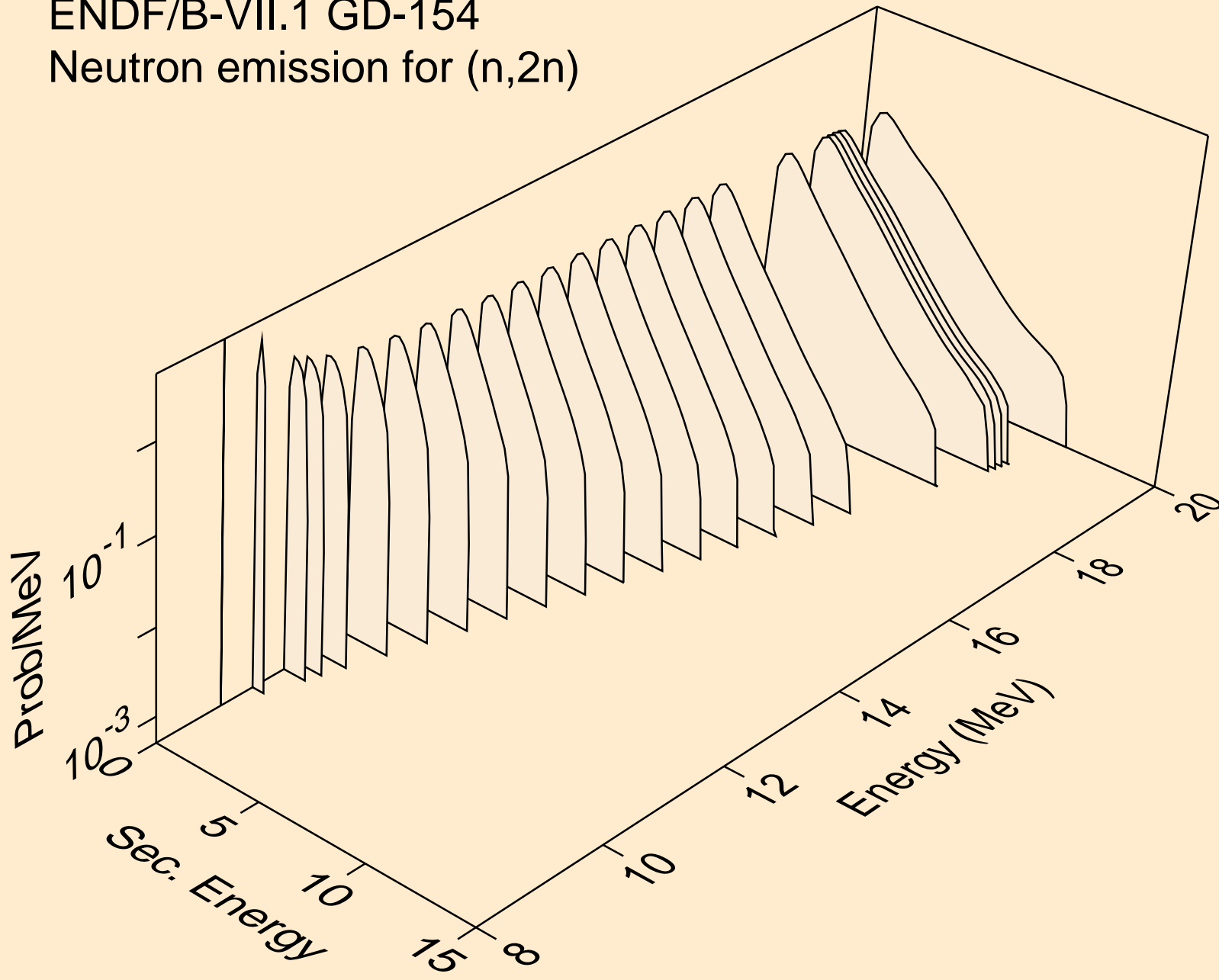

ENDF/B-VII.1 GD-154  
Neutron emission for (n,3n)

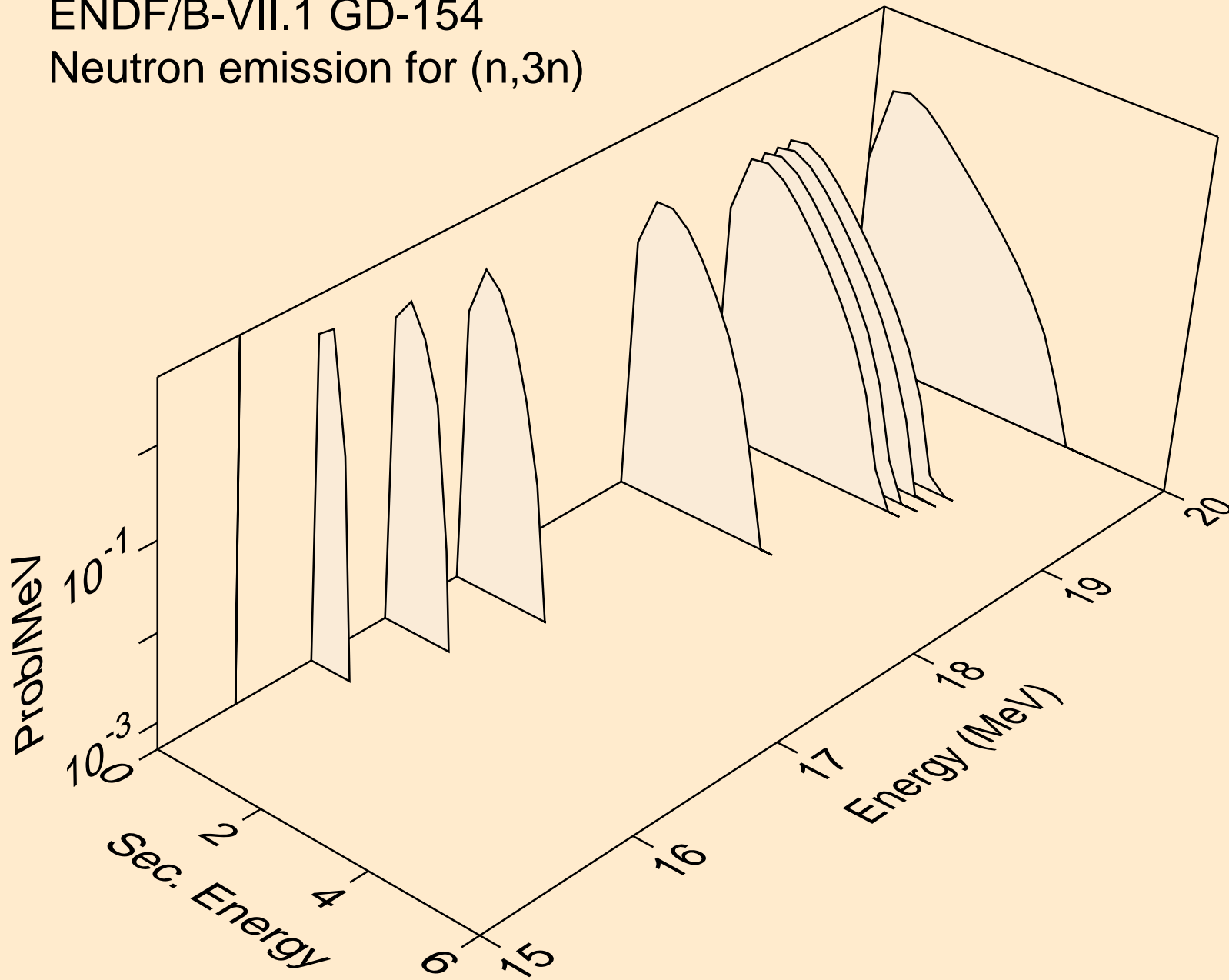

ENDF/B-VII.1 GD-154  
Neutron emission for (n,n\*)a

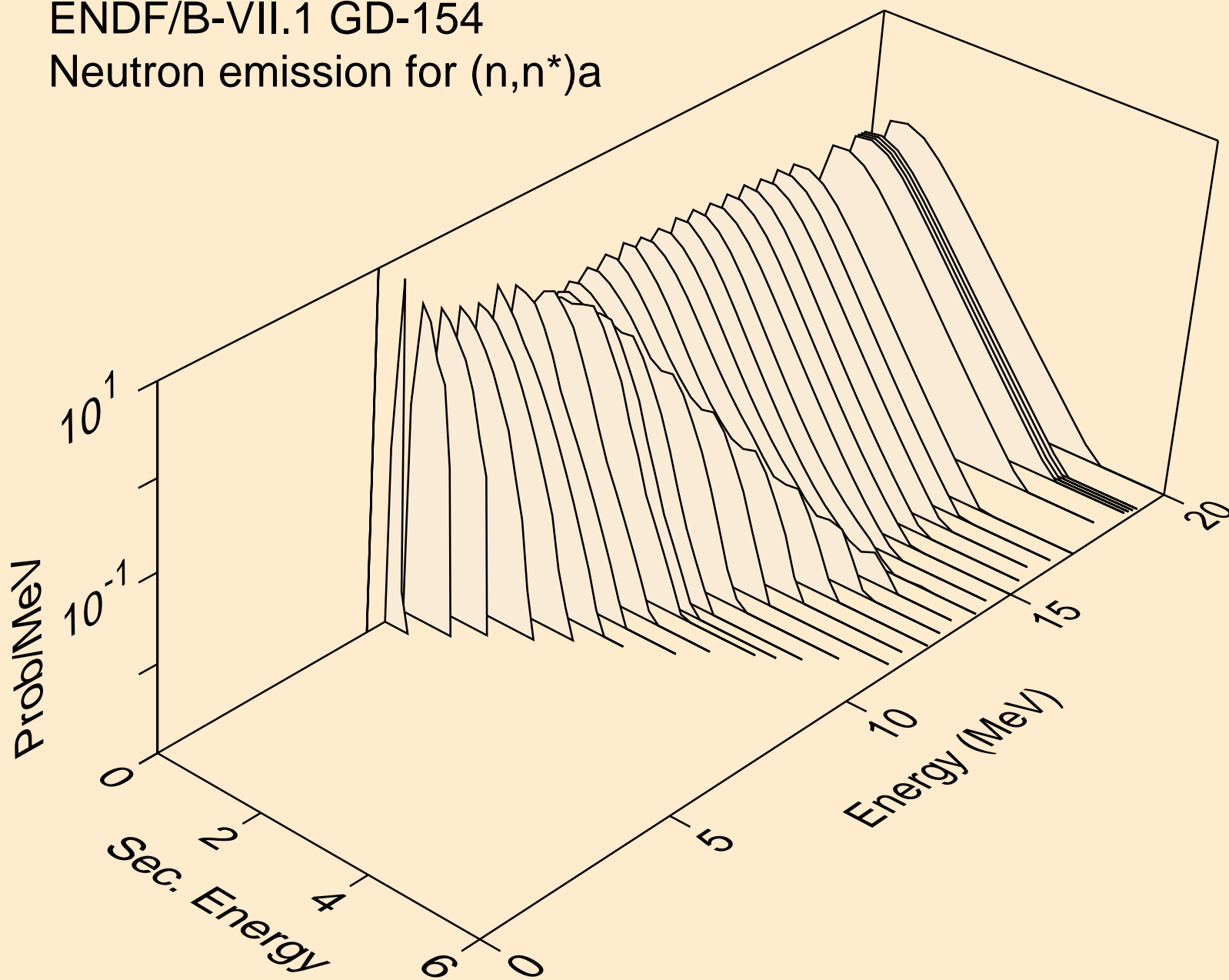

ENDF/B-VII.1 GD-154  
Neutron emission for (n,2n)a

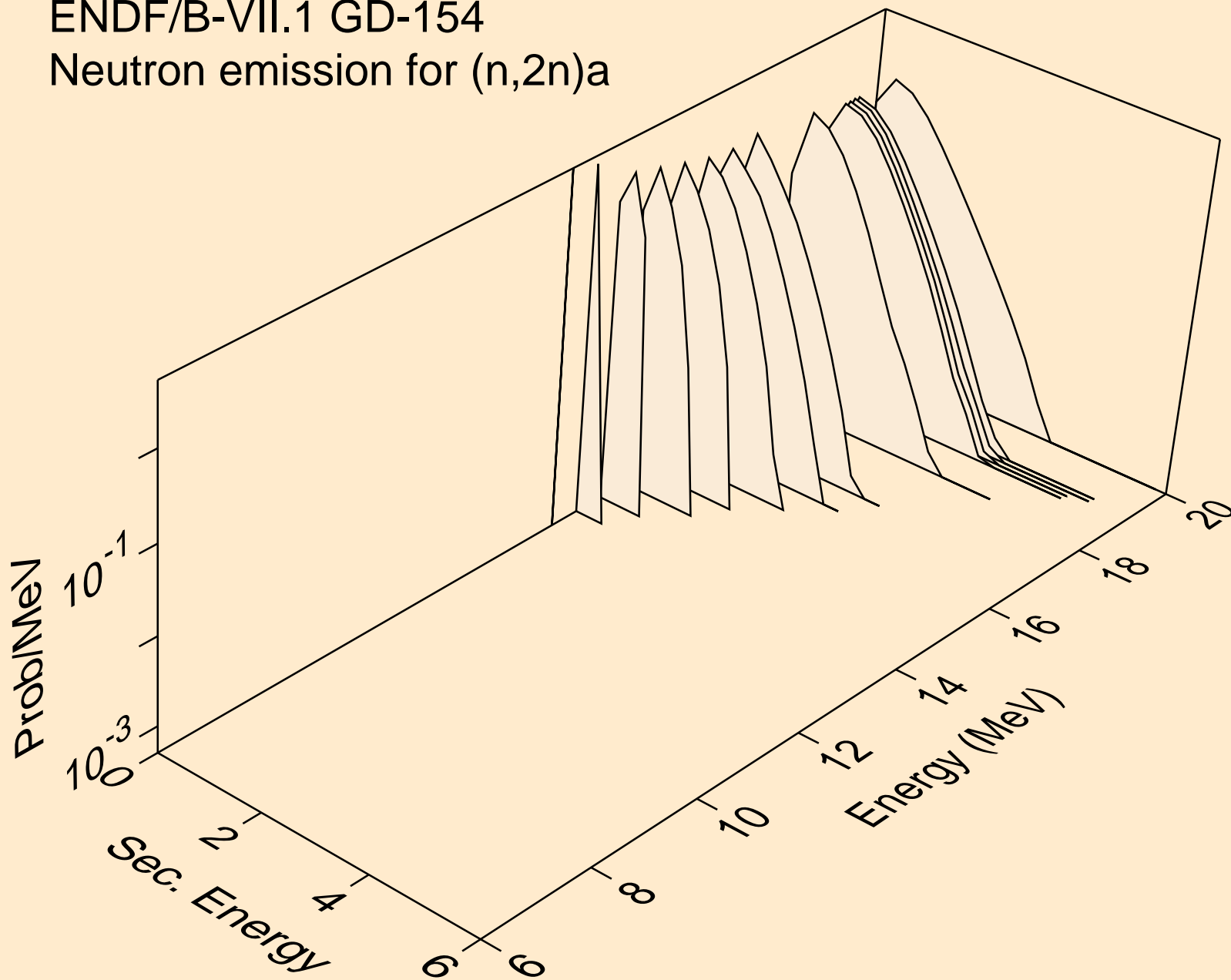

ENDF/B-VII.1 GD-154  
Neutron emission for (n,n\*)p

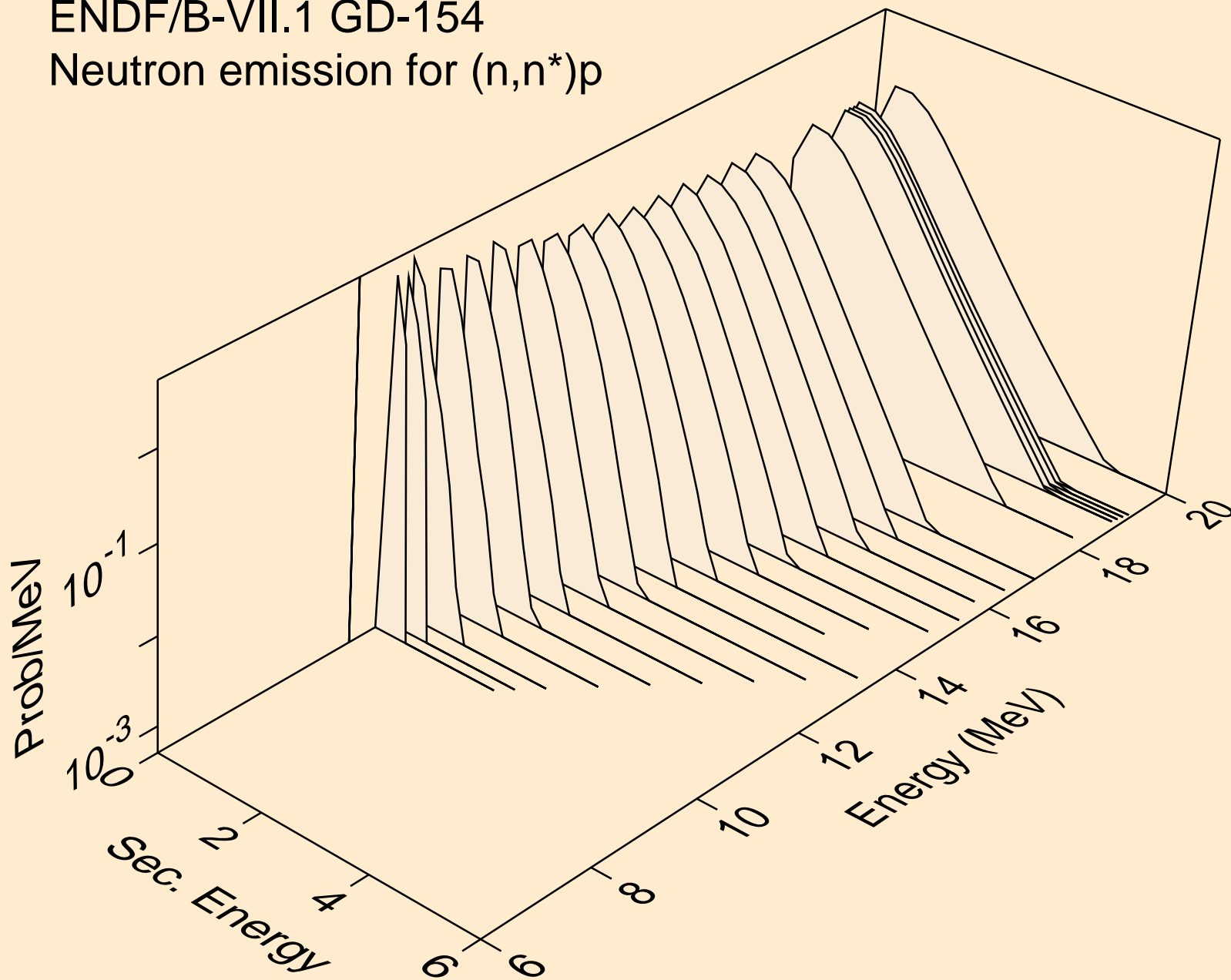

ENDF/B-VII.1 GD-154  
Neutron emission for (n,2np)

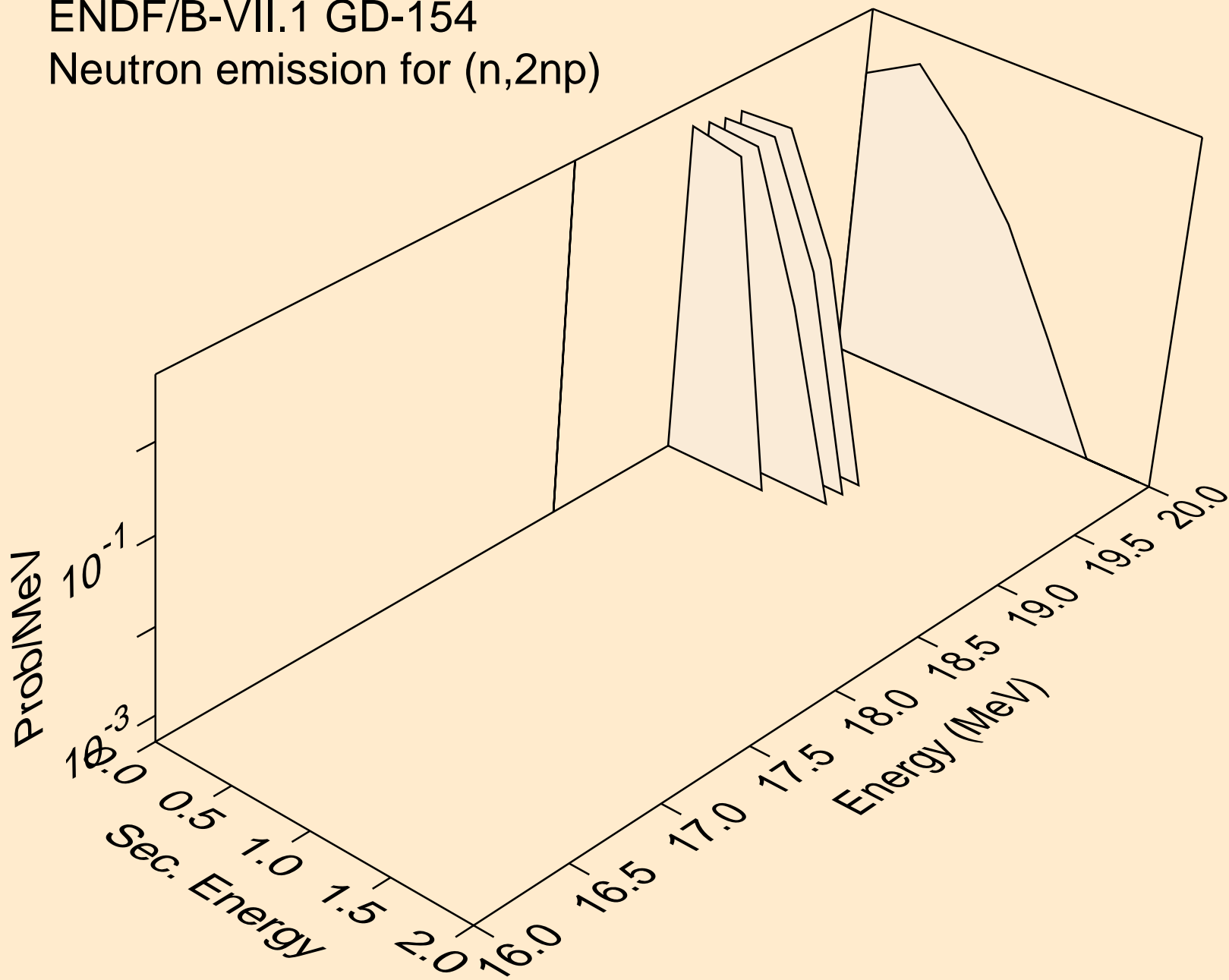

ENDF/B-VII.1 GD-154  
Neutron emission for (n,n\*c)

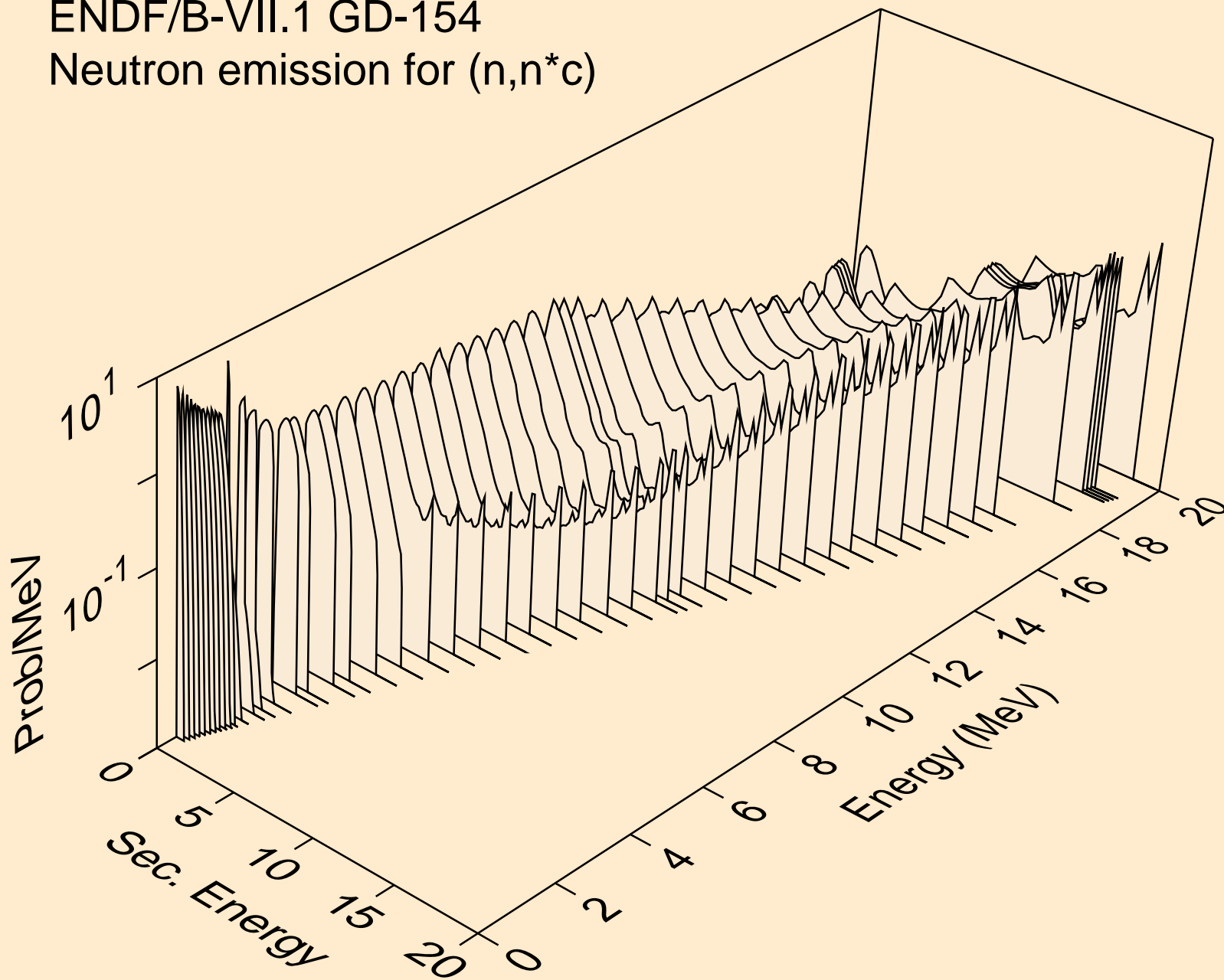



ENDF/B-VII.1 GD-154  
Photon emission for (n,2n)

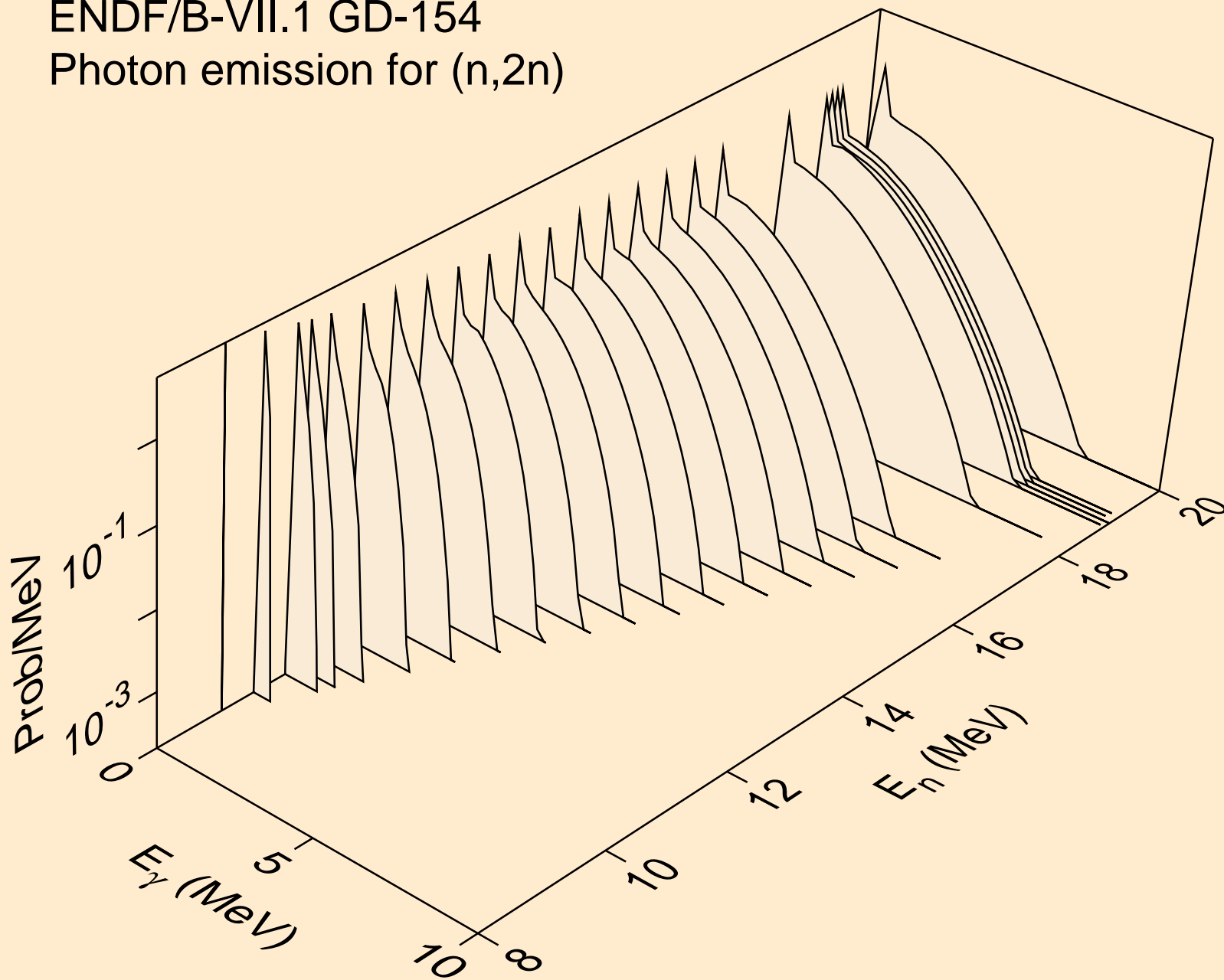

ENDF/B-VII.1 GD-154  
Photon emission for (n,3n)

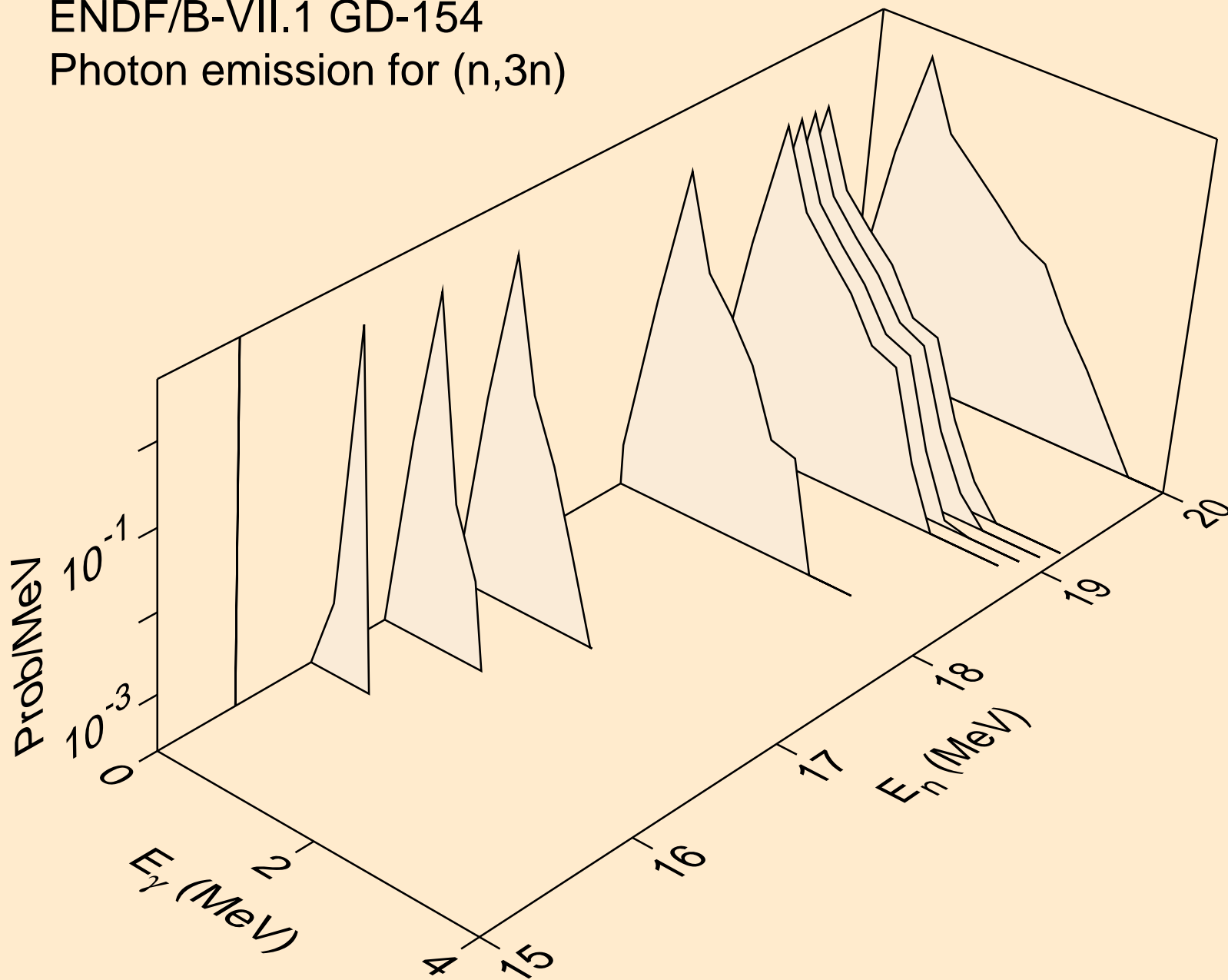

ENDF/B-VII.1 GD-154  
Photon emission for (n,n\*)a

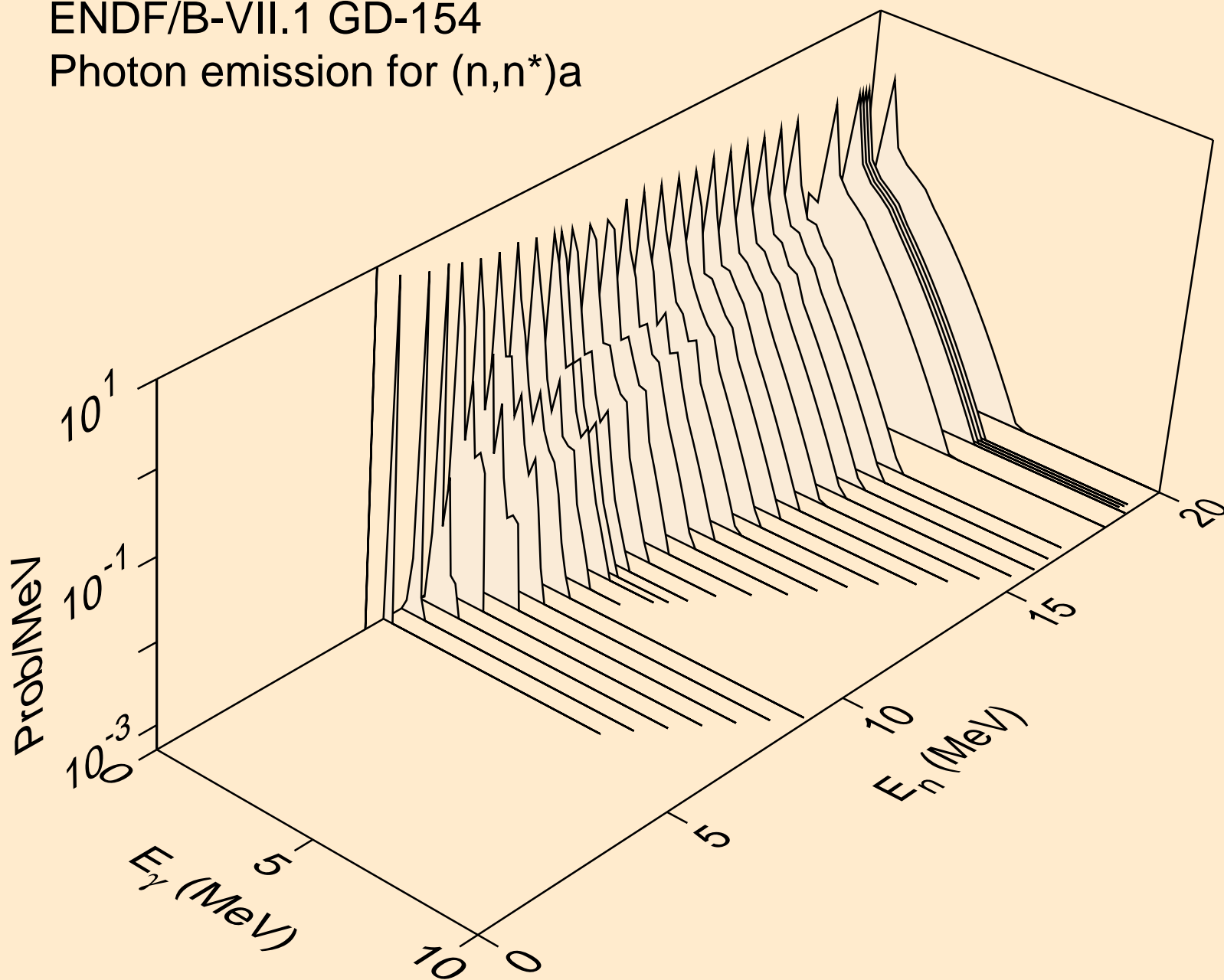

ENDF/B-VII.1 GD-154  
Photon emission for (n,2n)a

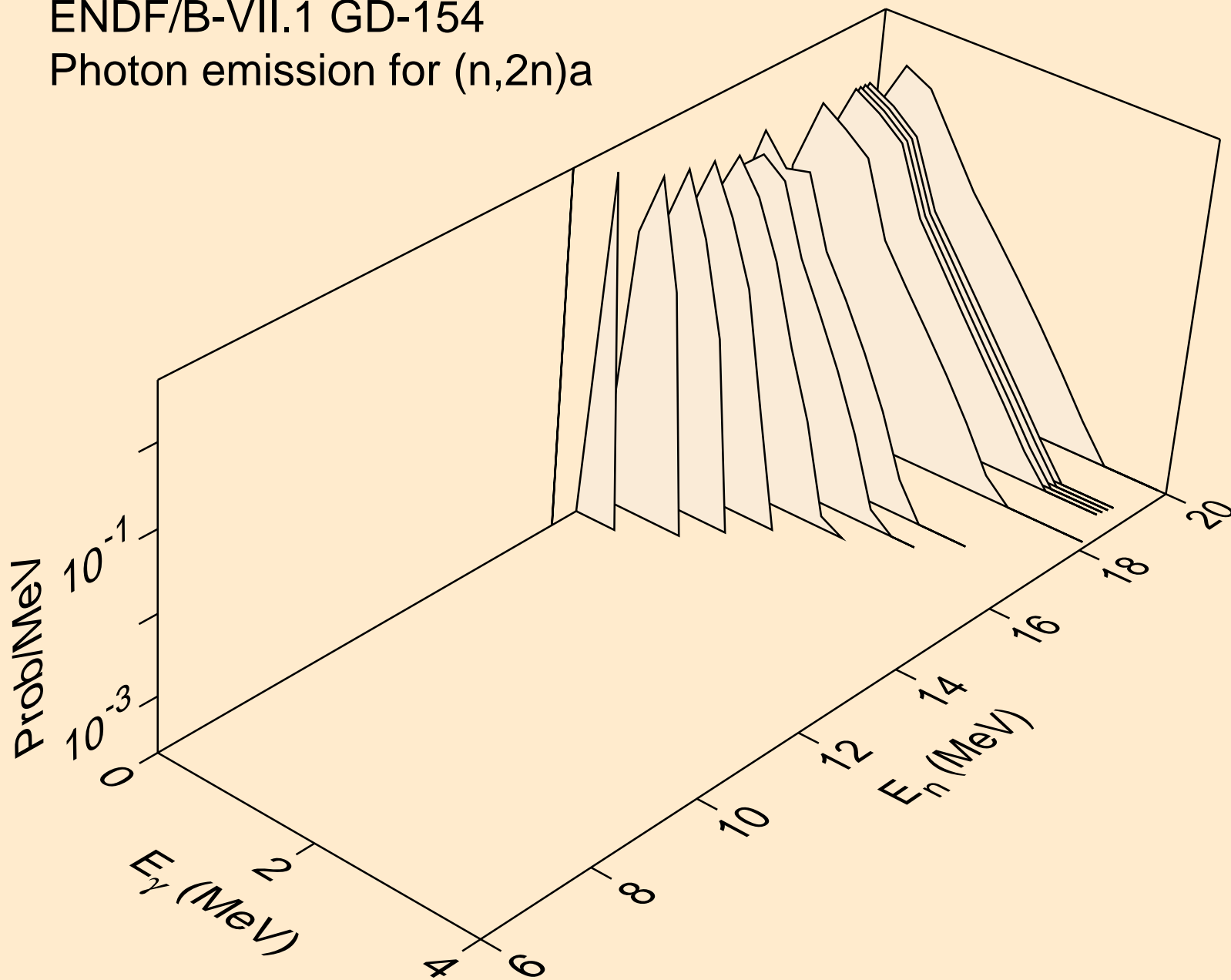

ENDF/B-VII.1 GD-154  
Photon emission for (n,n\*)p

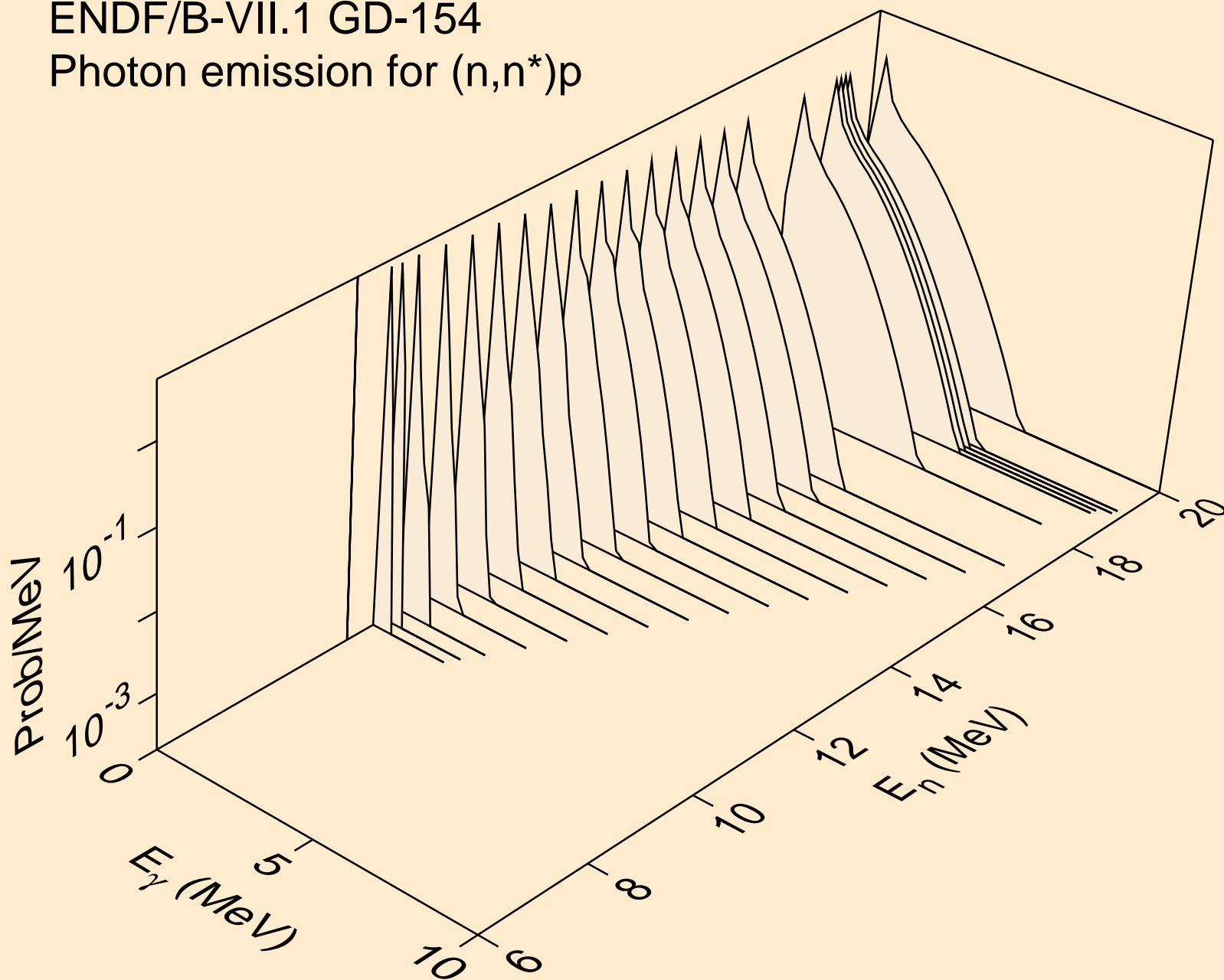

ENDF/B-VII.1 GD-154  
Photon emission for (n,2np)

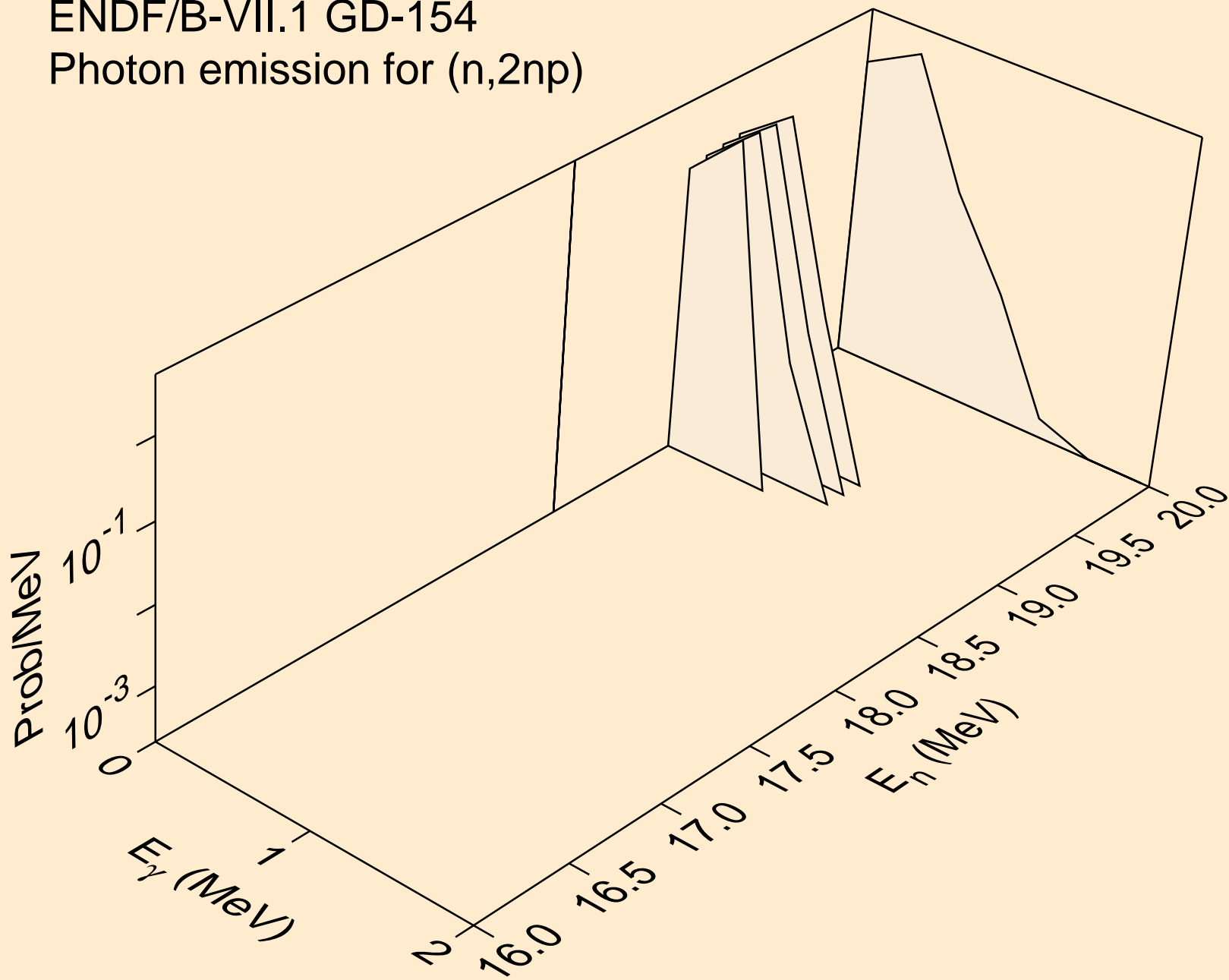

ENDF/B-VII.1 GD-154  
Photon emission for (n,n\*c)

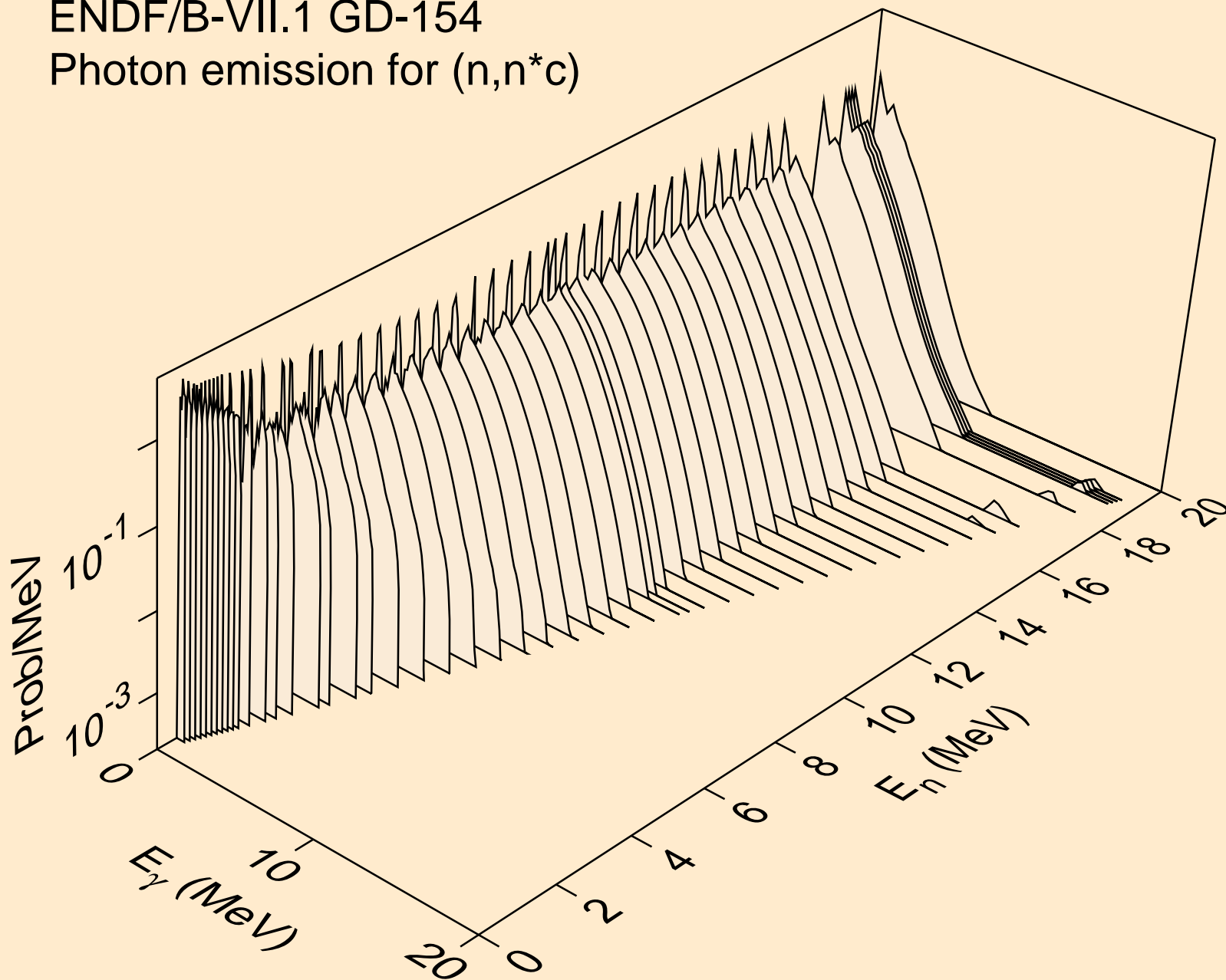

ENDF/B-VII.1 GD-154  
Photon emission for (n,gma)

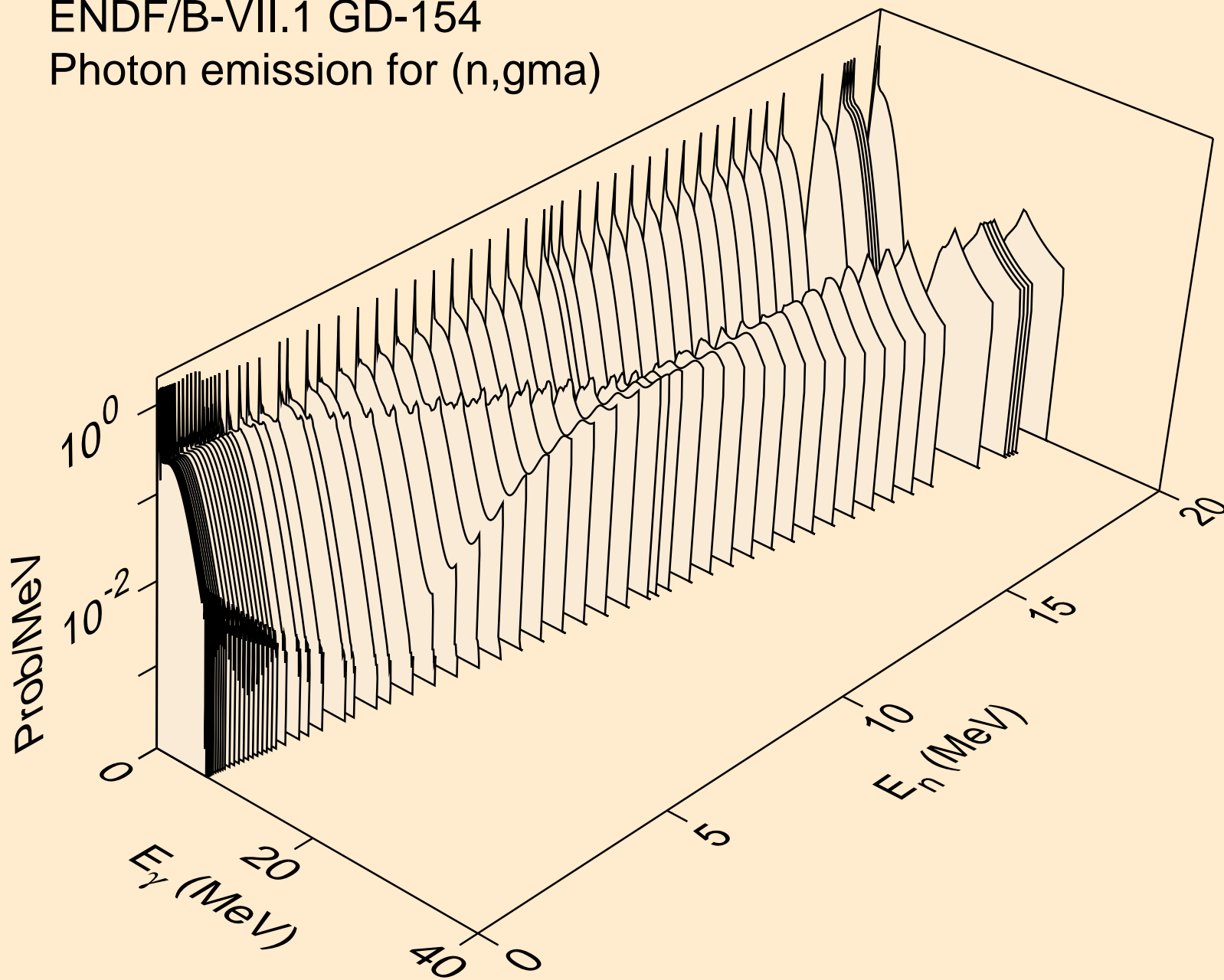



ENDF/B-VII.1 GD-154  
Photon emission for (n,p\*c)

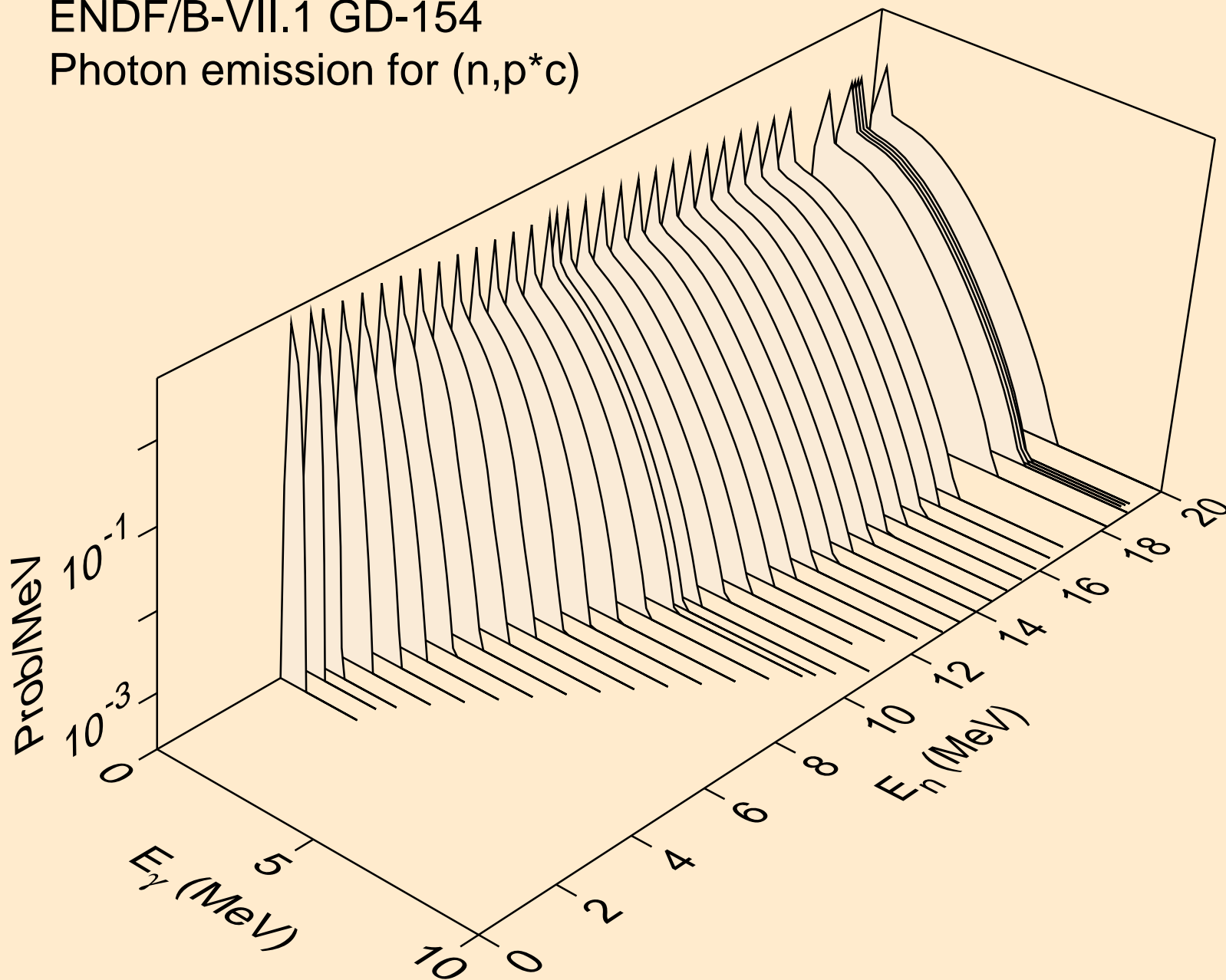

ENDF/B-VII.1 GD-154  
Photon emission for (n,a\*c)

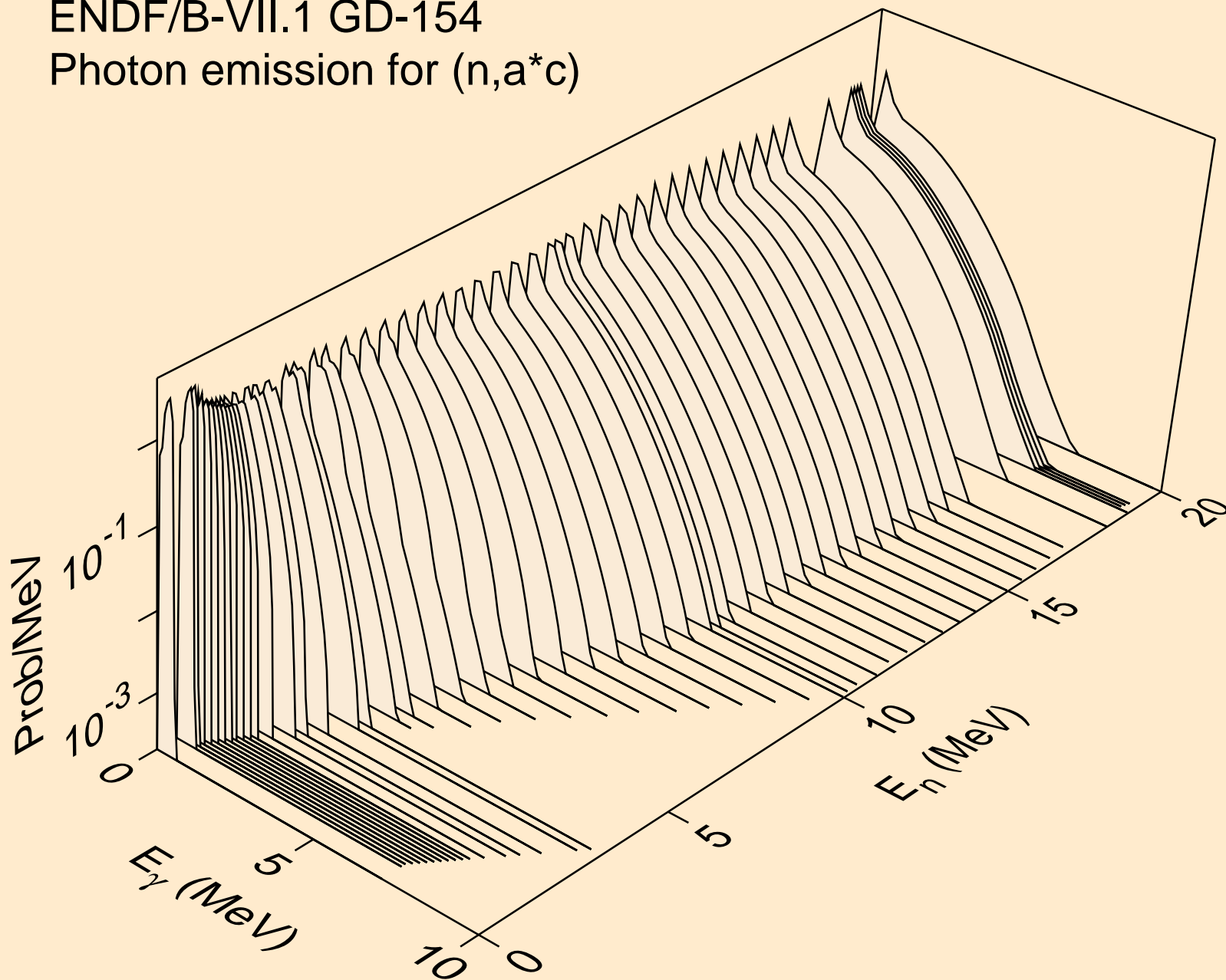

ENDF/B-VII.1 GD-154  
thermal capture photon spectrum

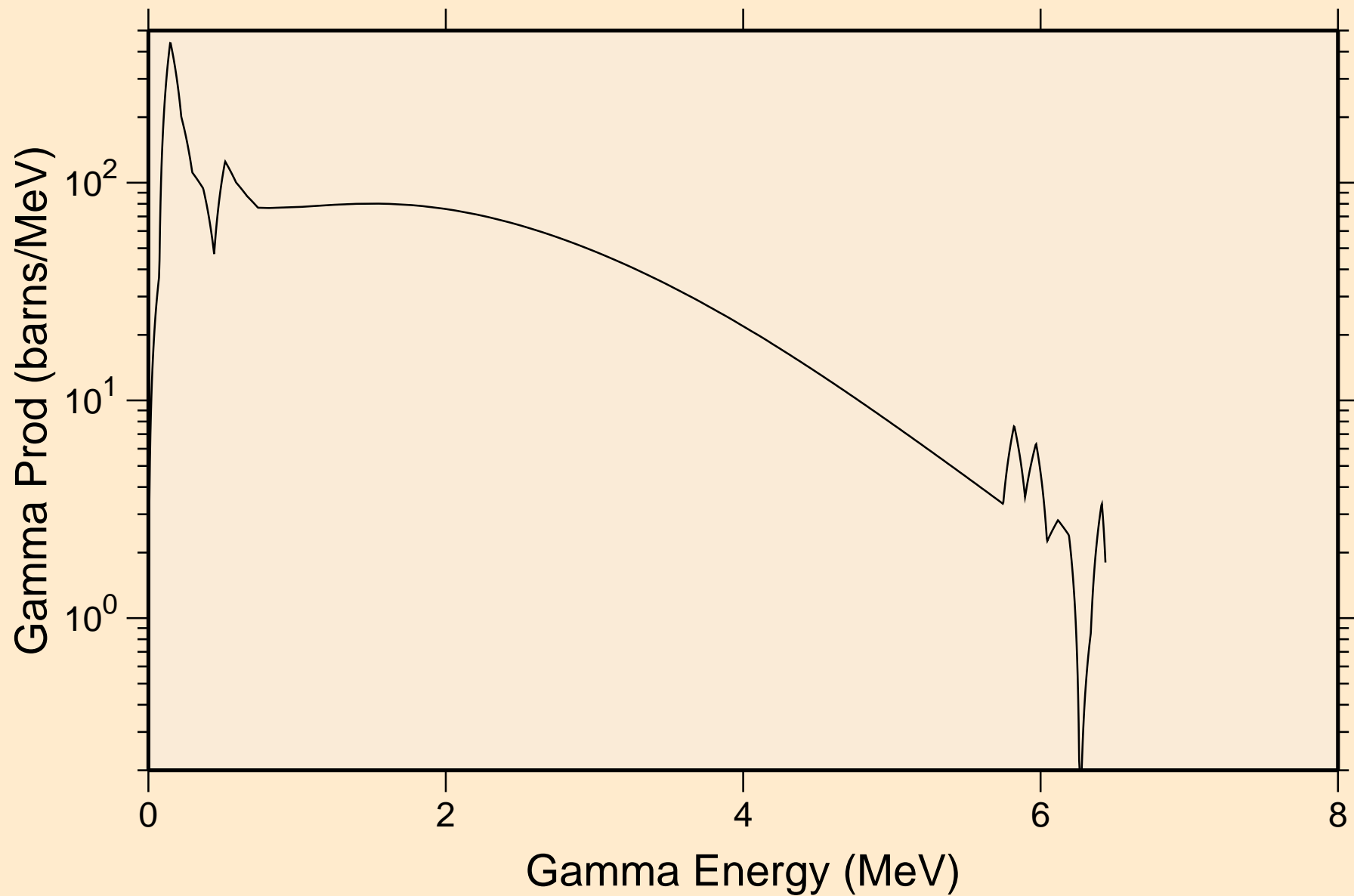

ENDF/B-VII.1 GD-154  
14 MeV photon spectrum

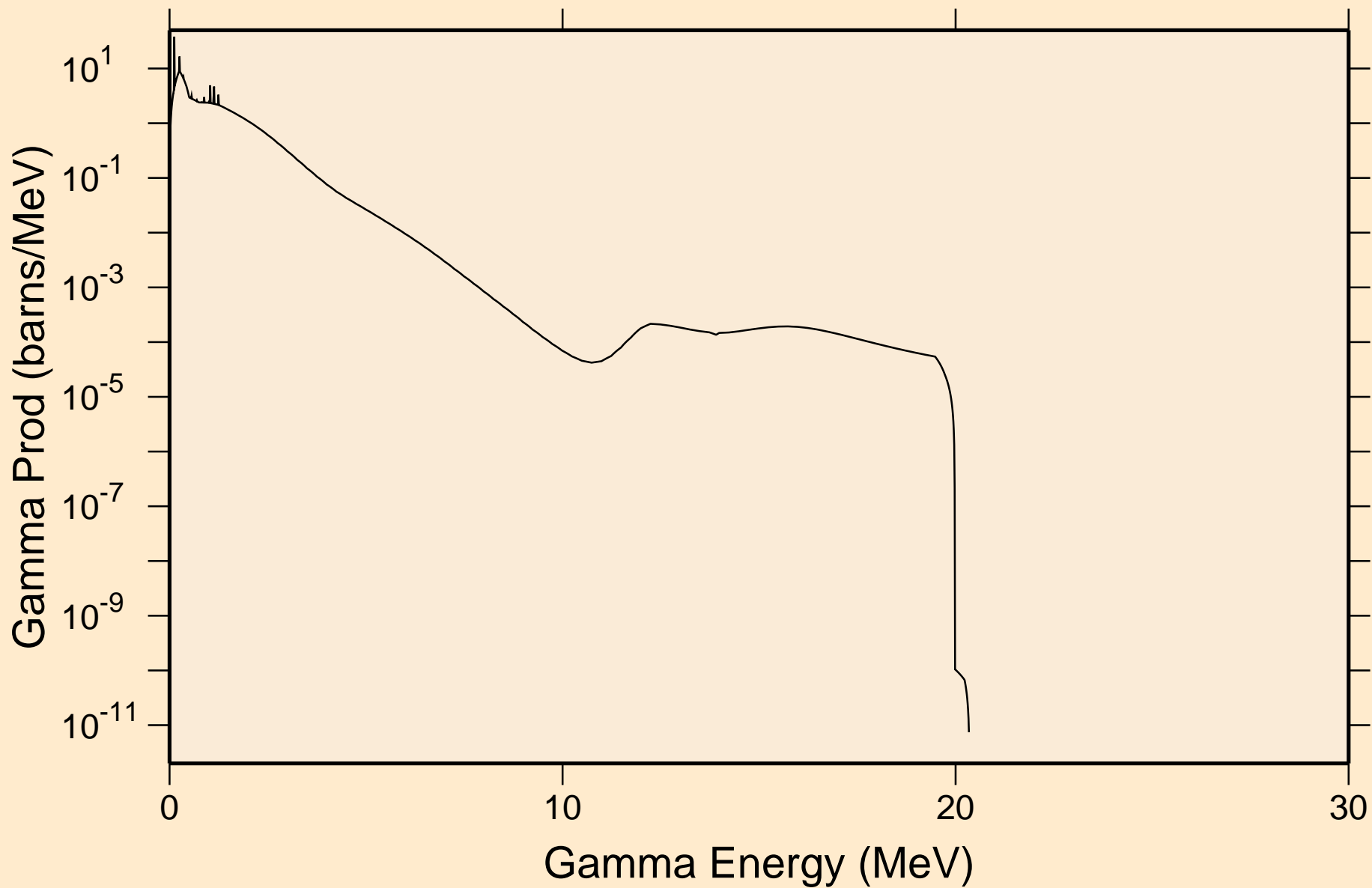

# ENDF/B-VII.1 GD-154

## Particle heating contributions

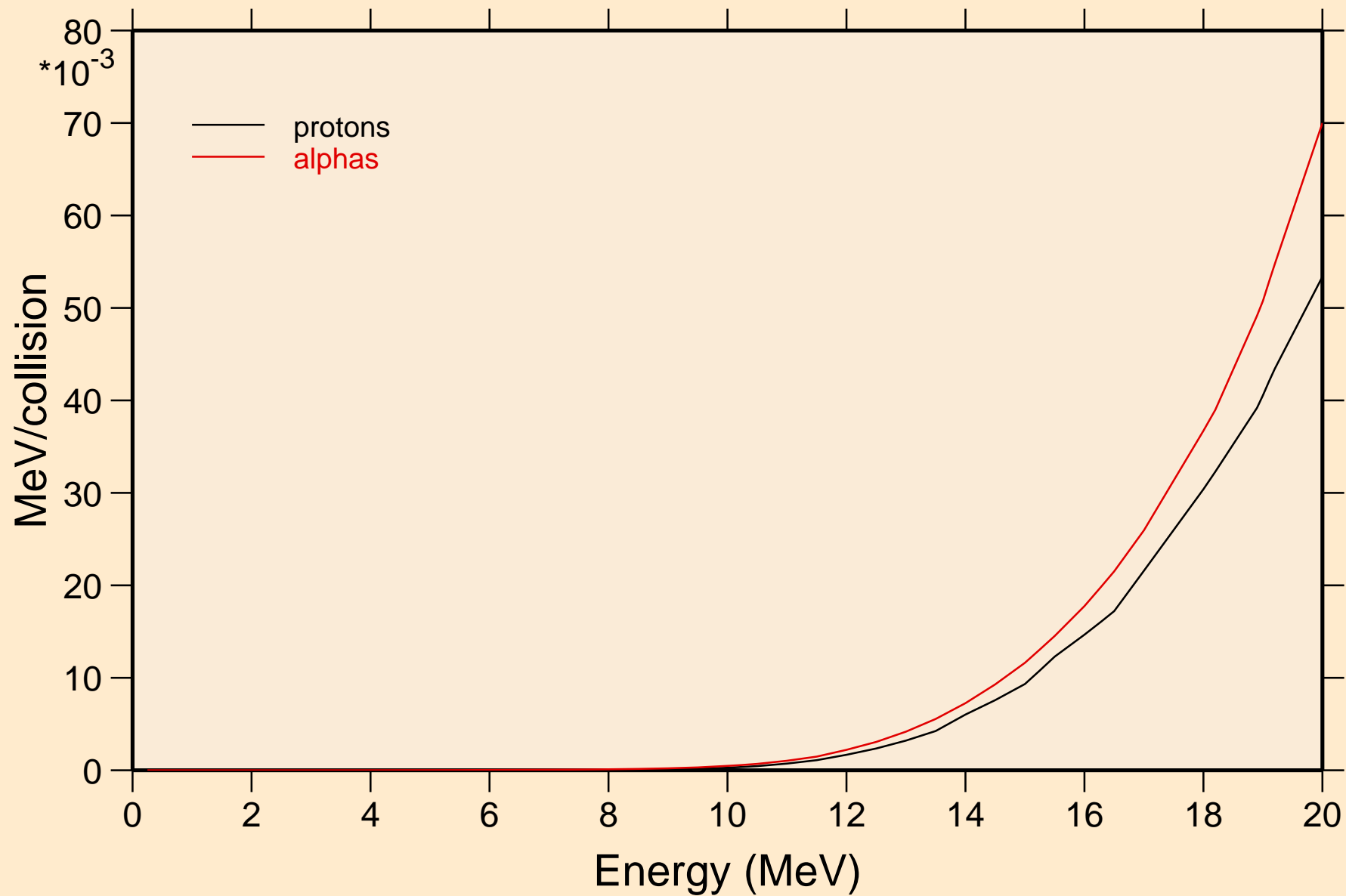

# ENDF/B-VII.1 GD-154 Recoil Heating

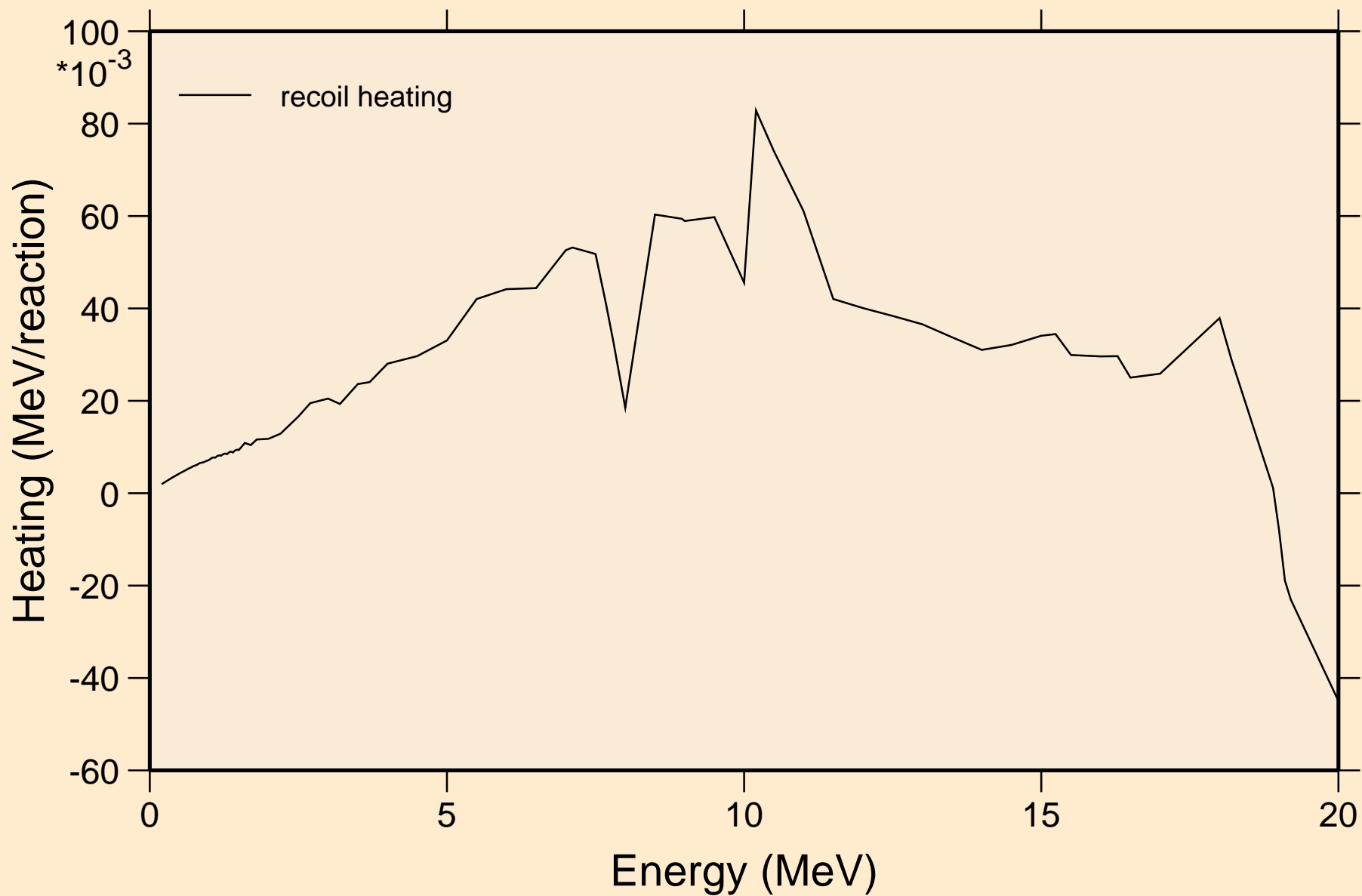

# ENDF/B-VII.1 GD-154

## Particle production cross sections

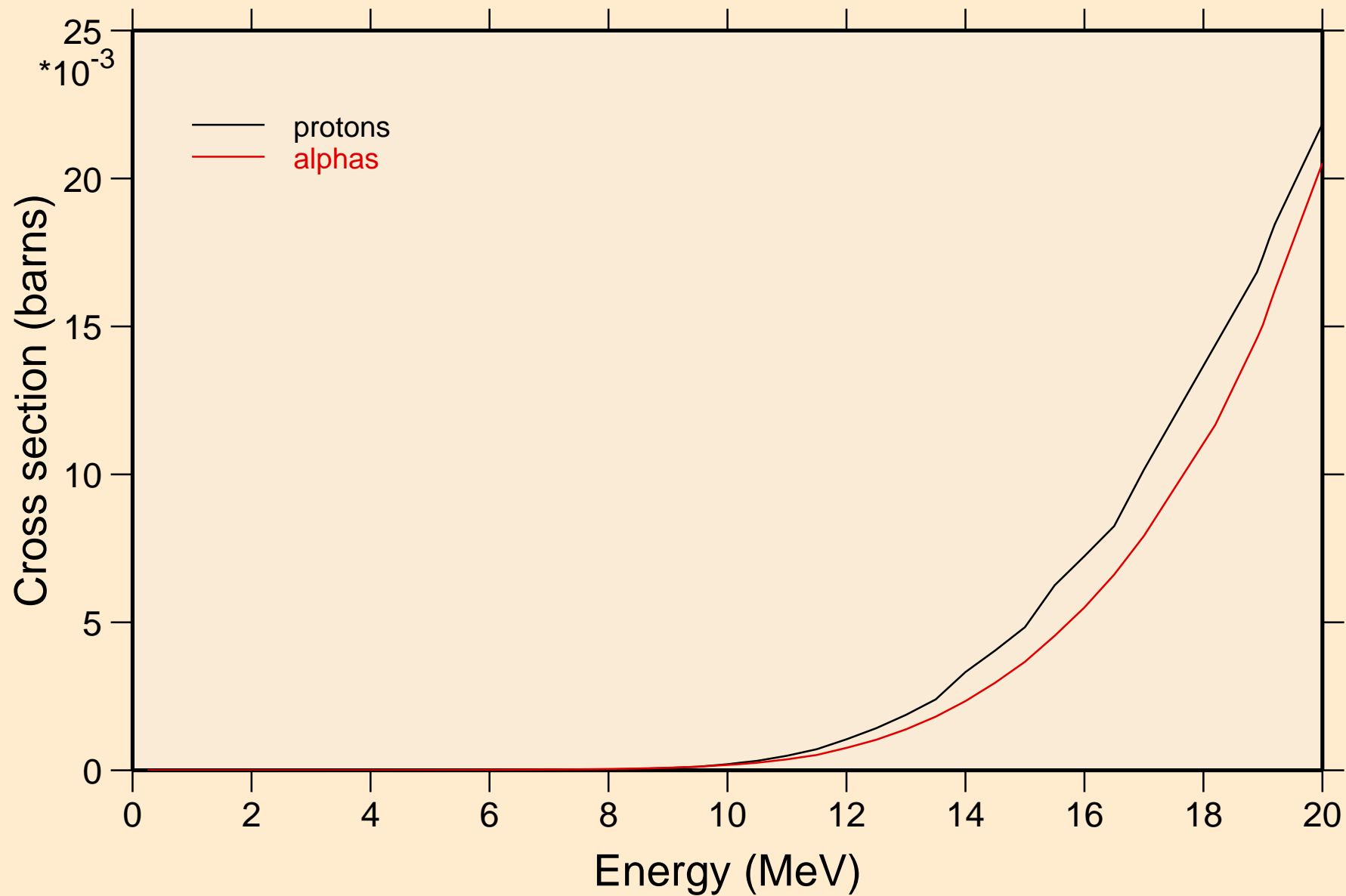

ENDF/B-VII.1 GD-154  
protons from (n,n\*)p

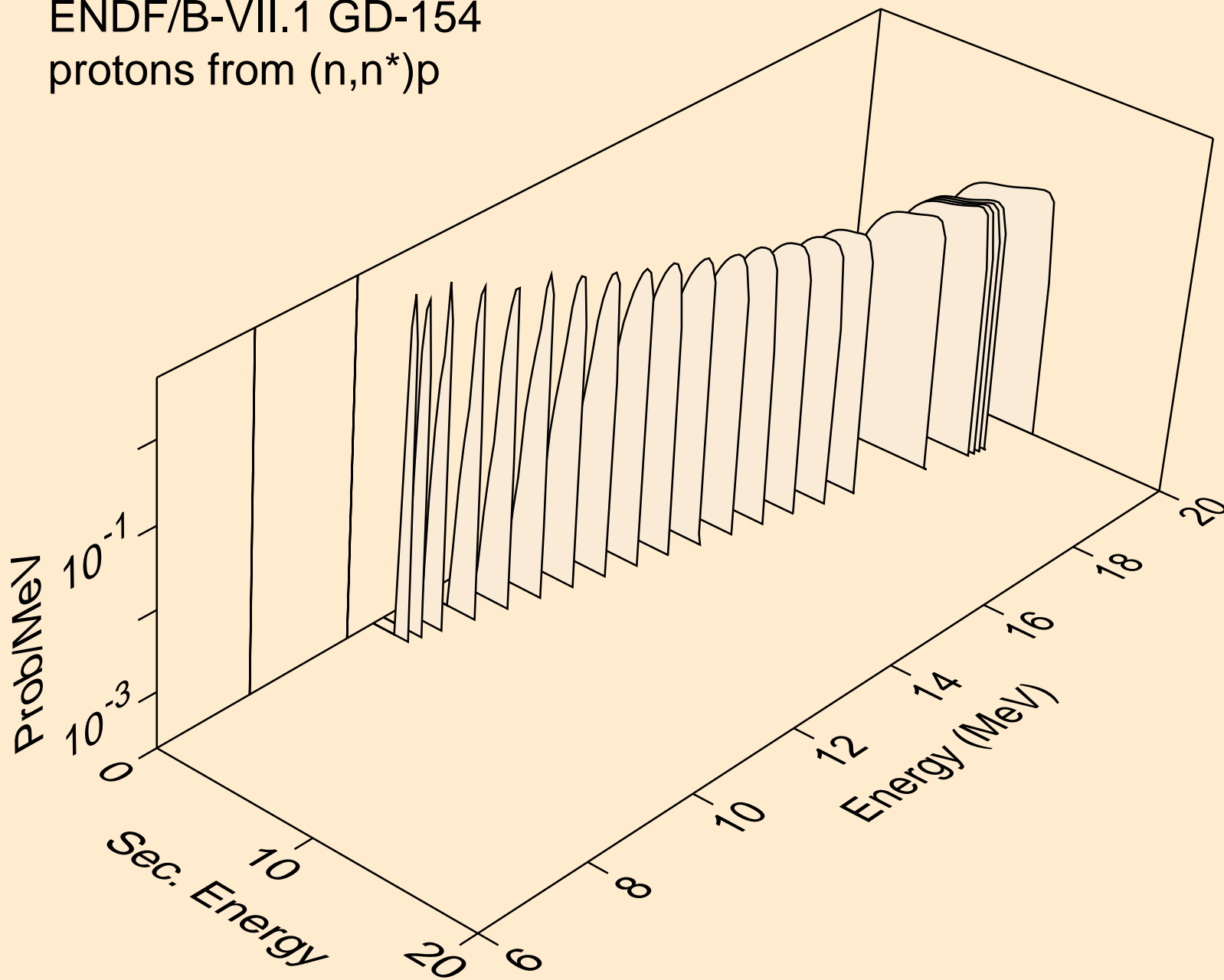



ENDF/B-VII.1 GD-154  
protons from (n,2np)

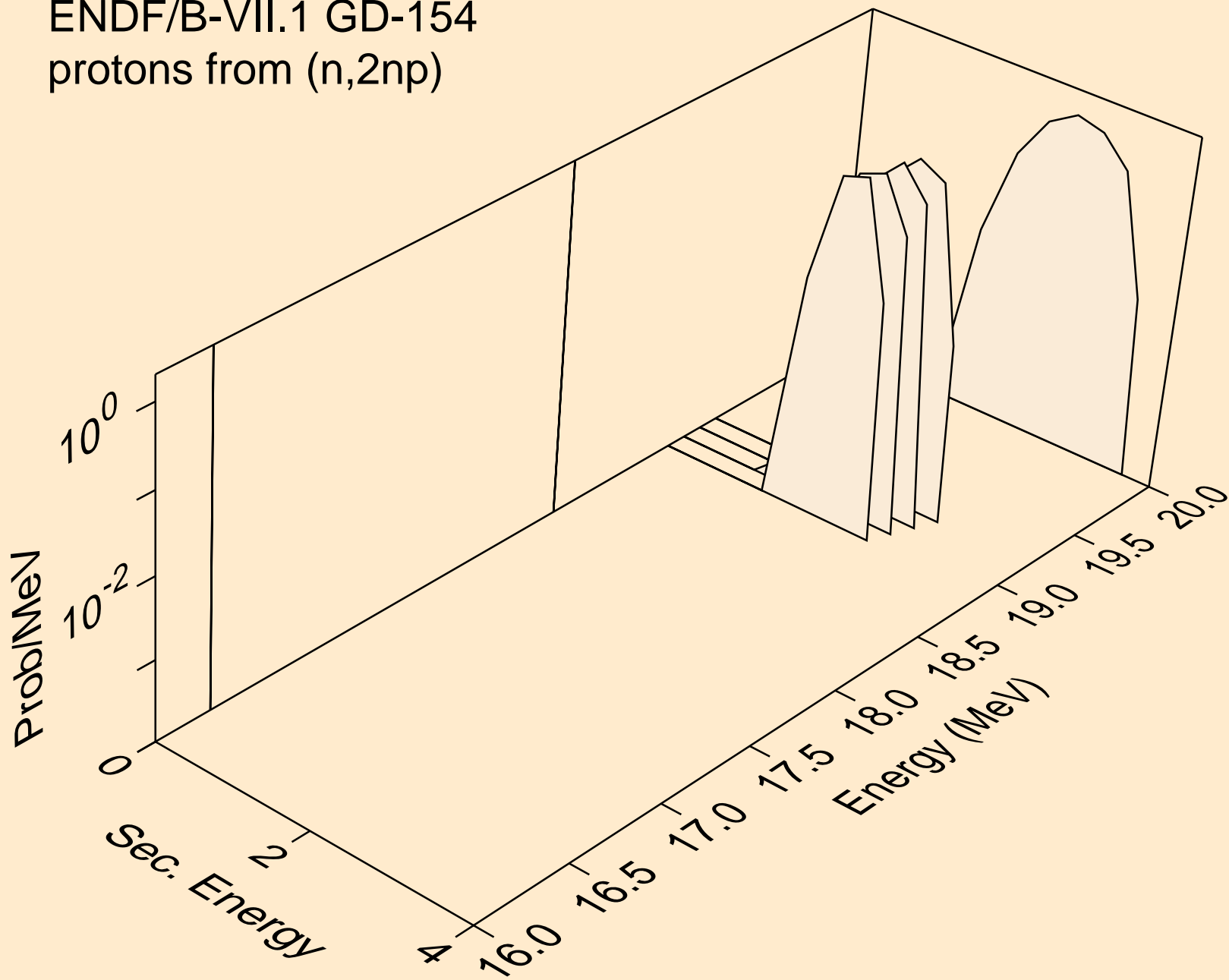

ENDF/B-VII.1 GD-154  
angular distribution for (n,p\*0) proton

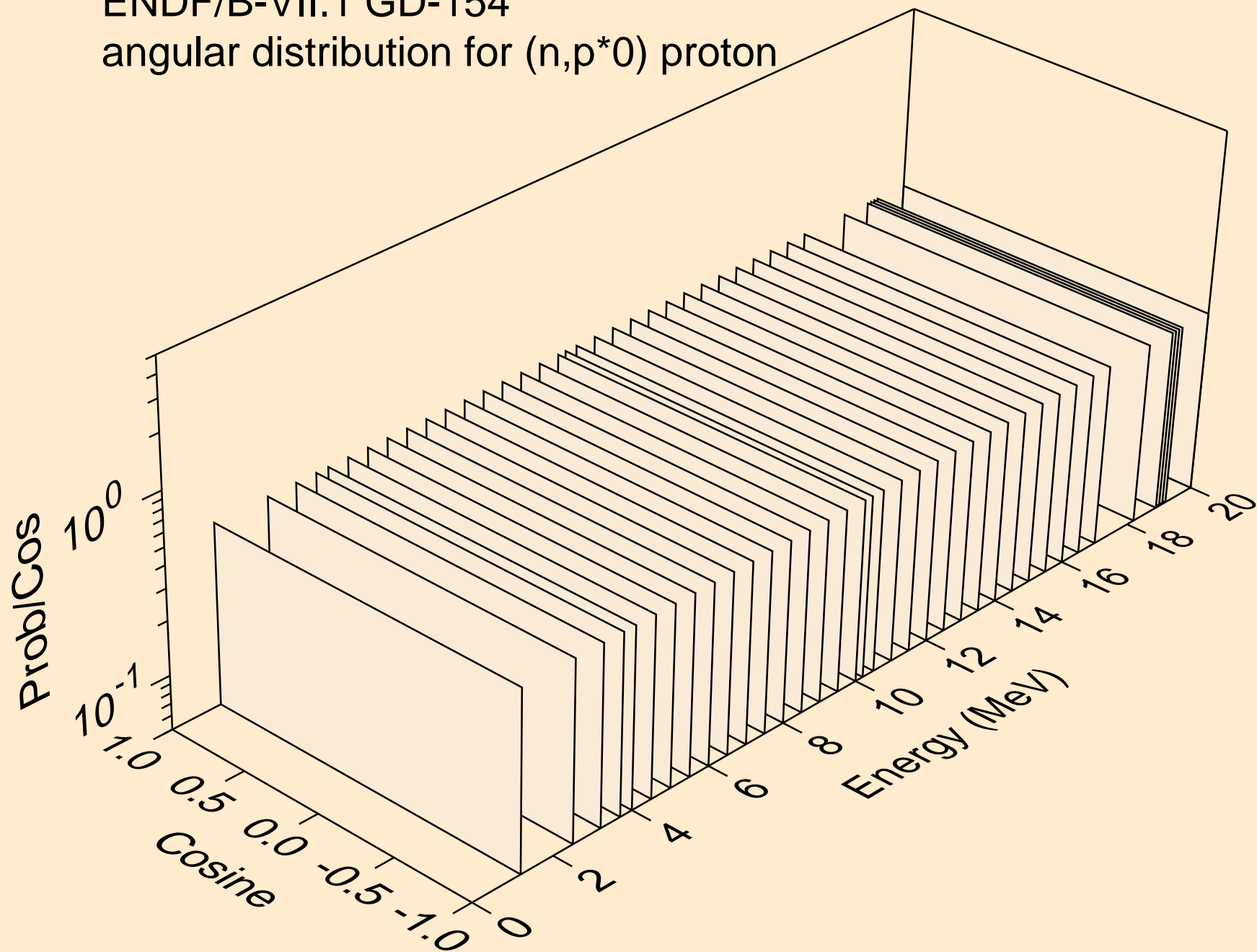

ENDF/B-VII.1 GD-154  
angular distribution for (n,p\*1) proton

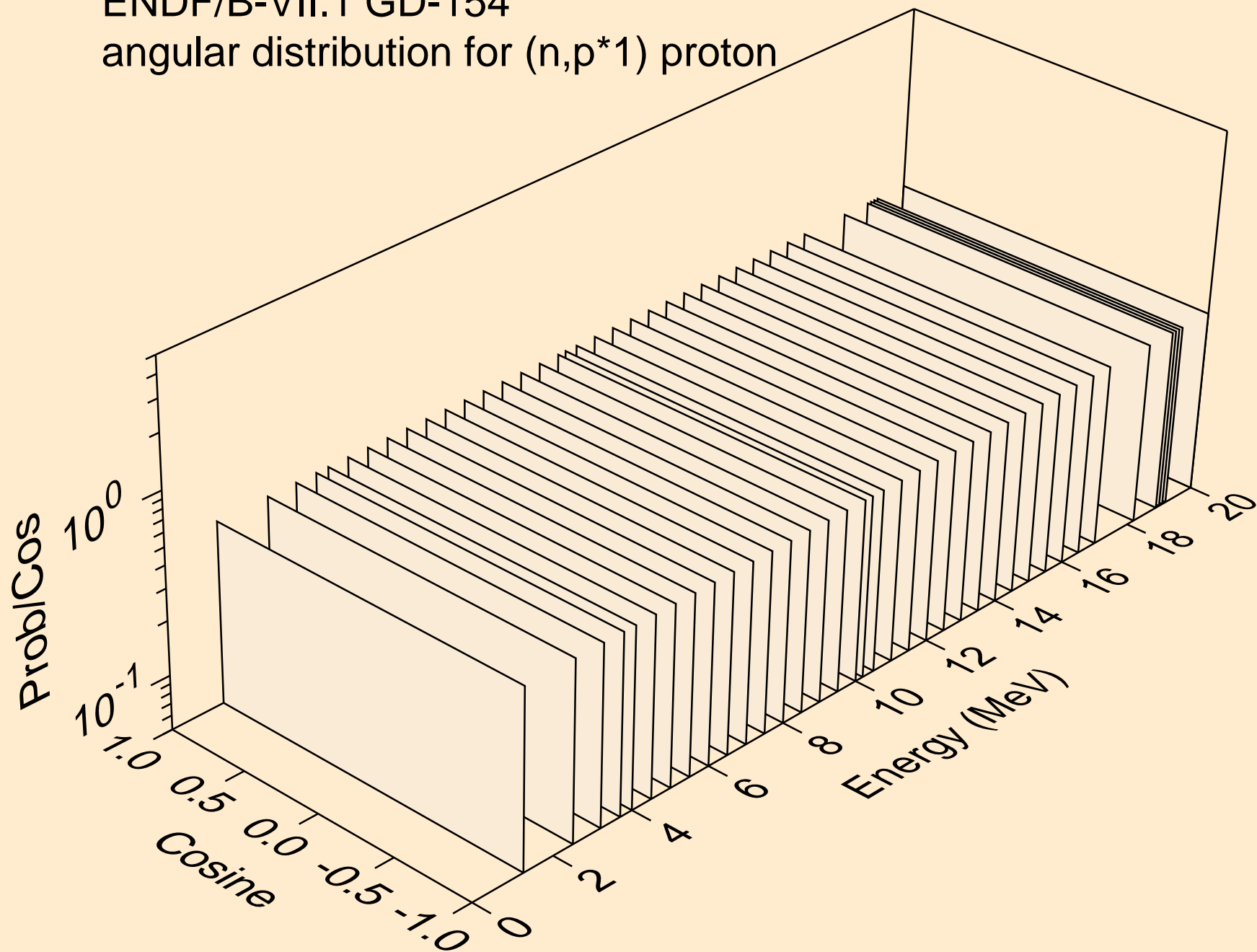

ENDF/B-VII.1 GD-154  
angular distribution for (n,p\*2) proton

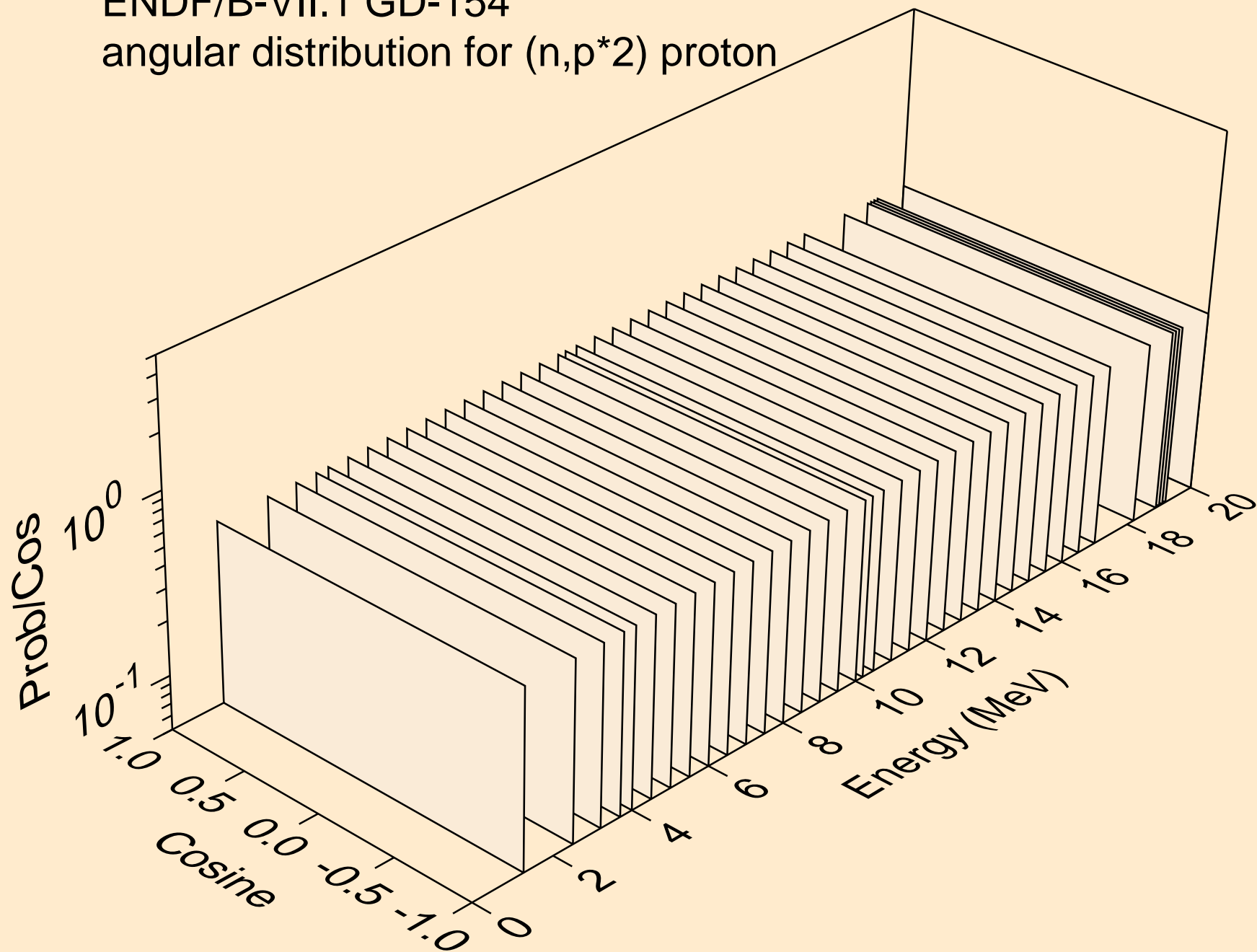

ENDF/B-VII.1 GD-154  
angular distribution for (n,p\*3) proton

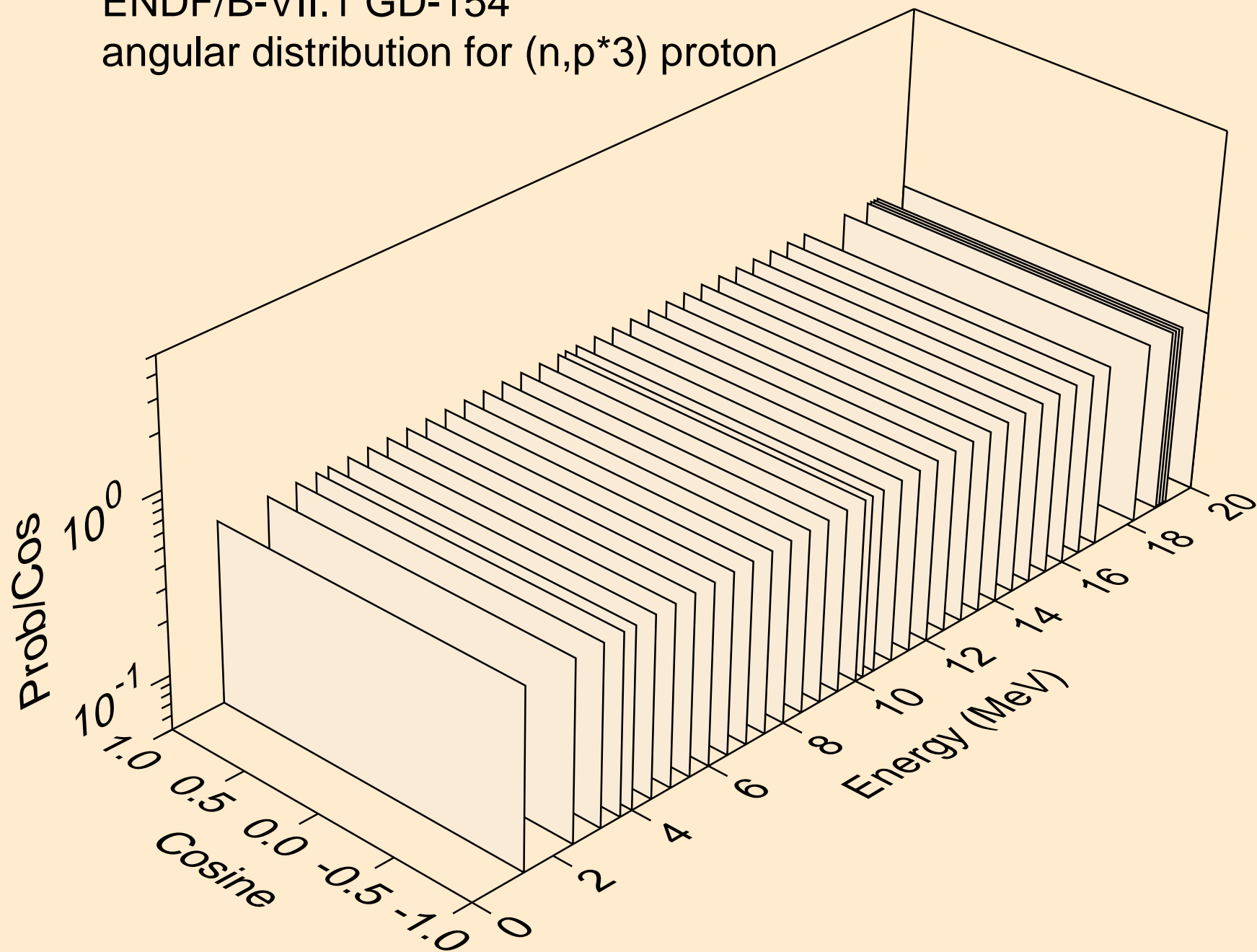

ENDF/B-VII.1 GD-154  
angular distribution for (n,p\*4) proton

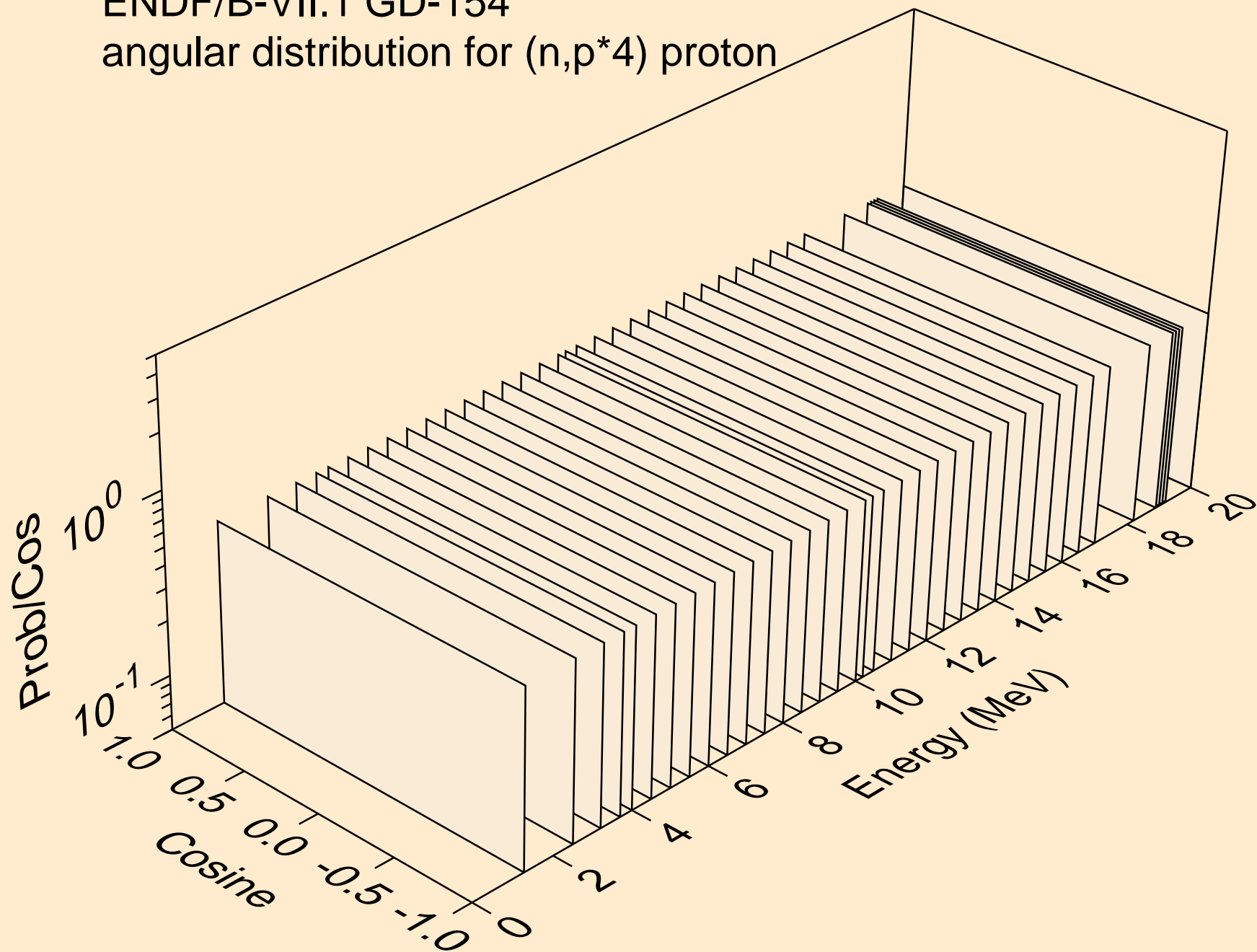

ENDF/B-VII.1 GD-154  
angular distribution for (n,p\*5) proton

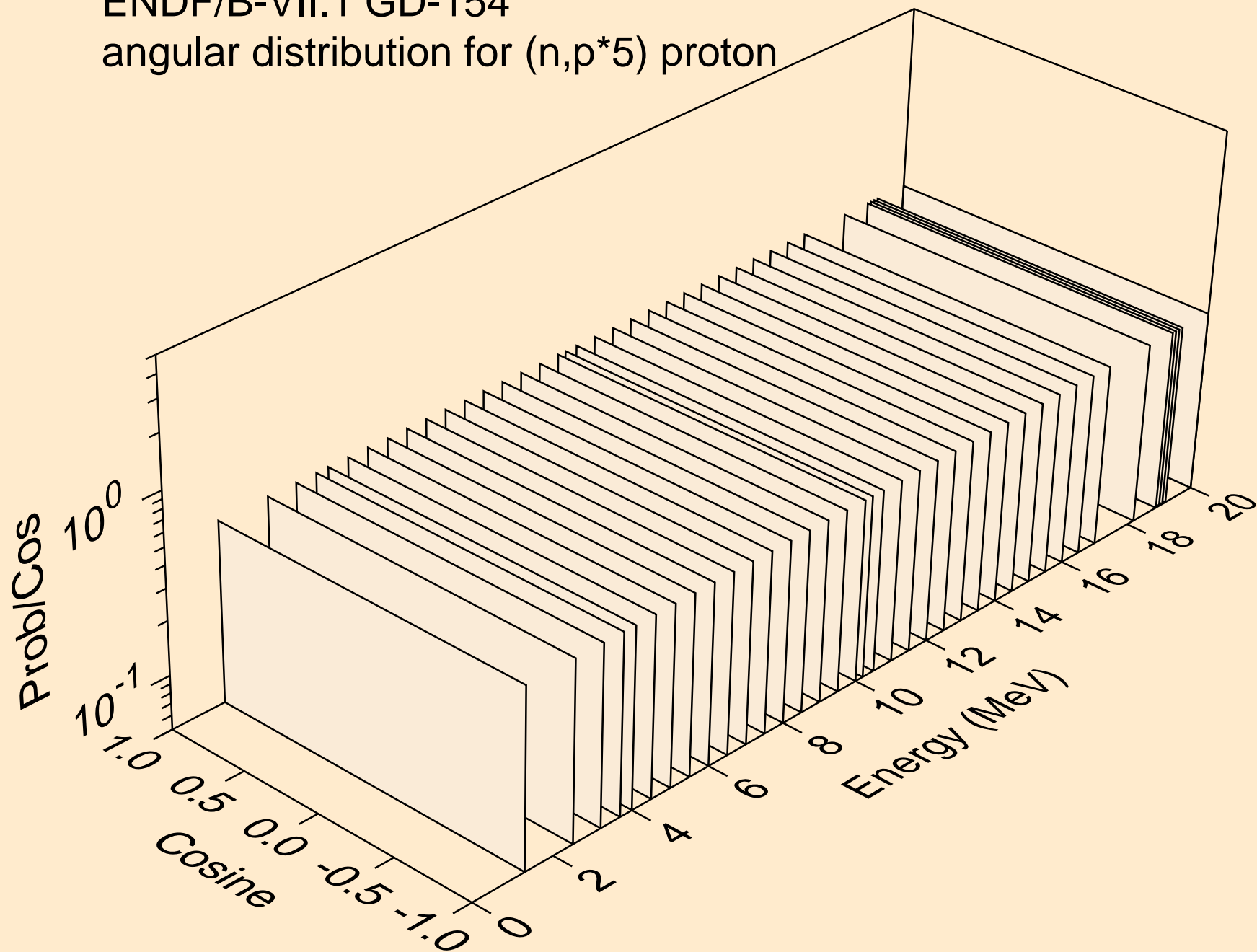

ENDF/B-VII.1 GD-154  
angular distribution for (n,p\*6) proton

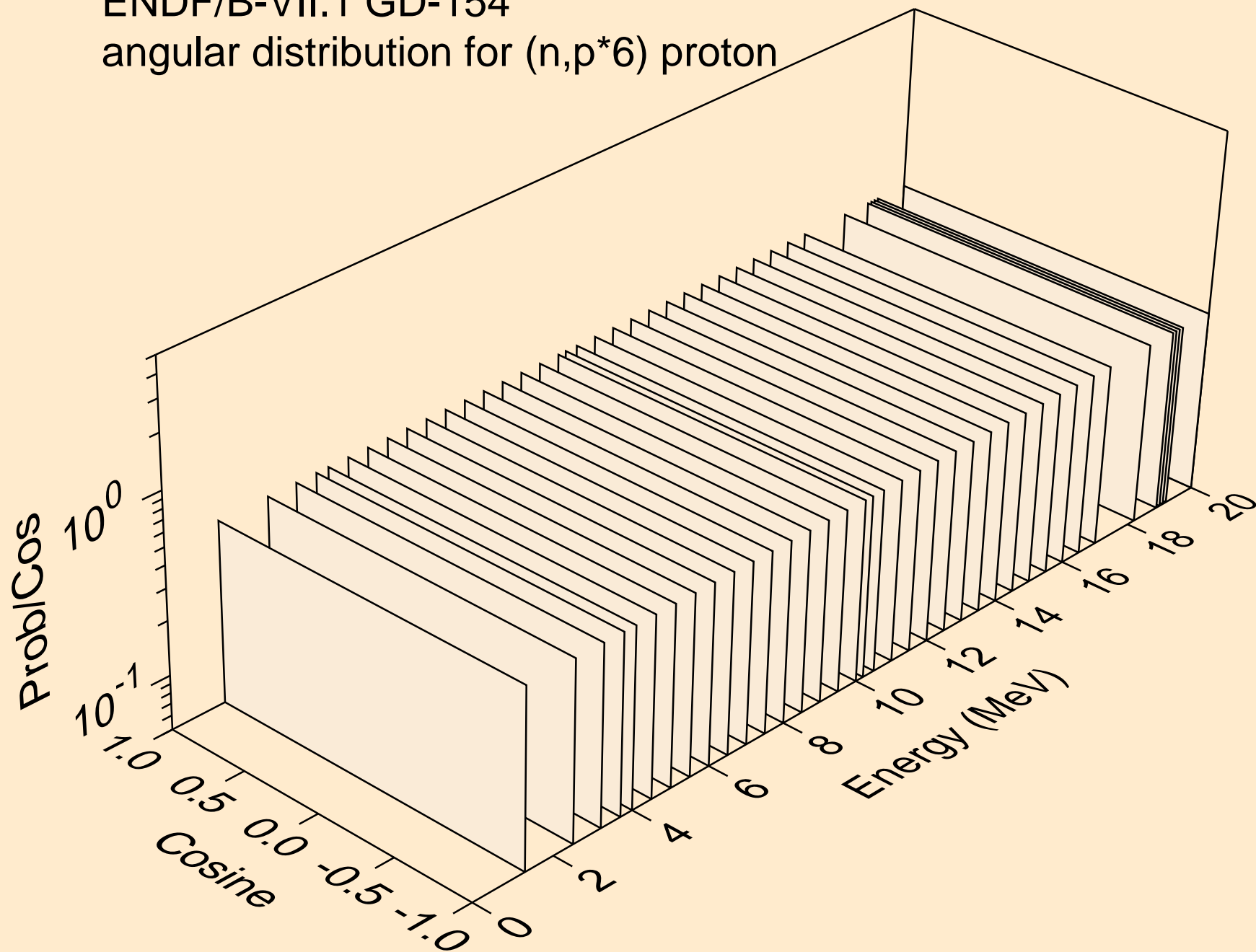



ENDF/B-VII.1 GD-154  
angular distribution for (n,p\*7) proton

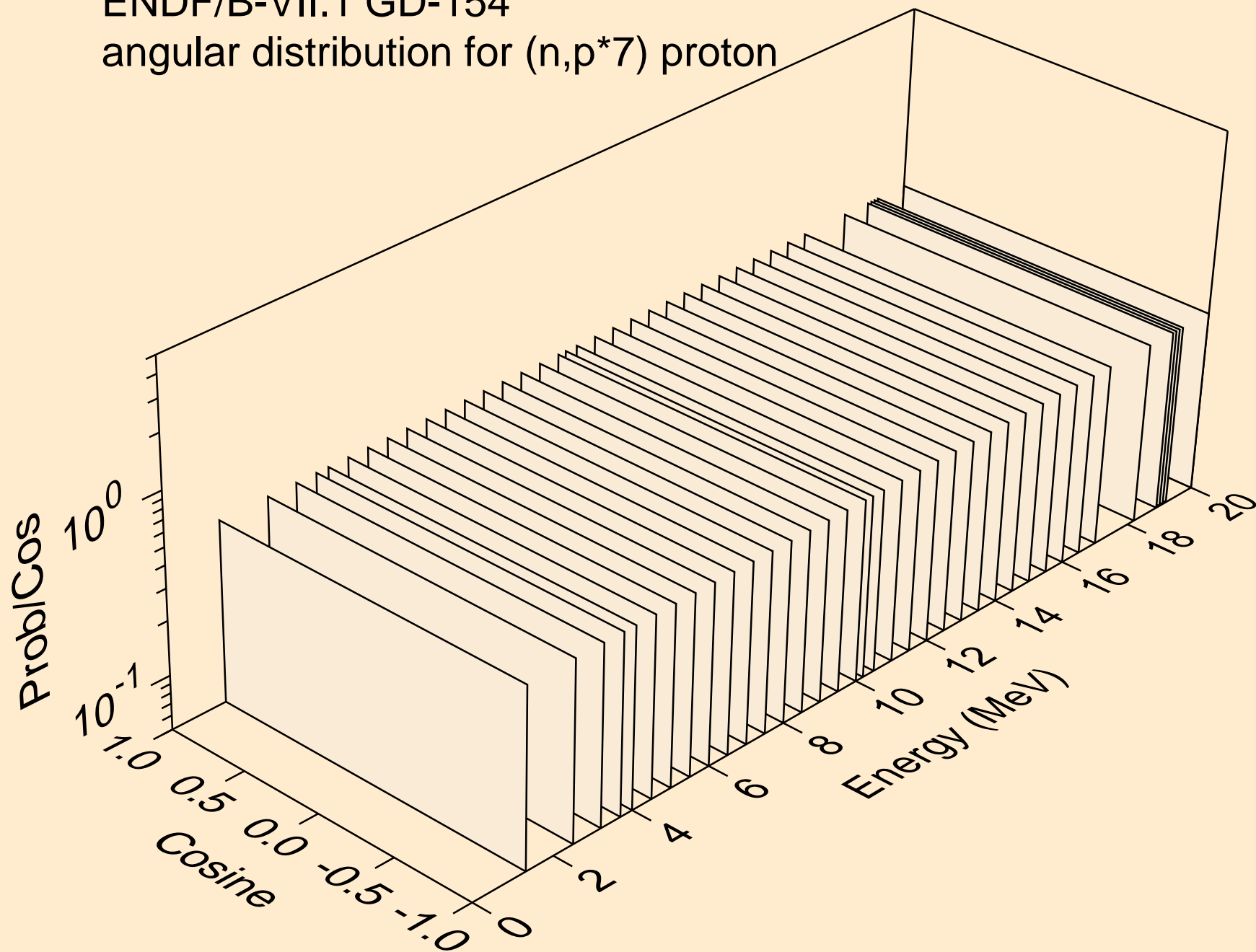

ENDF/B-VII.1 GD-154  
angular distribution for (n,p\*8) proton

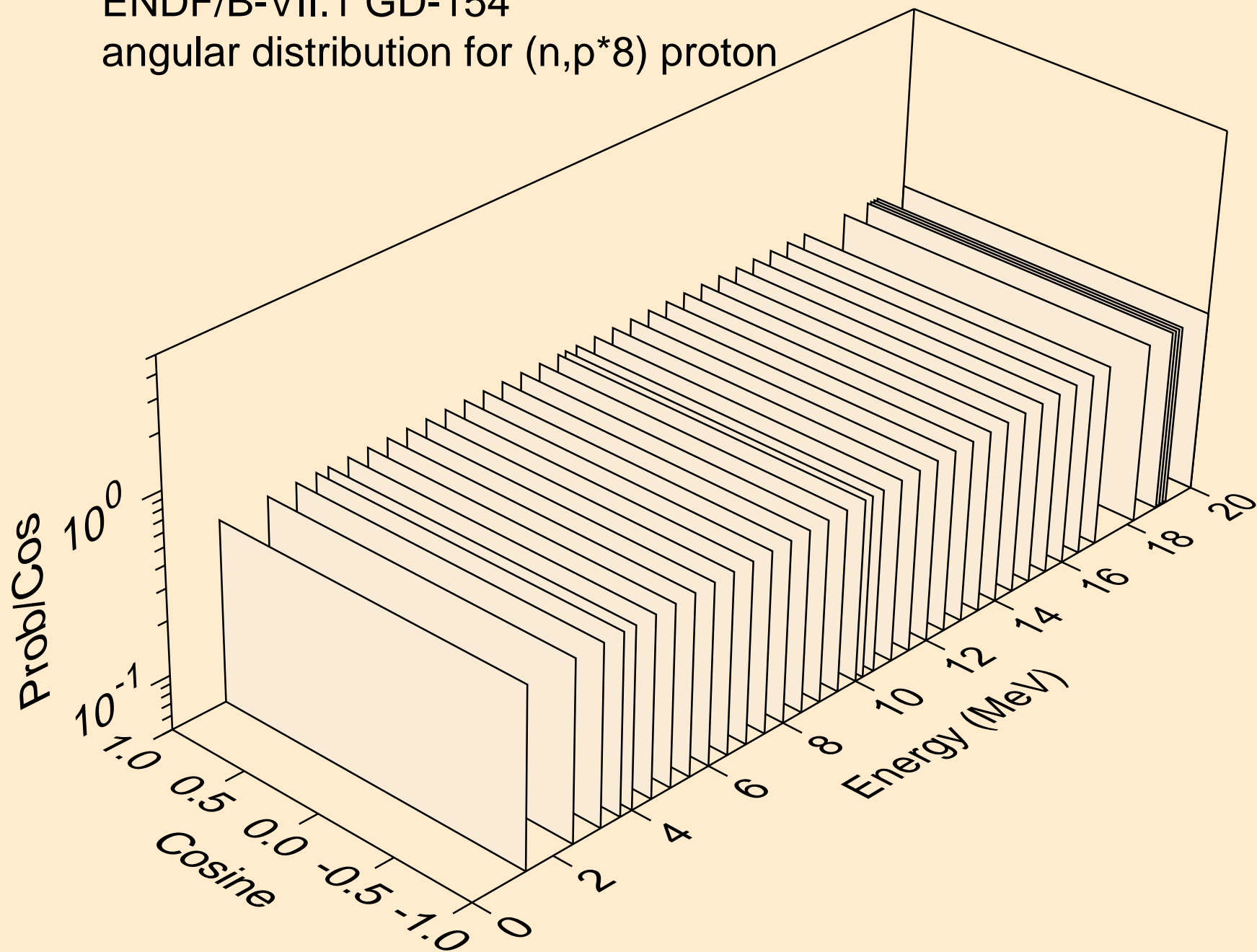

ENDF/B-VII.1 GD-154  
angular distribution for (n,p\*9) proton

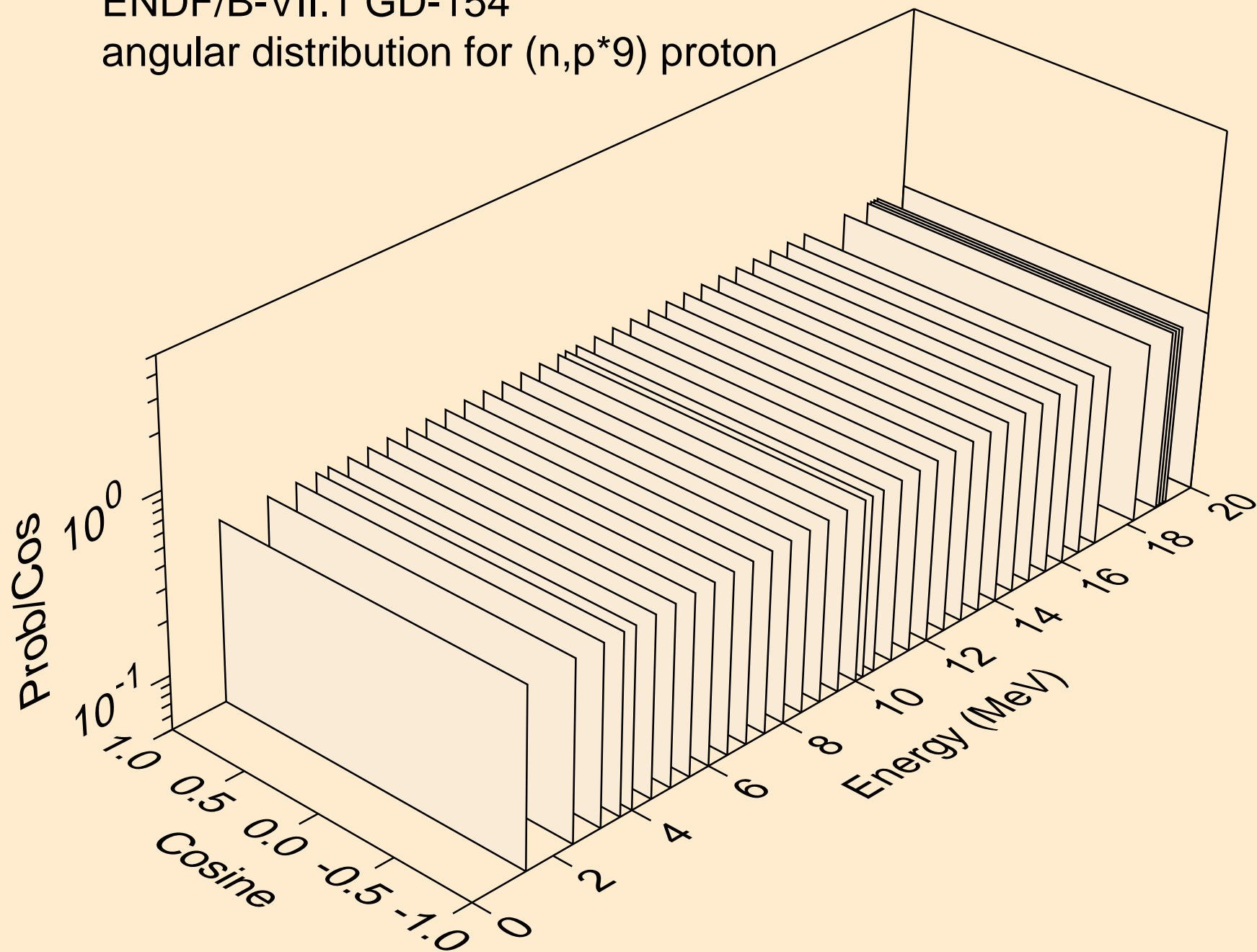

ENDF/B-VII.1 GD-154  
angular distribution for (n,p\*10) proton

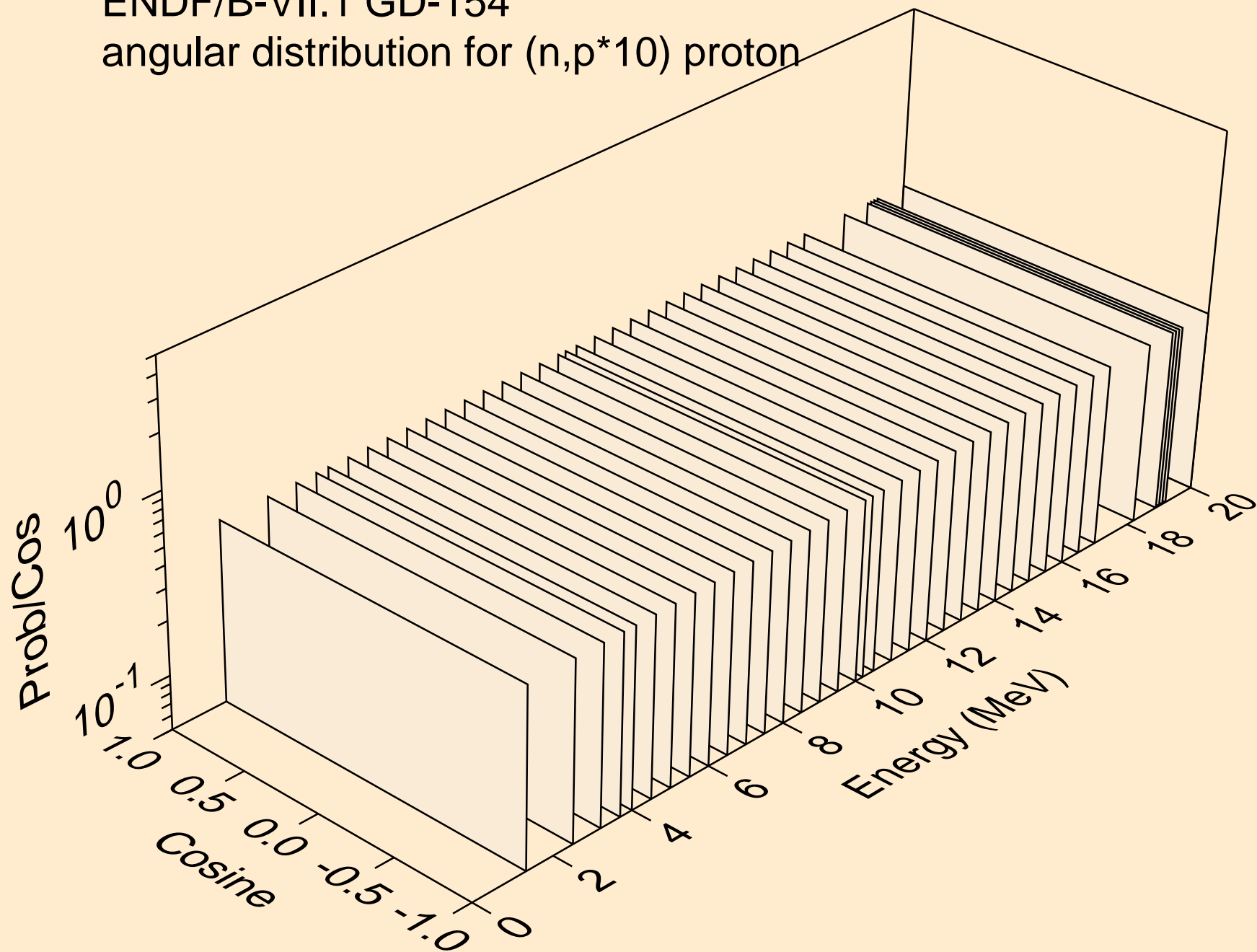

ENDF/B-VII.1 GD-154  
angular distribution for (n,p\*11) proton

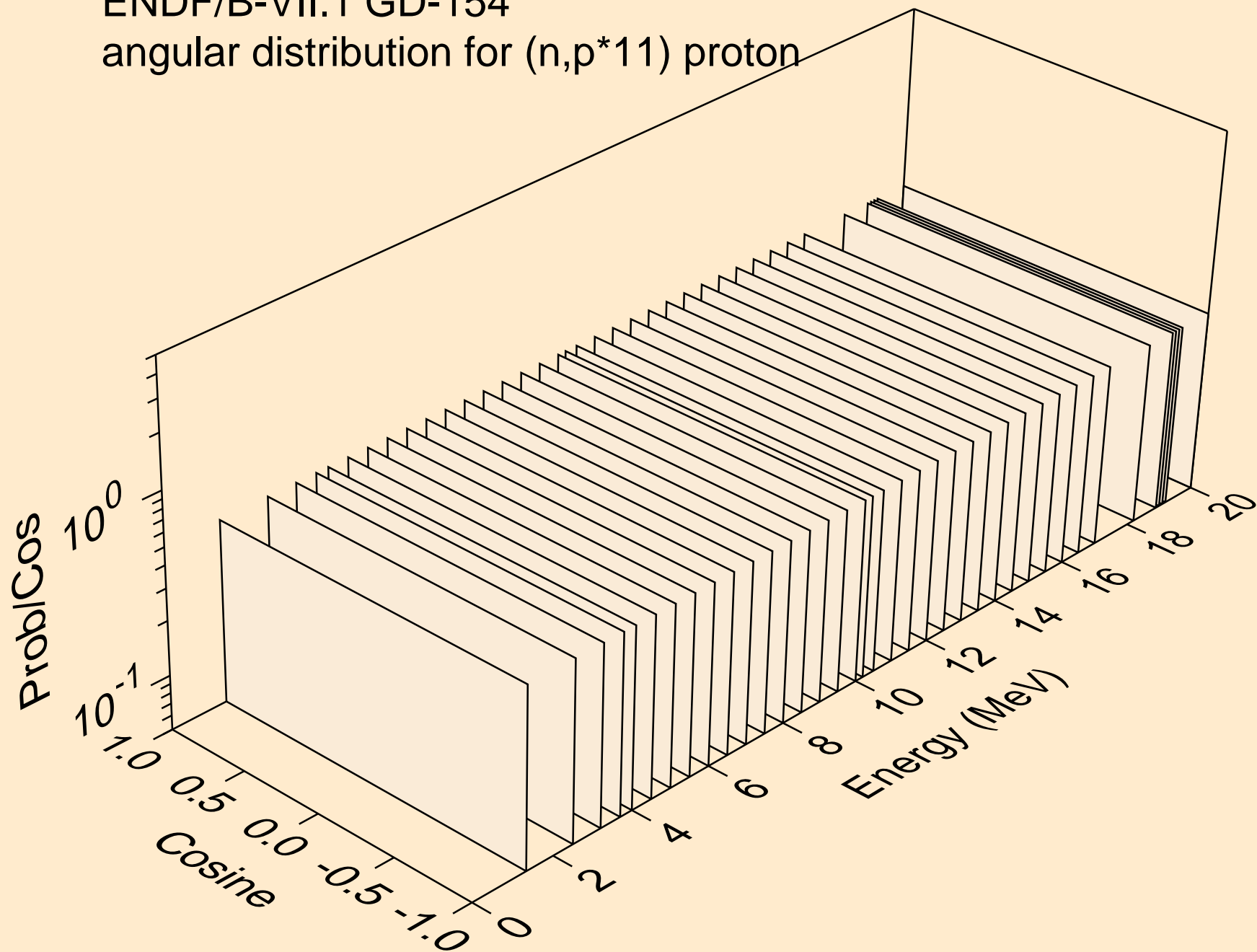

ENDF/B-VII.1 GD-154  
angular distribution for (n,p\*12) proton

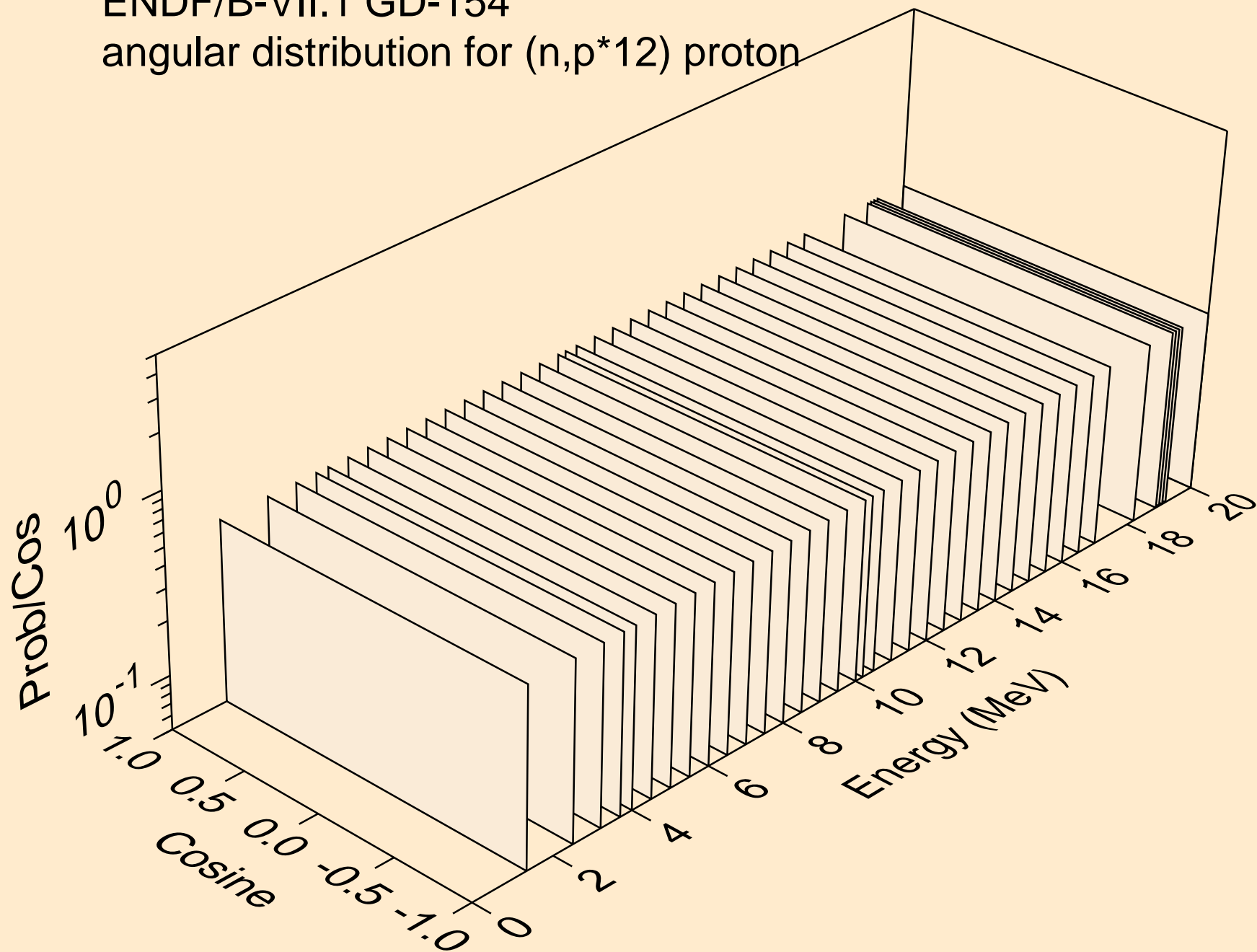

ENDF/B-VII.1 GD-154  
angular distribution for (n,p\*13) proton

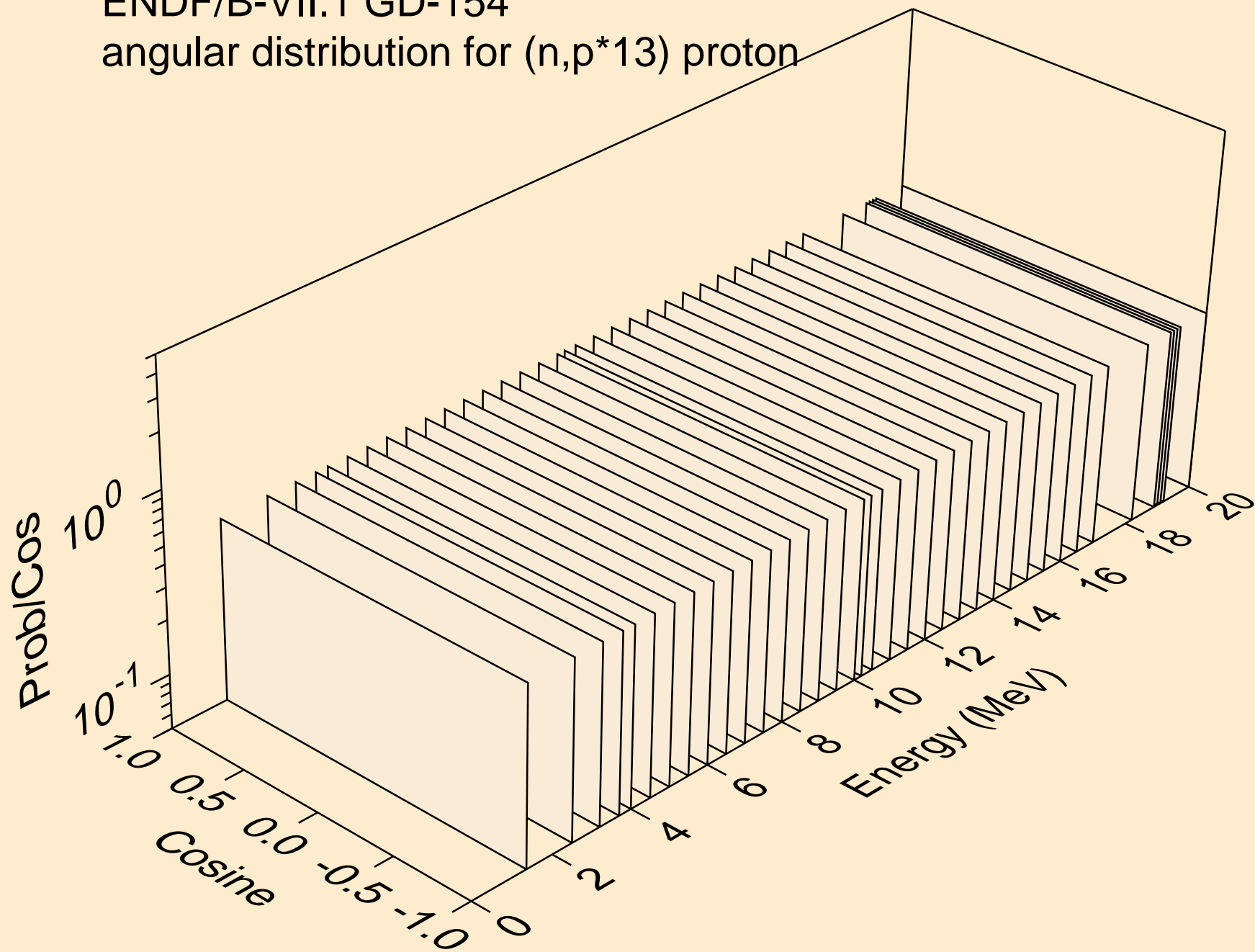

ENDF/B-VII.1 GD-154  
angular distribution for (n,p\*14) proton

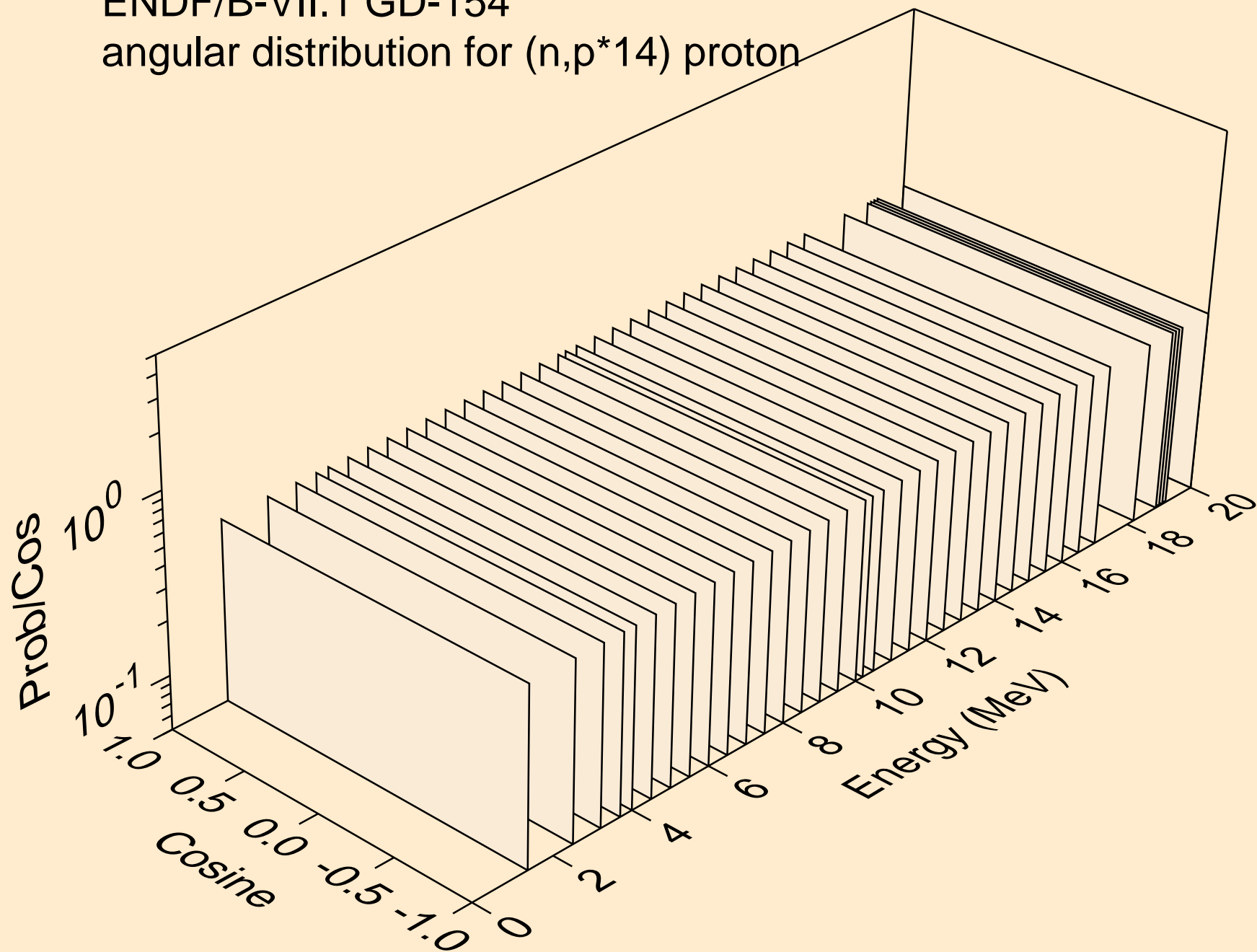



ENDF/B-VII.1 GD-154  
angular distribution for (n,p\*15) proton

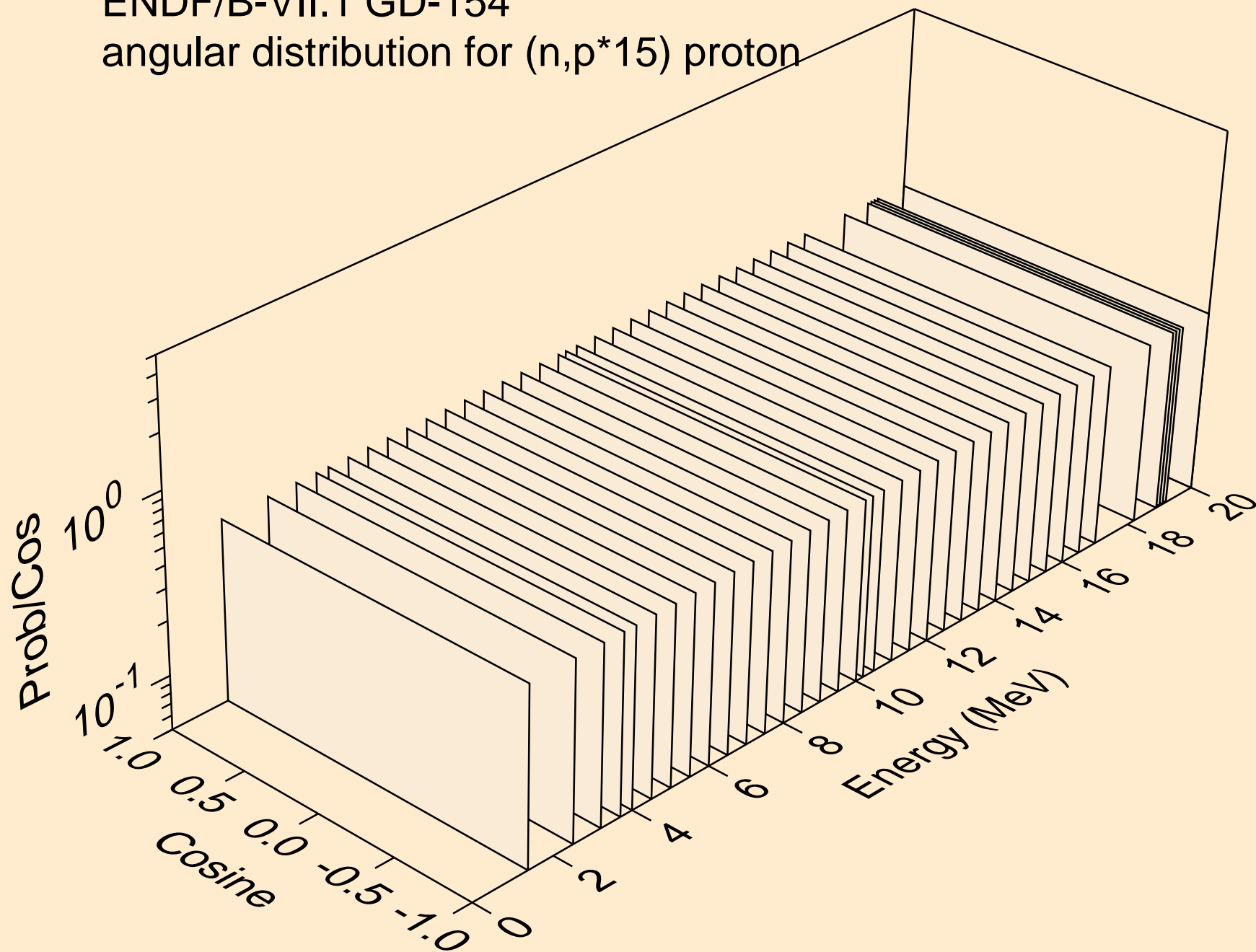

ENDF/B-VII.1 GD-154  
angular distribution for (n,p\*16) proton

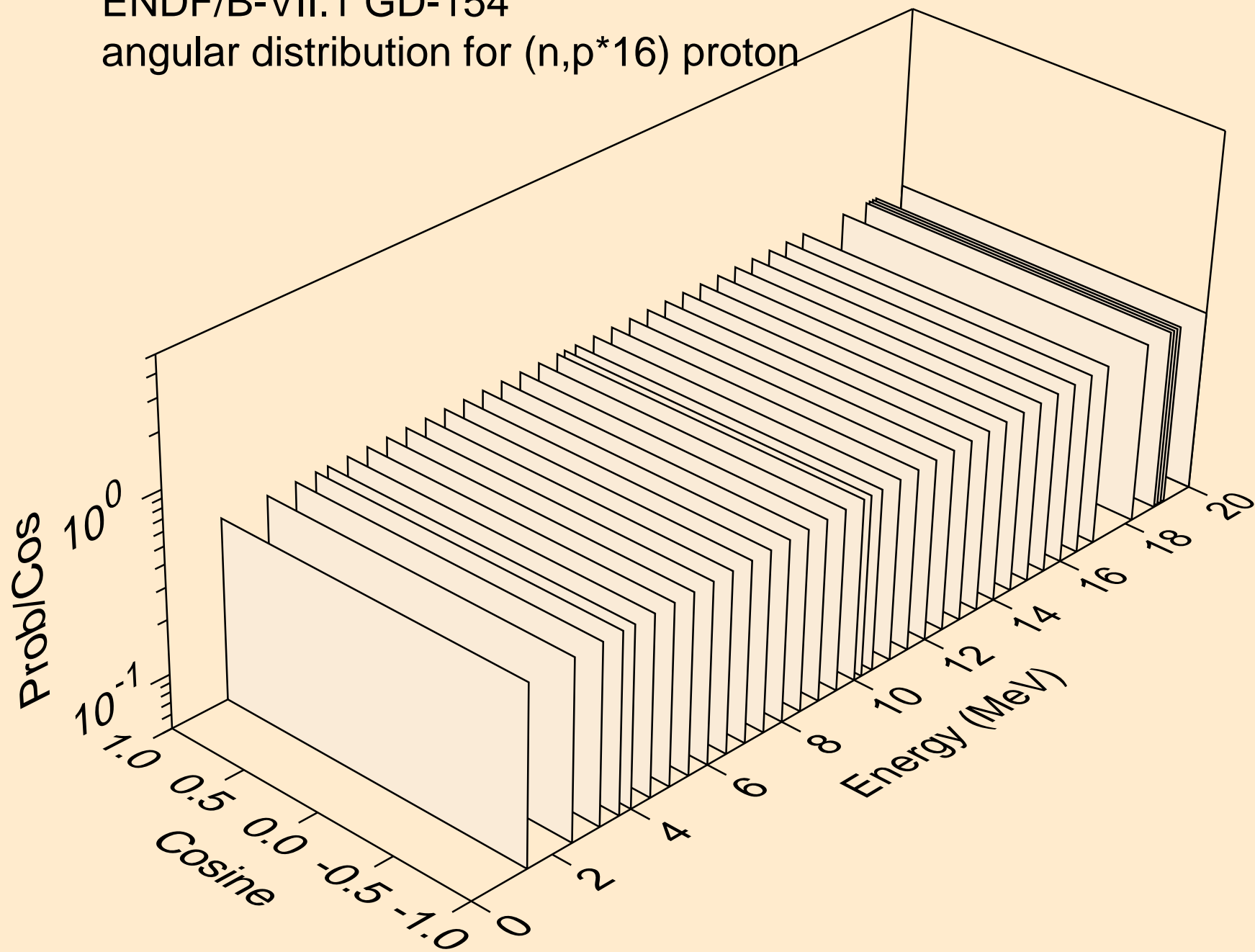

ENDF/B-VII.1 GD-154  
angular distribution for (n,p\*17) proton

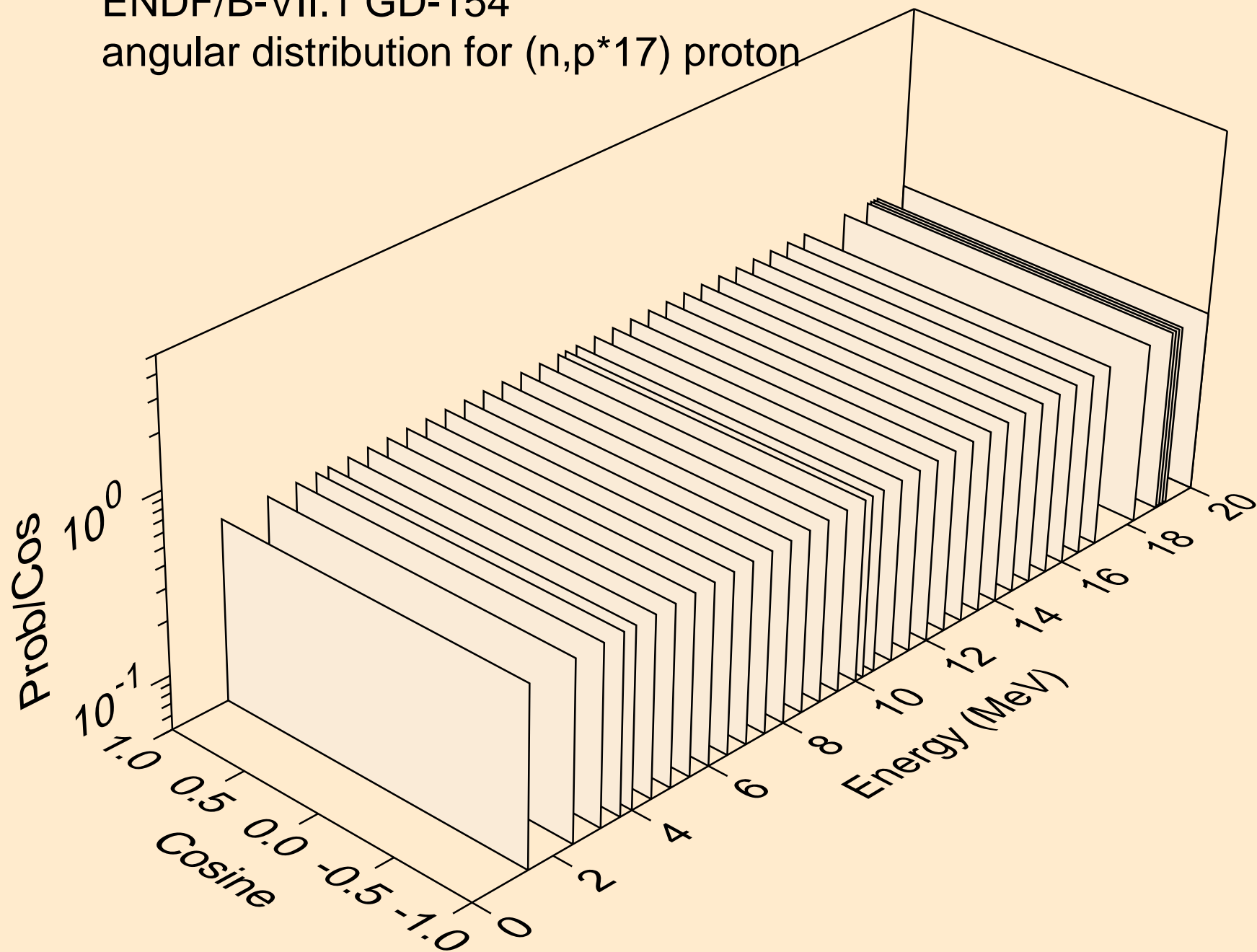

ENDF/B-VII.1 GD-154  
angular distribution for (n,p\*18) proton

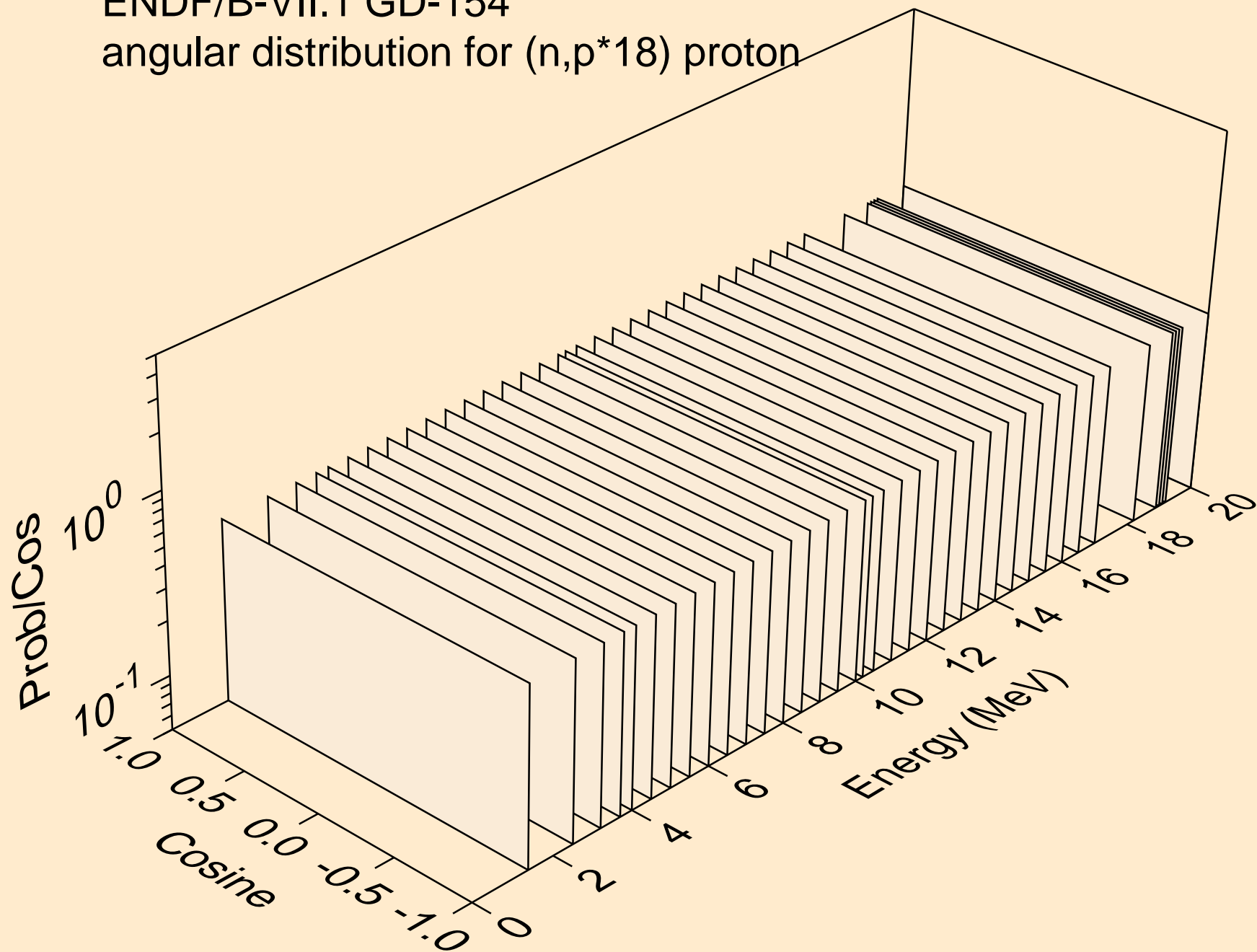

ENDF/B-VII.1 GD-154  
angular distribution for (n,p\*19) proton

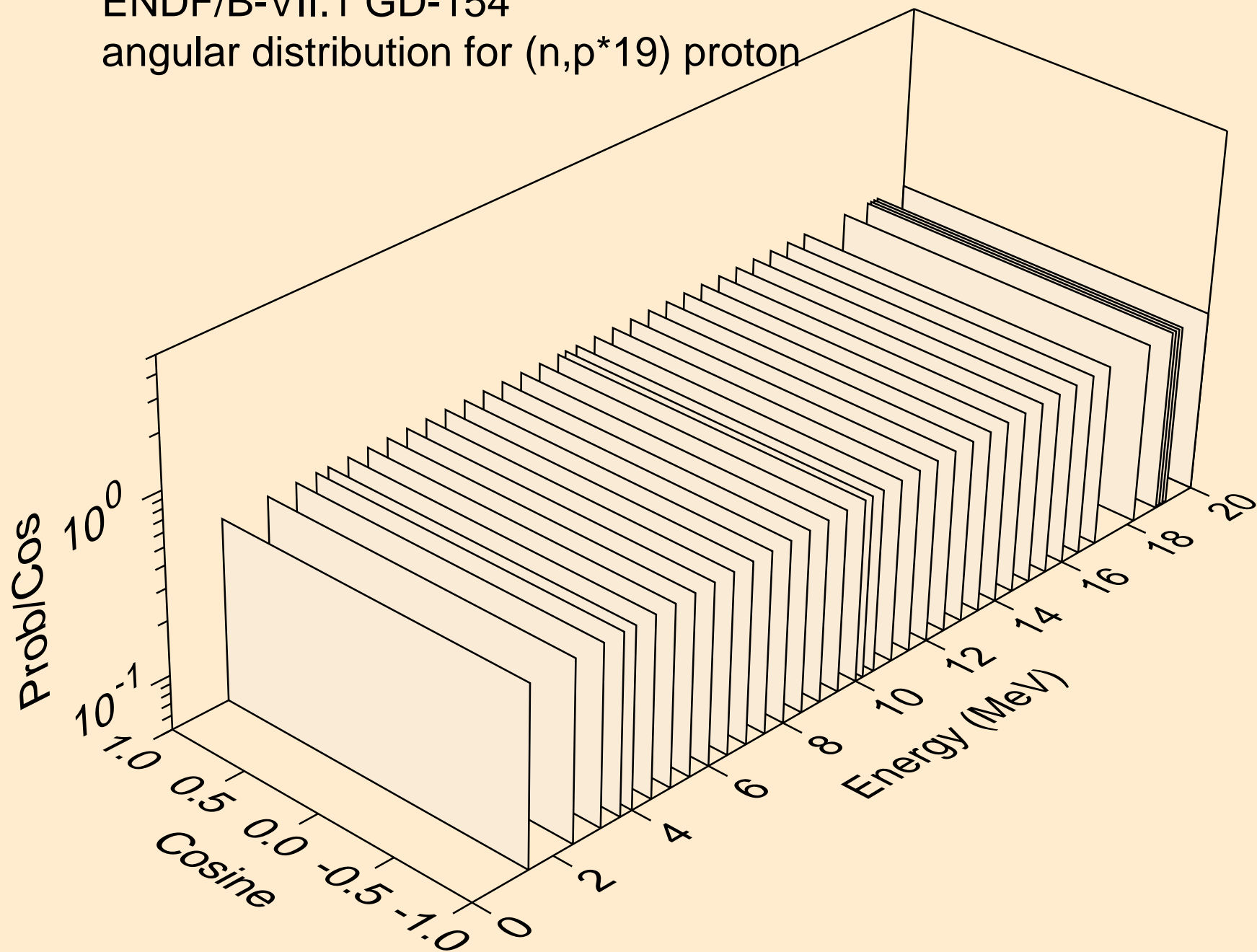

ENDF/B-VII.1 GD-154  
angular distribution for (n,p\*20) proton

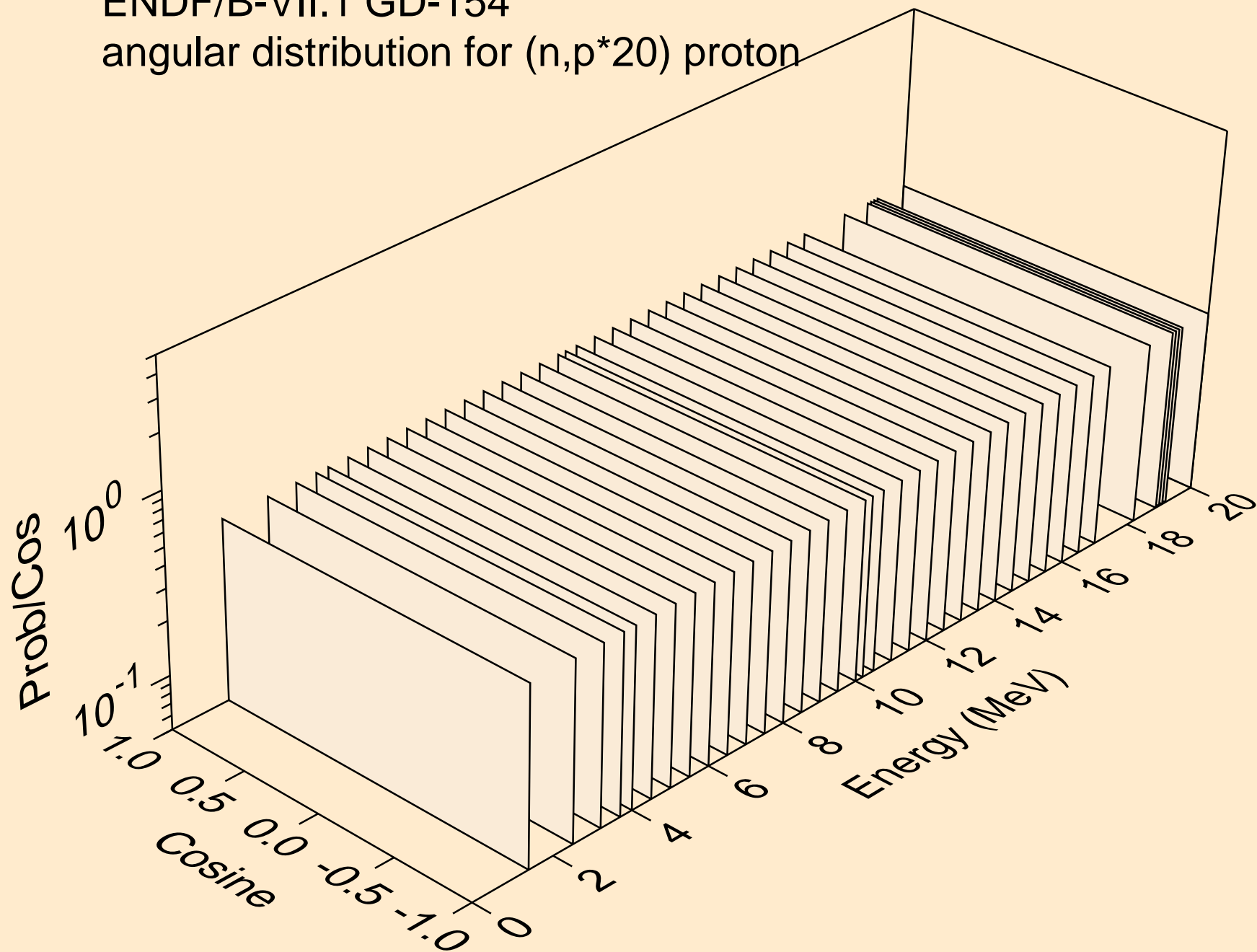

ENDF/B-VII.1 GD-154  
angular distribution for (n,p\*21) proton

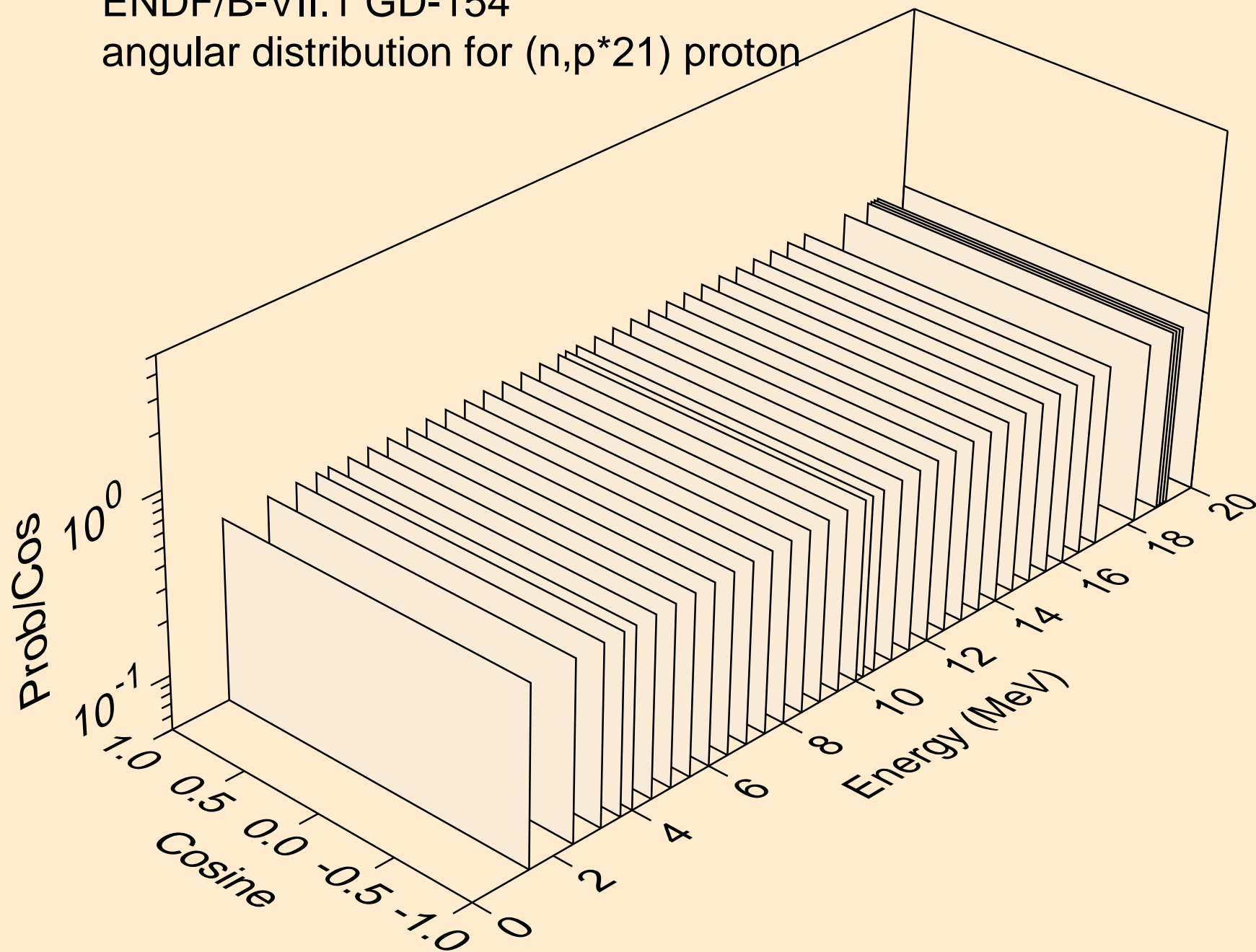

ENDF/B-VII.1 GD-154  
angular distribution for (n,p\*22) proton

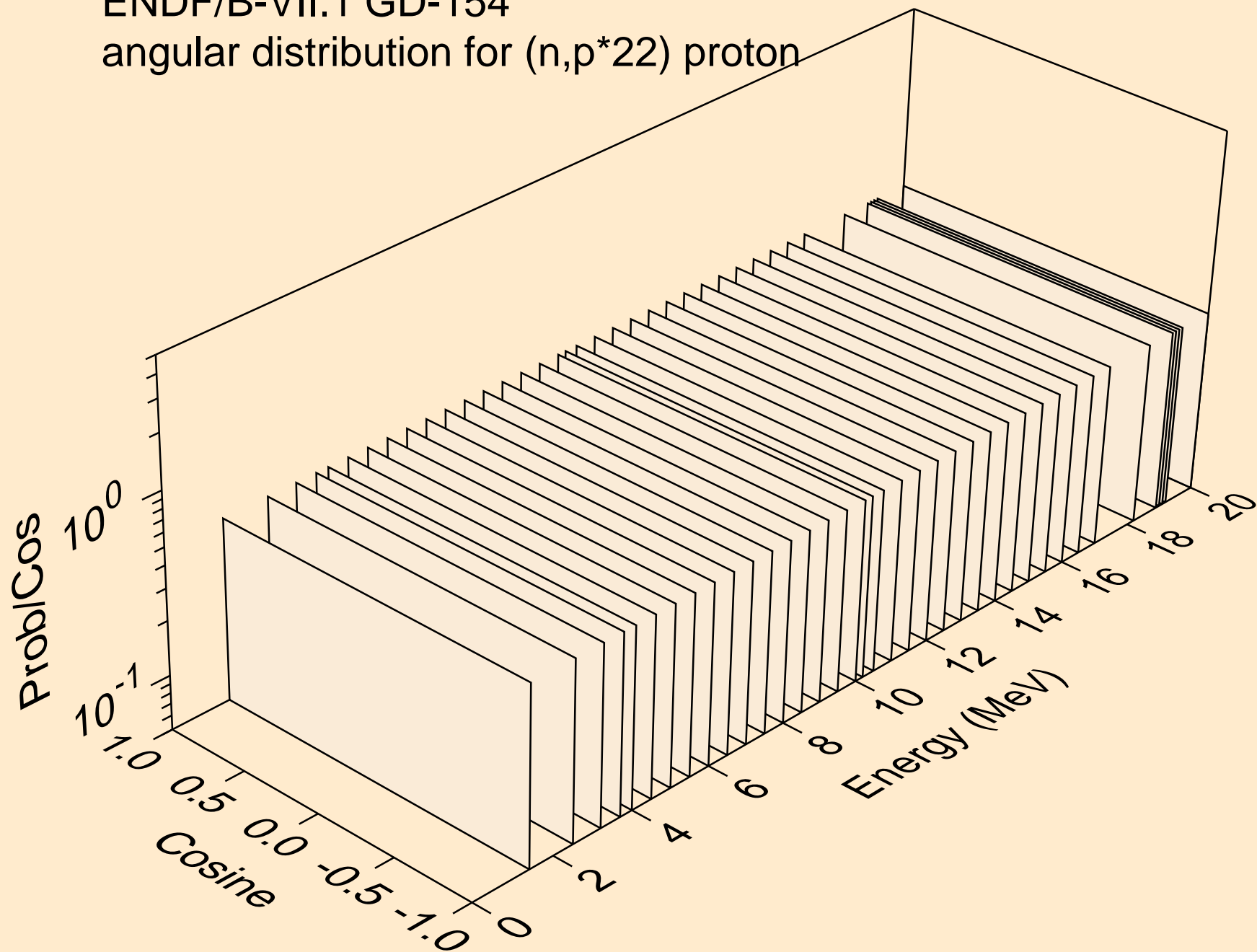



ENDF/B-VII.1 GD-154  
angular distribution for (n,p\*23) proton

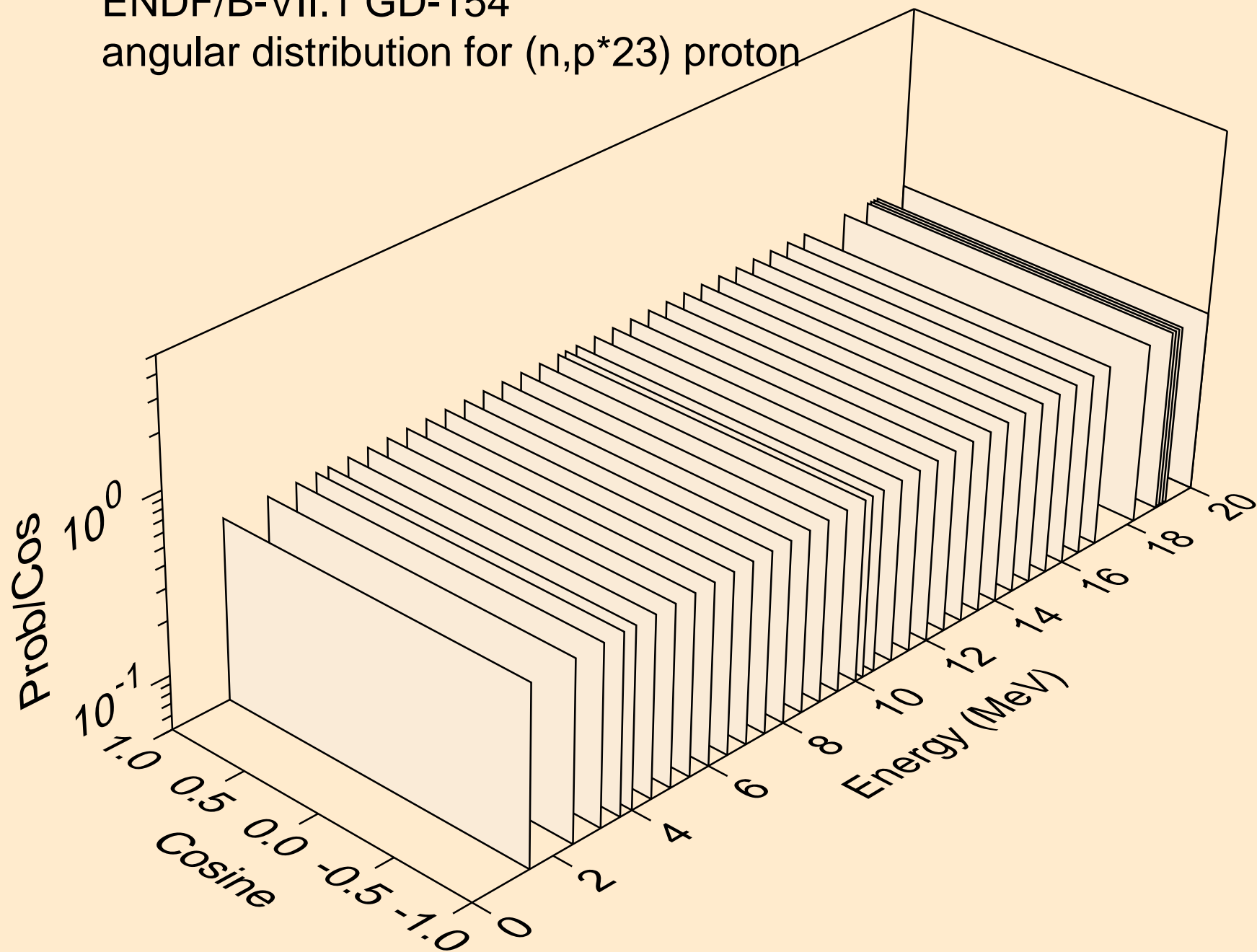

ENDF/B-VII.1 GD-154  
angular distribution for (n,p\*24) proton

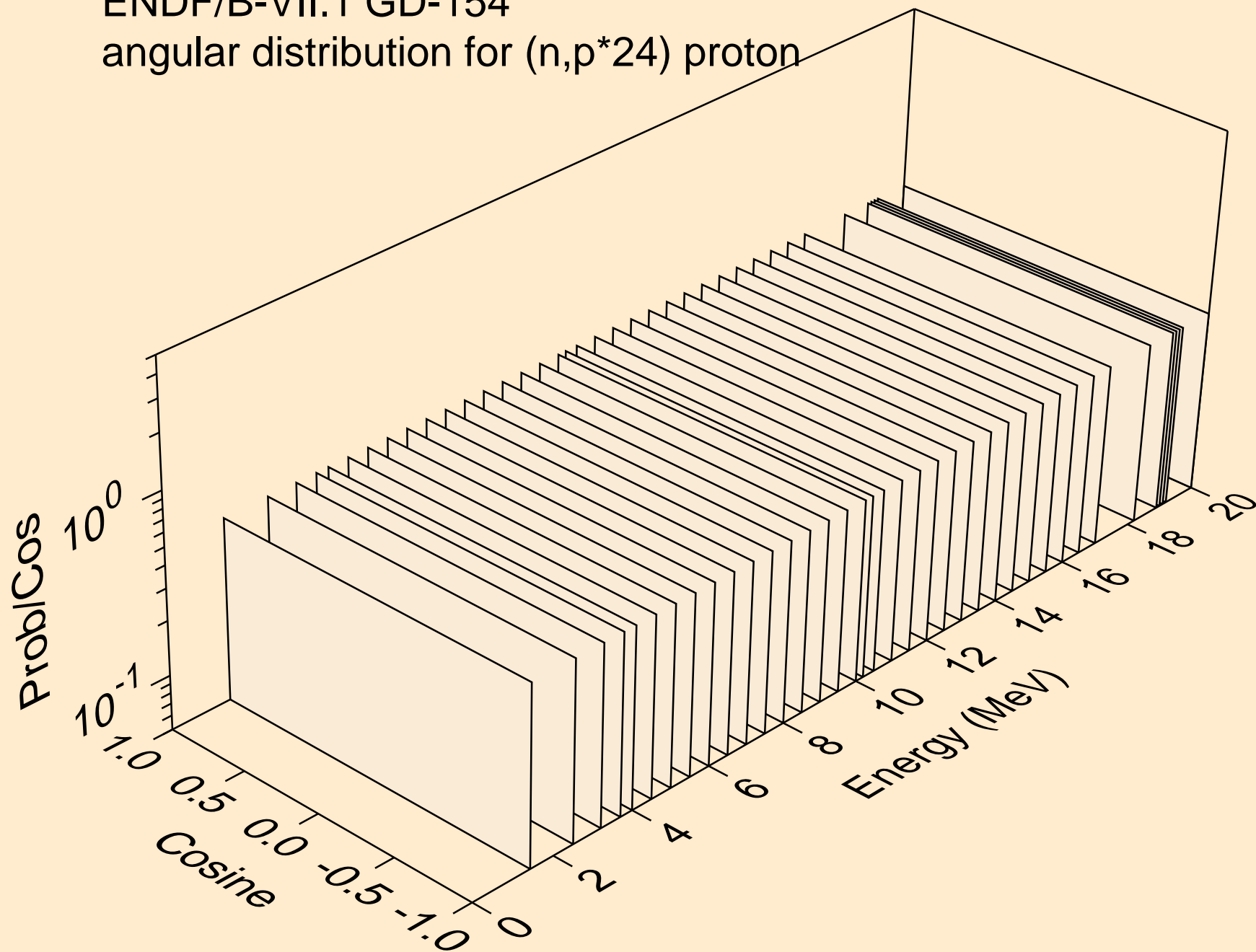

ENDF/B-VII.1 GD-154  
angular distribution for (n,p\*25) proton

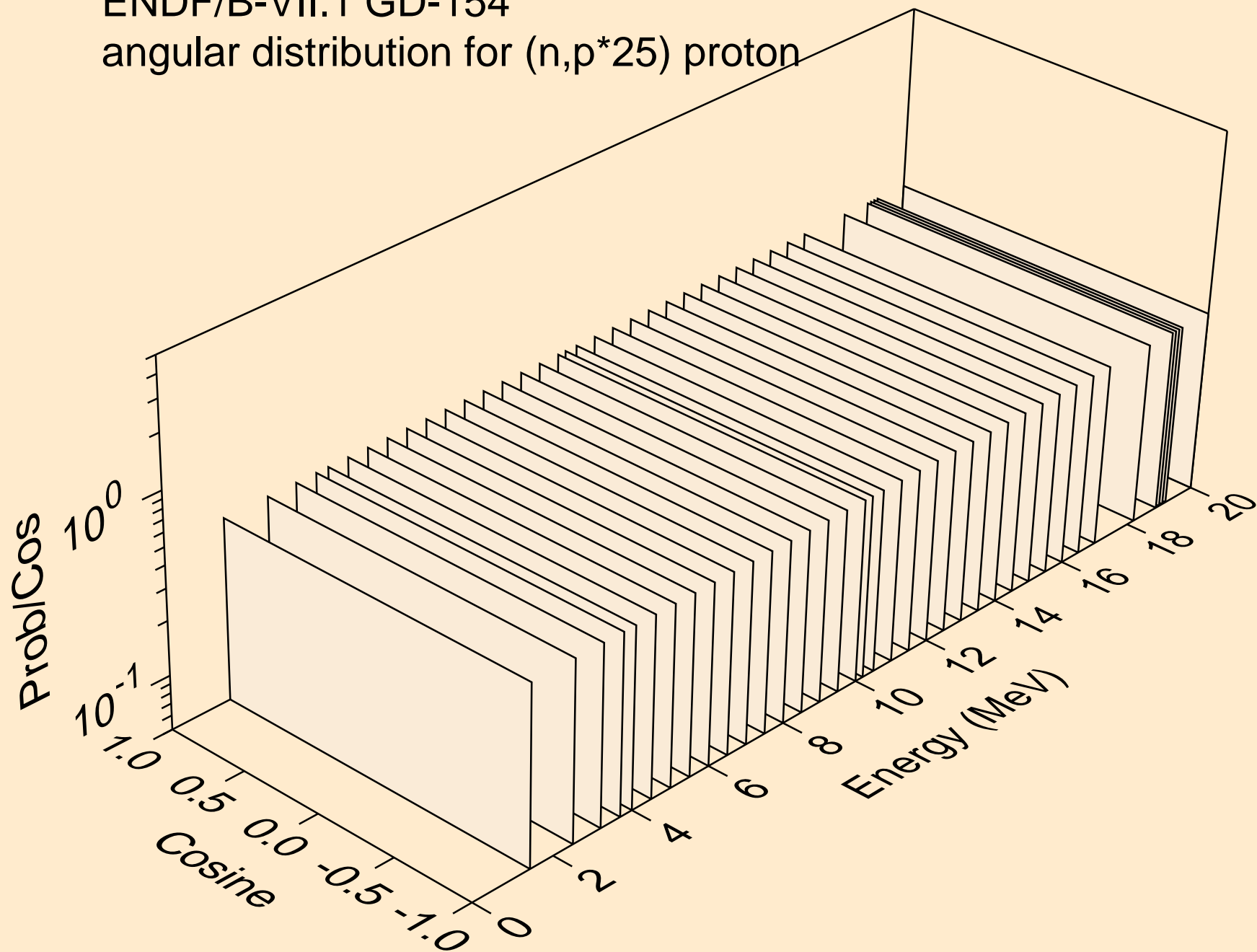

ENDF/B-VII.1 GD-154  
angular distribution for (n,p\*26) proton

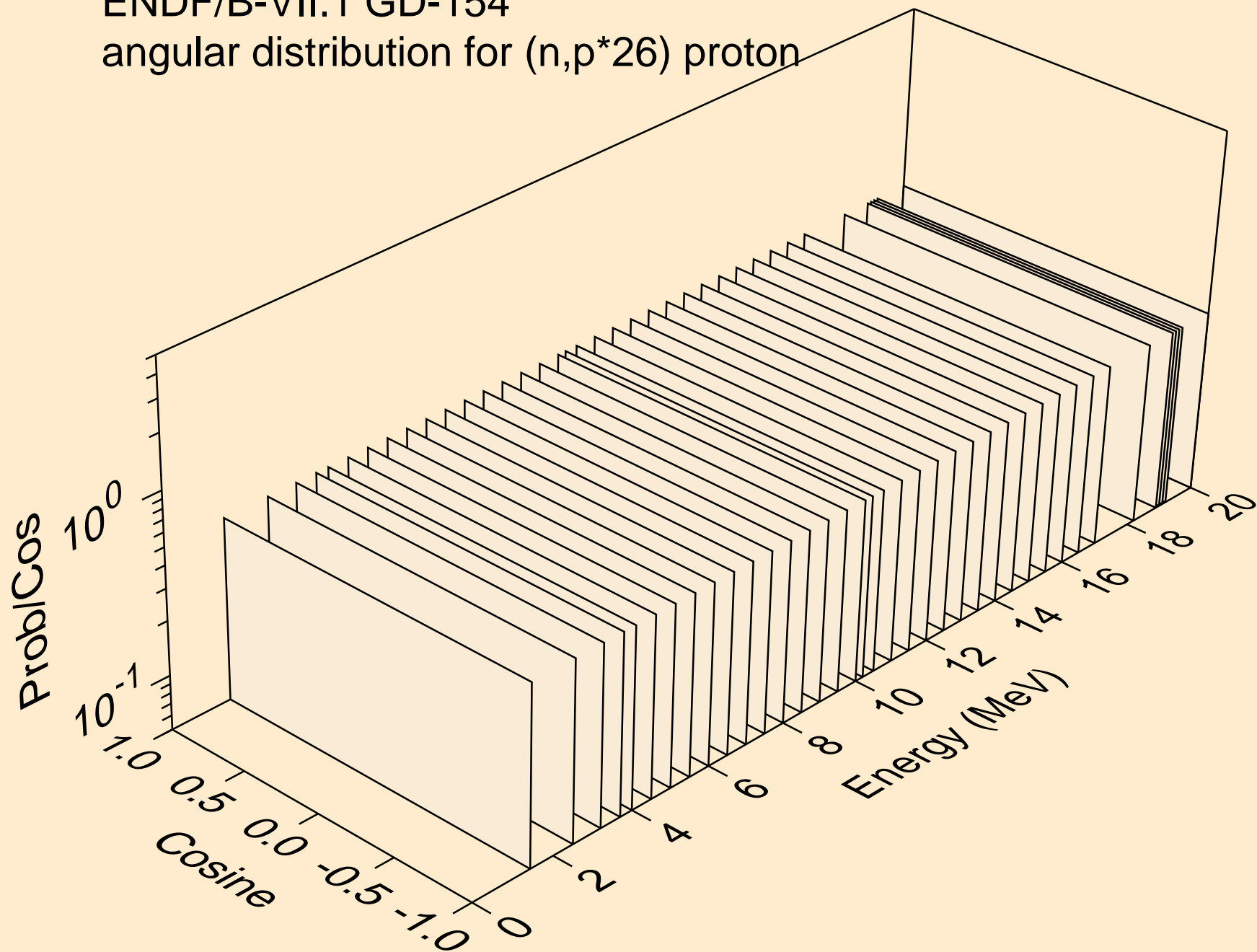

ENDF/B-VII.1 GD-154  
angular distribution for (n,p\*27) proton

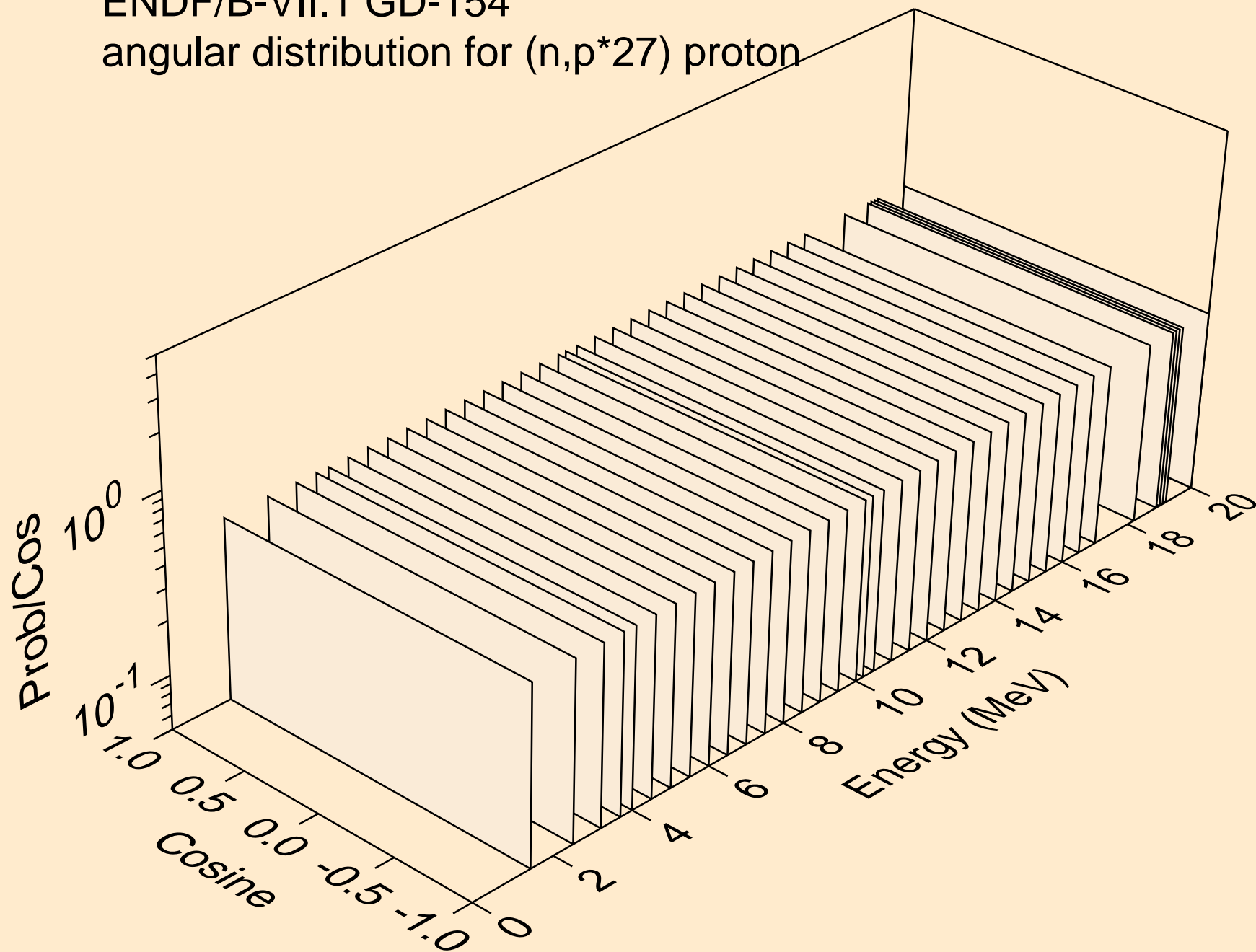

ENDF/B-VII.1 GD-154  
angular distribution for (n,p\*28) proton

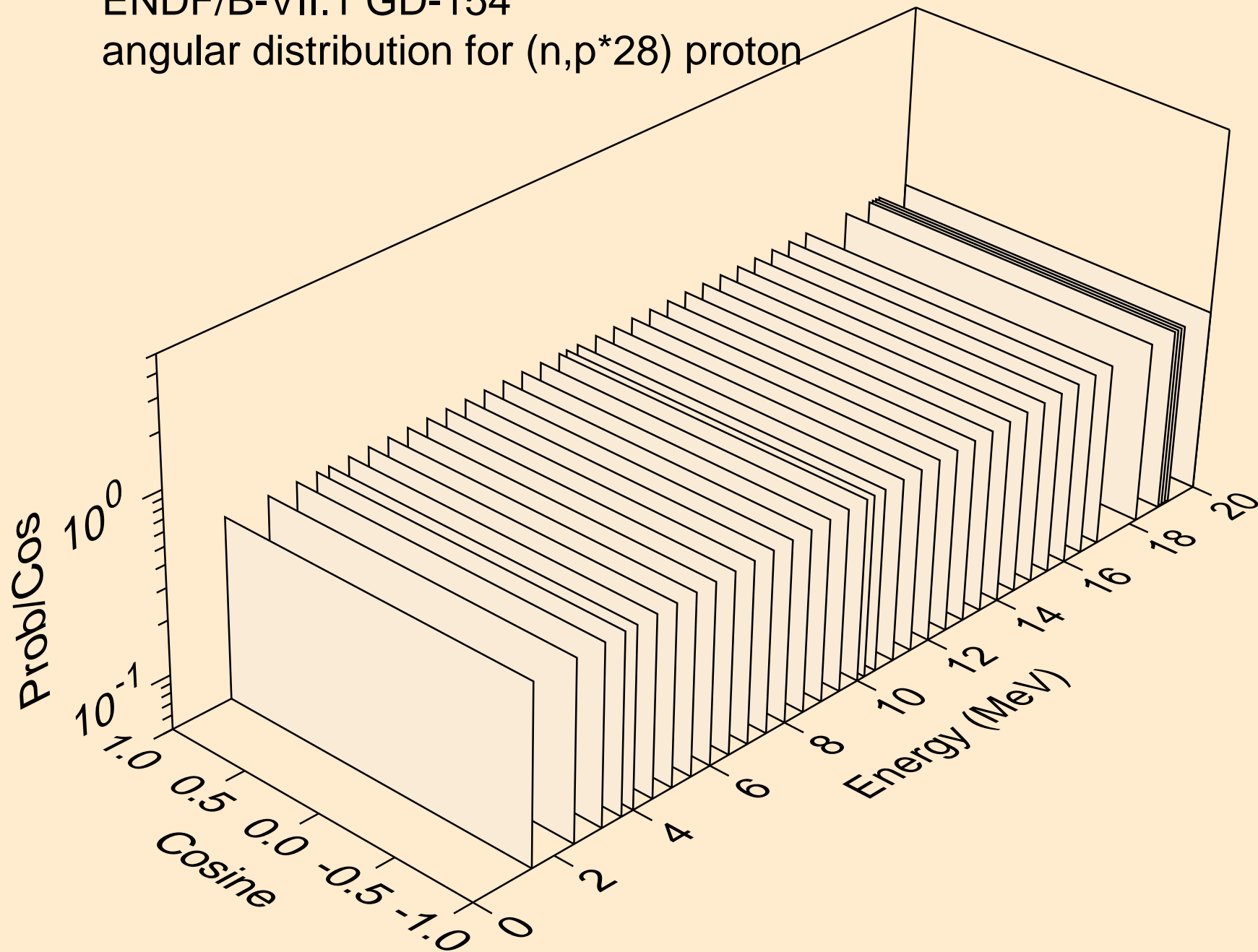

ENDF/B-VII.1 GD-154  
angular distribution for (n,p\*29) proton

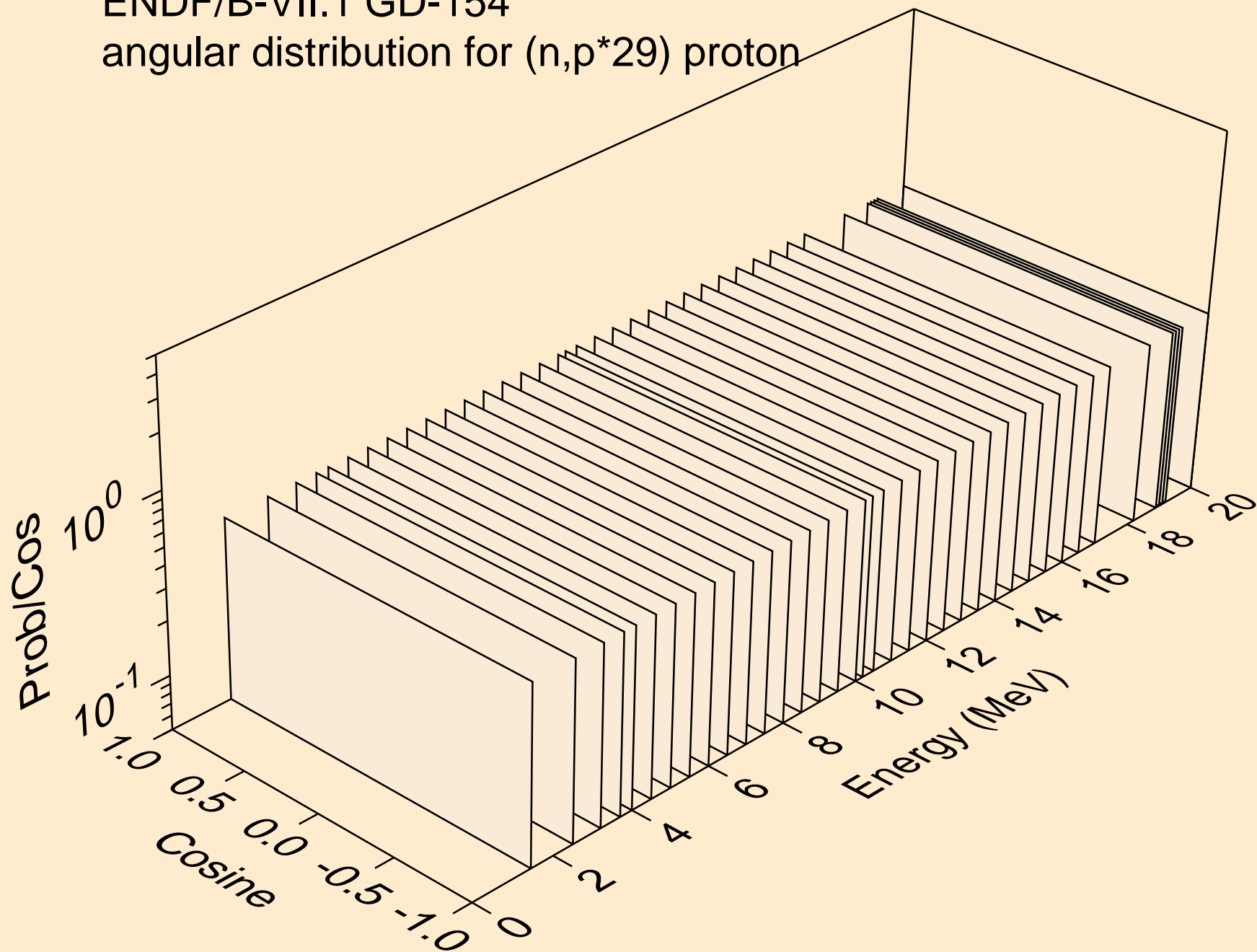

ENDF/B-VII.1 GD-154  
angular distribution for (n,p\*30) proton

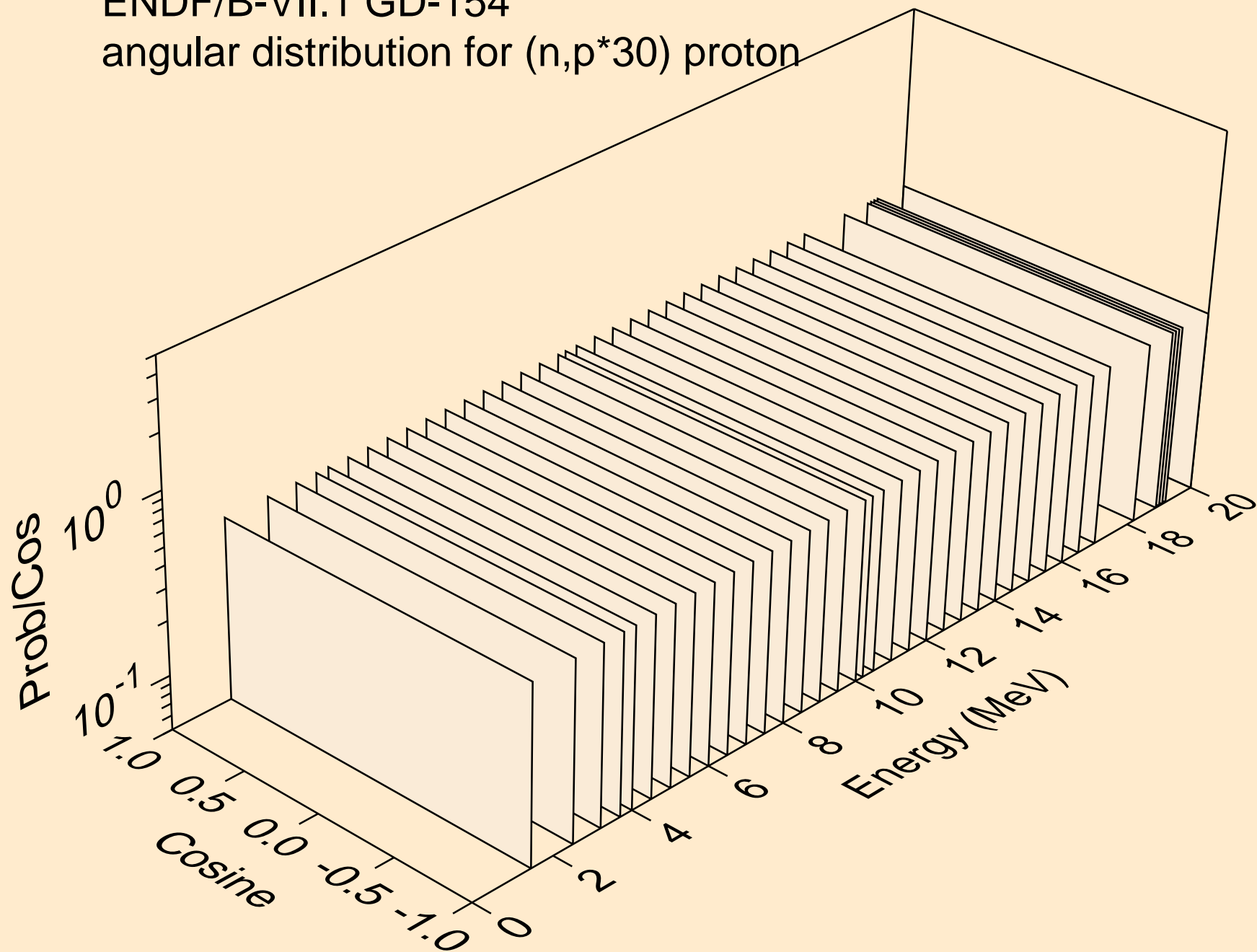



ENDF/B-VII.1 GD-154  
angular distribution for (n,p\*31) proton

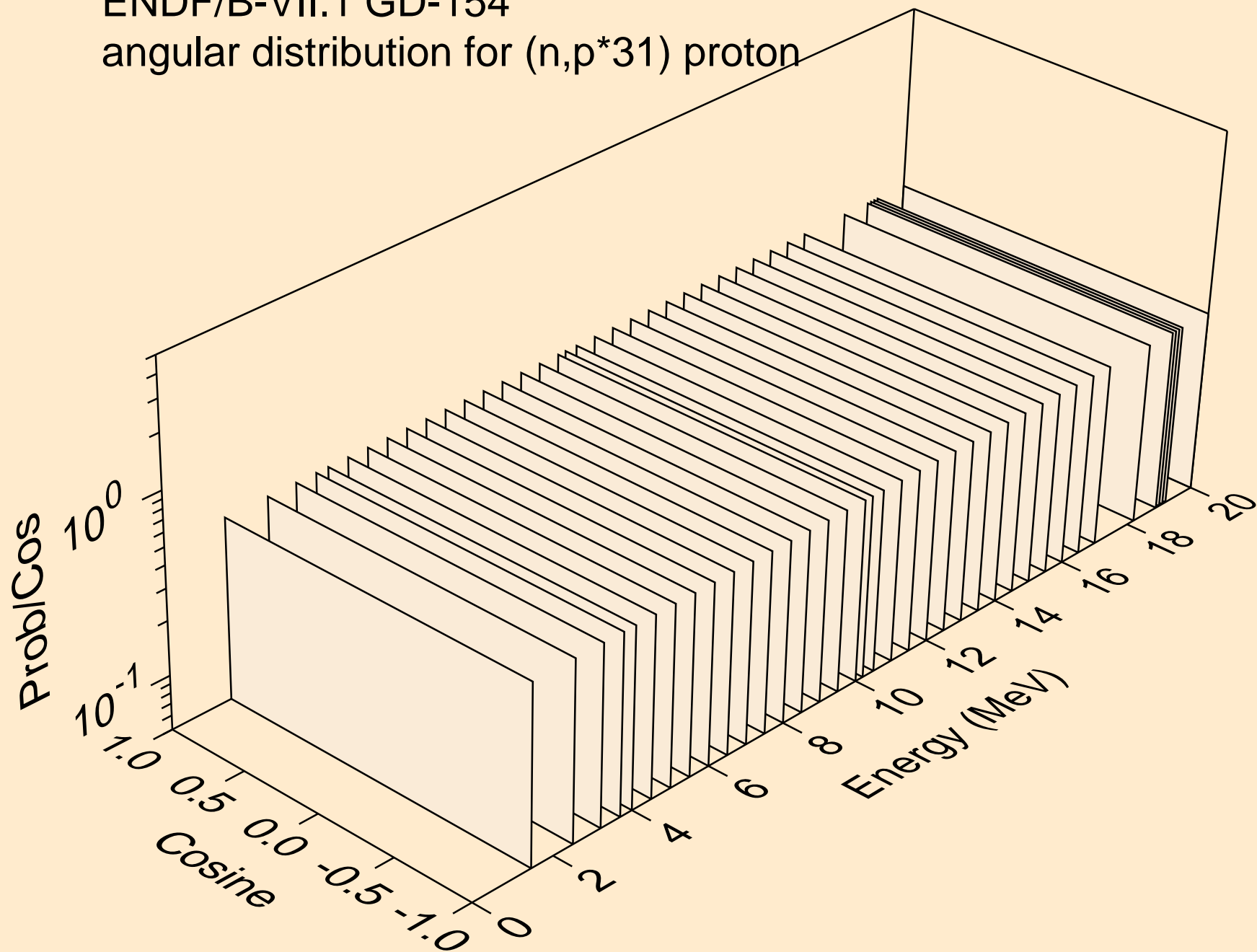

ENDF/B-VII.1 GD-154  
angular distribution for (n,p\*32) proton

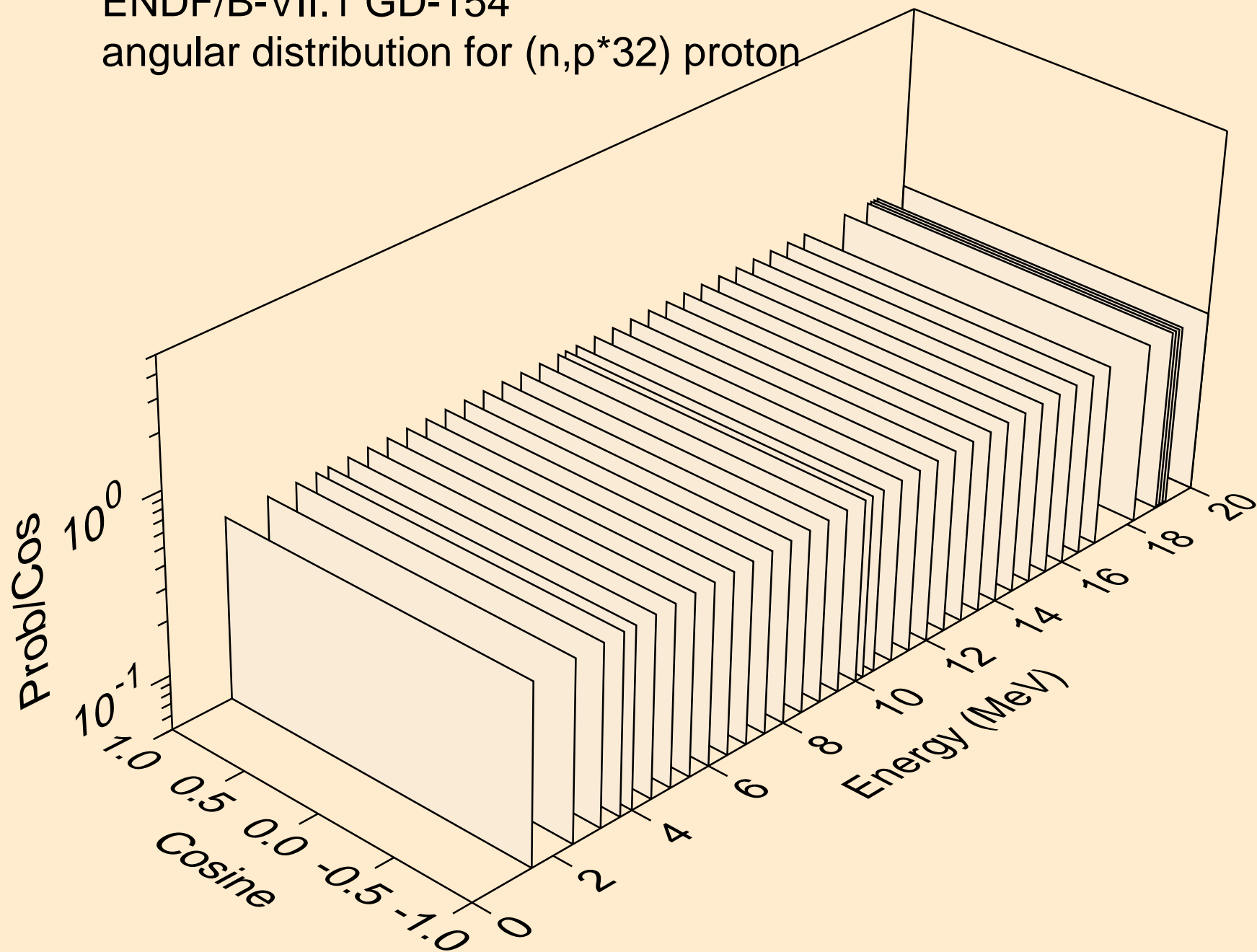

ENDF/B-VII.1 GD-154  
angular distribution for (n,p\*33) proton

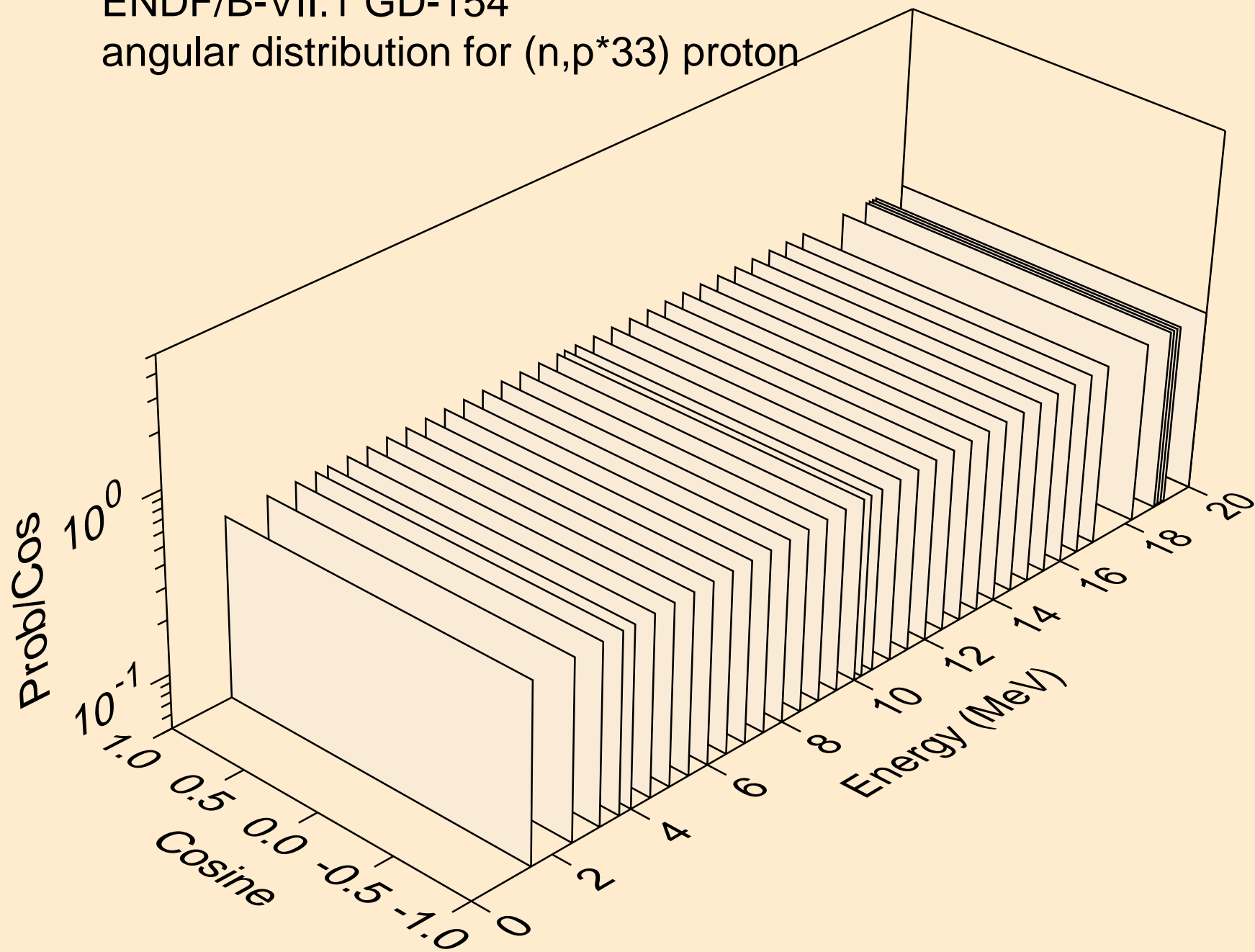

ENDF/B-VII.1 GD-154  
angular distribution for (n,p\*34) proton

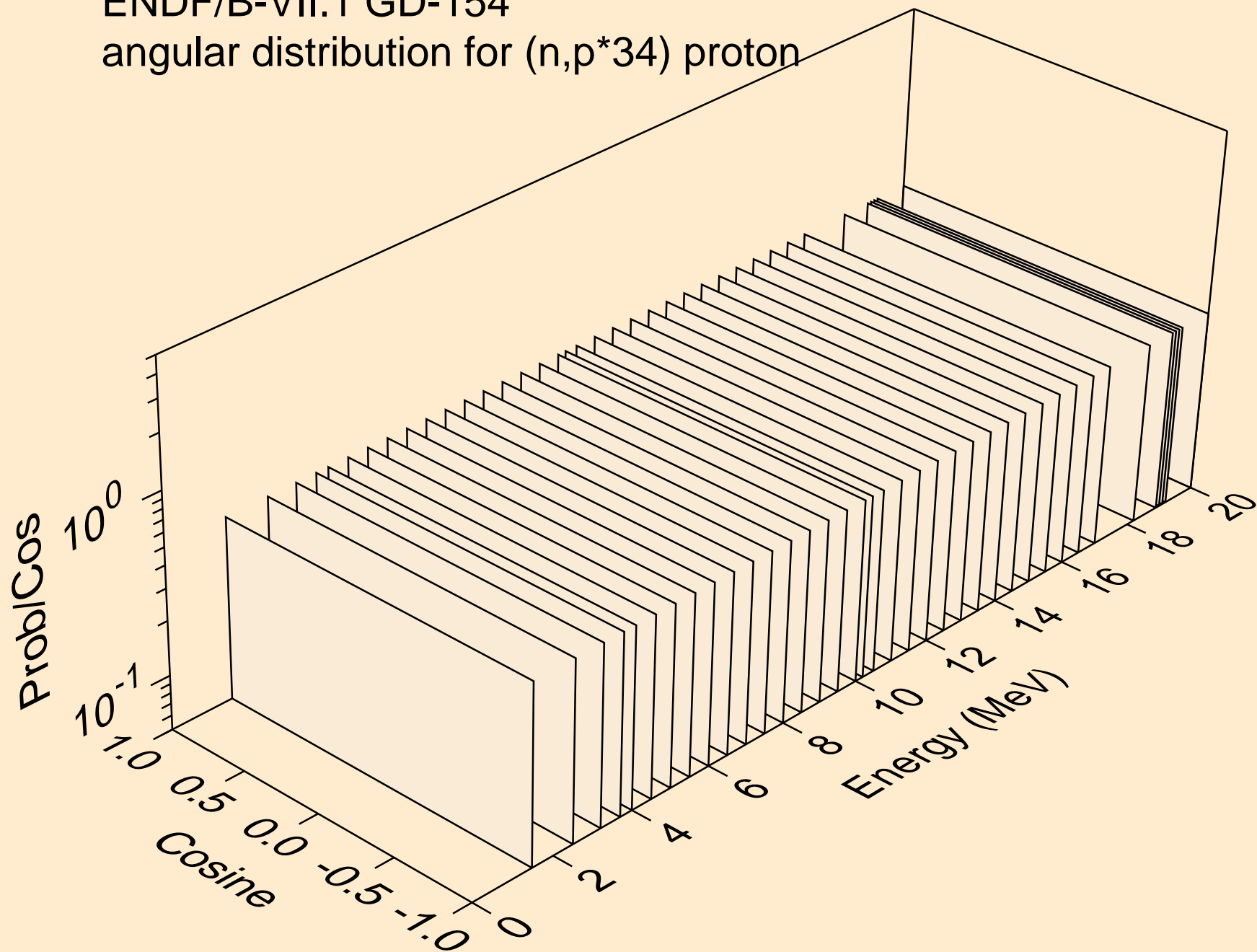

ENDF/B-VII.1 GD-154  
angular distribution for (n,p\*35) proton

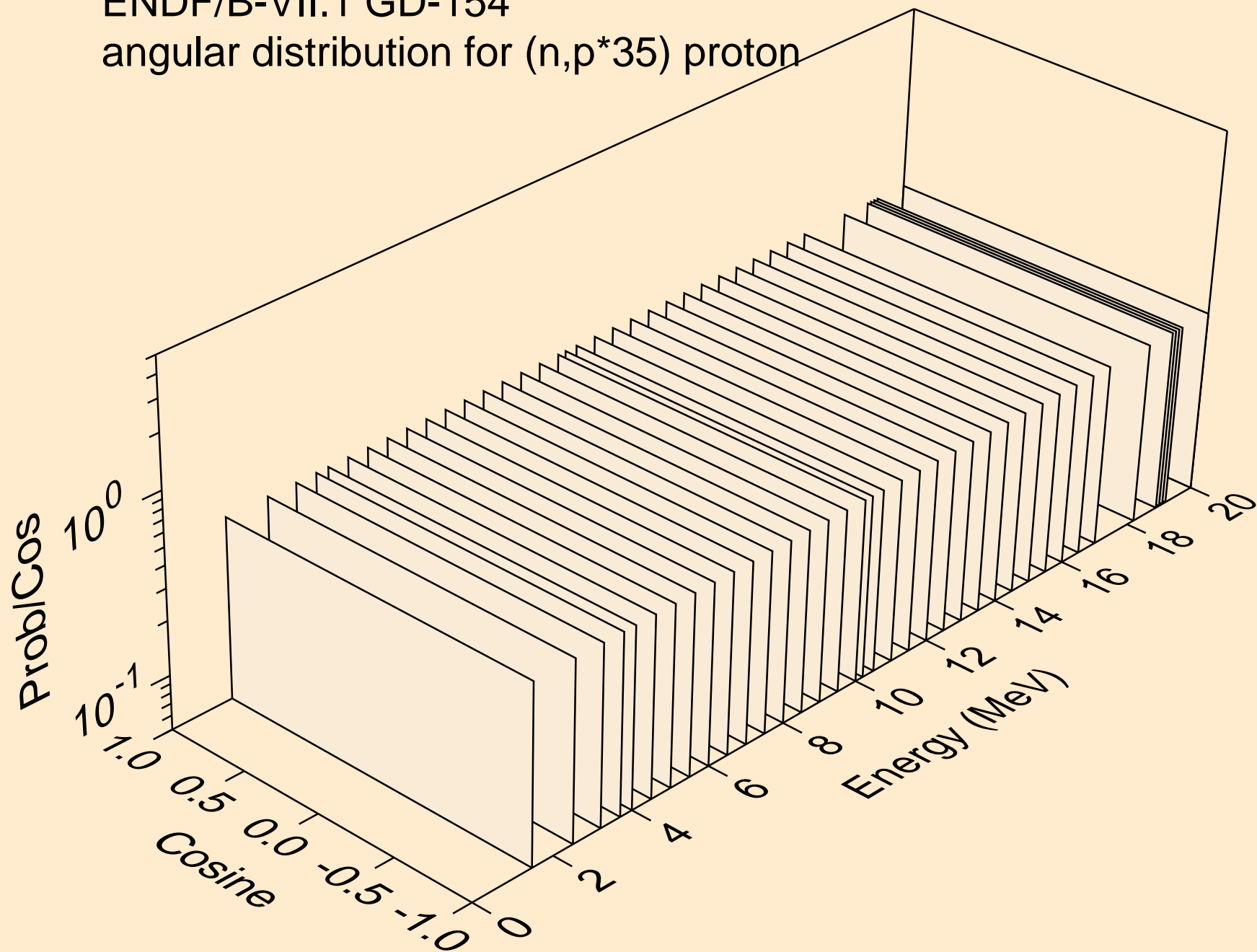

ENDF/B-VII.1 GD-154  
angular distribution for (n,p\*36) proton

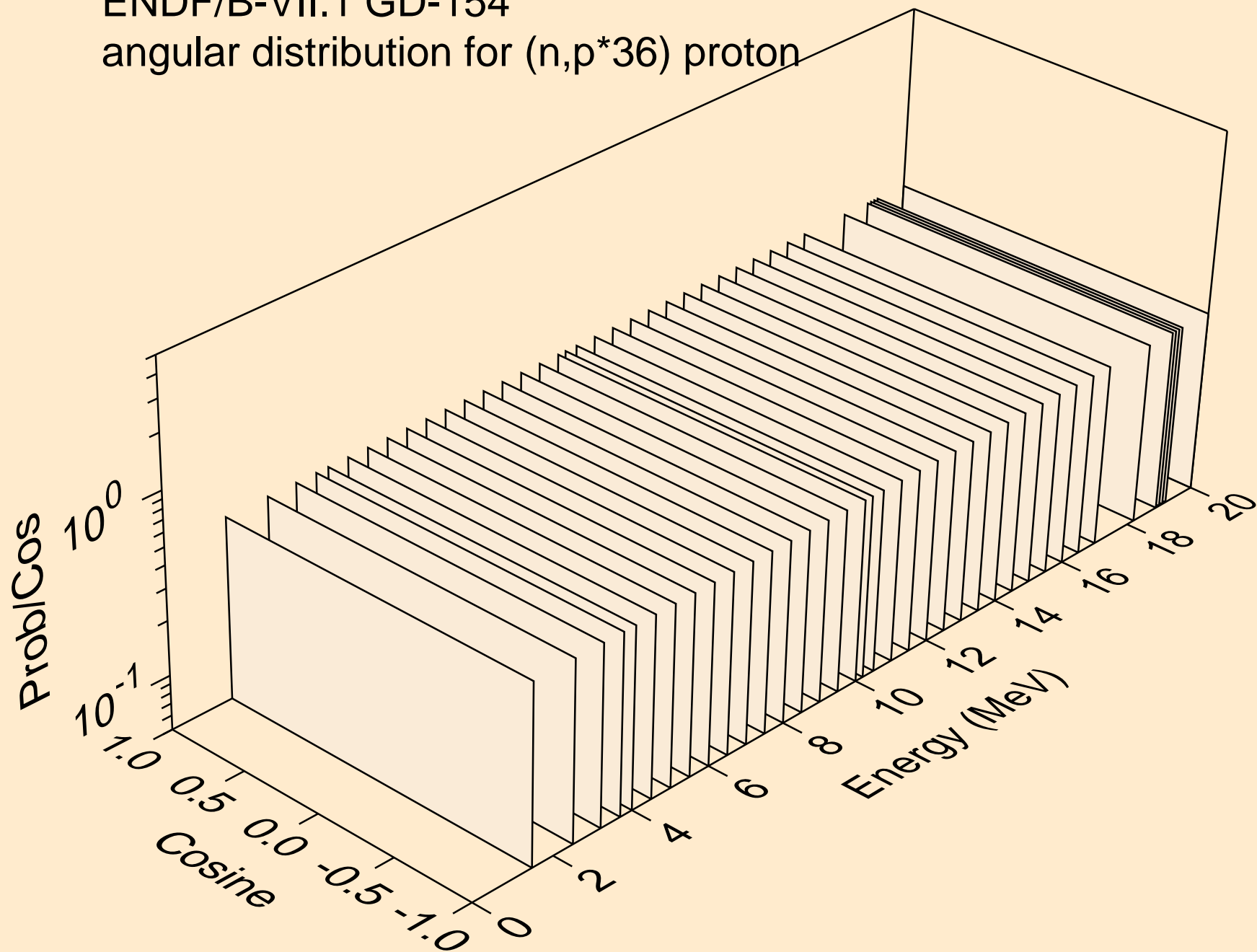

ENDF/B-VII.1 GD-154  
angular distribution for (n,p\*37) proton

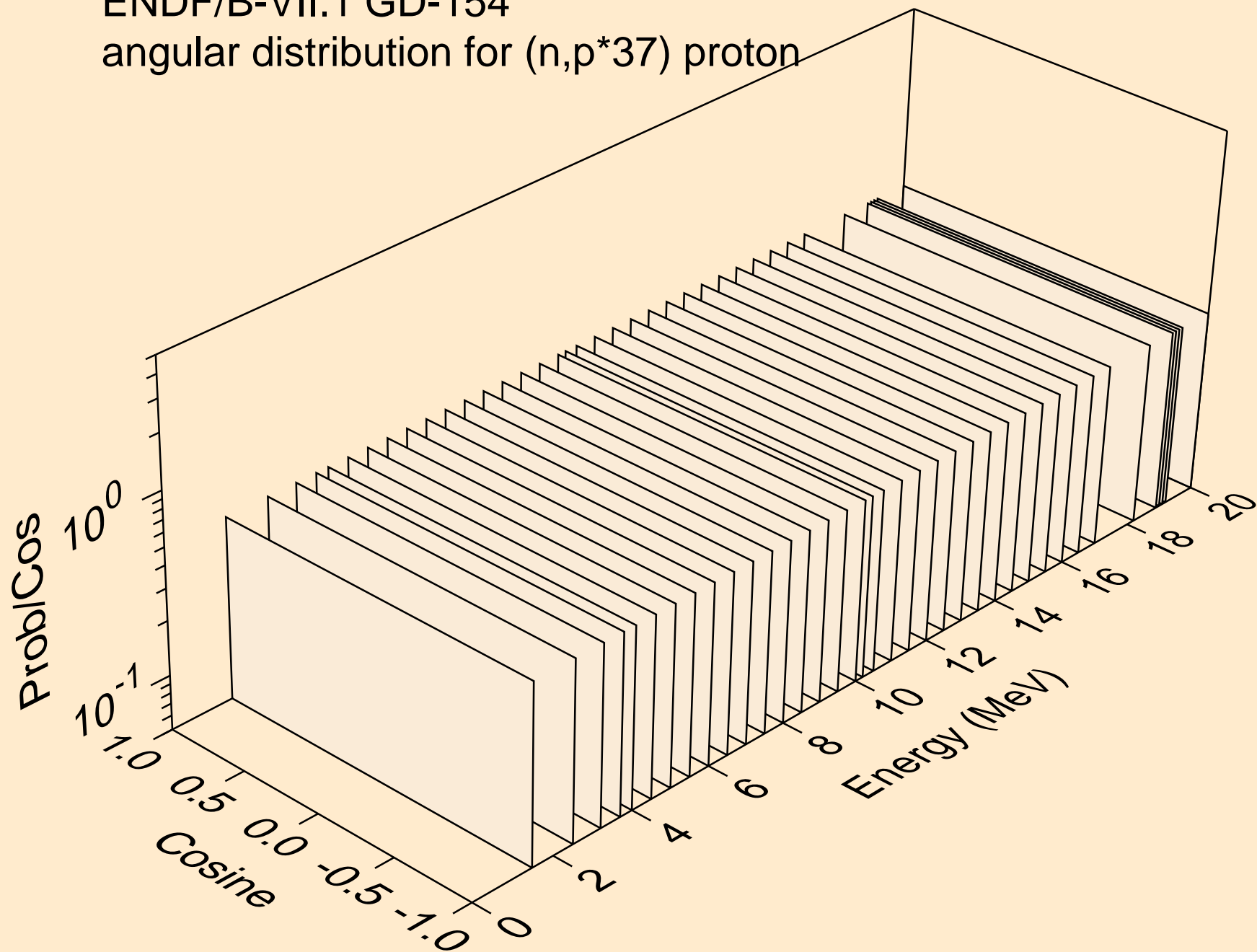

ENDF/B-VII.1 GD-154  
angular distribution for (n,p\*38) proton

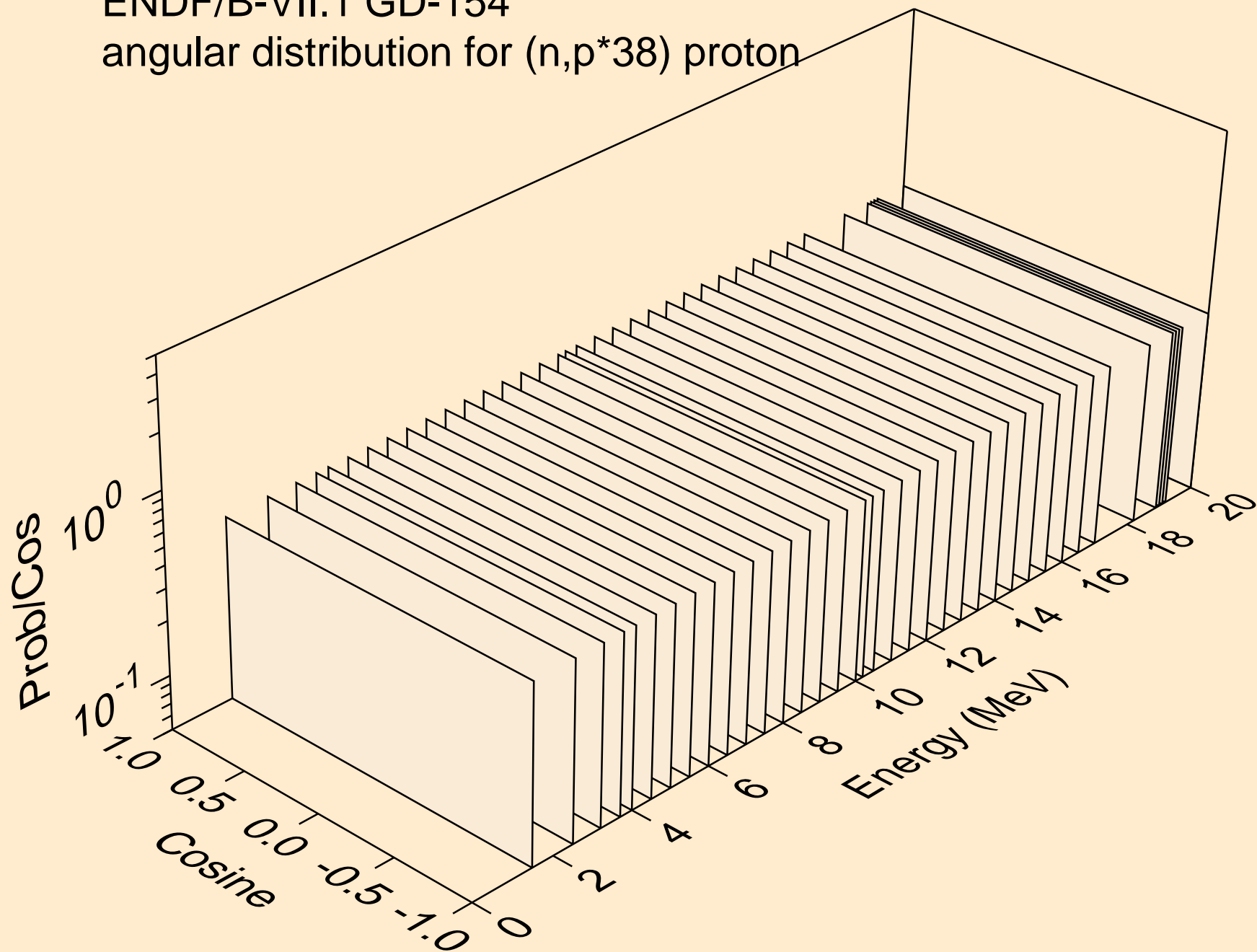



ENDF/B-VII.1 GD-154  
angular distribution for (n,p\*39) proton

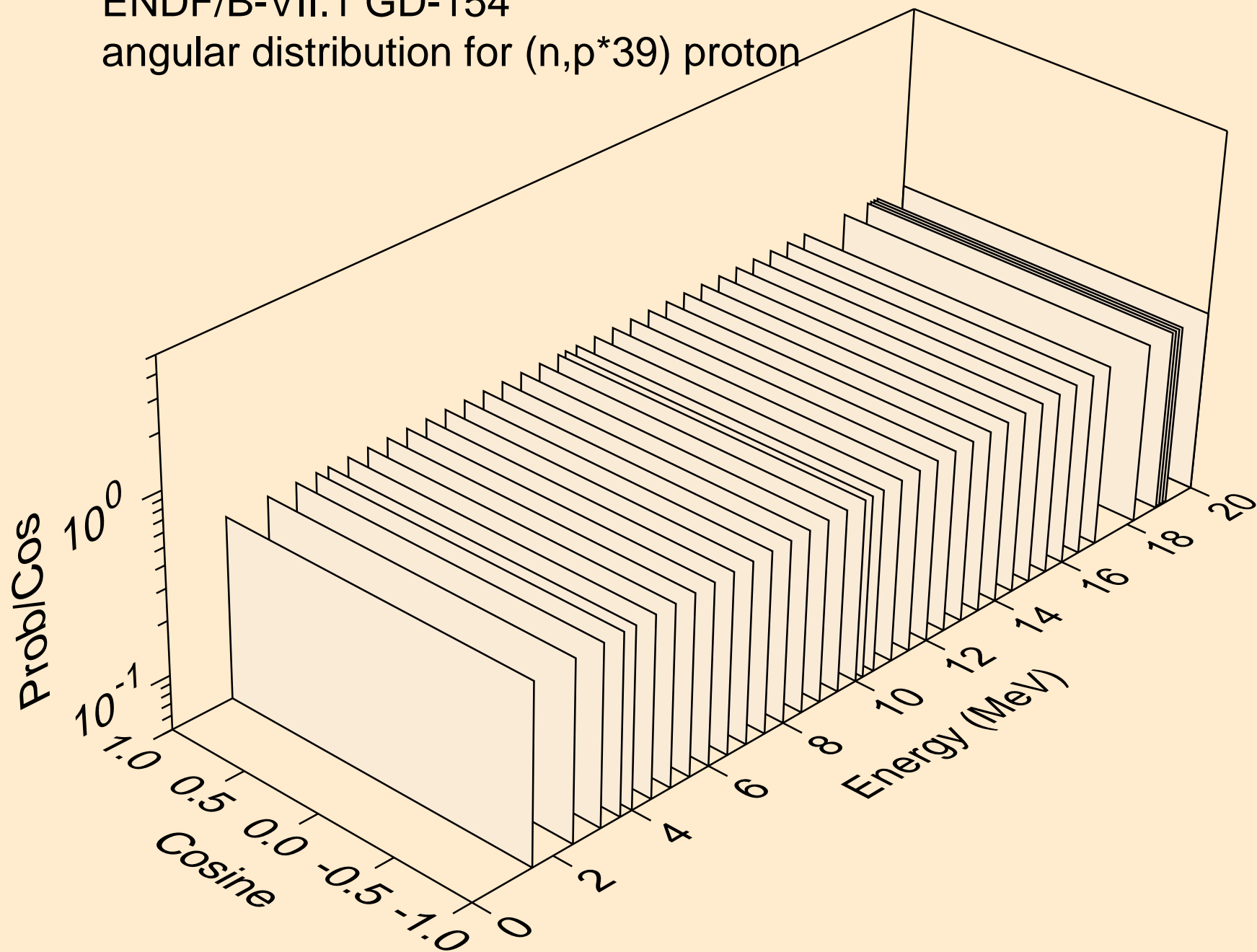

ENDF/B-VII.1 GD-154  
protons from (n,p\*c)

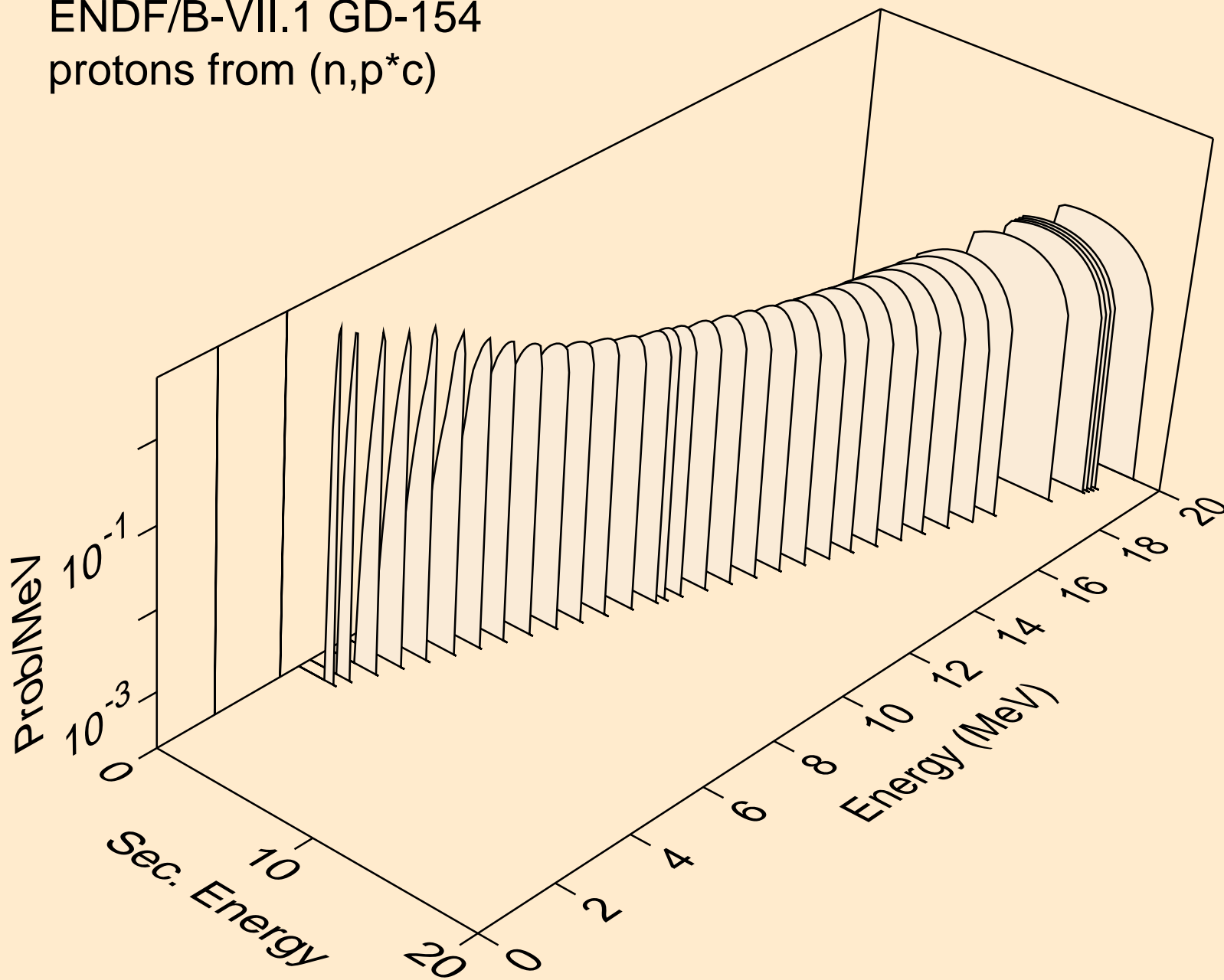

ENDF/B-VII.1 GD-154  
alphas from (n,n\*)a

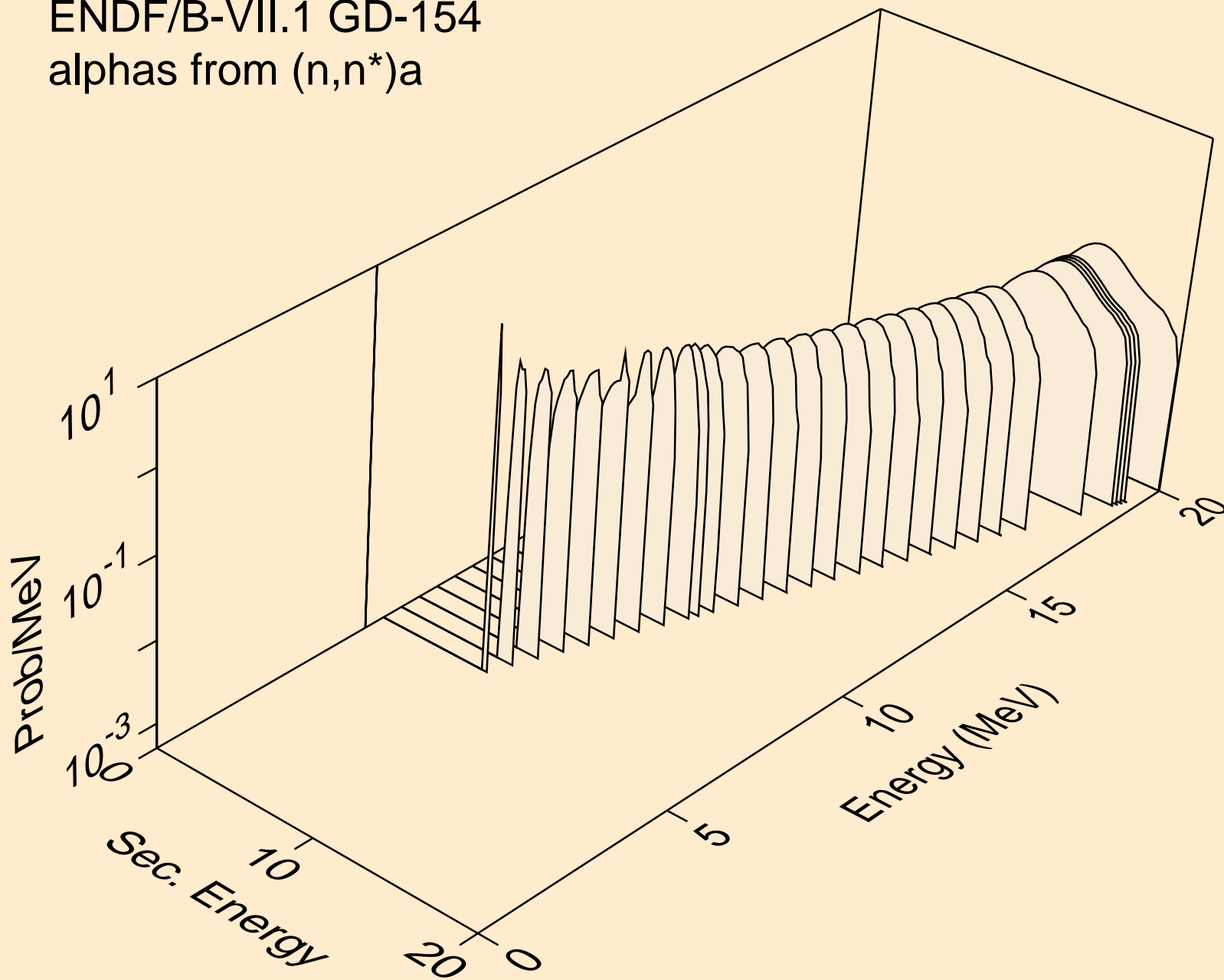

ENDF/B-VII.1 GD-154  
alphas from (n,2n)a

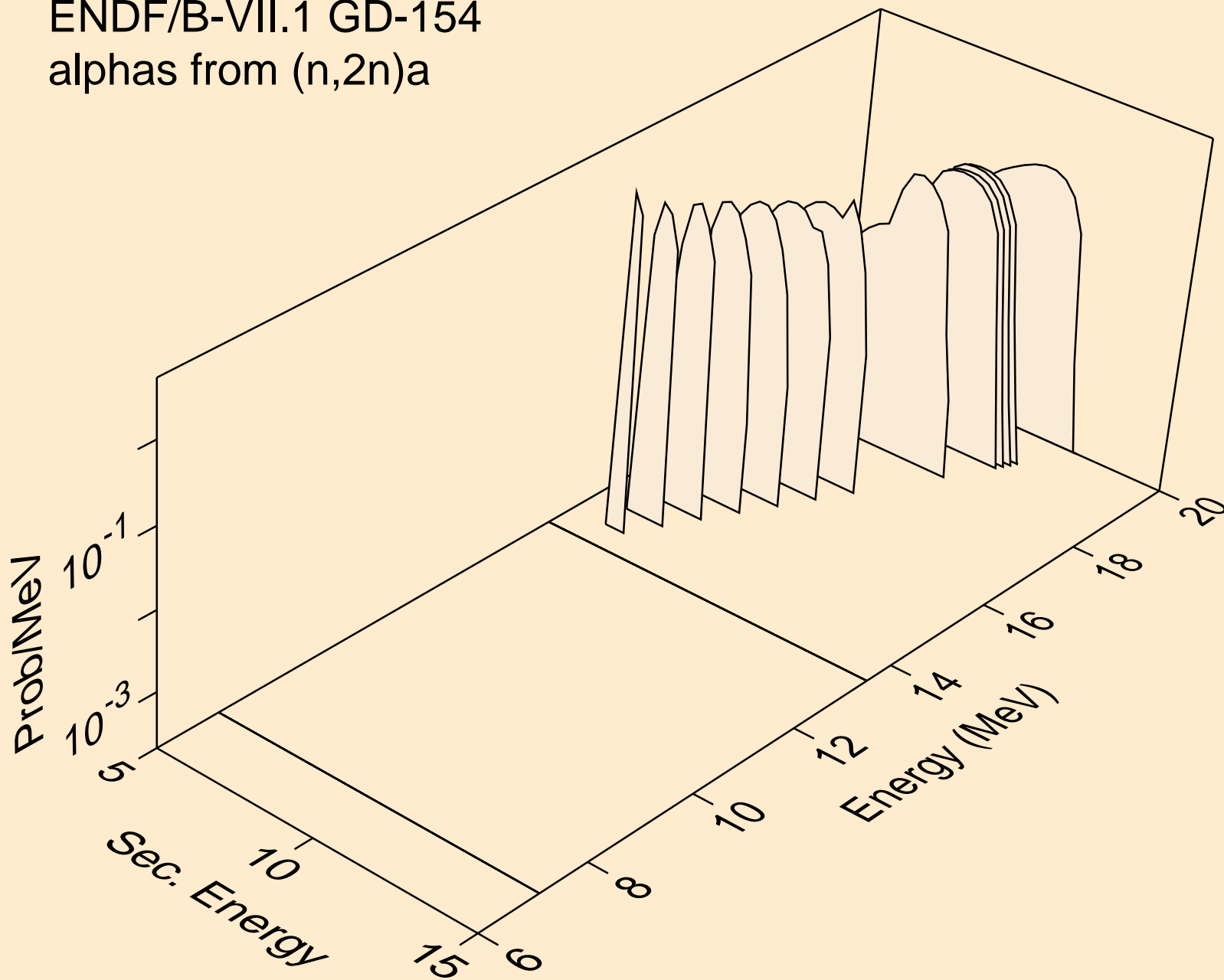

ENDF/B-VII.1 GD-154  
angular distribution for (n,a\*0) alpha

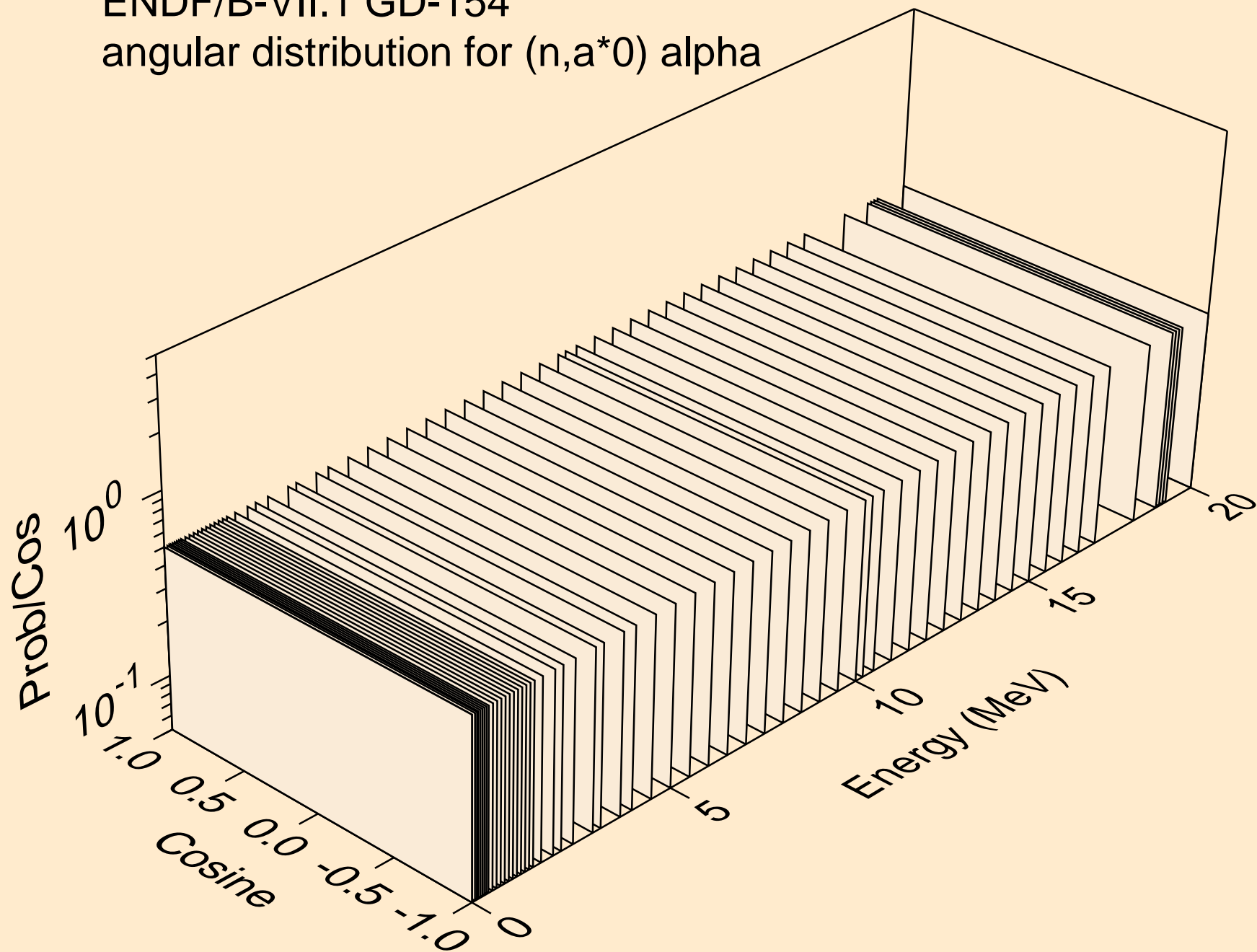

ENDF/B-VII.1 GD-154  
angular distribution for (n,a\*1) alpha

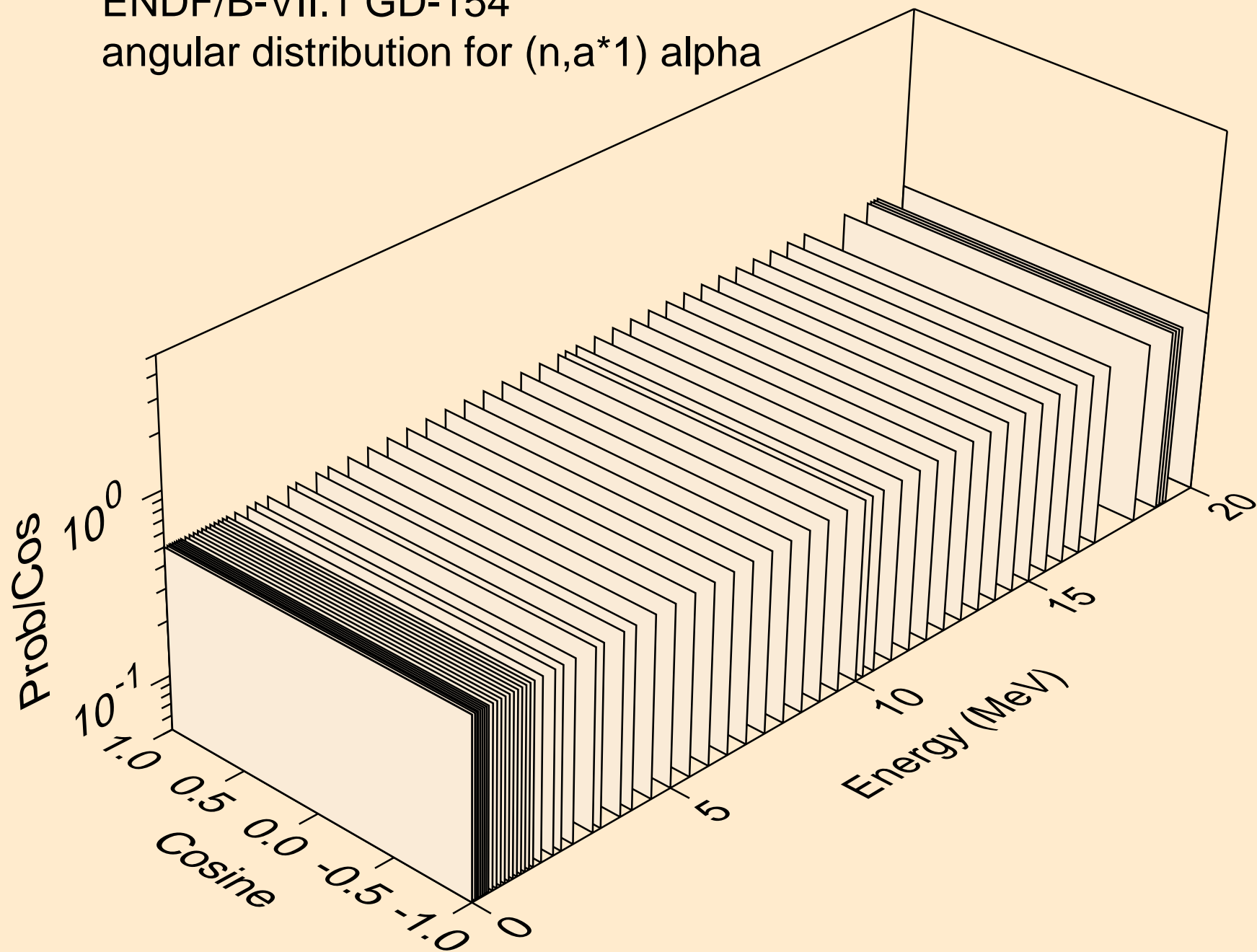

ENDF/B-VII.1 GD-154  
angular distribution for (n,a\*2) alpha

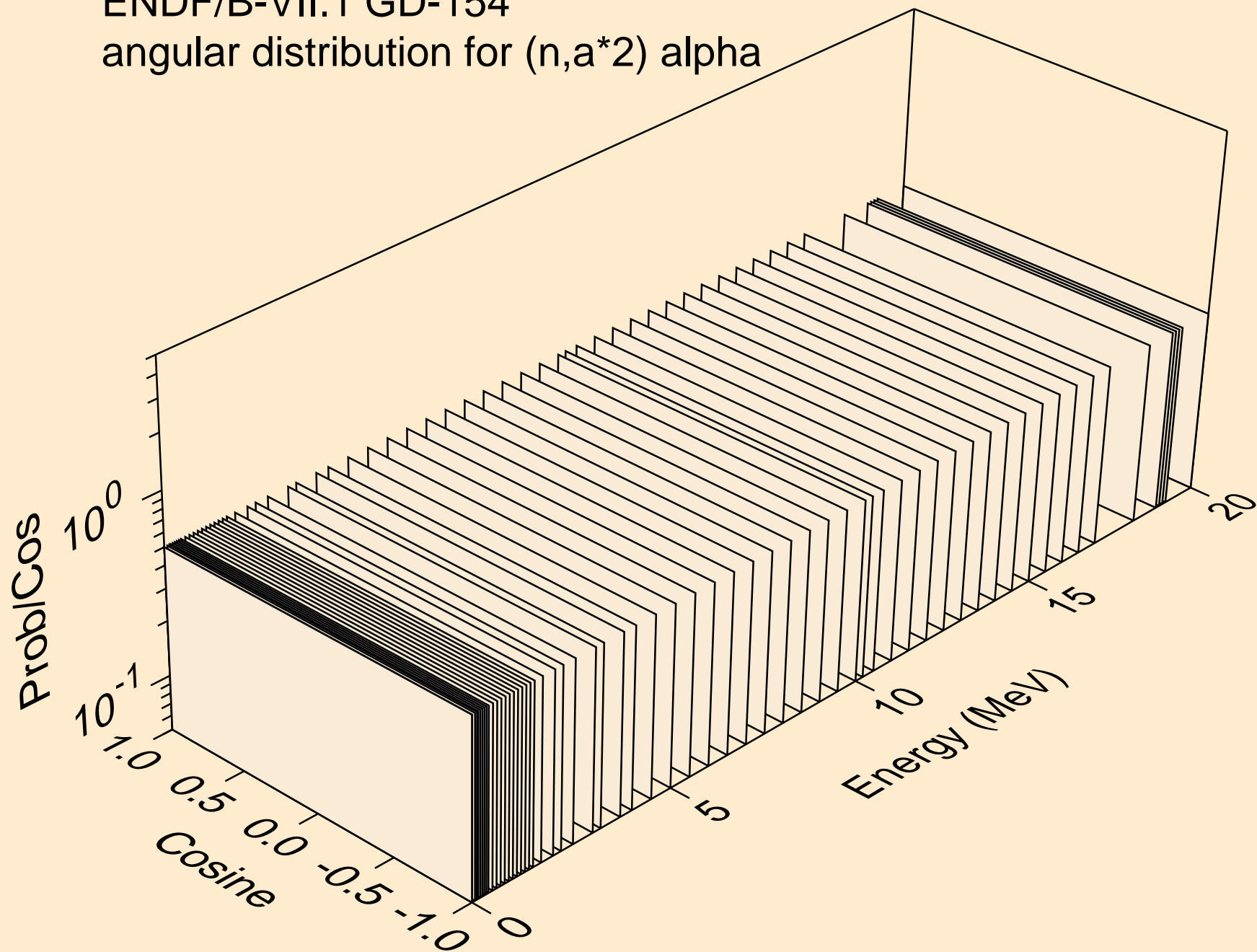

ENDF/B-VII.1 GD-154  
angular distribution for (n,a\*3) alpha

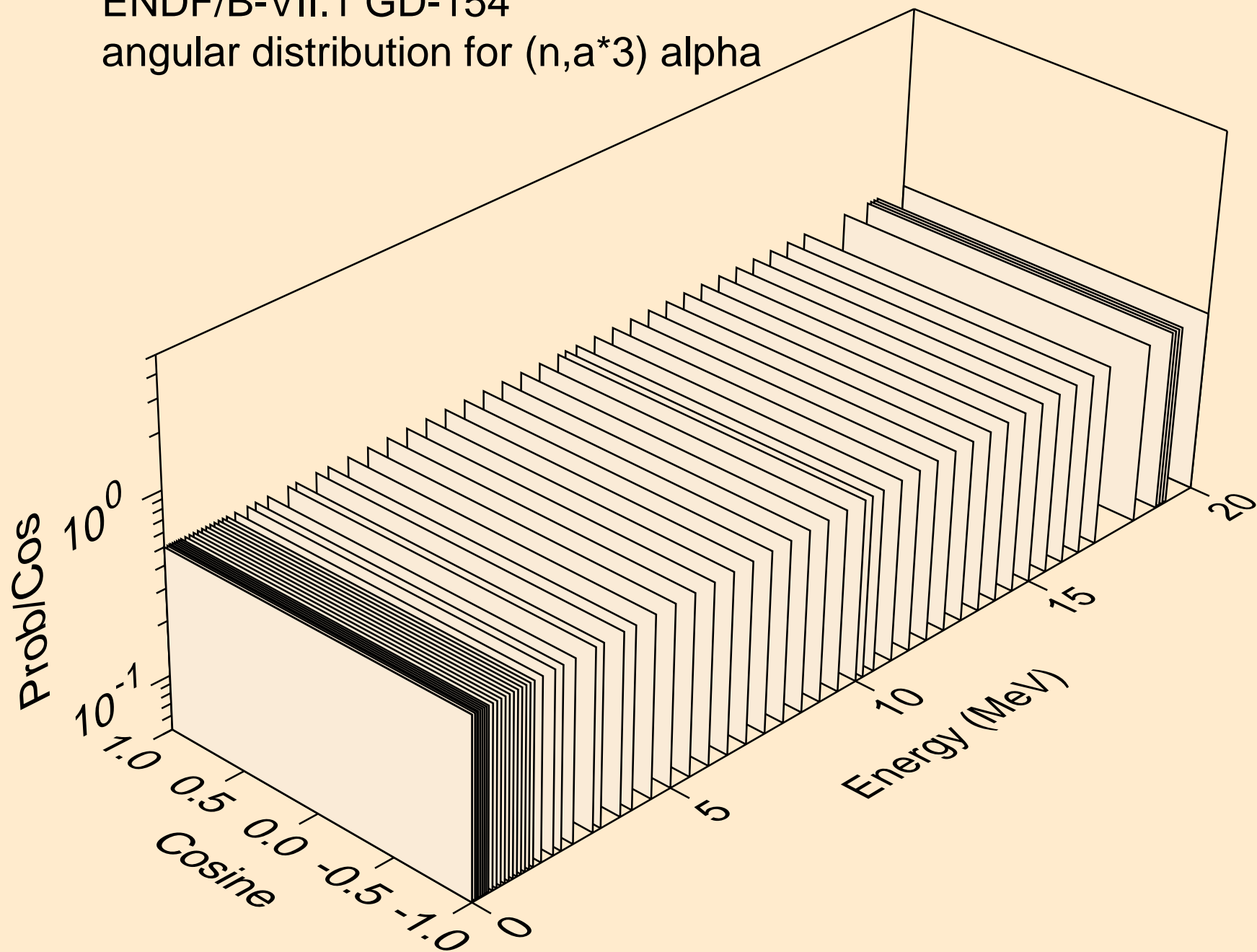



ENDF/B-VII.1 GD-154  
angular distribution for (n,a\*4) alpha

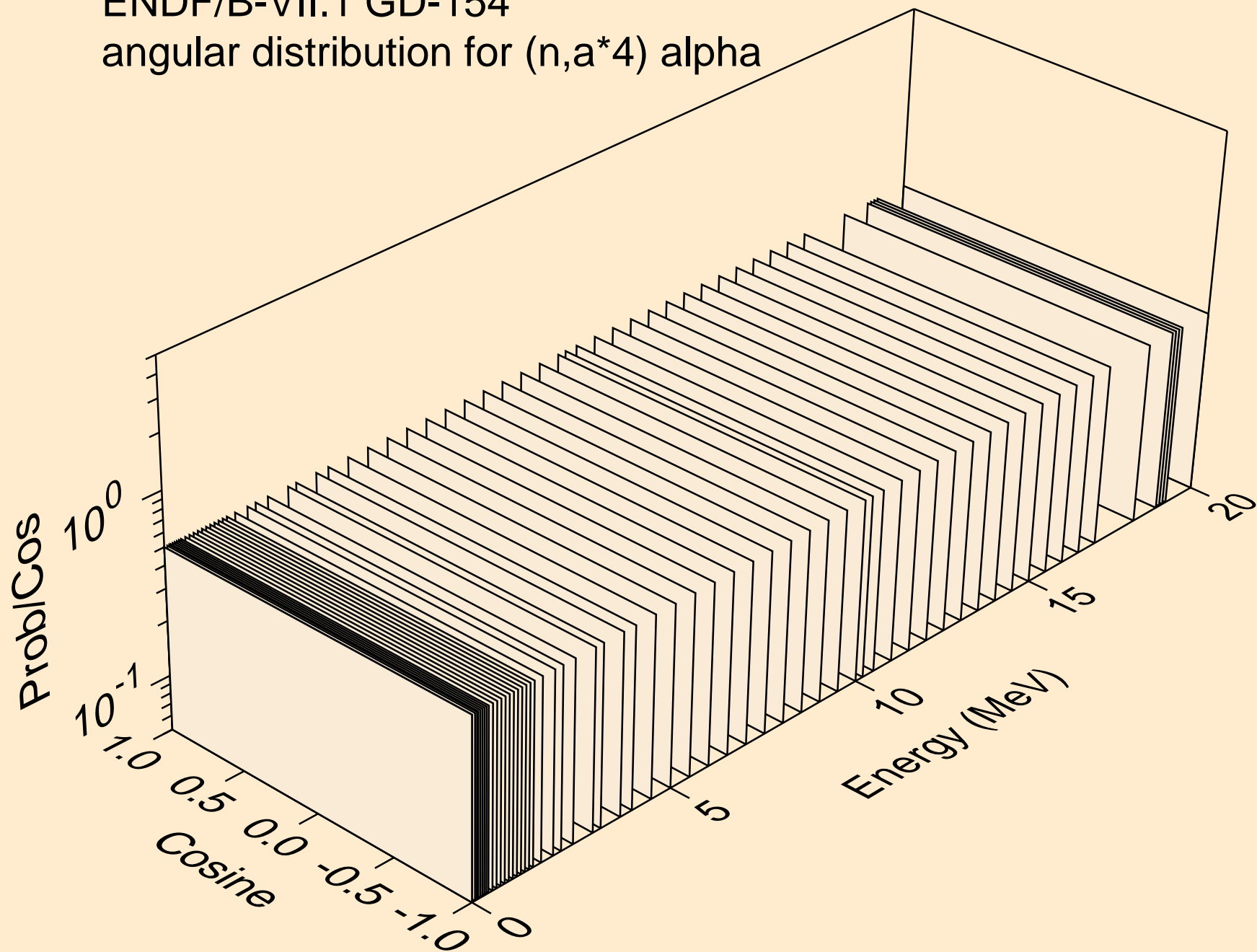

ENDF/B-VII.1 GD-154  
angular distribution for (n,a\*5) alpha

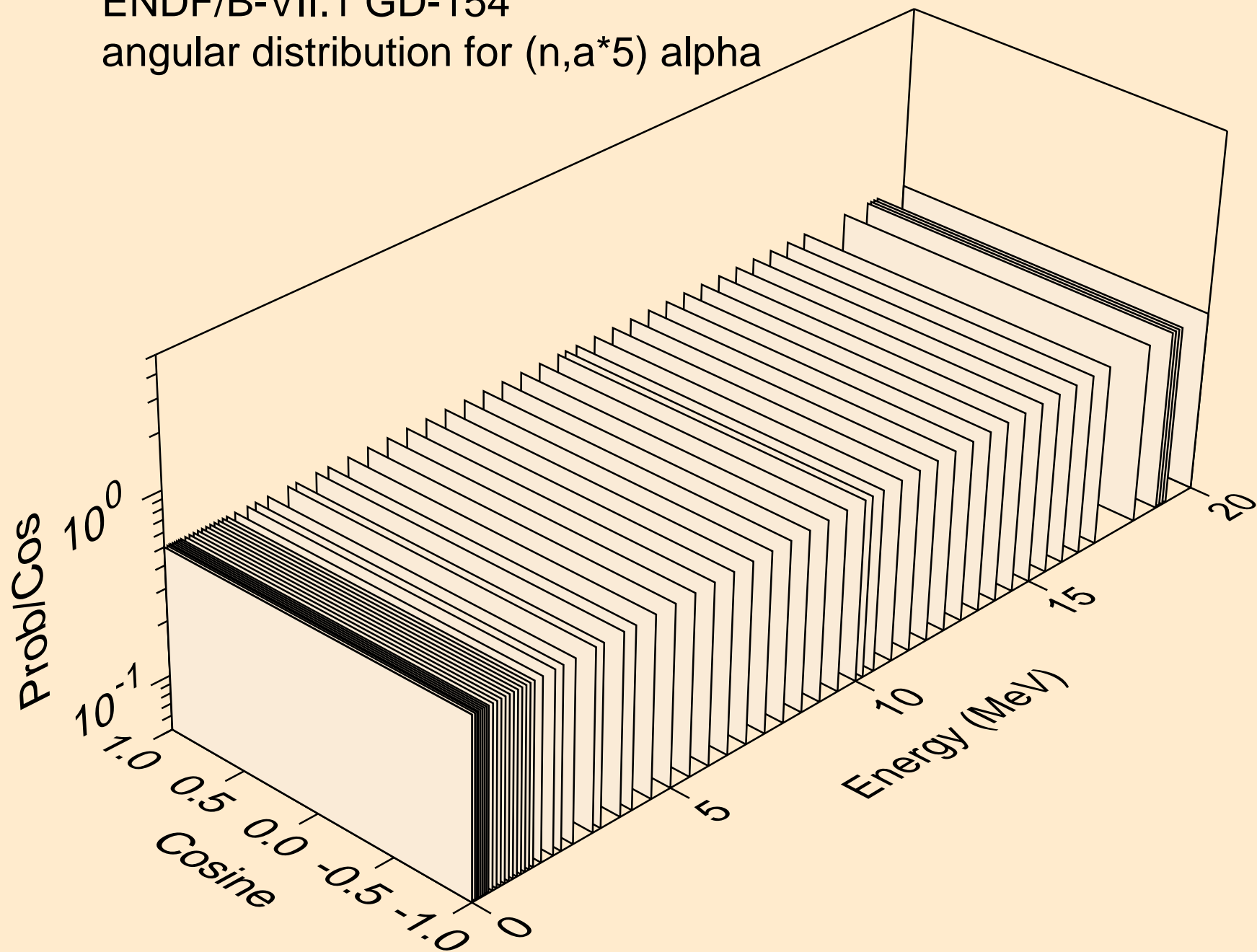

ENDF/B-VII.1 GD-154  
angular distribution for (n,a\*6) alpha

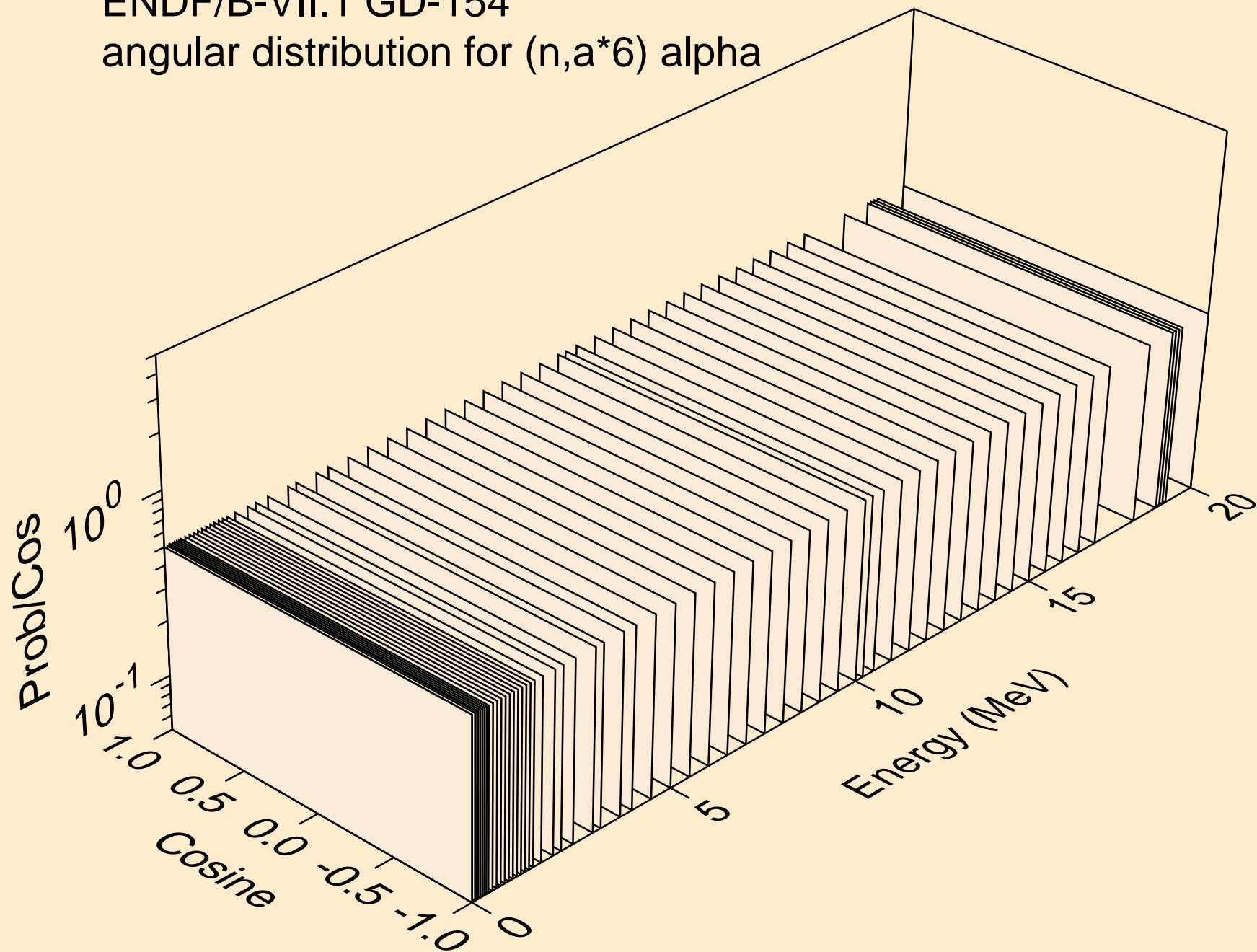

ENDF/B-VII.1 GD-154  
angular distribution for (n,a\*7) alpha

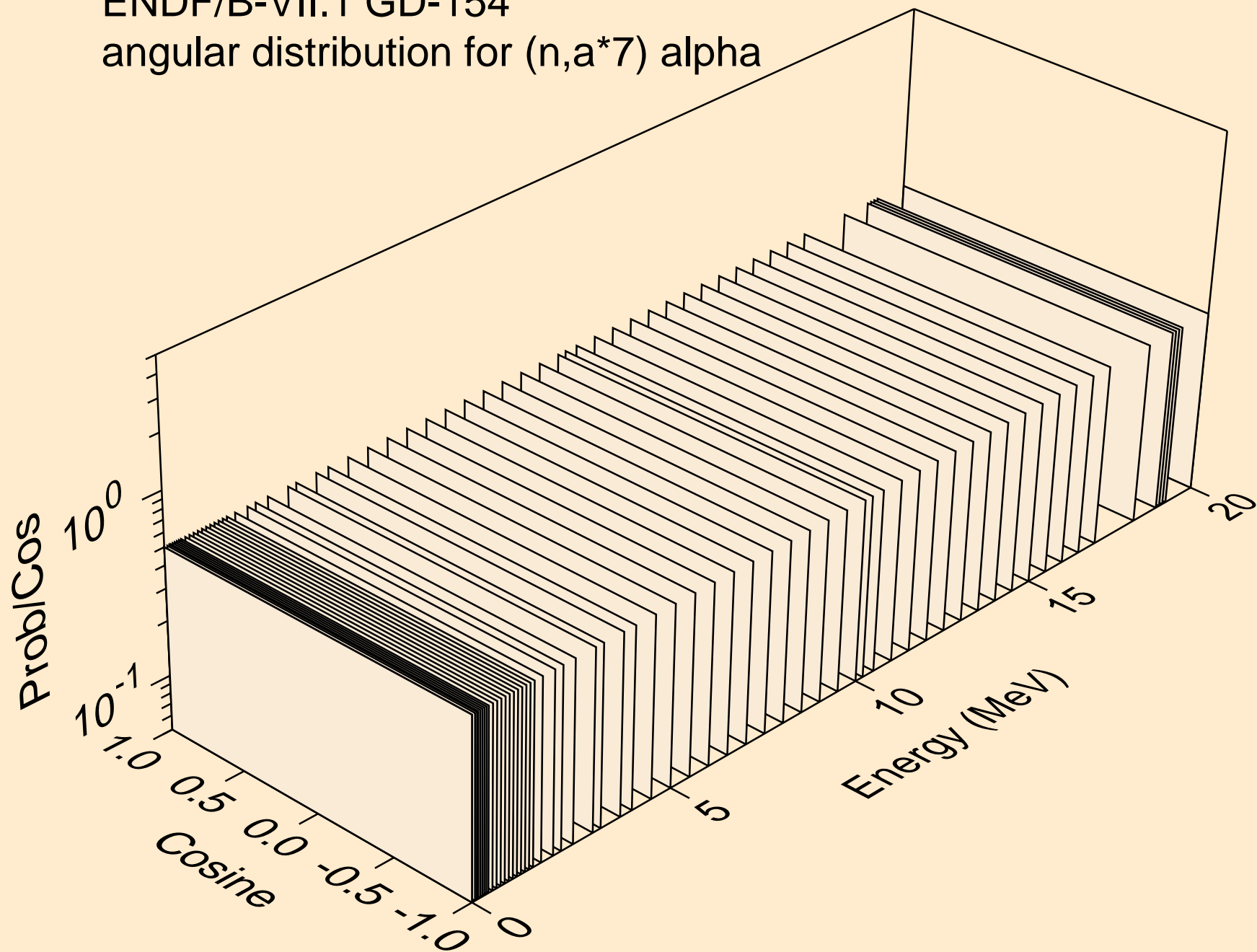

ENDF/B-VII.1 GD-154  
angular distribution for (n,a\*8) alpha

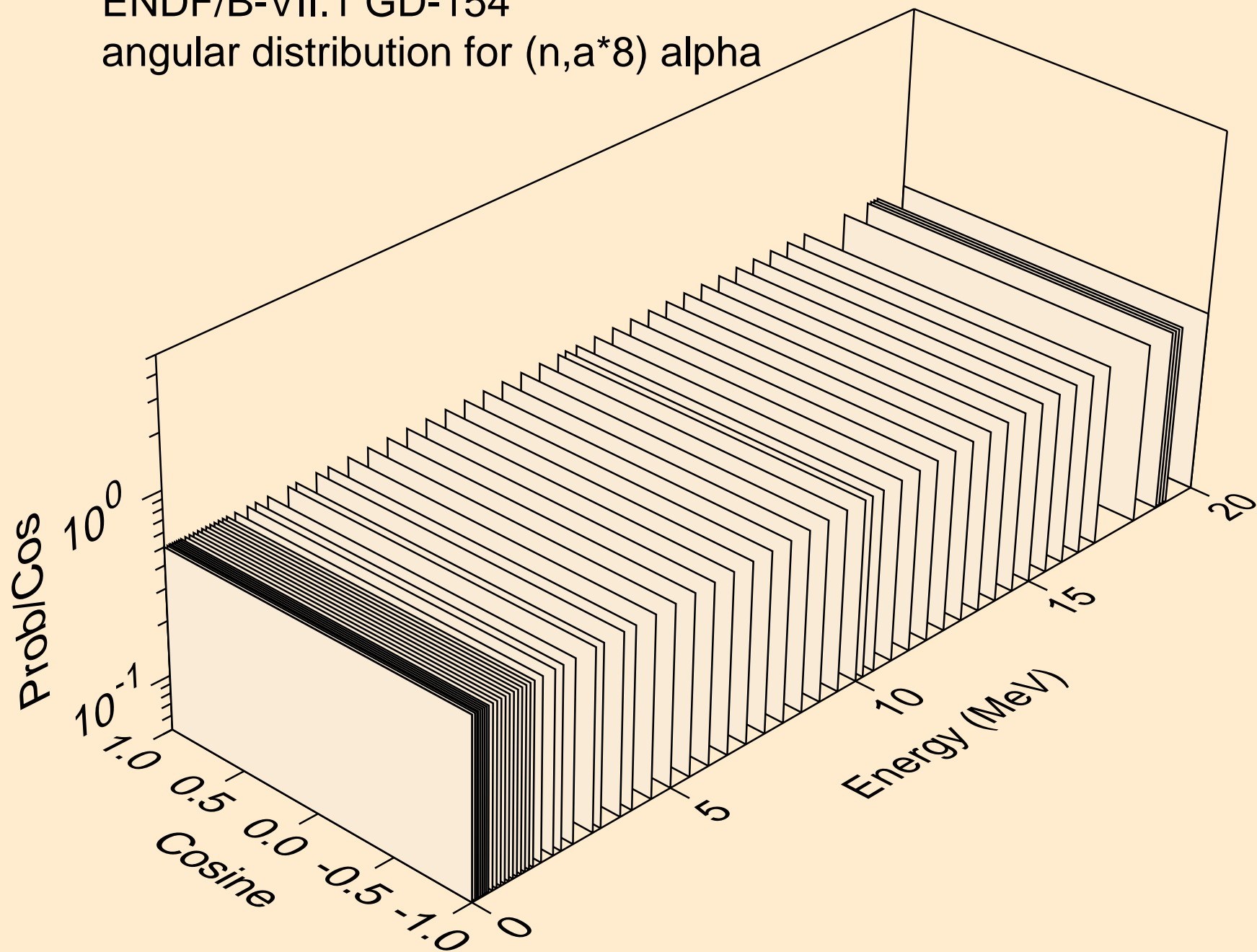

ENDF/B-VII.1 GD-154  
angular distribution for (n,a\*9) alpha

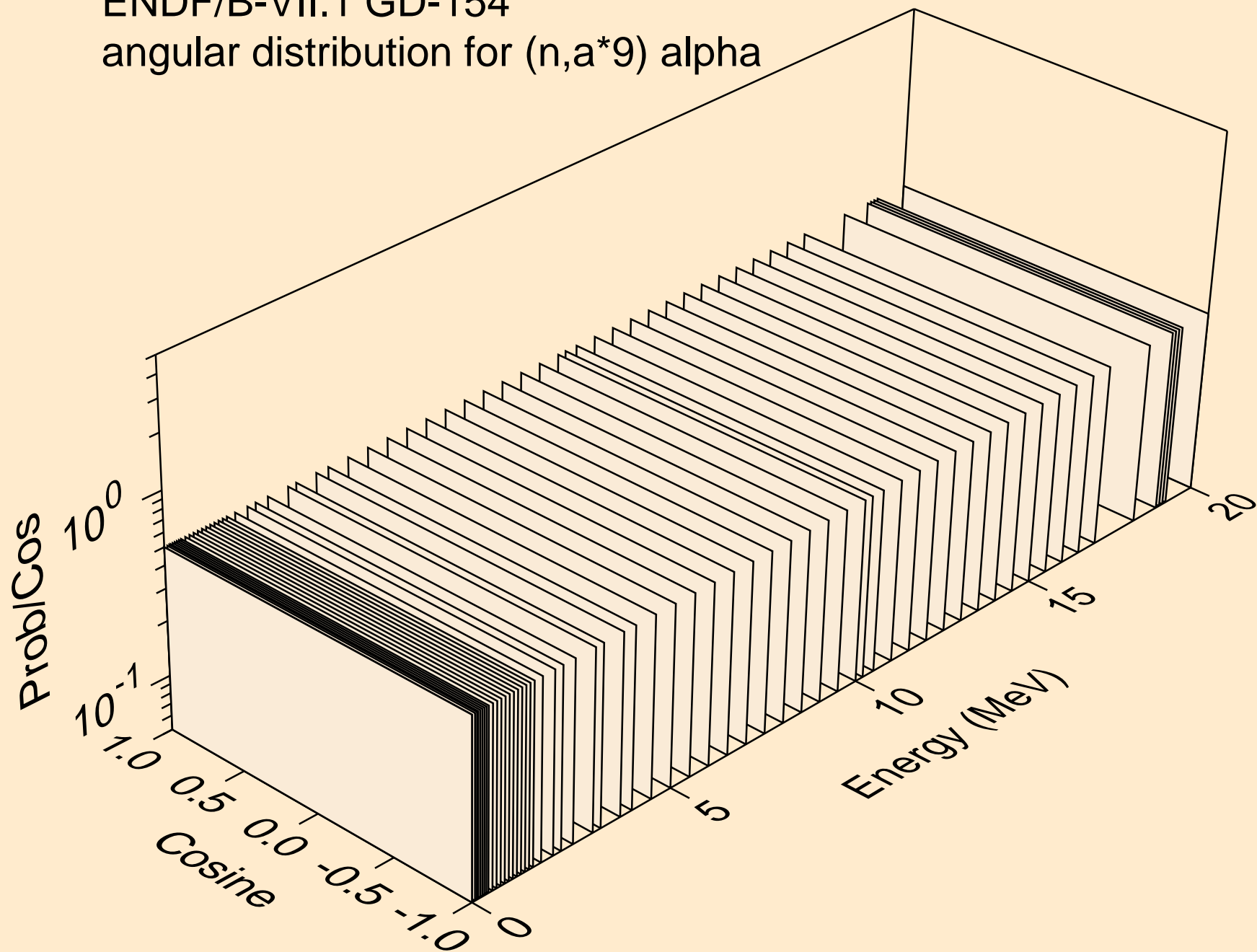

ENDF/B-VII.1 GD-154  
alphas from (n,a\*c)

