

# ENDF/B-VII.1 CM-248

## Principal cross sections

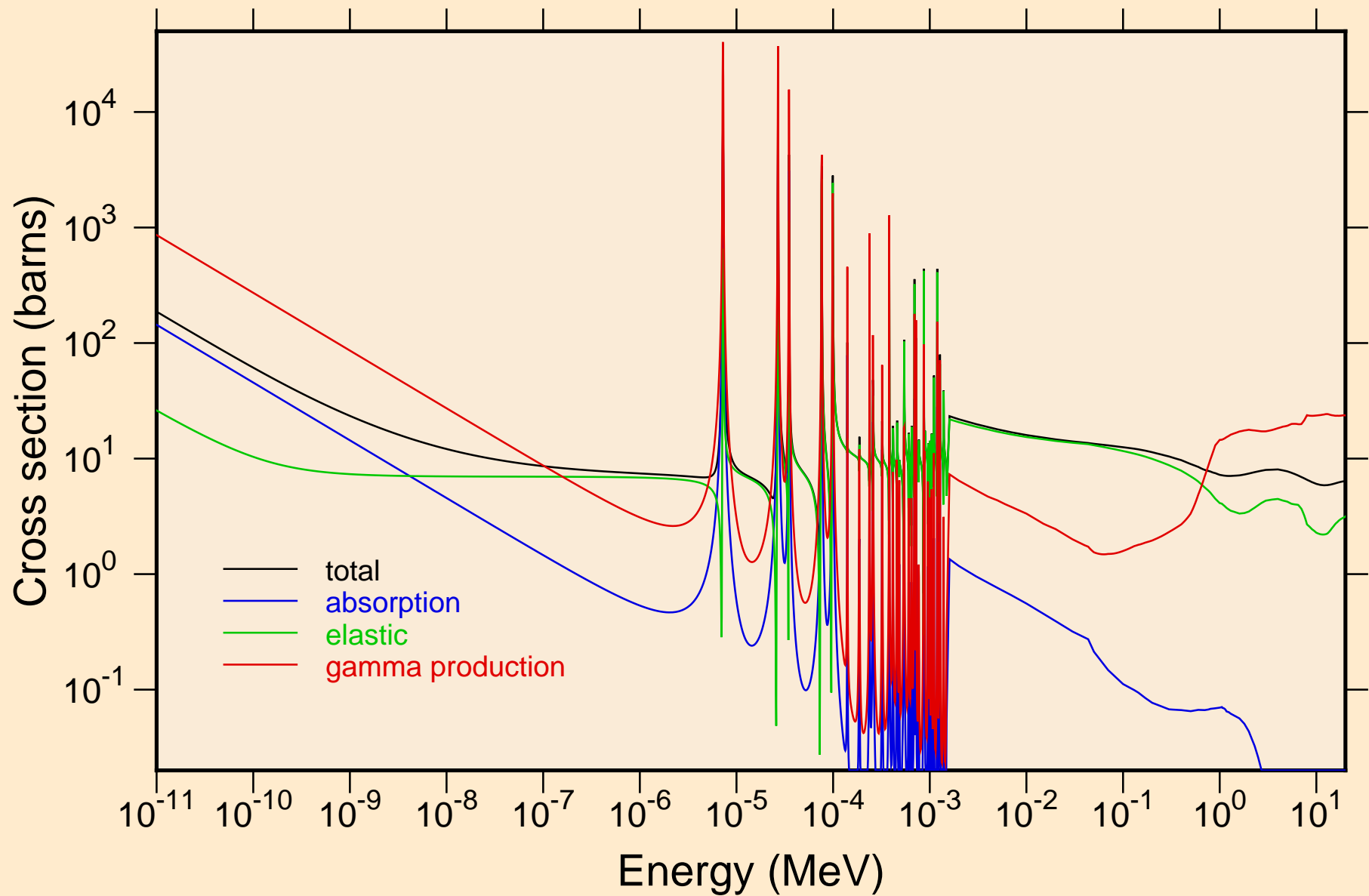

ENDF/B-VII.1 CM-248  
resonance total cross section

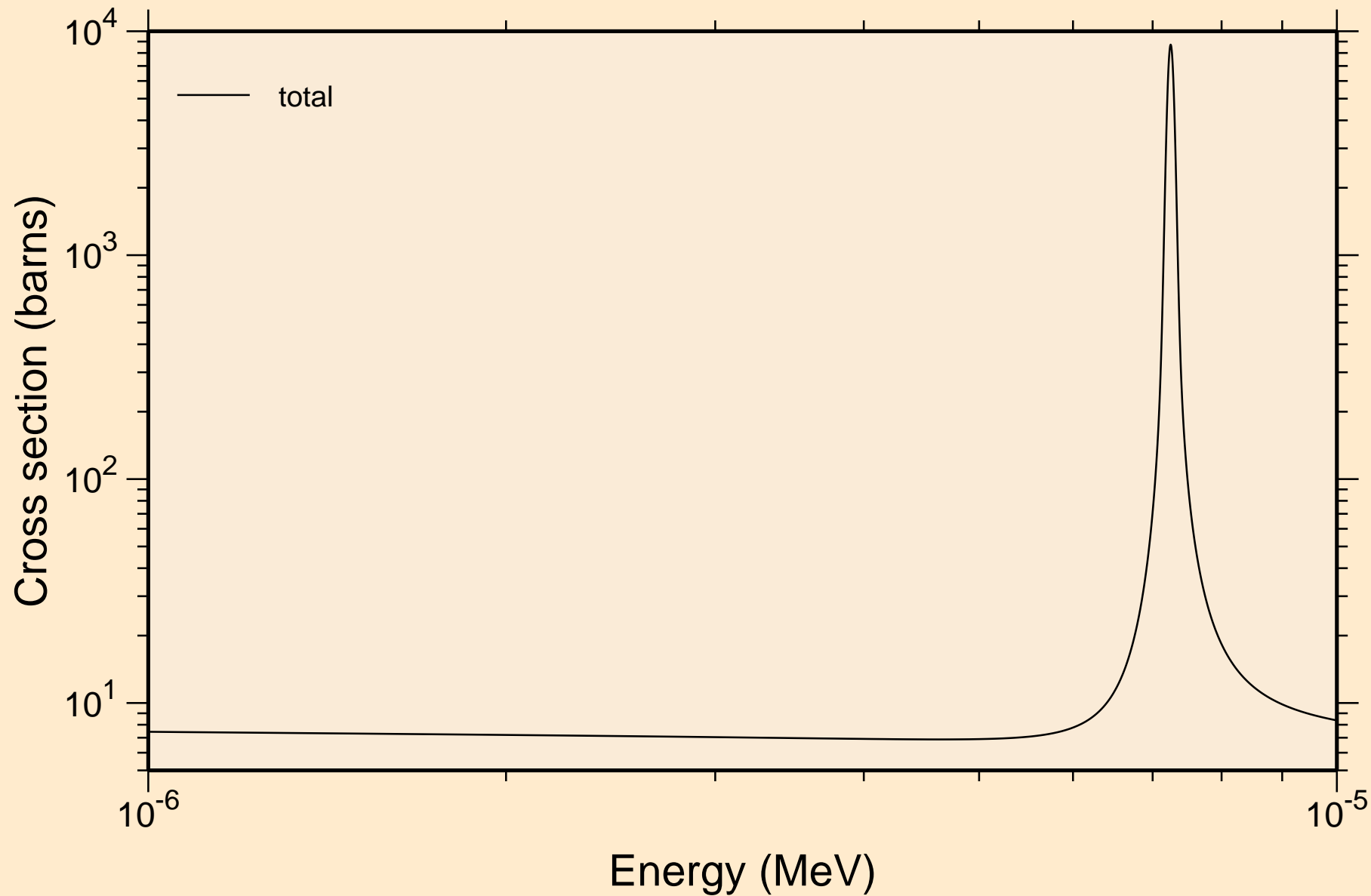

ENDF/B-VII.1 CM-248  
resonance total cross section

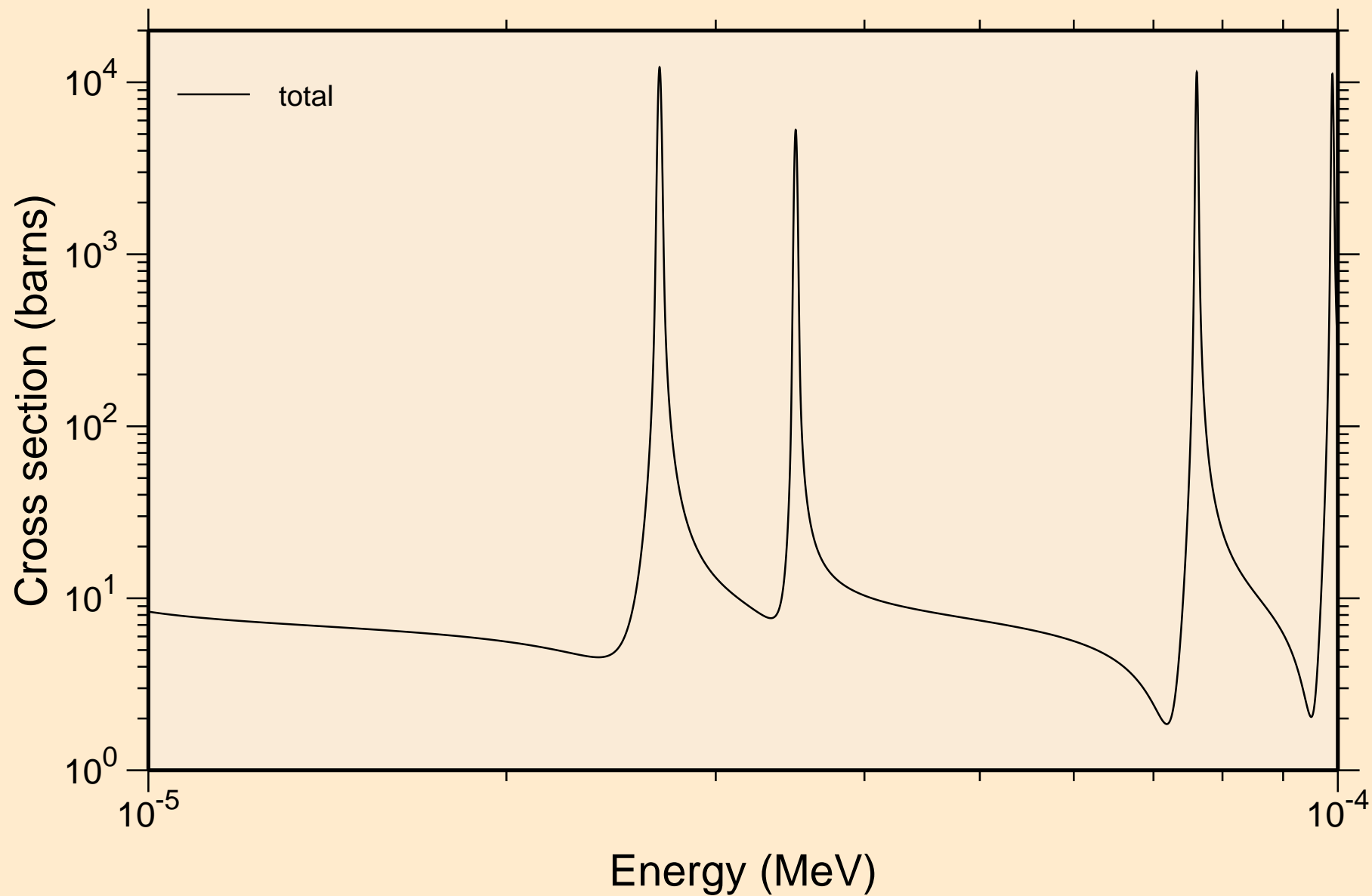

ENDF/B-VII.1 CM-248  
resonance total cross section

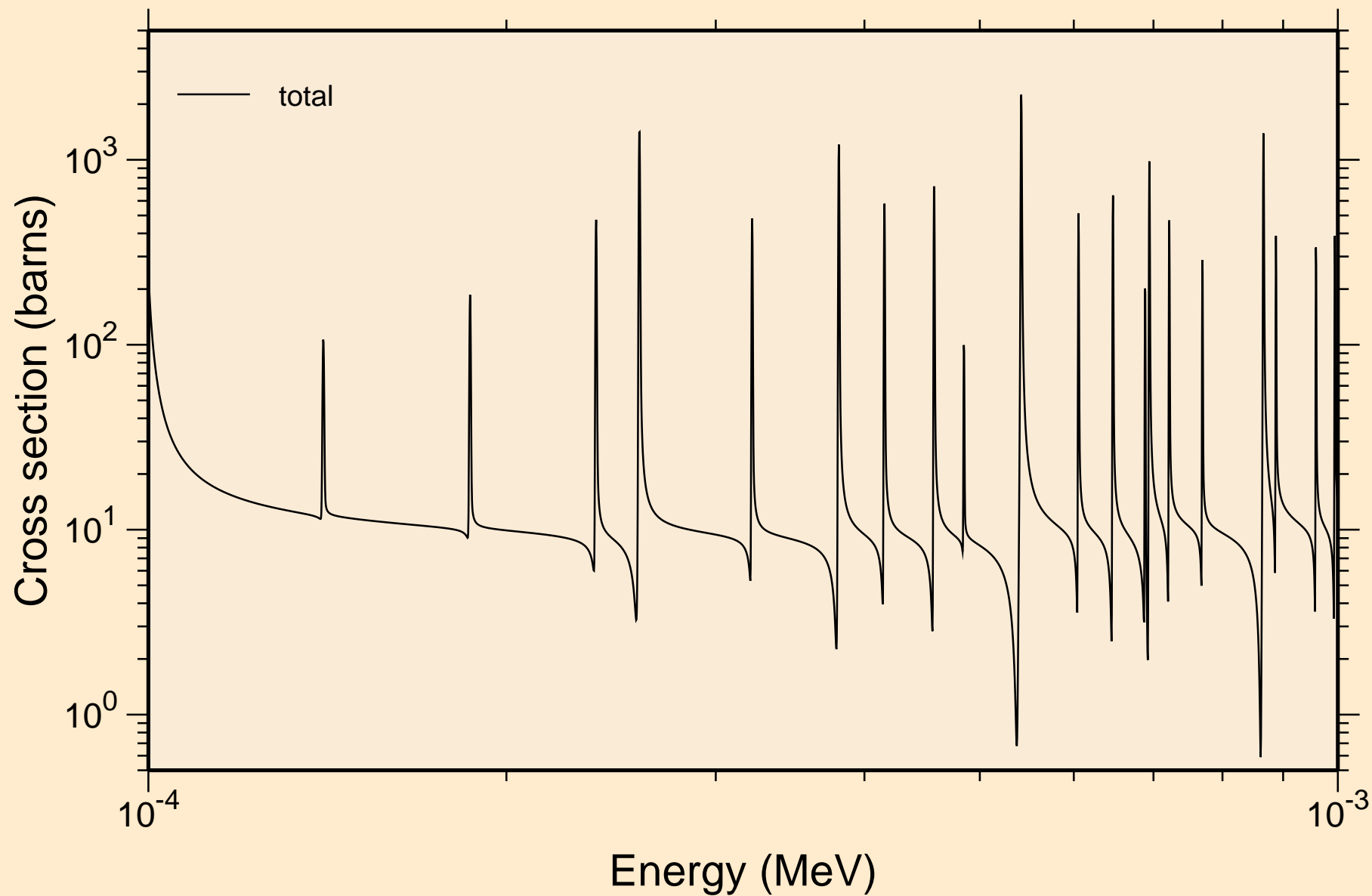

ENDF/B-VII.1 CM-248  
resonance total cross section

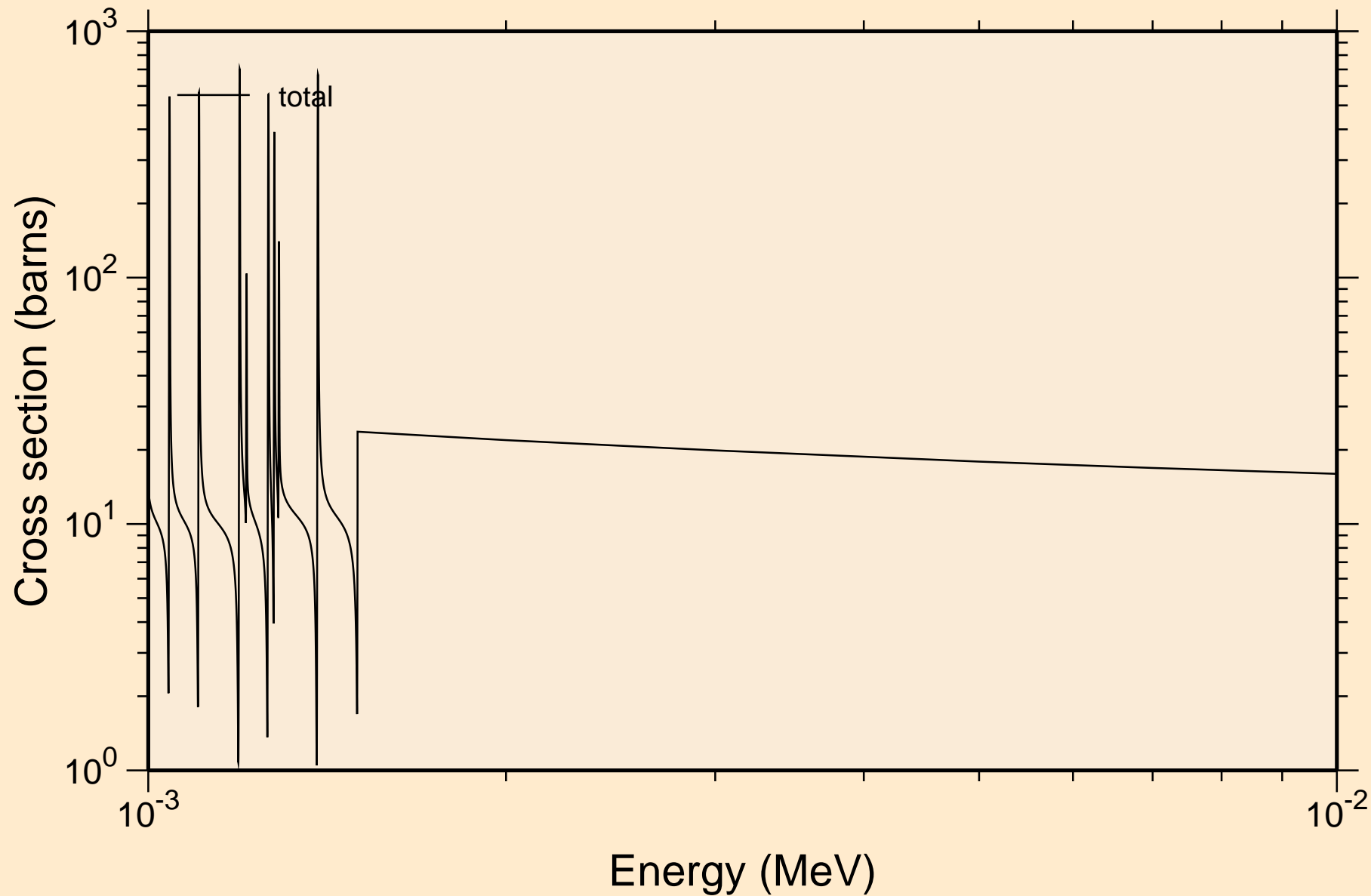

ENDF/B-VII.1 CM-248  
resonance total cross section

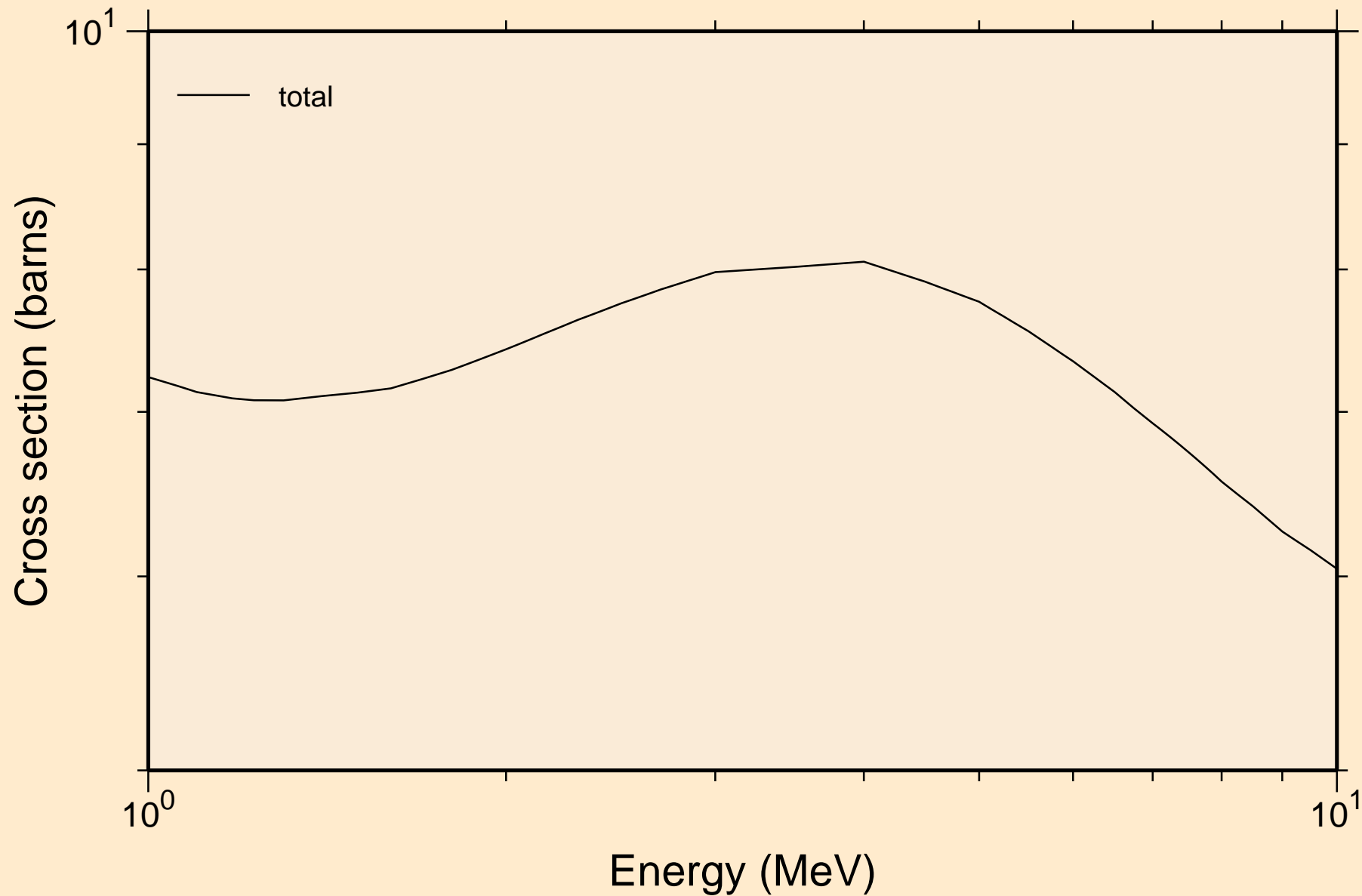

# ENDF/B-VII.1 CM-248 resonance absorption cross sections

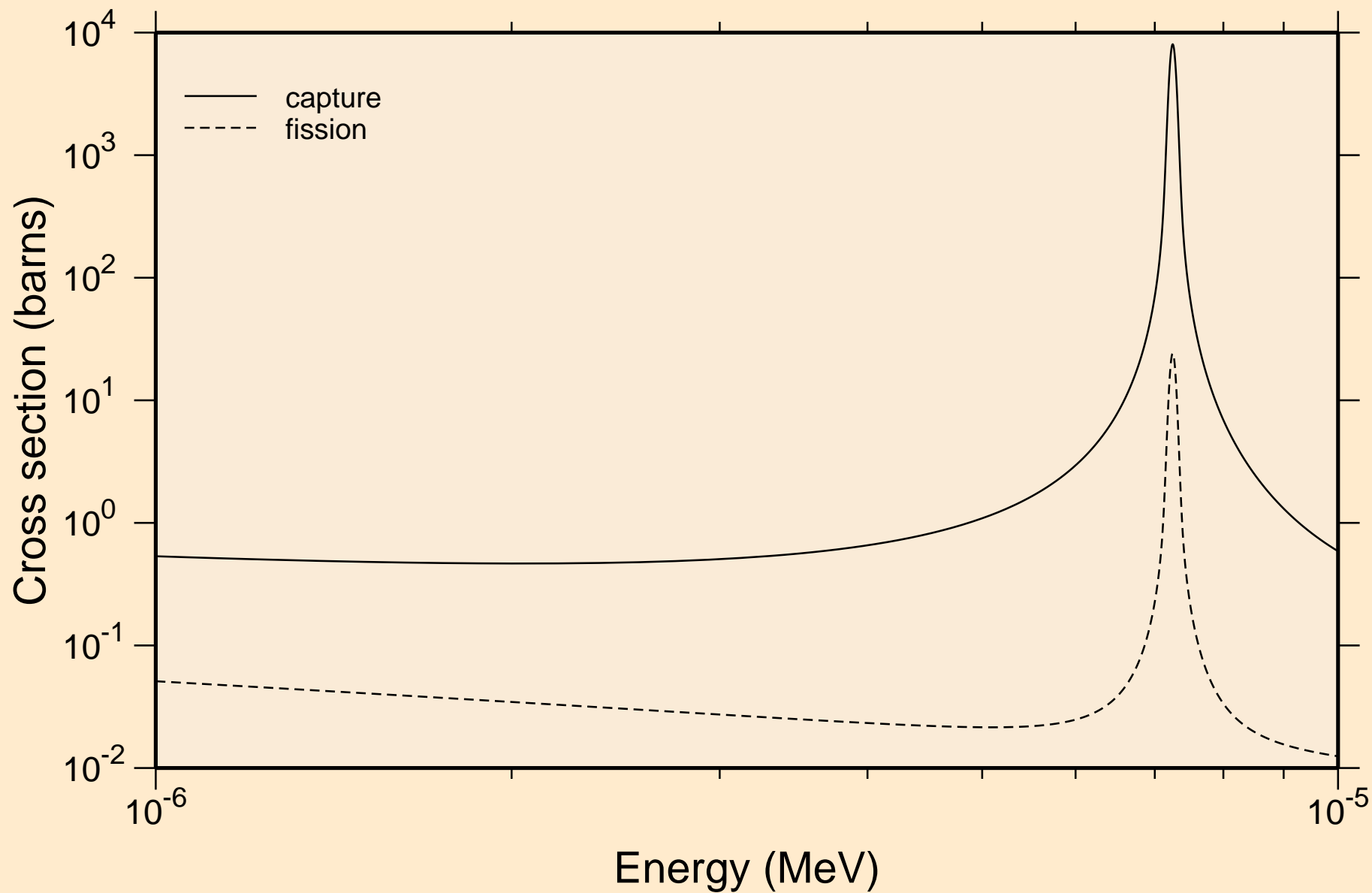

# ENDF/B-VII.1 CM-248

## resonance absorption cross sections

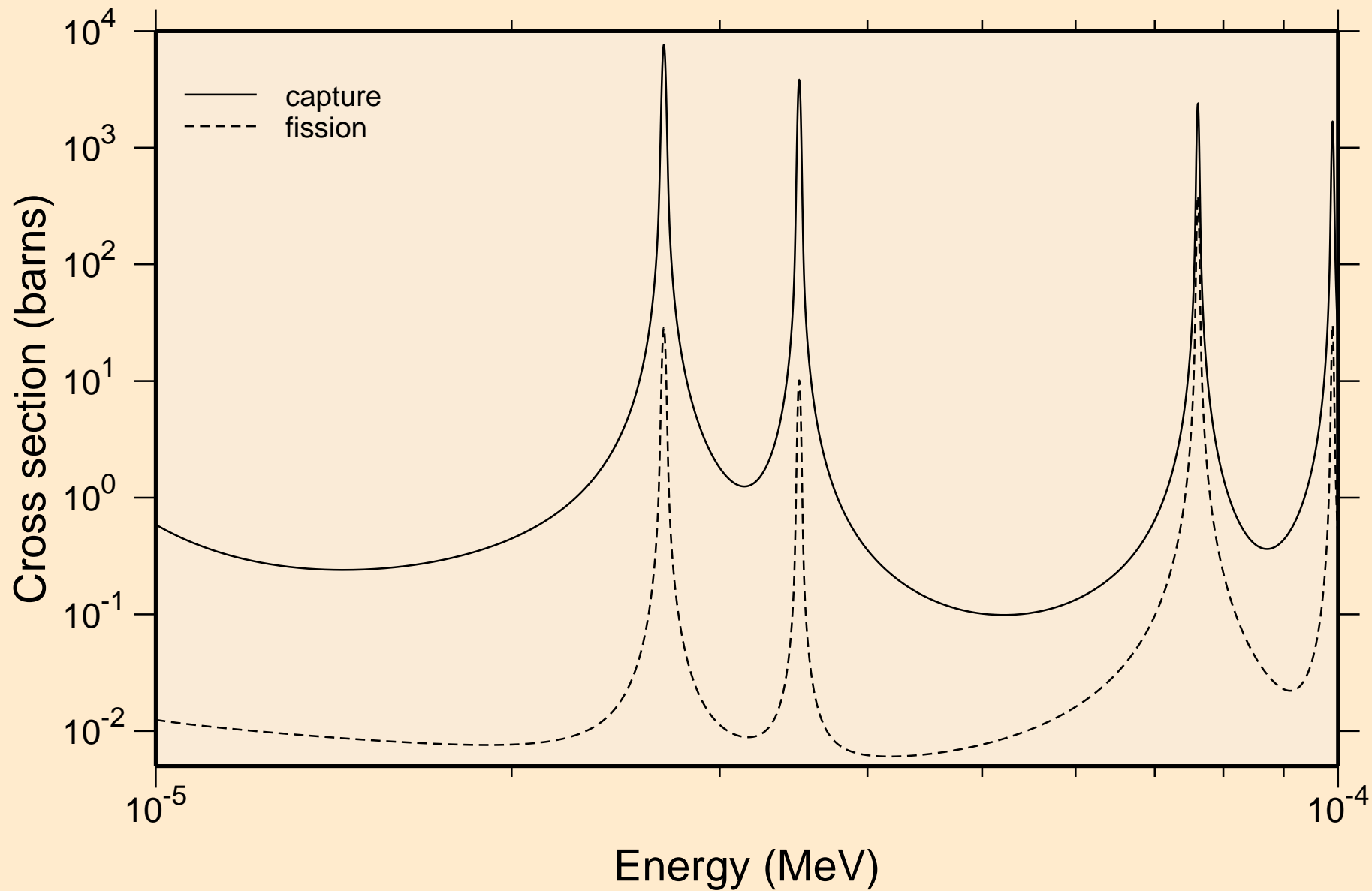



# ENDF/B-VII.1 CM-248 resonance absorption cross sections

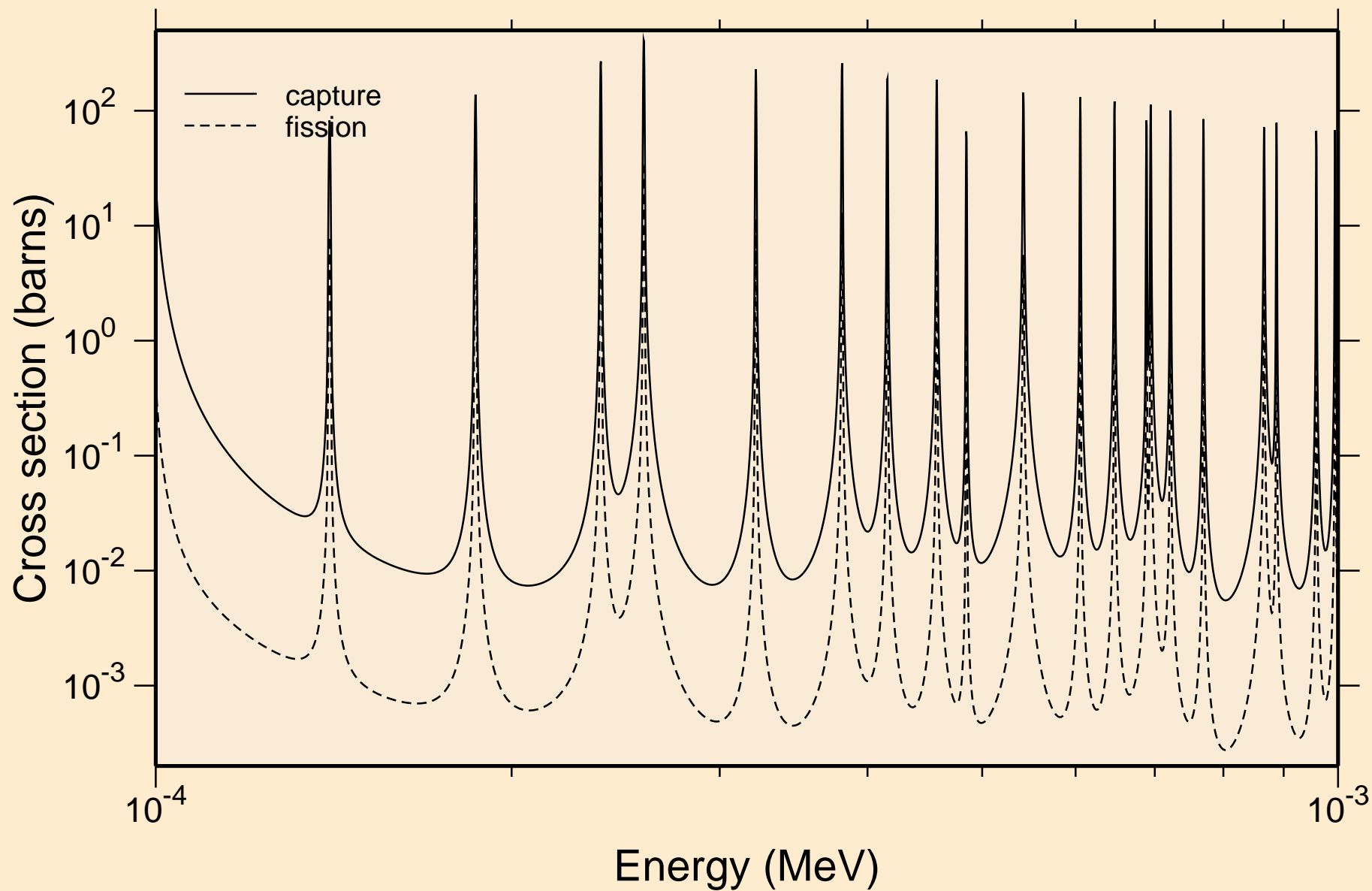

# ENDF/B-VII.1 CM-248 resonance absorption cross sections

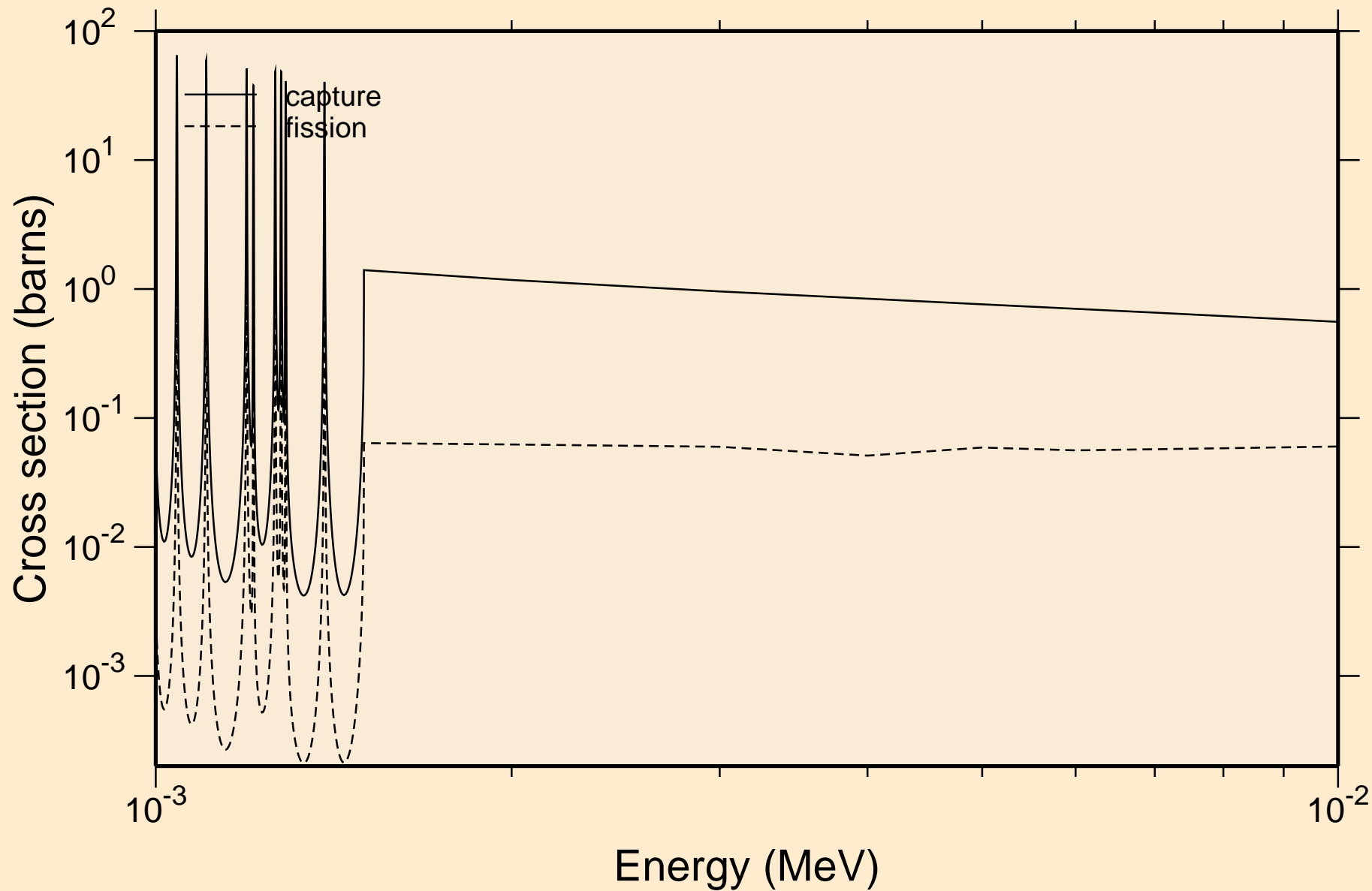

ENDF/B-VII.1 CM-248  
resonance absorption cross sections

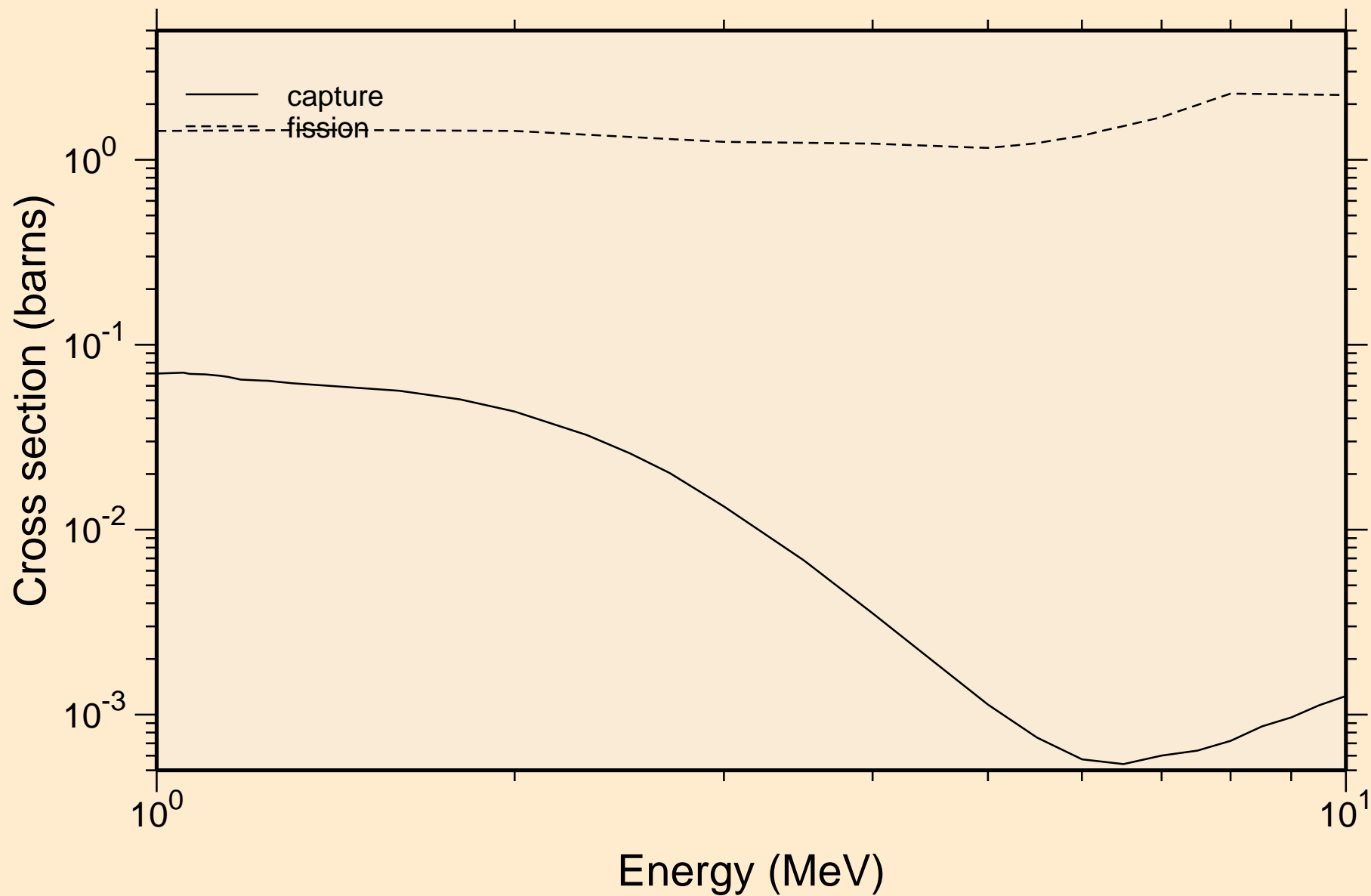

# ENDF/B-VII.1 CM-248

## UR total cross section

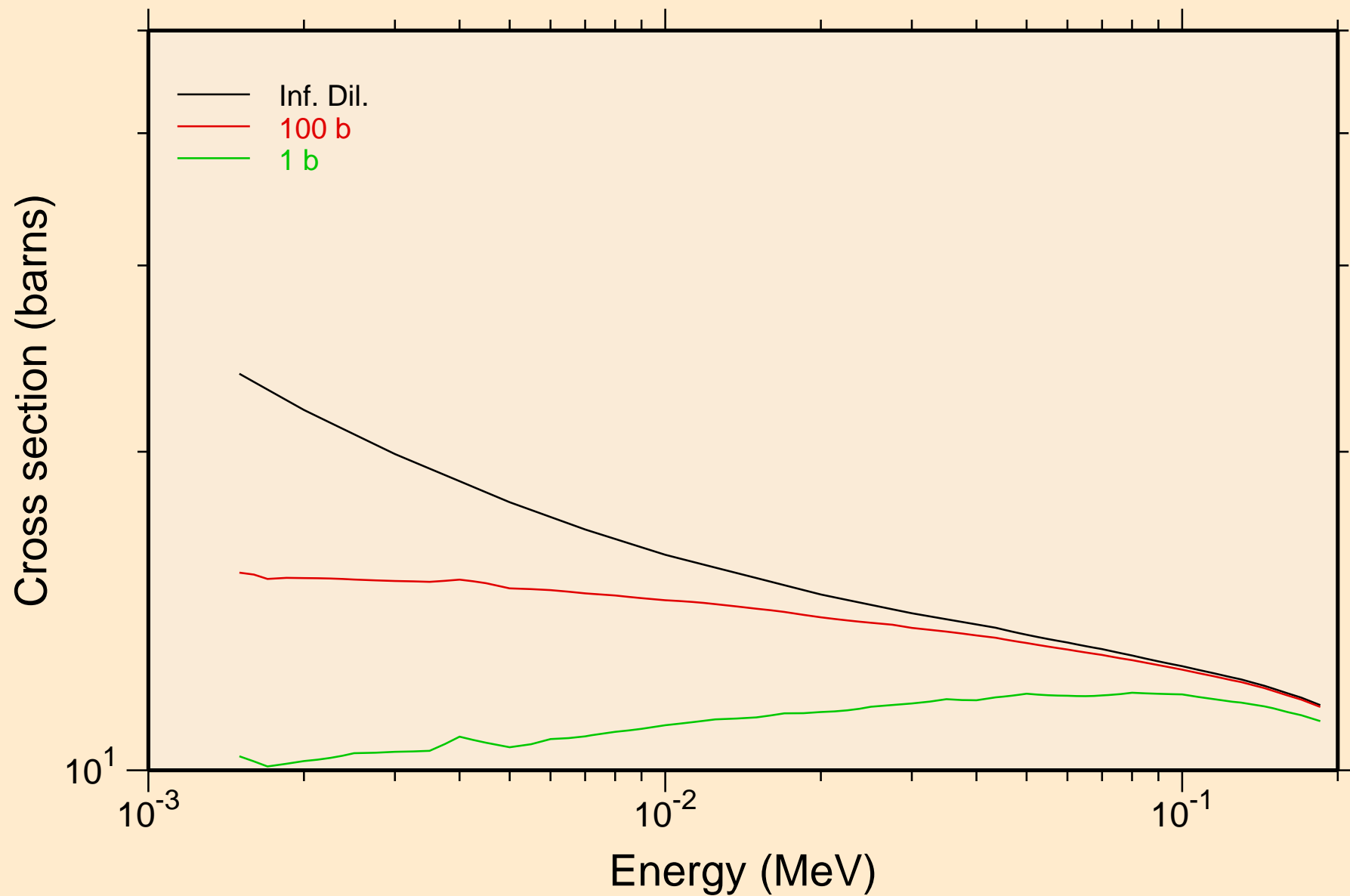

ENDF/B-VII.1 CM-248  
UR elastic cross section

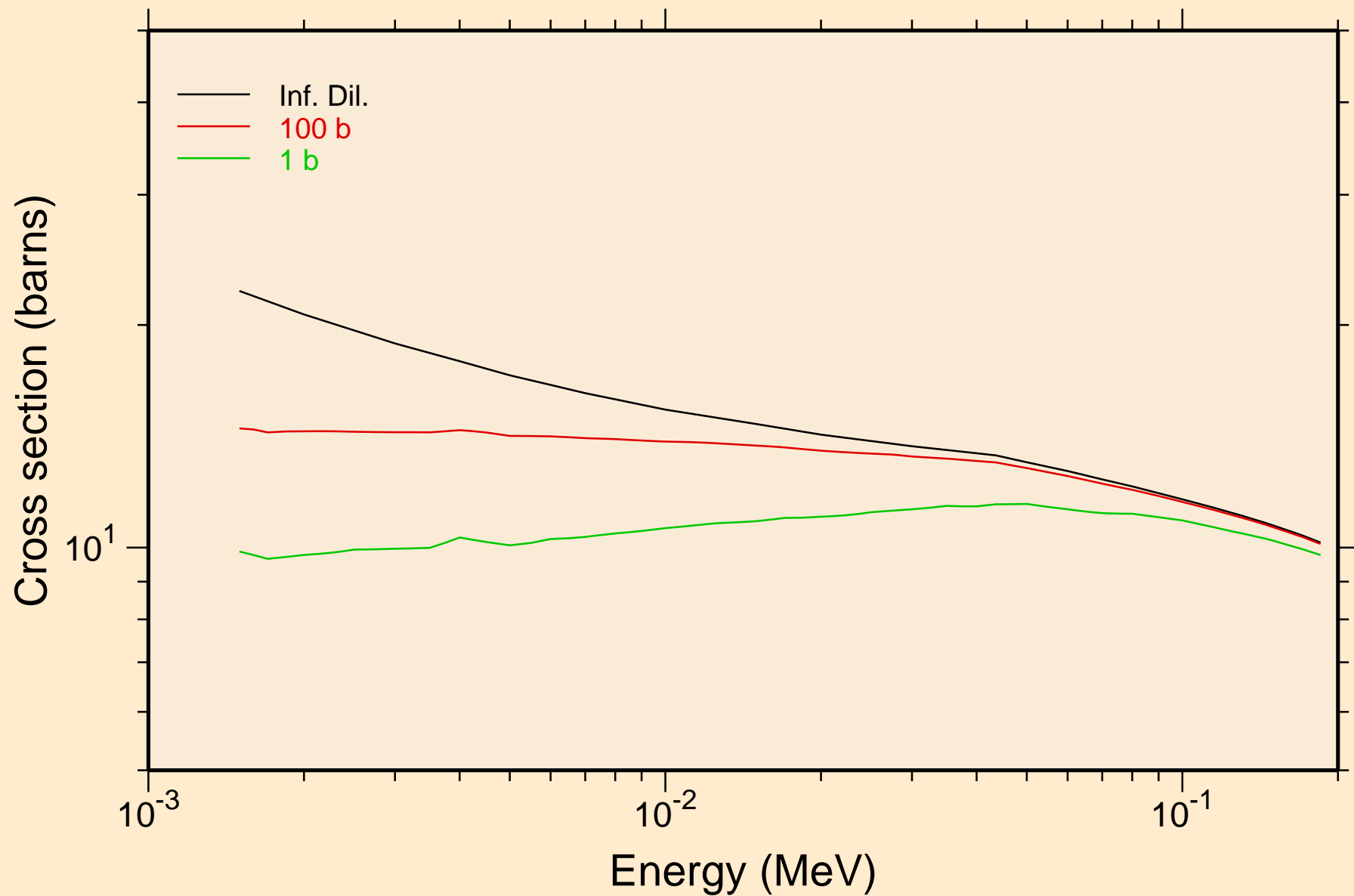

ENDF/B-VII.1 CM-248  
UR fission cross section

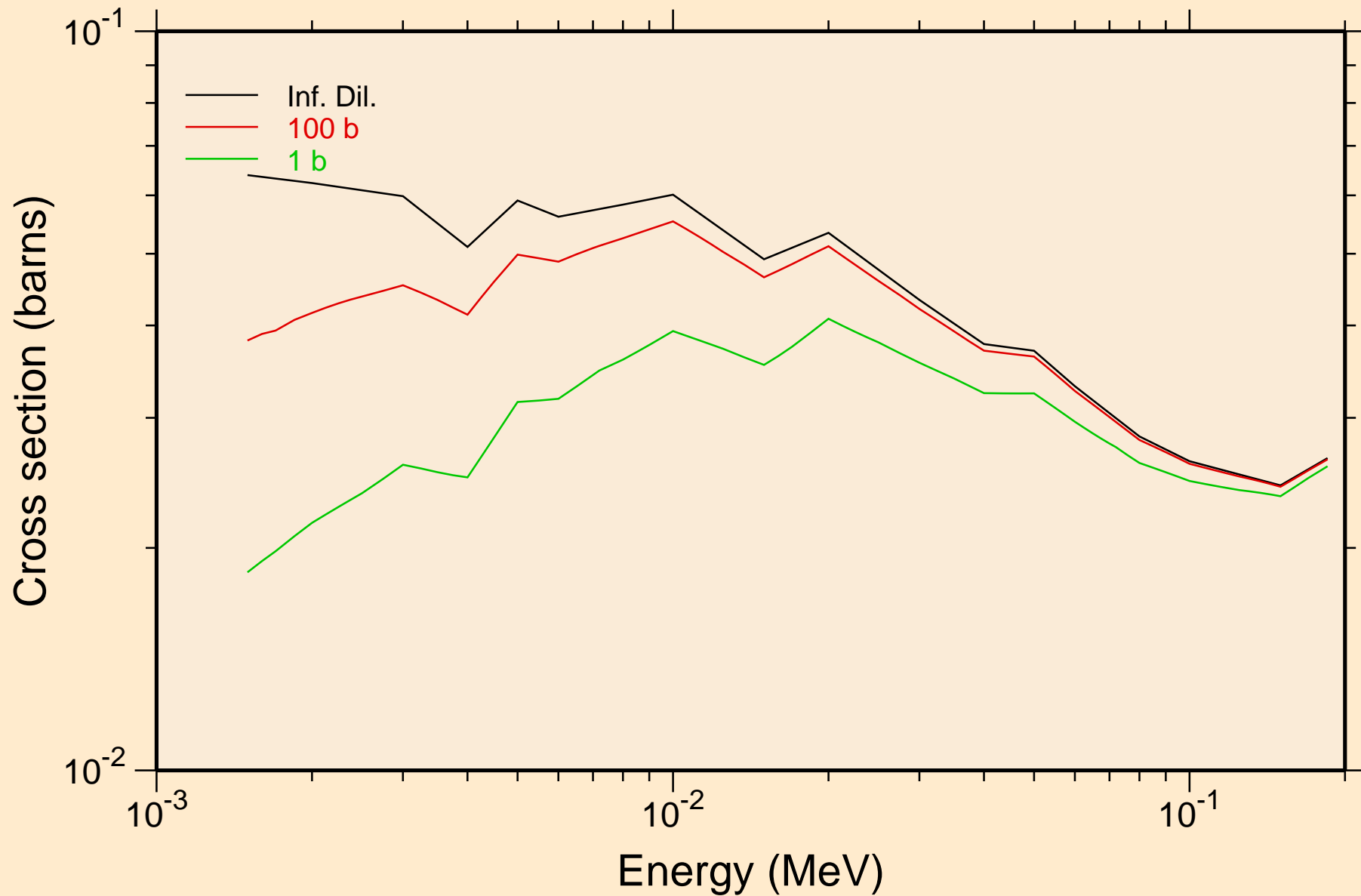

ENDF/B-VII.1 CM-248  
UR capture cross section

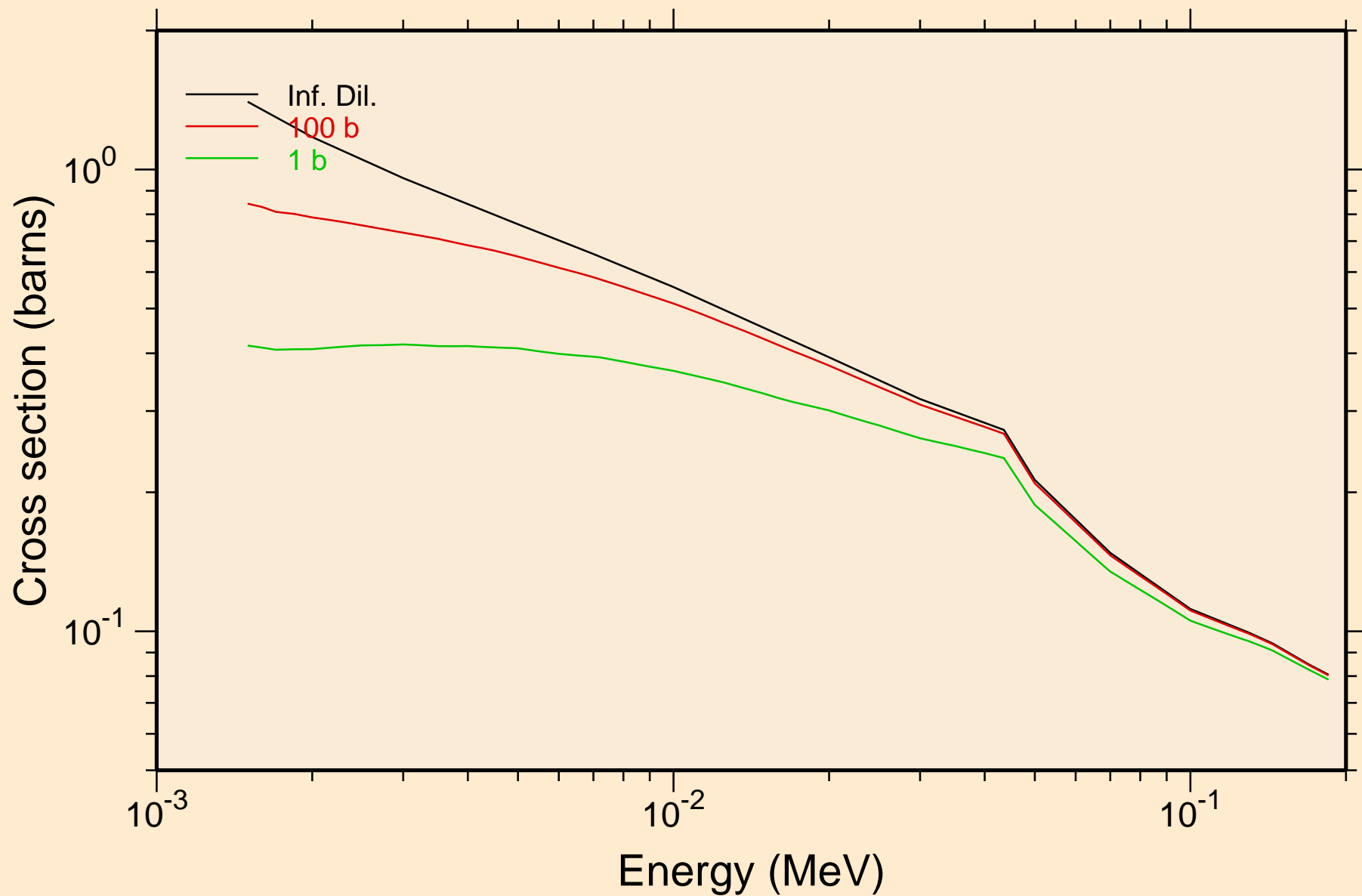

# ENDF/B-VII.1 CM-248

## Heating

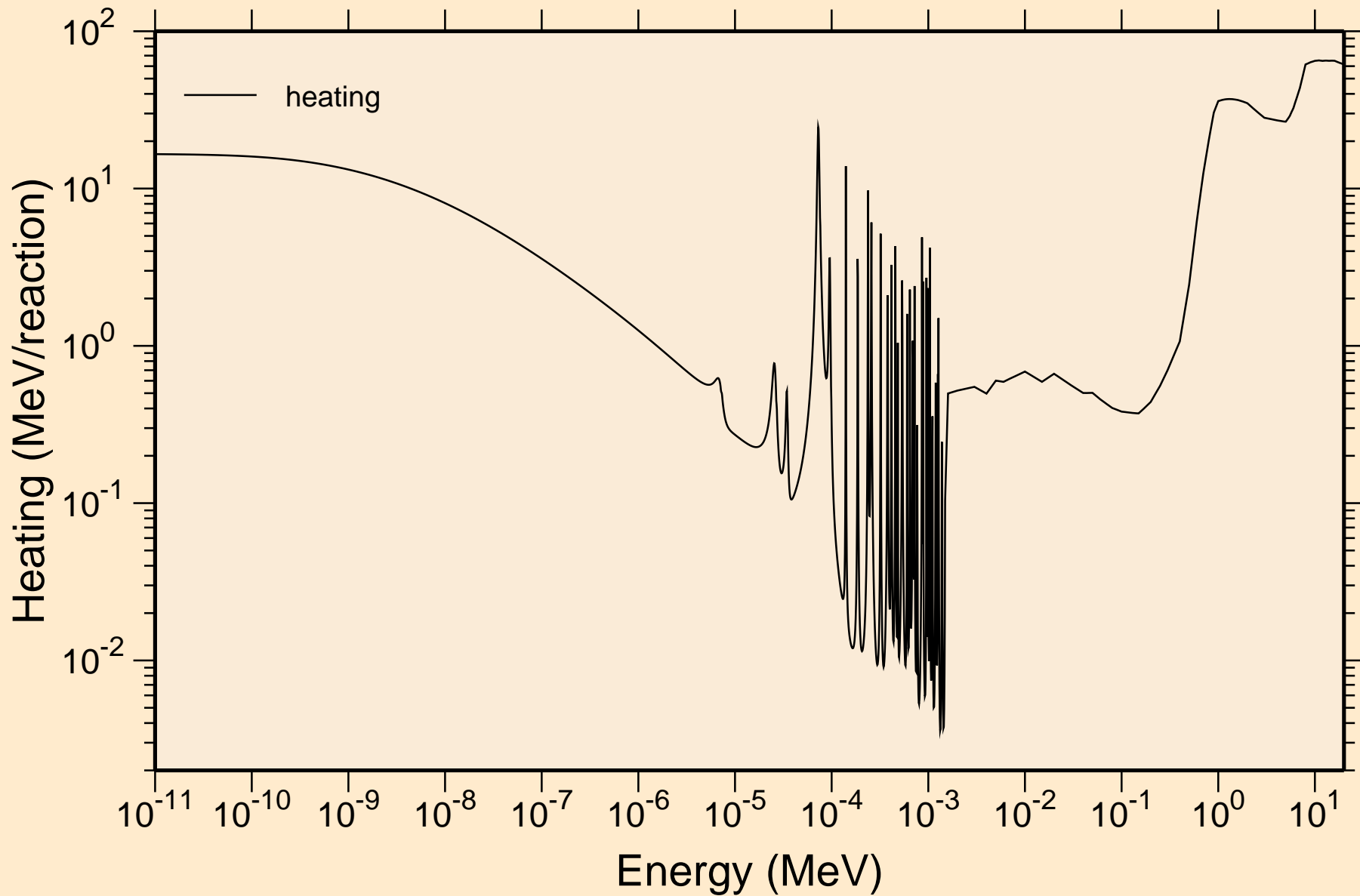



# ENDF/B-VII.1 CM-248

## Damage

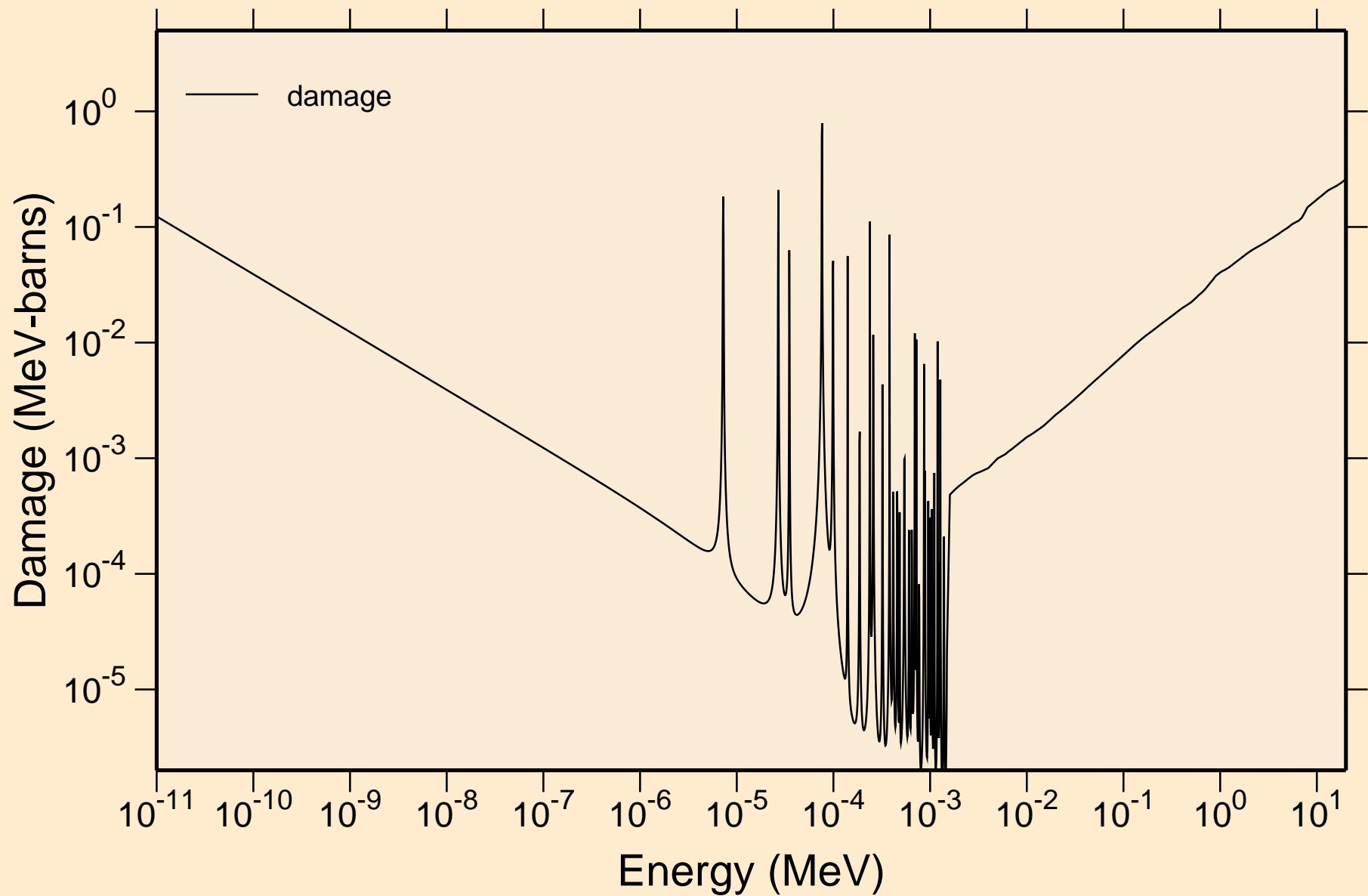

# ENDF/B-VII.1 CM-248

## Non-threshold reactions

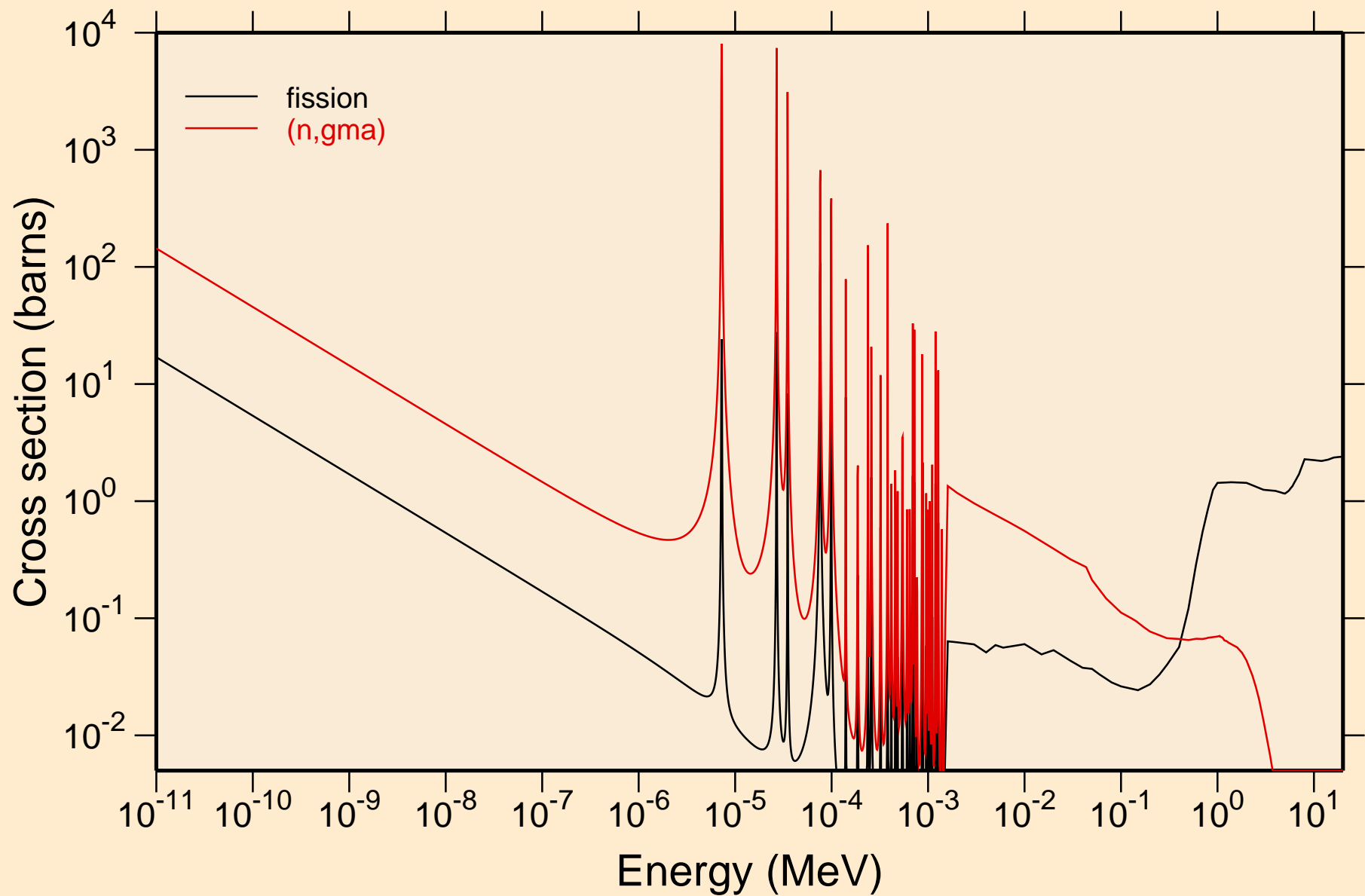

# ENDF/B-VII.1 CM-248

## Principal cross sections

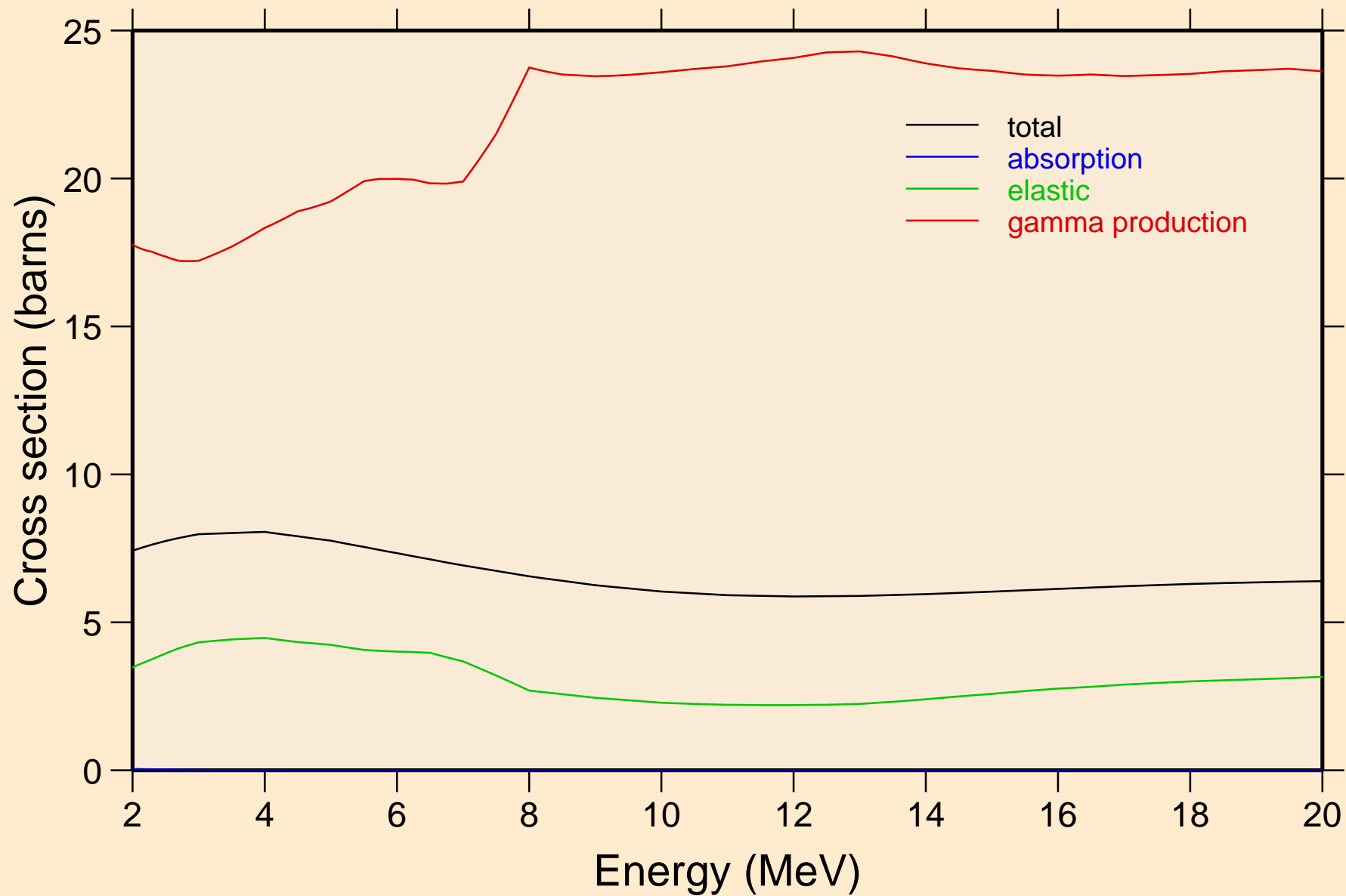

# ENDF/B-VII.1 CM-248

## Heating

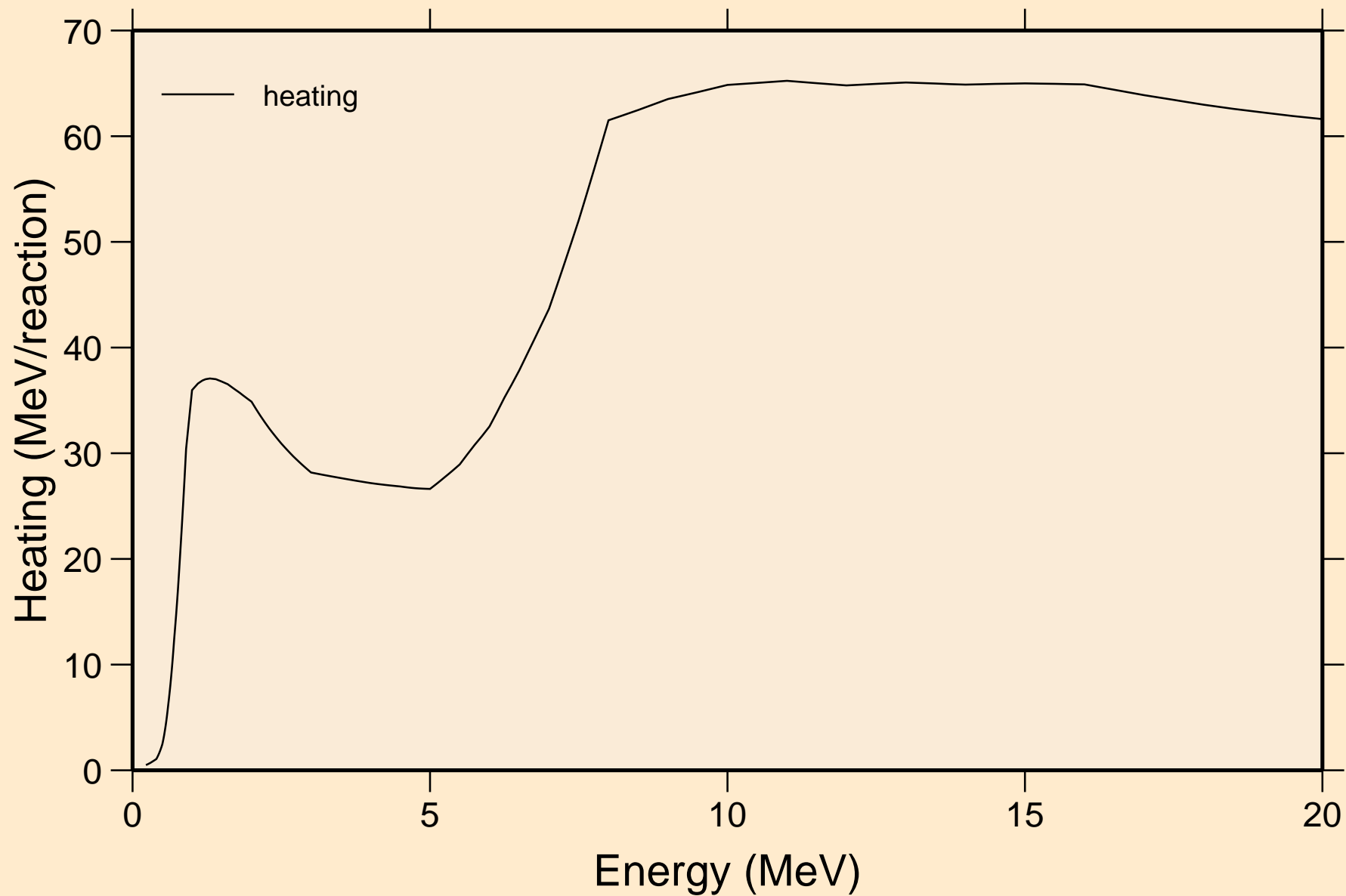

# ENDF/B-VII.1 CM-248

## Damage

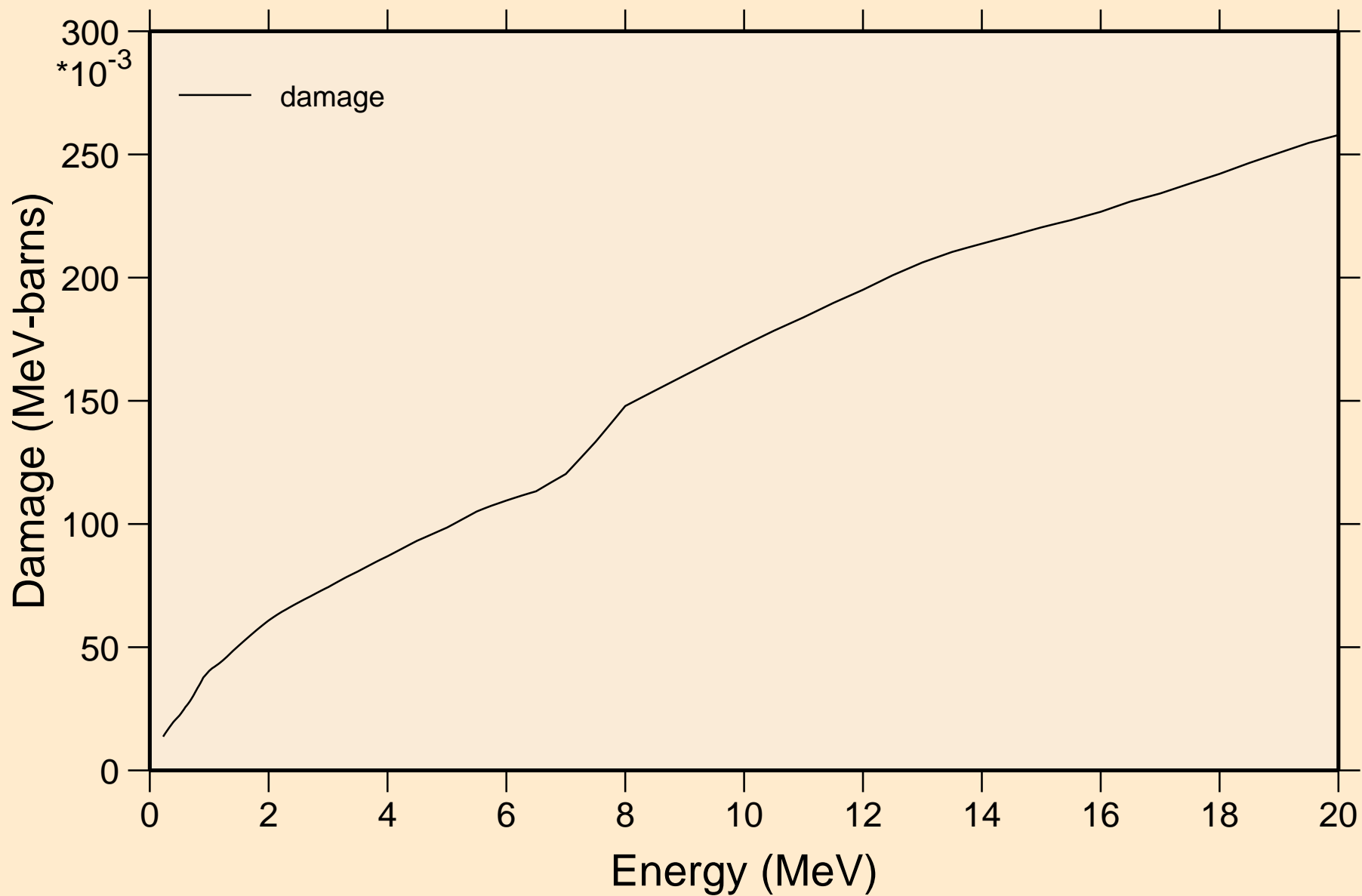

# ENDF/B-VII.1 CM-248

## Non-threshold reactions

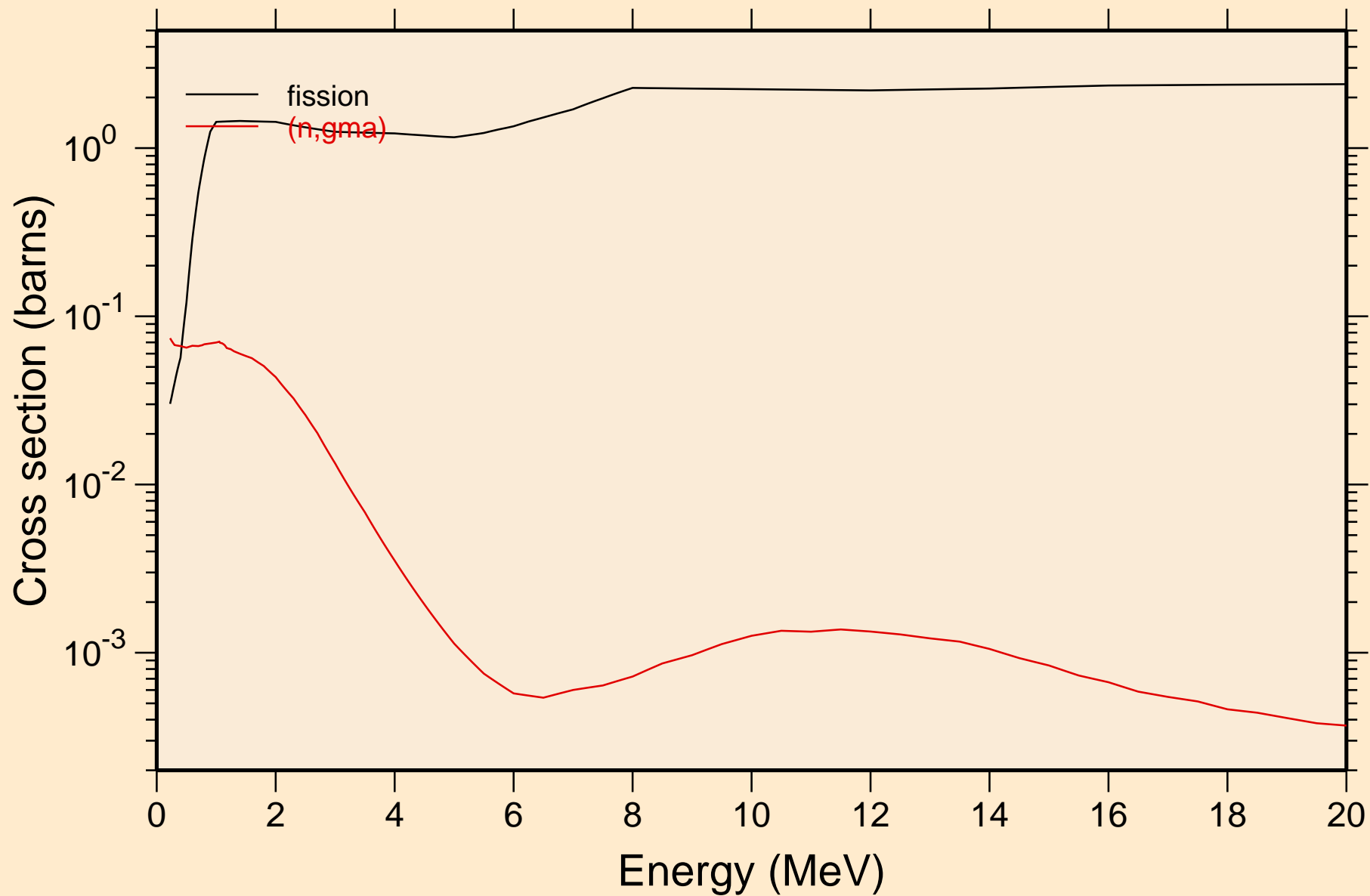

# ENDF/B-VII.1 CM-248

## Inelastic levels

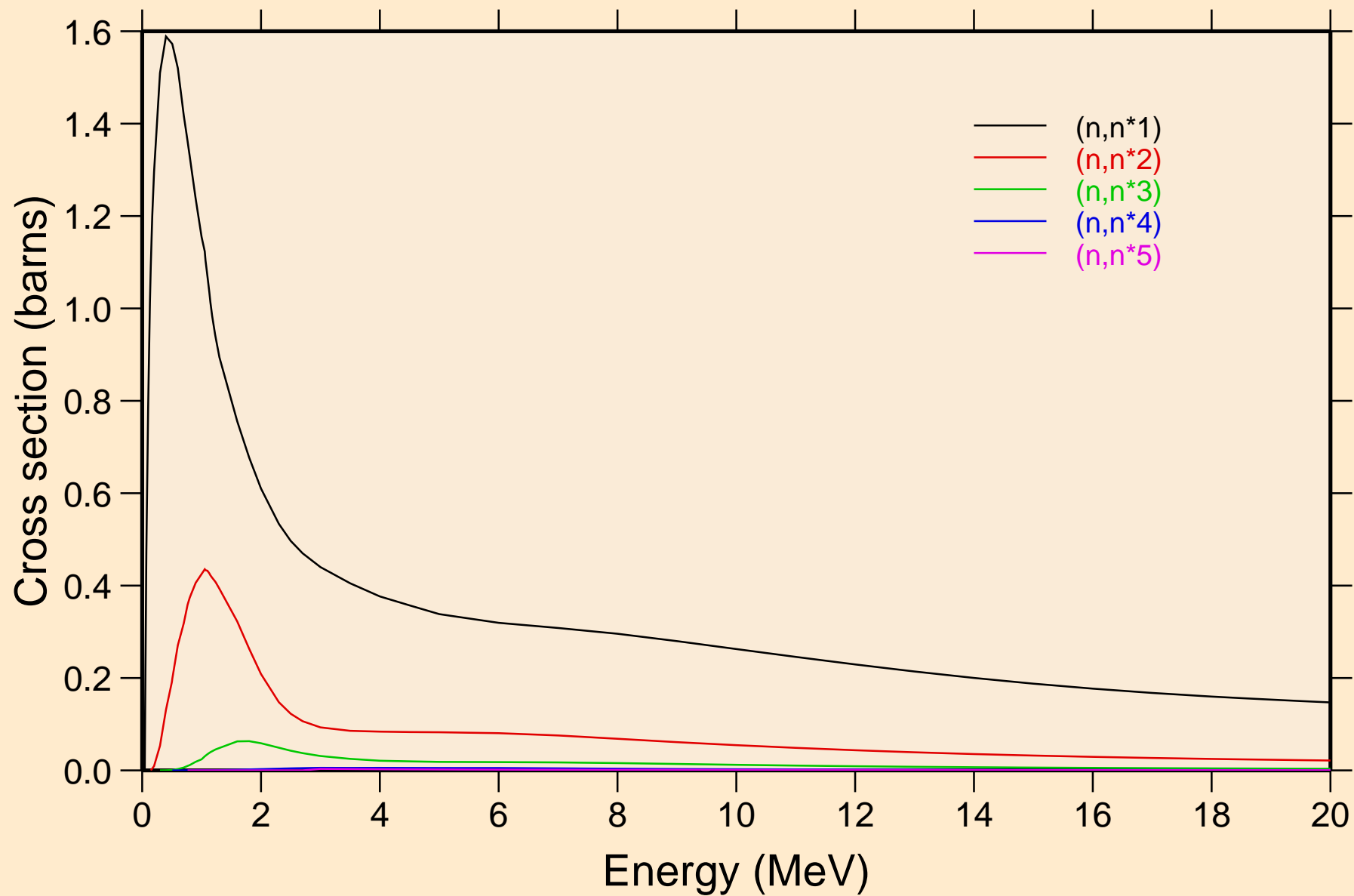

# ENDF/B-VII.1 CM-248

## Inelastic levels

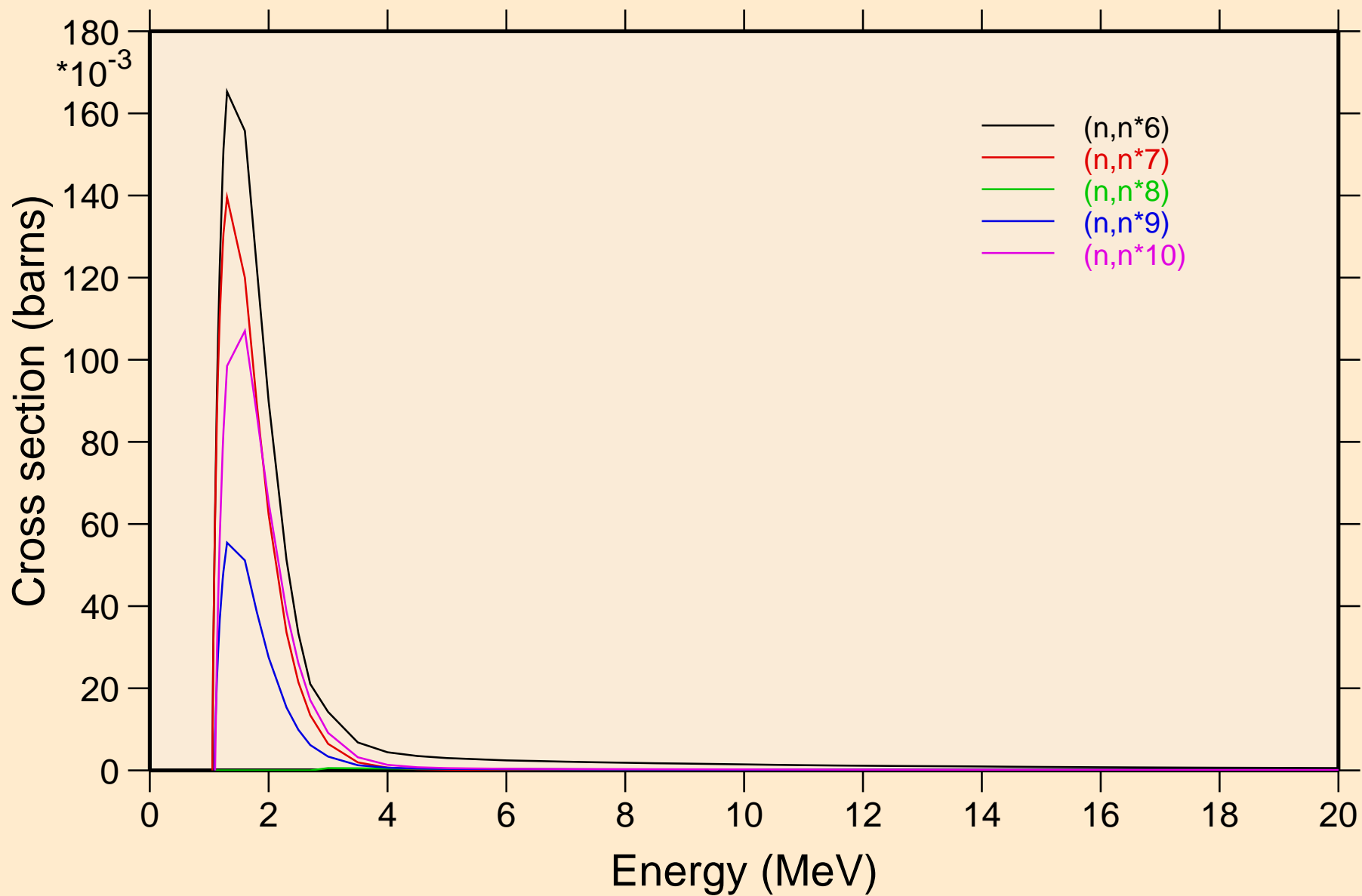



# ENDF/B-VII.1 CM-248

## Inelastic levels

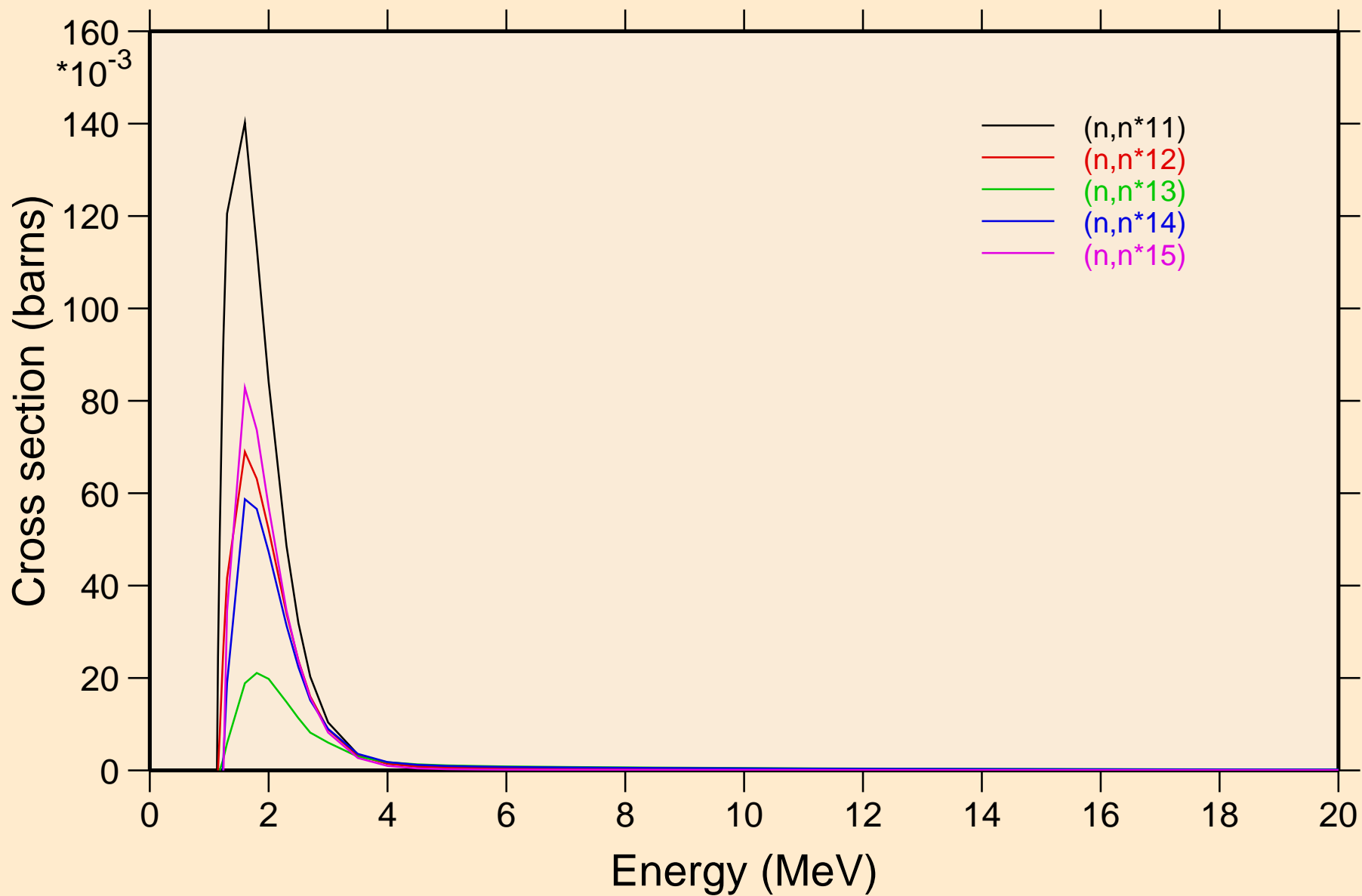

# ENDF/B-VII.1 CM-248

## Threshold reactions

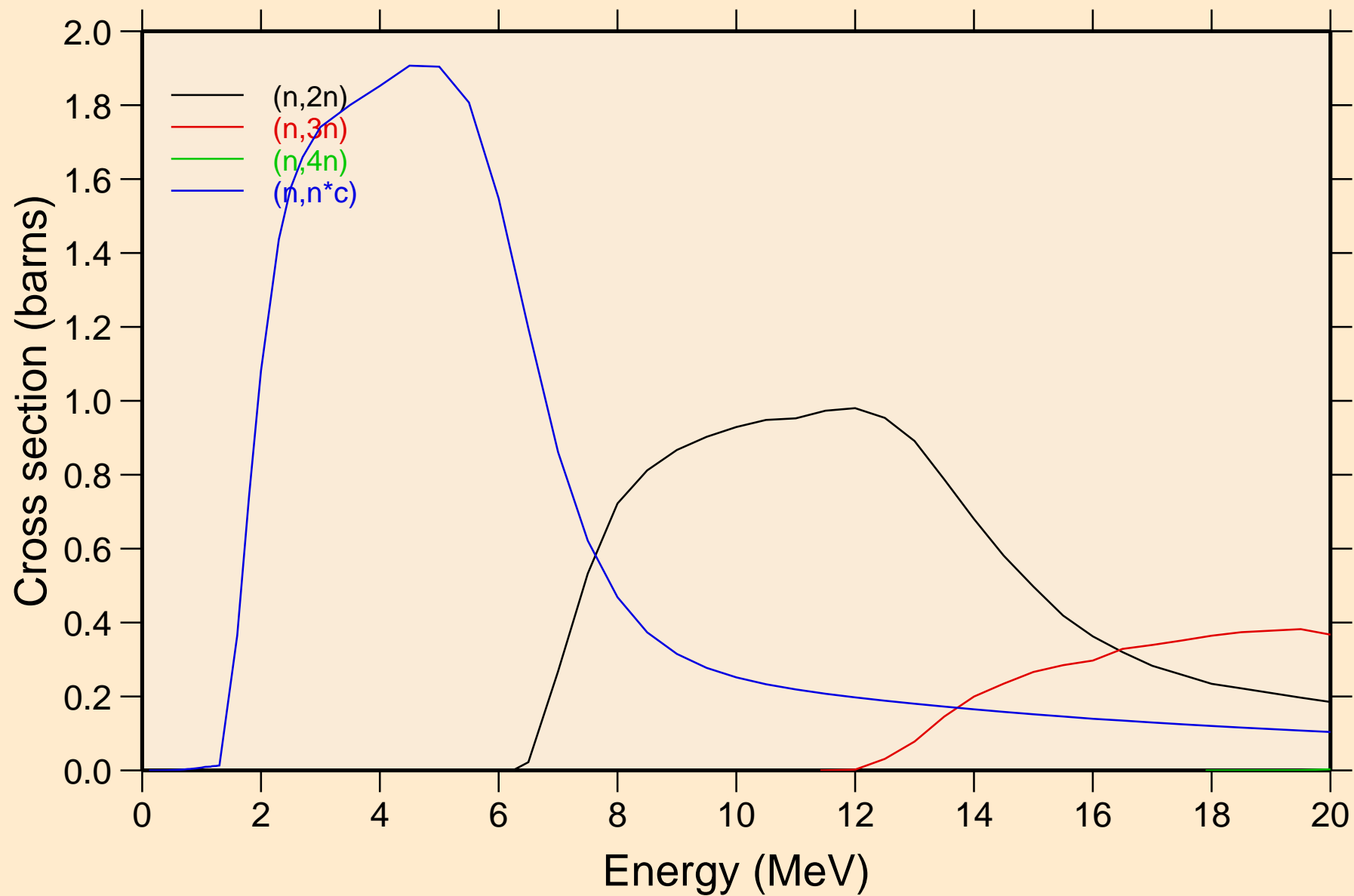

ENDF/B-VII.1 CM-248  
angular distribution for elastic

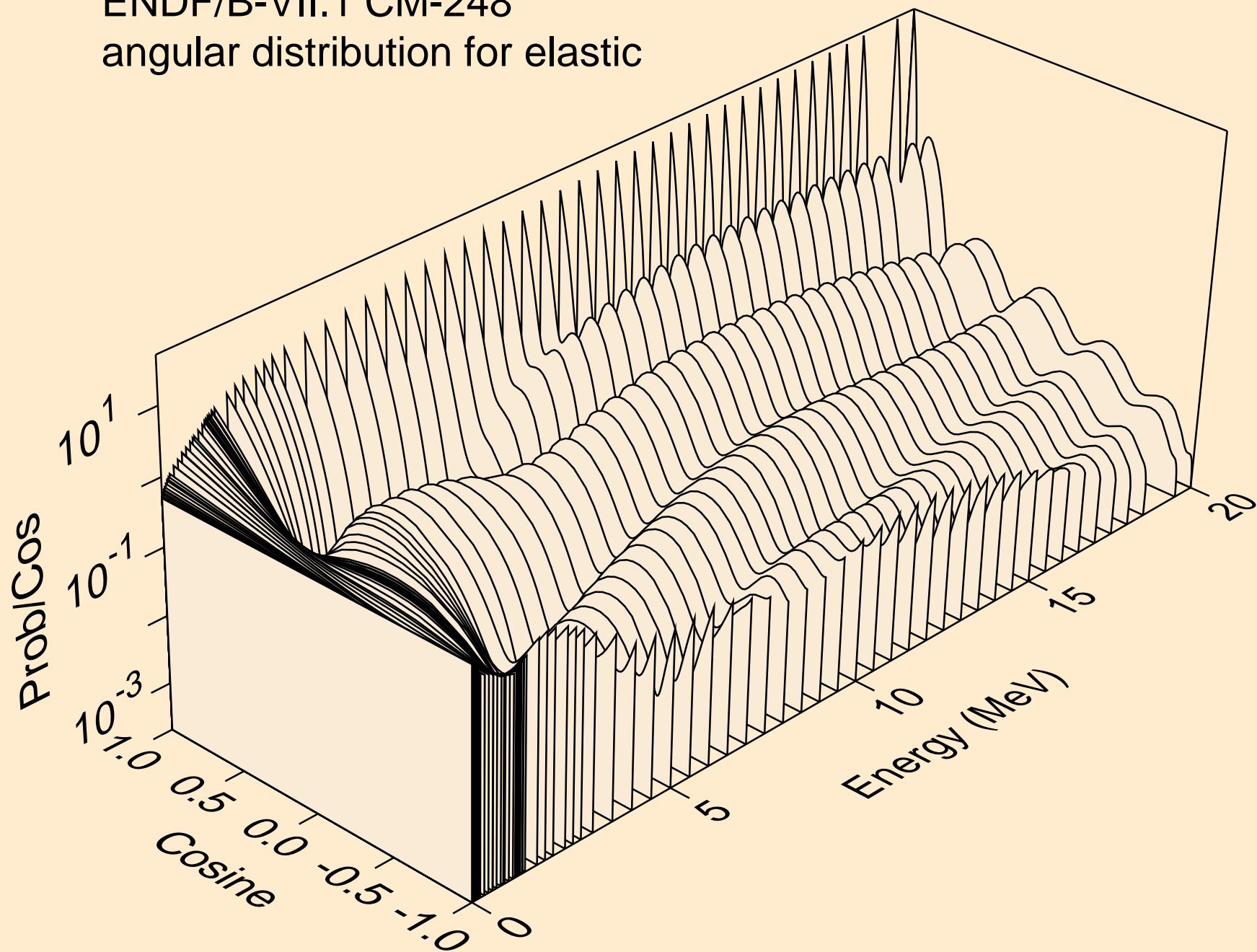

ENDF/B-VII.1 CM-248  
angular distribution for (n,n\*1)

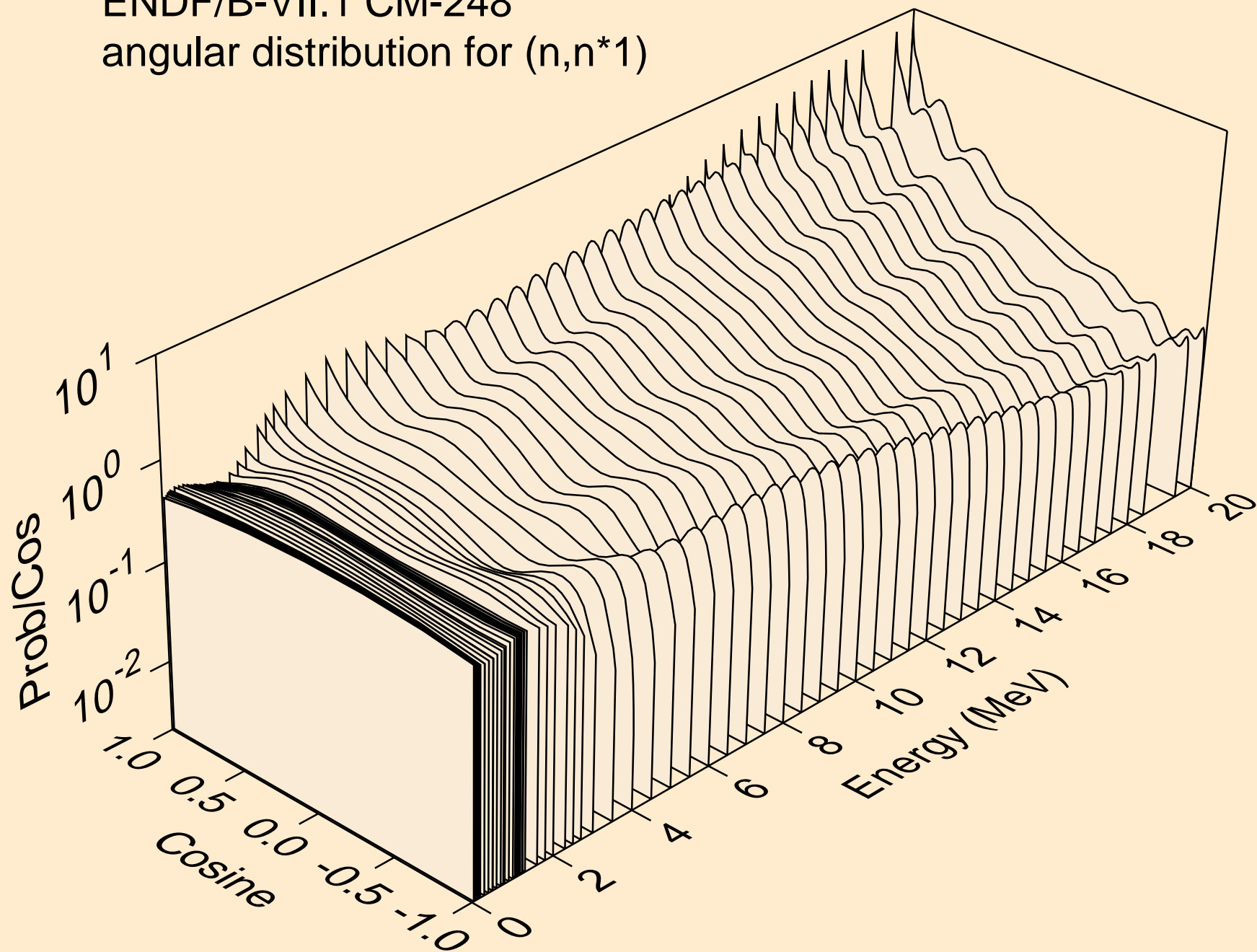

ENDF/B-VII.1 CM-248  
angular distribution for (n,n\*2)

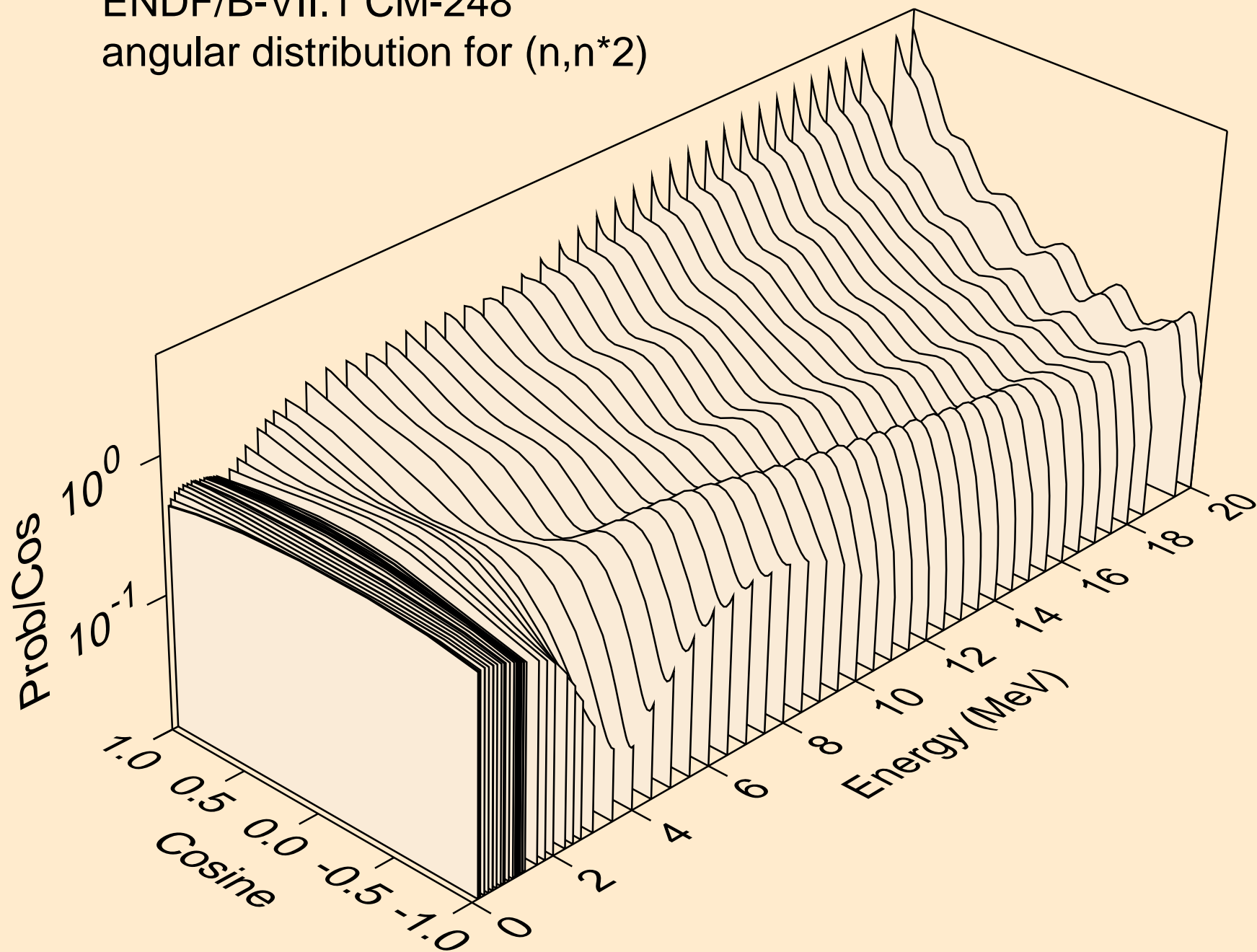

ENDF/B-VII.1 CM-248  
angular distribution for (n,n\*3)

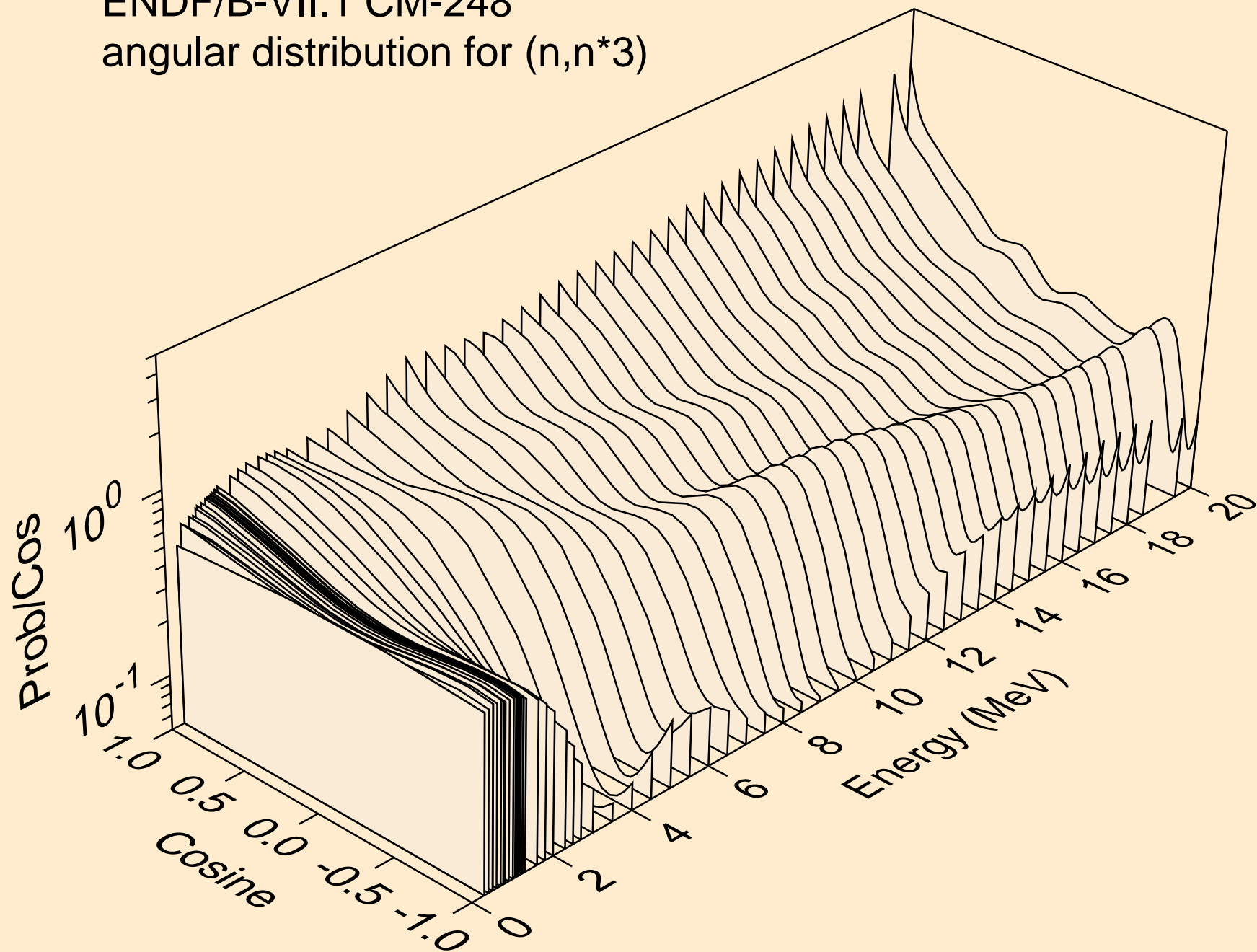

ENDF/B-VII.1 CM-248  
angular distribution for (n,n\*4)

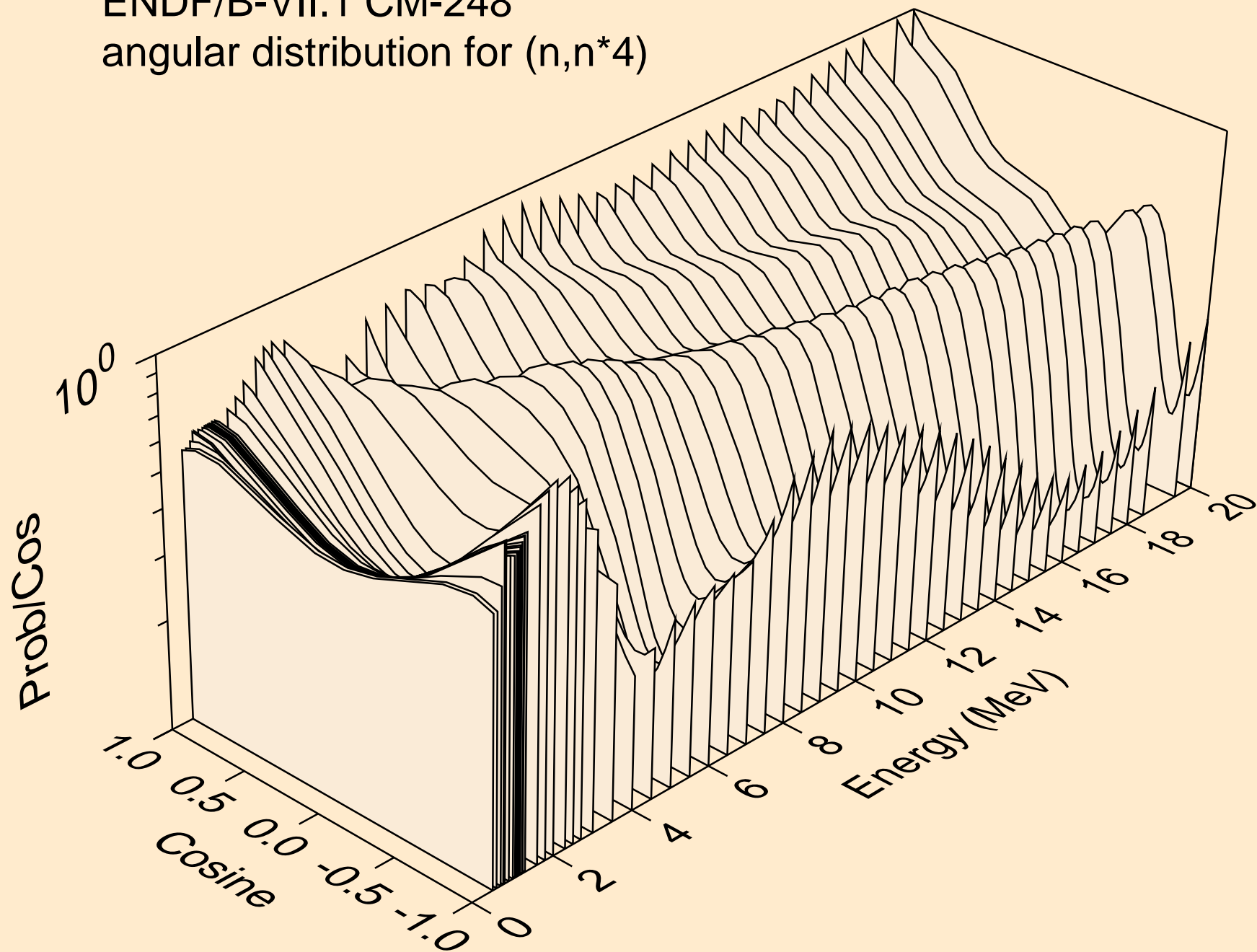

ENDF/B-VII.1 CM-248  
angular distribution for (n,n\*5)

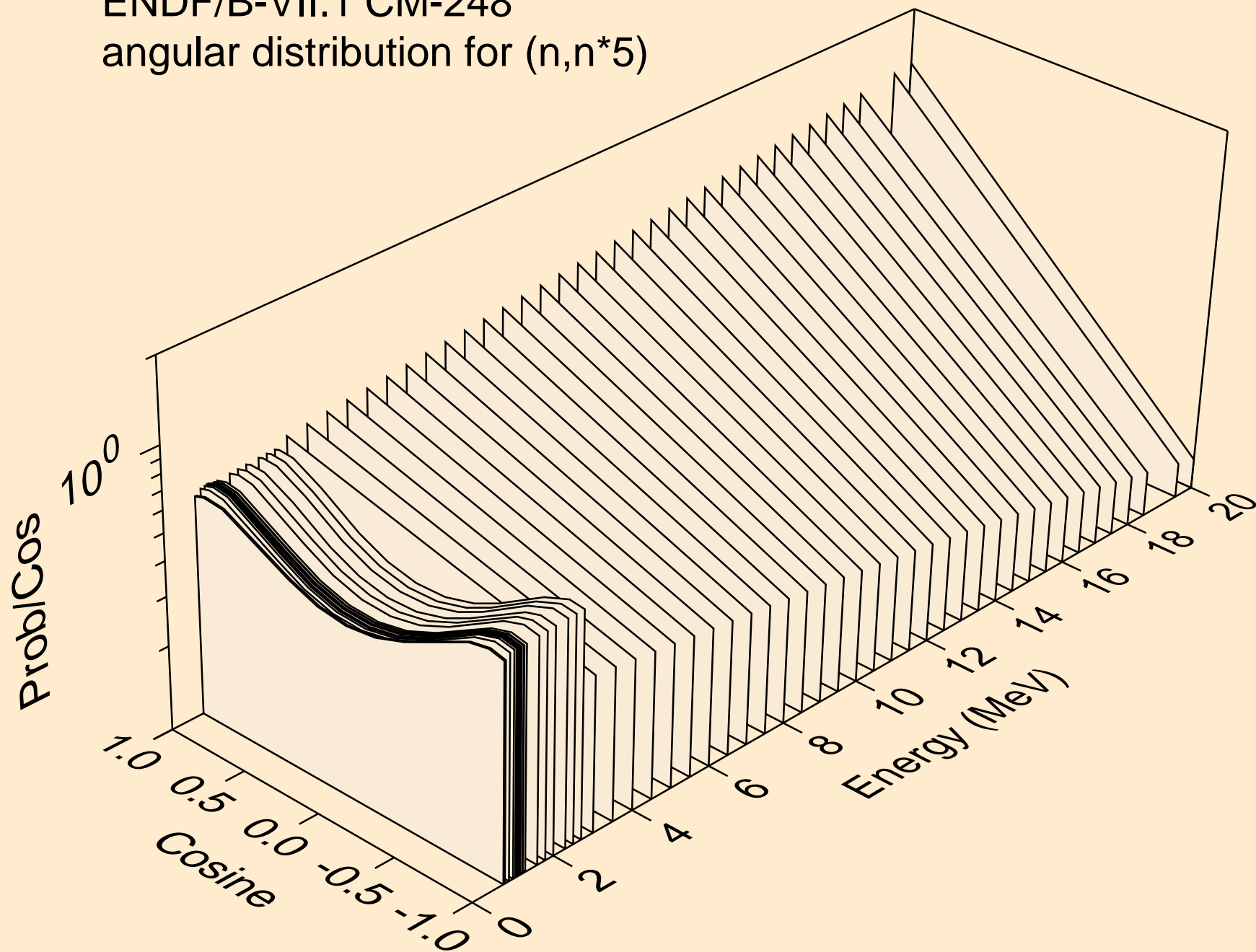



ENDF/B-VII.1 CM-248  
angular distribution for (n,n\*6)

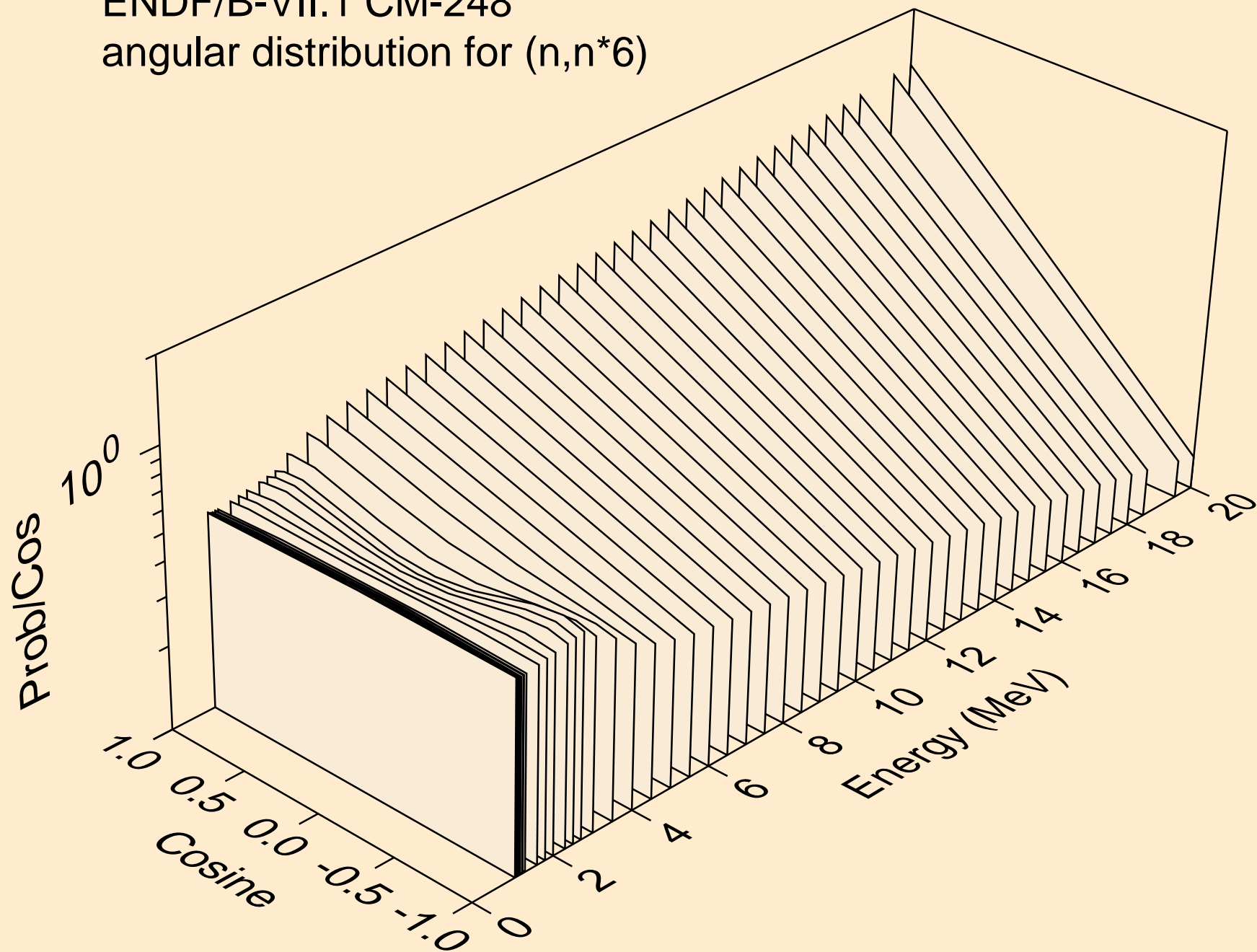

ENDF/B-VII.1 CM-248  
angular distribution for (n,n\*7)

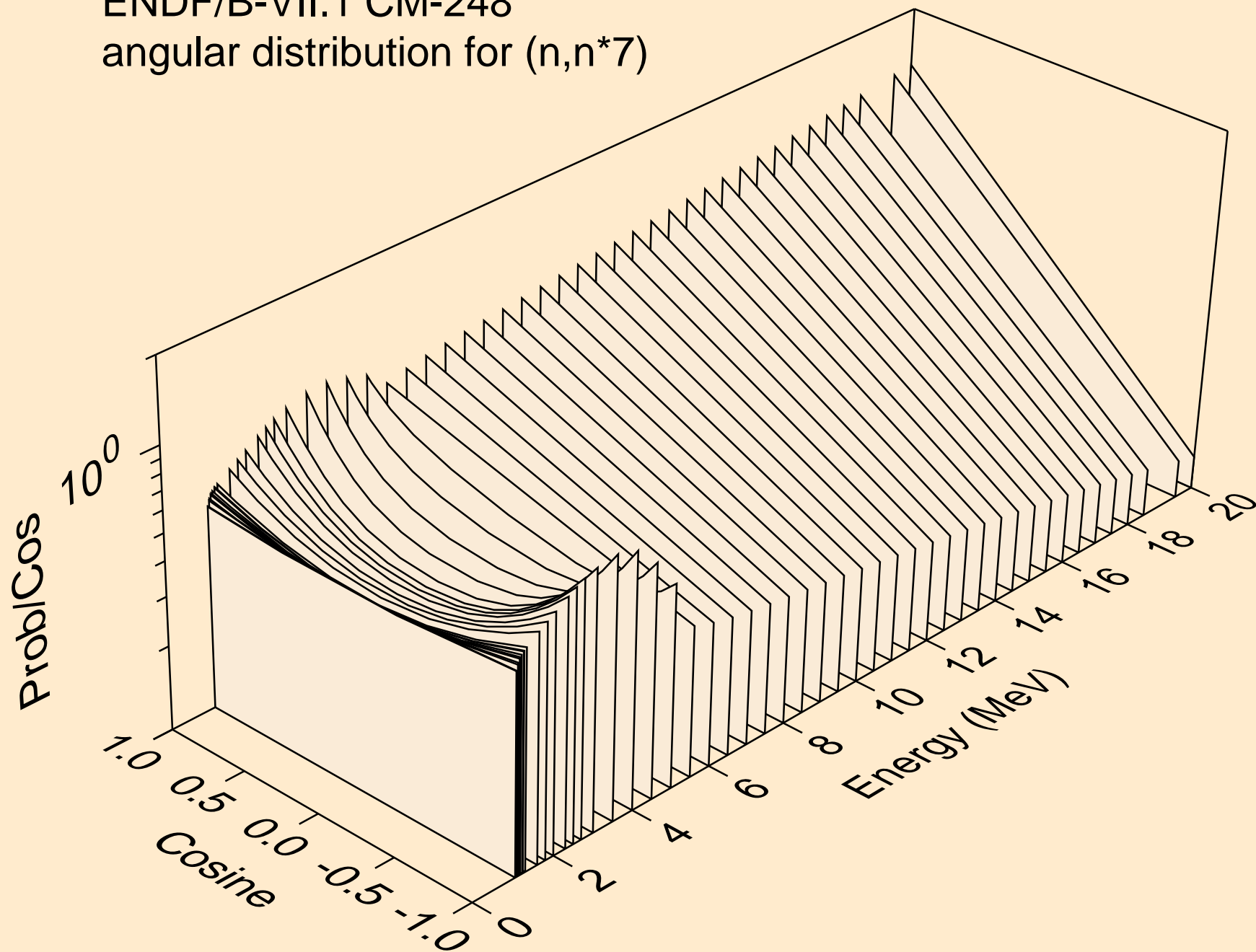

ENDF/B-VII.1 CM-248  
angular distribution for (n,n\*8)

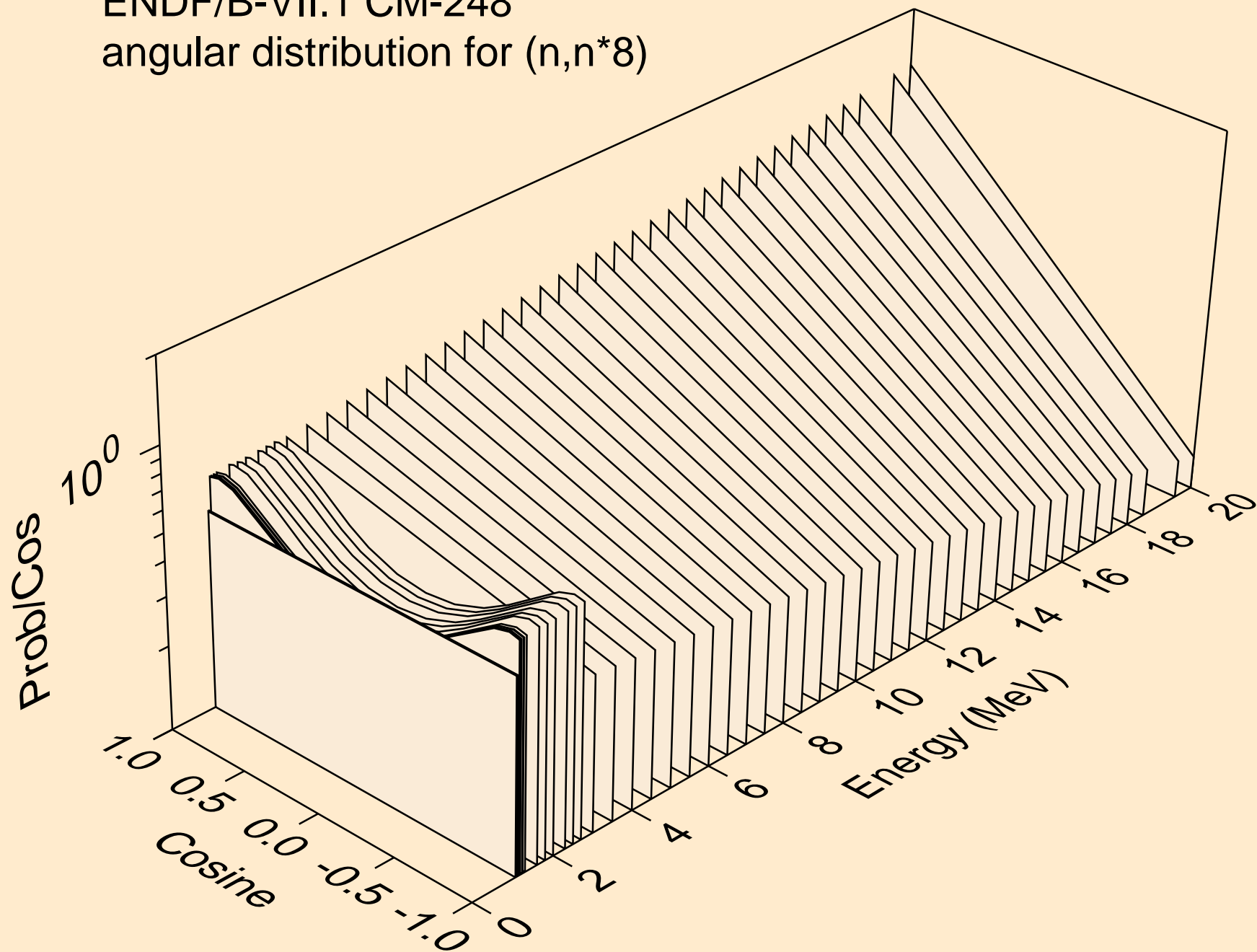

ENDF/B-VII.1 CM-248  
angular distribution for (n,n\*9)

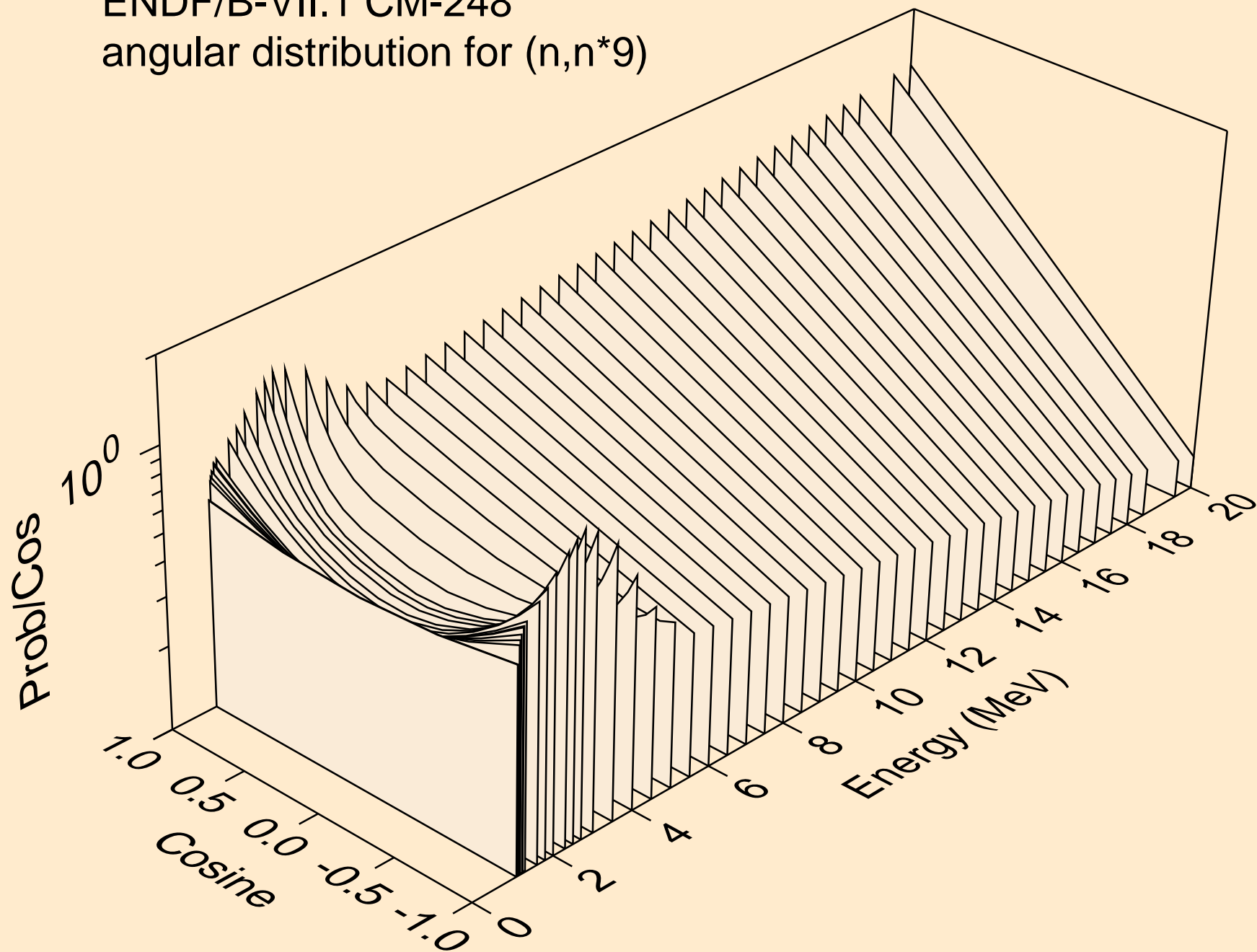

ENDF/B-VII.1 CM-248  
angular distribution for (n,n\*10)

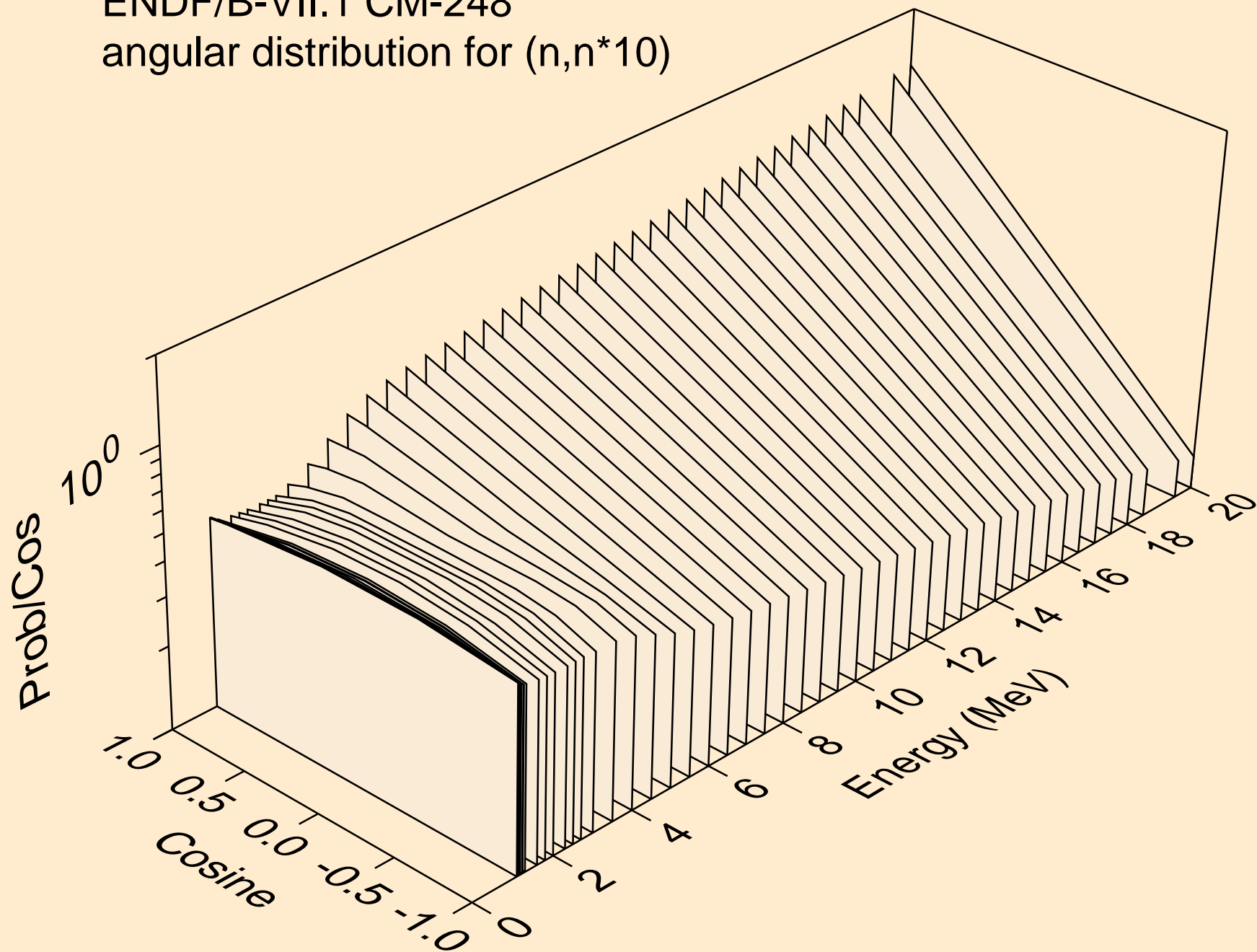

ENDF/B-VII.1 CM-248  
angular distribution for (n,n\*11)

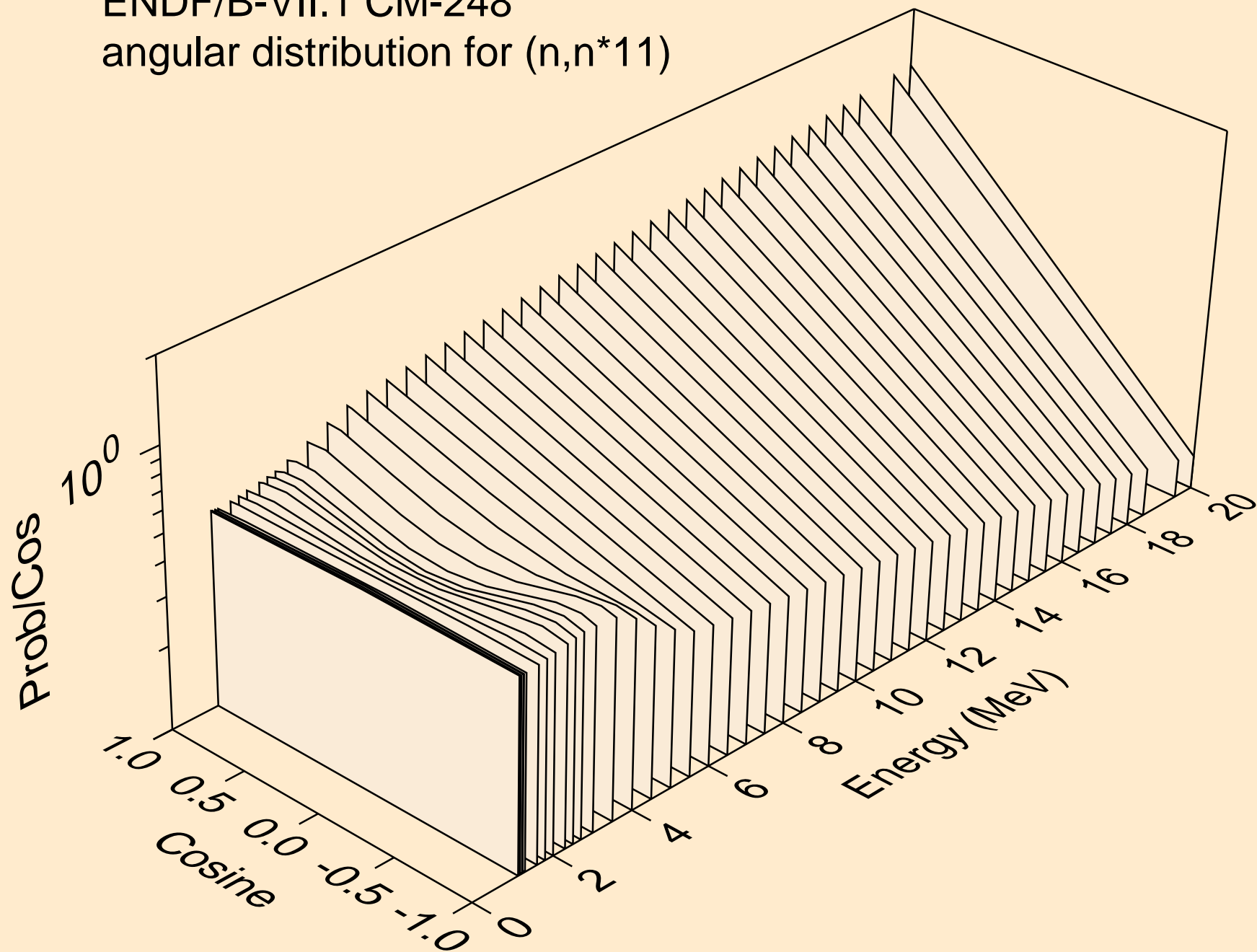

ENDF/B-VII.1 CM-248  
angular distribution for (n,n\*12)

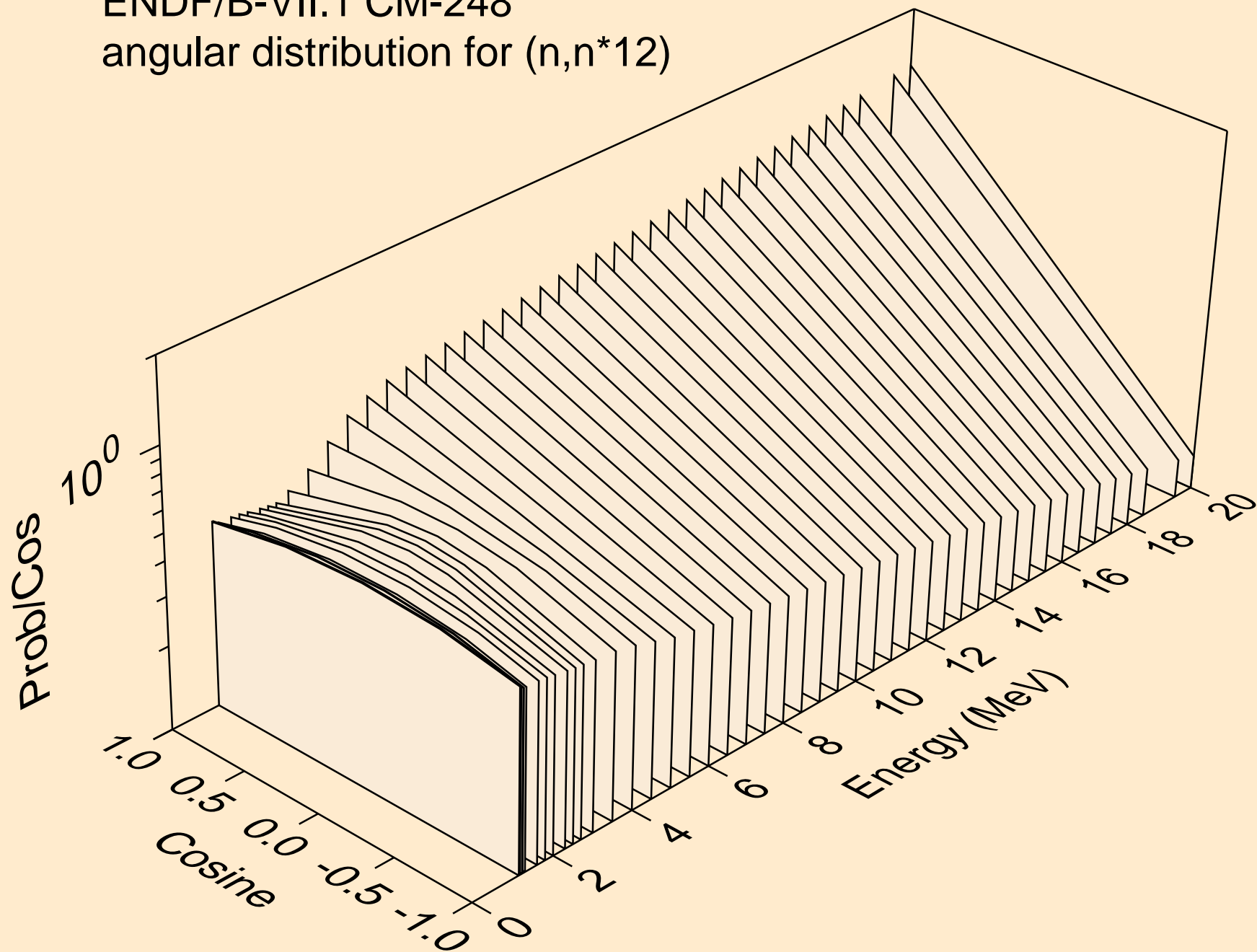



ENDF/B-VII.1 CM-248  
angular distribution for (n,n\*13)

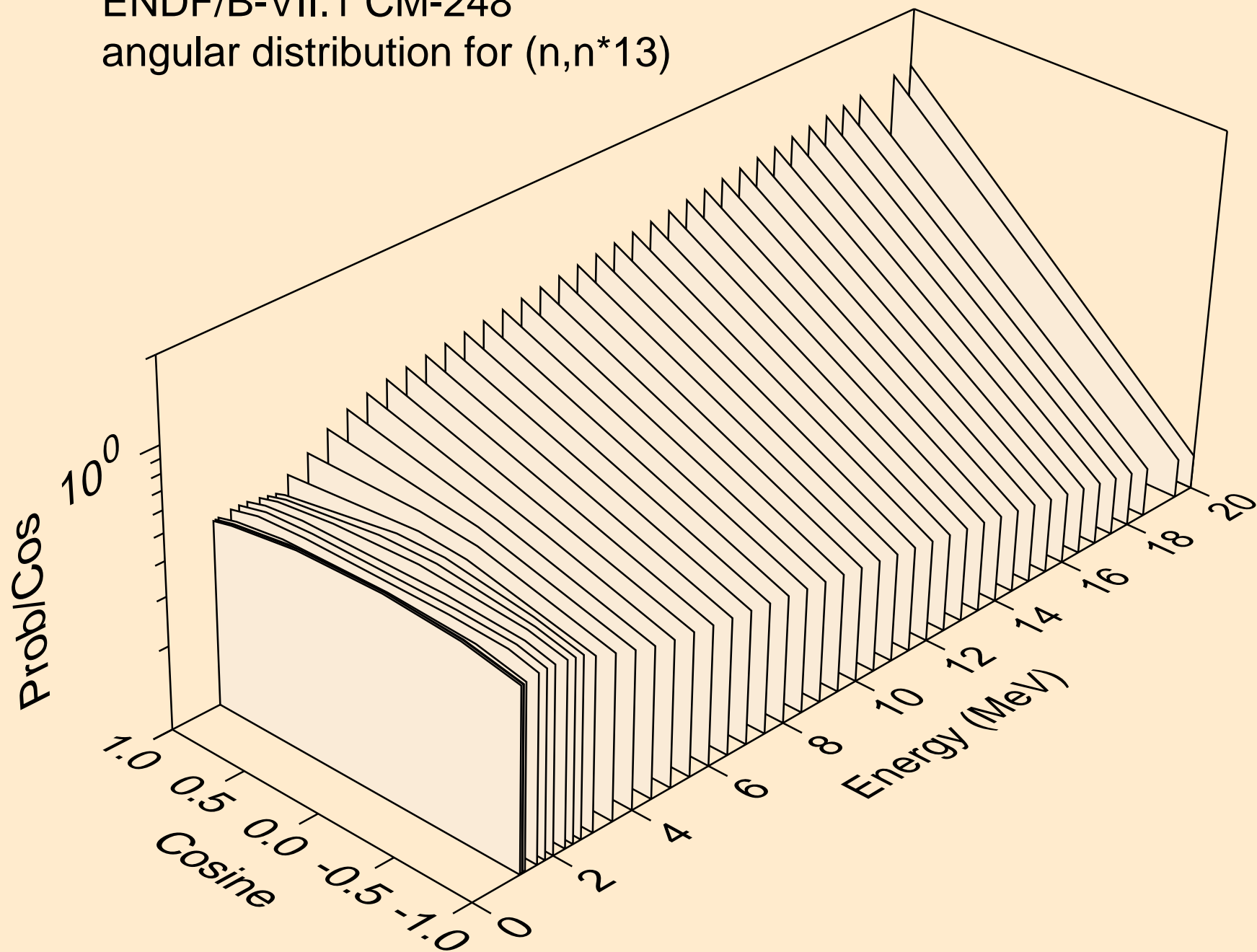



ENDF/B-VII.1 CM-248  
angular distribution for (n,n\*14)

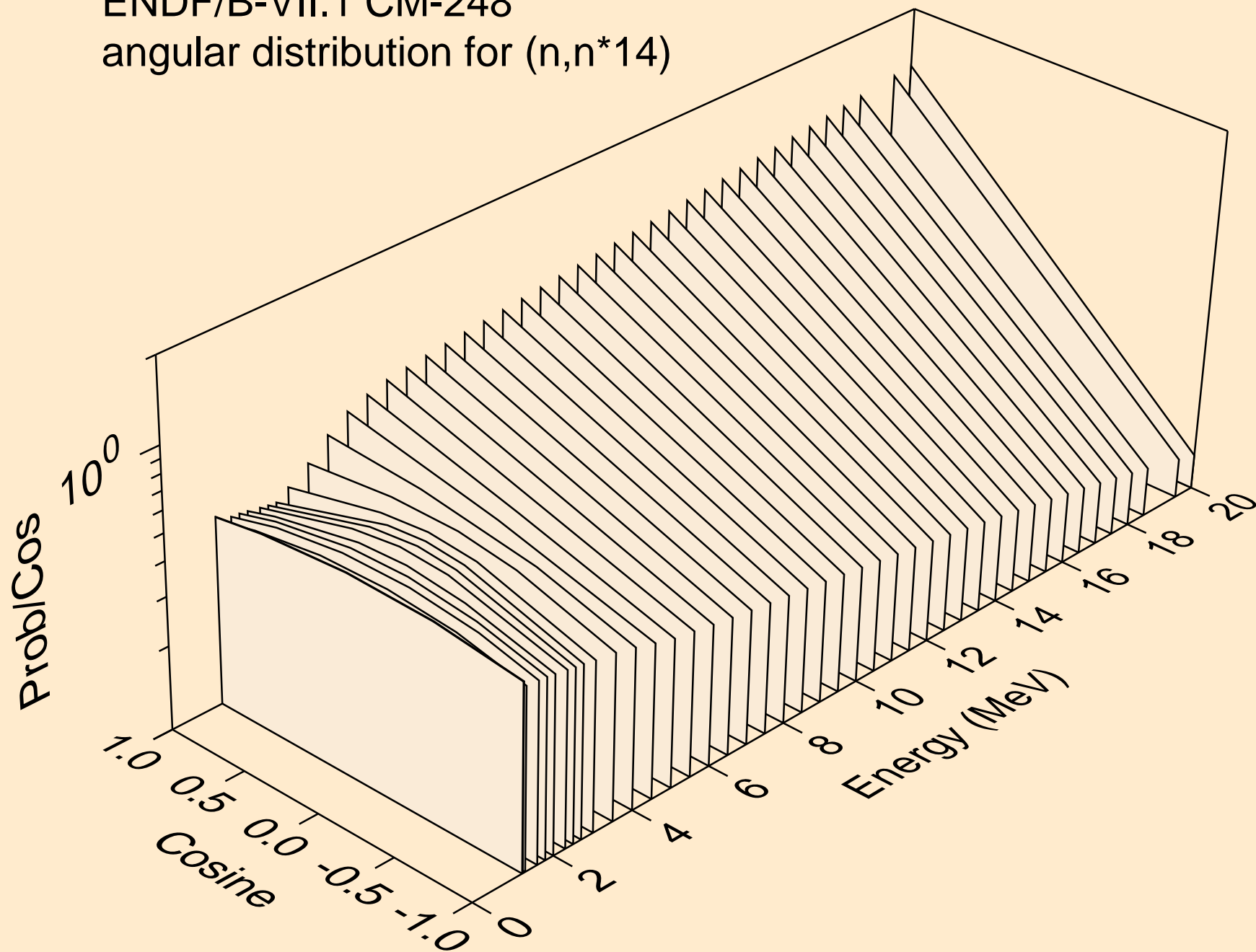

ENDF/B-VII.1 CM-248  
angular distribution for (n,n\*15)

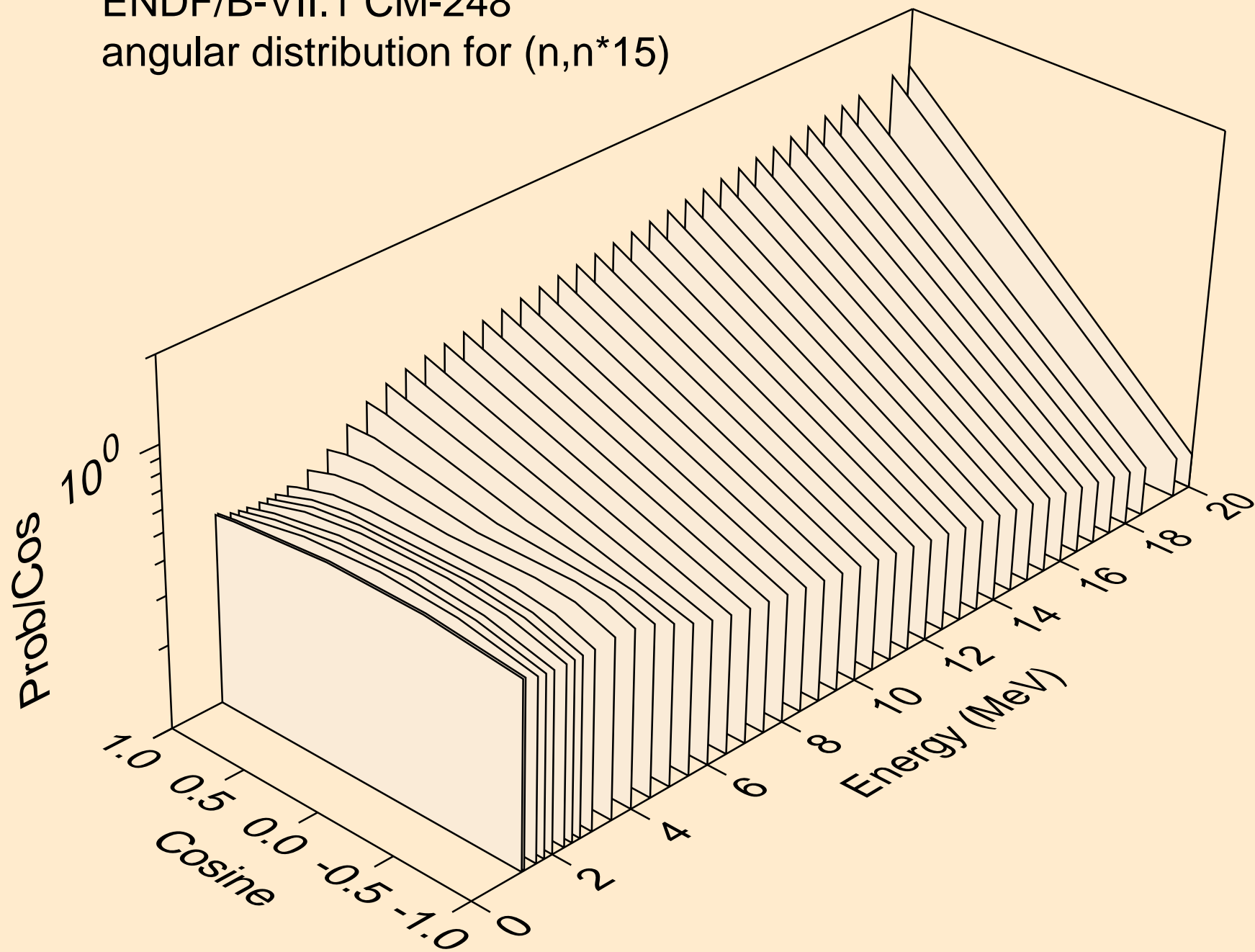

ENDF/B-VII.1 CM-248

Total fission nubar

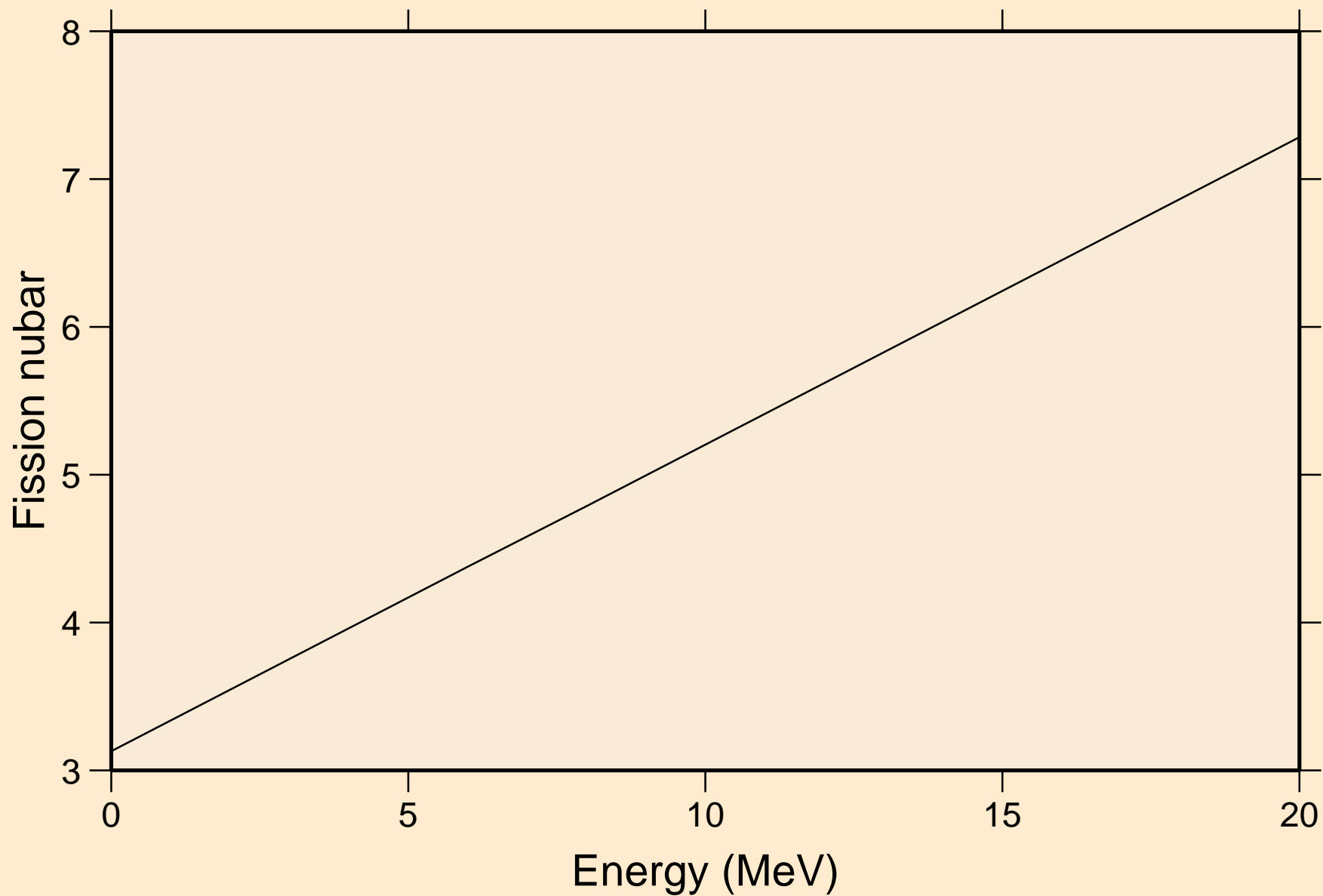

ENDF/B-VII.1 CM-248  
Neutron emission for (n,2n)

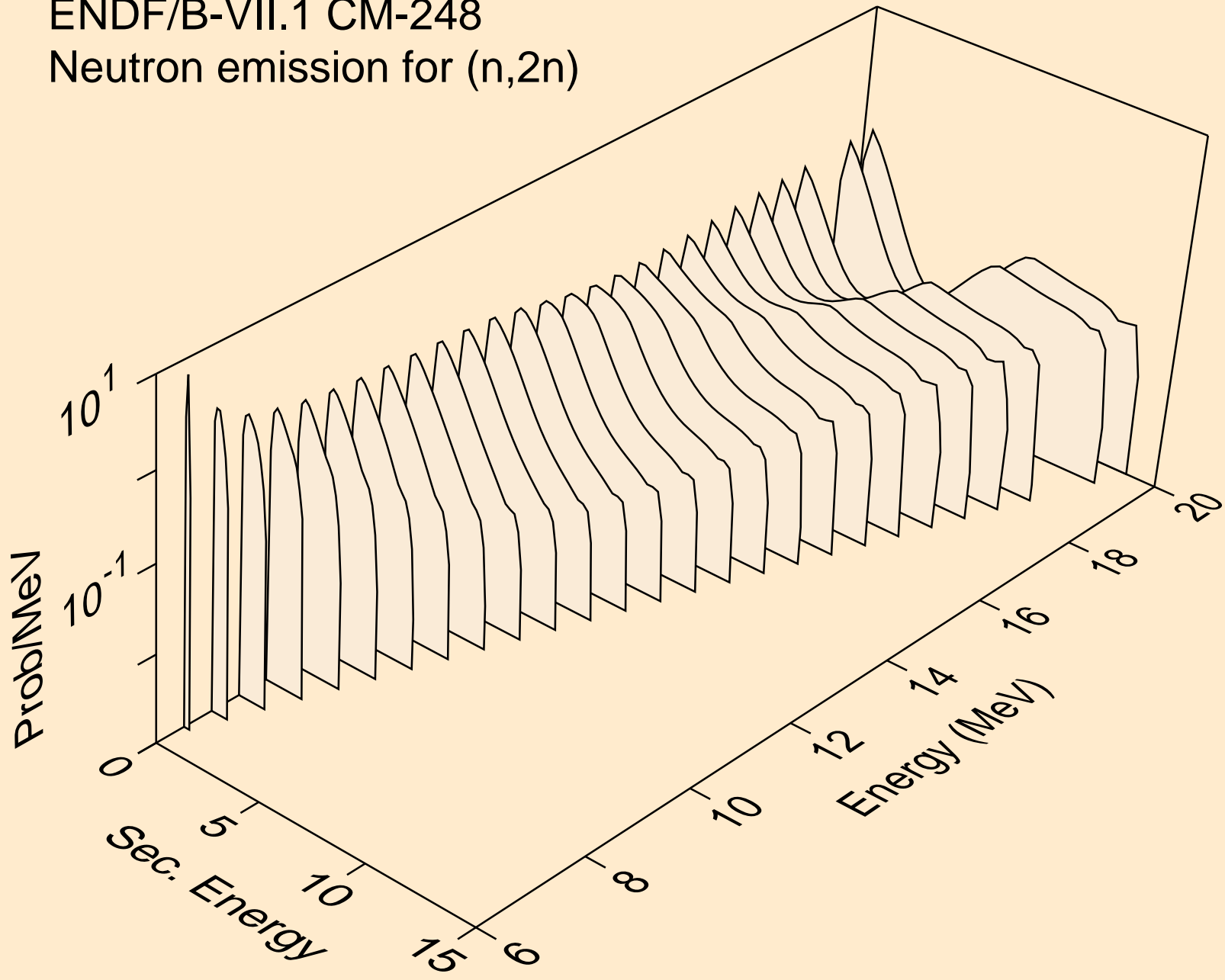

ENDF/B-VII.1 CM-248  
Neutron emission for (n,3n)

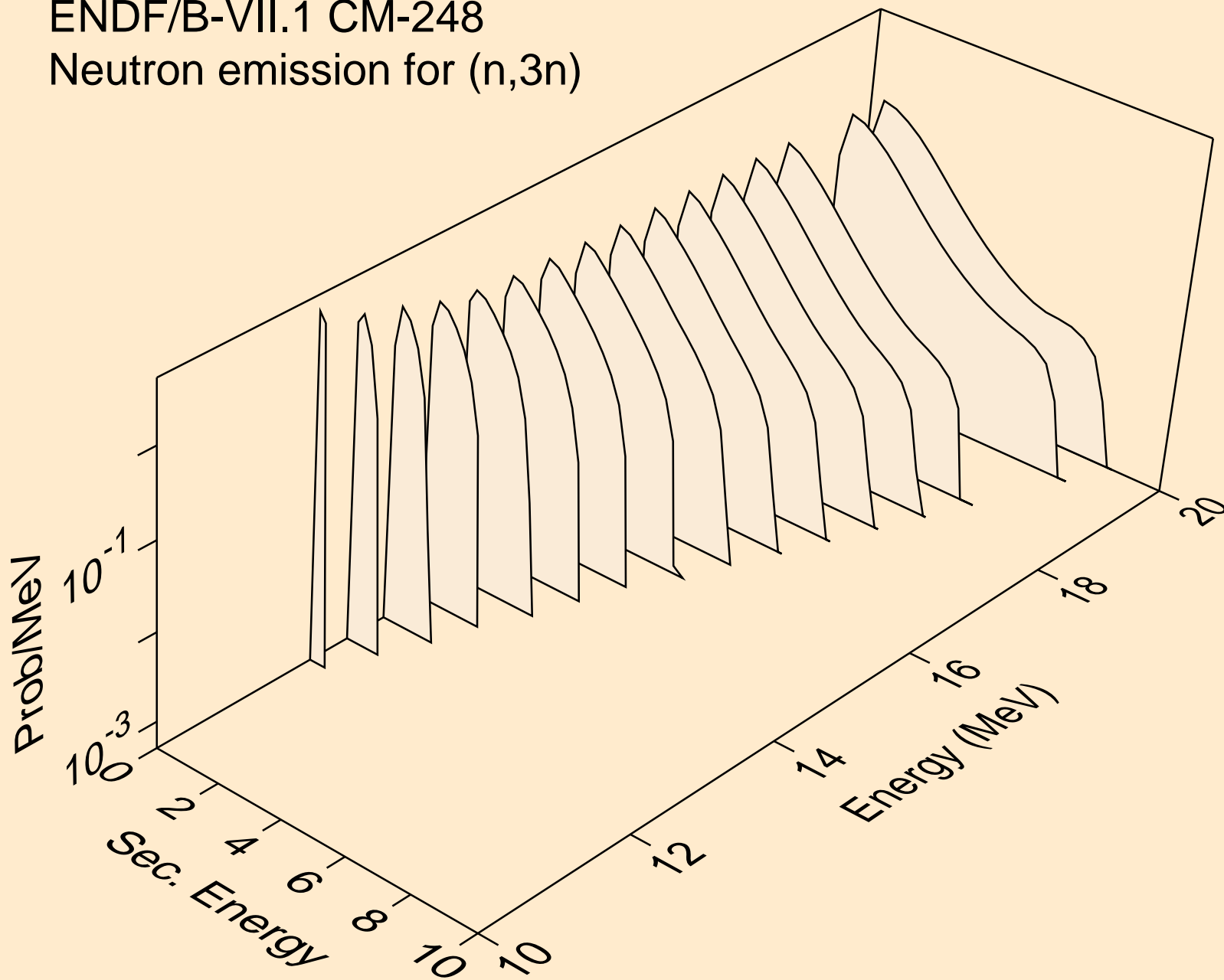

ENDF/B-VII.1 CM-248  
Neutron emission for fission

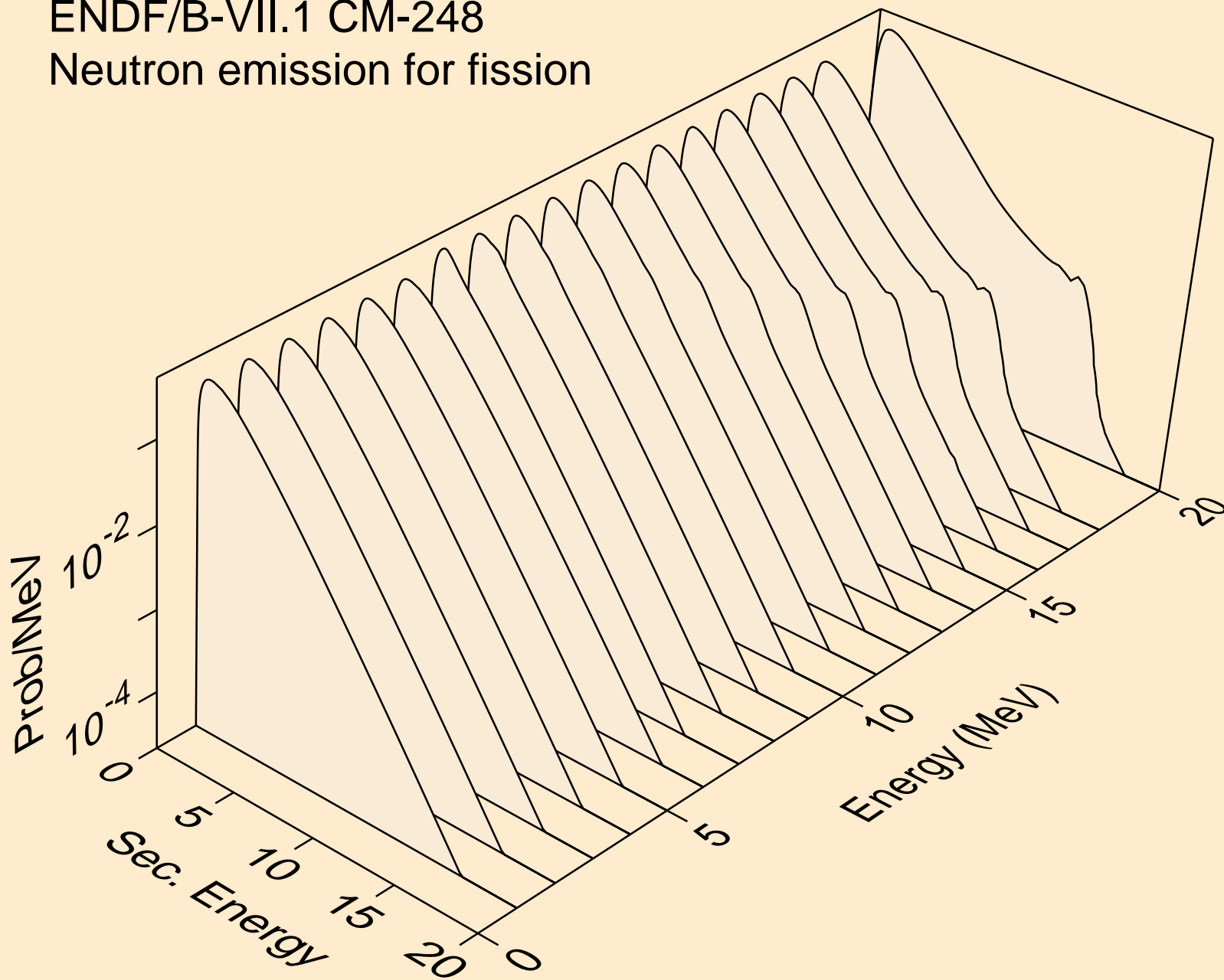

ENDF/B-VII.1 CM-248  
Neutron emission for (n,4n)

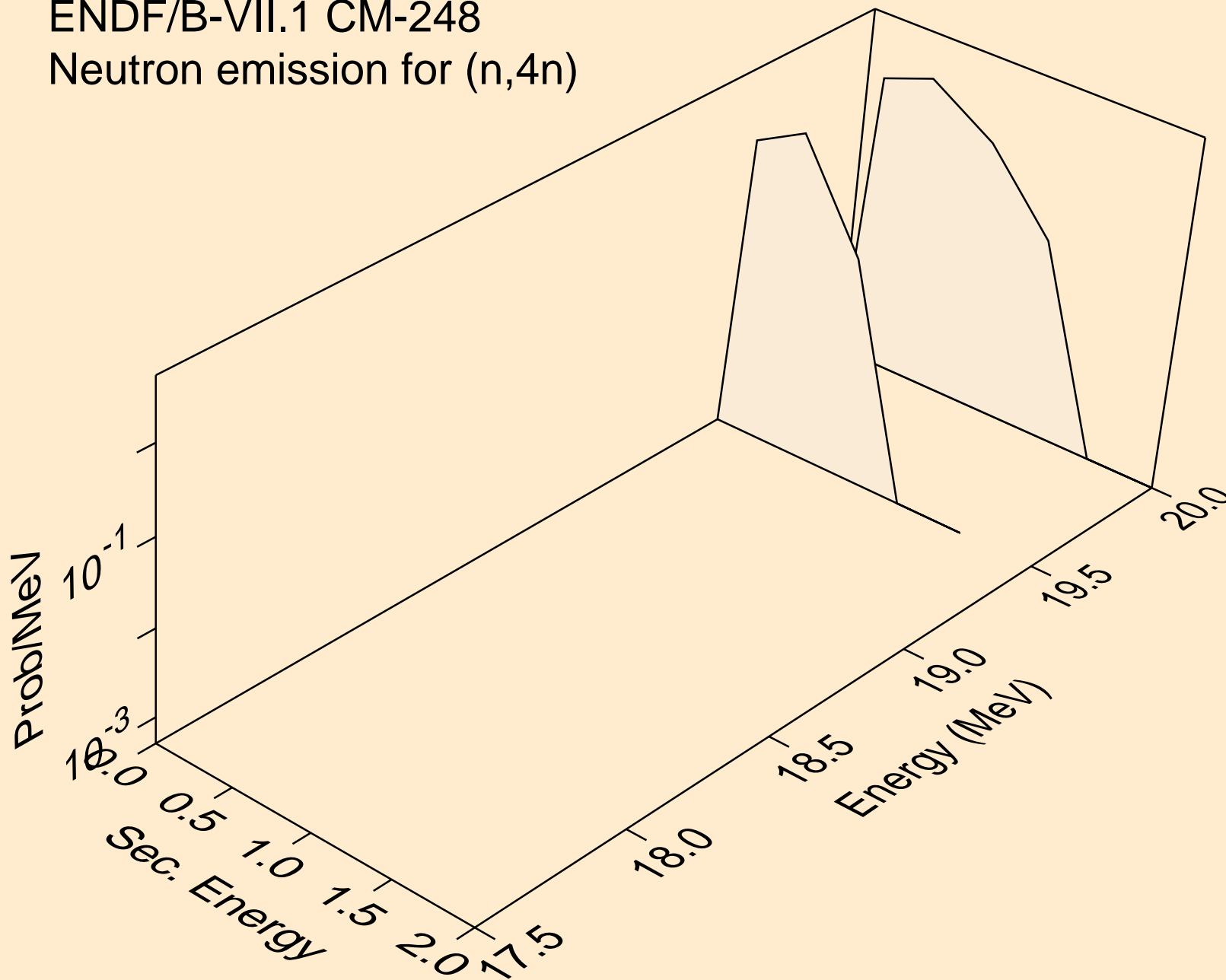

ENDF/B-VII.1 CM-248  
Neutron emission for (n,n\*c)

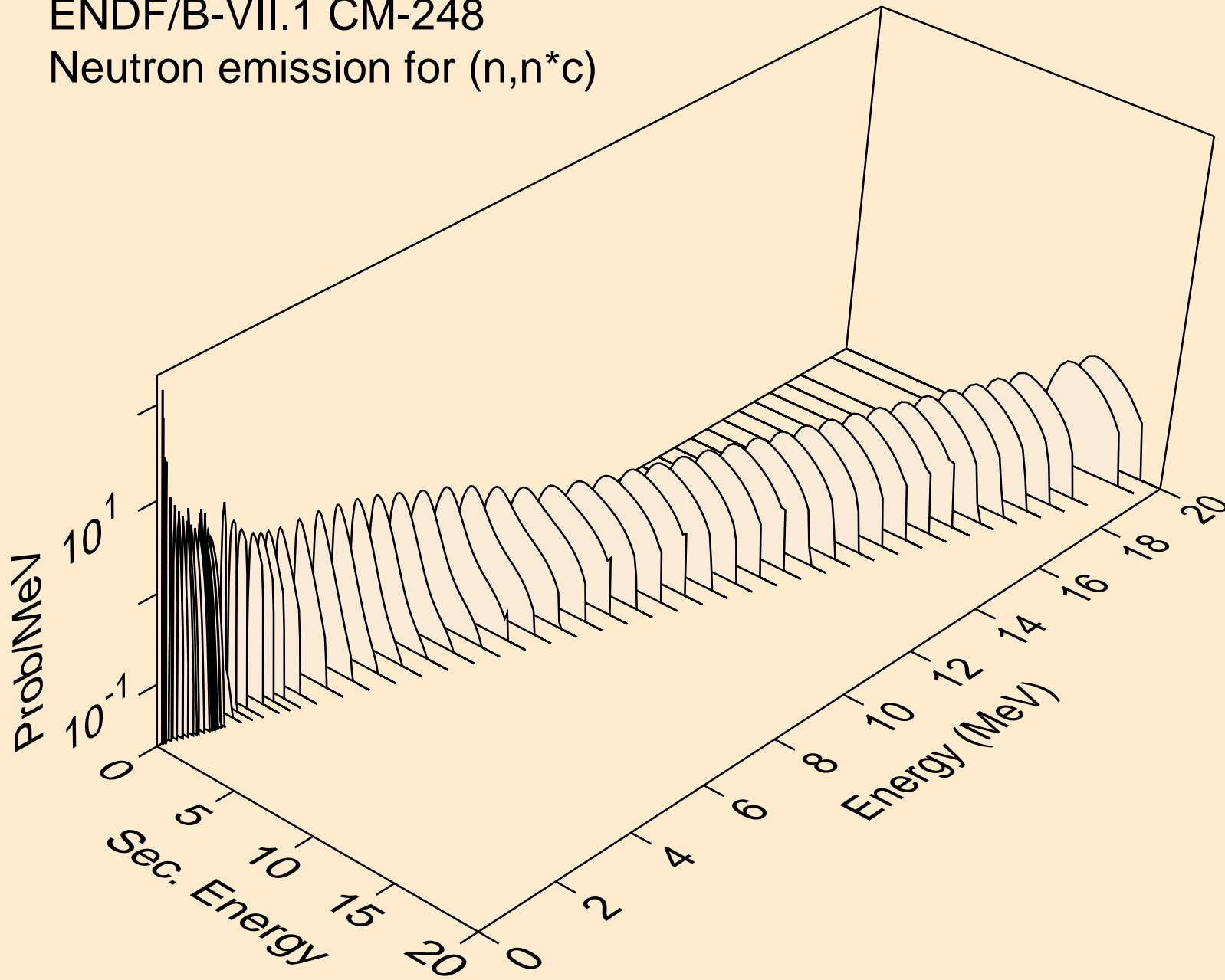



ENDF/B-VII.1 CM-248  
Photon emission for fission

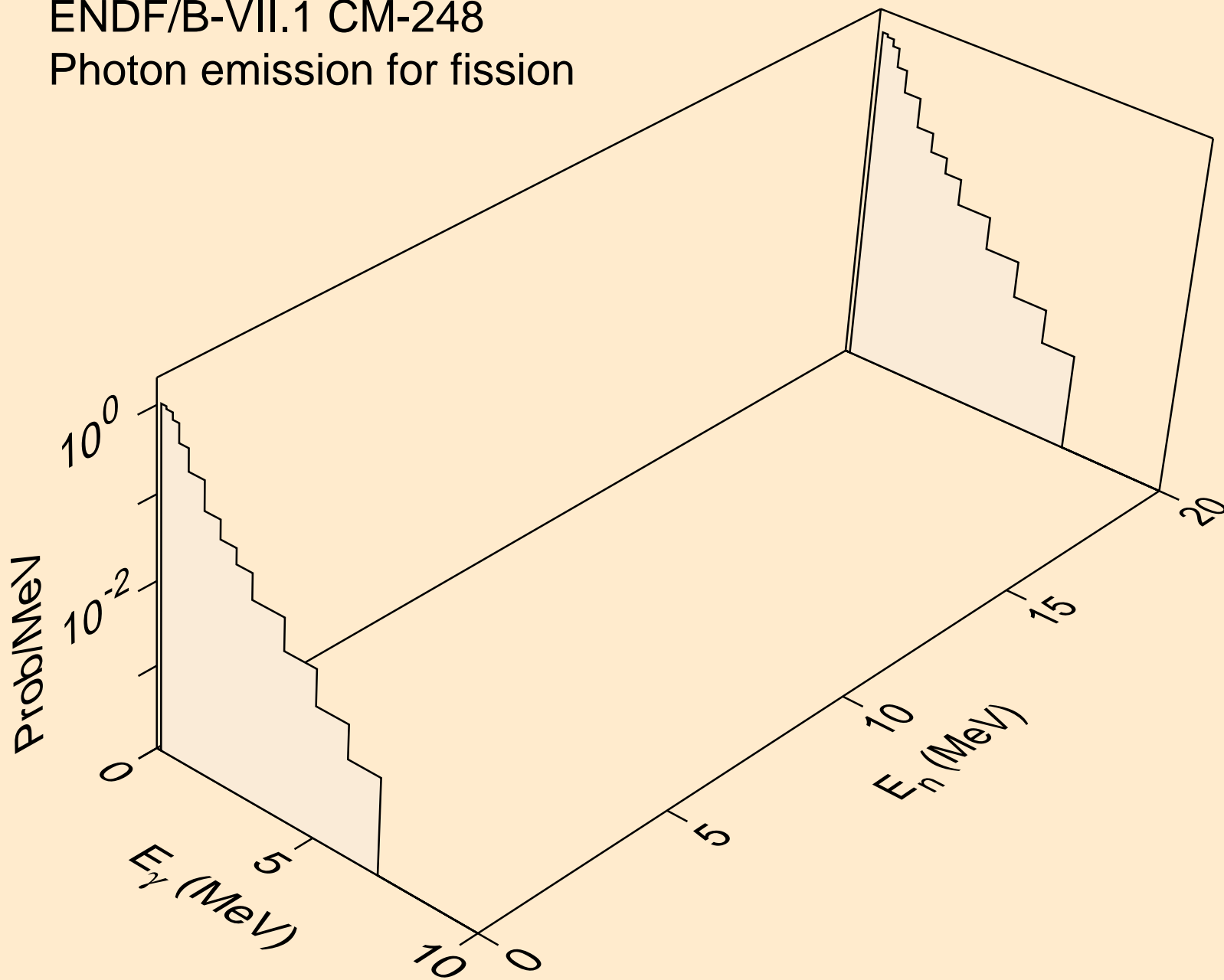

ENDF/B-VII.1 CM-248  
Photon emission for (n,2n)

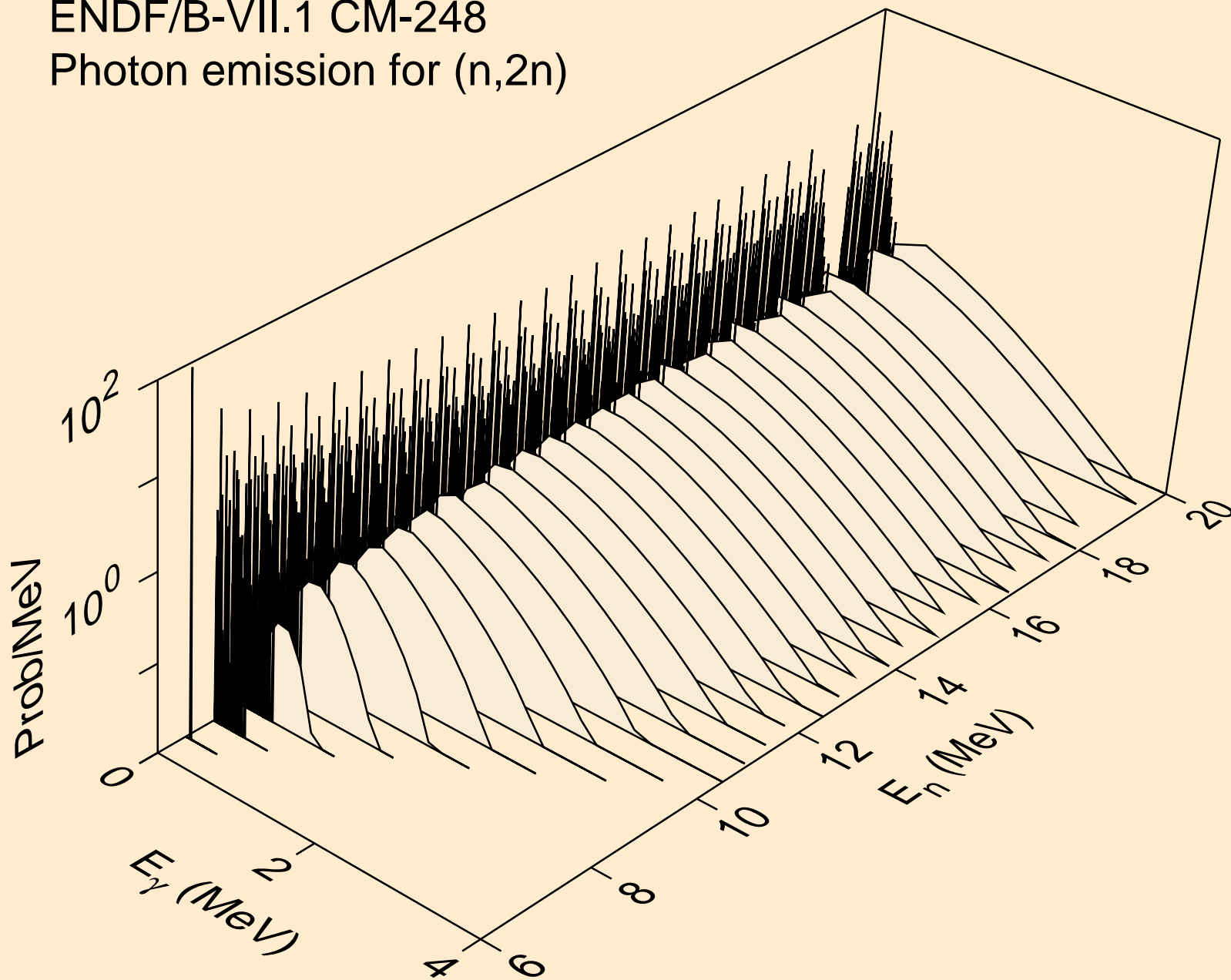

ENDF/B-VII.1 CM-248  
Photon emission for (n,3n)

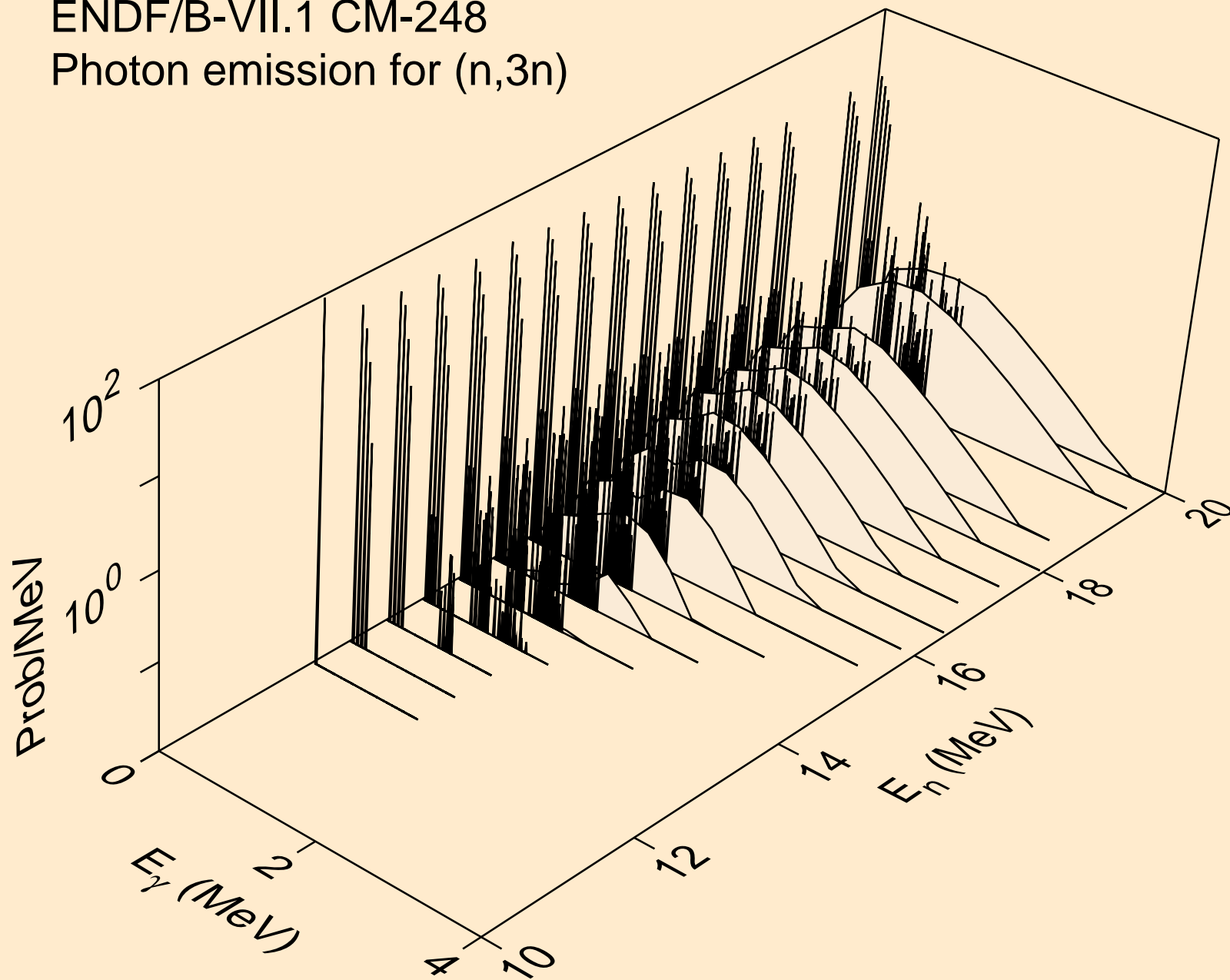

ENDF/B-VII.1 CM-248  
Photon emission for (n,4n)

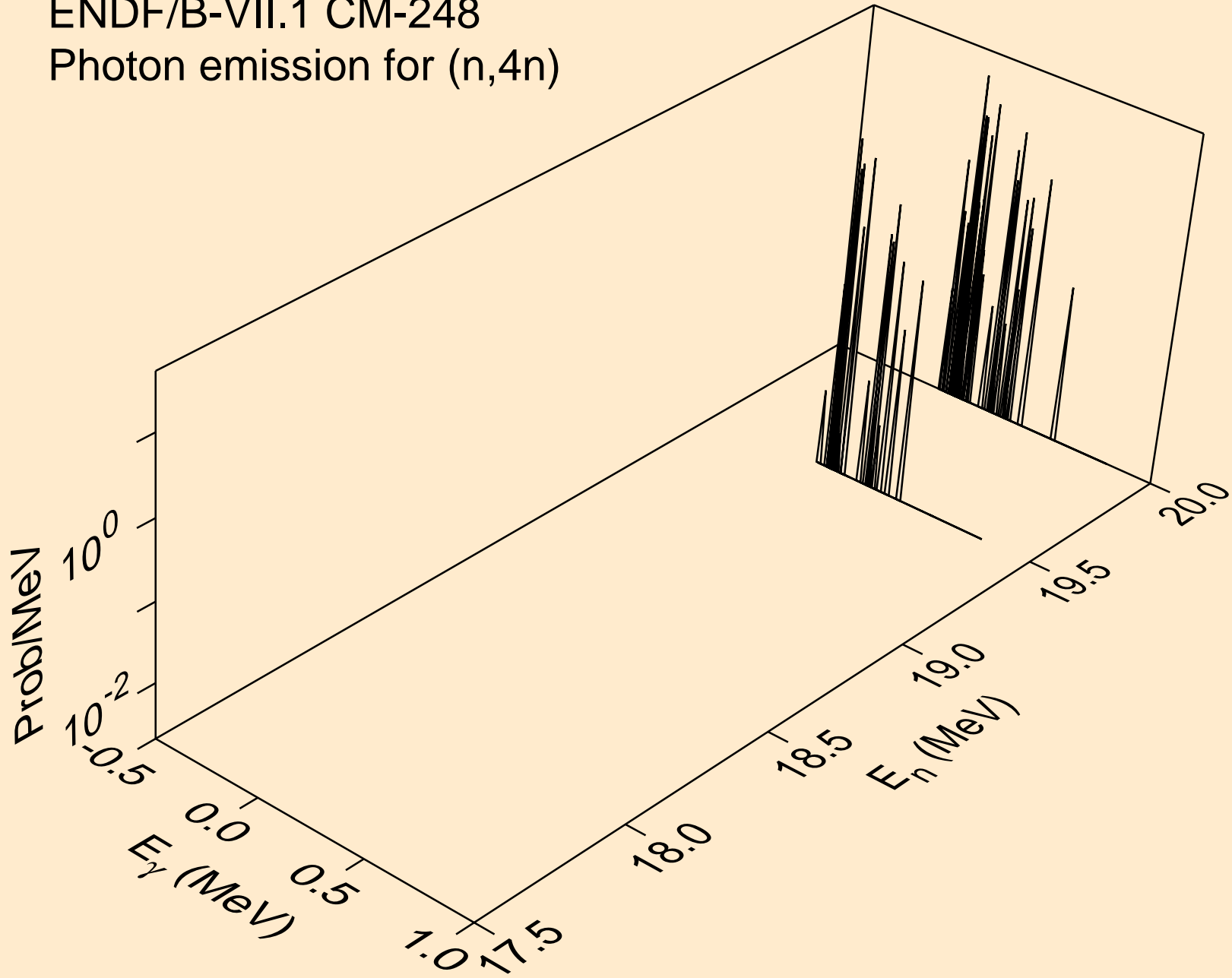

ENDF/B-VII.1 CM-248  
Photon emission for (n,n\*1)

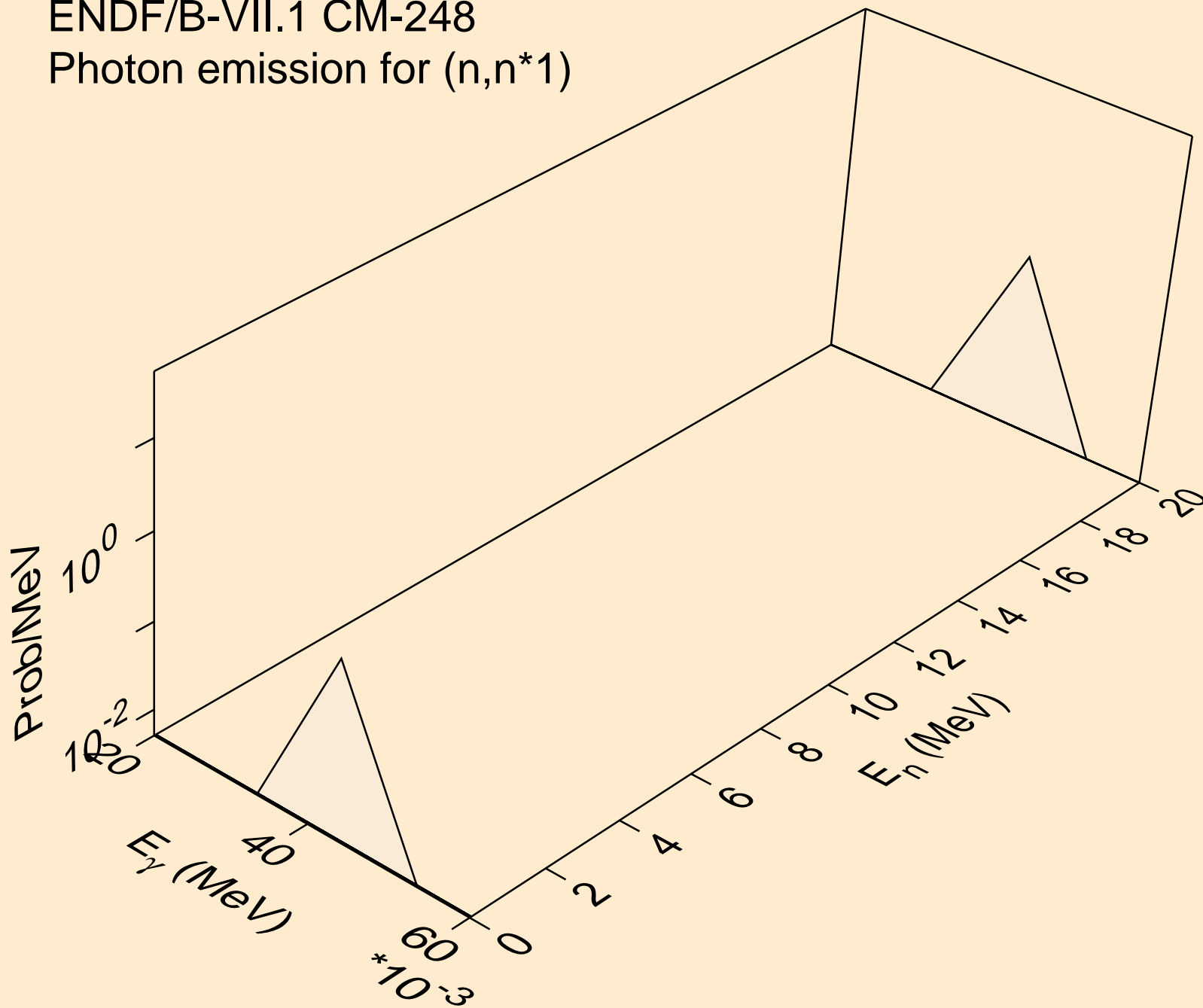

ENDF/B-VII.1 CM-248  
Photon emission for (n,n\*2)

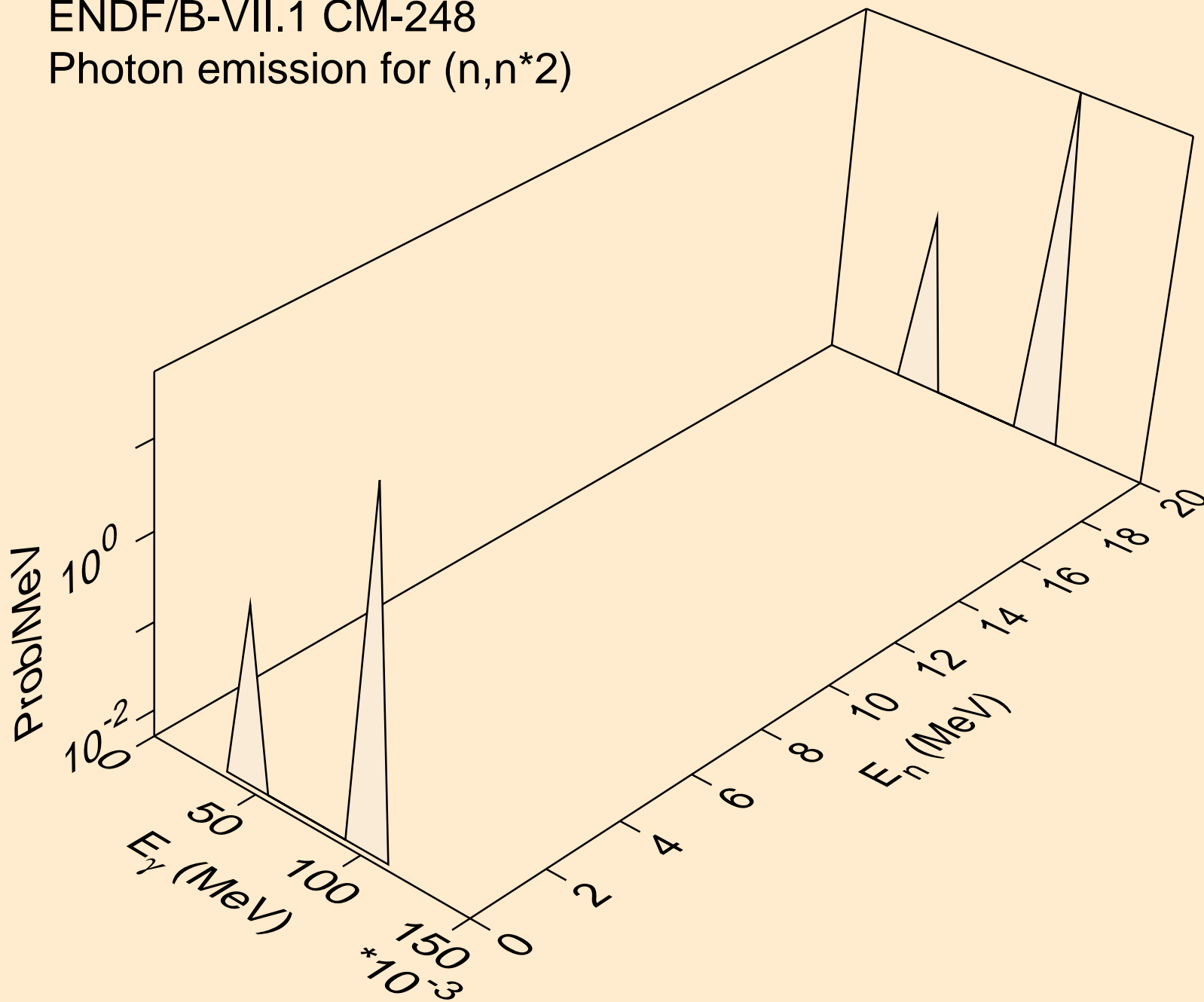

ENDF/B-VII.1 CM-248  
Photon emission for (n,n\*3)

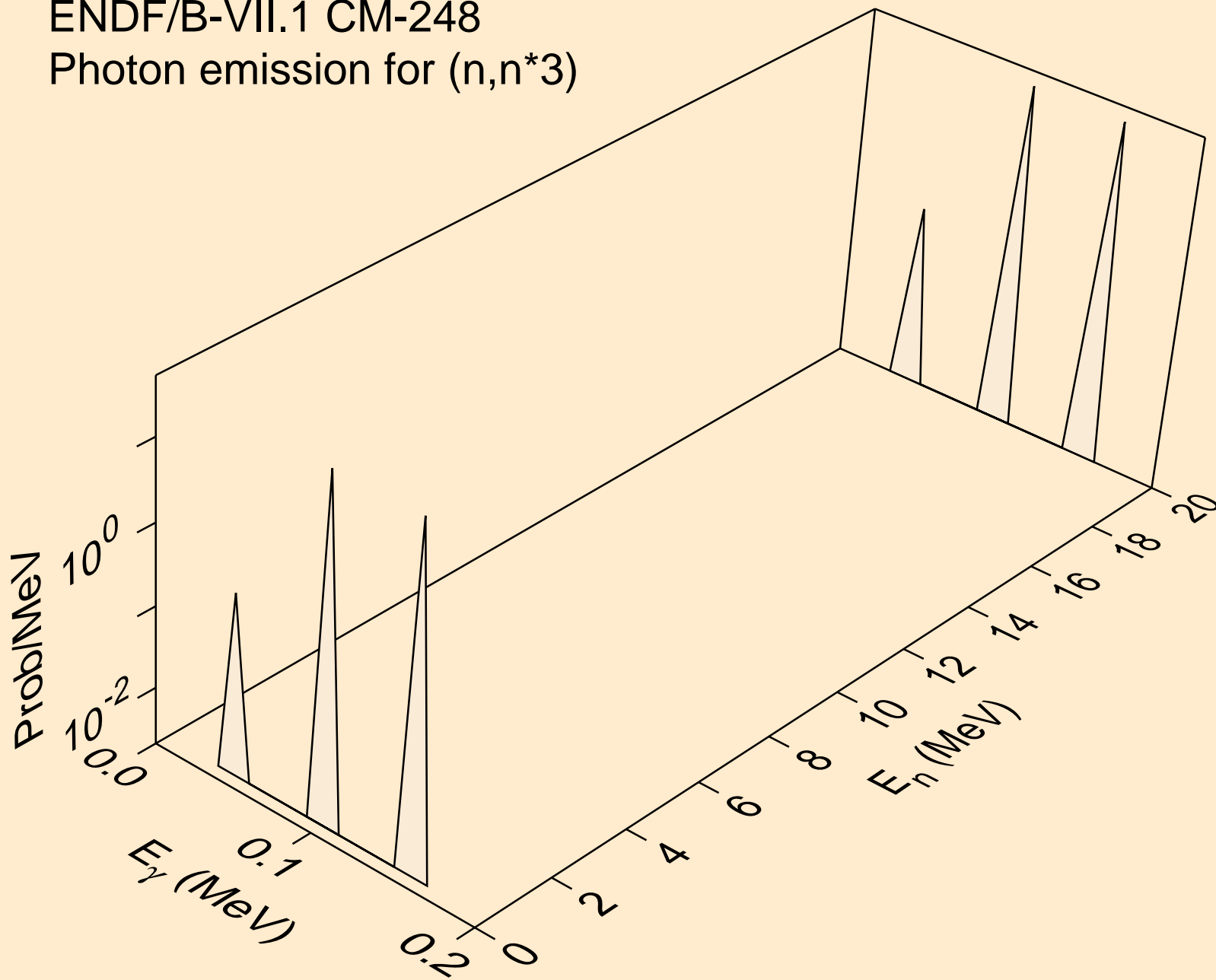

ENDF/B-VII.1 CM-248  
Photon emission for (n,n\*4)

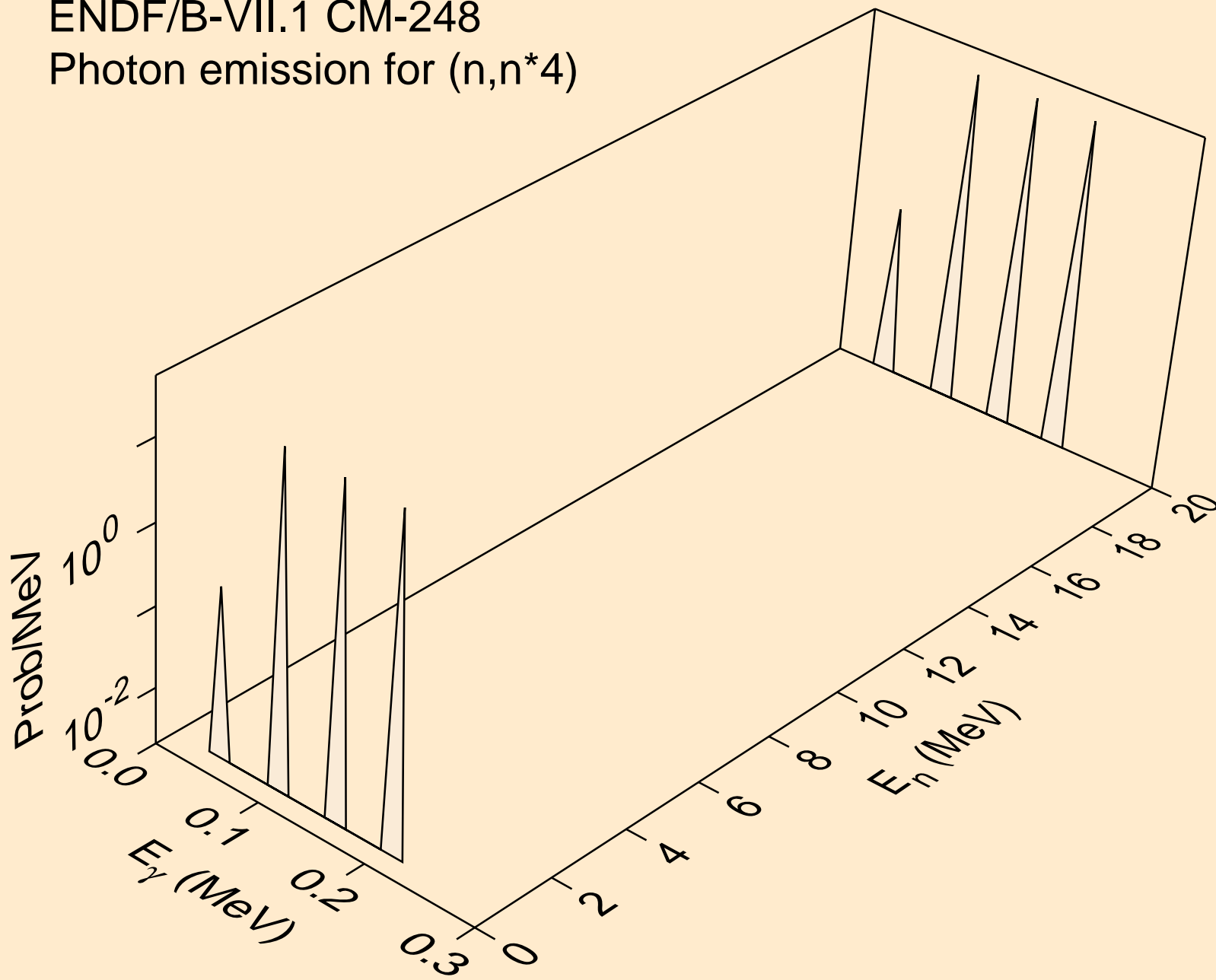



ENDF/B-VII.1 CM-248  
Photon emission for (n,n\*5)

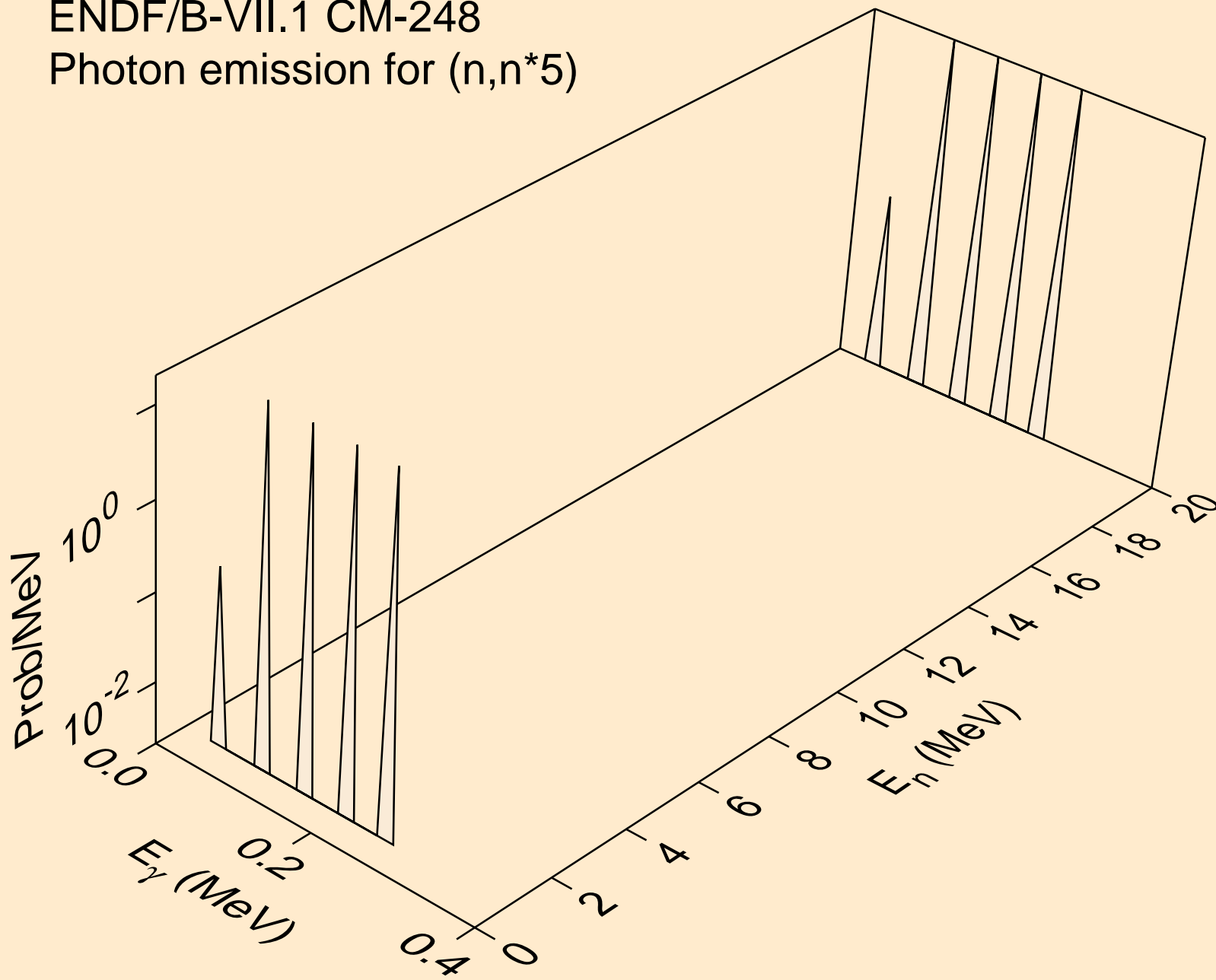

ENDF/B-VII.1 CM-248  
Photon emission for (n,n\*6)

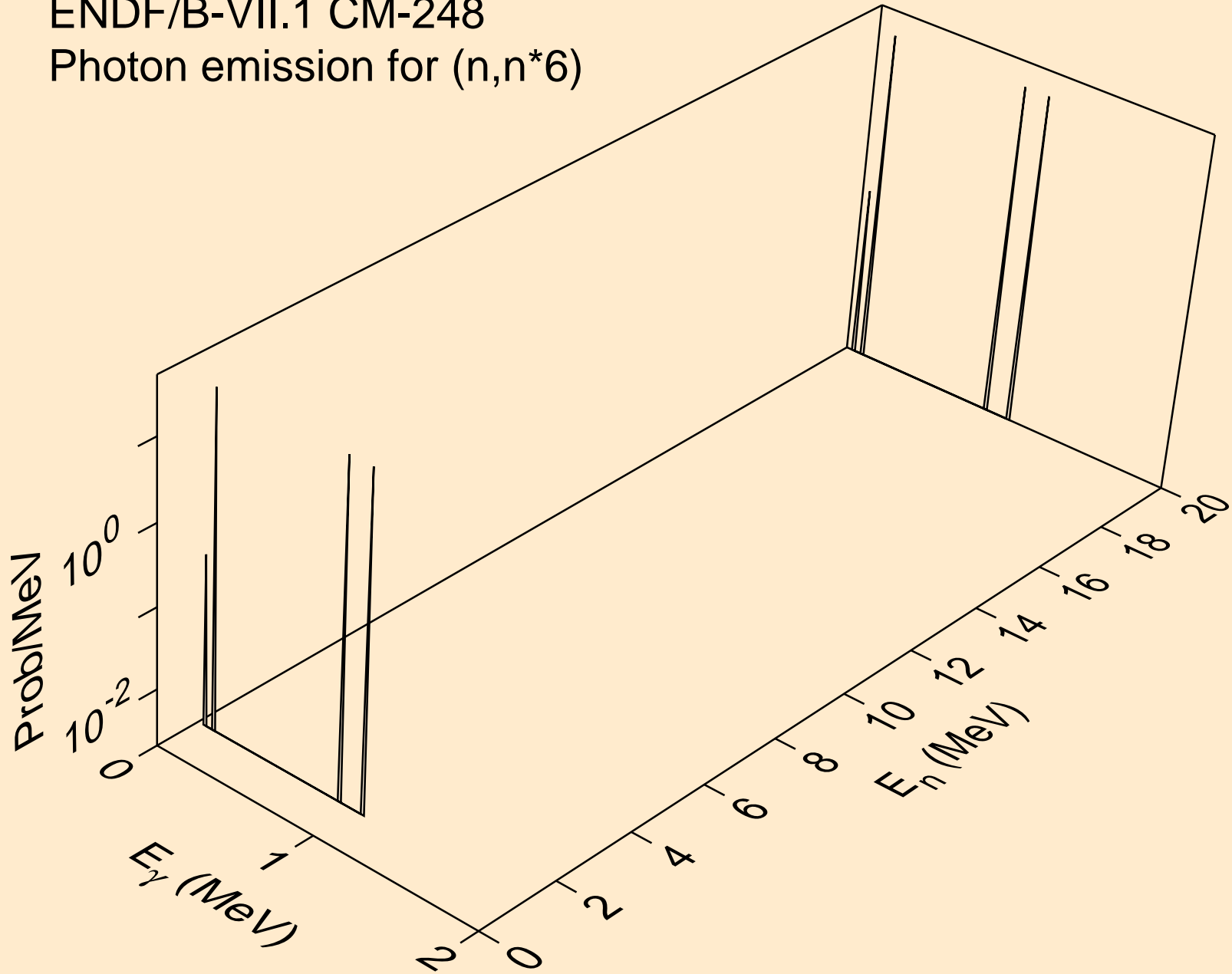

ENDF/B-VII.1 CM-248  
Photon emission for (n,n\*7)

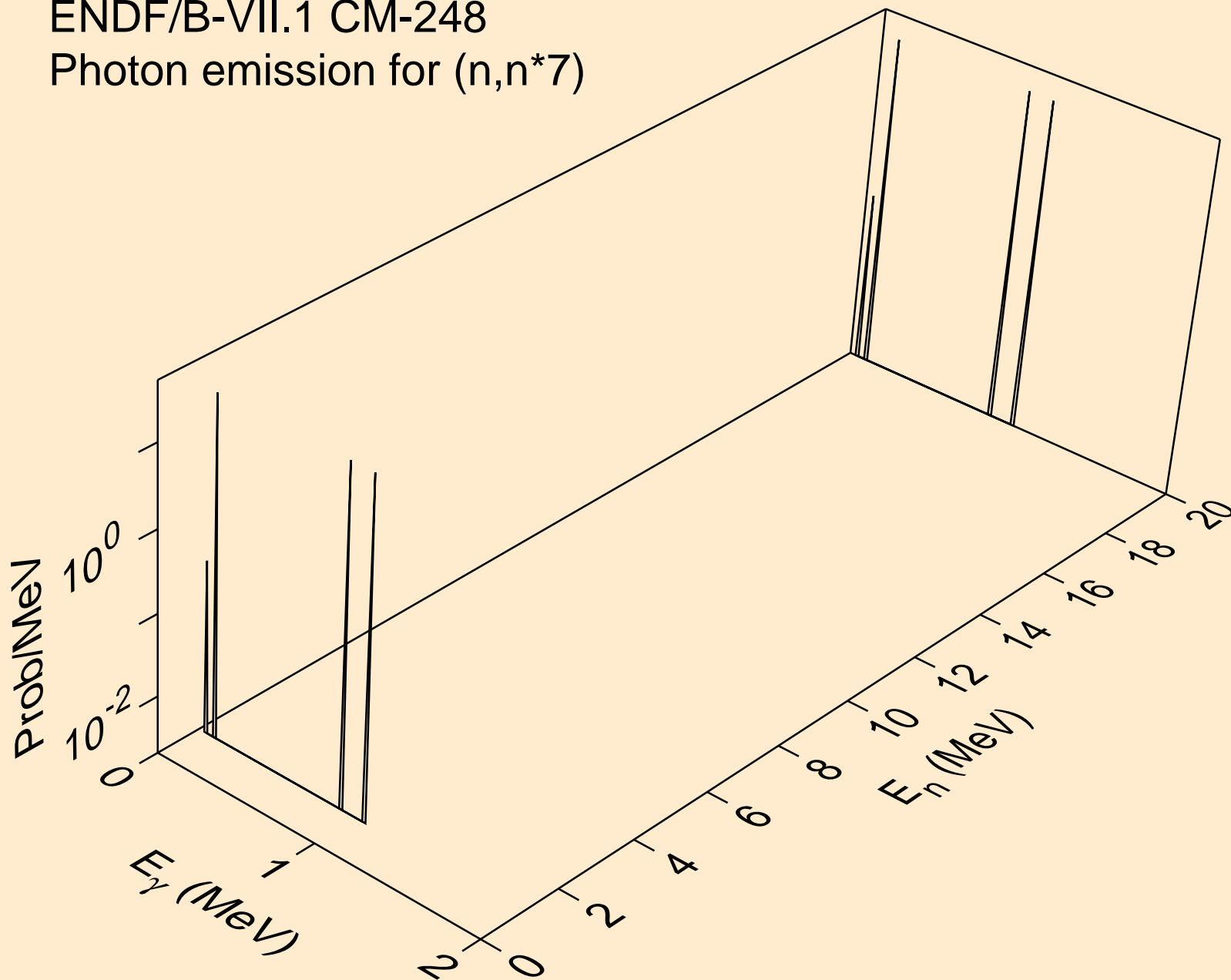

ENDF/B-VII.1 CM-248  
Photon emission for (n,n\*8)

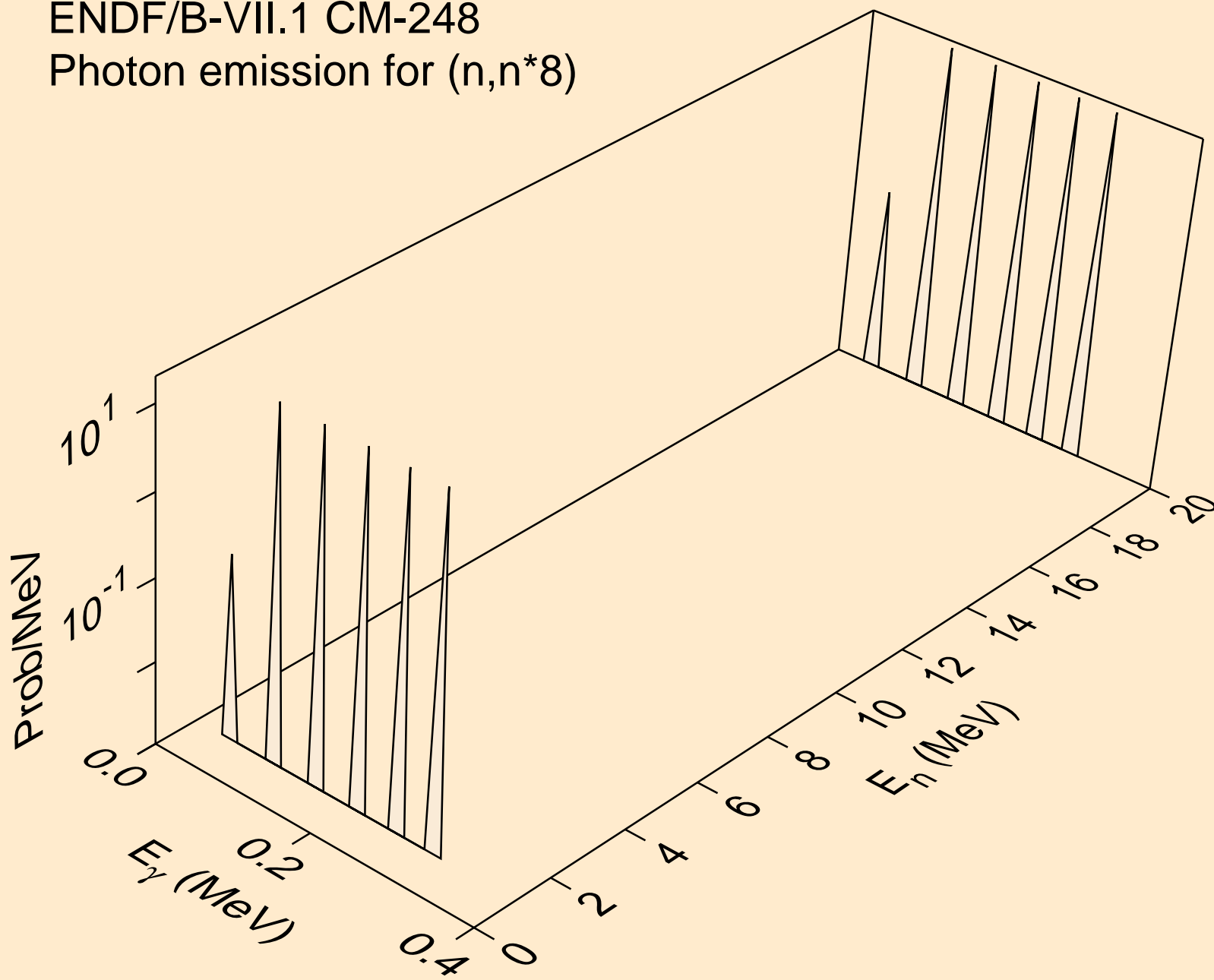

ENDF/B-VII.1 CM-248  
Photon emission for (n,n\*9)

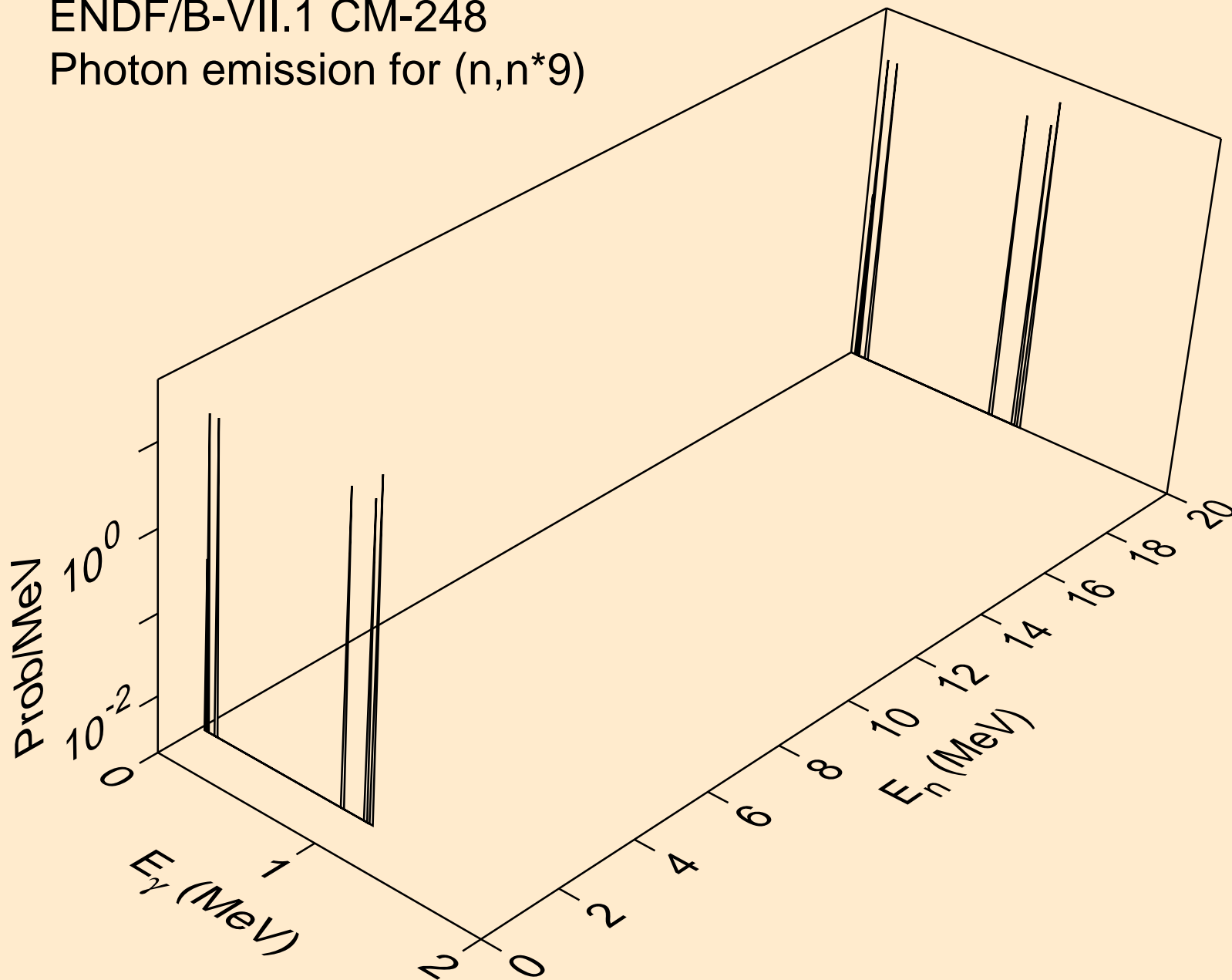

ENDF/B-VII.1 CM-248  
Photon emission for (n,n\*10)

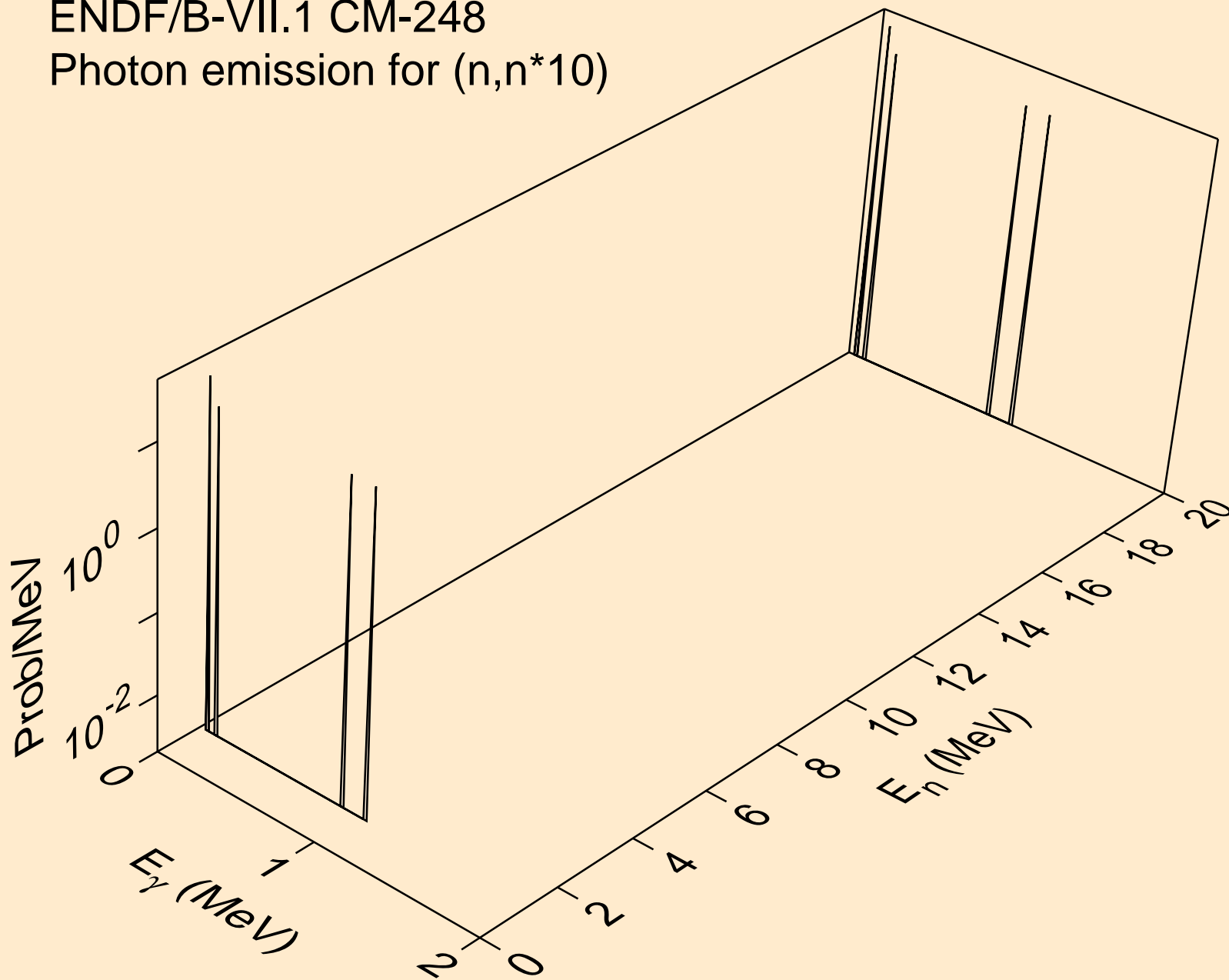

ENDF/B-VII.1 CM-248  
Photon emission for (n,n\*11)

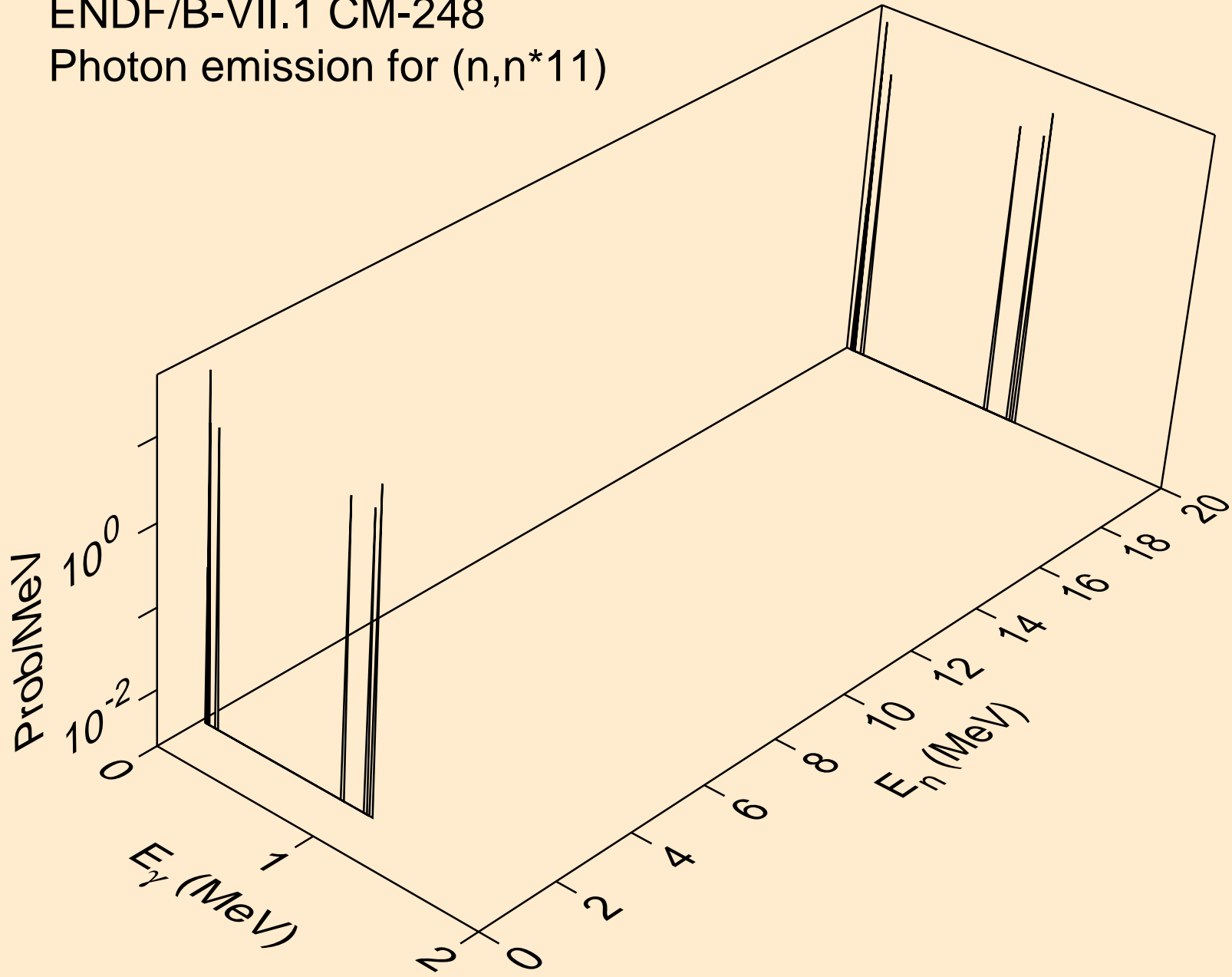

ENDF/B-VII.1 CM-248  
Photon emission for (n,n\*12)

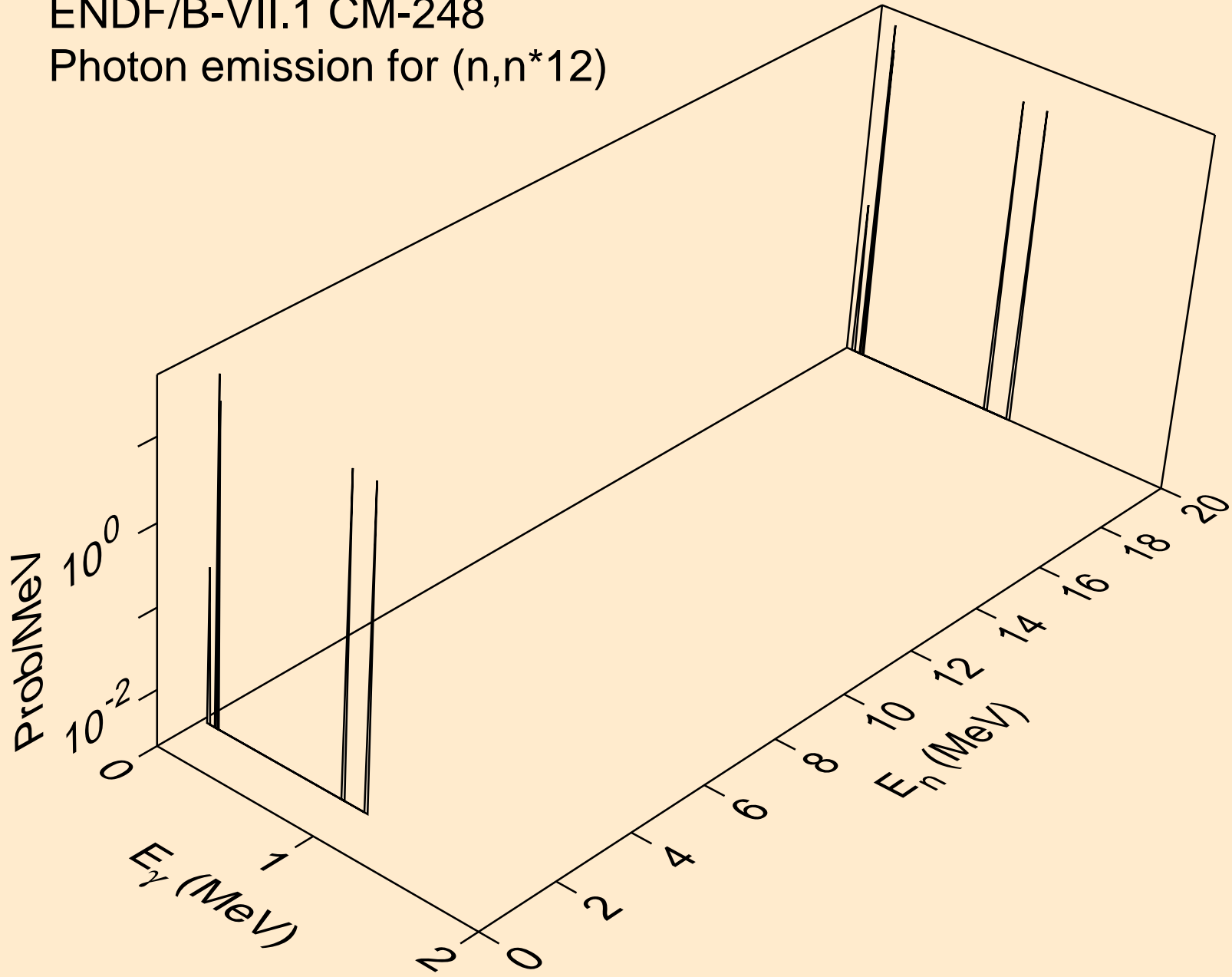



ENDF/B-VII.1 CM-248  
Photon emission for (n,n\*13)

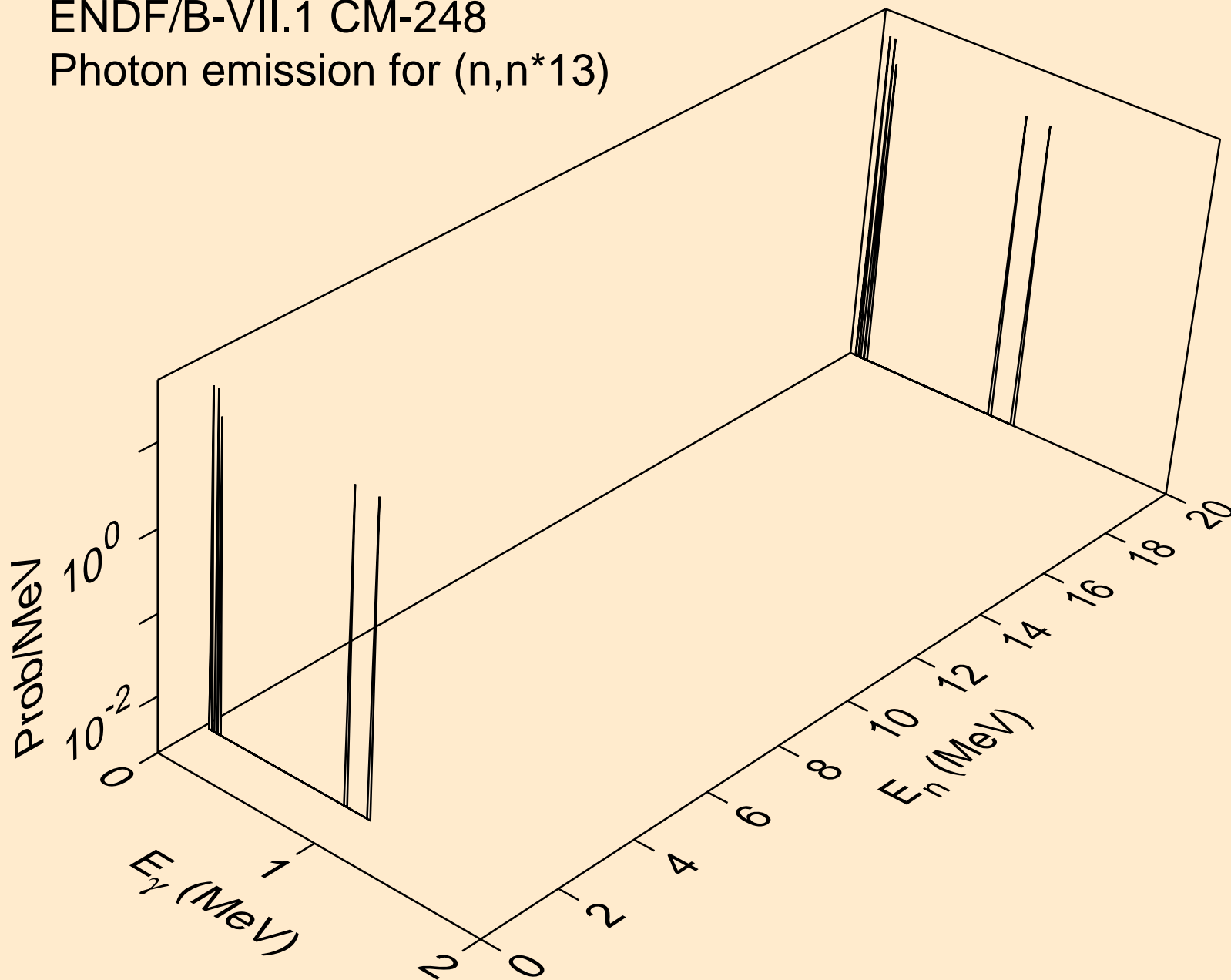

ENDF/B-VII.1 CM-248  
Photon emission for (n,n\*14)

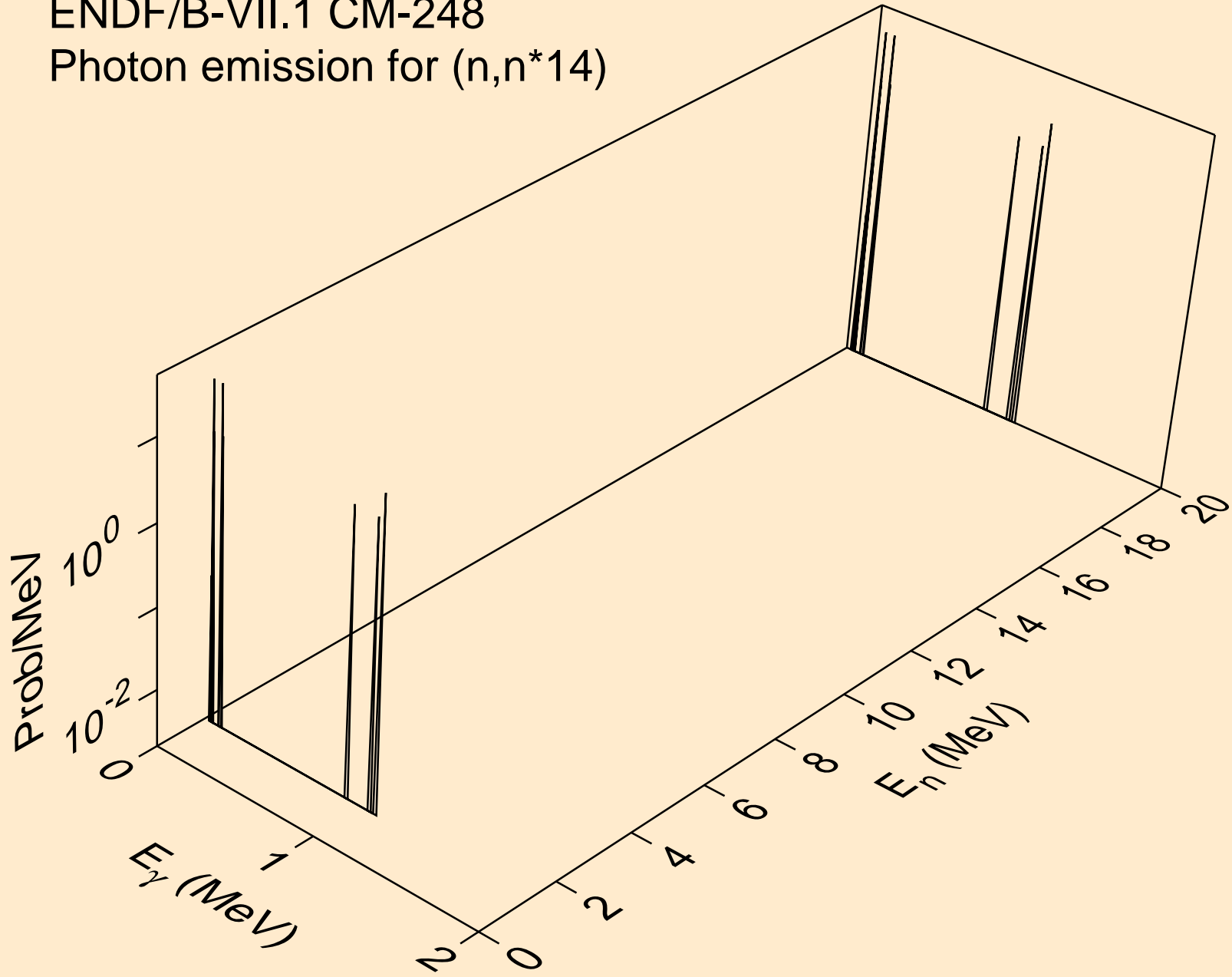

ENDF/B-VII.1 CM-248  
Photon emission for (n,n\*15)

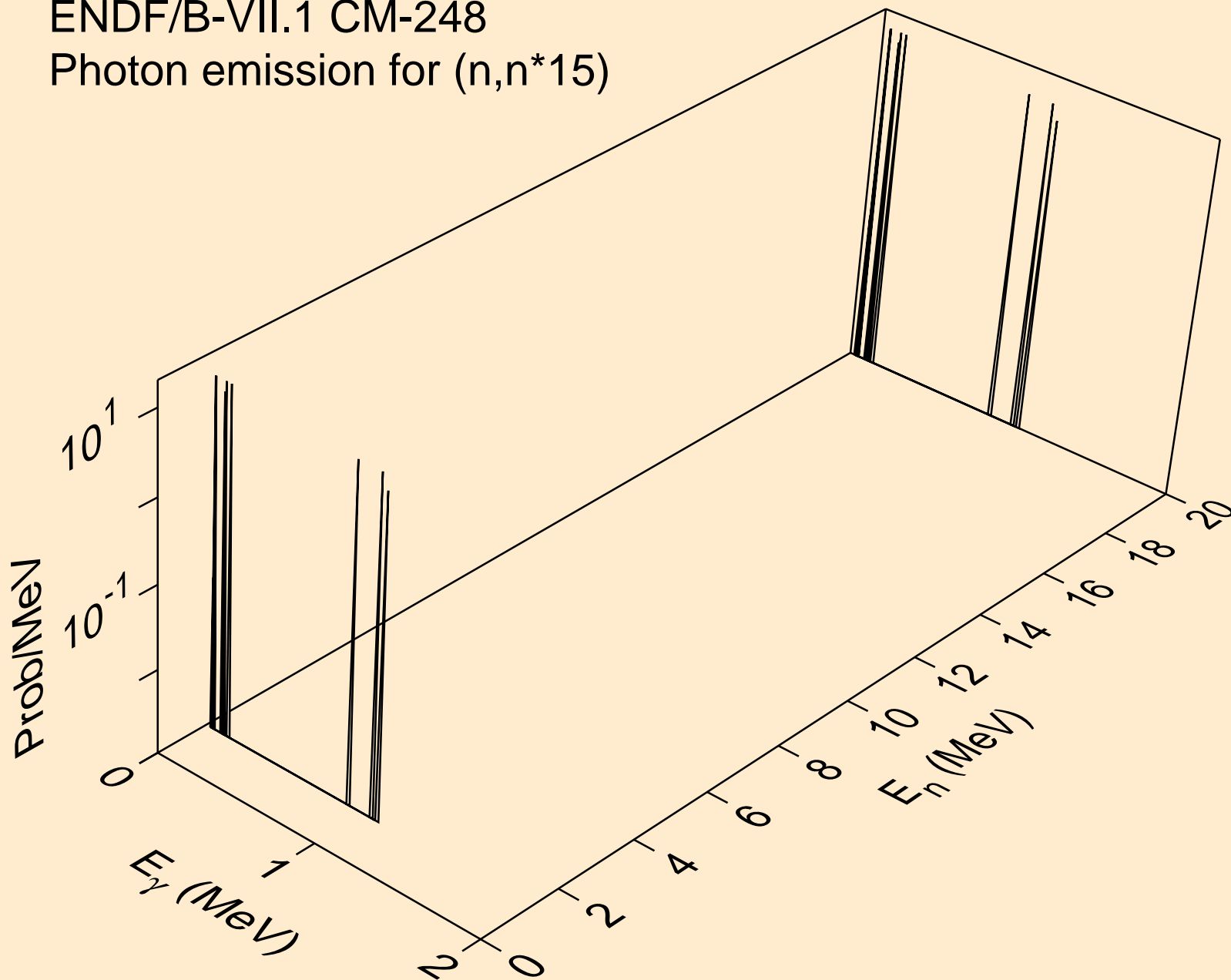

ENDF/B-VII.1 CM-248  
Photon emission for (n,n\*c)

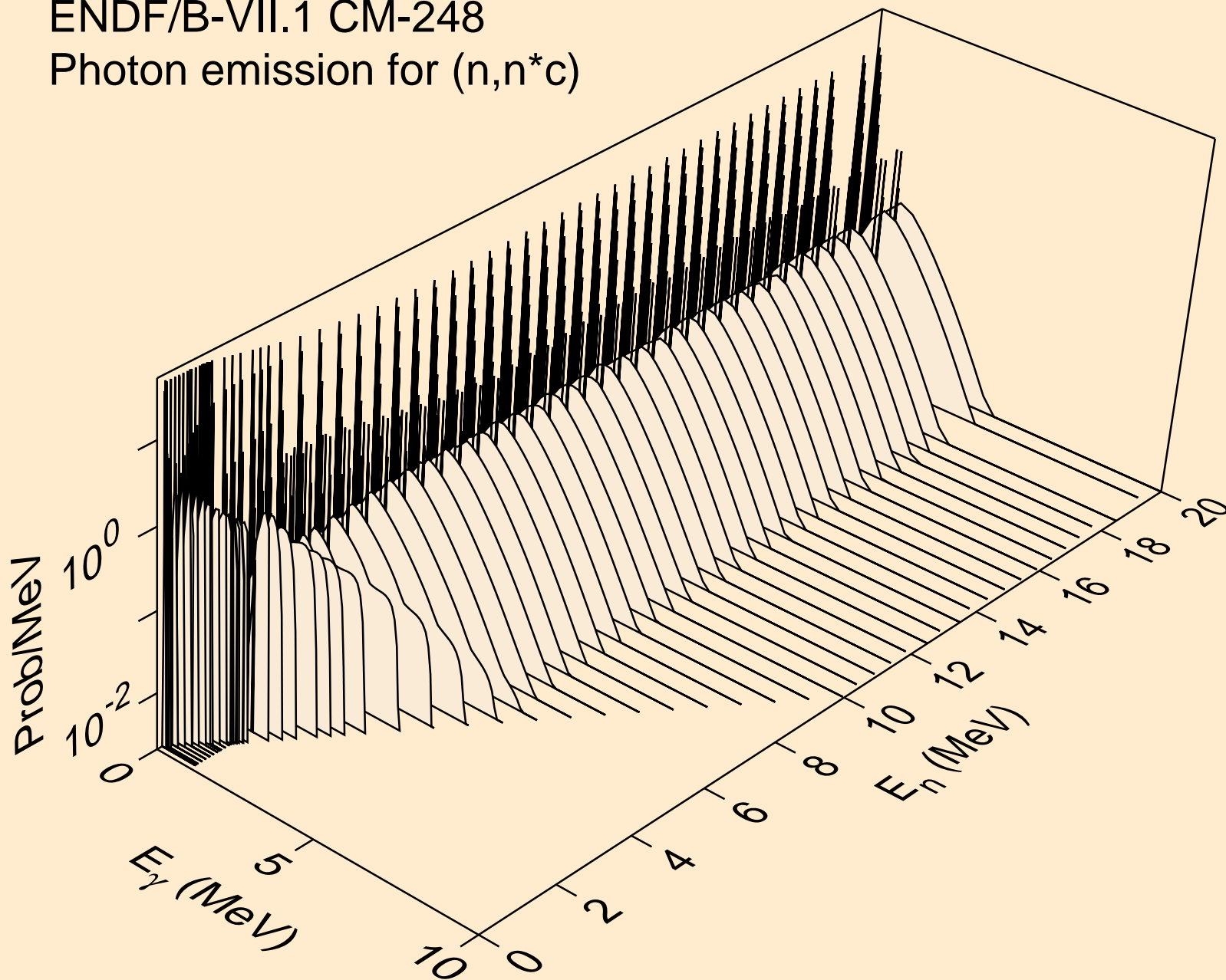

ENDF/B-VII.1 CM-248  
Photon emission for (n,gma)

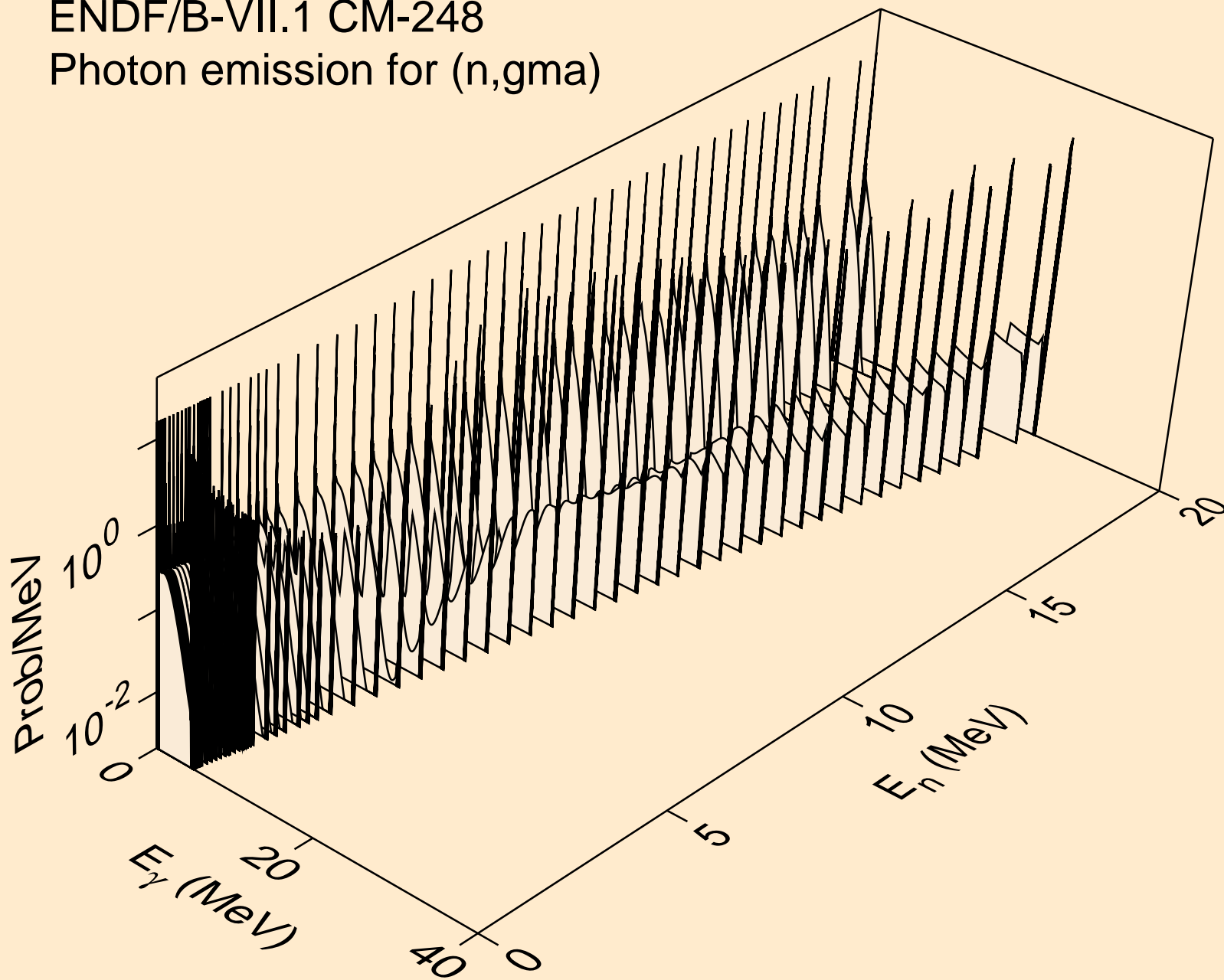

ENDF/B-VII.1 CM-248  
thermal capture photon spectrum

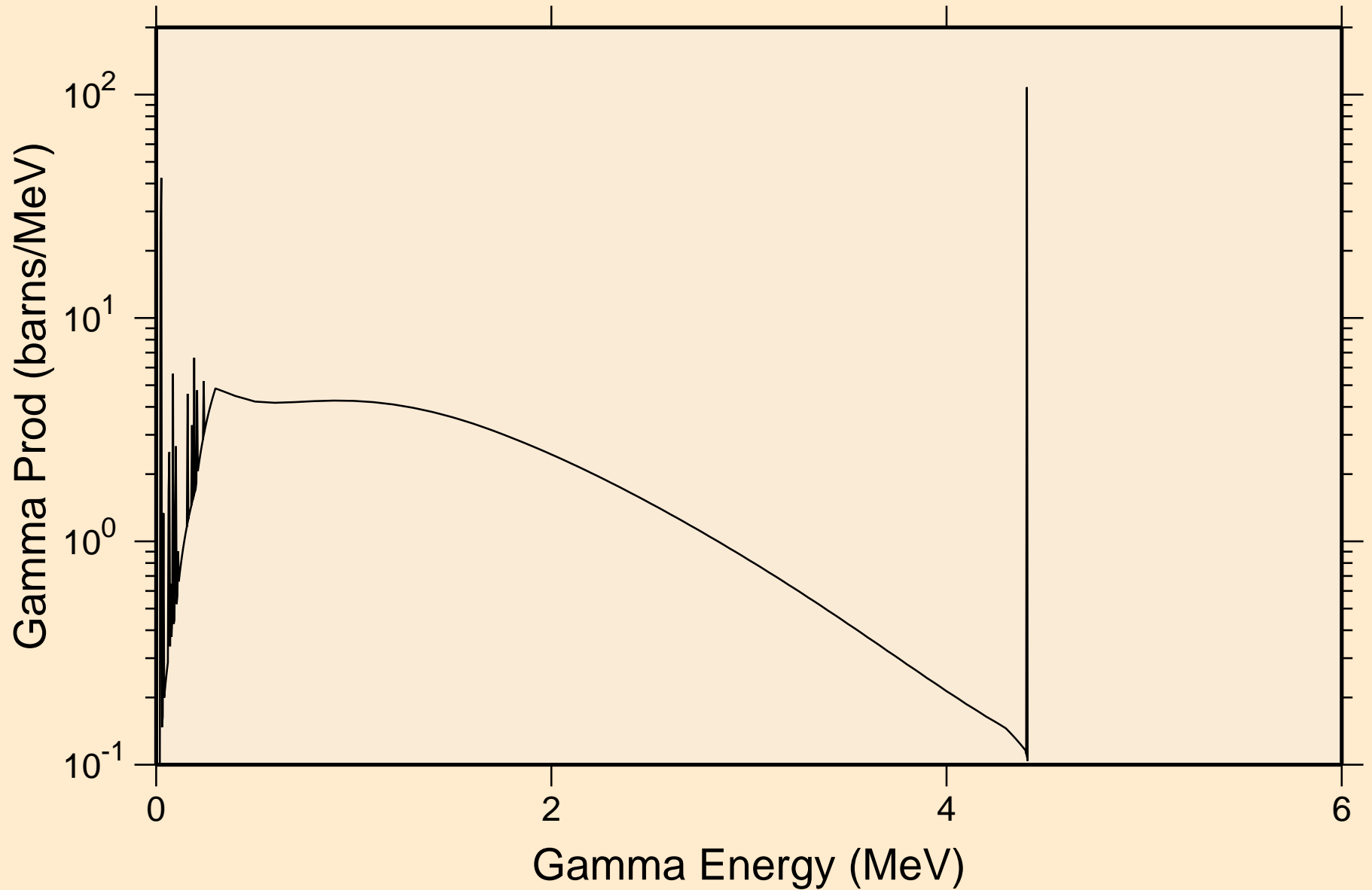

ENDF/B-VII.1 CM-248  
14 MeV photon spectrum

