

ENDF/B-VII.1 CL-37

Principal cross sections

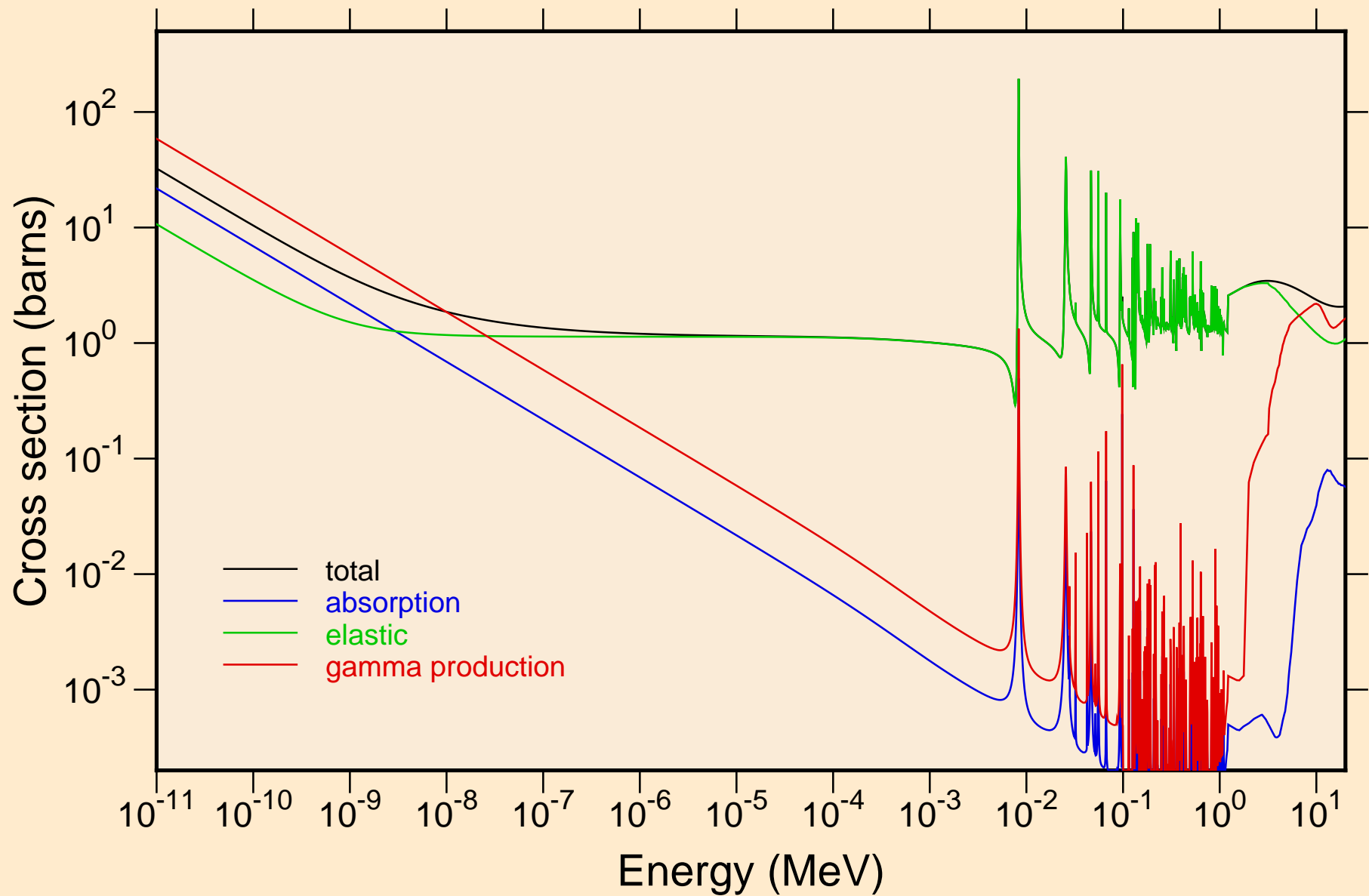

ENDF/B-VII.1 CL-37
resonance total cross section

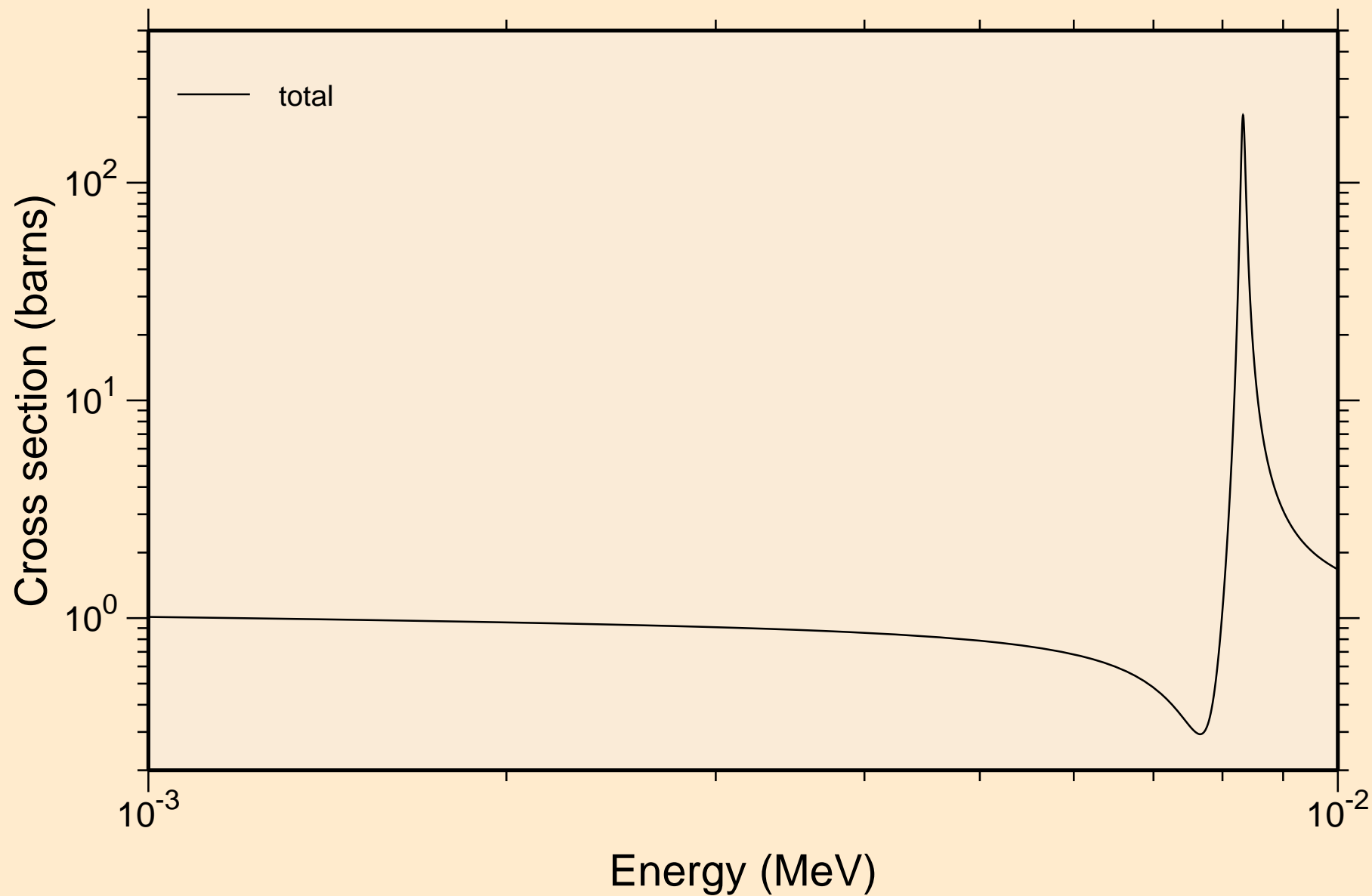

ENDF/B-VII.1 CL-37
resonance total cross section

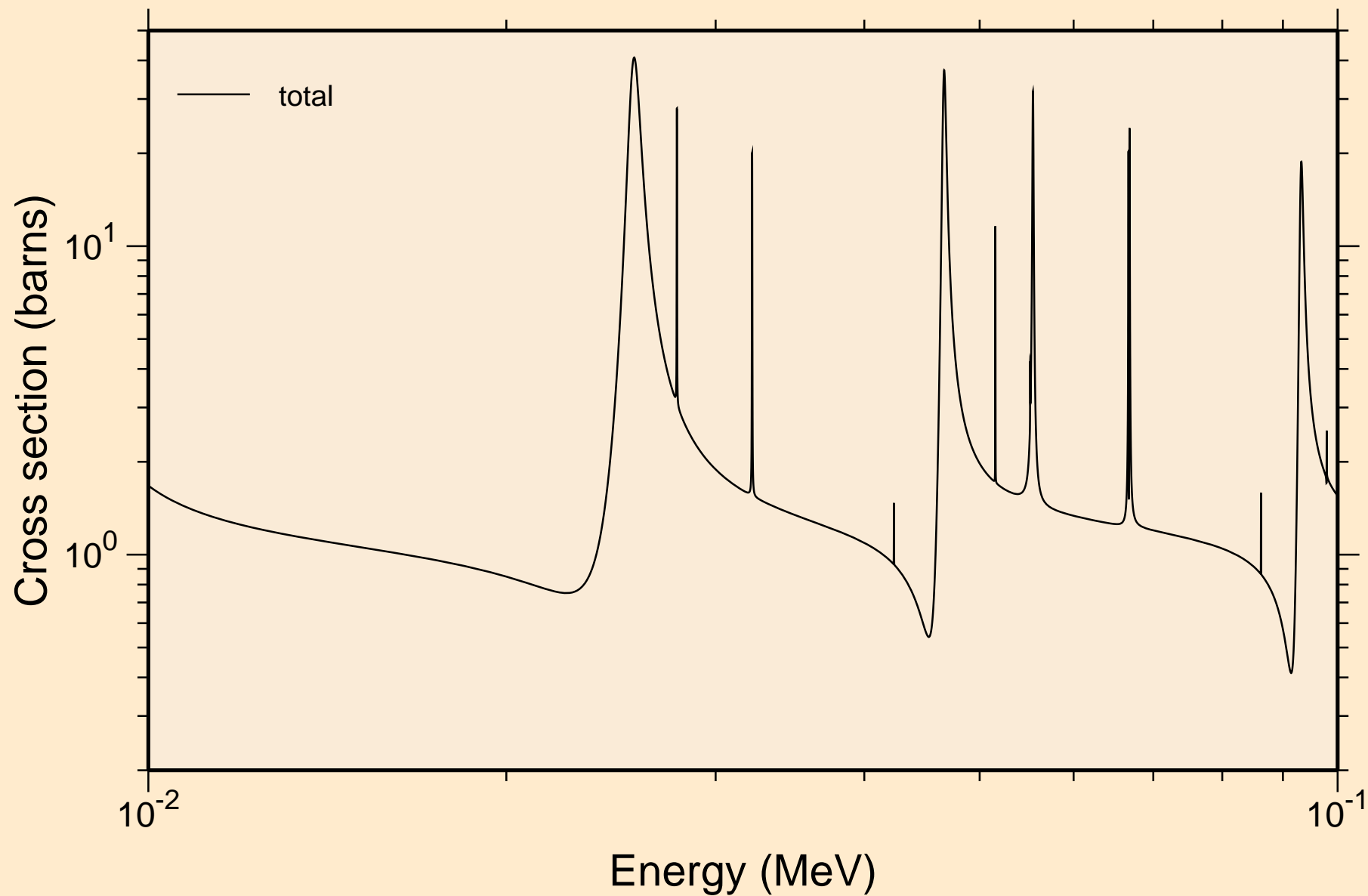

ENDF/B-VII.1 CL-37
resonance total cross section

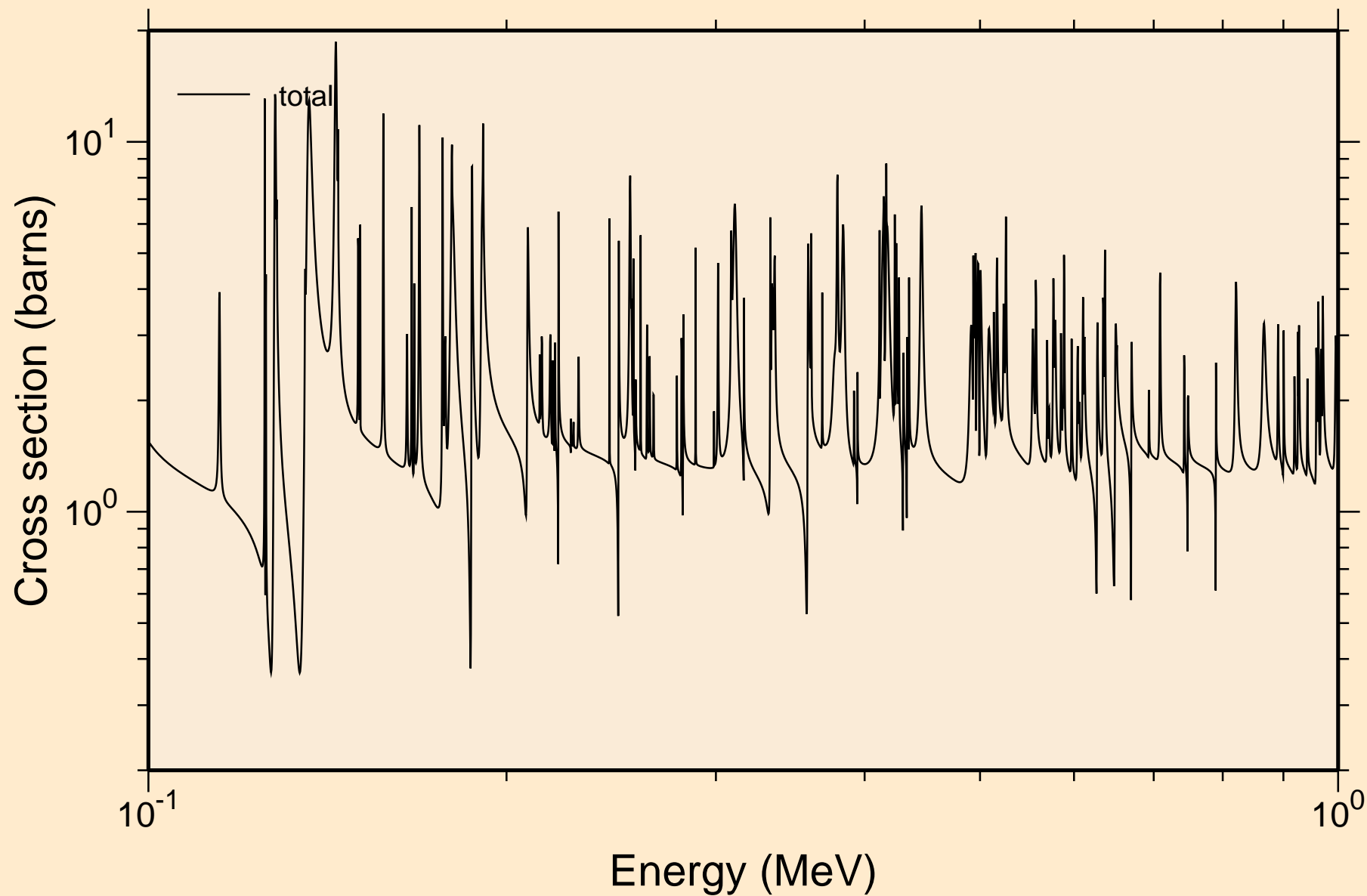

ENDF/B-VII.1 CL-37
resonance total cross section

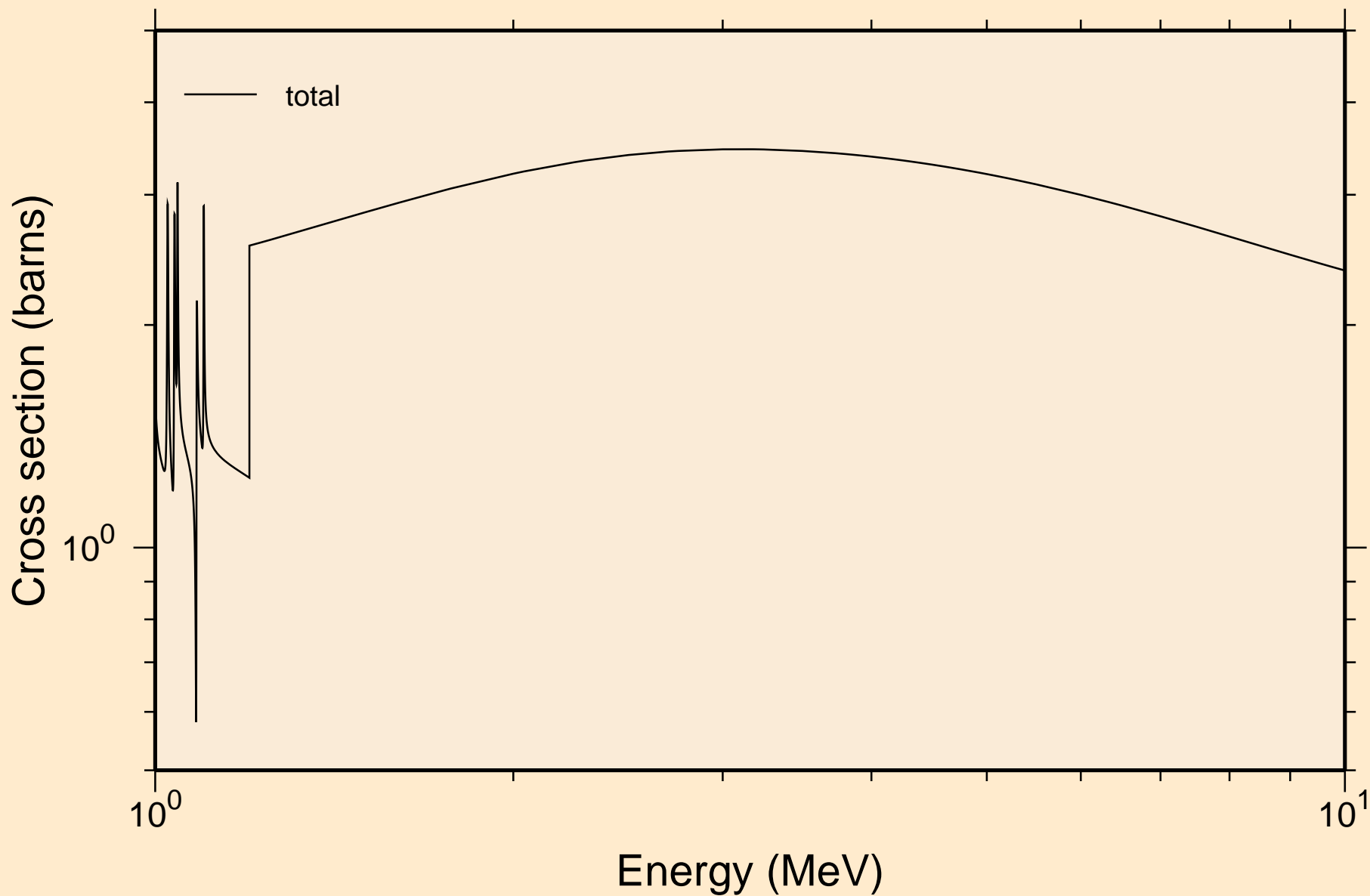

ENDF/B-VII.1 CL-37
resonance absorption cross sections

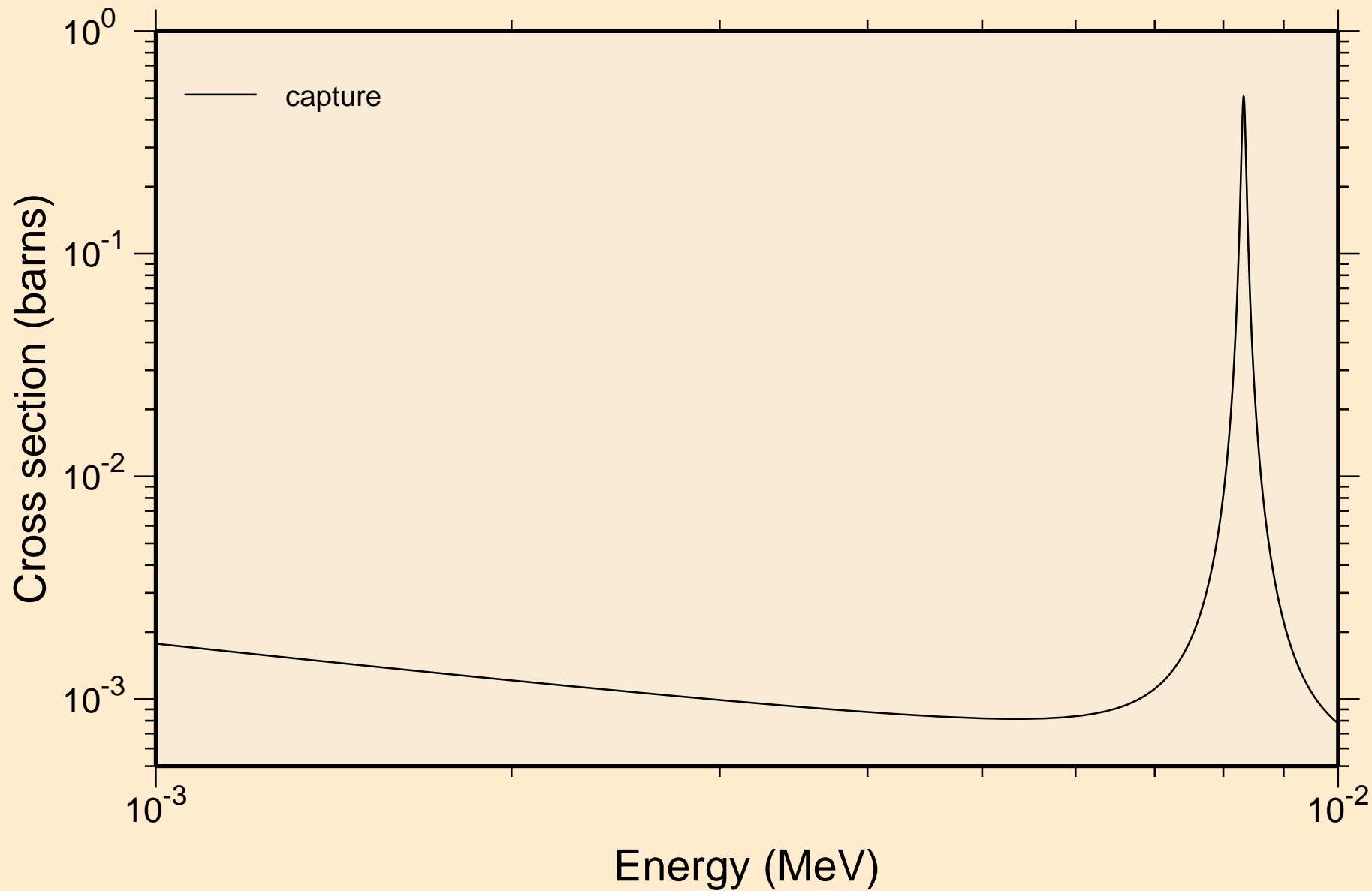

ENDF/B-VII.1 CL-37
resonance absorption cross sections

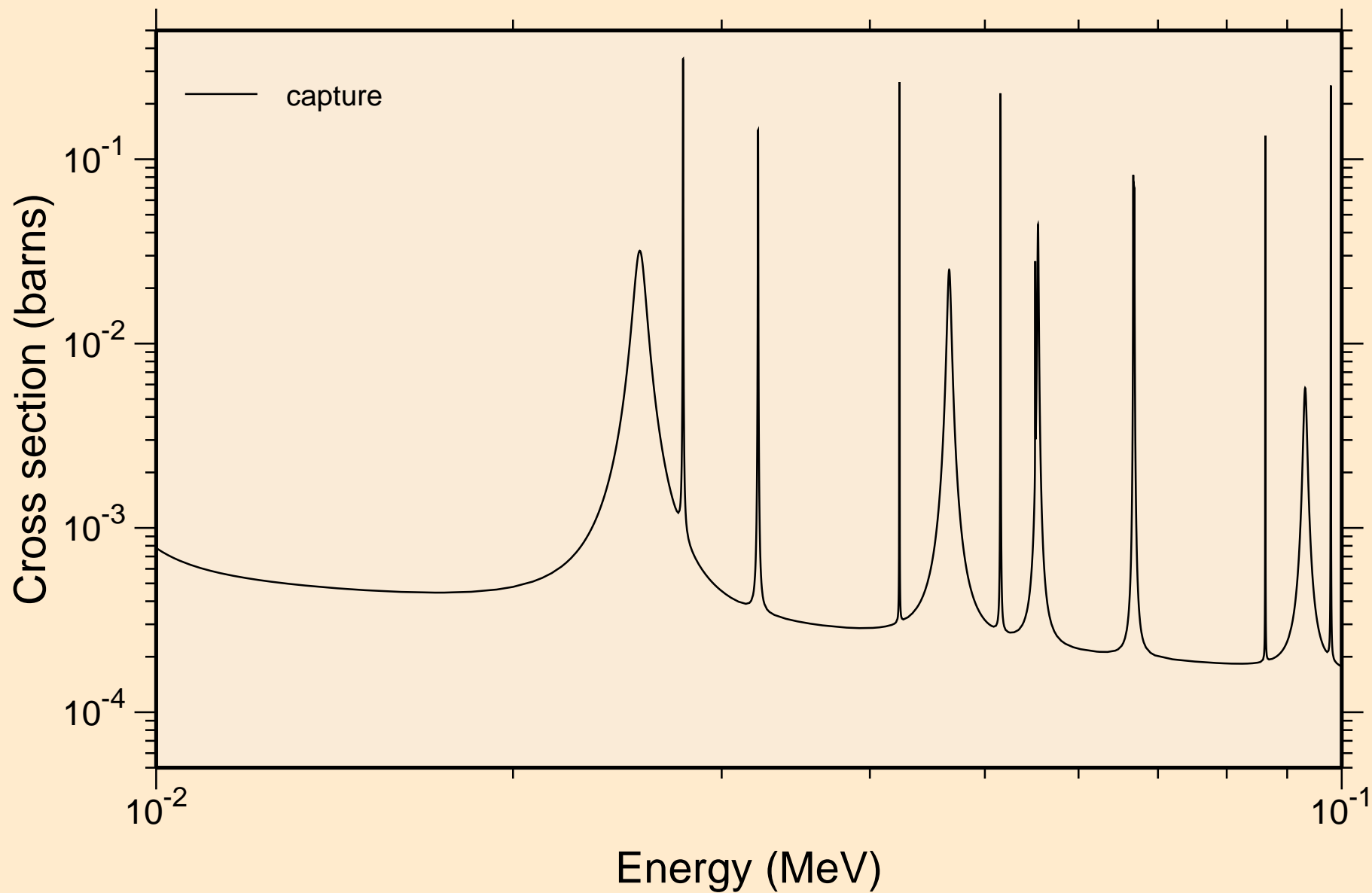

ENDF/B-VII.1 CL-37
resonance absorption cross sections

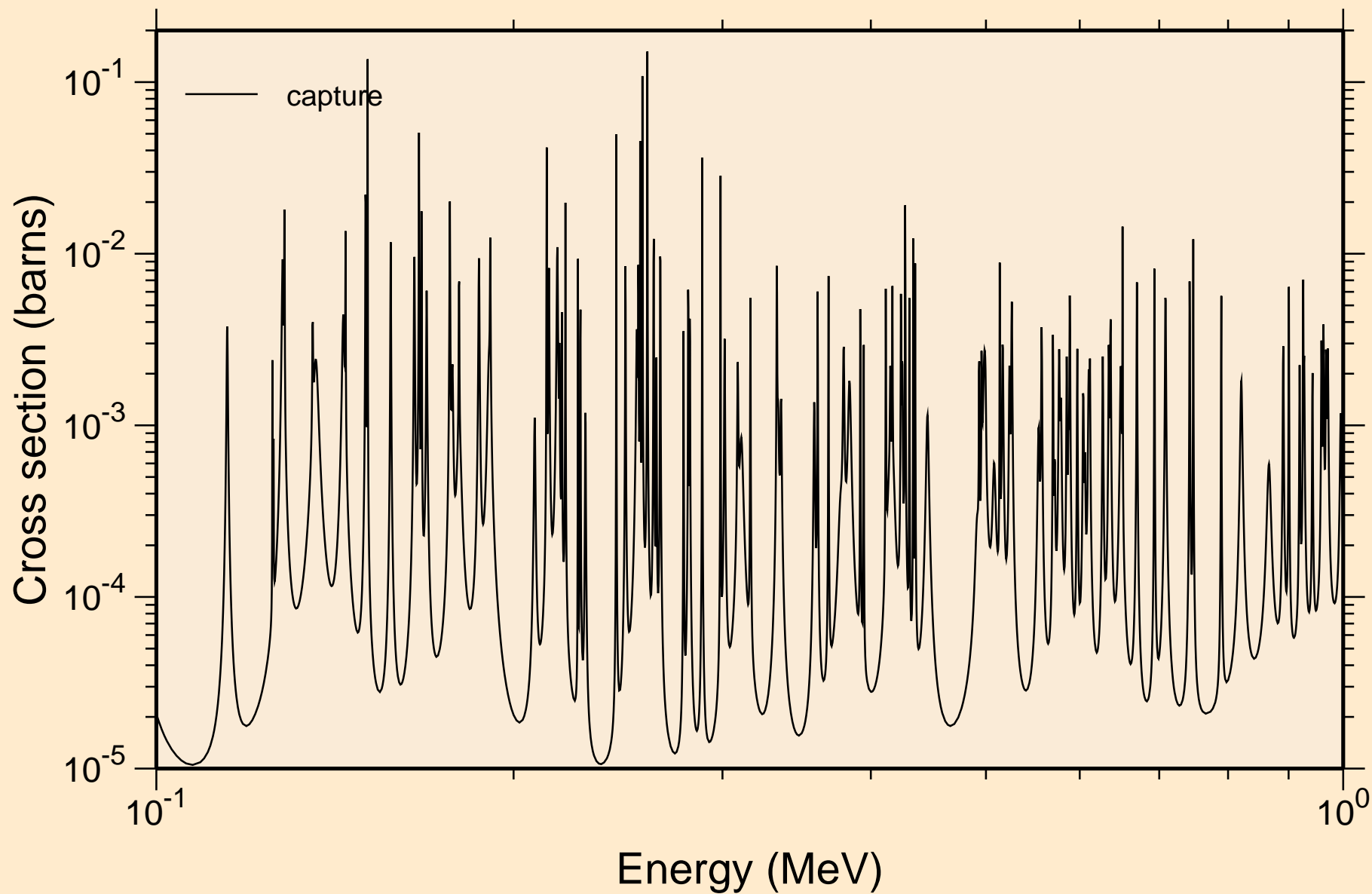

ENDF/B-VII.1 CL-37
resonance absorption cross sections

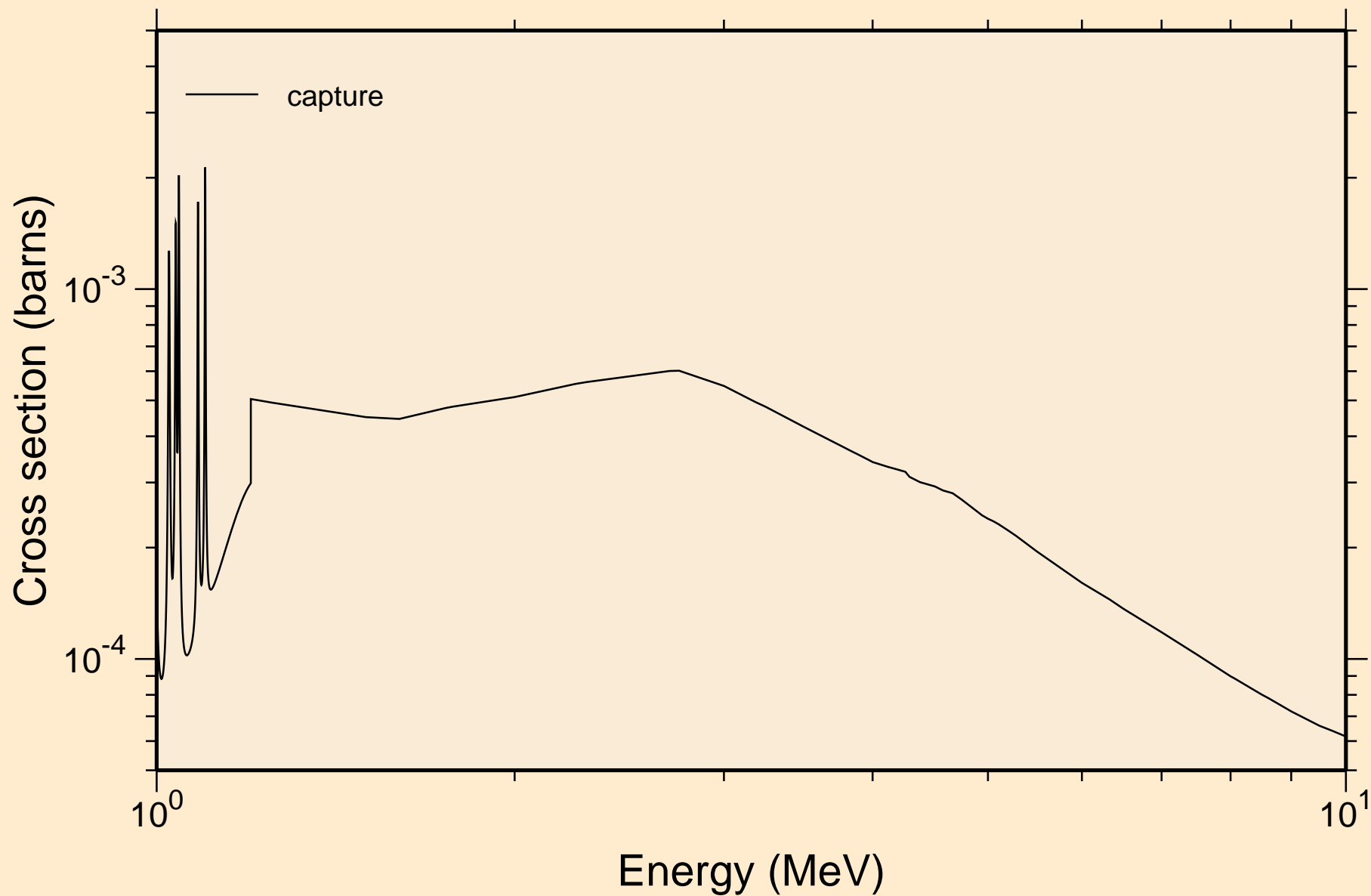

ENDF/B-VII.1 CL-37

Heating

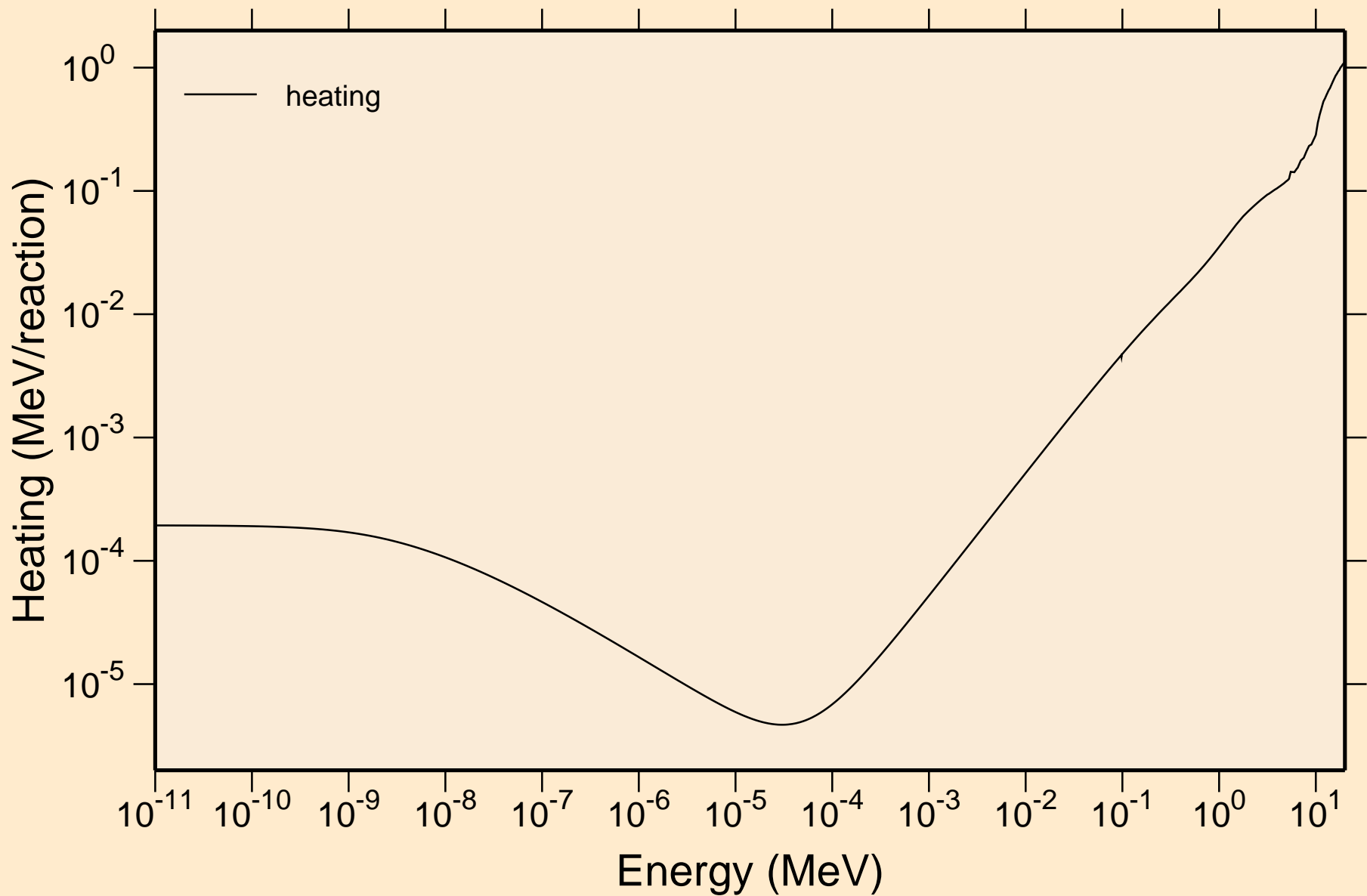

ENDF/B-VII.1 CL-37

Damage

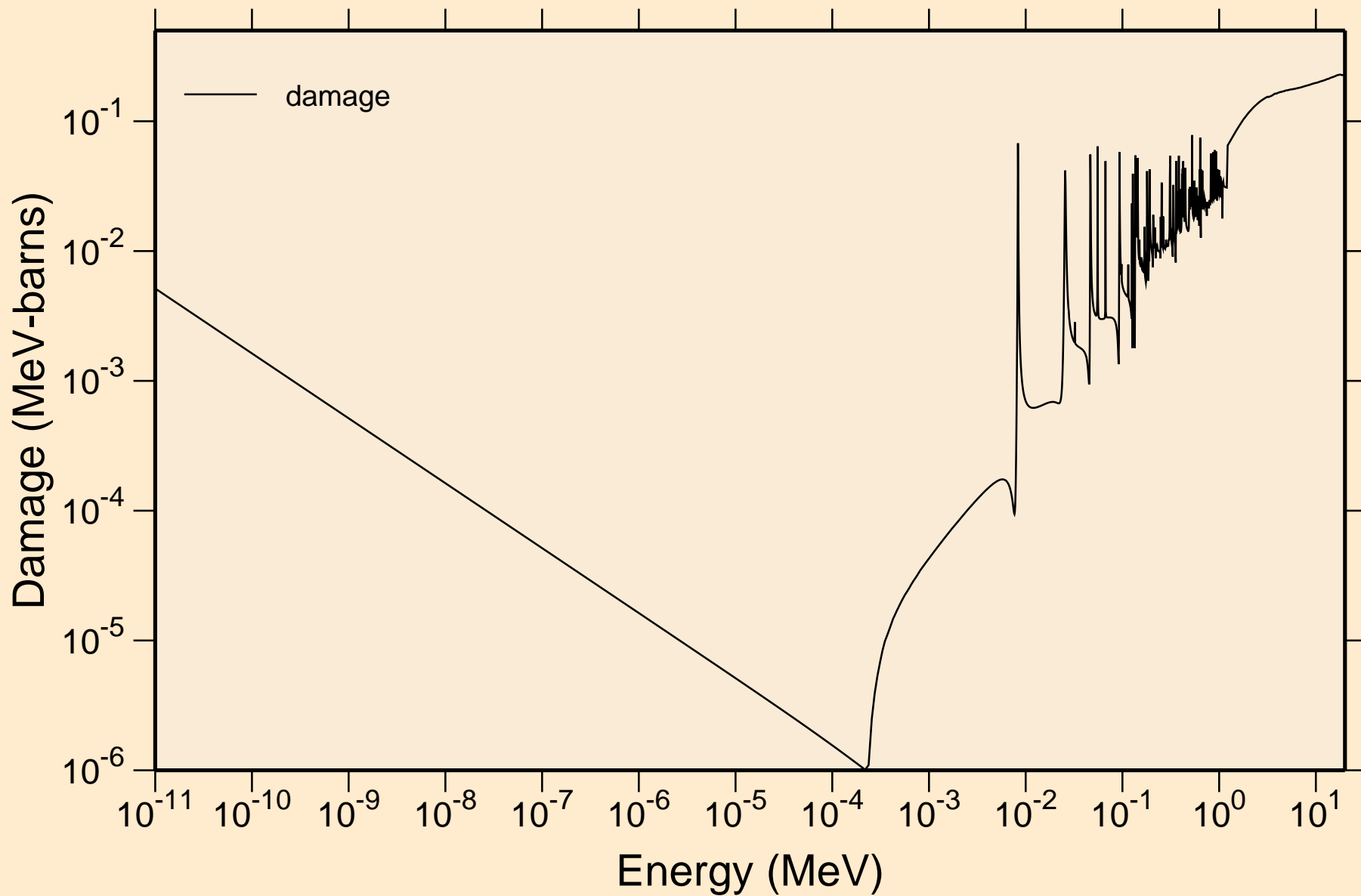

ENDF/B-VII.1 CL-37
Non-threshold reactions

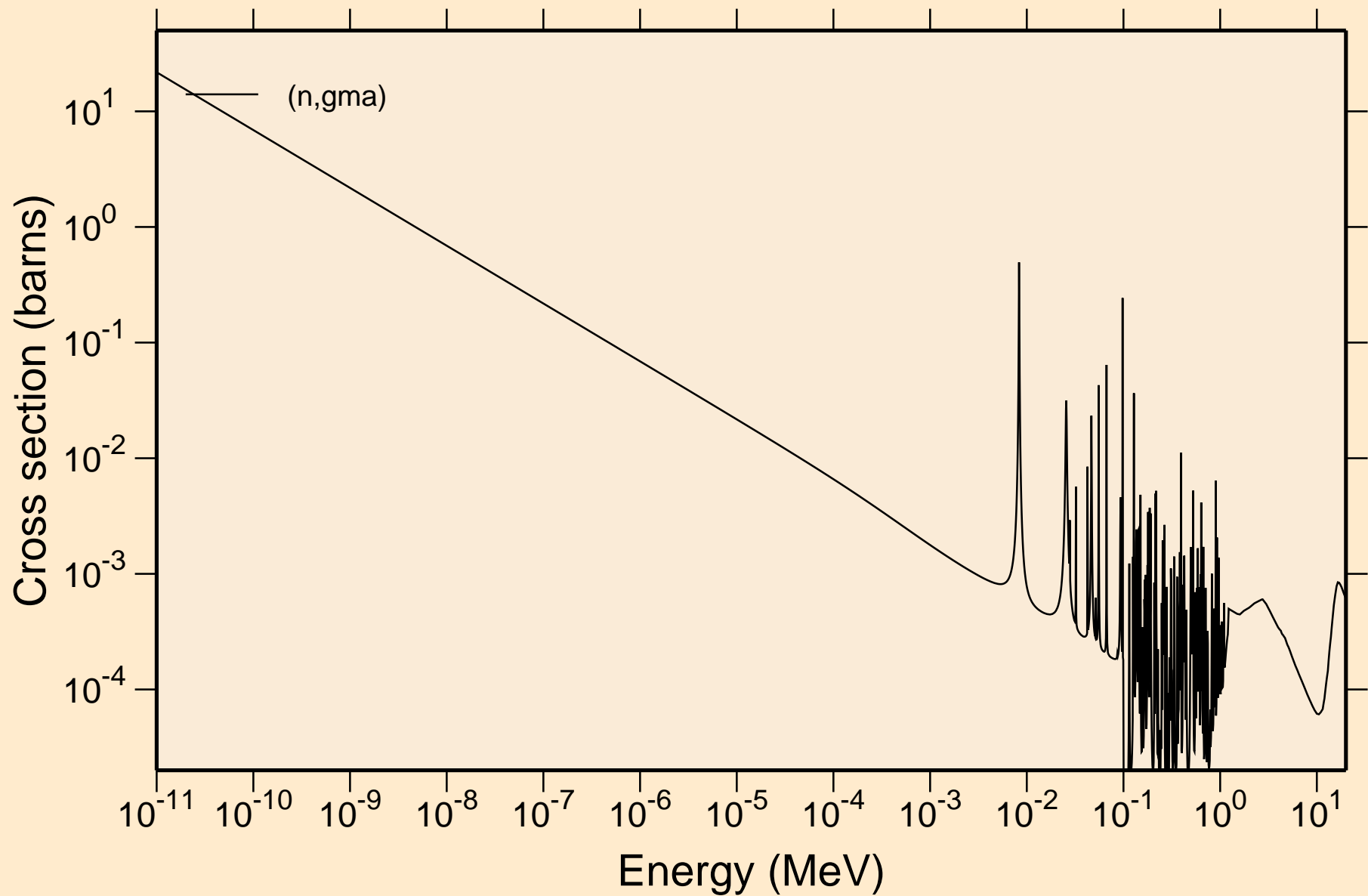

ENDF/B-VII.1 CL-37

Principal cross sections

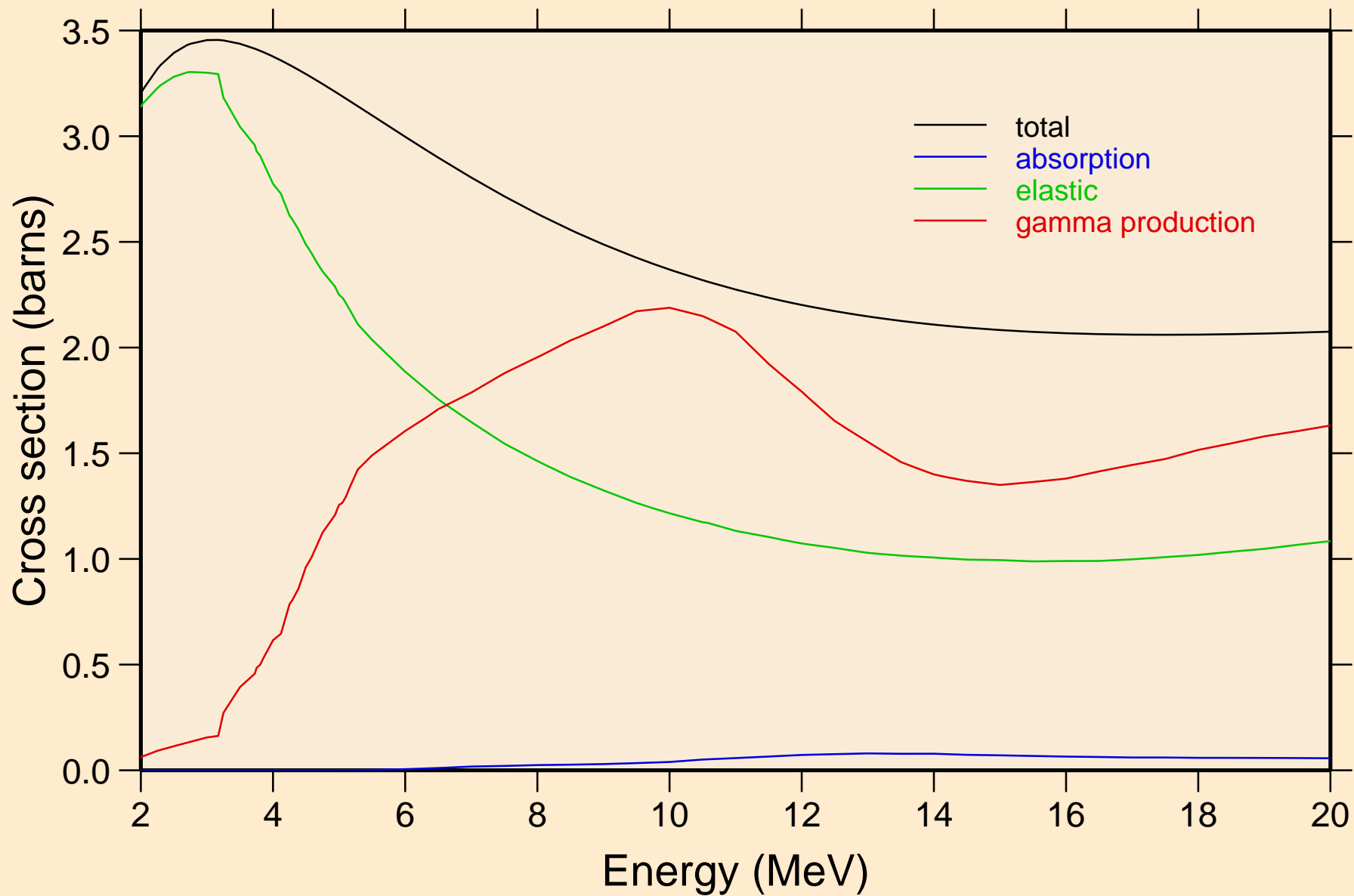

ENDF/B-VII.1 CL-37

Heating

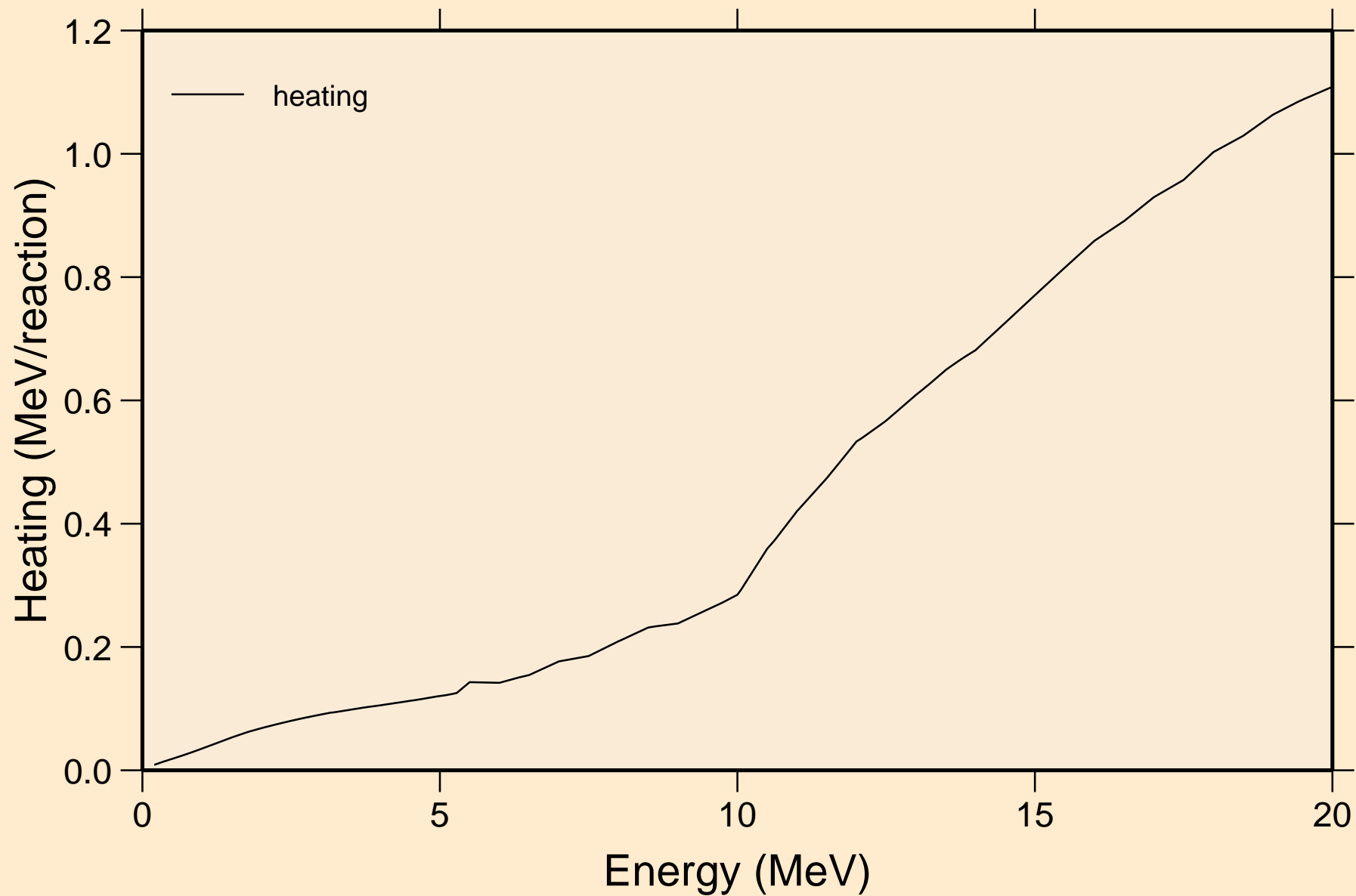

ENDF/B-VII.1 CL-37

Damage

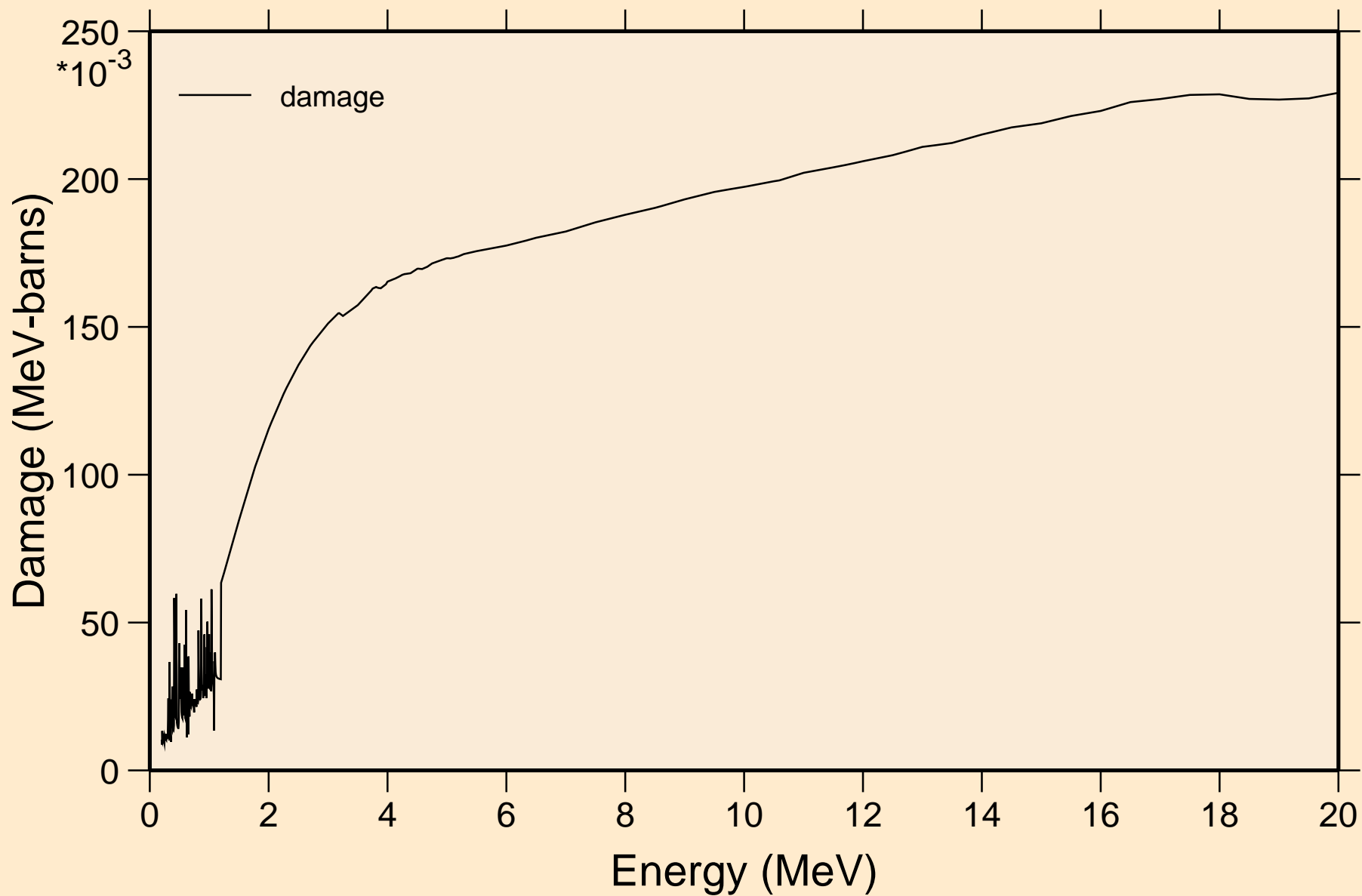

ENDF/B-VII.1 CL-37
Non-threshold reactions

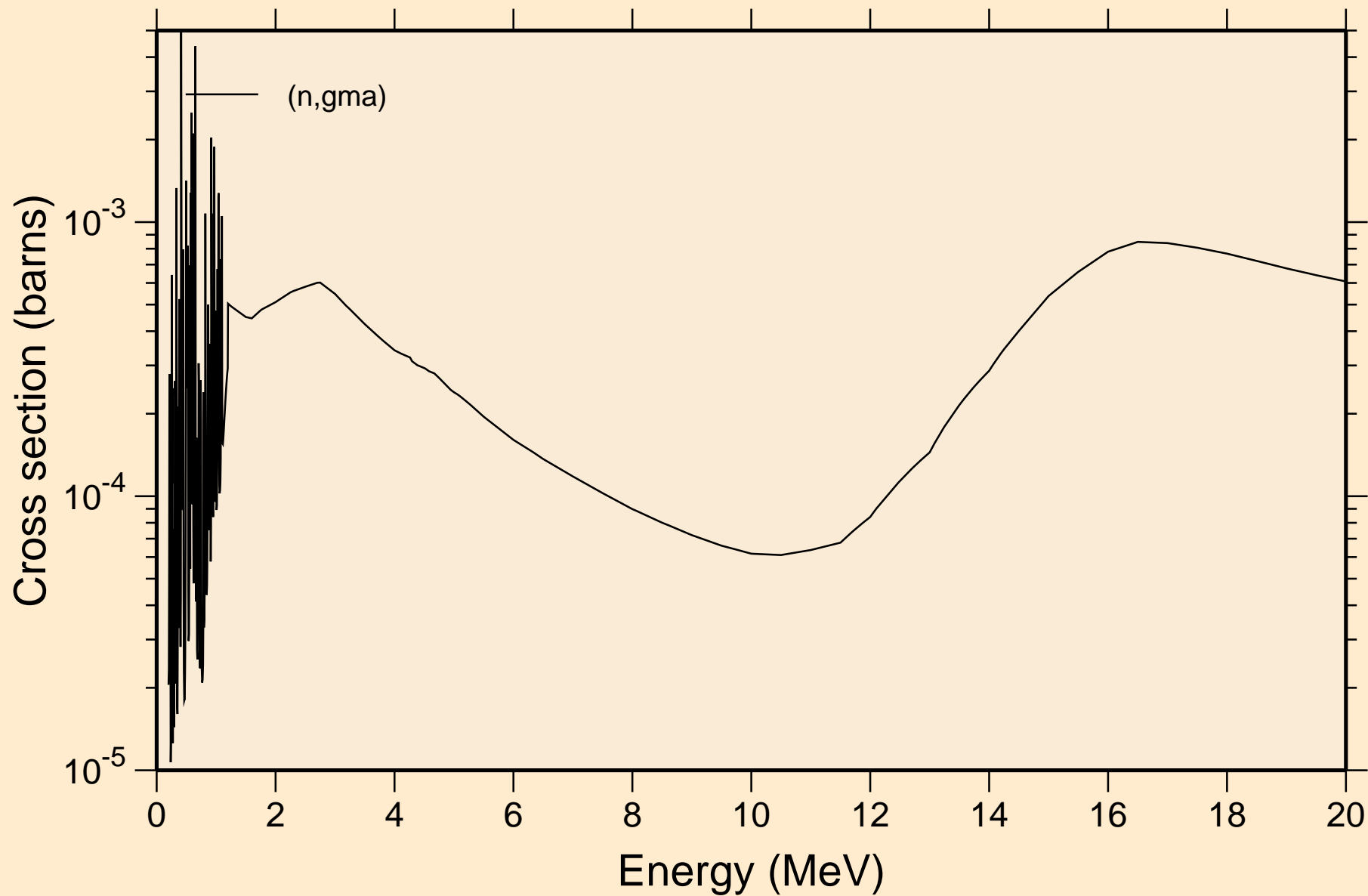

ENDF/B-VII.1 CL-37

Inelastic levels

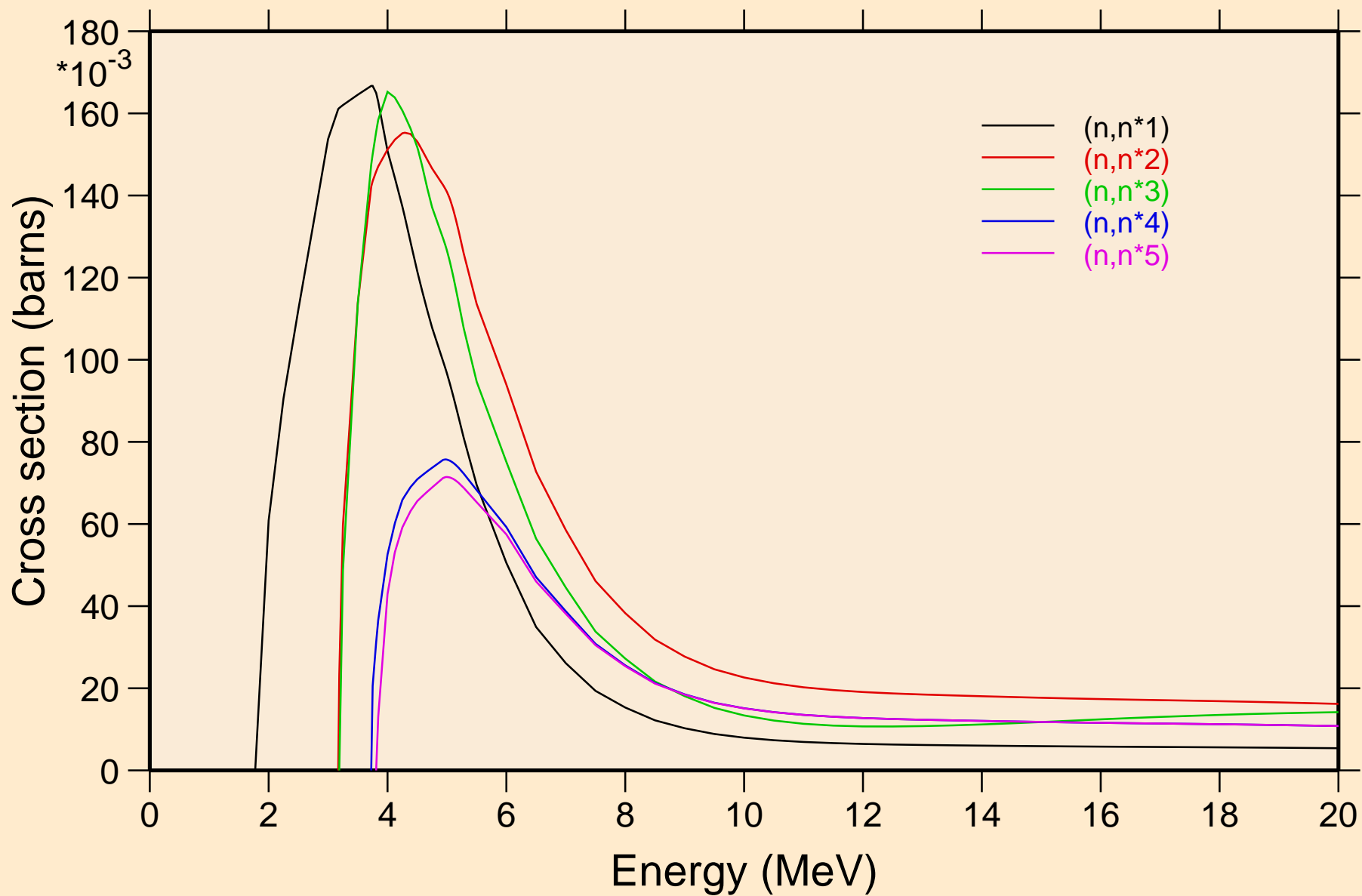

ENDF/B-VII.1 CL-37

Inelastic levels

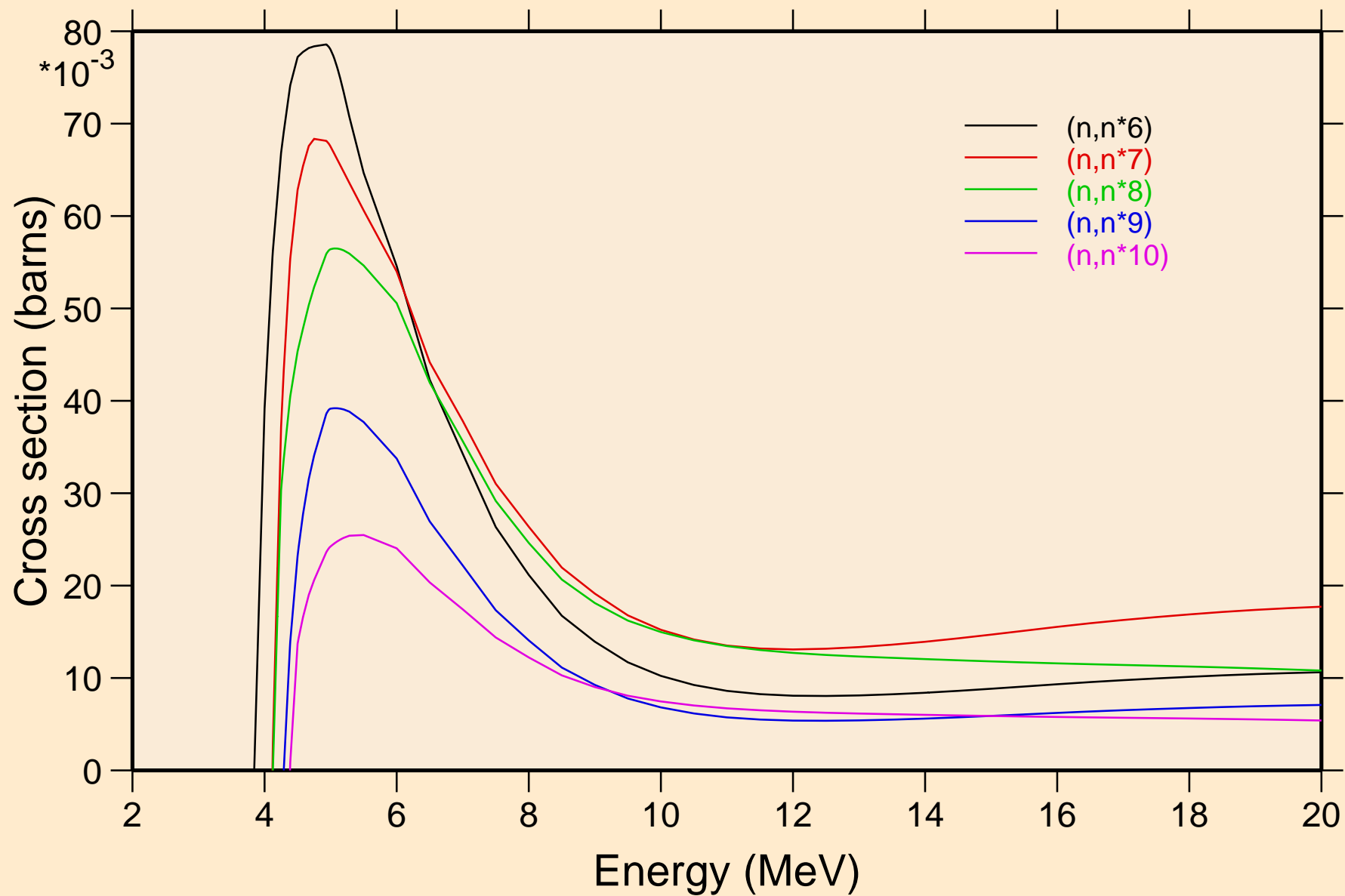

ENDF/B-VII.1 CL-37

Inelastic levels

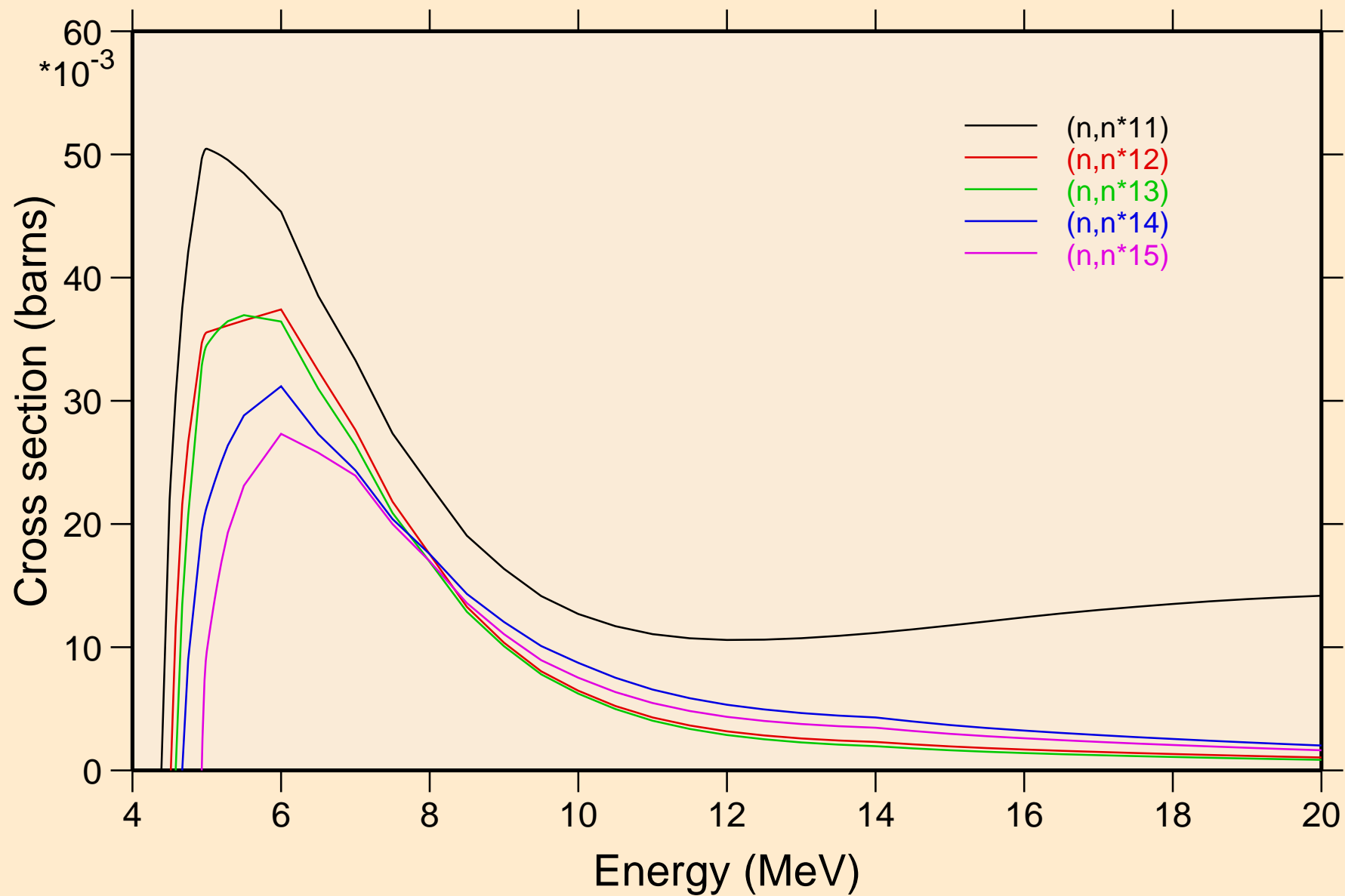

ENDF/B-VII.1 CL-37

Inelastic levels

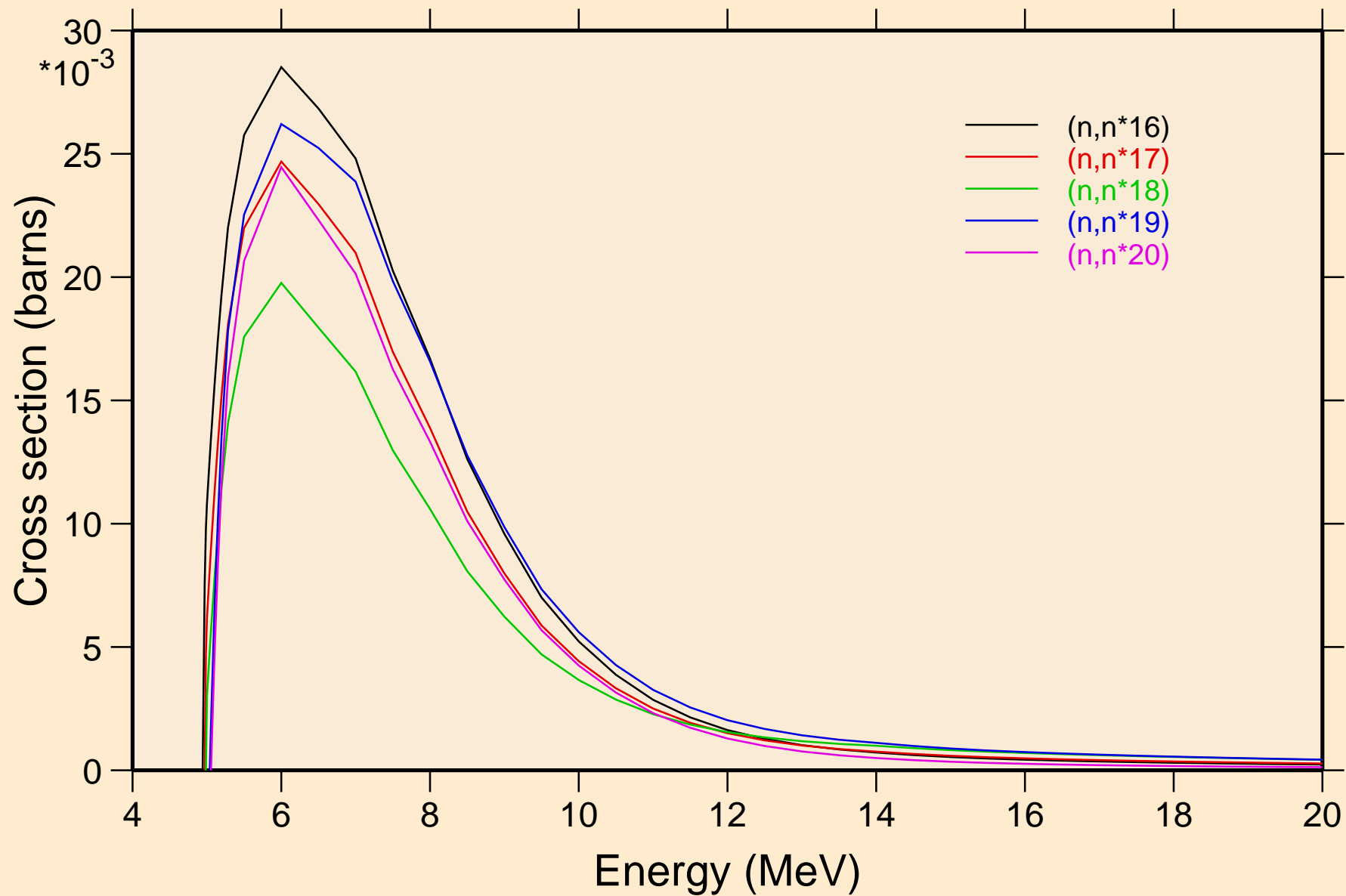

ENDF/B-VII.1 CL-37

Inelastic levels

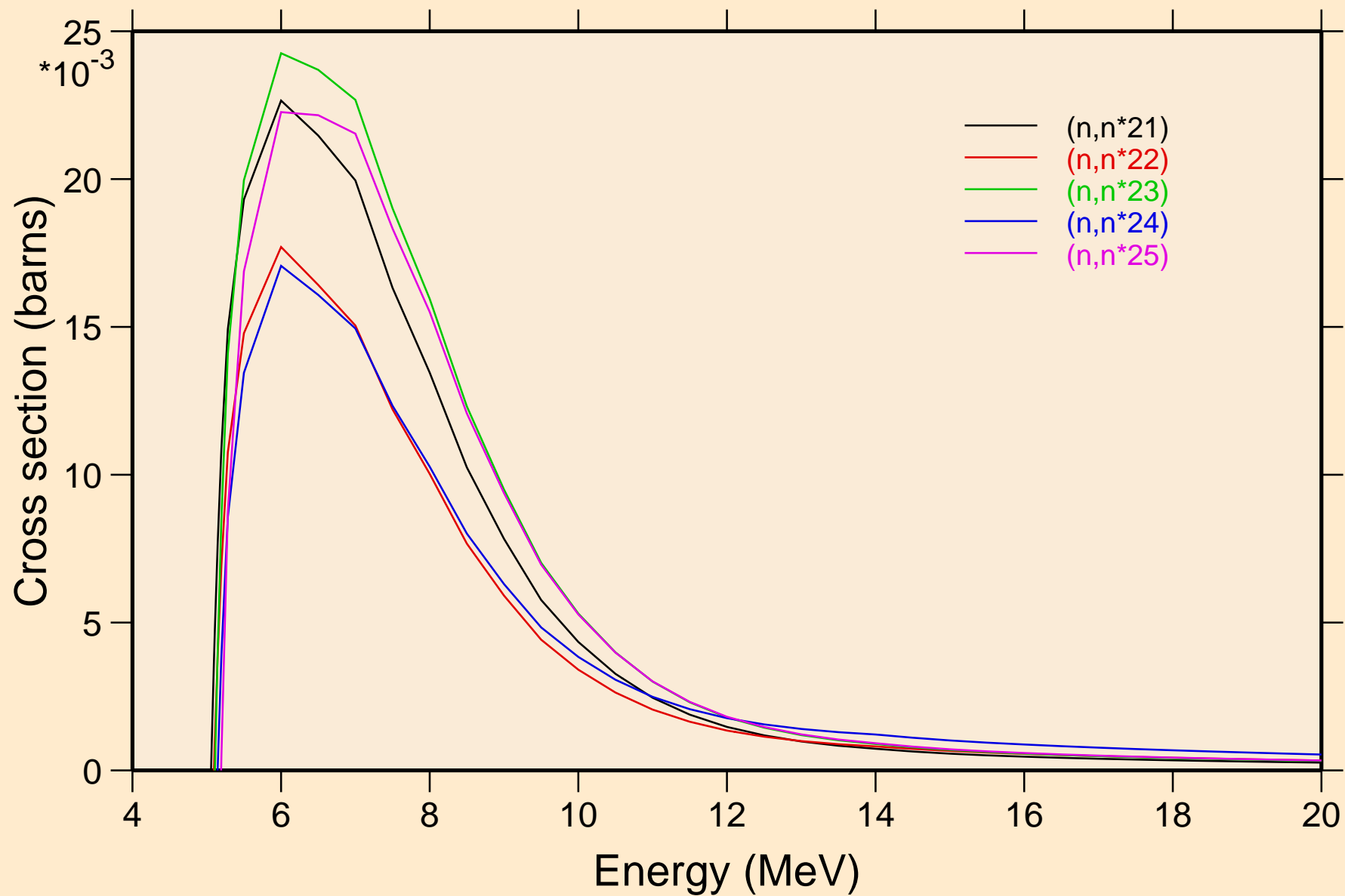

ENDF/B-VII.1 CL-37

Inelastic levels

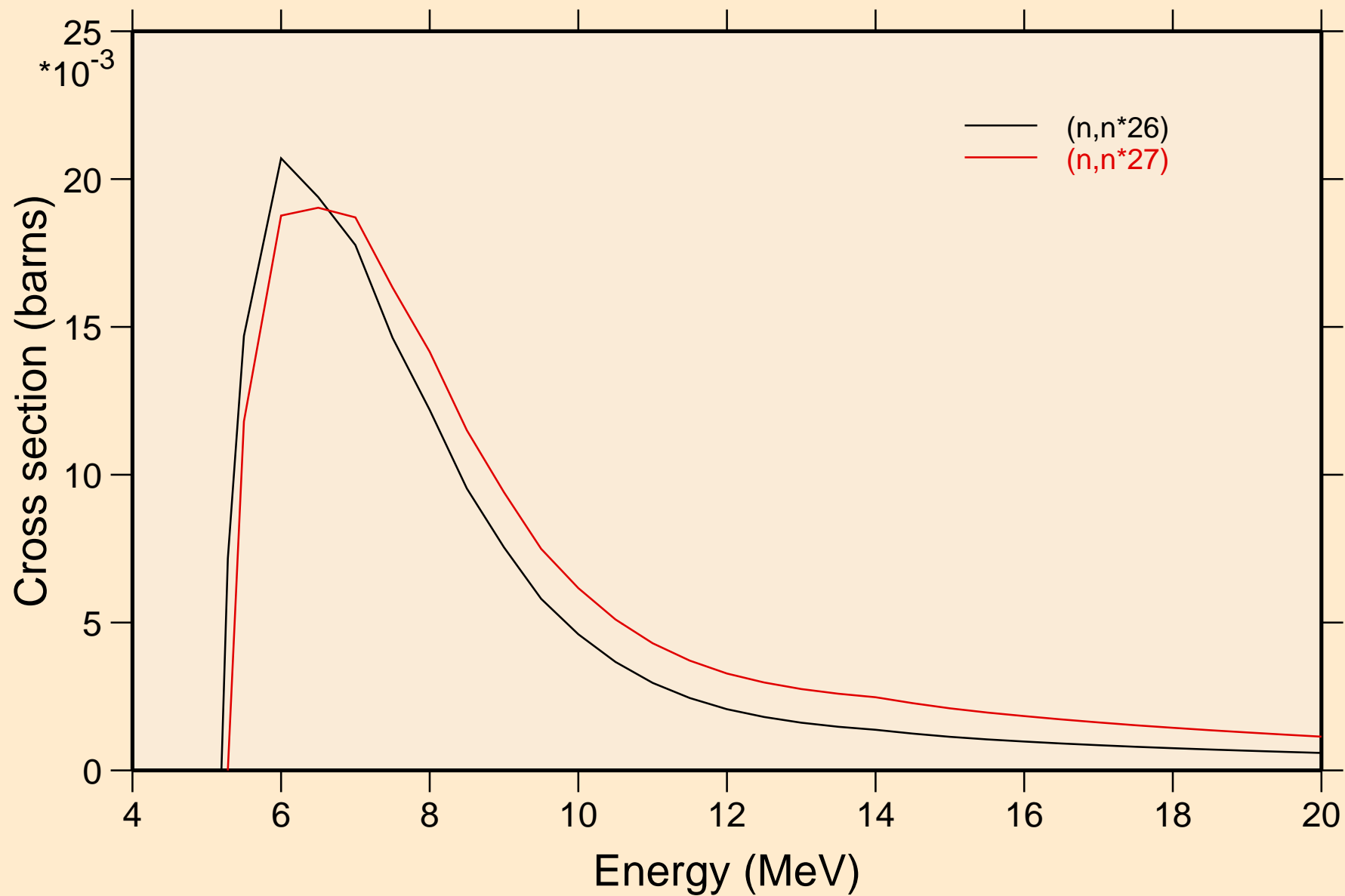

ENDF/B-VII.1 CL-37

Threshold reactions

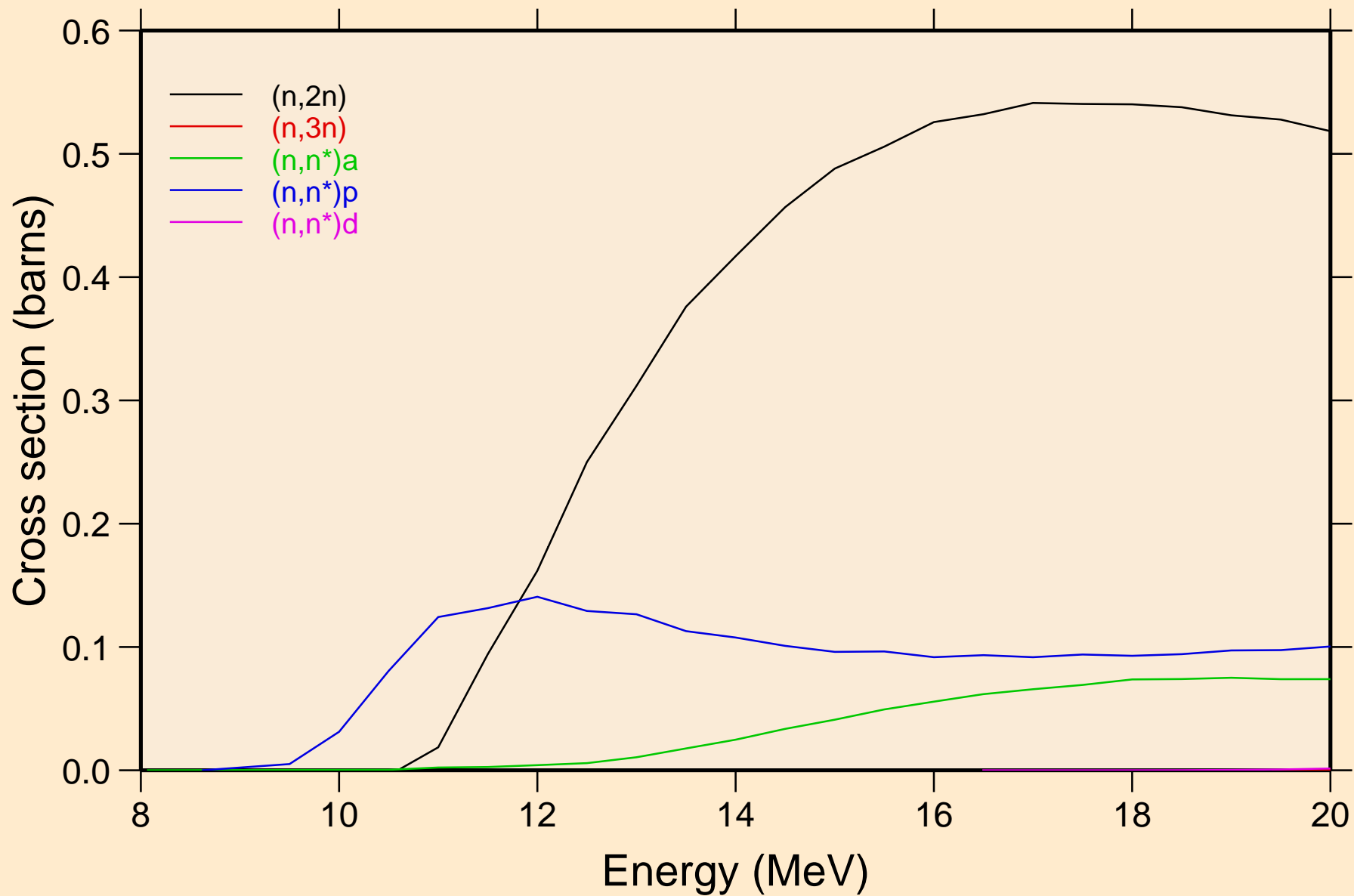

ENDF/B-VII.1 CL-37

Threshold reactions

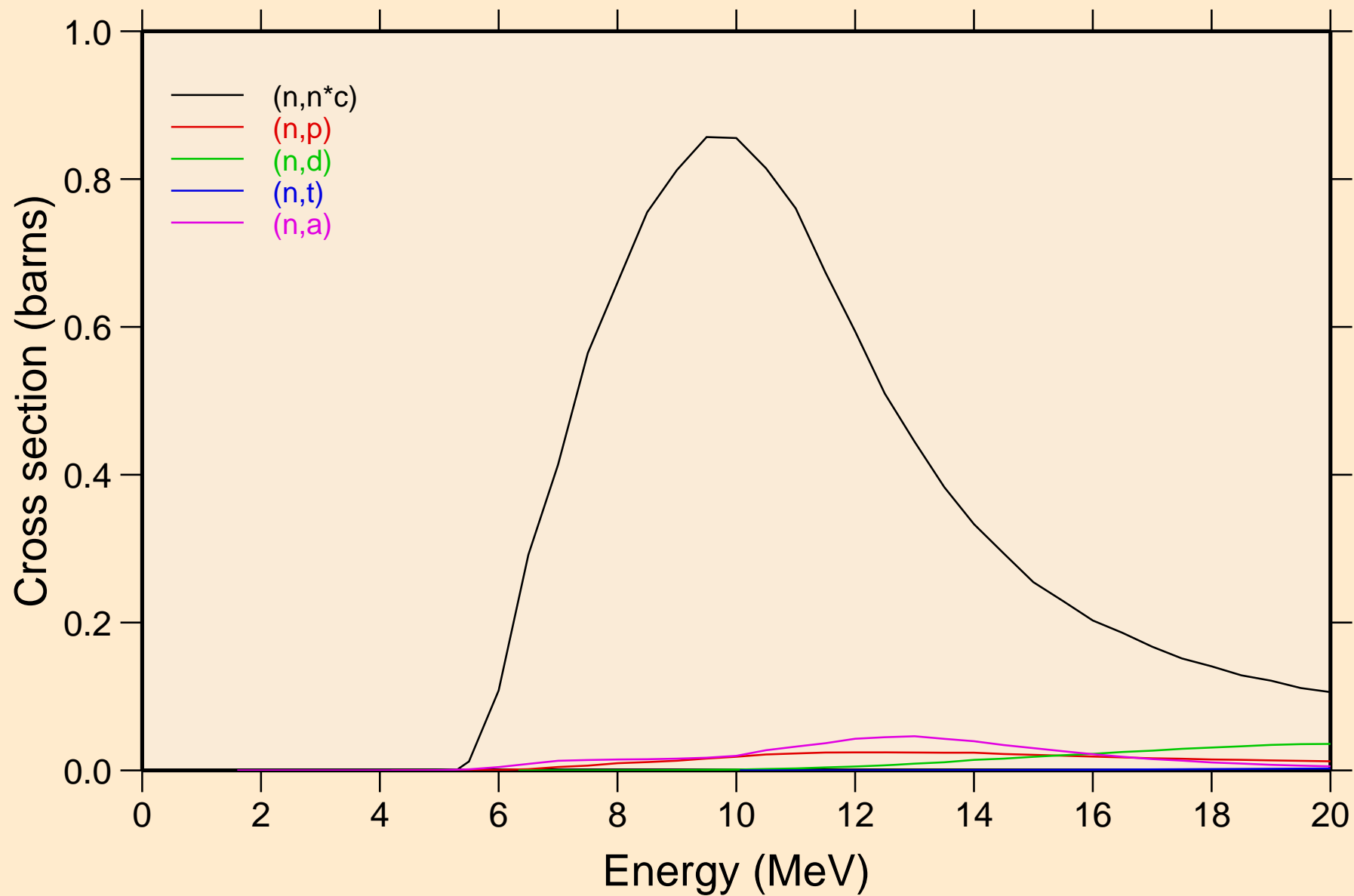

ENDF/B-VII.1 CL-37

Threshold reactions

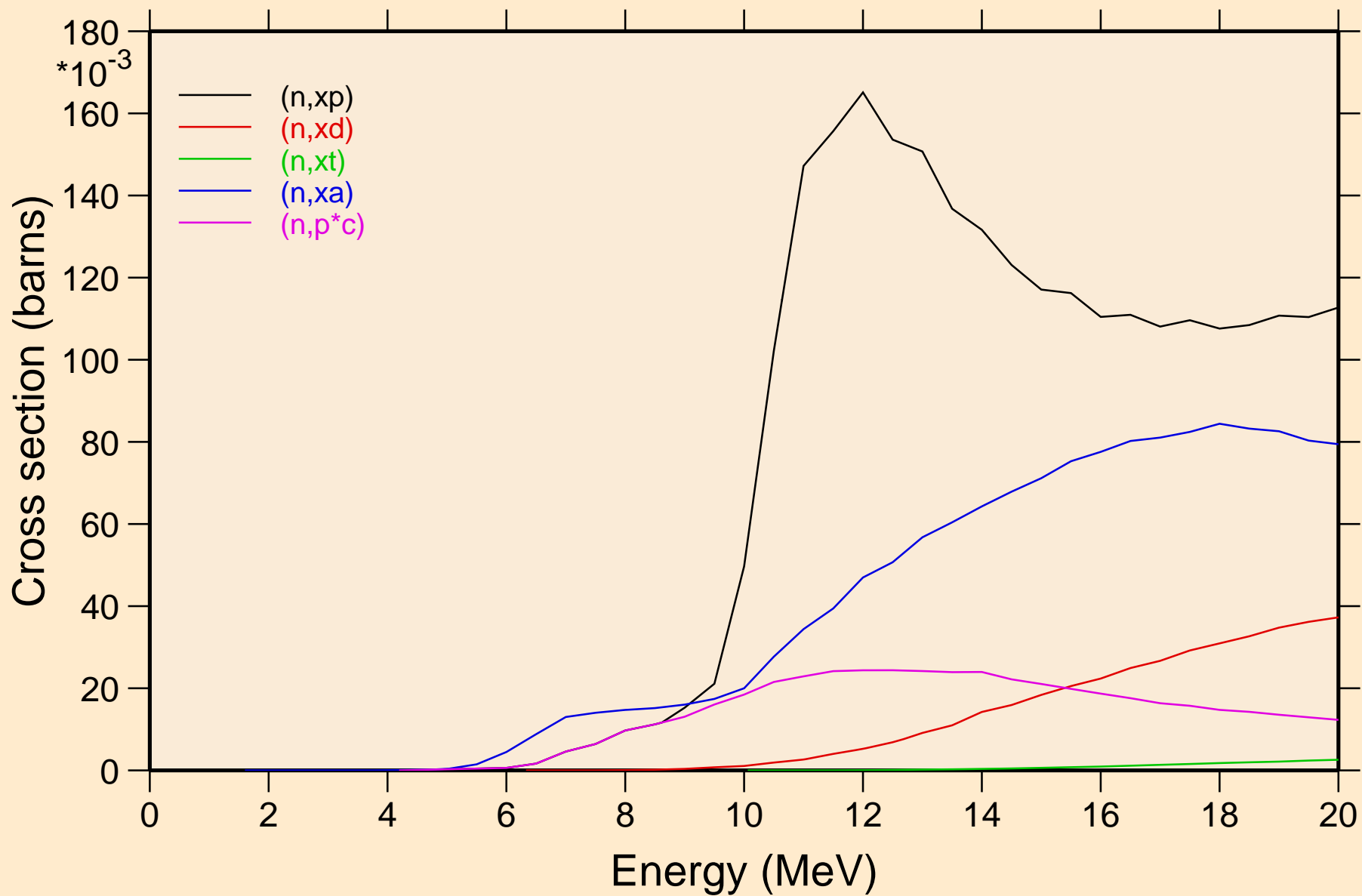

ENDF/B-VII.1 CL-37

Threshold reactions

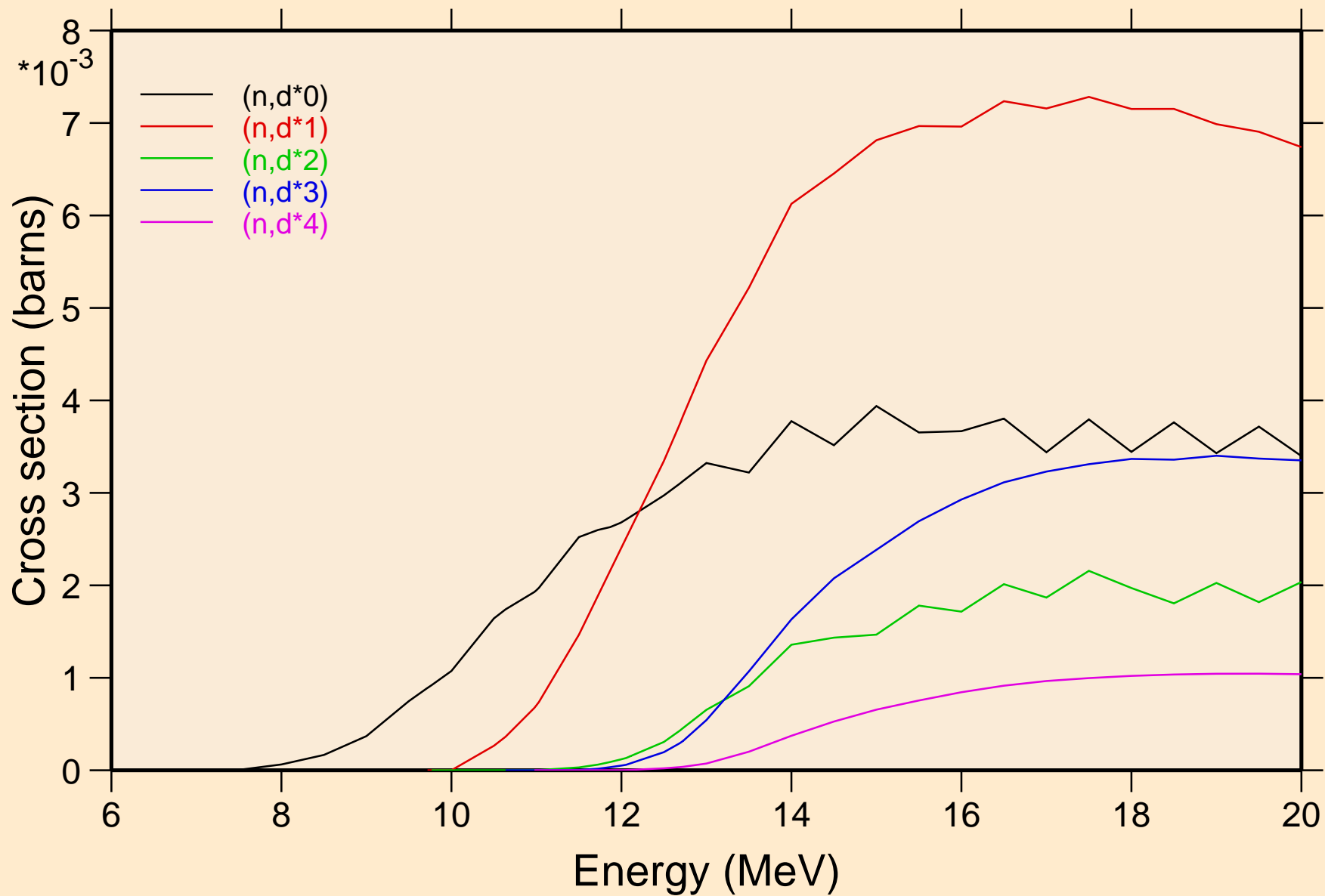

ENDF/B-VII.1 CL-37

Threshold reactions

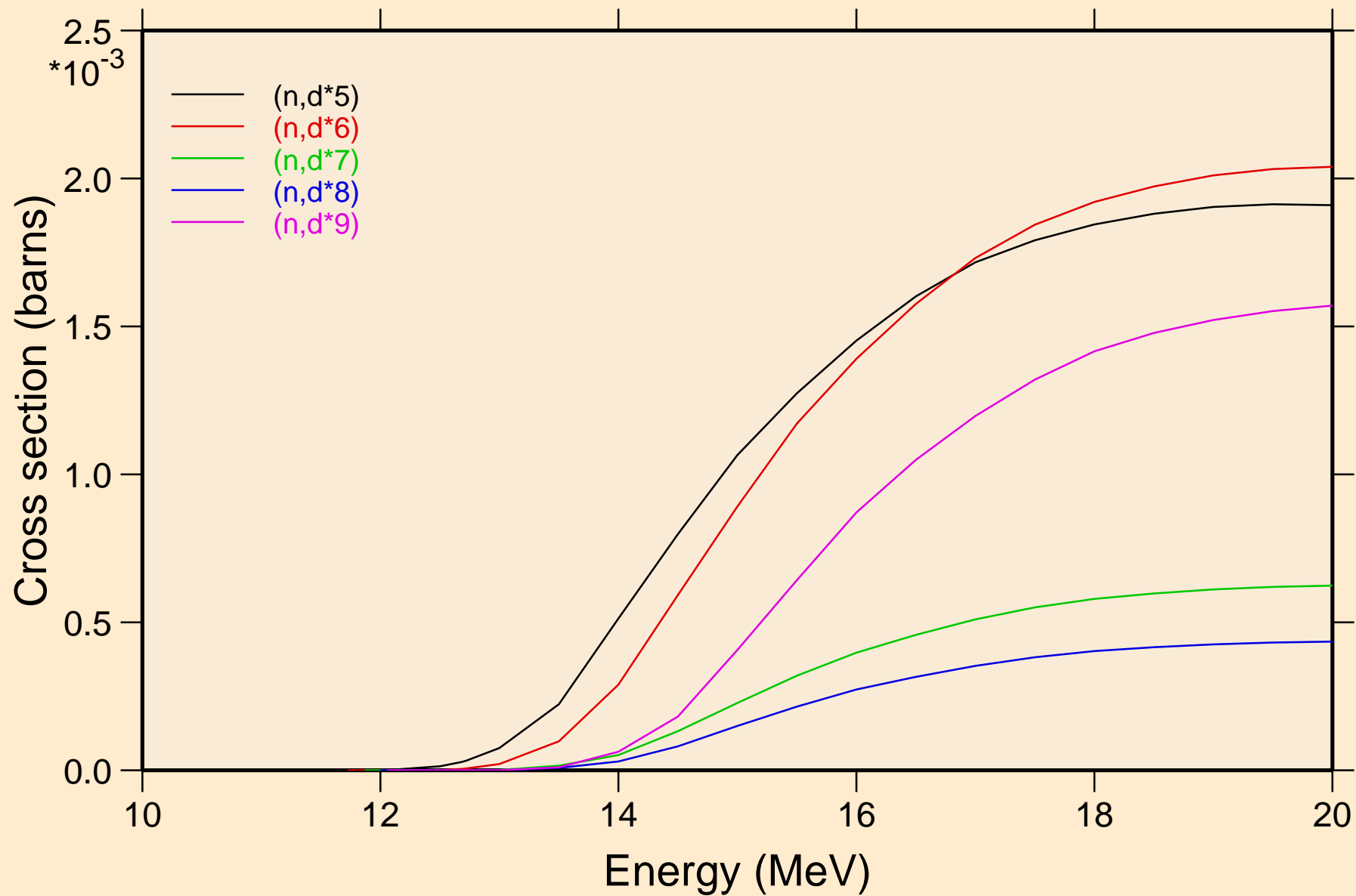

ENDF/B-VII.1 CL-37

Threshold reactions

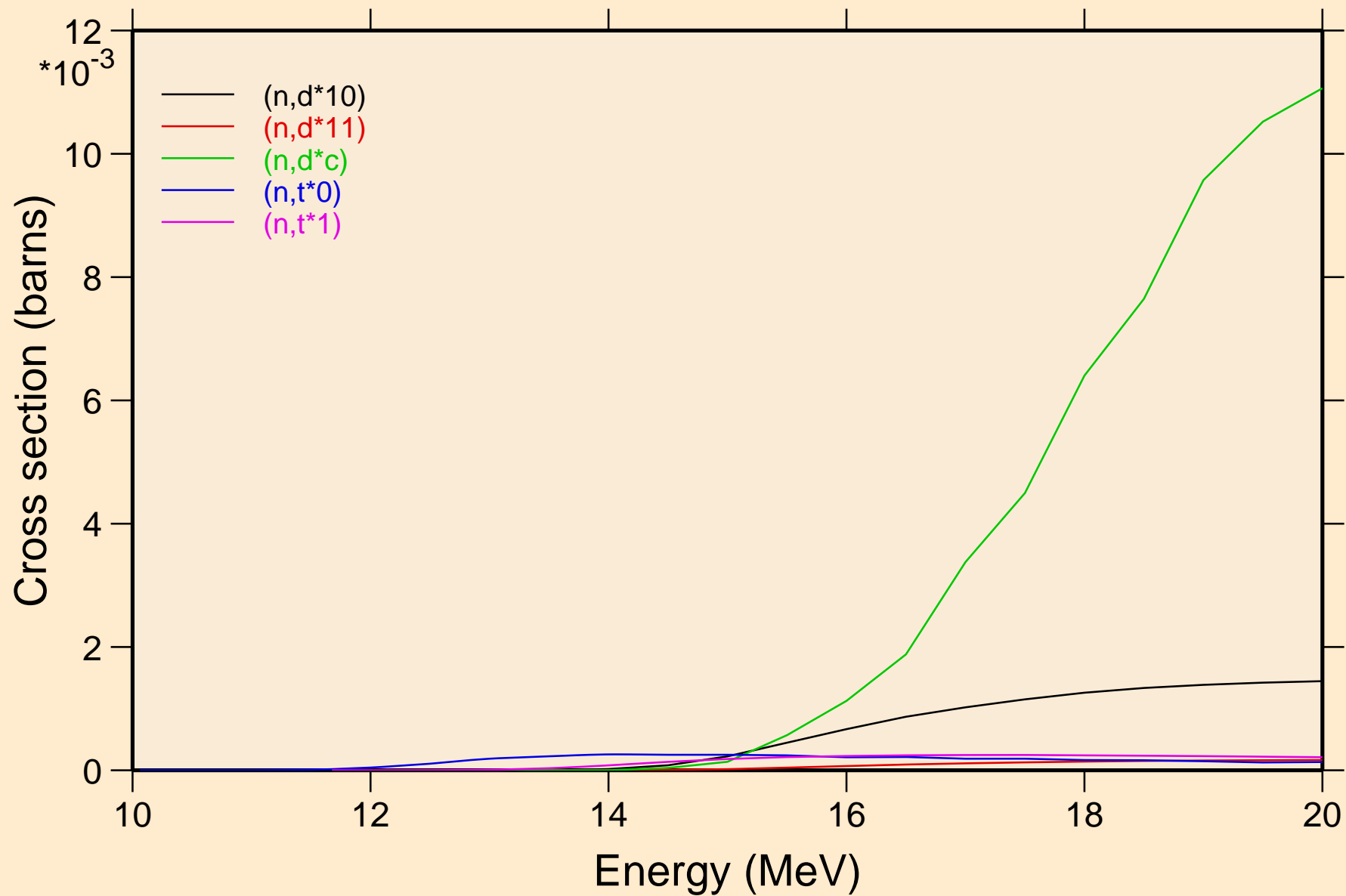

ENDF/B-VII.1 CL-37

Threshold reactions

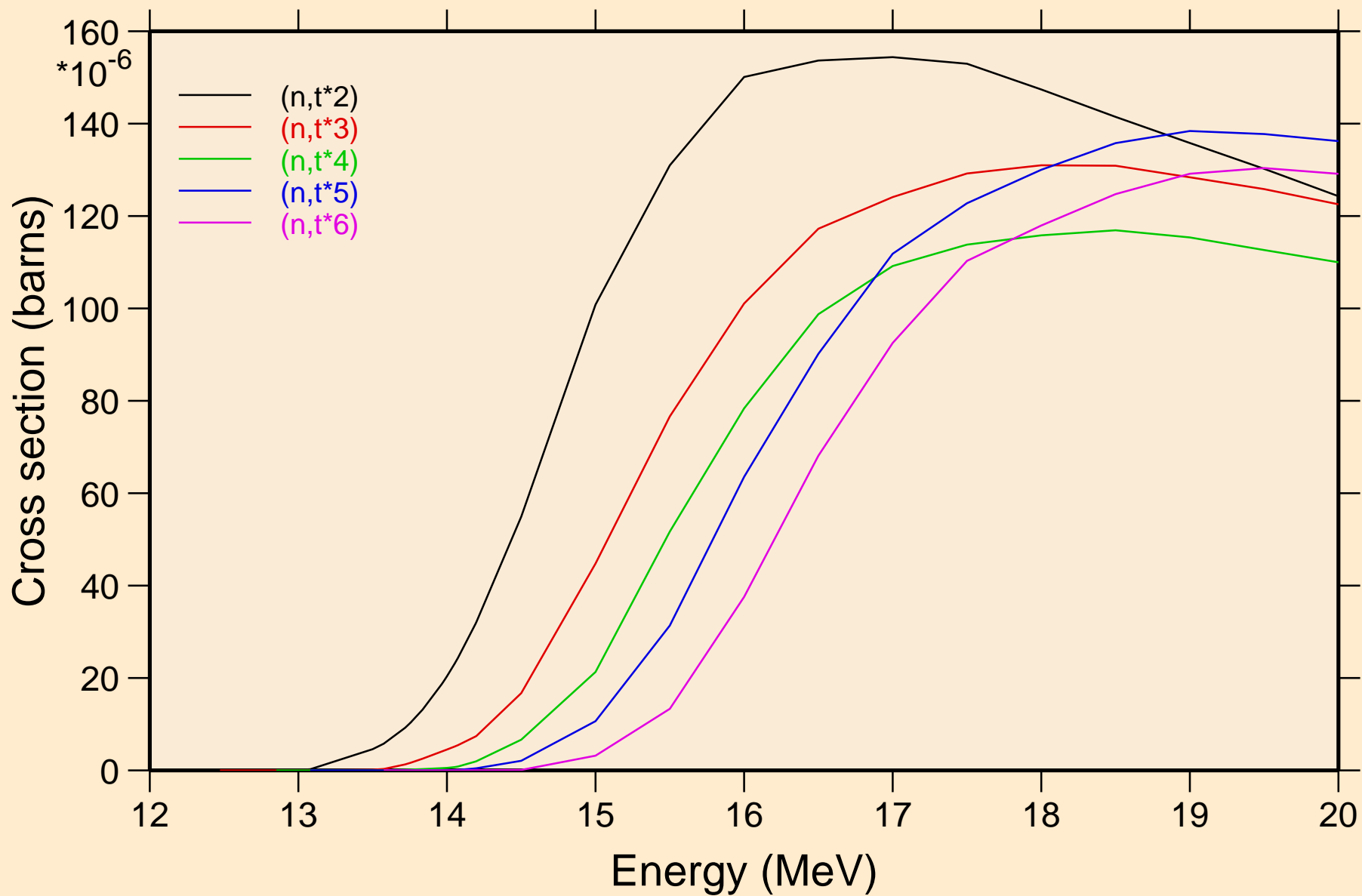

ENDF/B-VII.1 CL-37

Threshold reactions

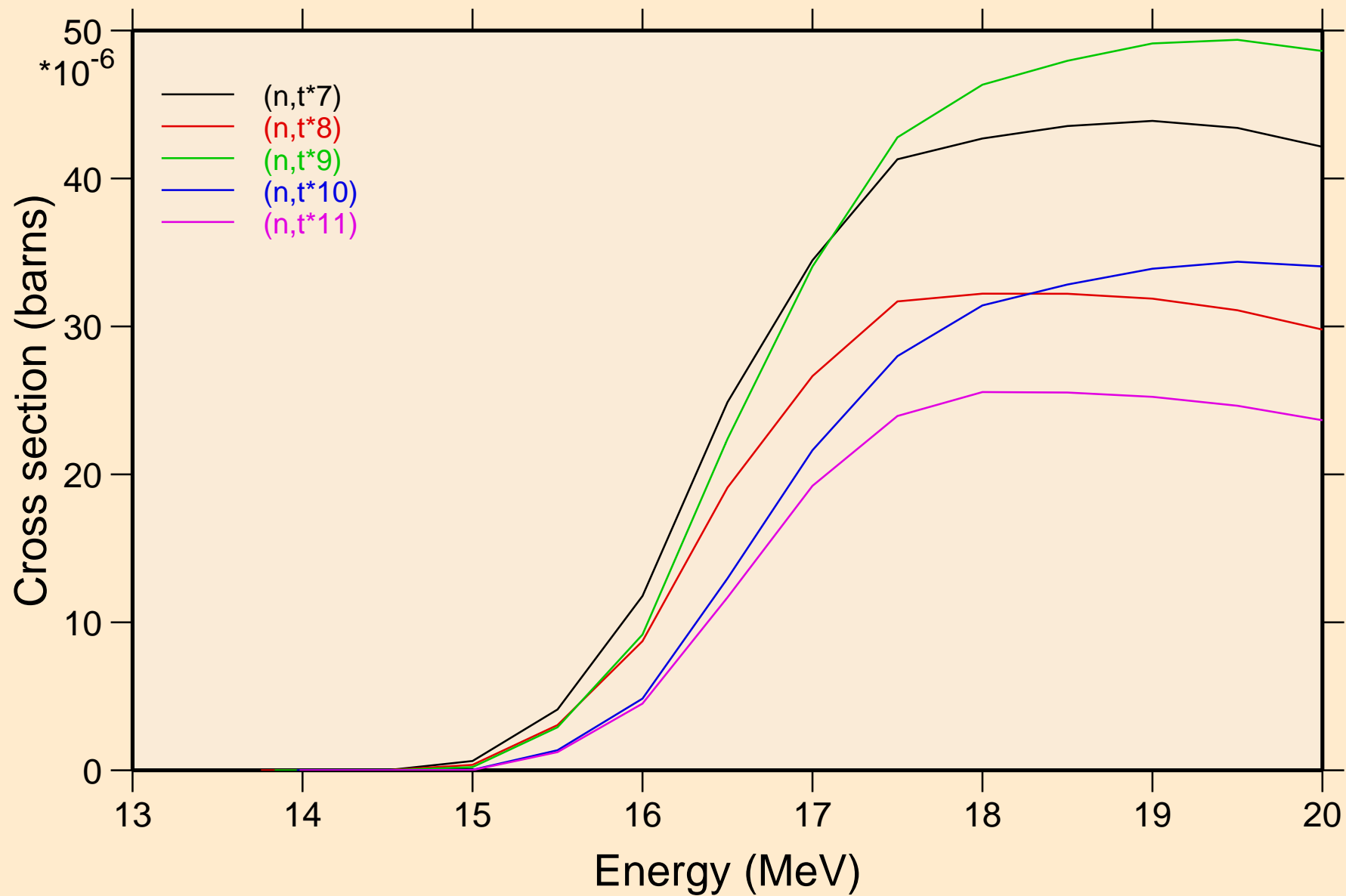

ENDF/B-VII.1 CL-37

Threshold reactions

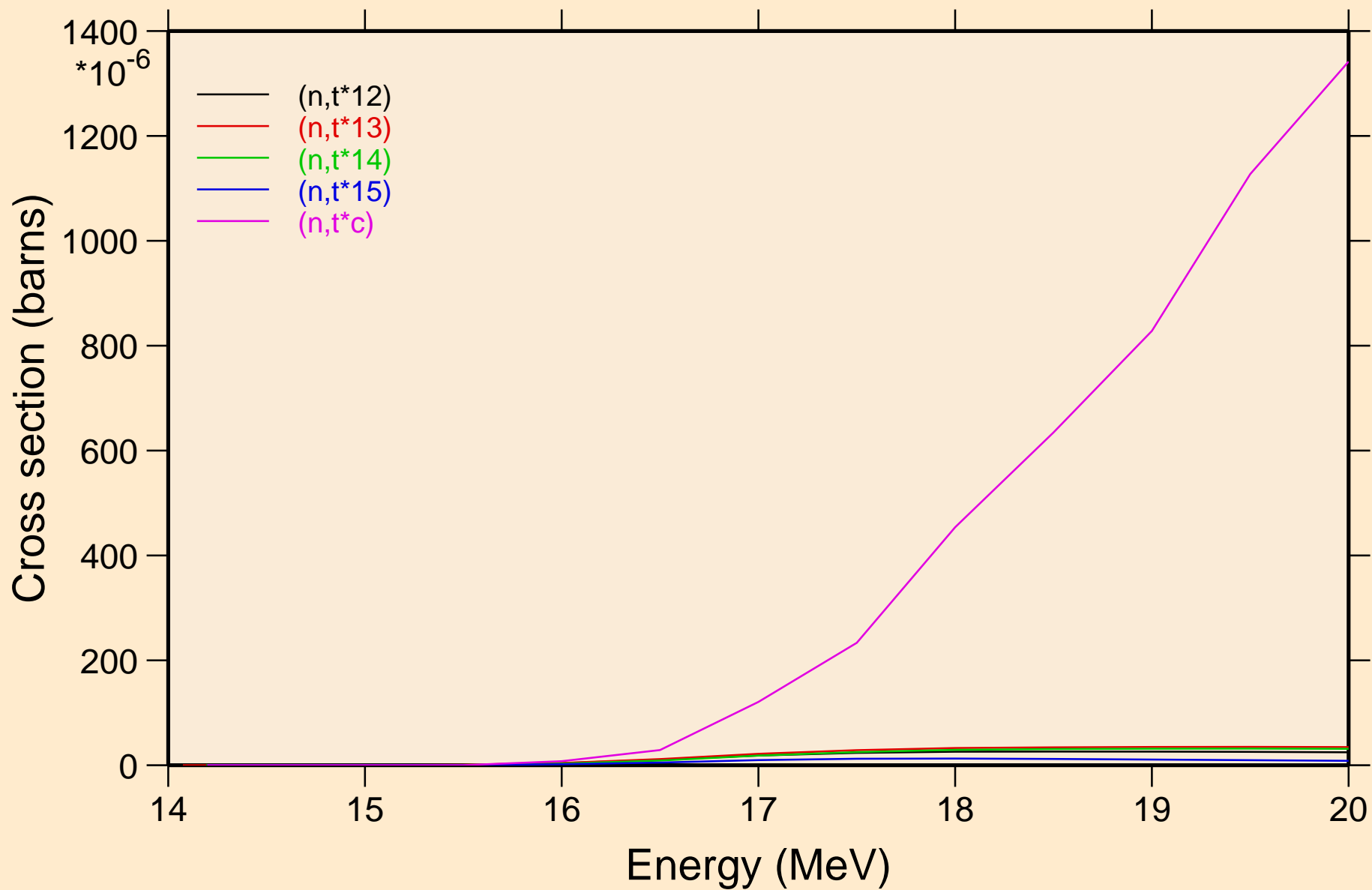

ENDF/B-VII.1 CL-37

Threshold reactions

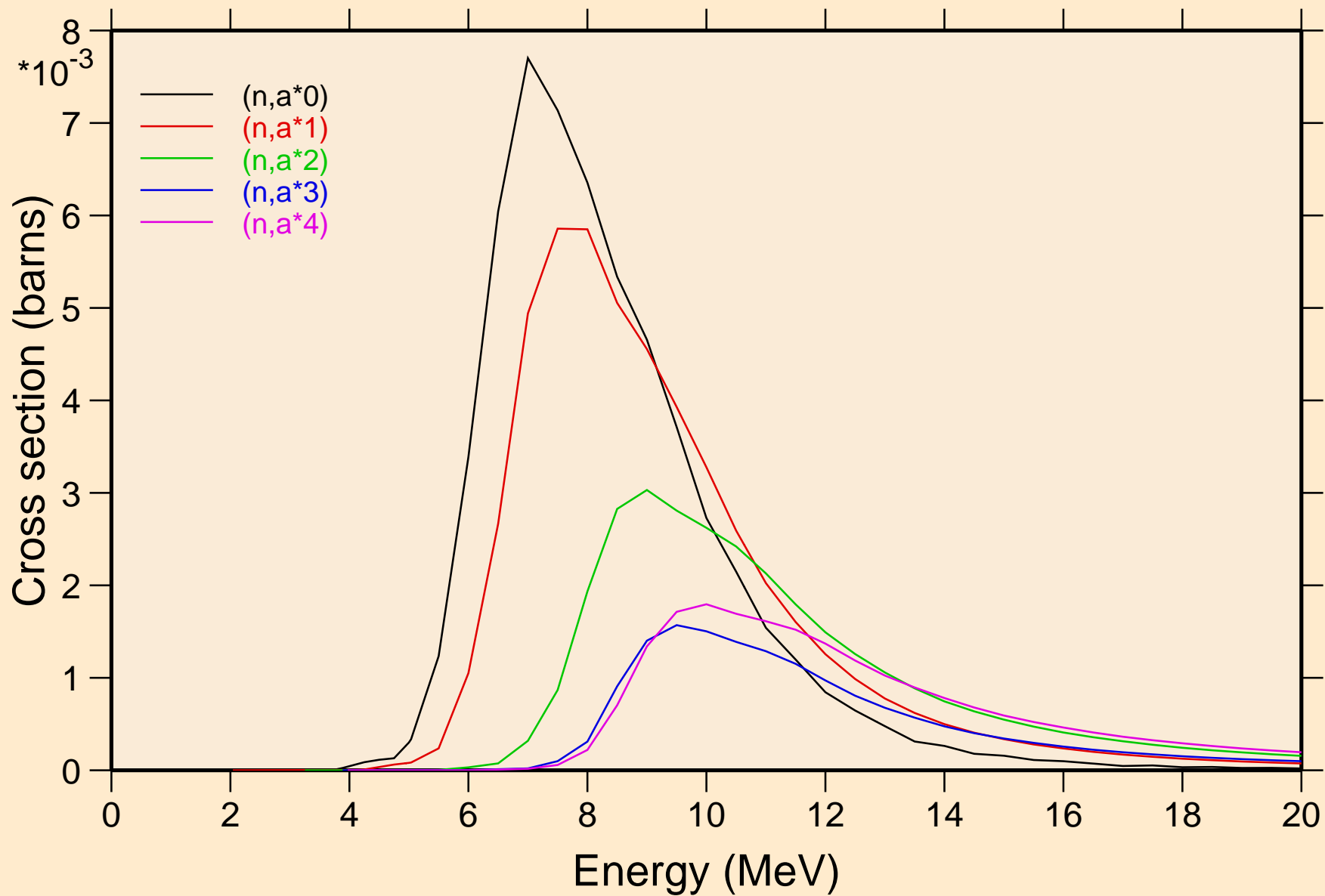

ENDF/B-VII.1 CL-37

Threshold reactions

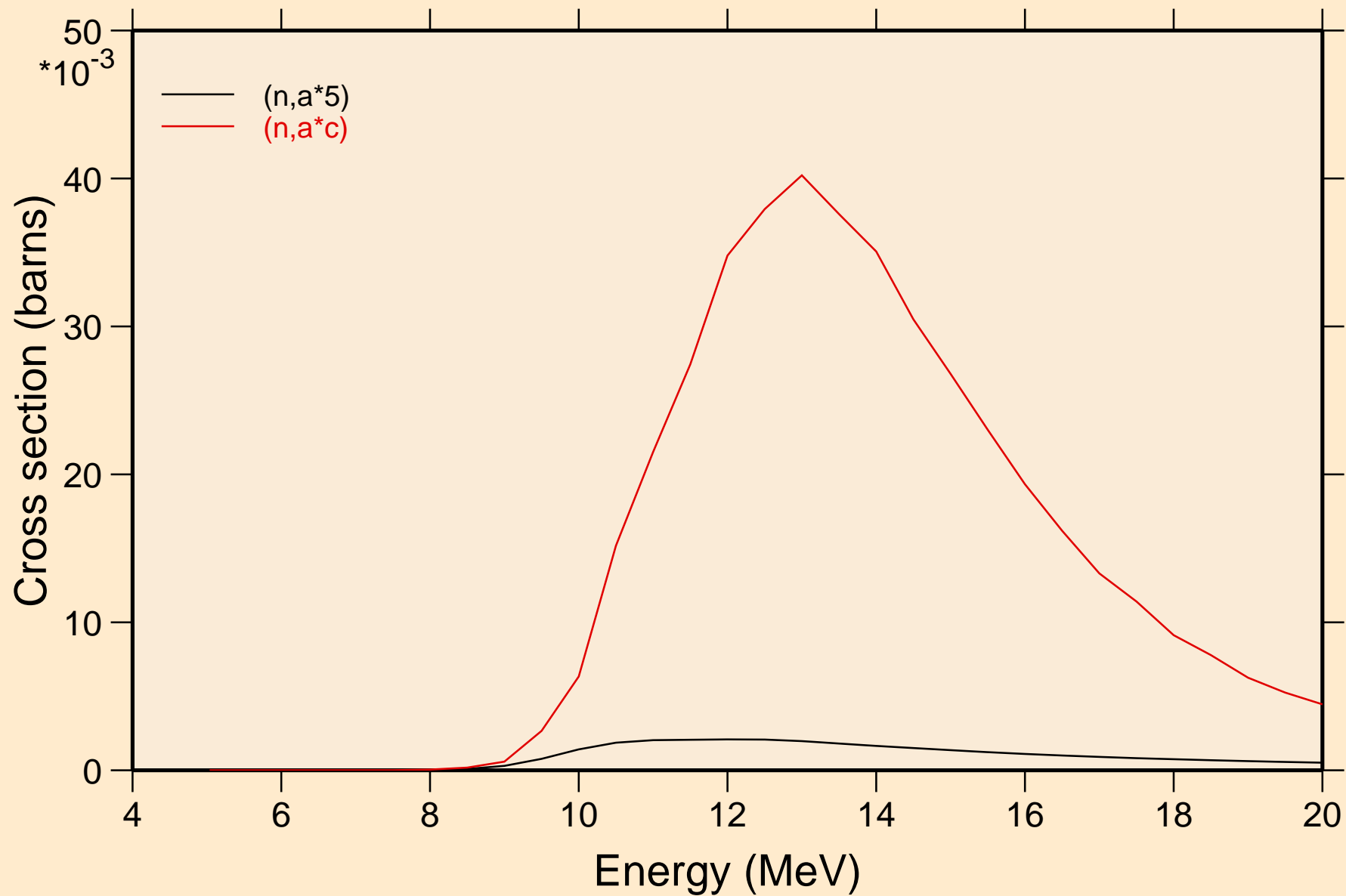

ENDF/B-VII.1 CL-37
angular distribution for elastic

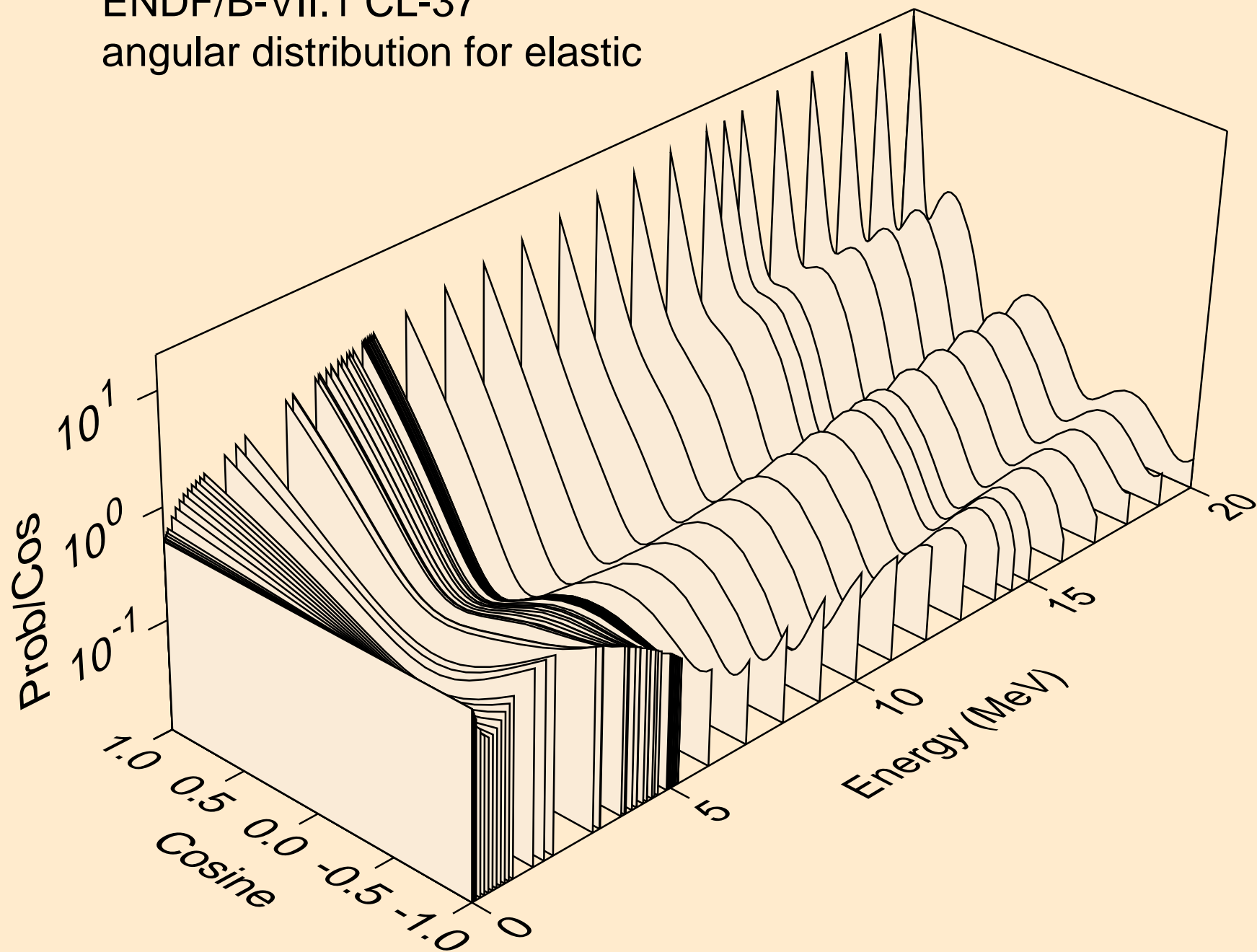

ENDF/B-VII.1 CL-37
angular distribution for (n,n*1)

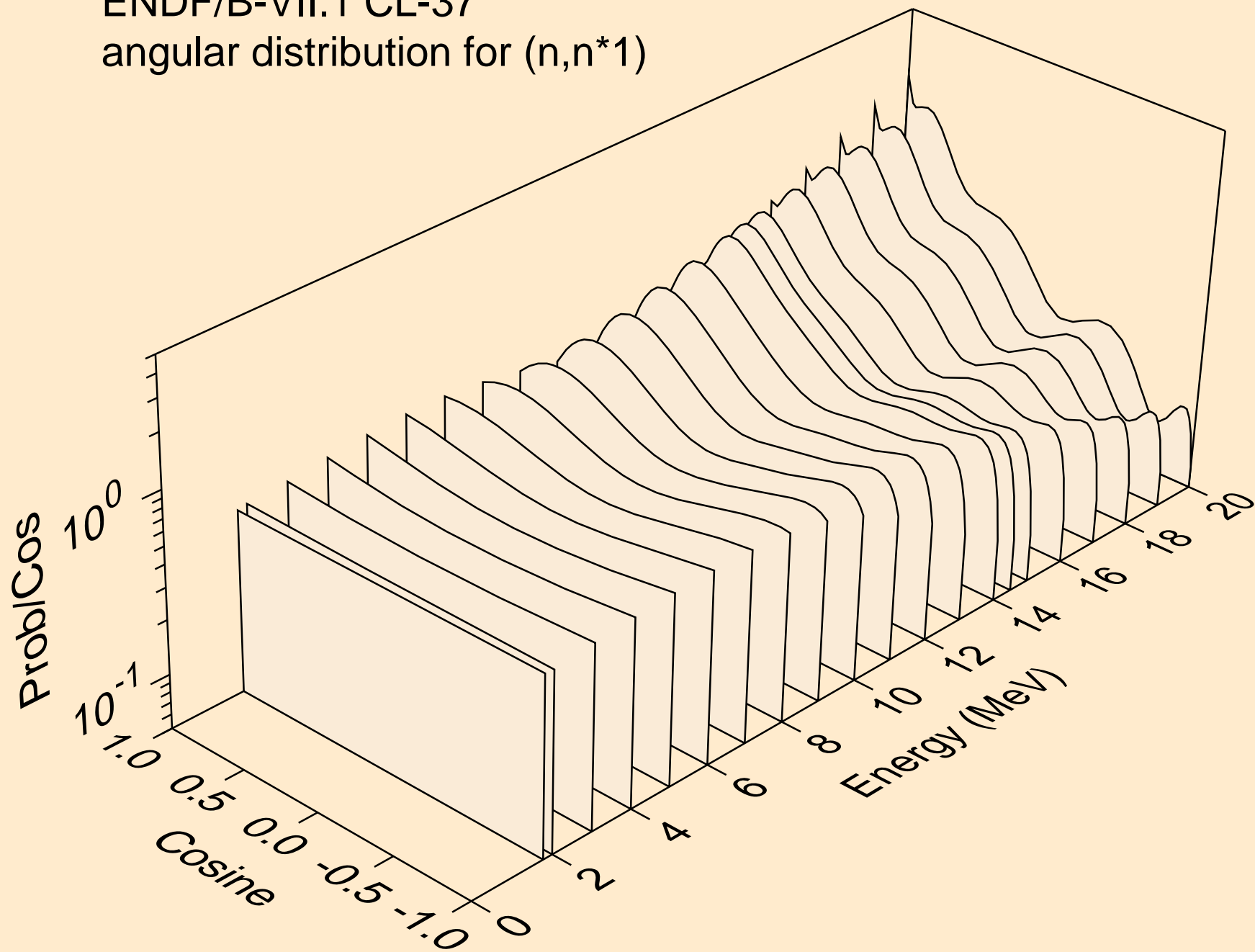

ENDF/B-VII.1 CL-37
angular distribution for (n,n*2)

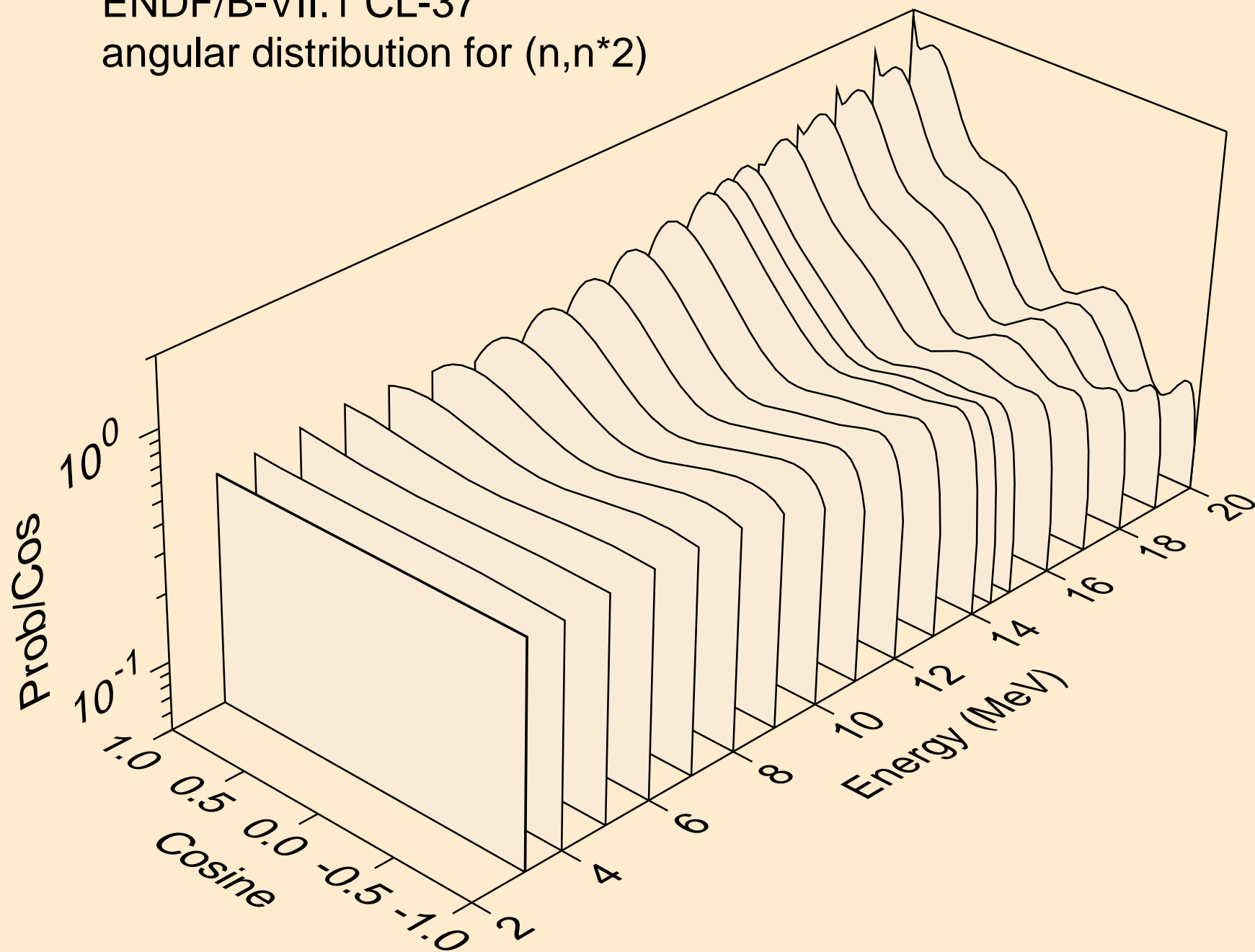

ENDF/B-VII.1 CL-37
angular distribution for (n,n*3)

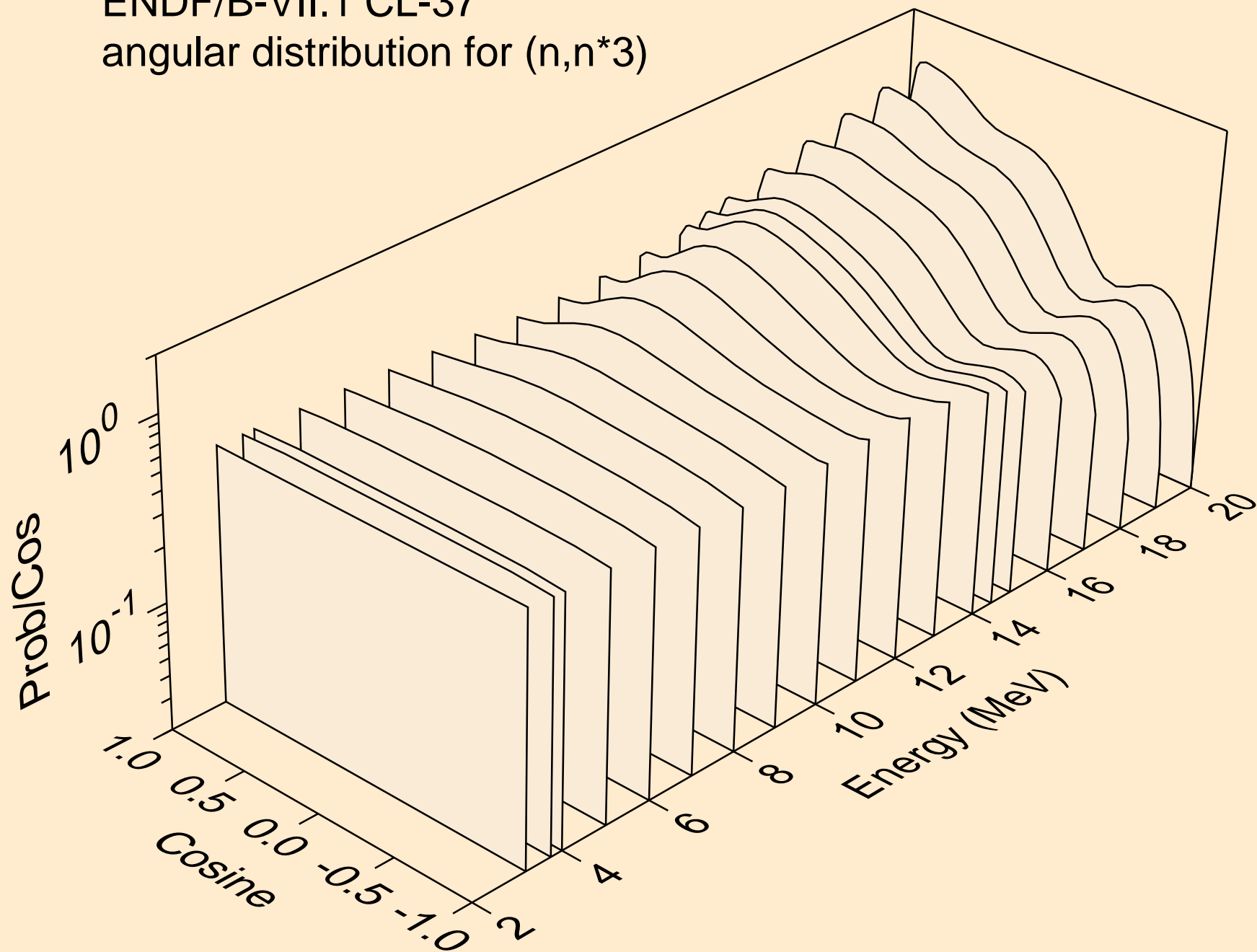

ENDF/B-VII.1 CL-37
angular distribution for (n,n*4)

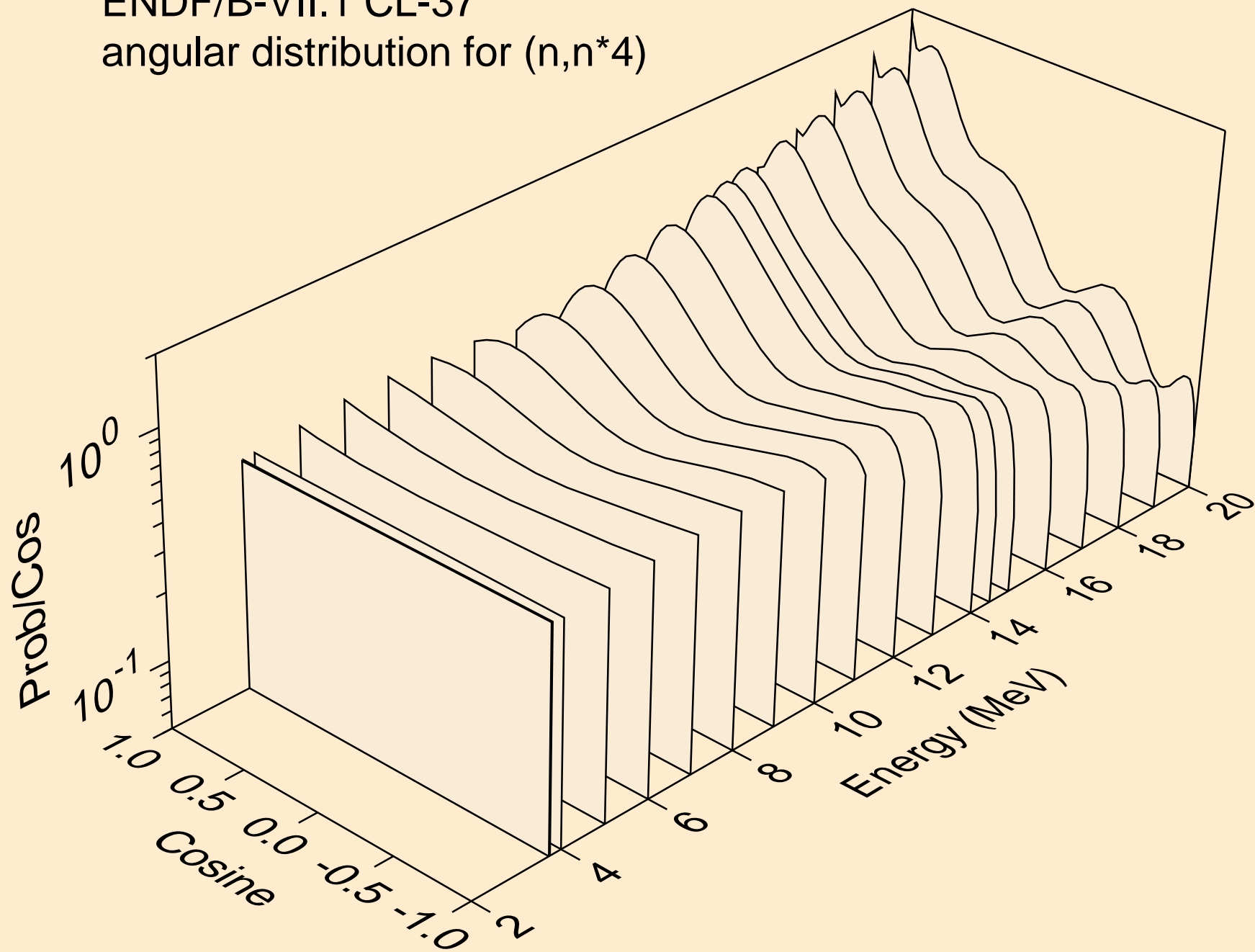

ENDF/B-VII.1 CL-37
angular distribution for (n,n*5)

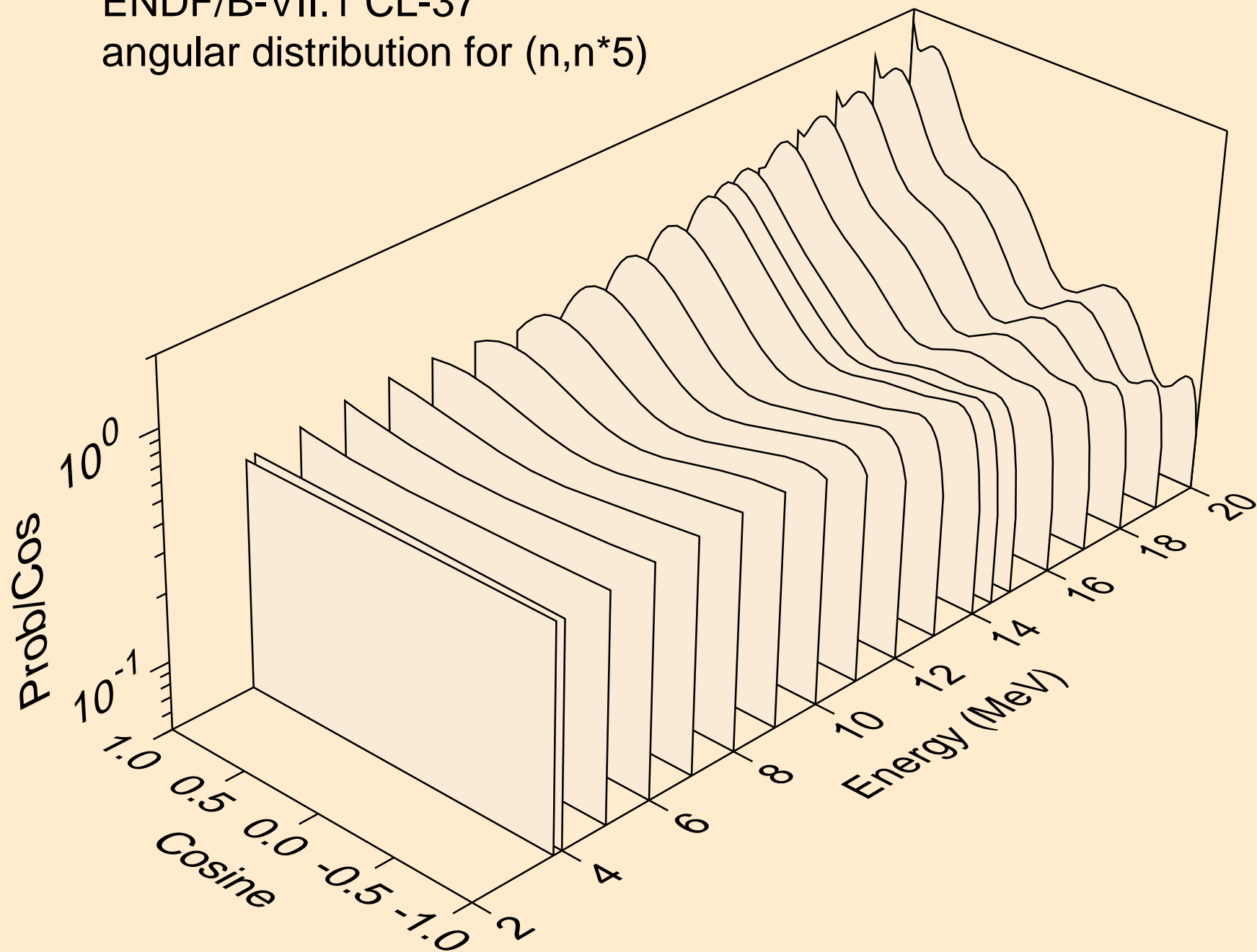

ENDF/B-VII.1 CL-37
angular distribution for (n,n*6)

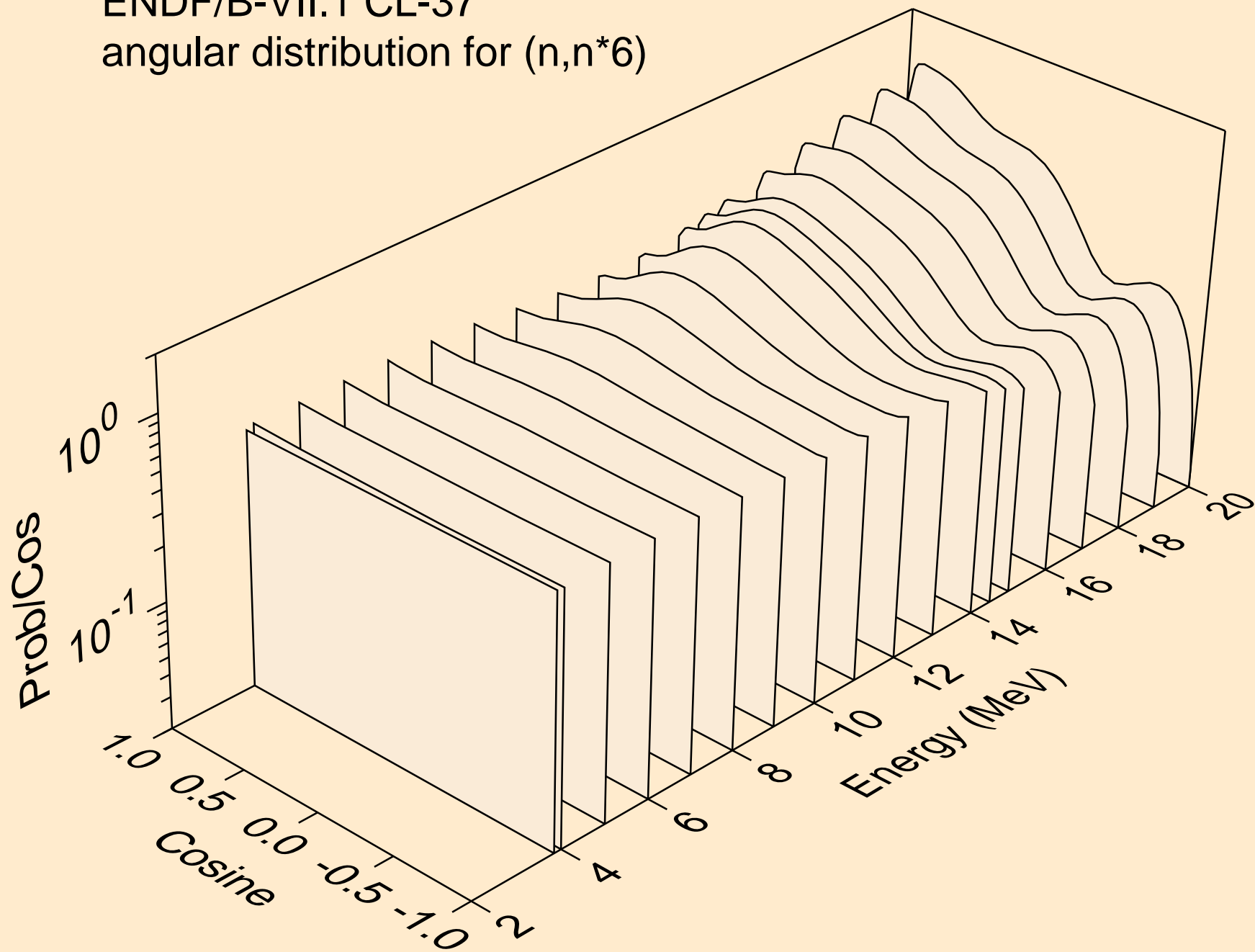

ENDF/B-VII.1 CL-37
angular distribution for (n,n*7)

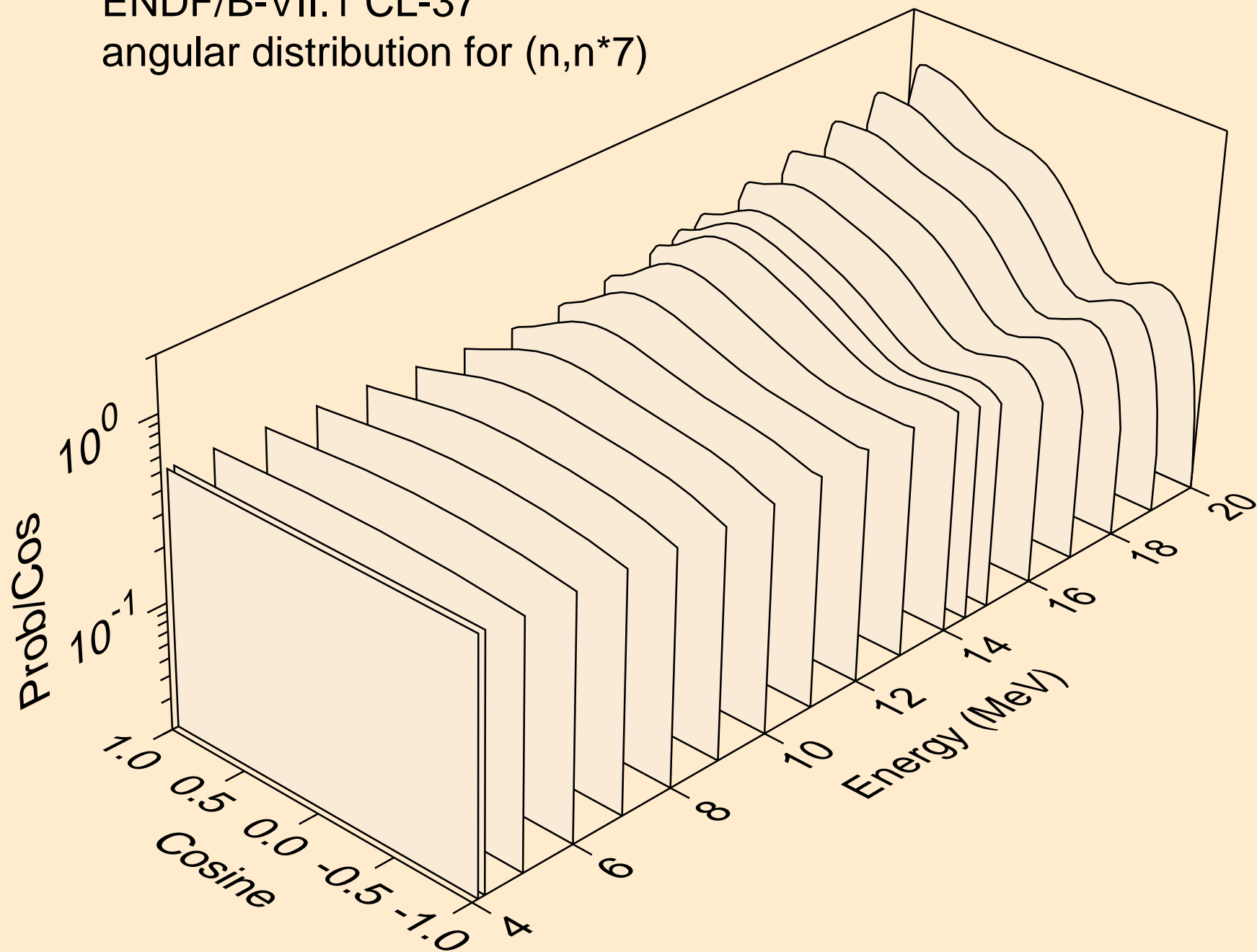

ENDF/B-VII.1 CL-37
angular distribution for (n,n*8)

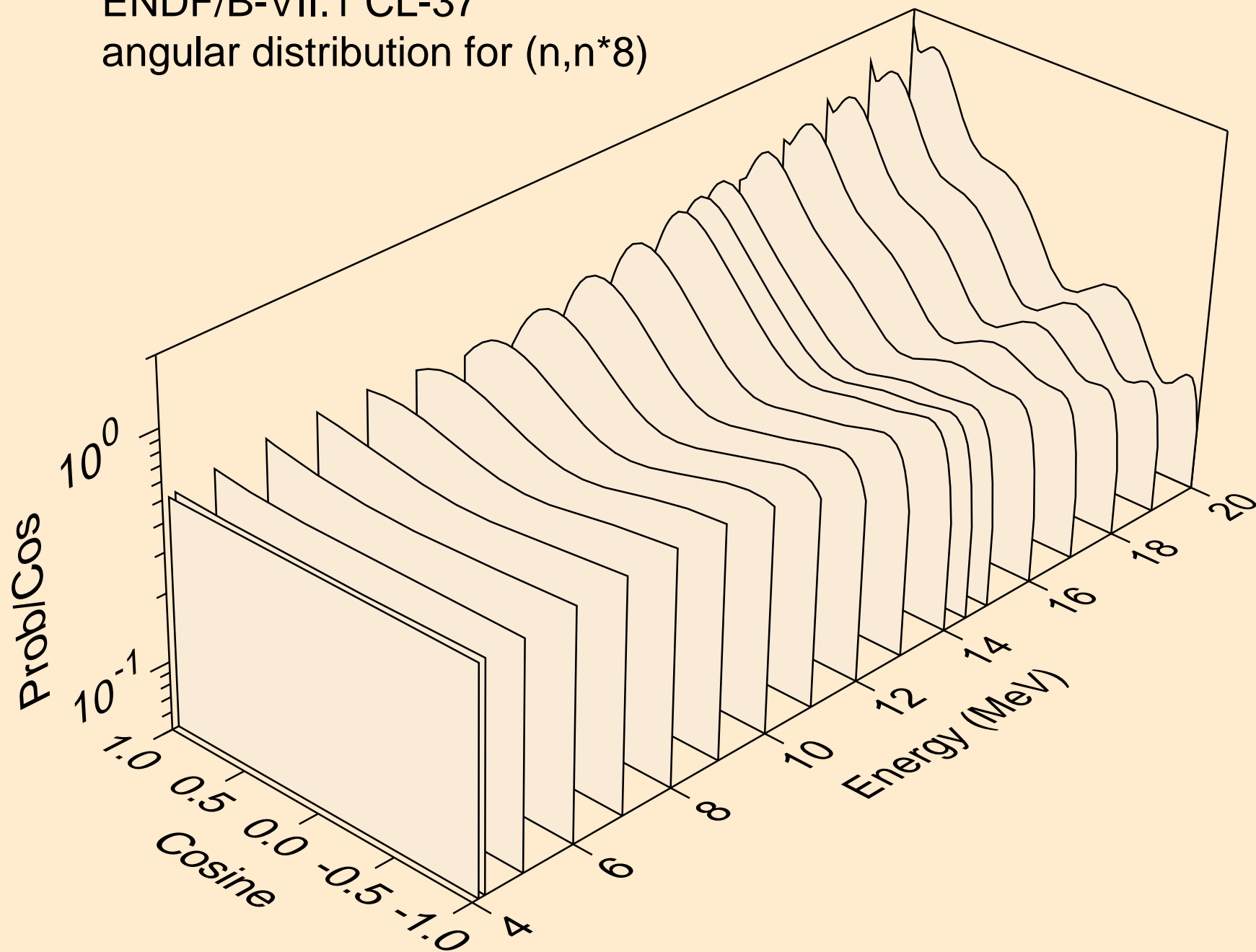

ENDF/B-VII.1 CL-37
angular distribution for (n,n*9)

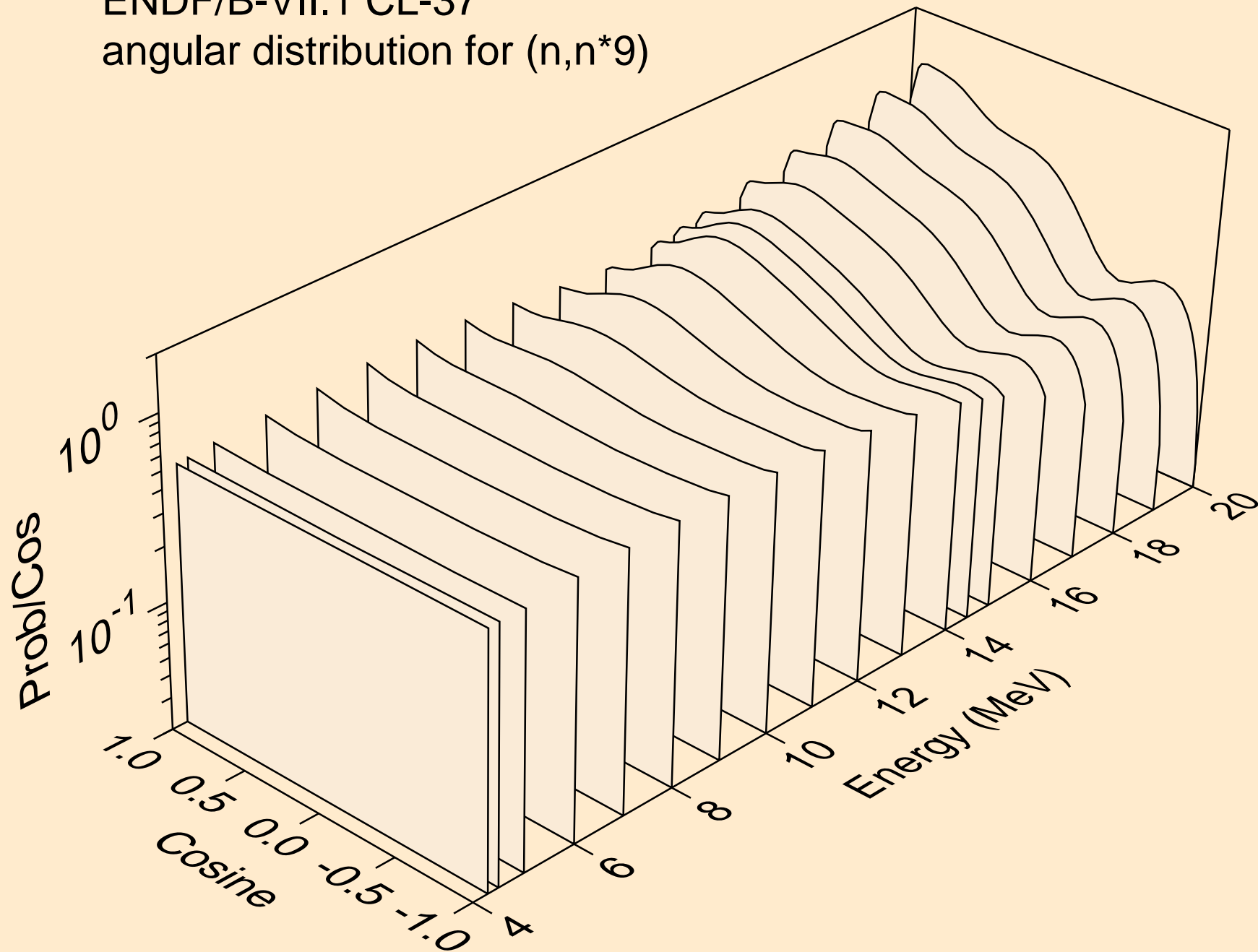

ENDF/B-VII.1 CL-37
angular distribution for (n,n*10)

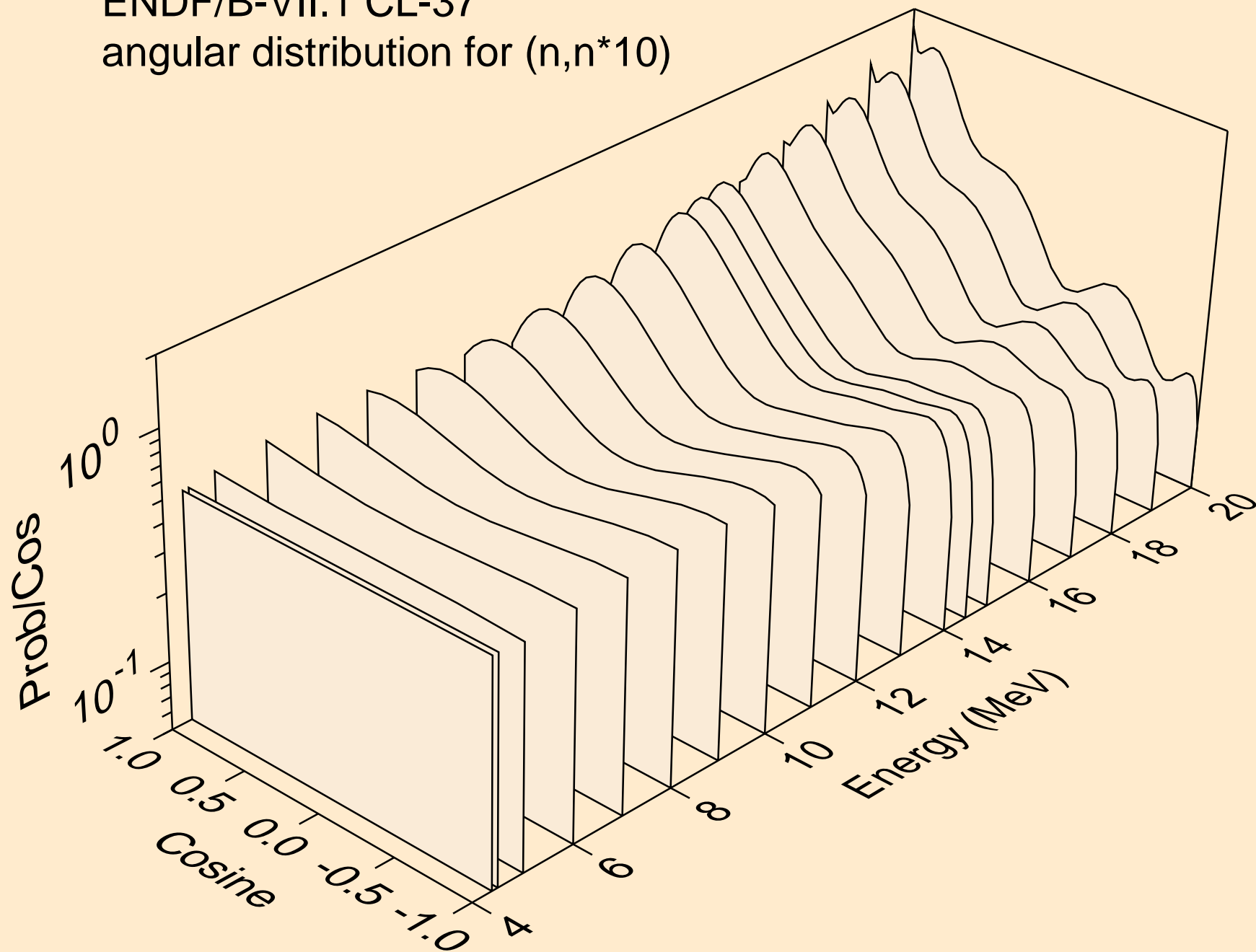

ENDF/B-VII.1 CL-37
angular distribution for (n,n*11)

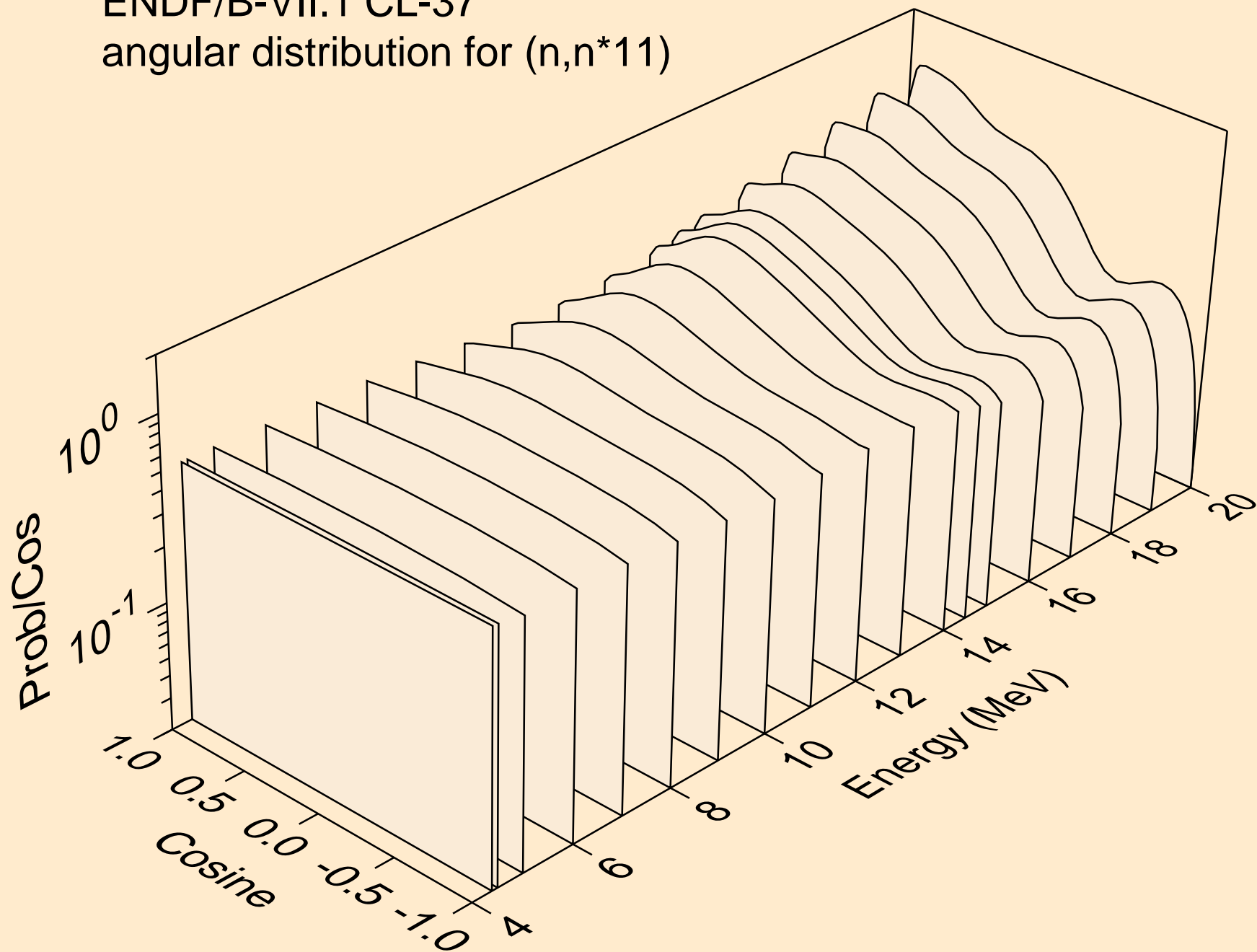

ENDF/B-VII.1 CL-37
angular distribution for (n,n*12)

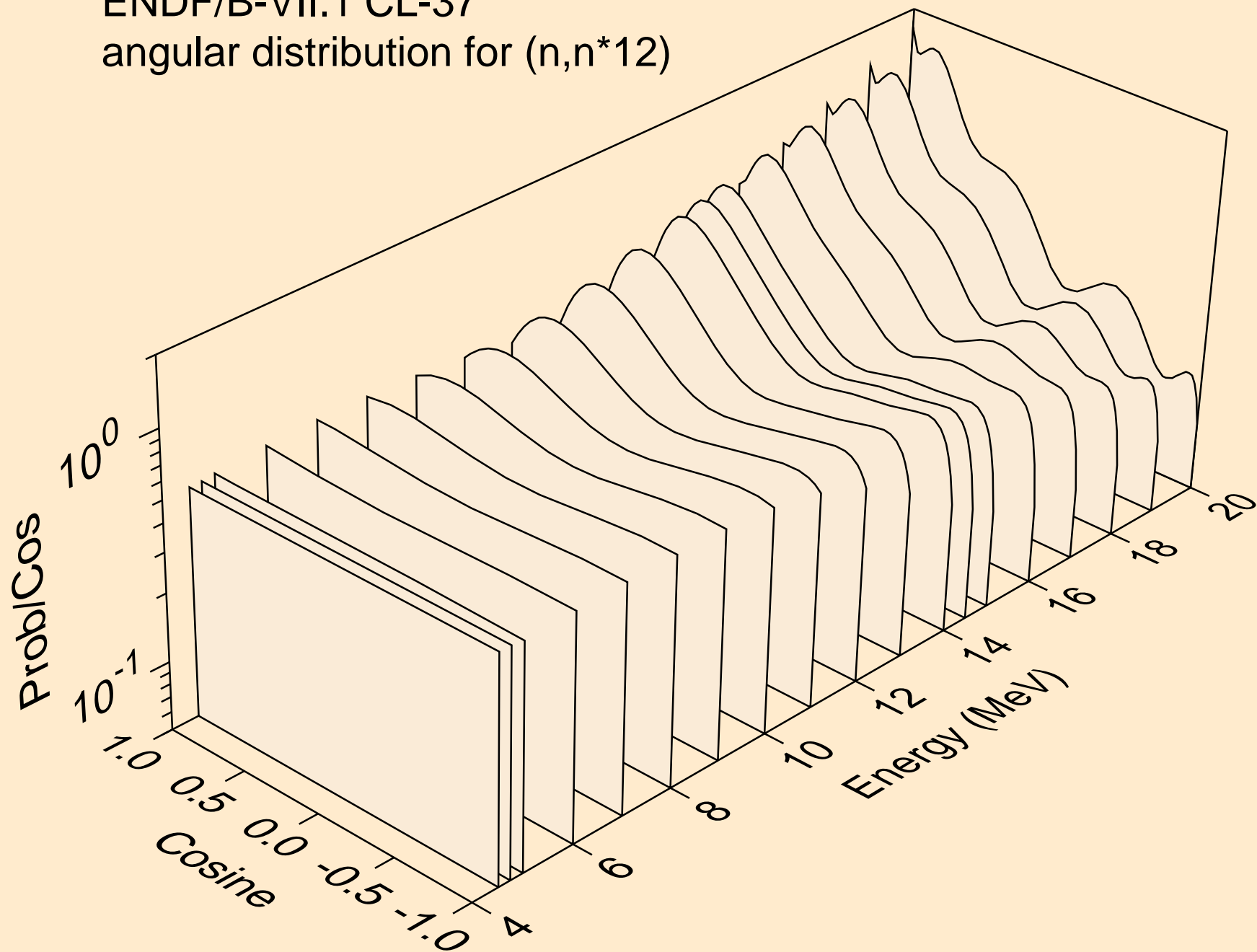

ENDF/B-VII.1 CL-37
angular distribution for (n,n*13)

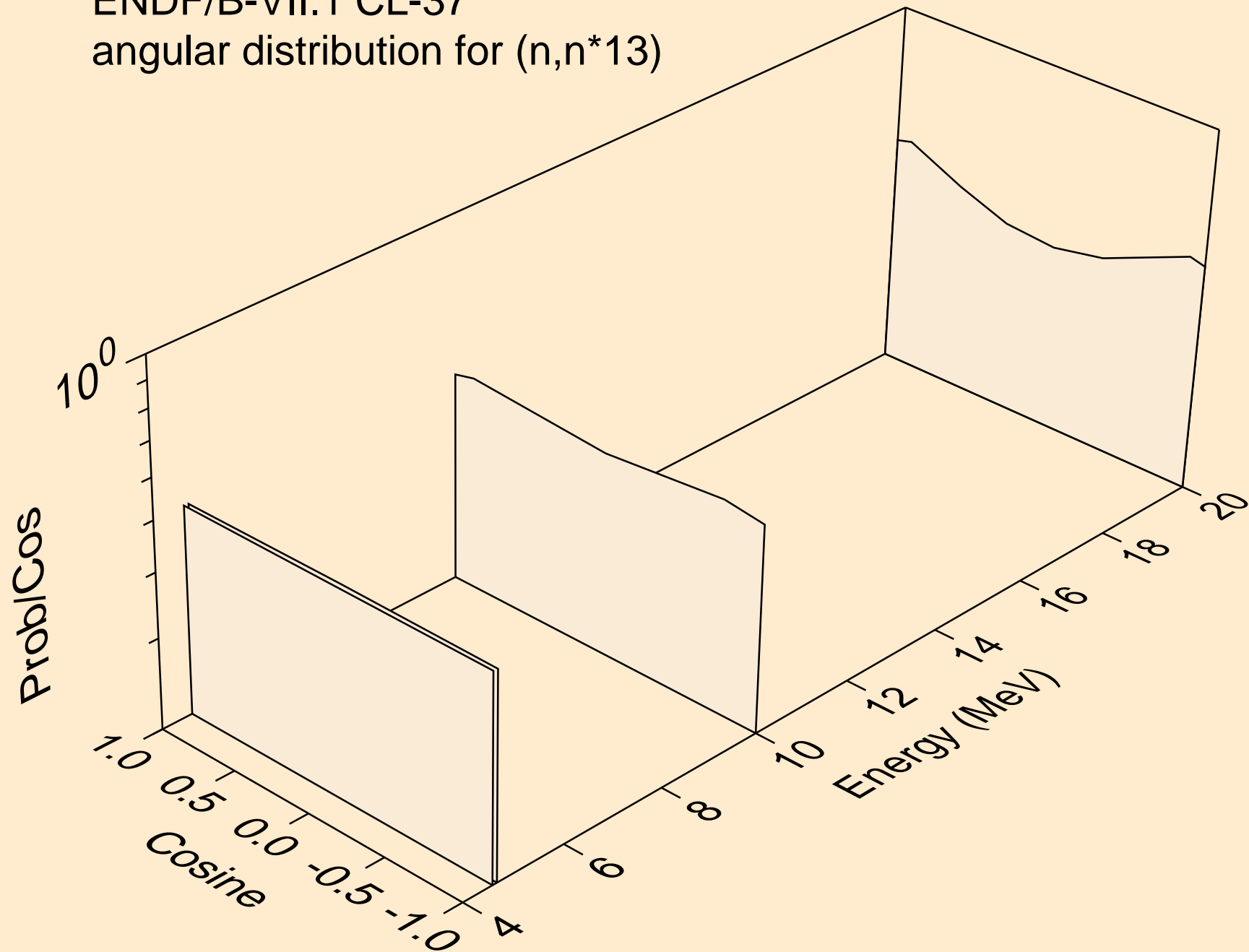

ENDF/B-VII.1 CL-37
angular distribution for (n,n*14)

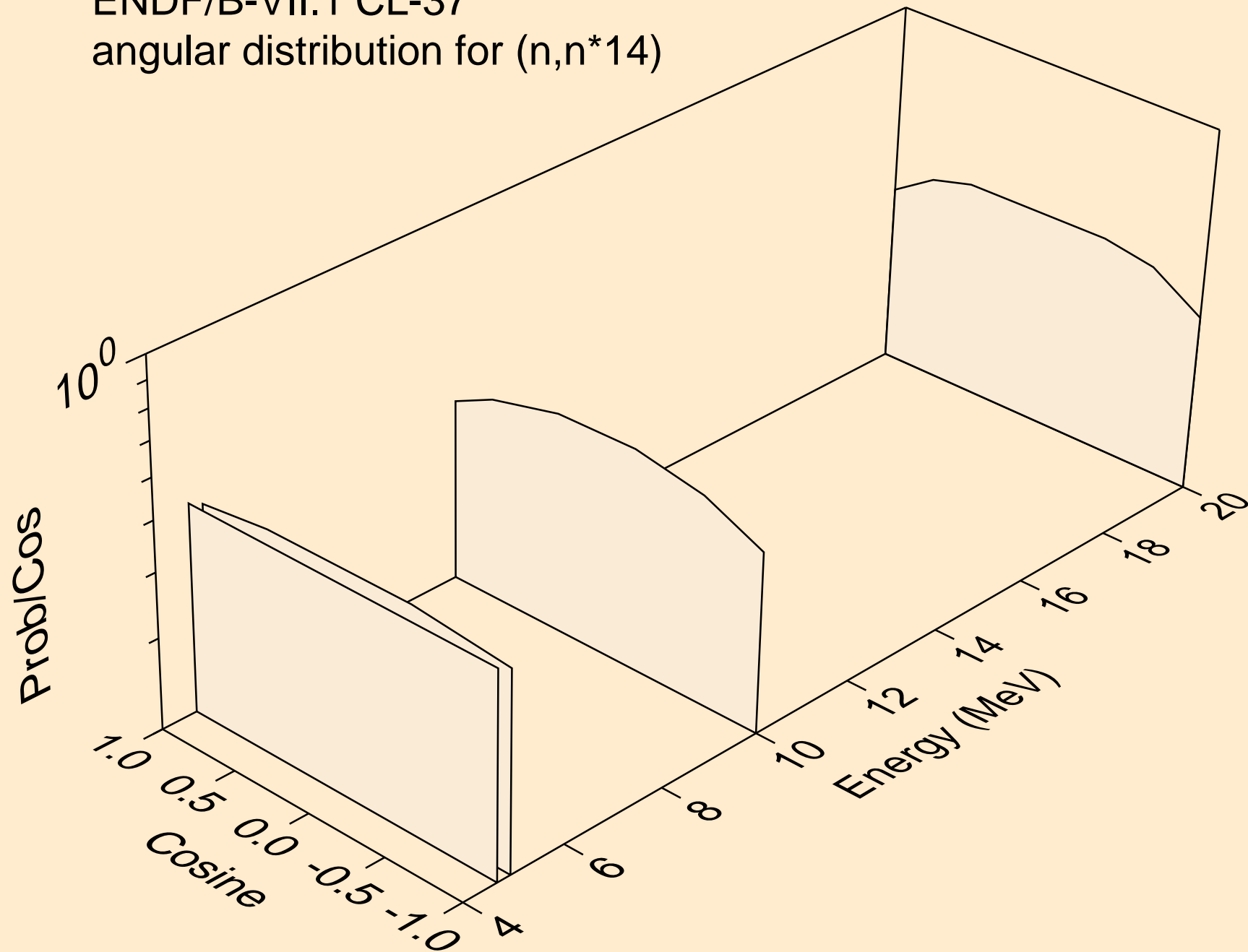

ENDF/B-VII.1 CL-37
angular distribution for (n,n*15)

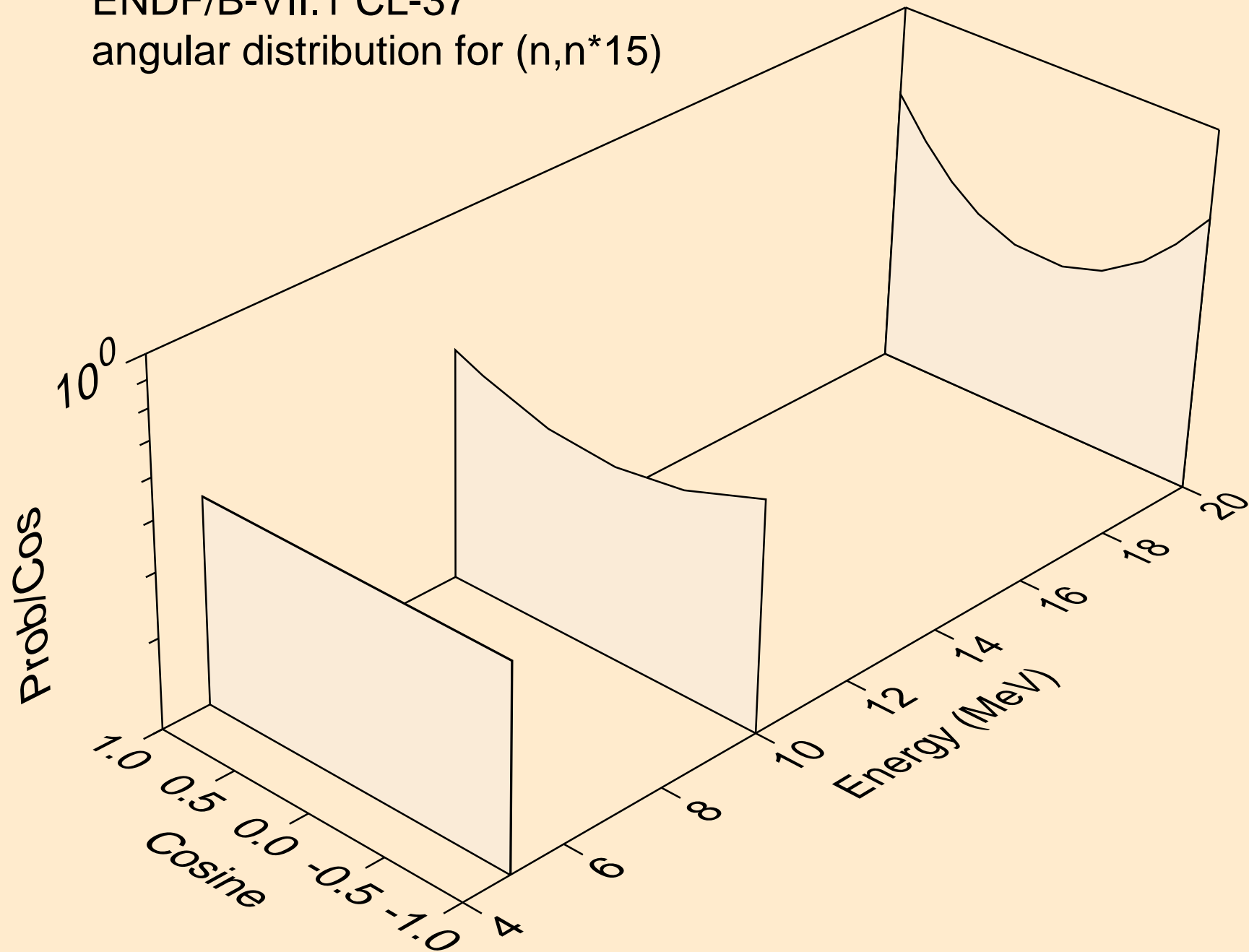

ENDF/B-VII.1 CL-37
angular distribution for (n,n*16)

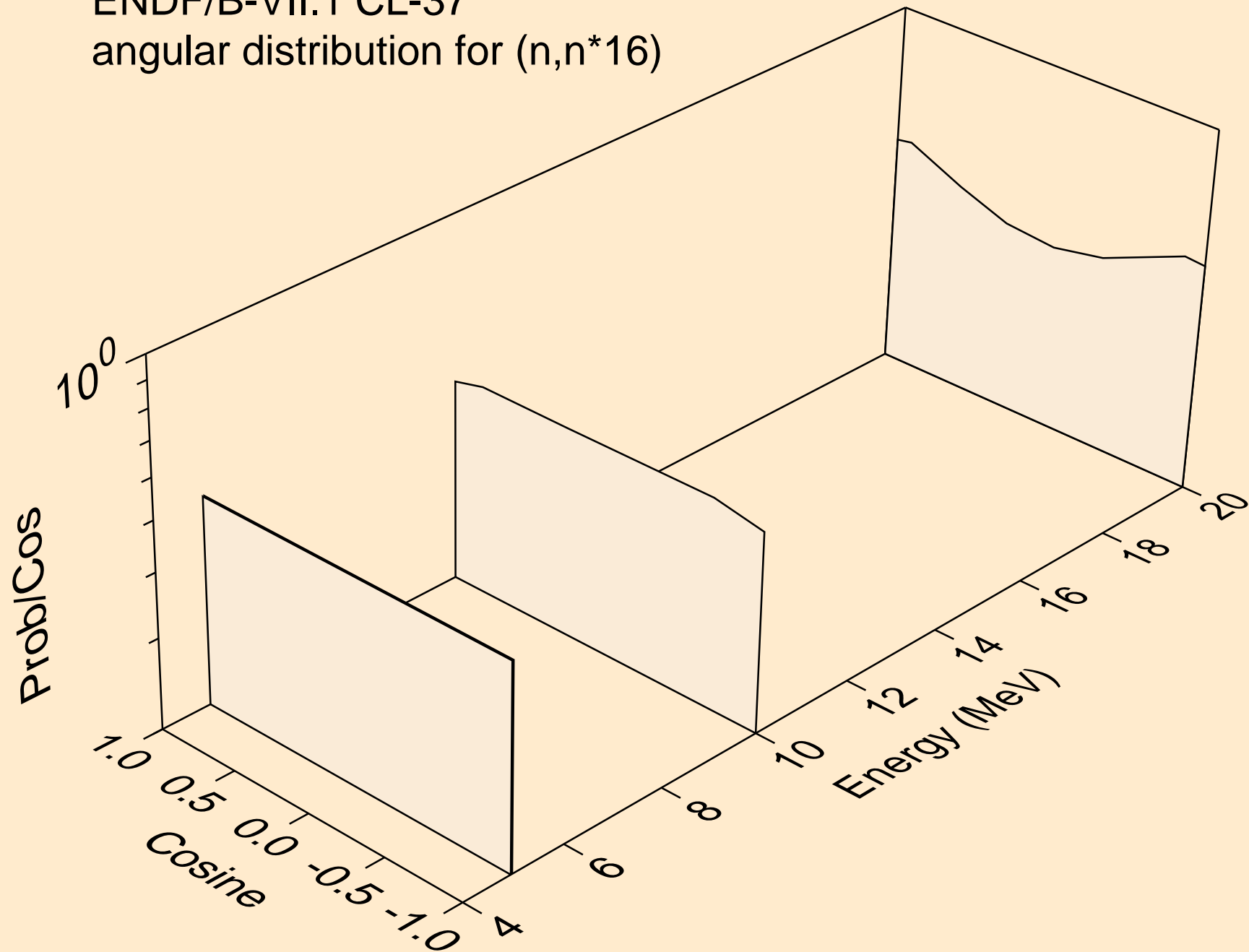

ENDF/B-VII.1 CL-37
angular distribution for (n,n*17)

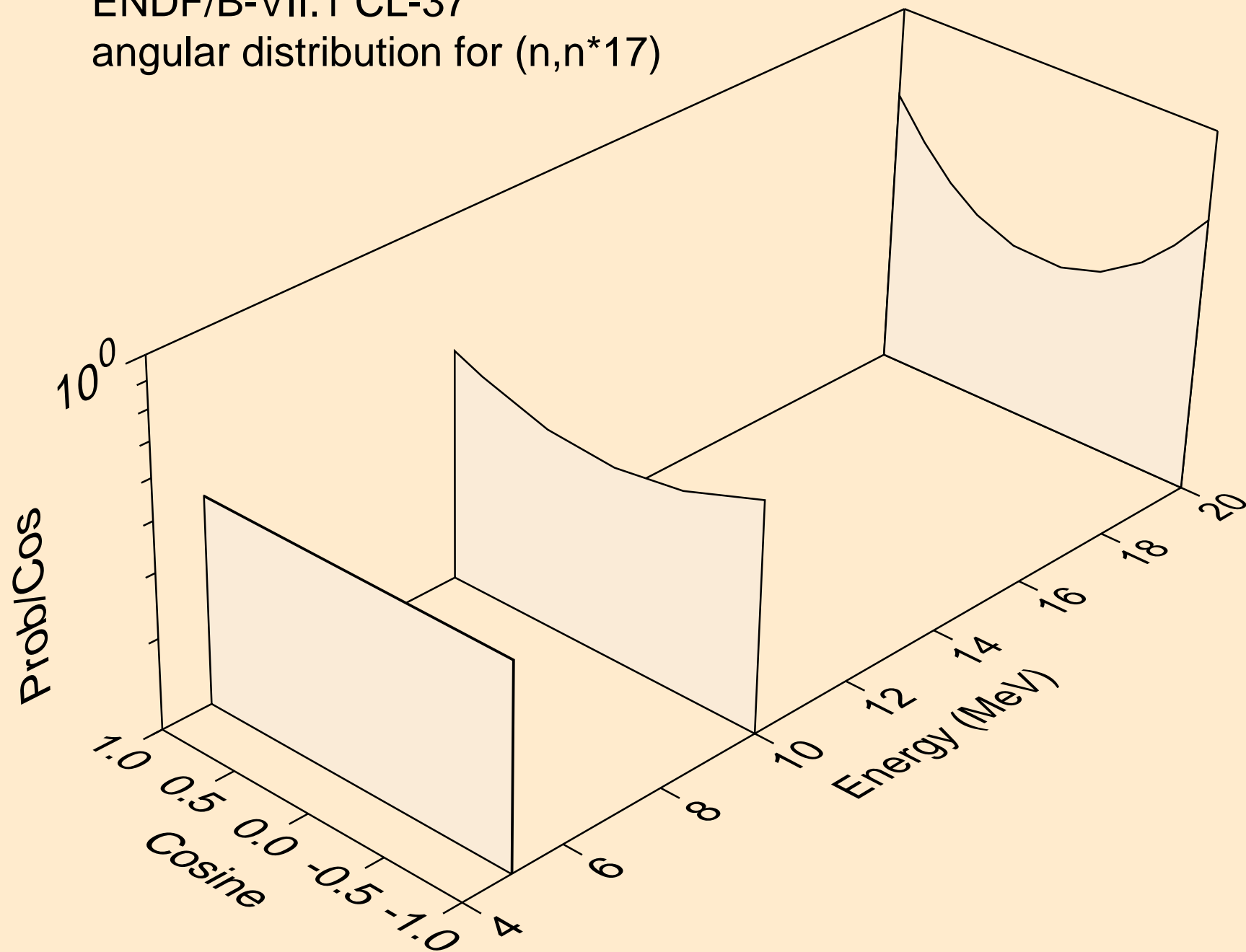

ENDF/B-VII.1 CL-37
angular distribution for (n,n*18)

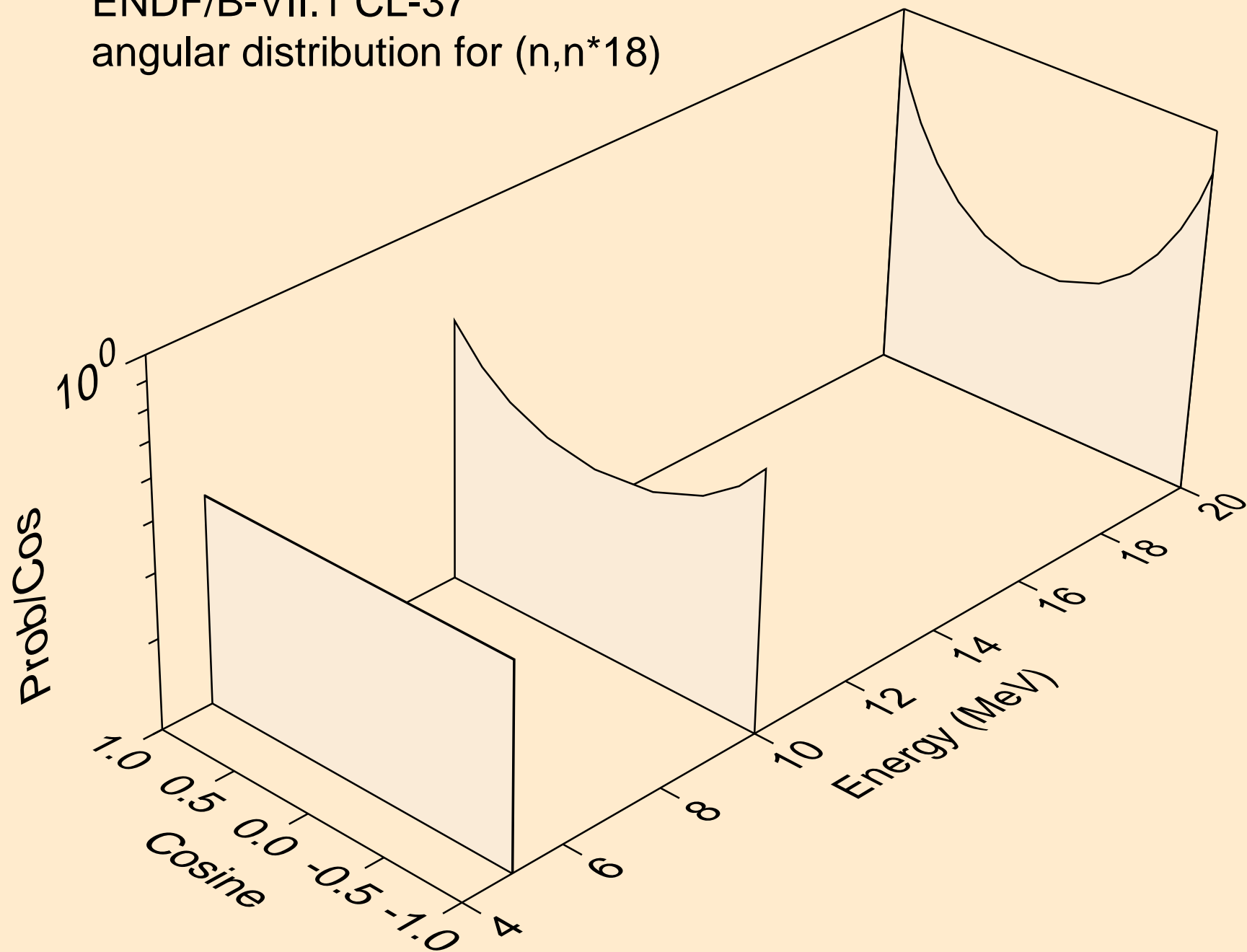

ENDF/B-VII.1 CL-37
angular distribution for (n,n*19)

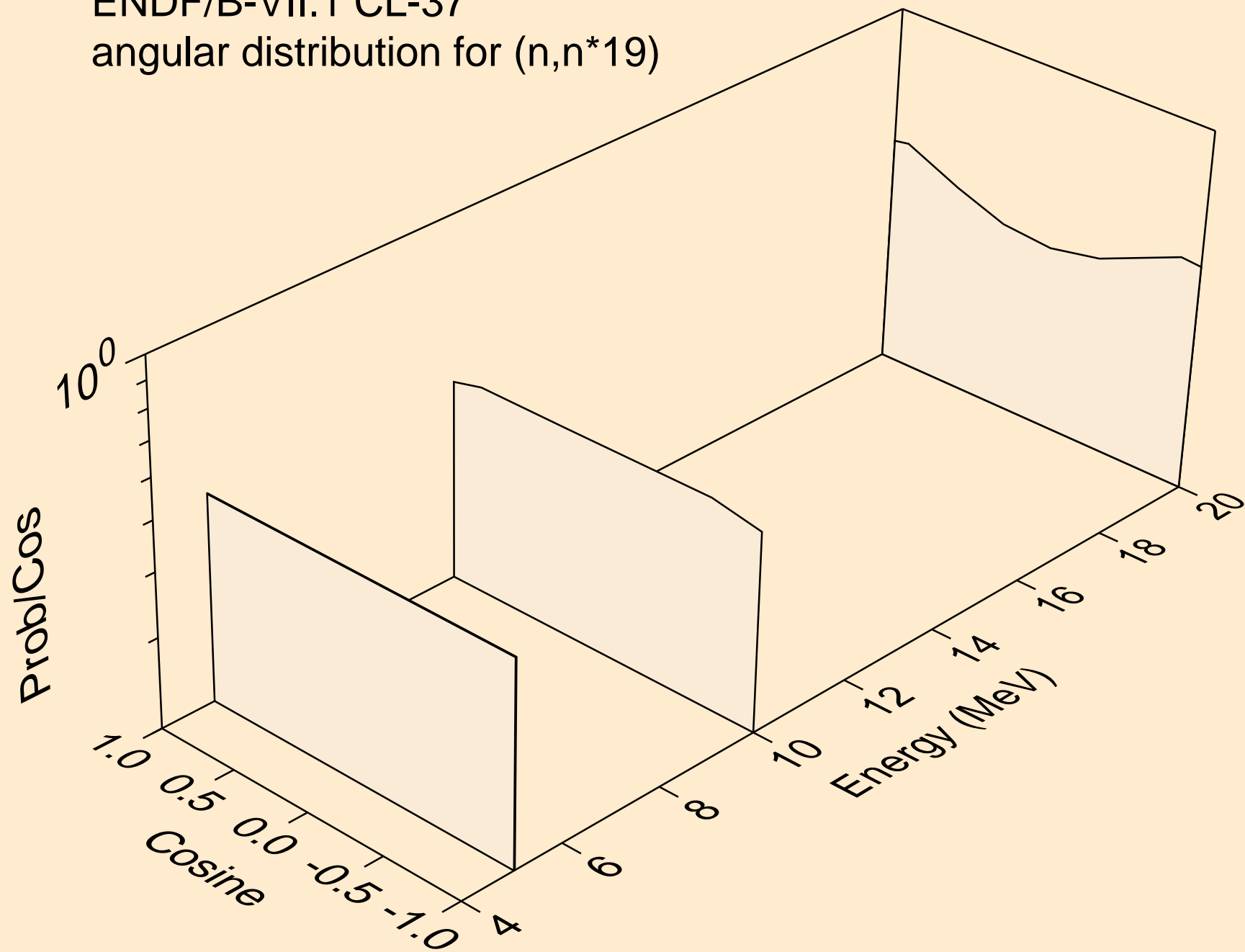

ENDF/B-VII.1 CL-37
angular distribution for (n,n*20)

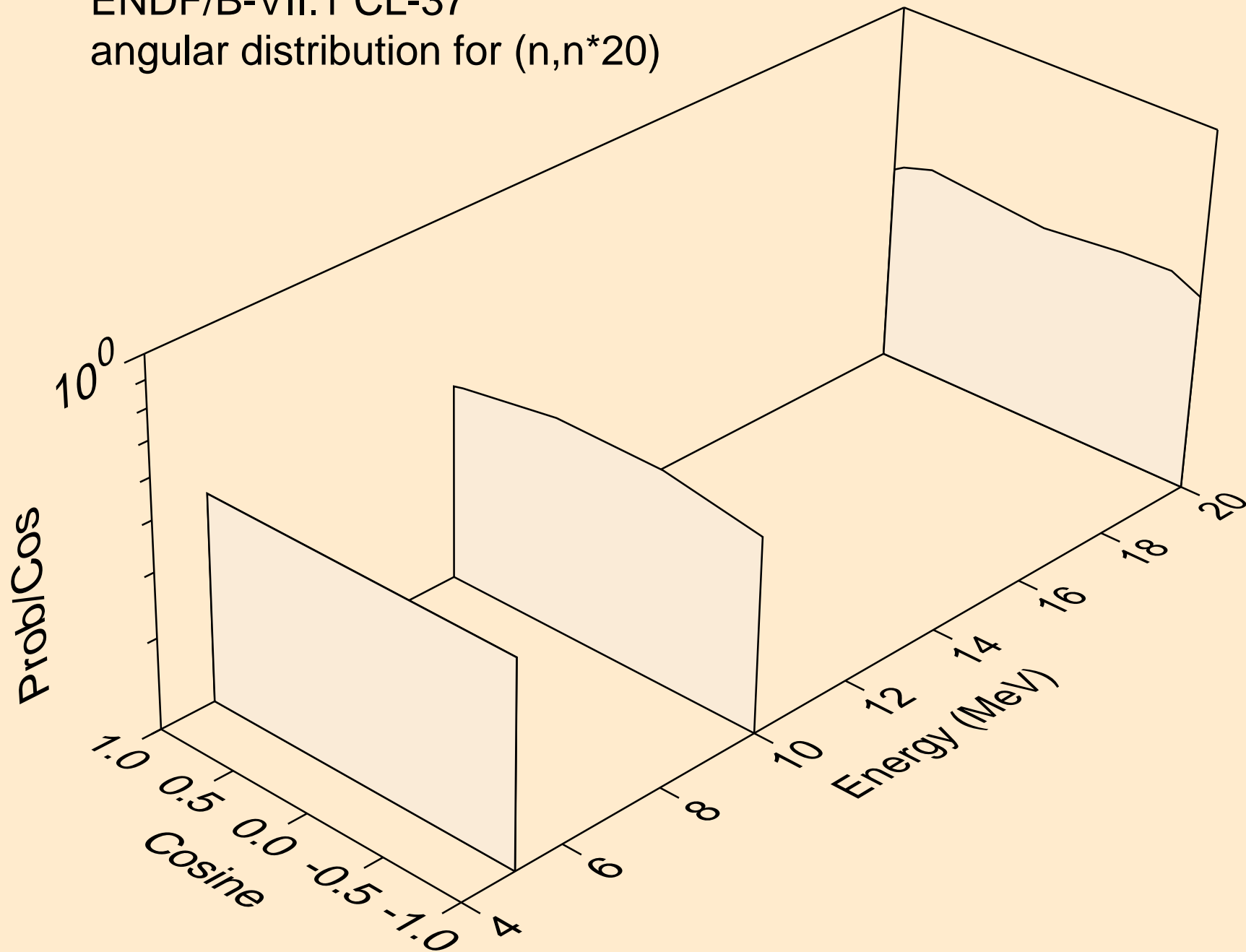

ENDF/B-VII.1 CL-37
angular distribution for (n,n*21)

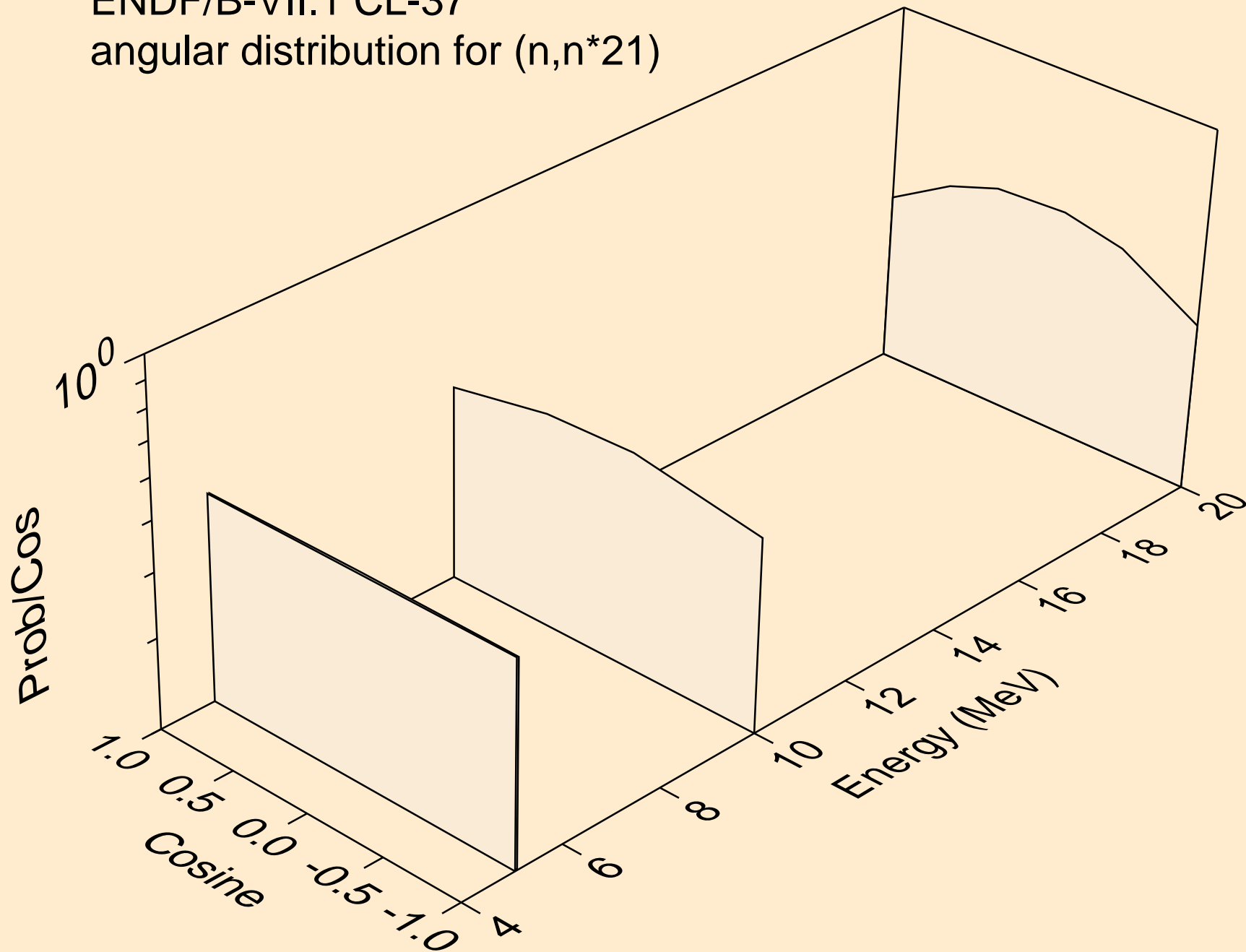

ENDF/B-VII.1 CL-37
angular distribution for (n,n*22)

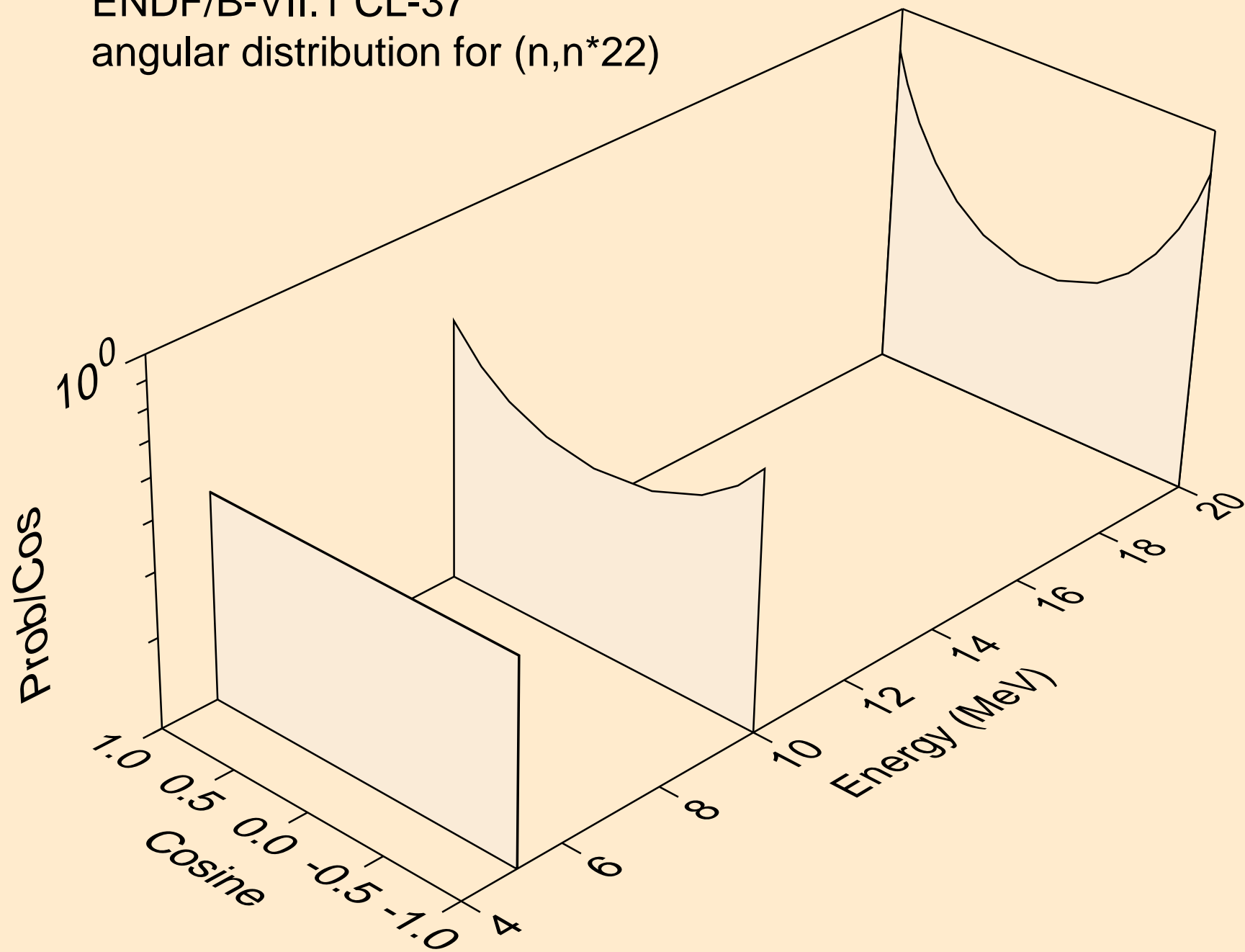

ENDF/B-VII.1 CL-37
angular distribution for (n,n*23)

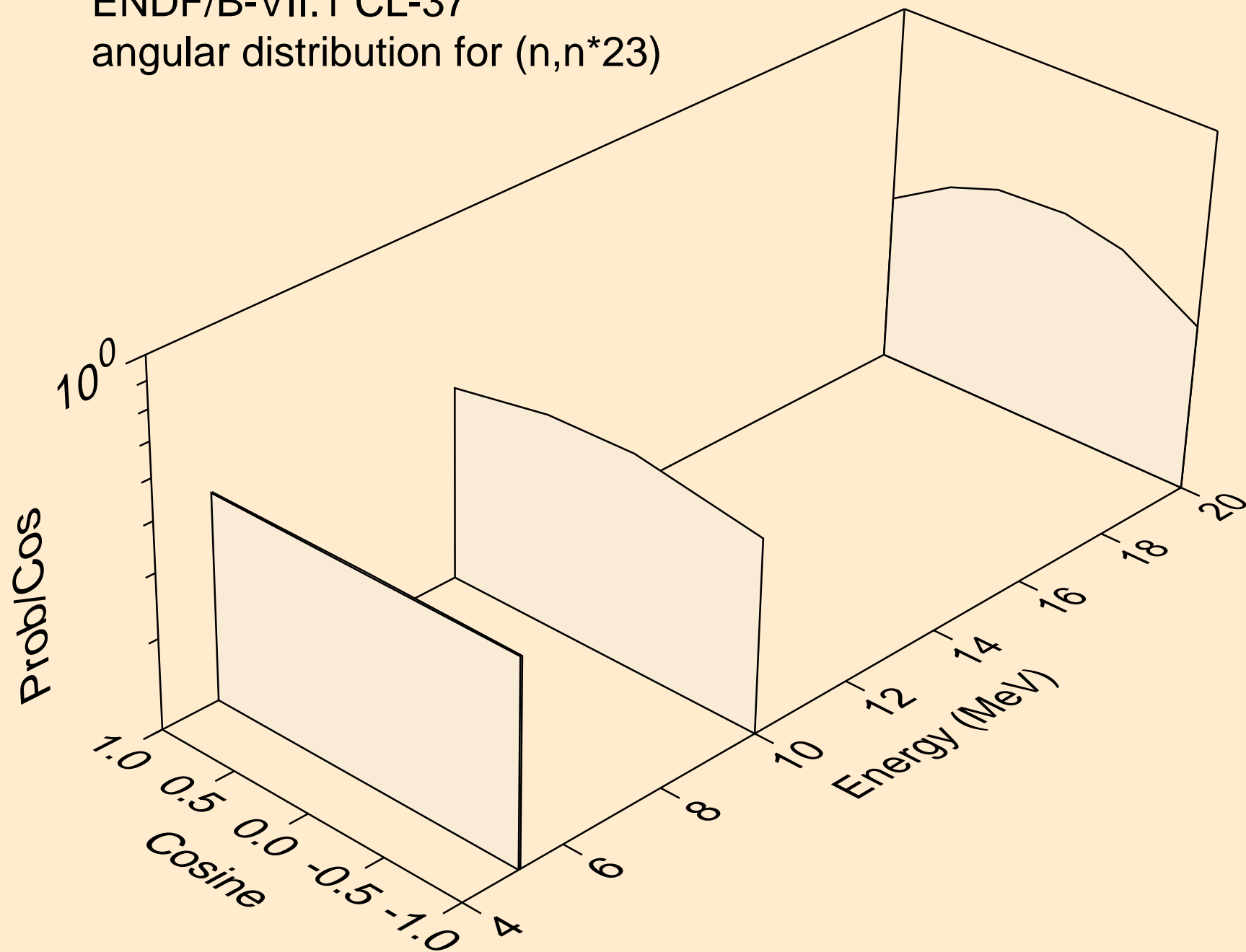

ENDF/B-VII.1 CL-37
angular distribution for (n,n*24)

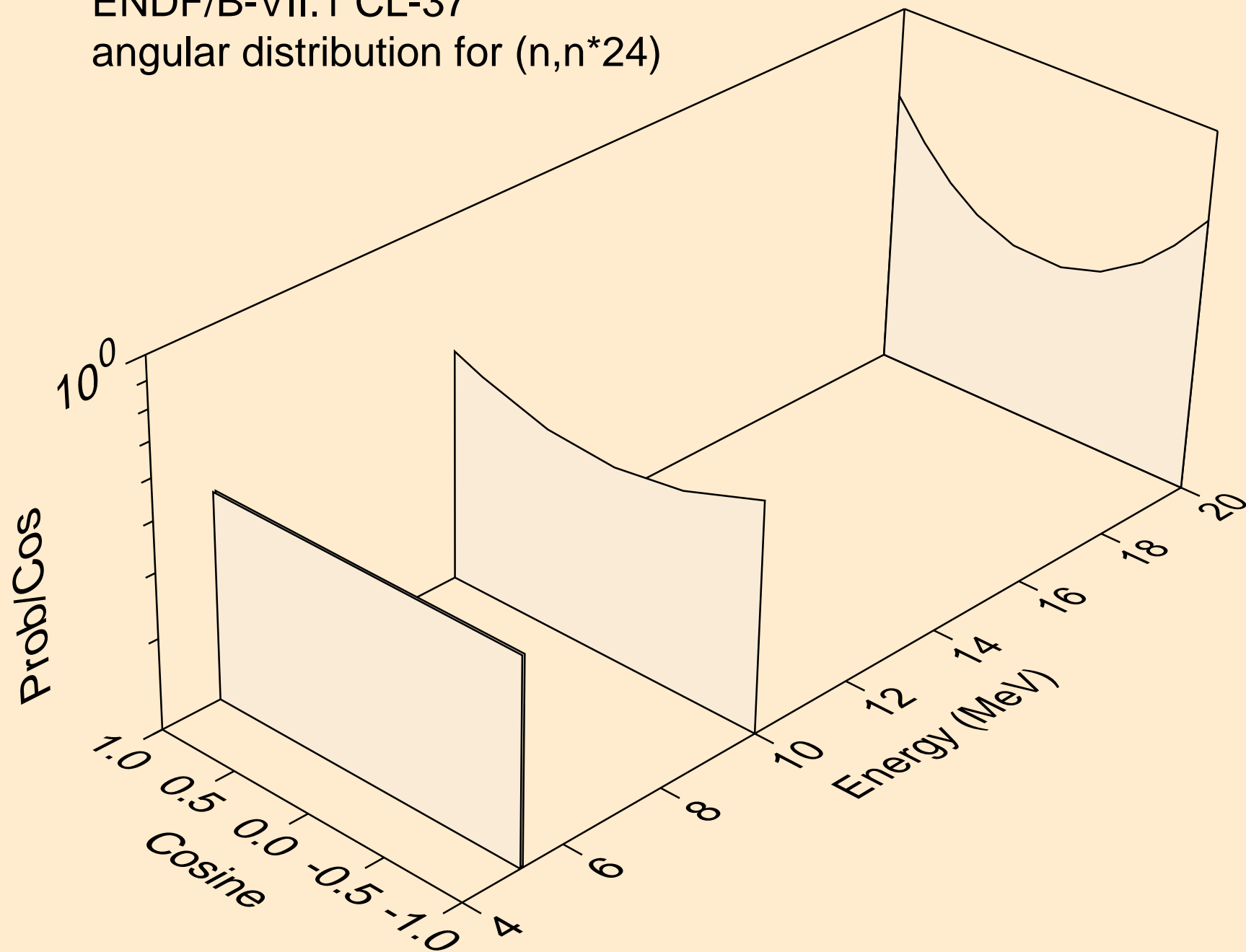

ENDF/B-VII.1 CL-37
angular distribution for (n,n*25)

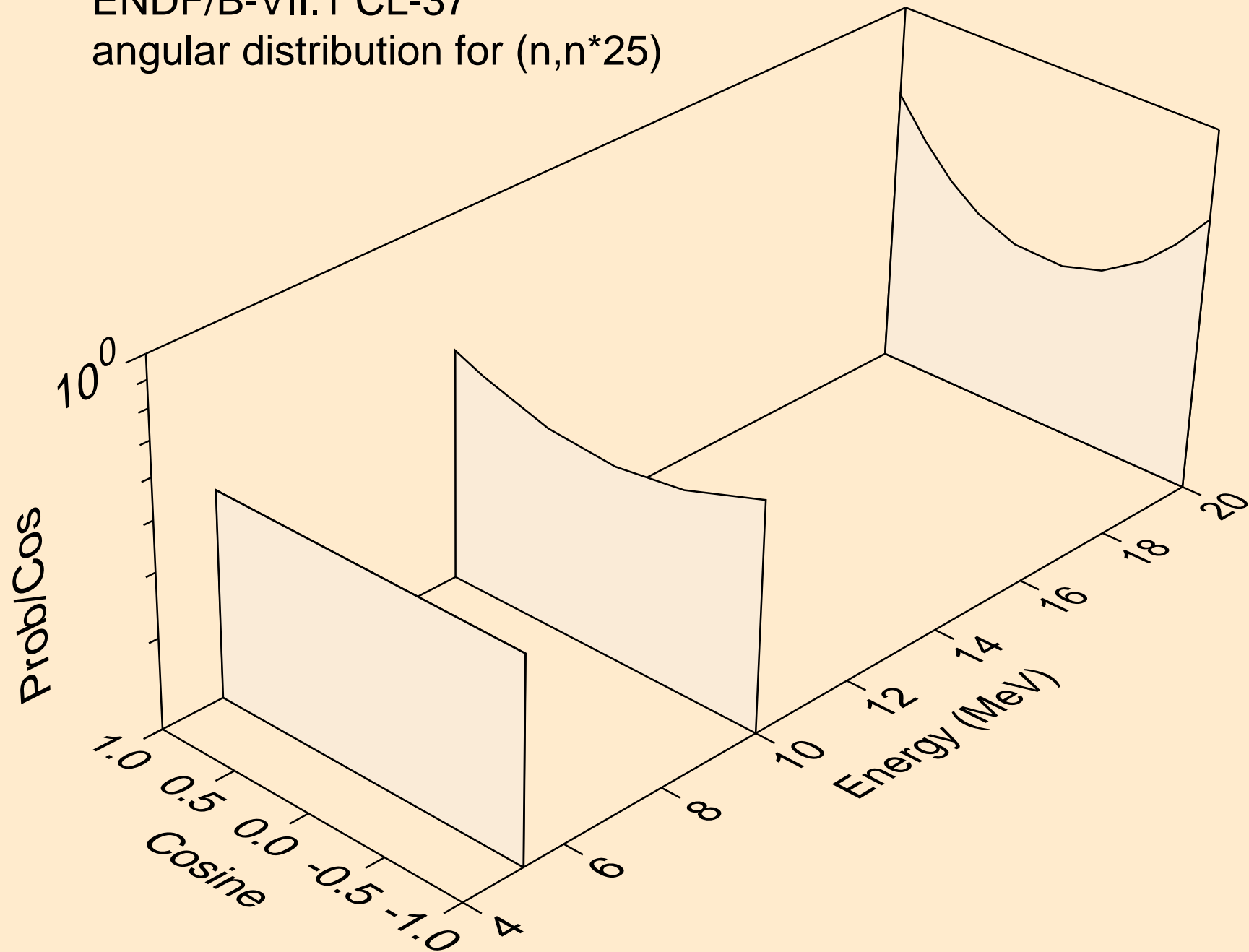

ENDF/B-VII.1 CL-37
angular distribution for (n,n*26)

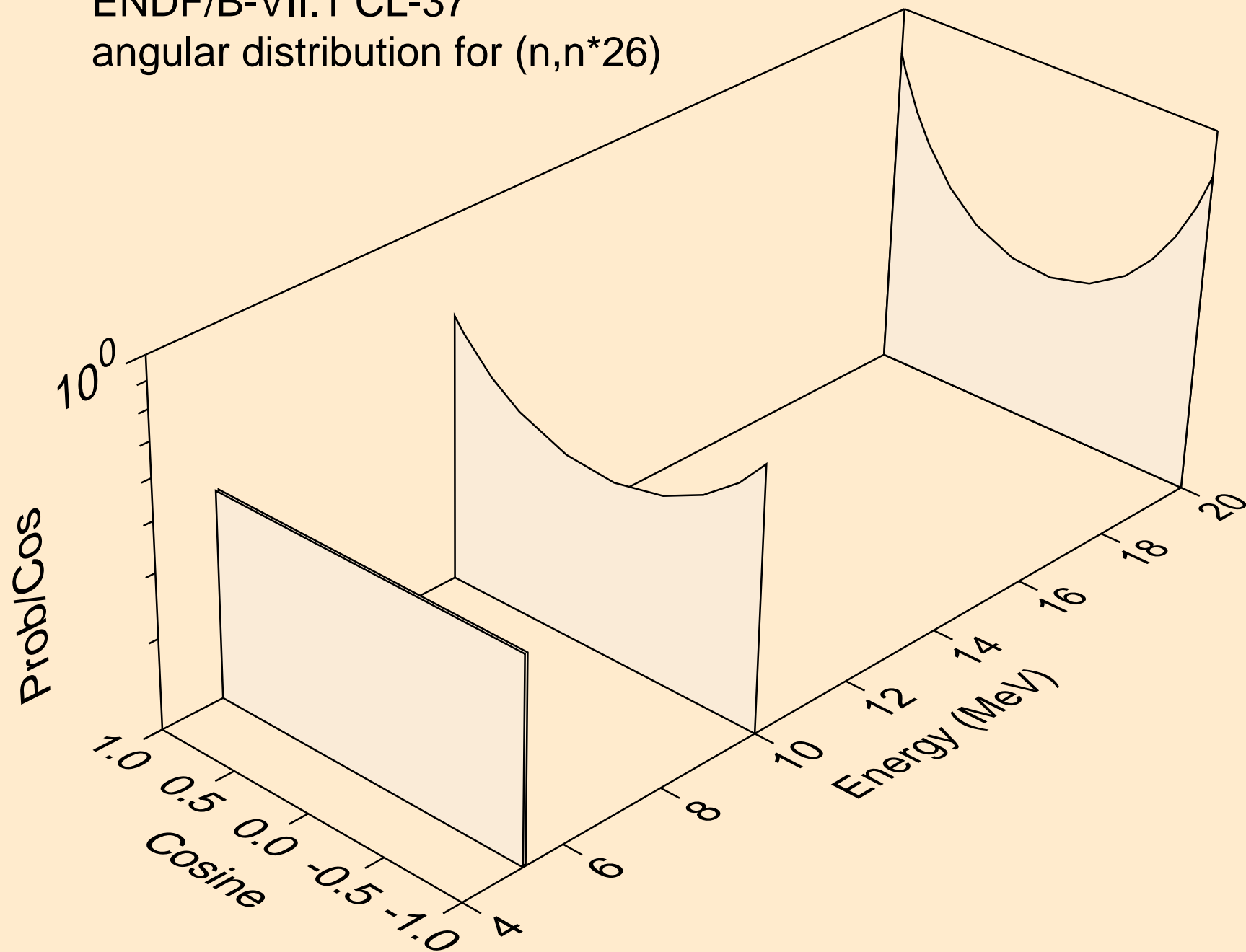

ENDF/B-VII.1 CL-37
angular distribution for (n,n*27)

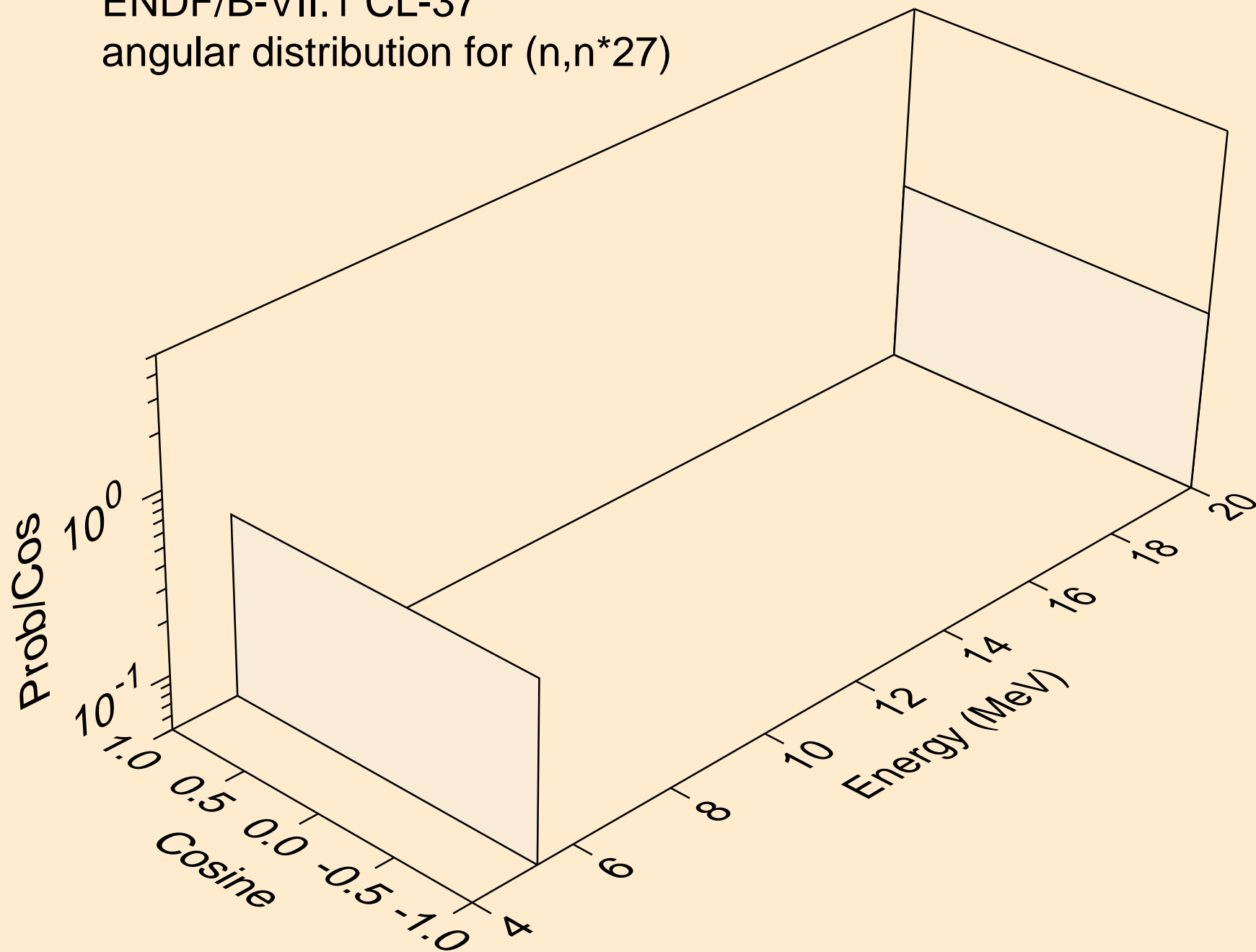

ENDF/B-VII.1 CL-37
Neutron emission for (n,2n)

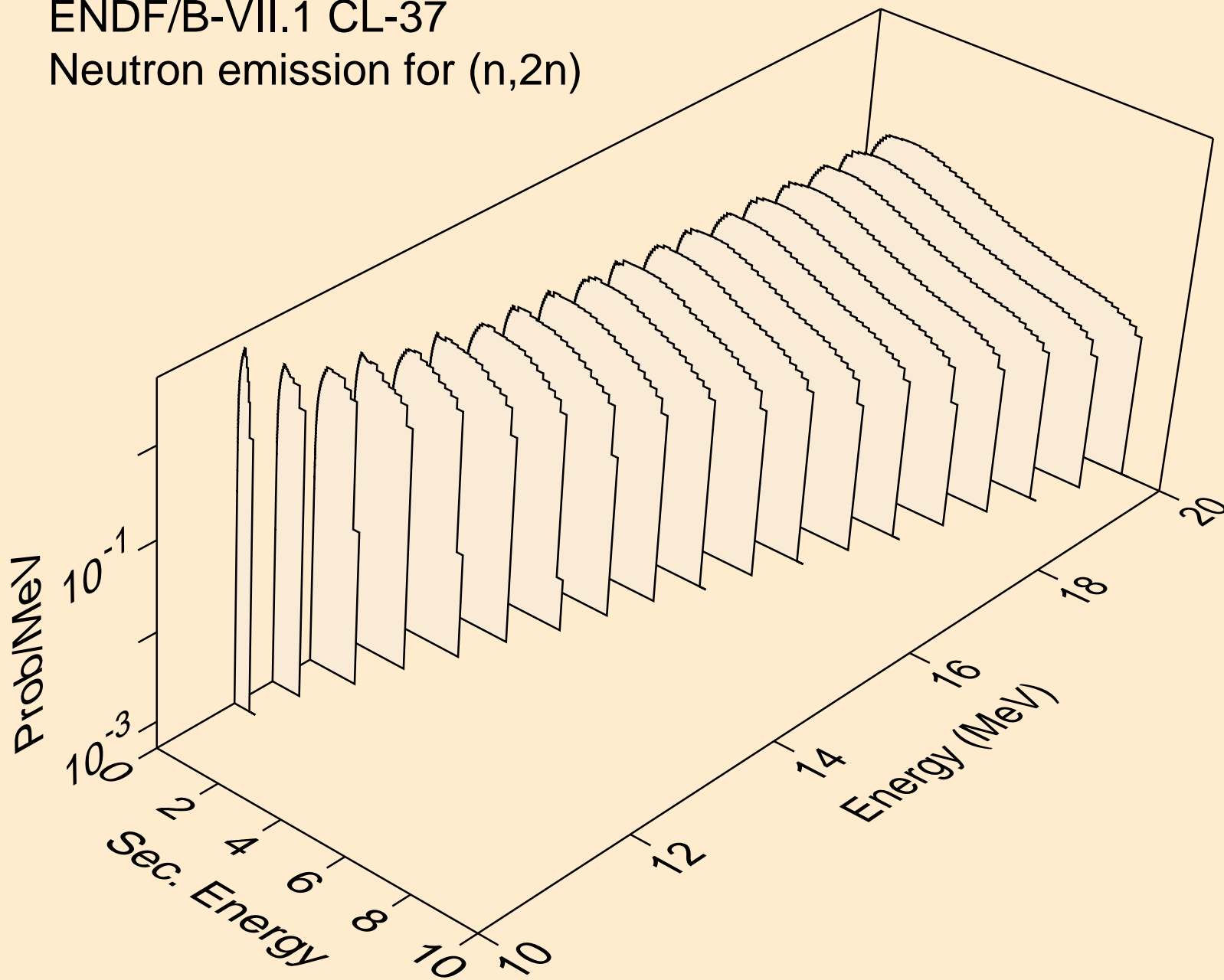

ENDF/B-VII.1 CL-37
Neutron emission for (n,3n)

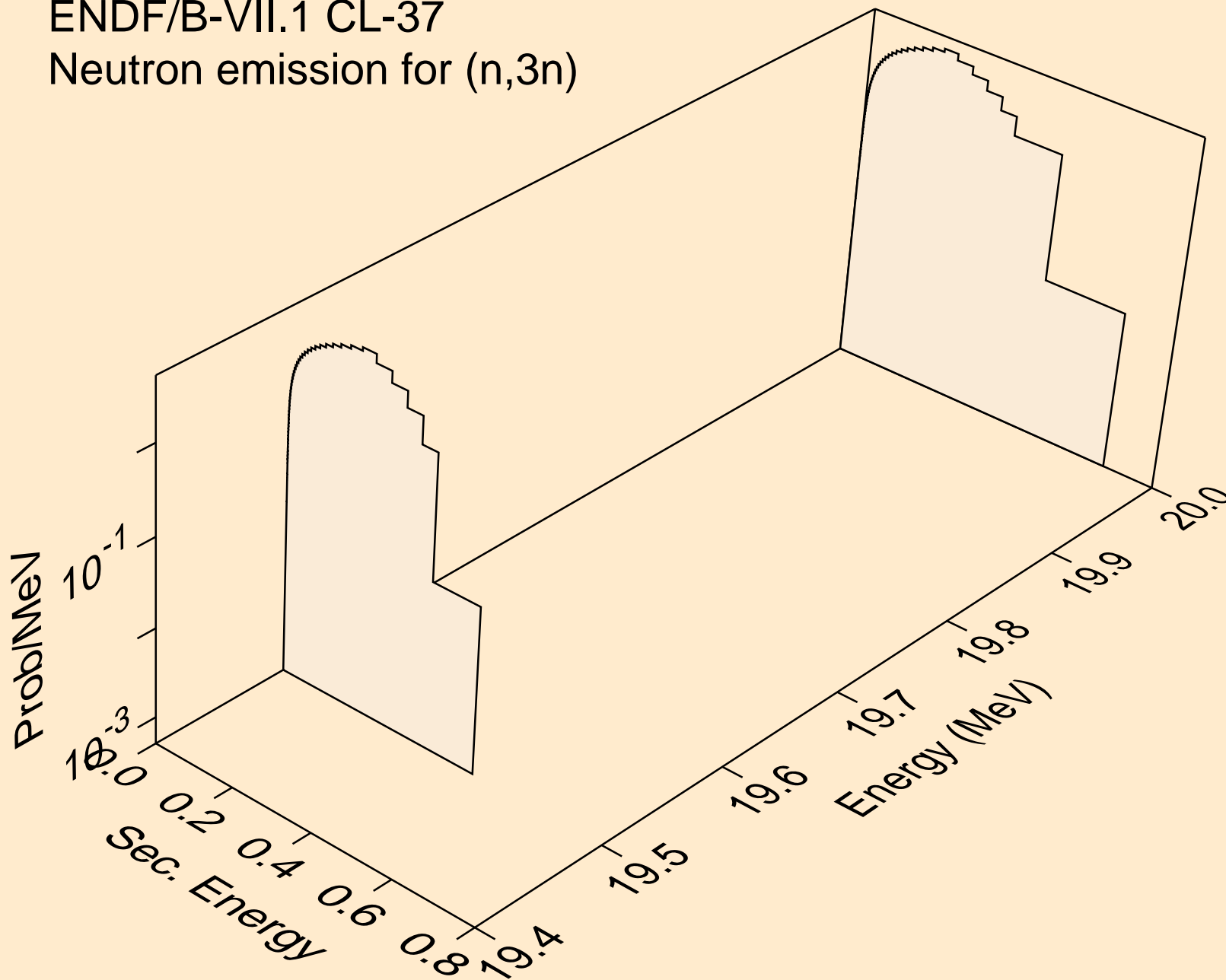

ENDF/B-VII.1 CL-37
Neutron emission for (n,n*)a

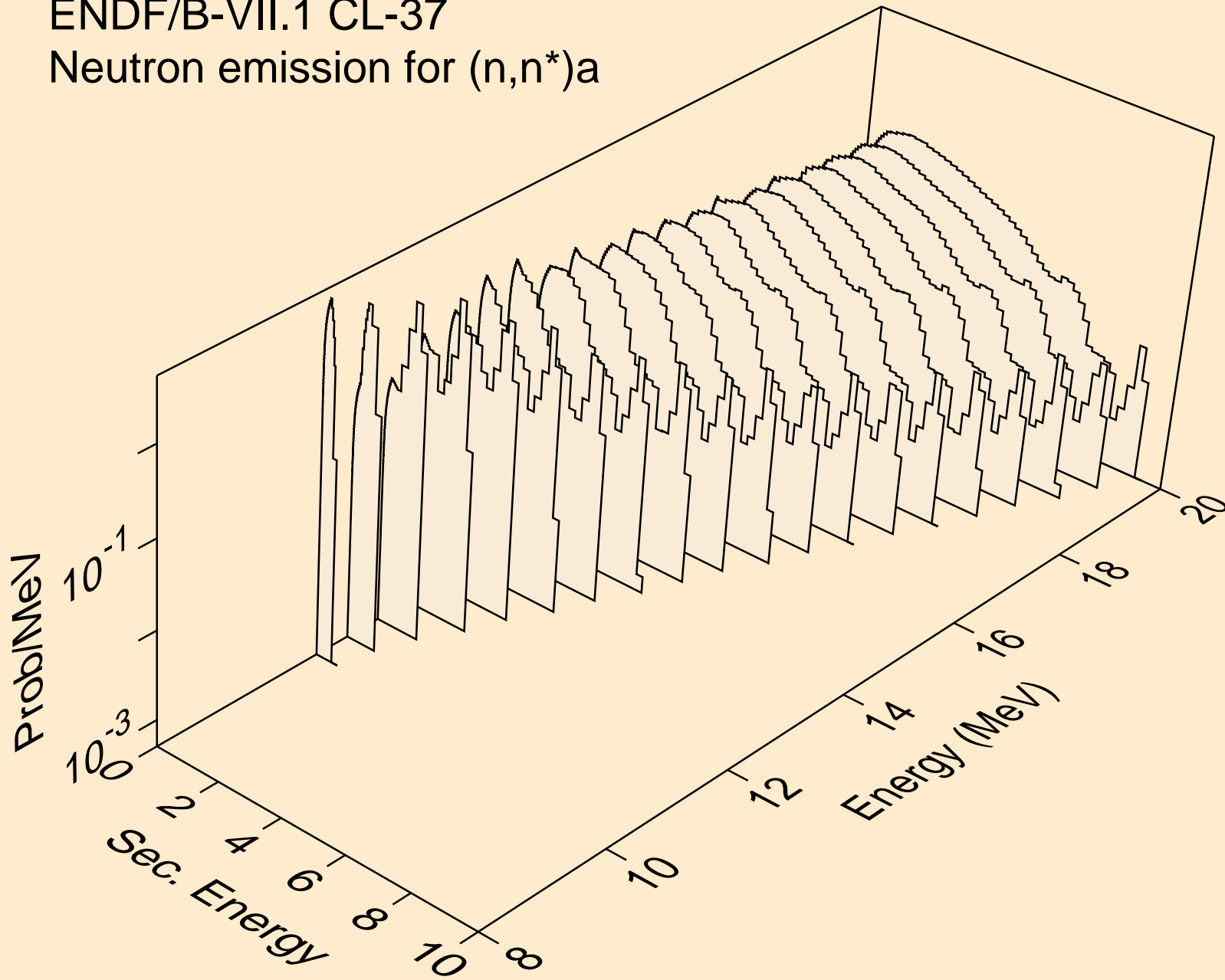

ENDF/B-VII.1 CL-37
Neutron emission for (n,n*)p

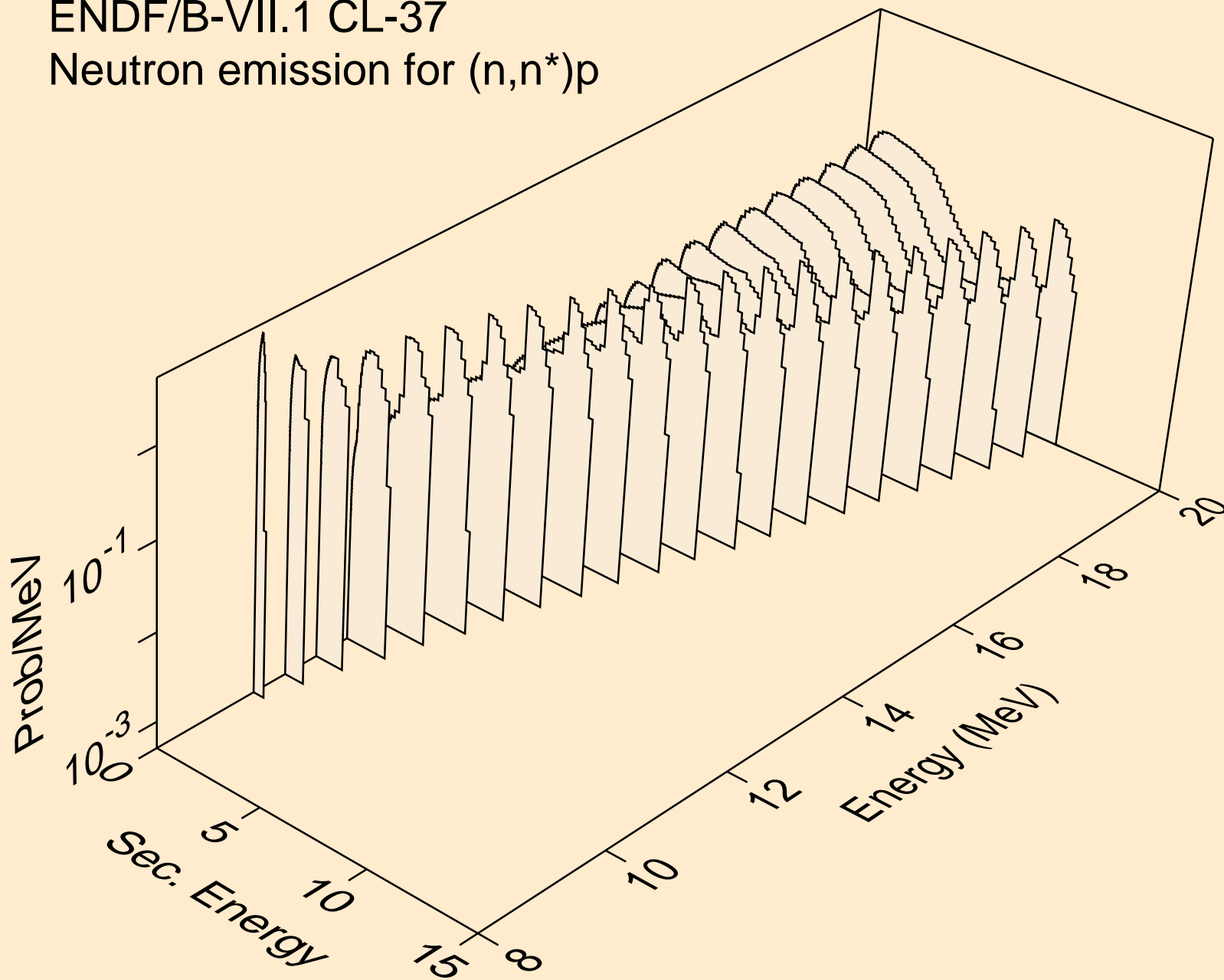

ENDF/B-VII.1 CL-37
Neutron emission for (n,n*)d

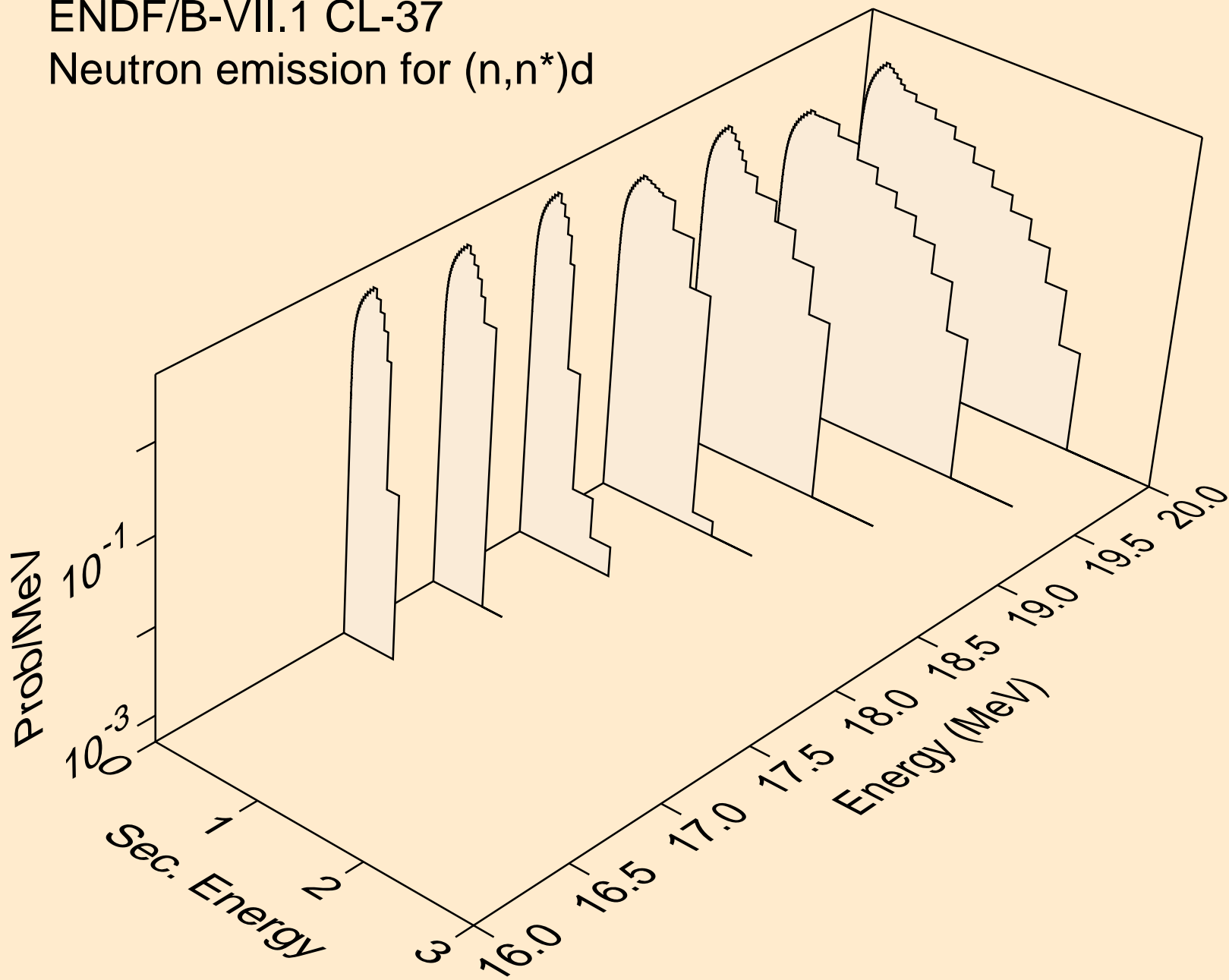

ENDF/B-VII.1 CL-37
Neutron emission for (n,n*c)

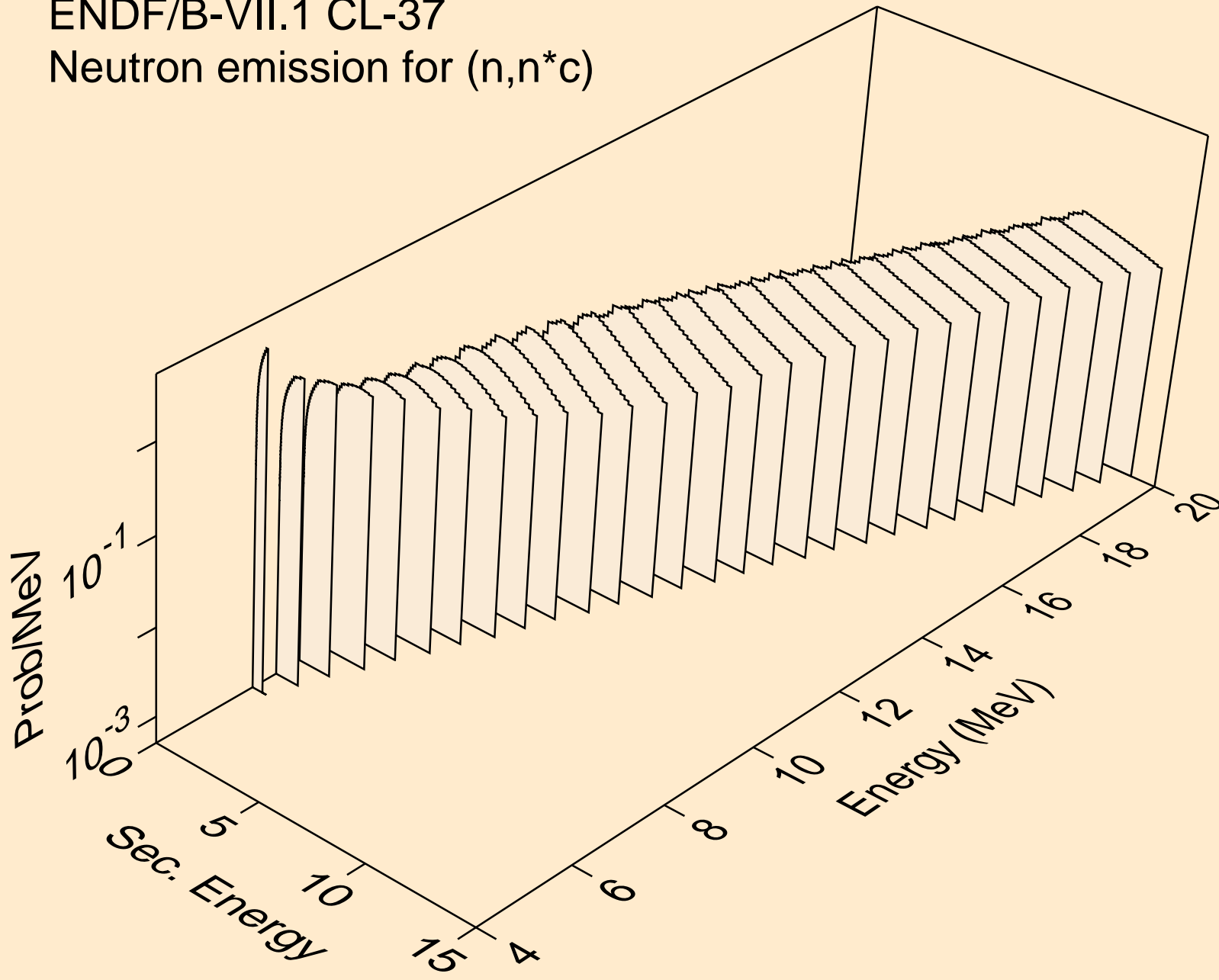

ENDF/B-VII.1 CL-37
Photon emission for (n,gma)

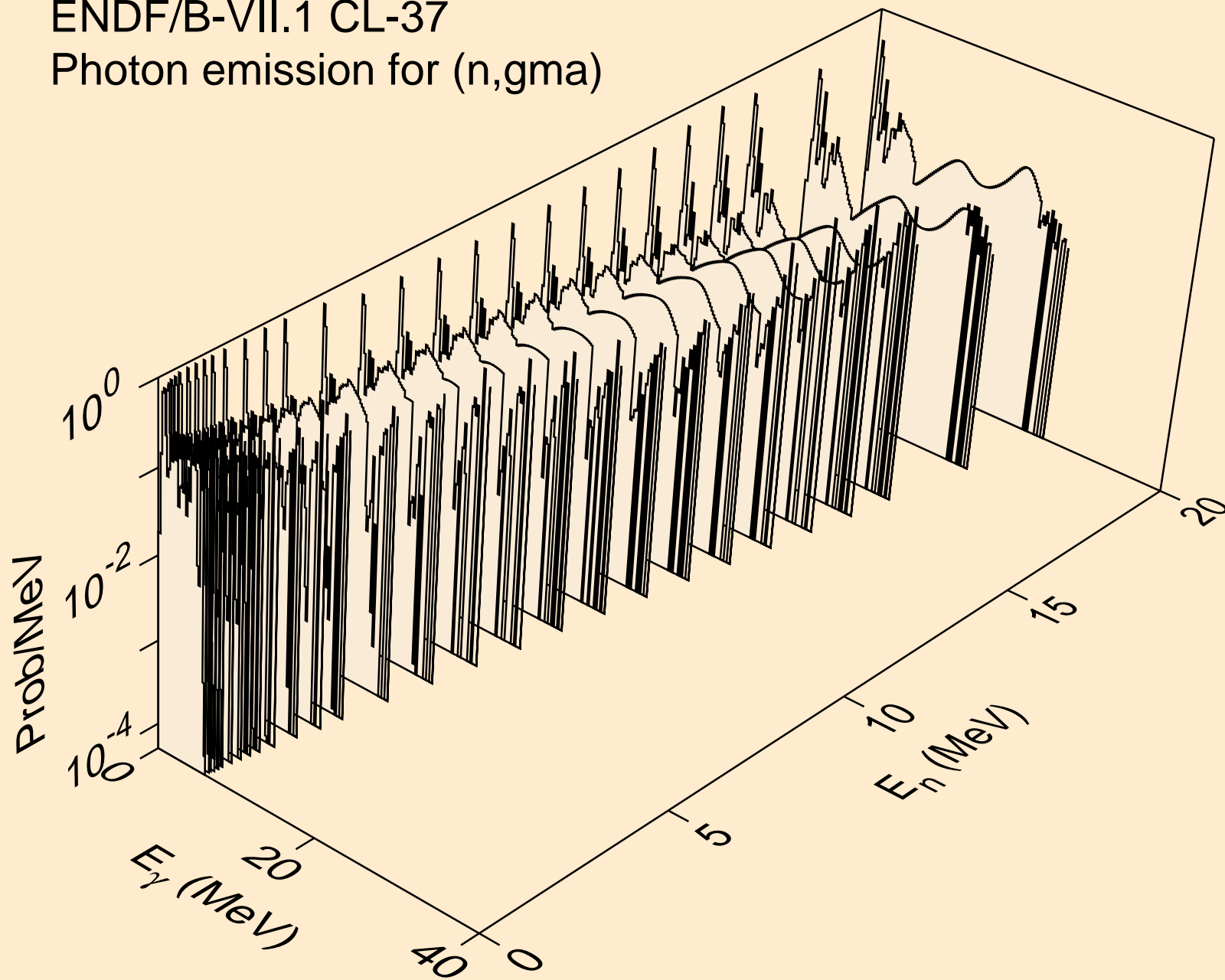

ENDF/B-VII.1 CL-37
Photon emission for (n,2n)

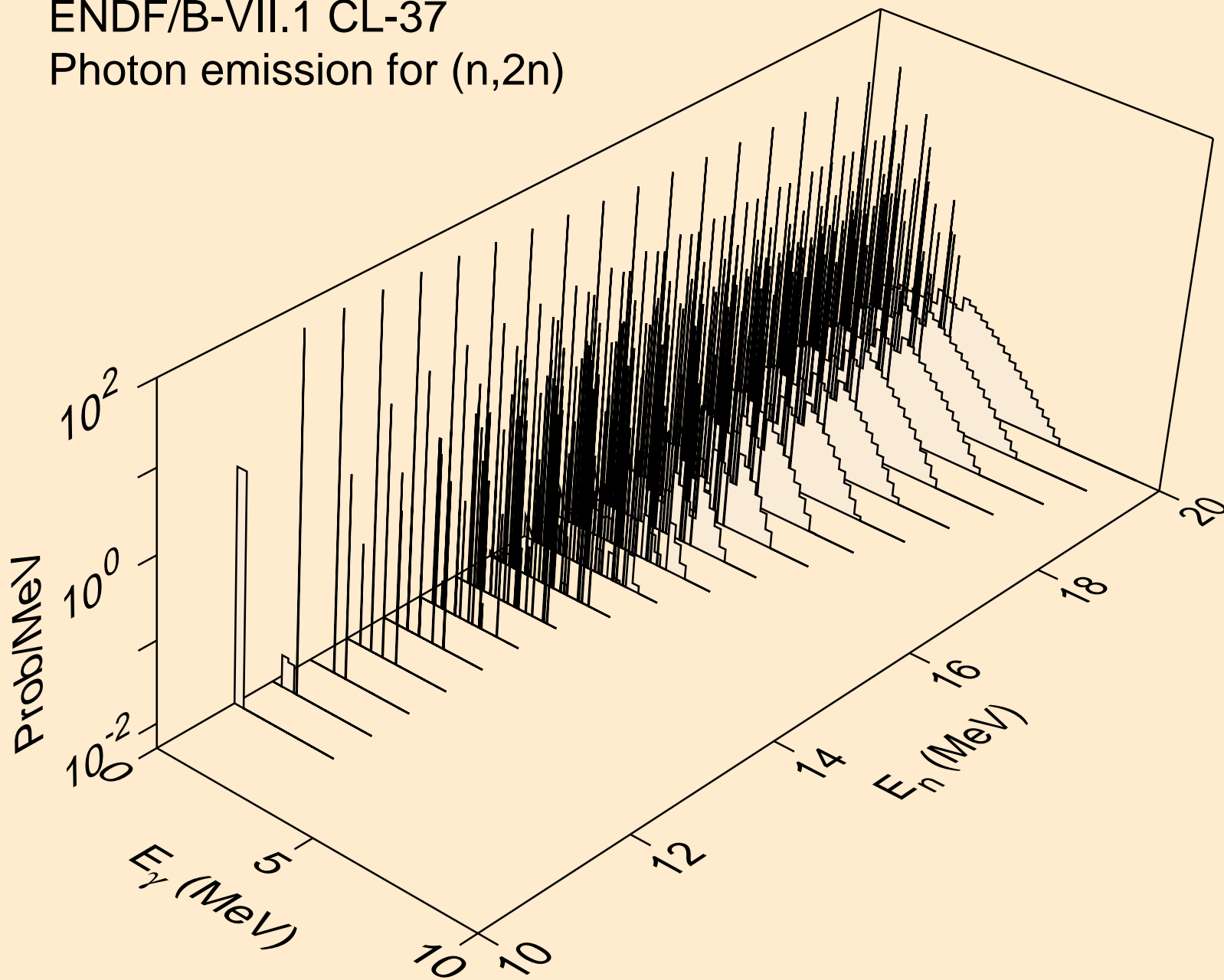

ENDF/B-VII.1 CL-37
Photon emission for (n,3n)

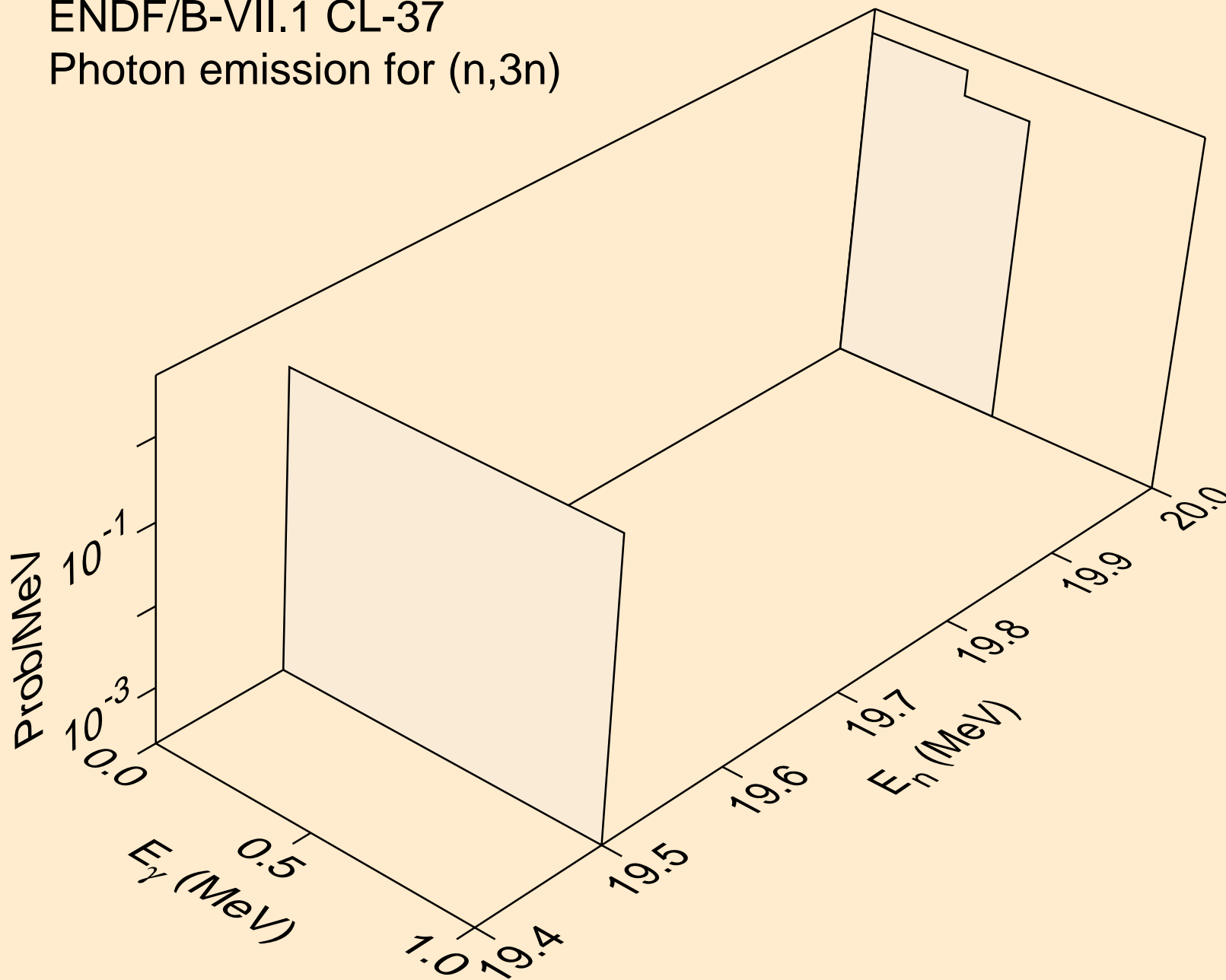

ENDF/B-VII.1 CL-37
Photon emission for (n,n*)a

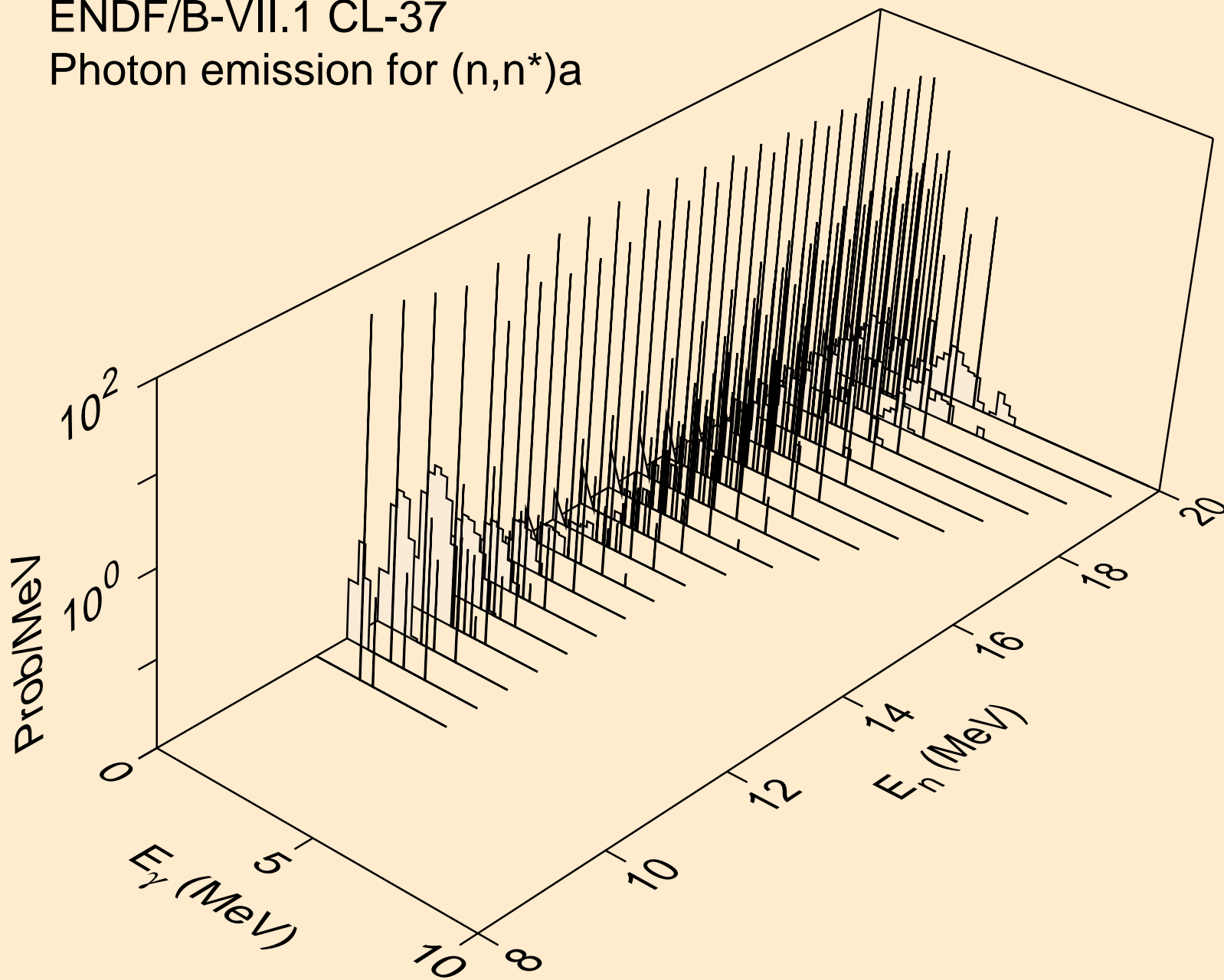

ENDF/B-VII.1 CL-37
Photon emission for (n,n*)p

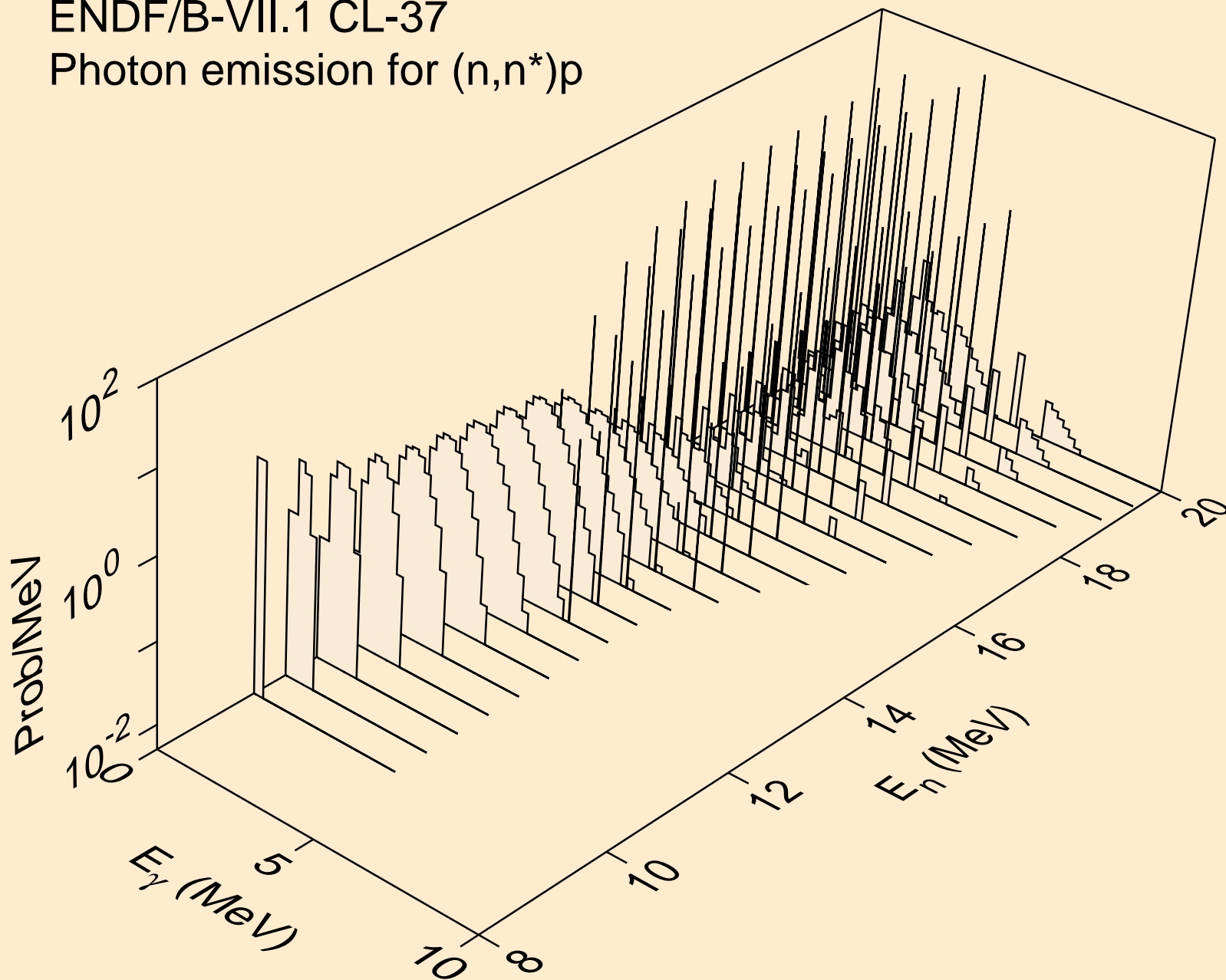

ENDF/B-VII.1 CL-37
Photon emission for (n,n*)d

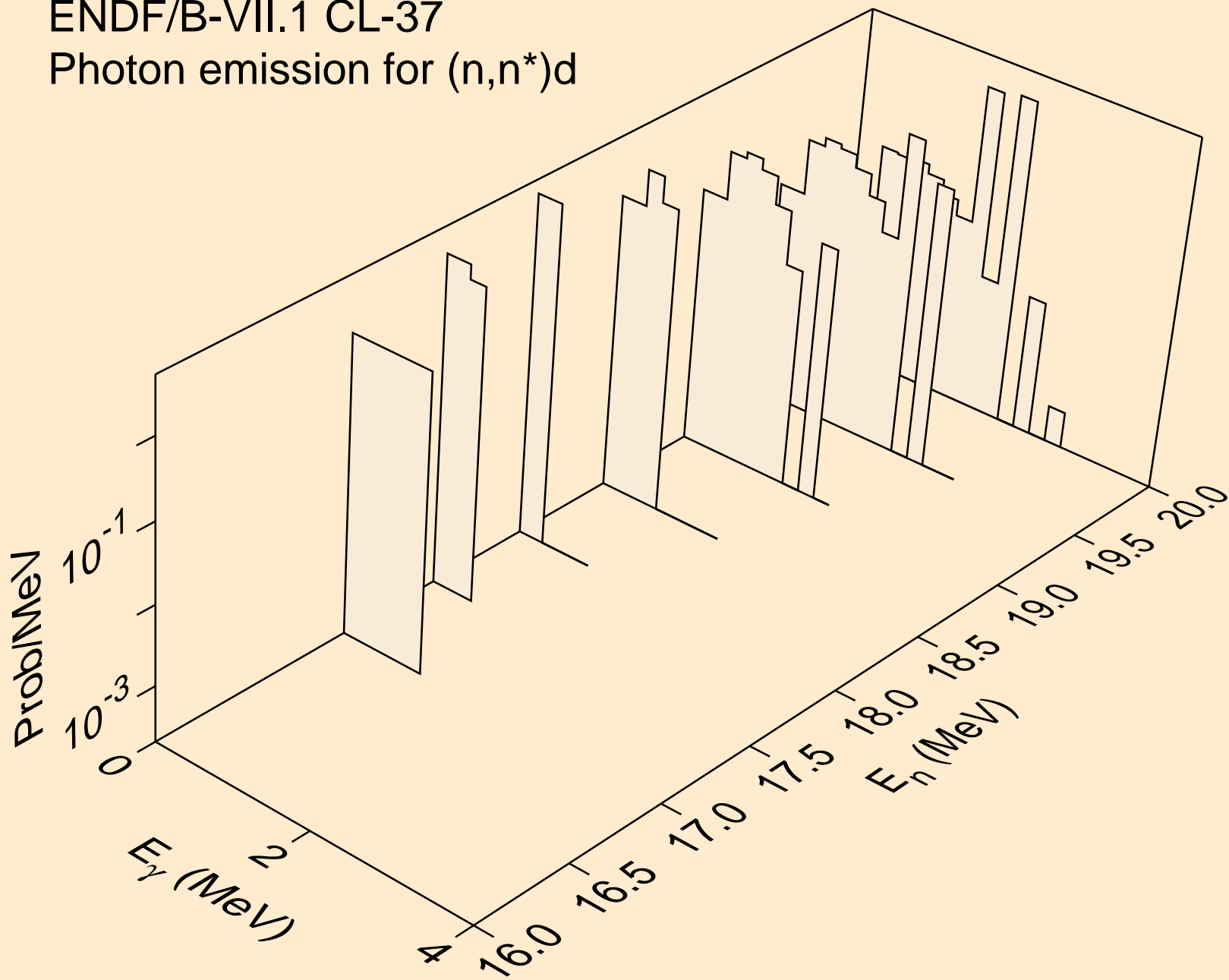

ENDF/B-VII.1 CL-37
Photon emission for (n,n*1)

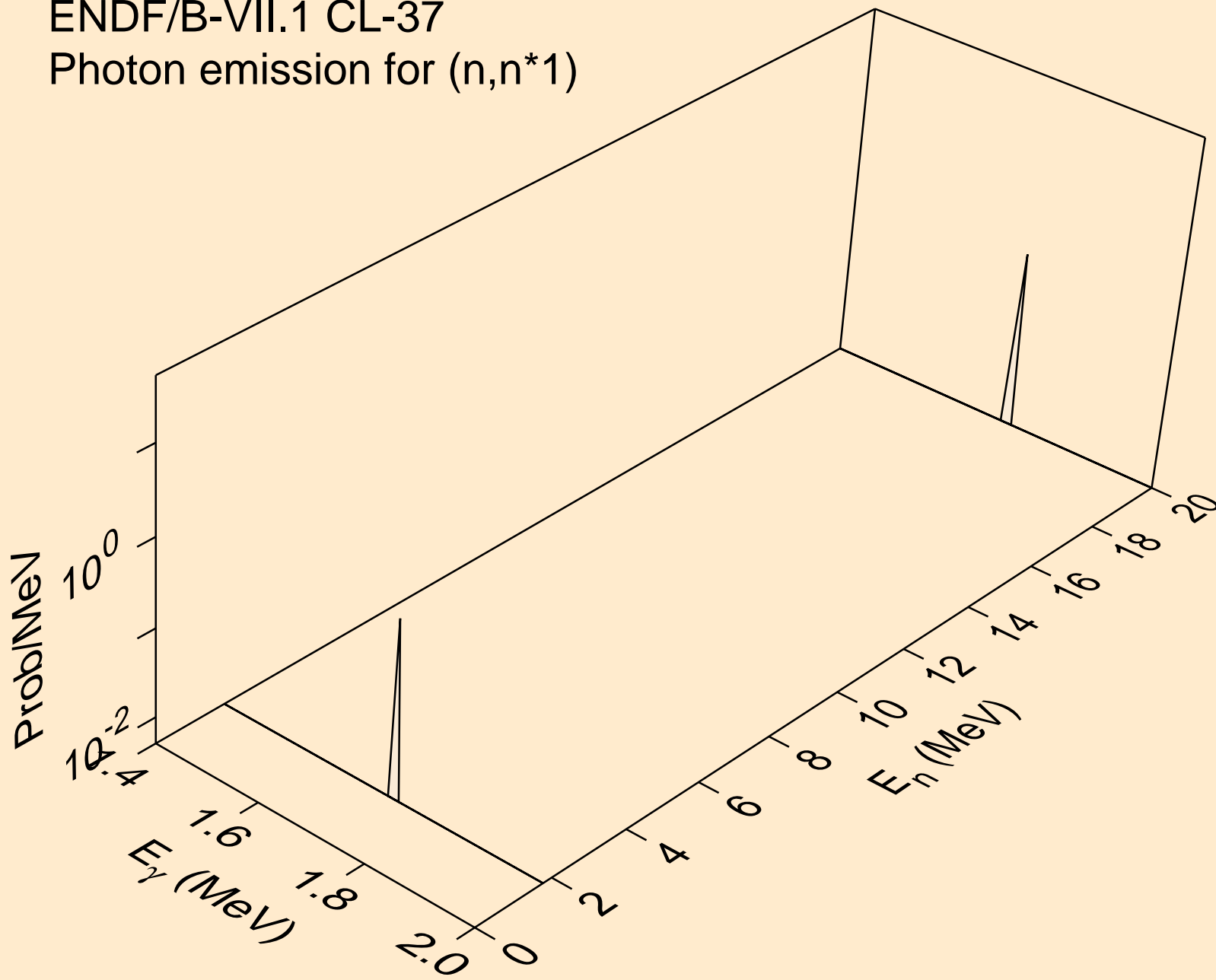

ENDF/B-VII.1 CL-37
Photon emission for (n,n*2)

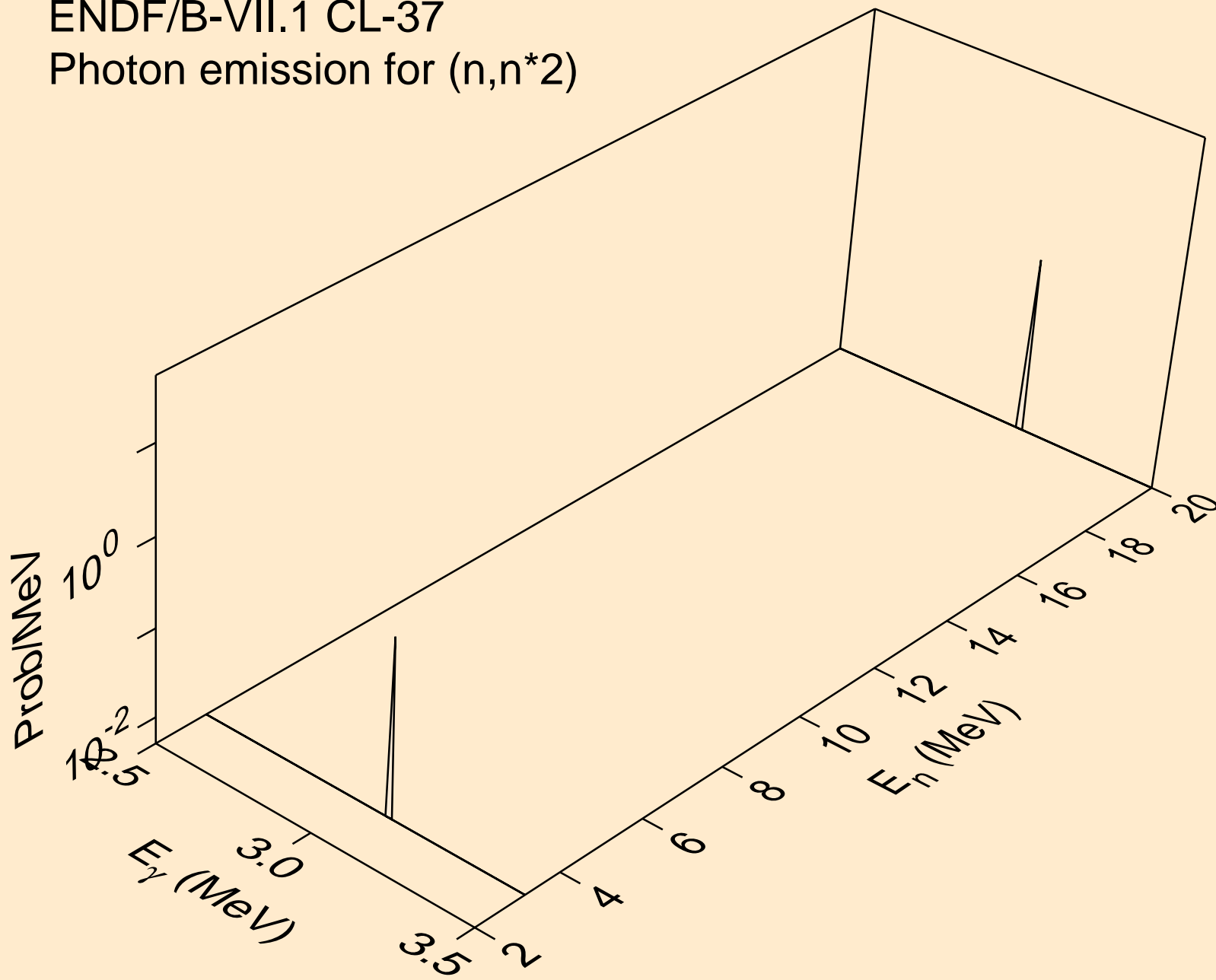

ENDF/B-VII.1 CL-37
Photon emission for (n,n*3)

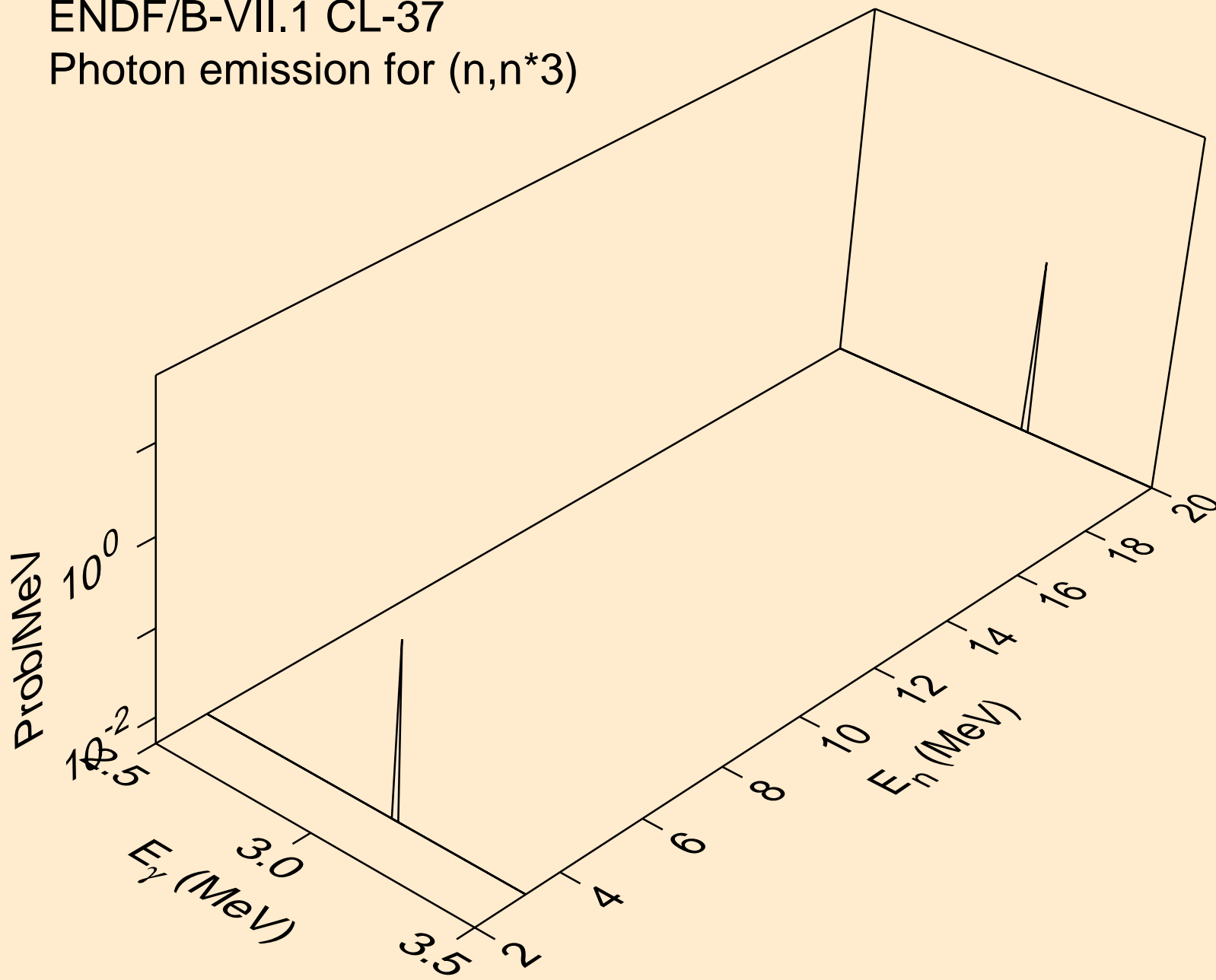

ENDF/B-VII.1 CL-37
Photon emission for (n,n*4)

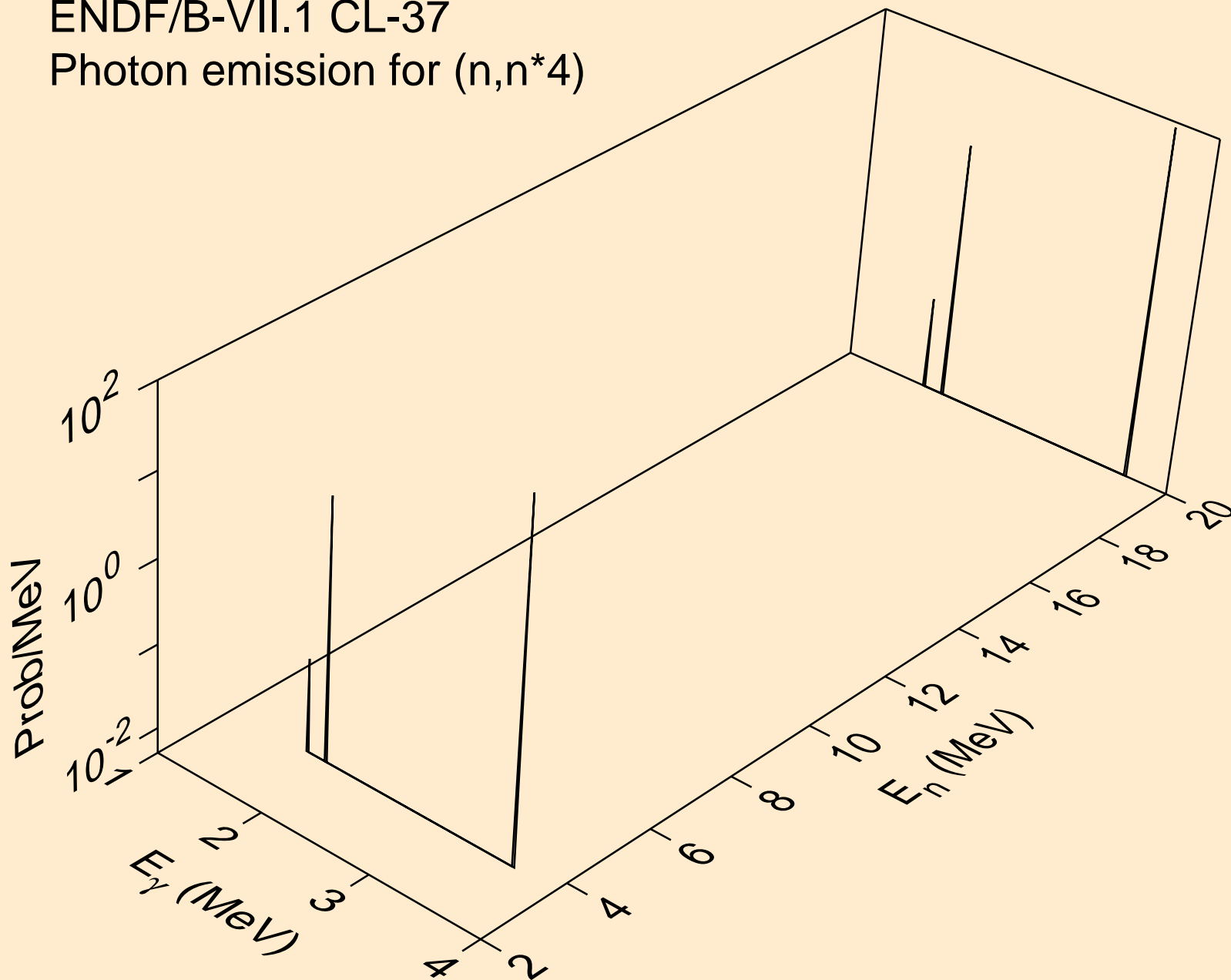

ENDF/B-VII.1 CL-37
Photon emission for (n,n*5)

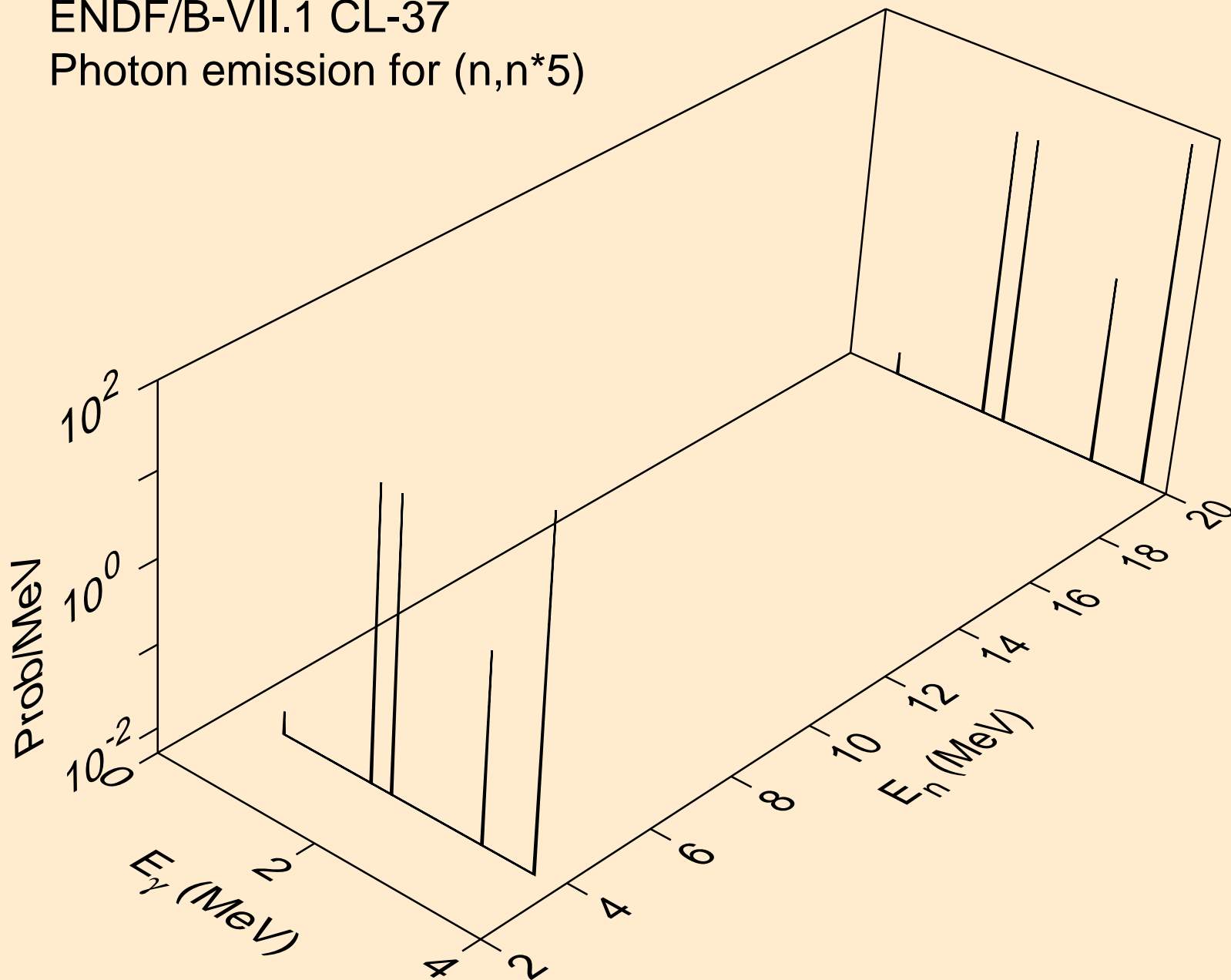

ENDF/B-VII.1 CL-37
Photon emission for (n,n*6)

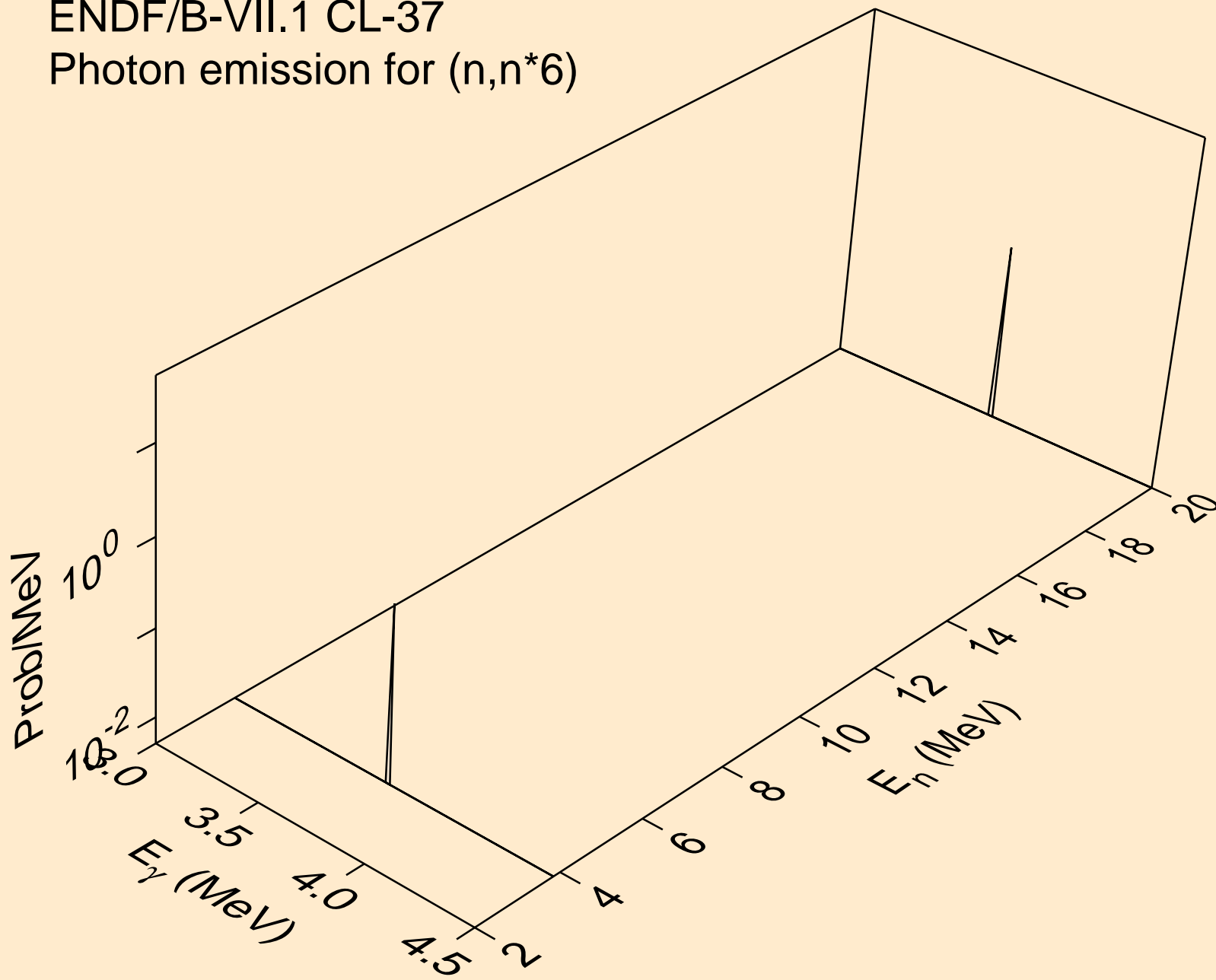

ENDF/B-VII.1 CL-37
Photon emission for (n,n*7)

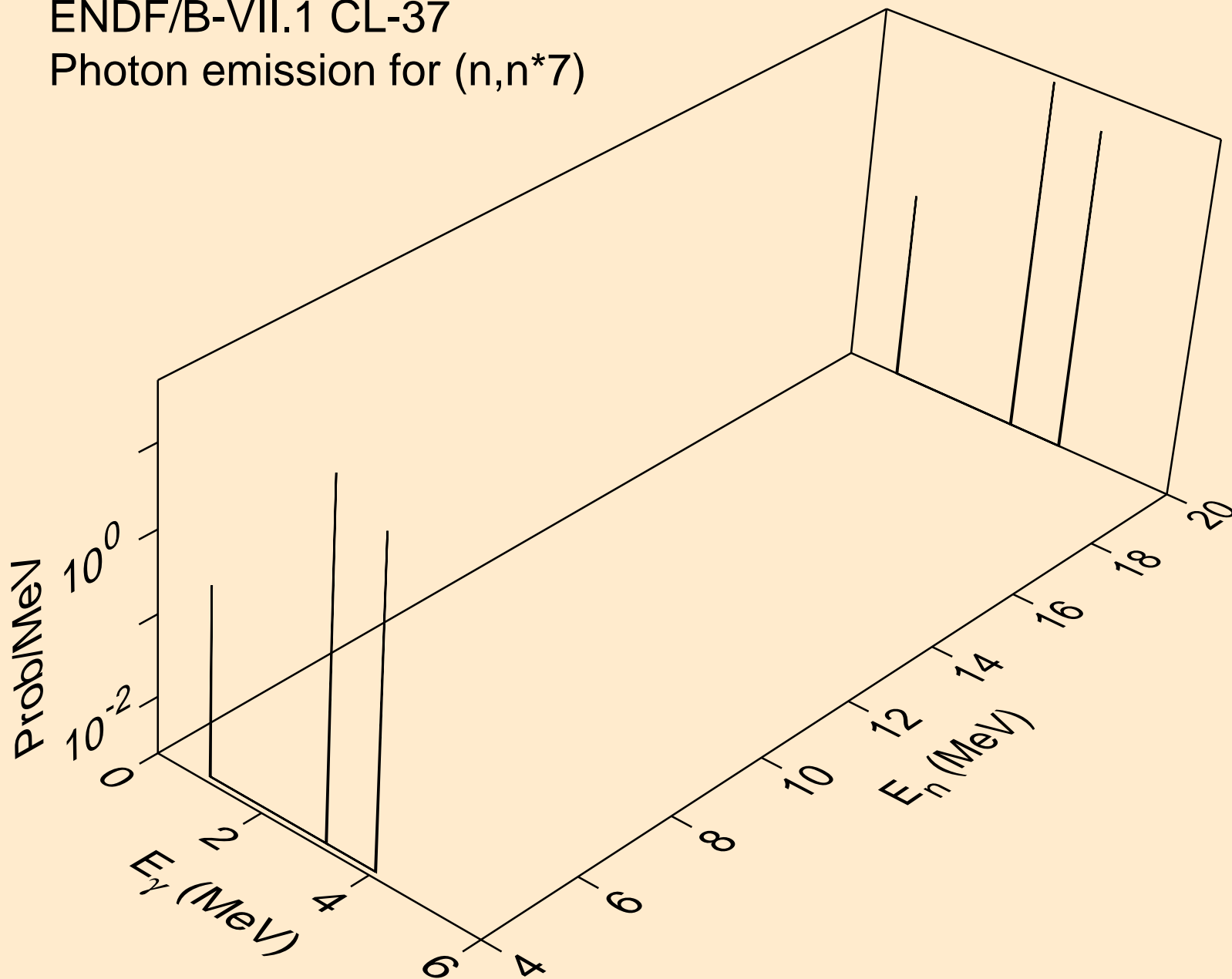

ENDF/B-VII.1 CL-37
Photon emission for (n,n*8)

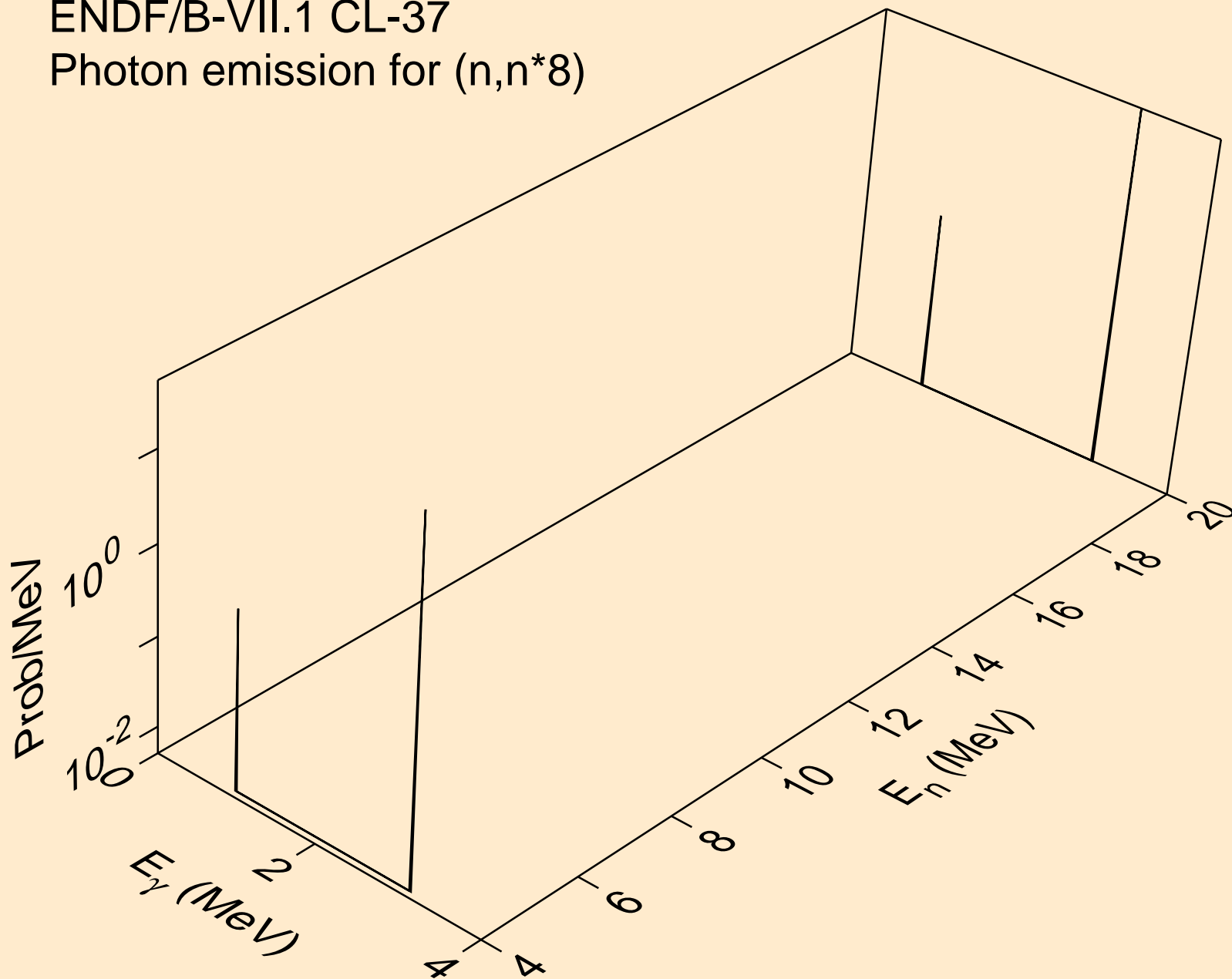

ENDF/B-VII.1 CL-37
Photon emission for (n,n*9)

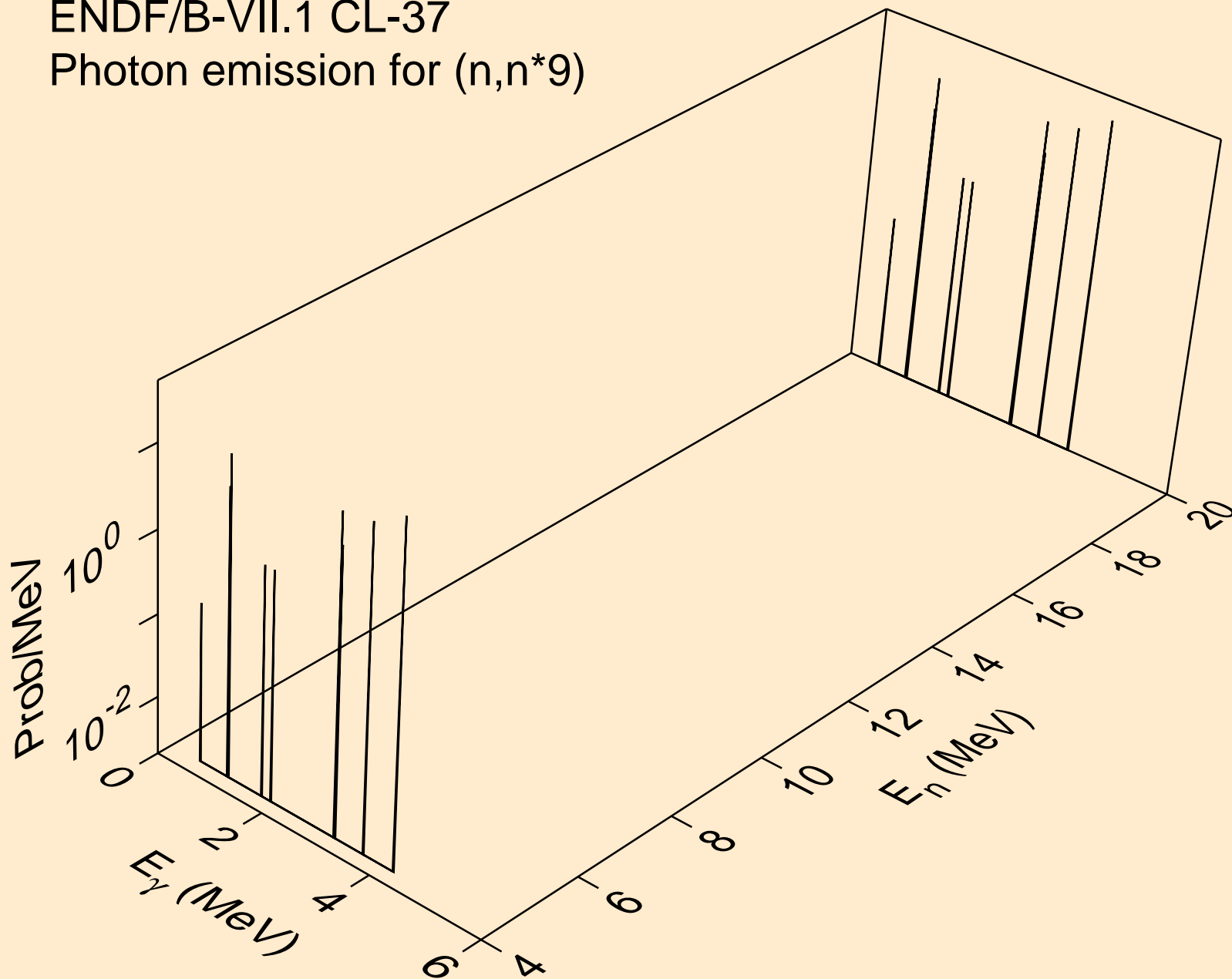

ENDF/B-VII.1 CL-37
Photon emission for (n,n*10)

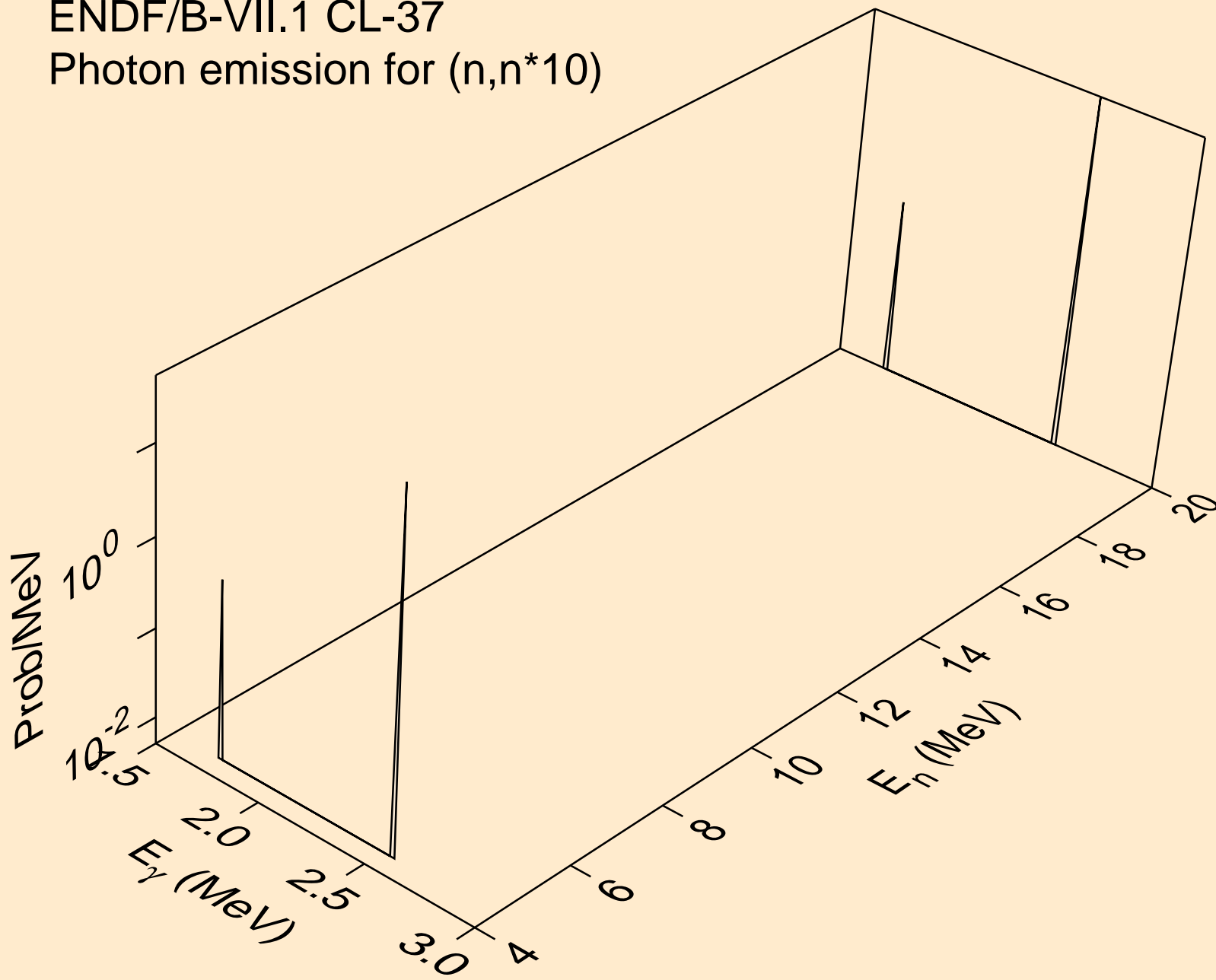

ENDF/B-VII.1 CL-37
Photon emission for (n,n*11)

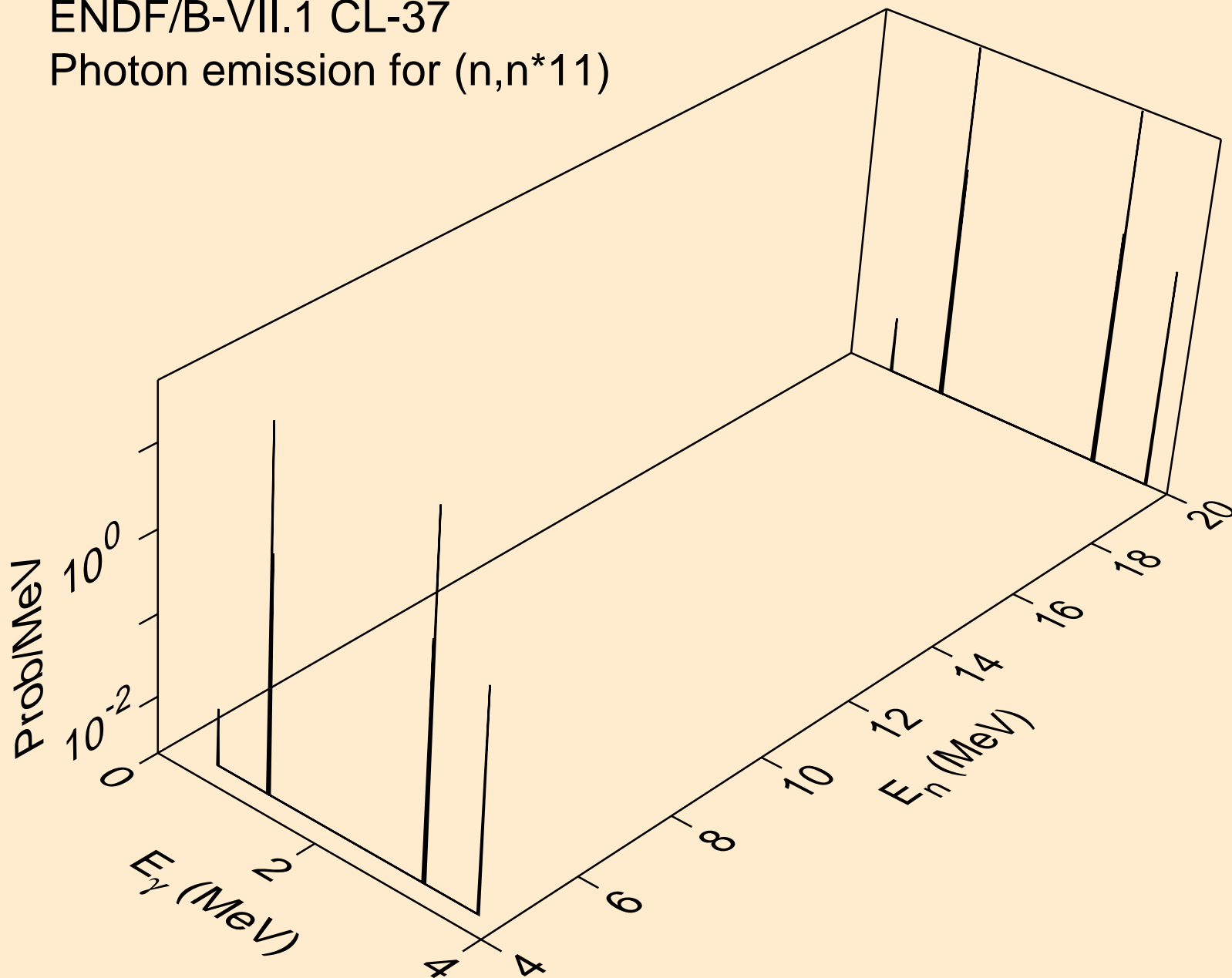

ENDF/B-VII.1 CL-37
Photon emission for (n,n*12)

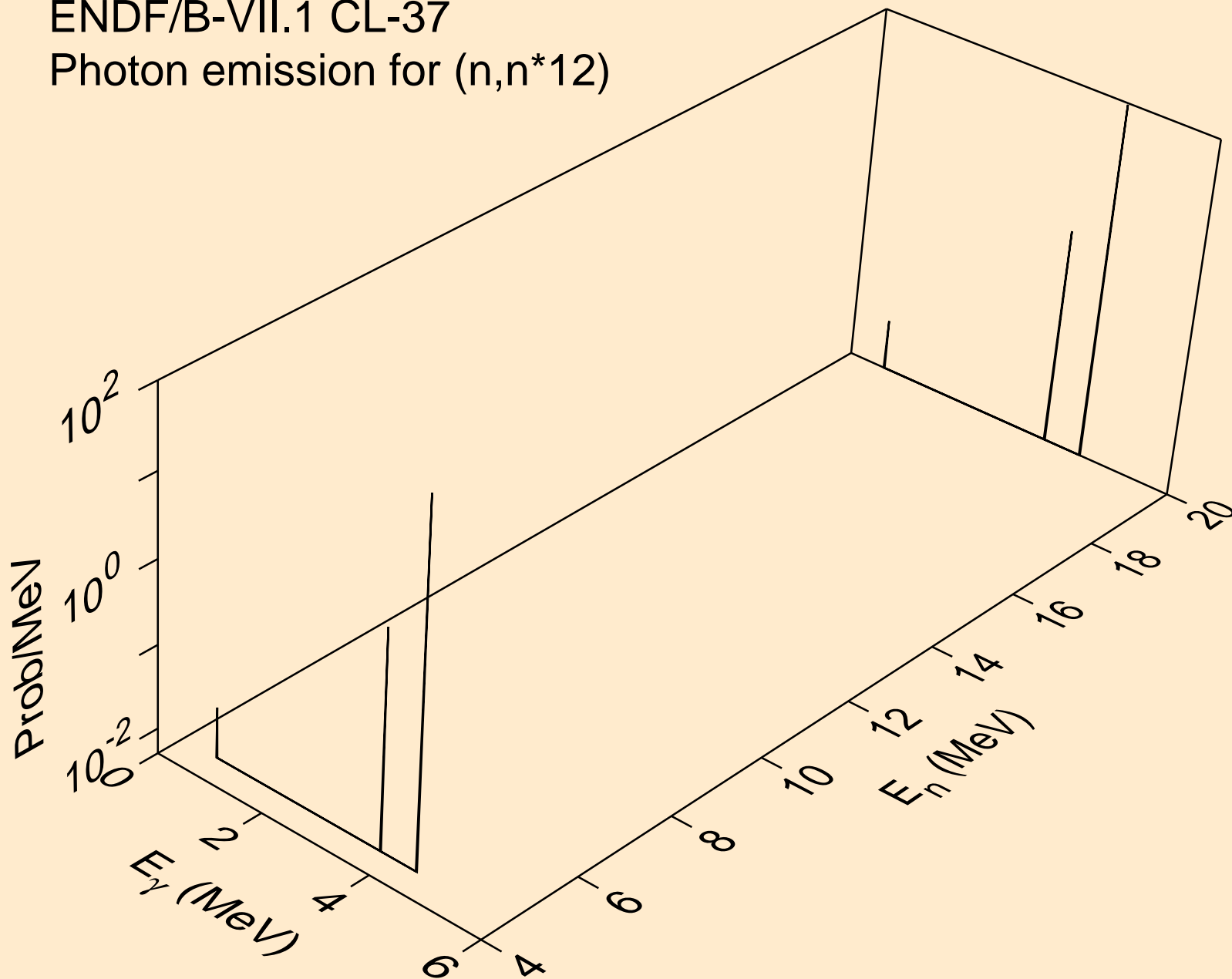

ENDF/B-VII.1 CL-37
Photon emission for (n,n*13)

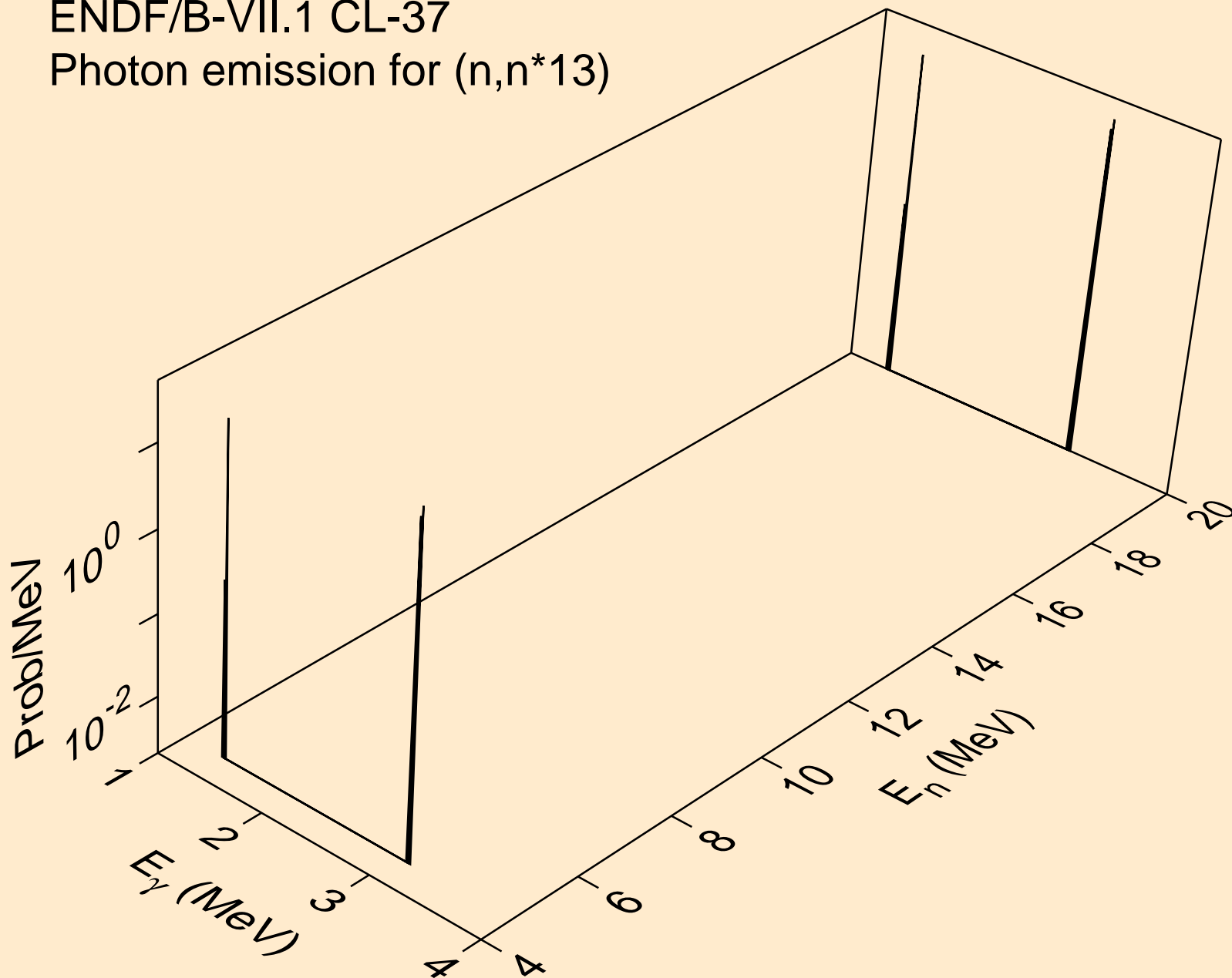

ENDF/B-VII.1 CL-37
Photon emission for (n,n*14)

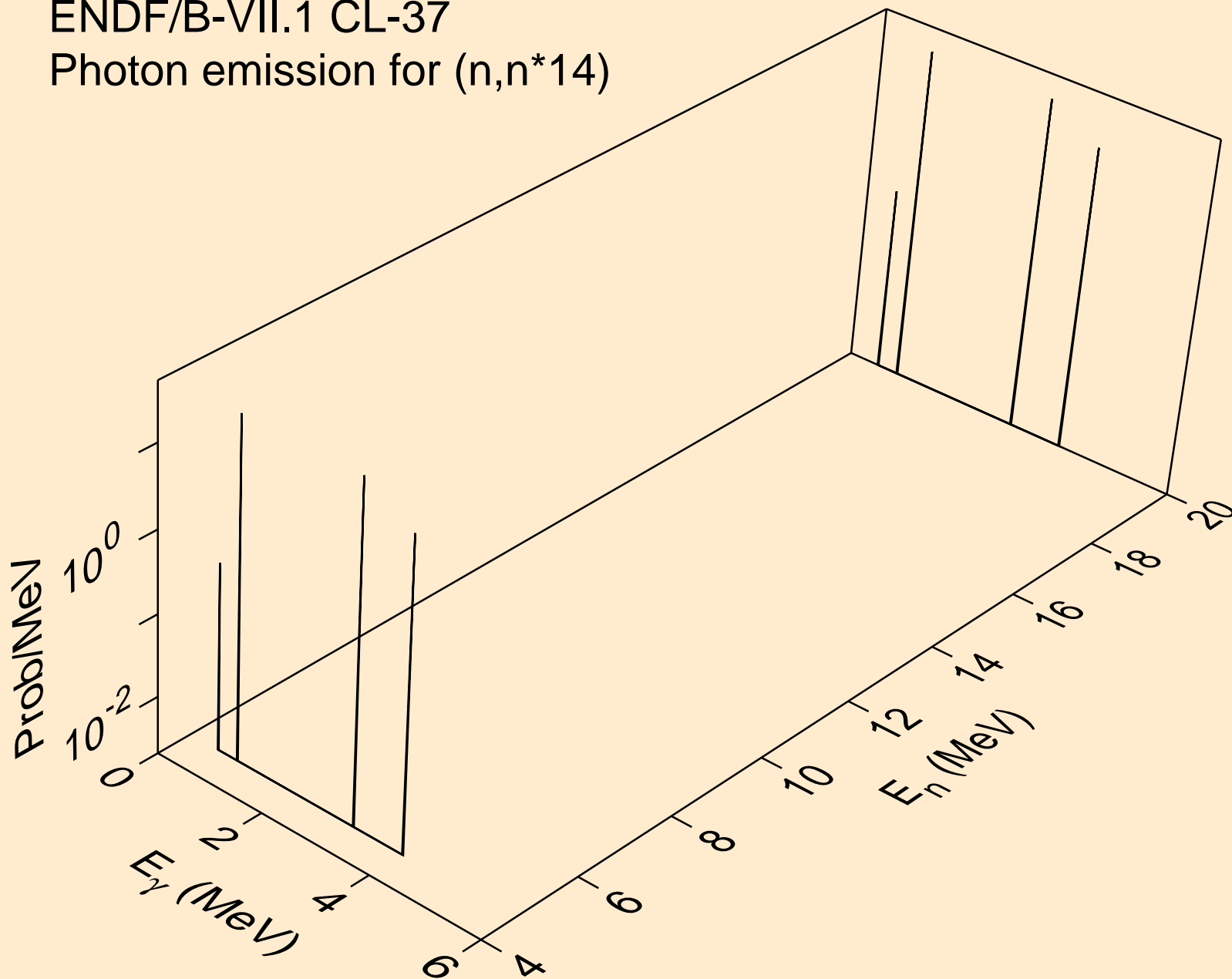

ENDF/B-VII.1 CL-37
Photon emission for (n,n*15)

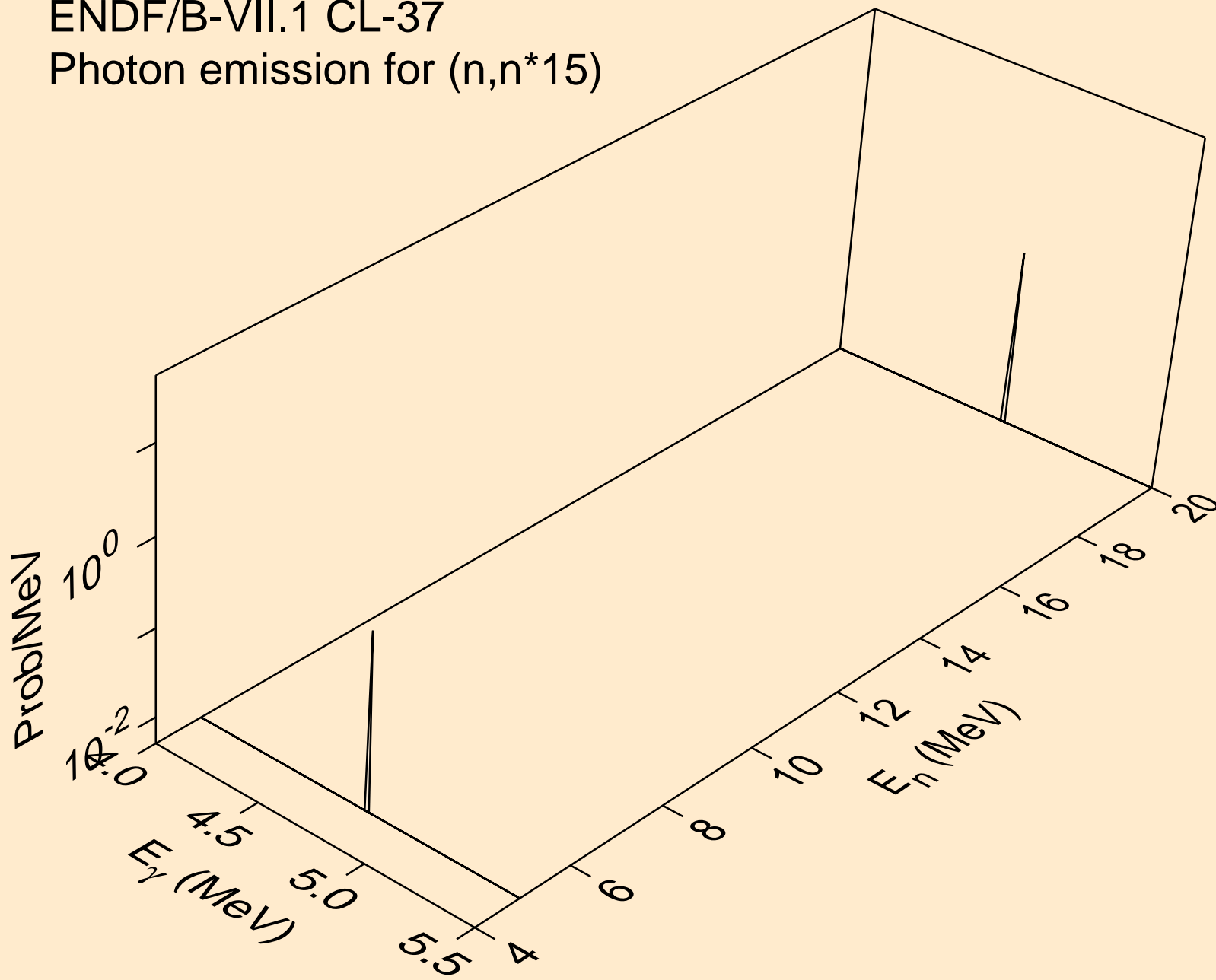

ENDF/B-VII.1 CL-37
Photon emission for (n,n*16)

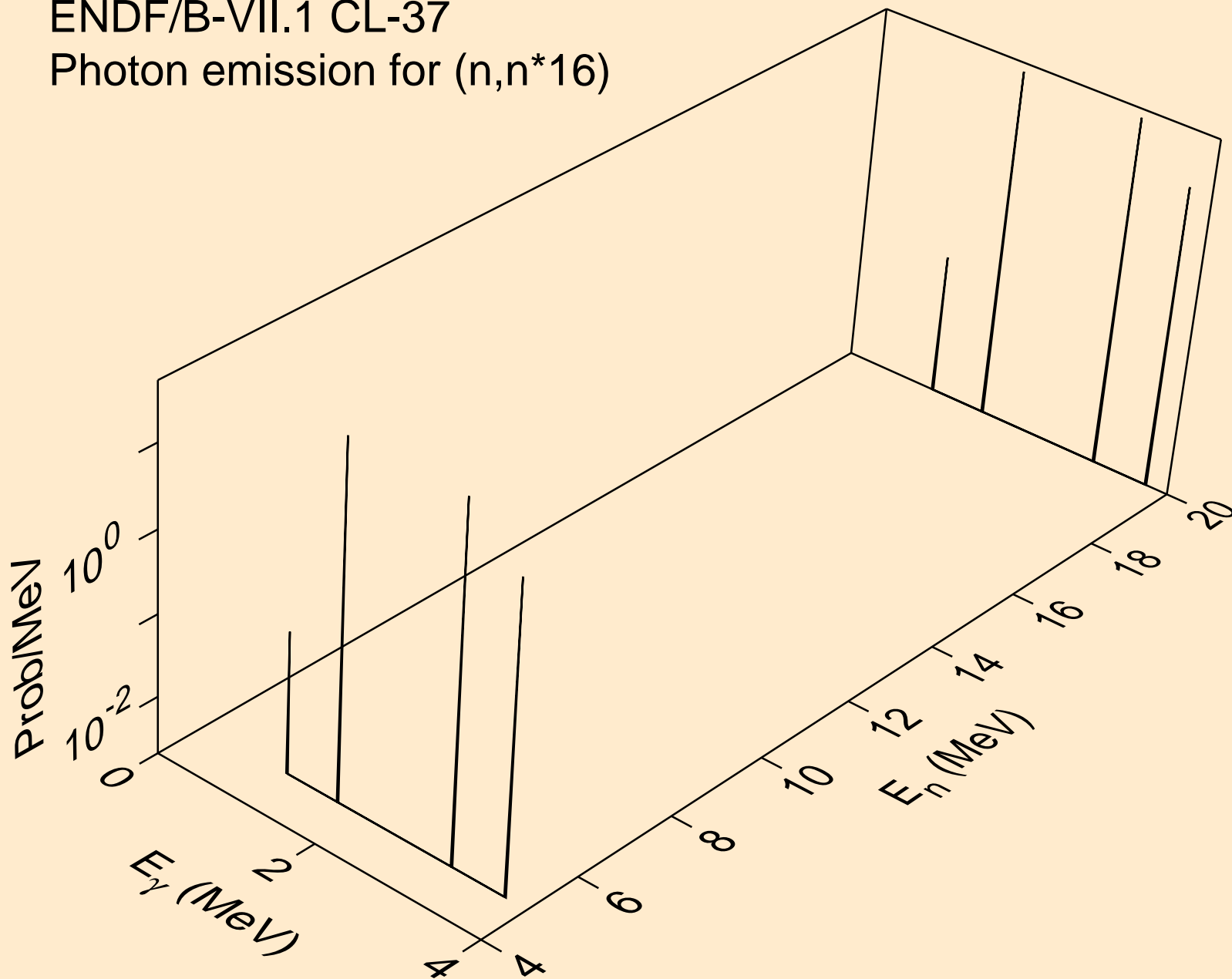

ENDF/B-VII.1 CL-37
Photon emission for (n,n*17)

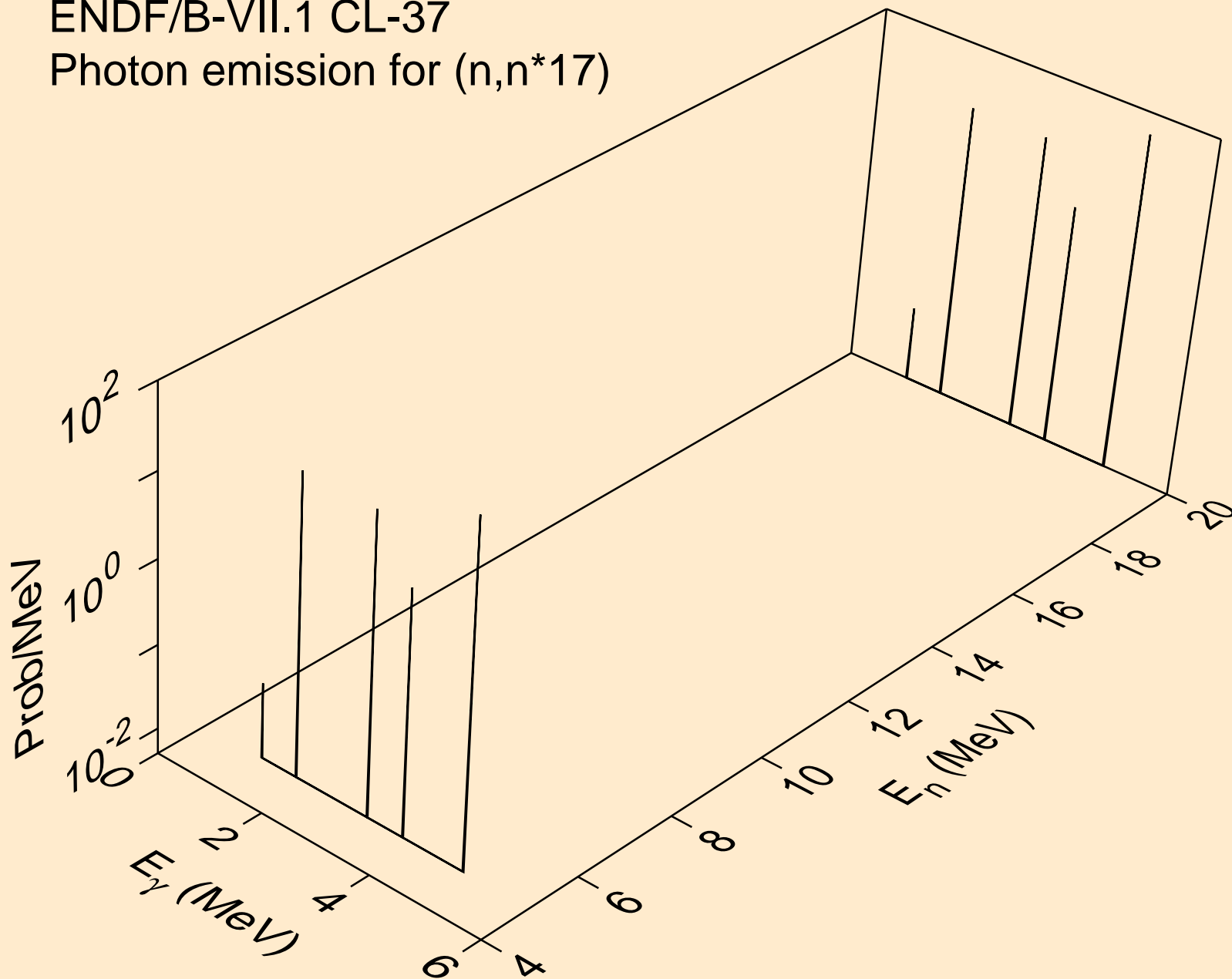

ENDF/B-VII.1 CL-37
Photon emission for (n,n*18)

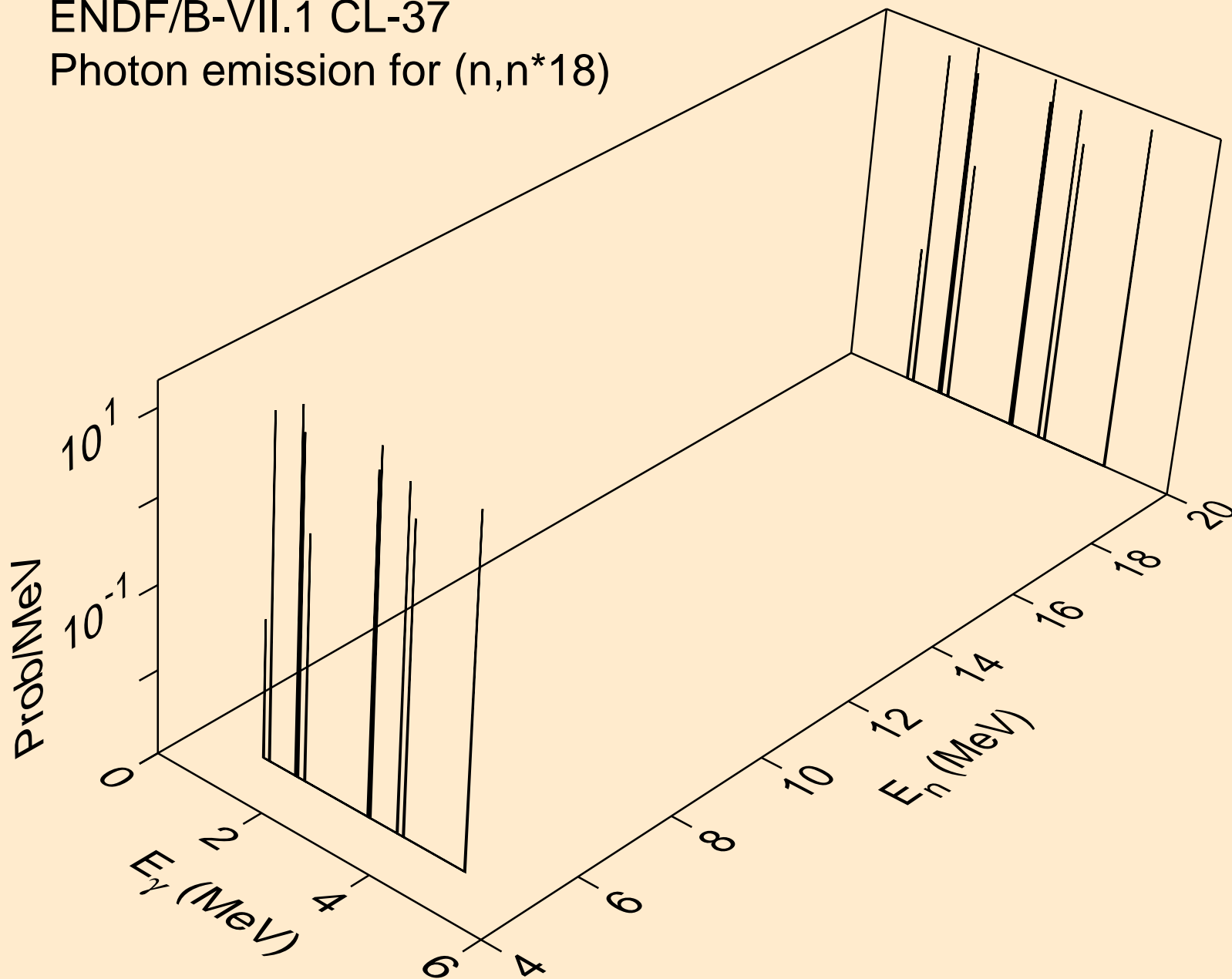

ENDF/B-VII.1 CL-37
Photon emission for (n,n*19)

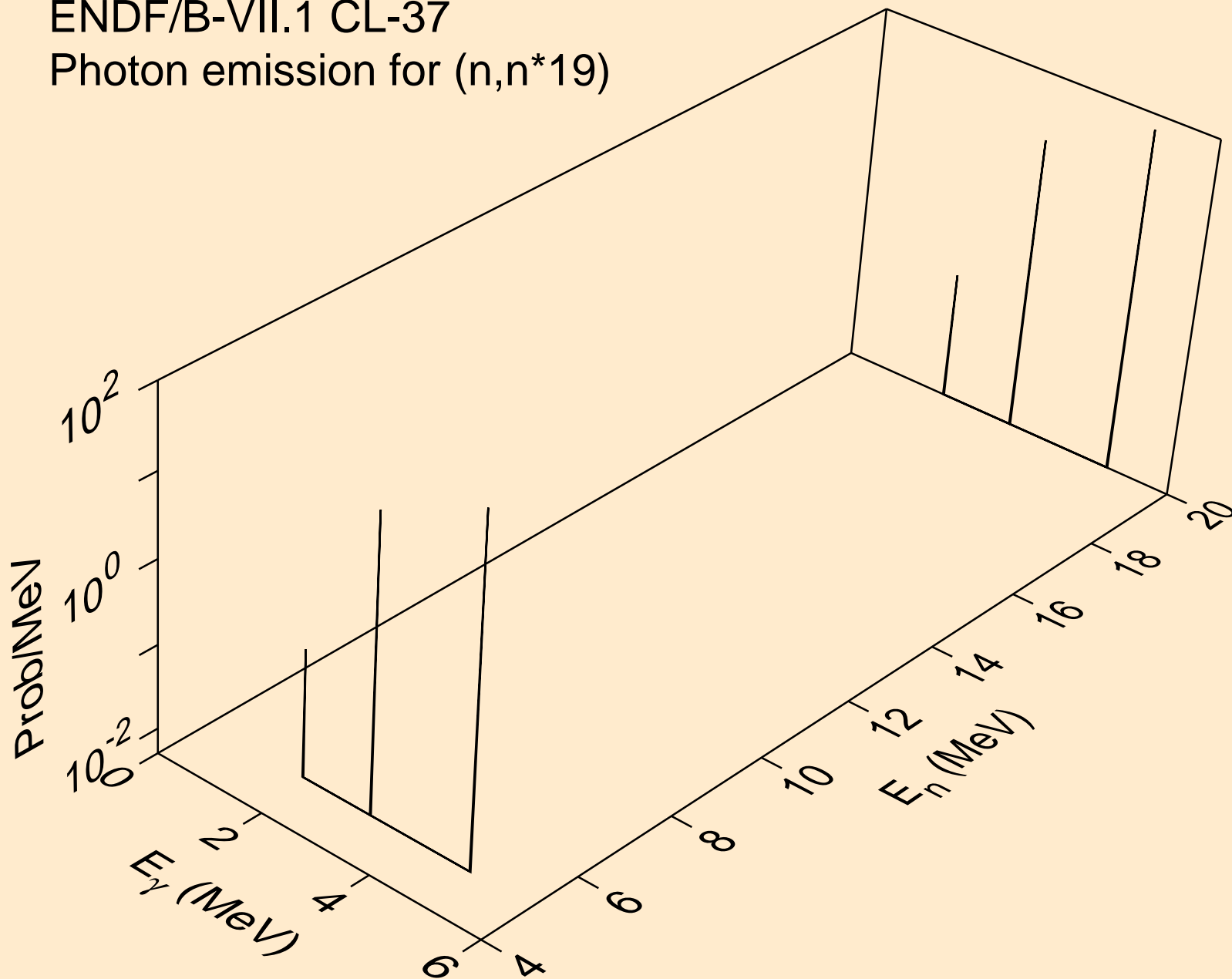

ENDF/B-VII.1 CL-37
Photon emission for (n,n*20)

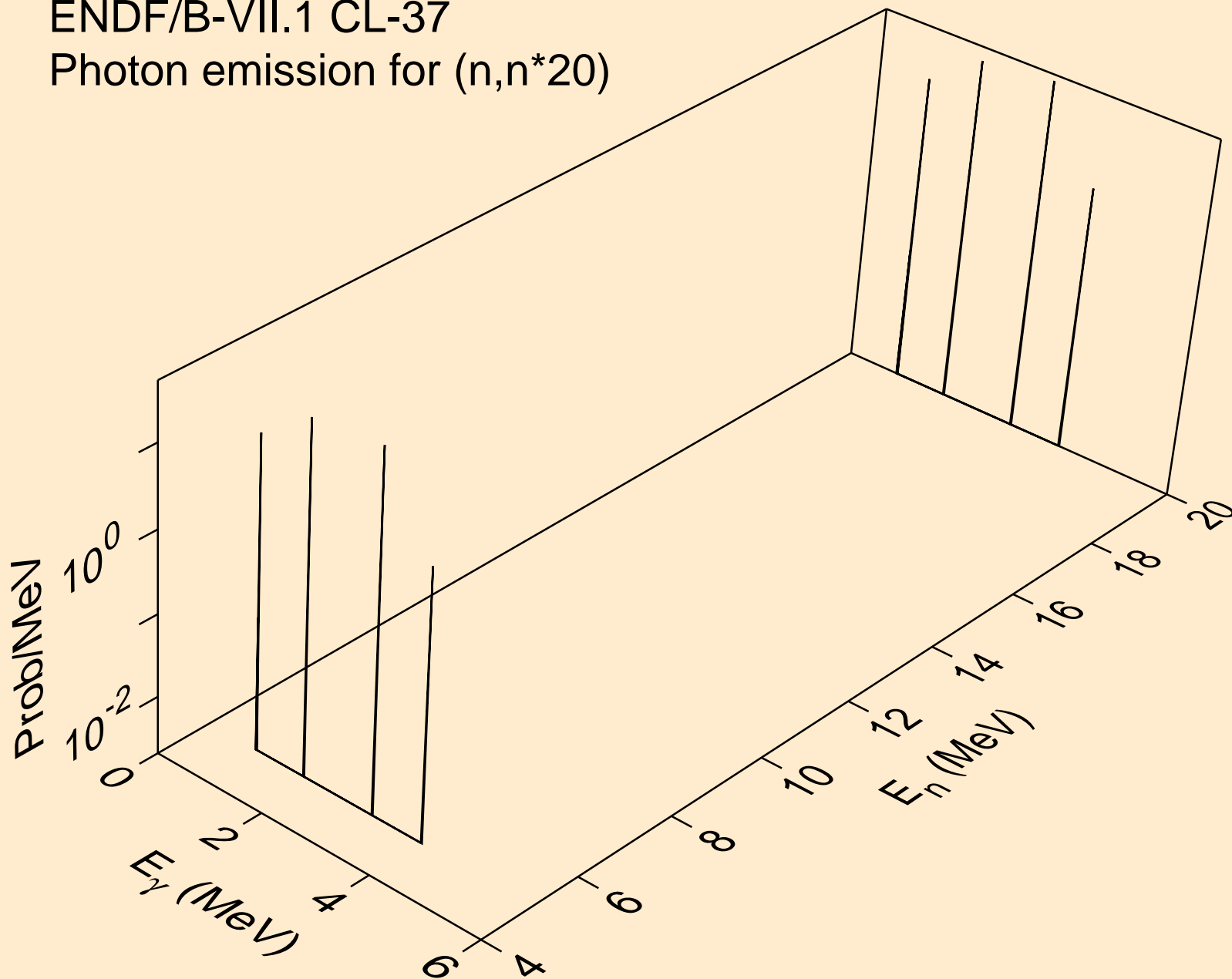

ENDF/B-VII.1 CL-37
Photon emission for (n,n*21)

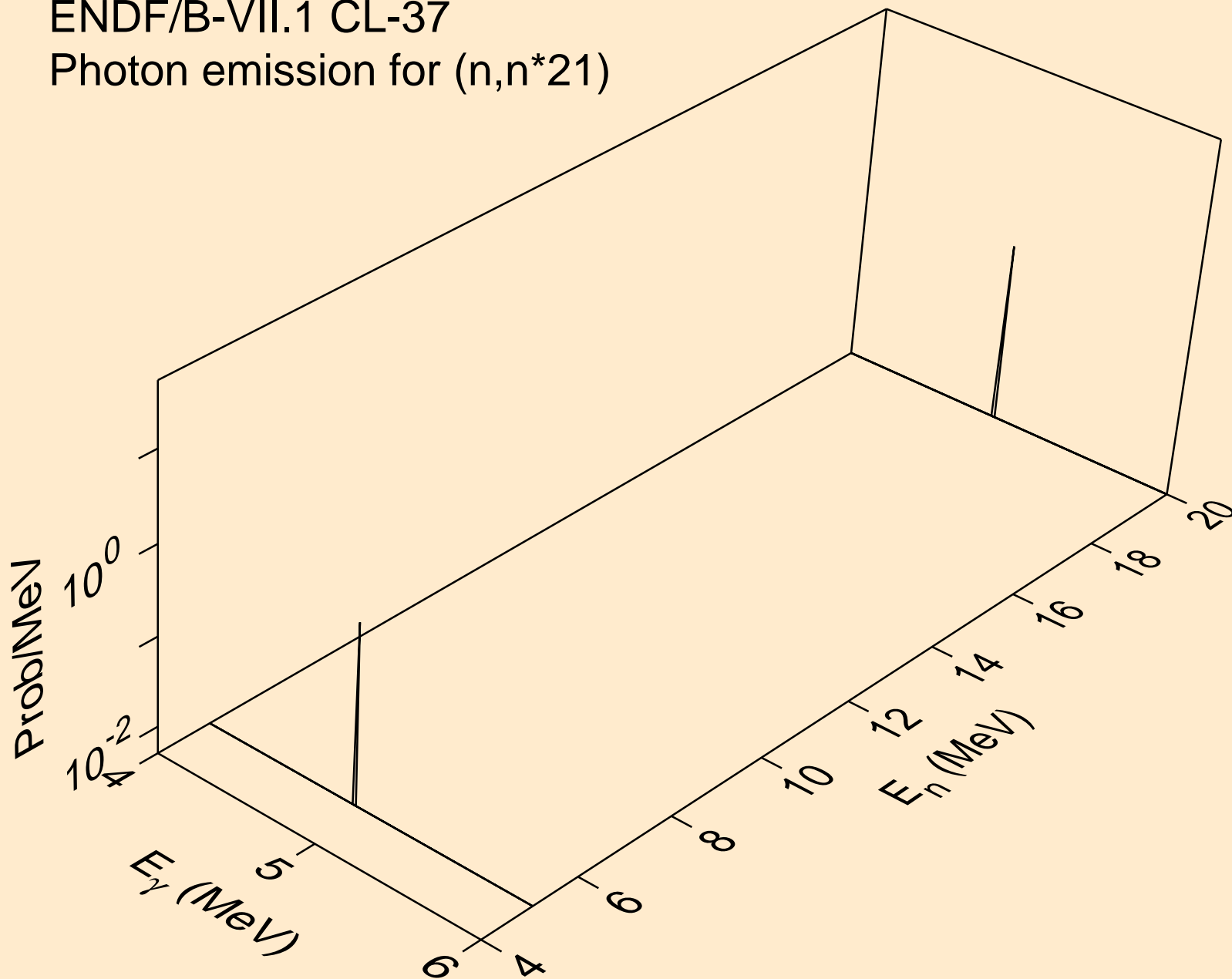

ENDF/B-VII.1 CL-37
Photon emission for (n,n*22)

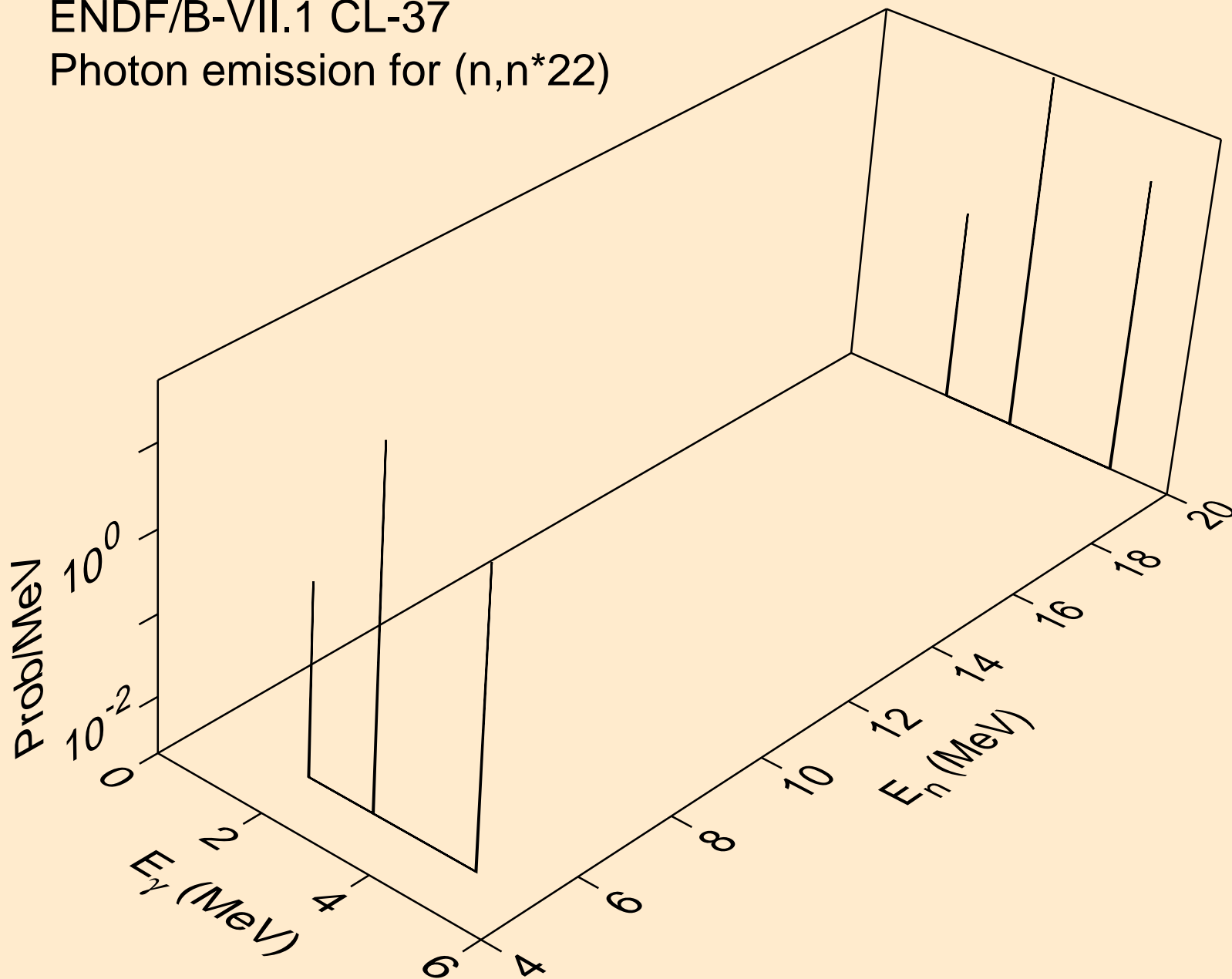

ENDF/B-VII.1 CL-37
Photon emission for (n,n*23)

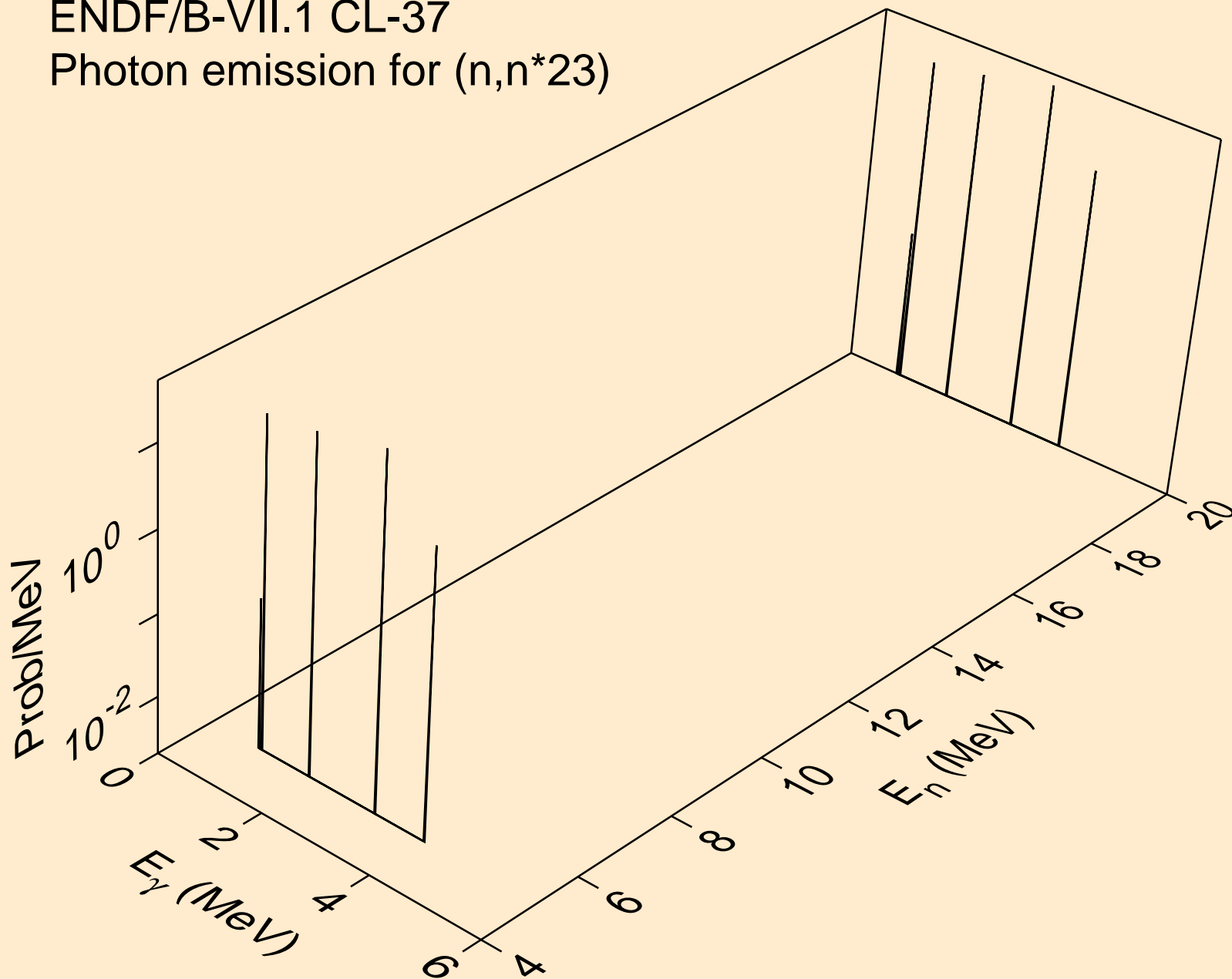

ENDF/B-VII.1 CL-37
Photon emission for (n,n*24)

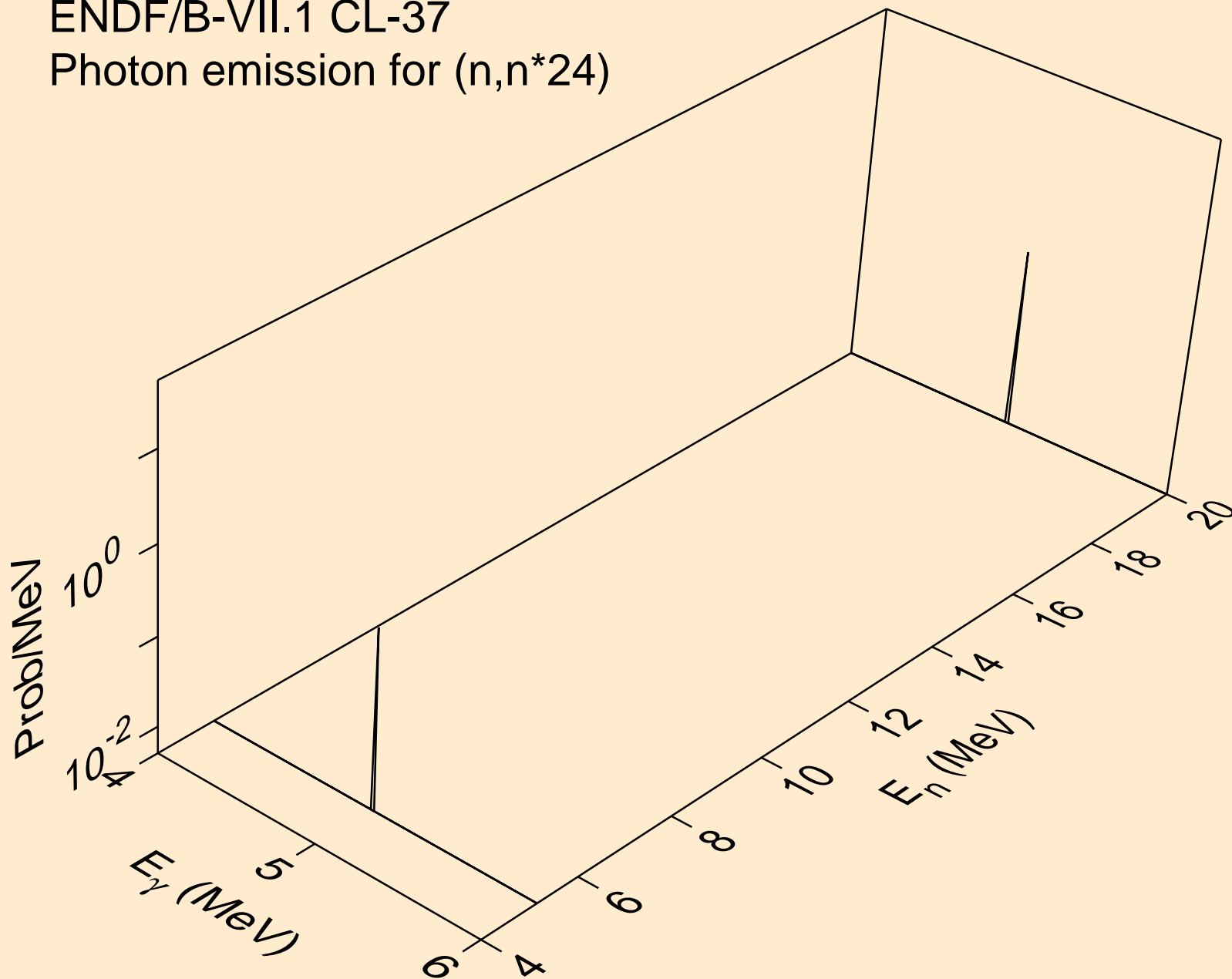

ENDF/B-VII.1 CL-37
Photon emission for (n,n*25)

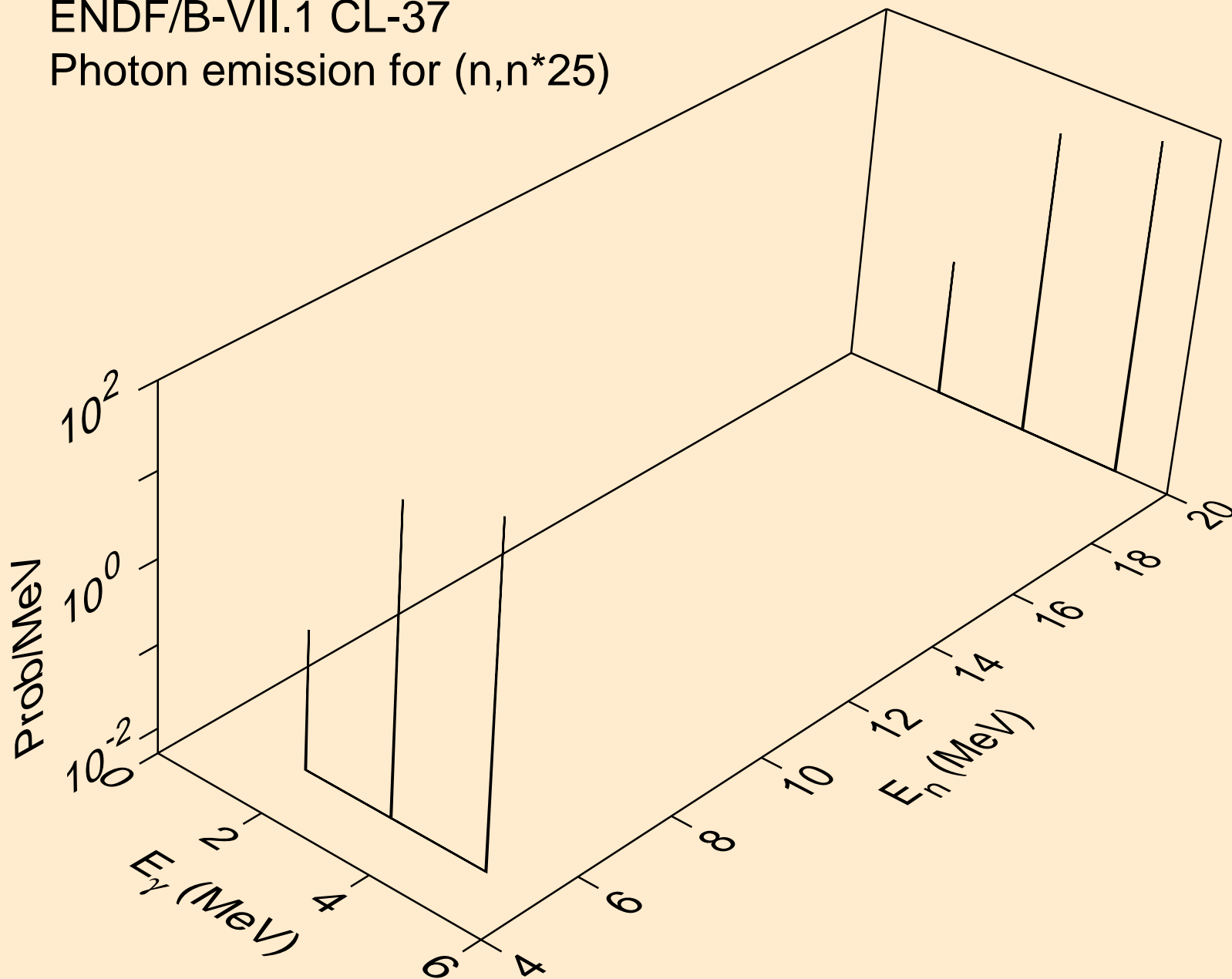

ENDF/B-VII.1 CL-37
Photon emission for (n,n*26)

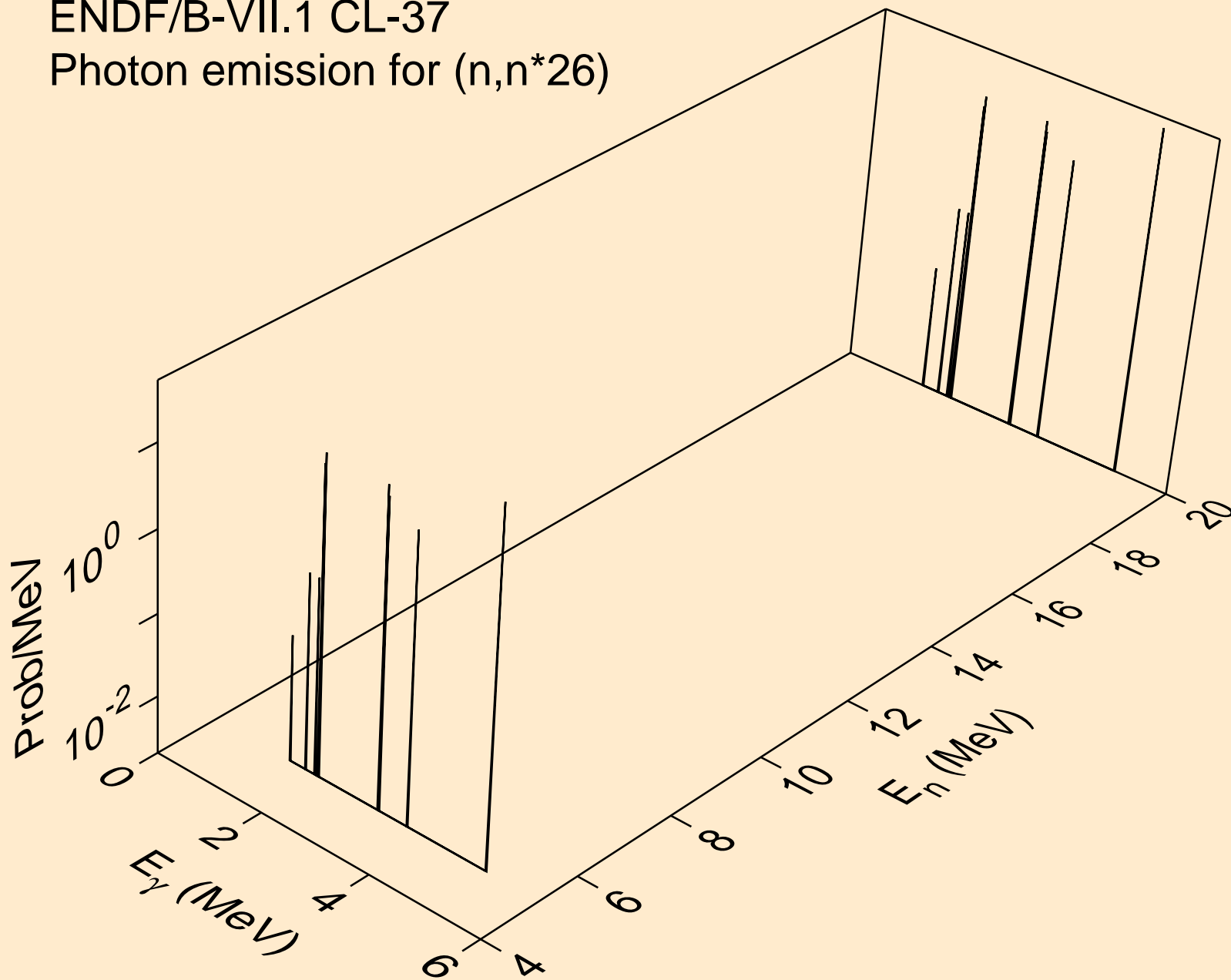

ENDF/B-VII.1 CL-37
Photon emission for (n,n*27)

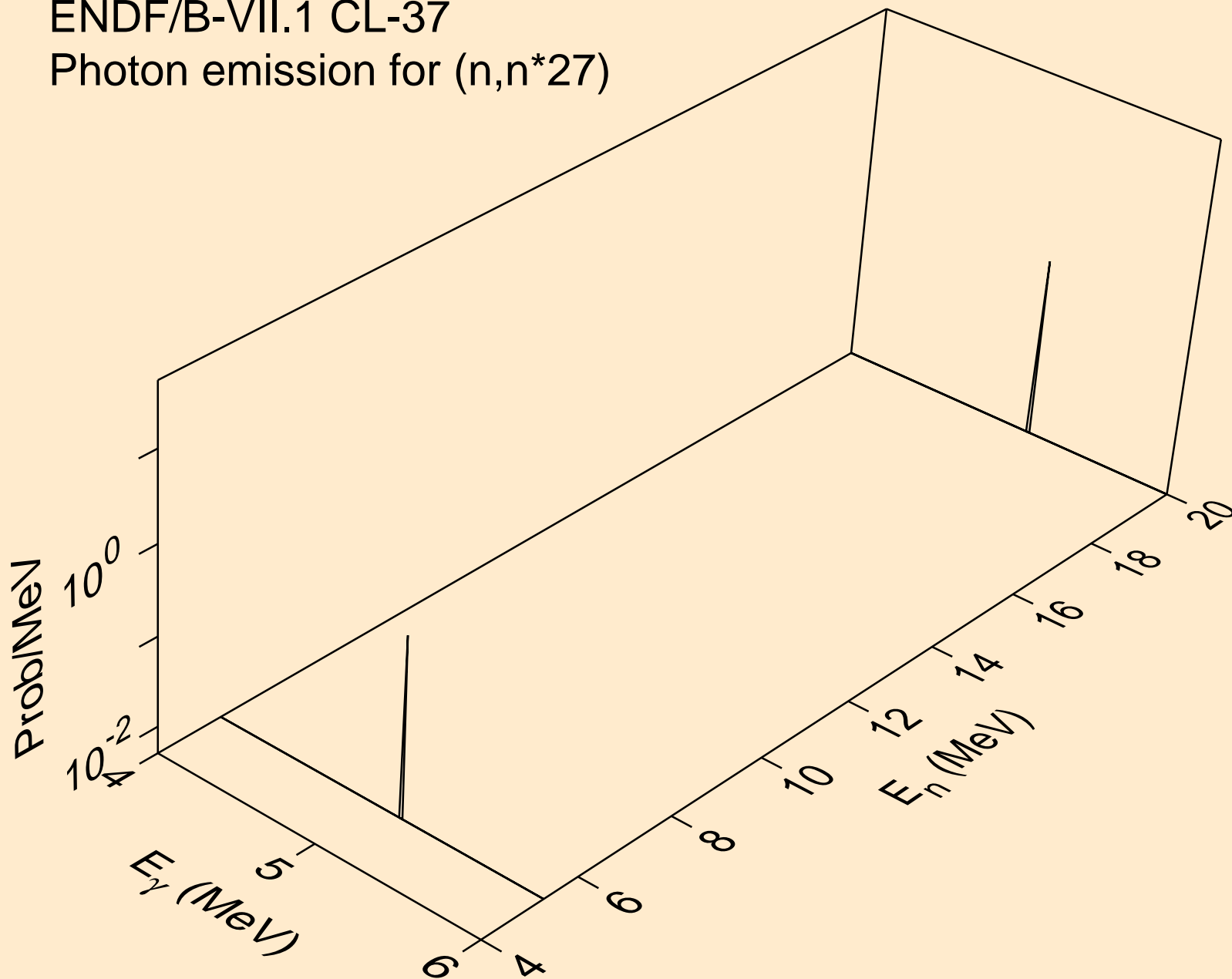

ENDF/B-VII.1 CL-37
Photon emission for (n,n*c)

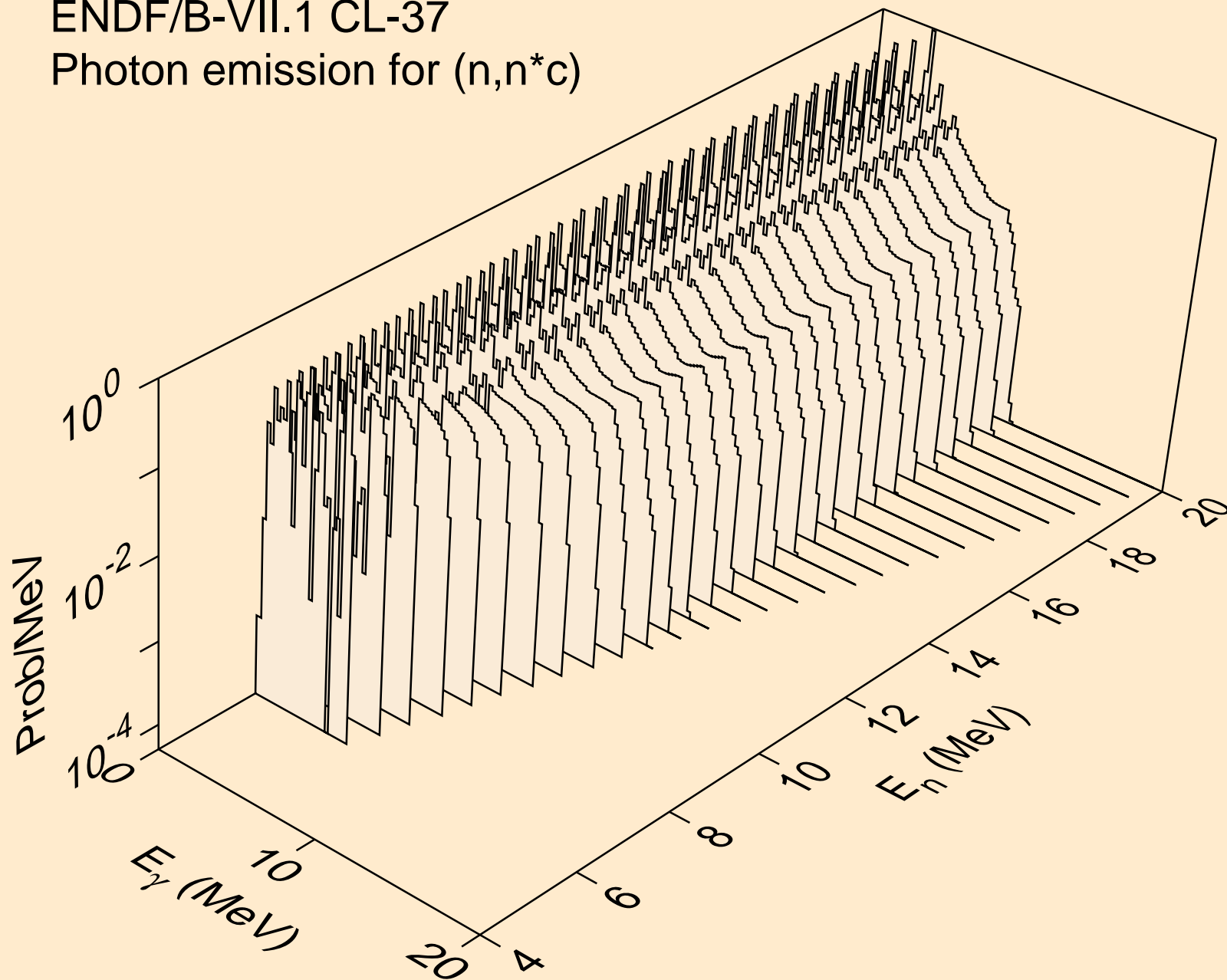

ENDF/B-VII.1 CL-37
Photon emission for (n,p*c)

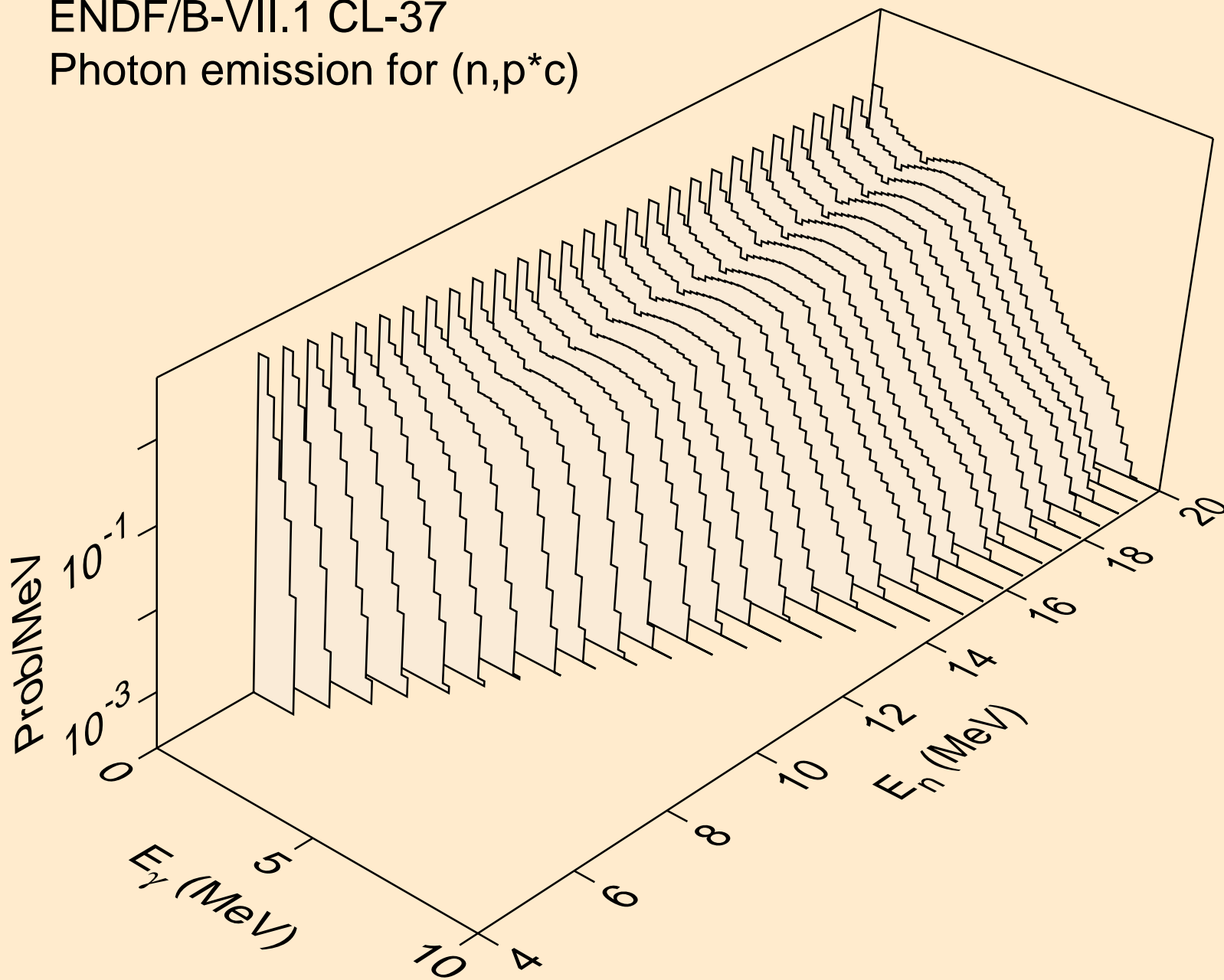

ENDF/B-VII.1 CL-37
Photon emission for (n,d*1)

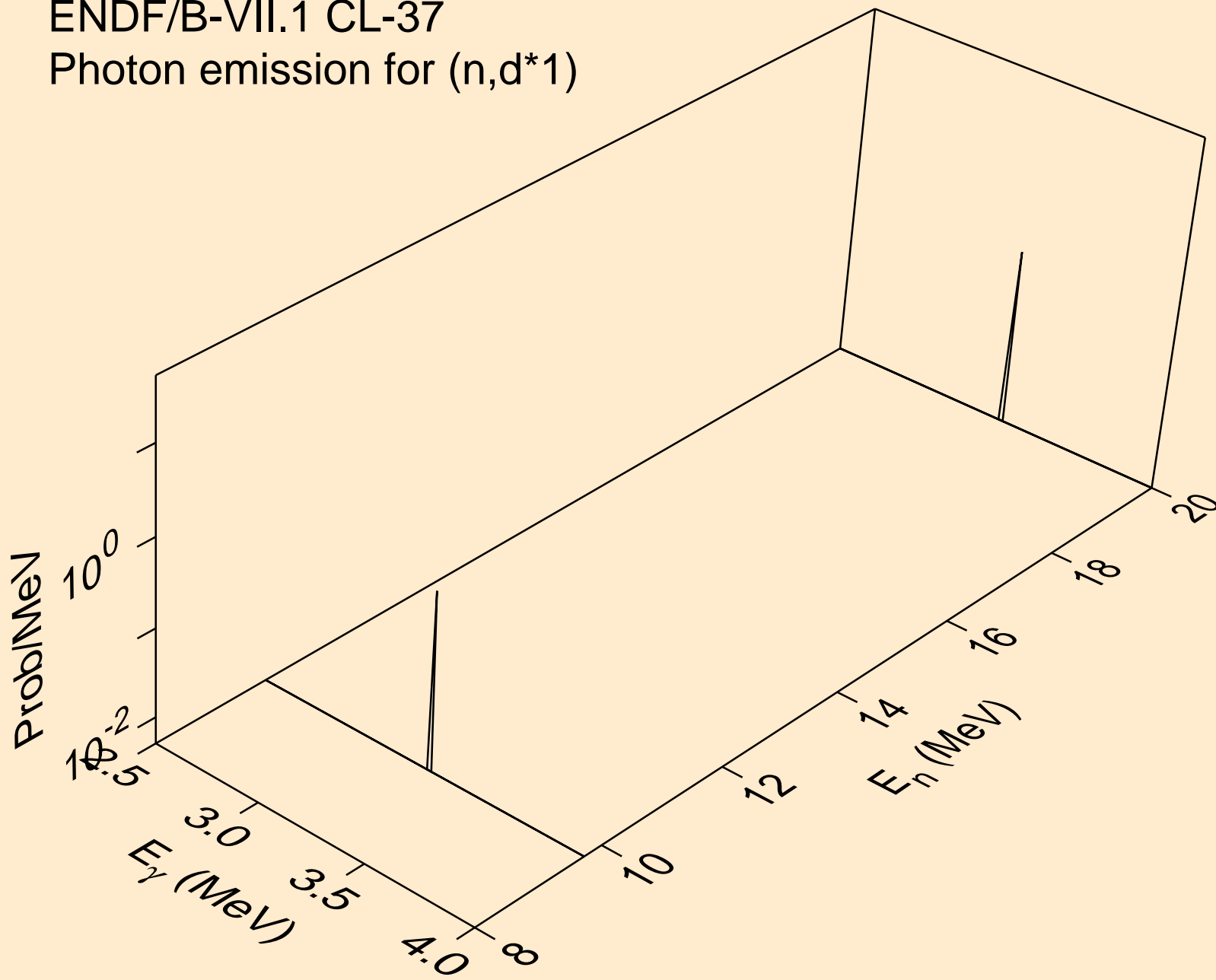

ENDF/B-VII.1 CL-37
Photon emission for (n,d*2)

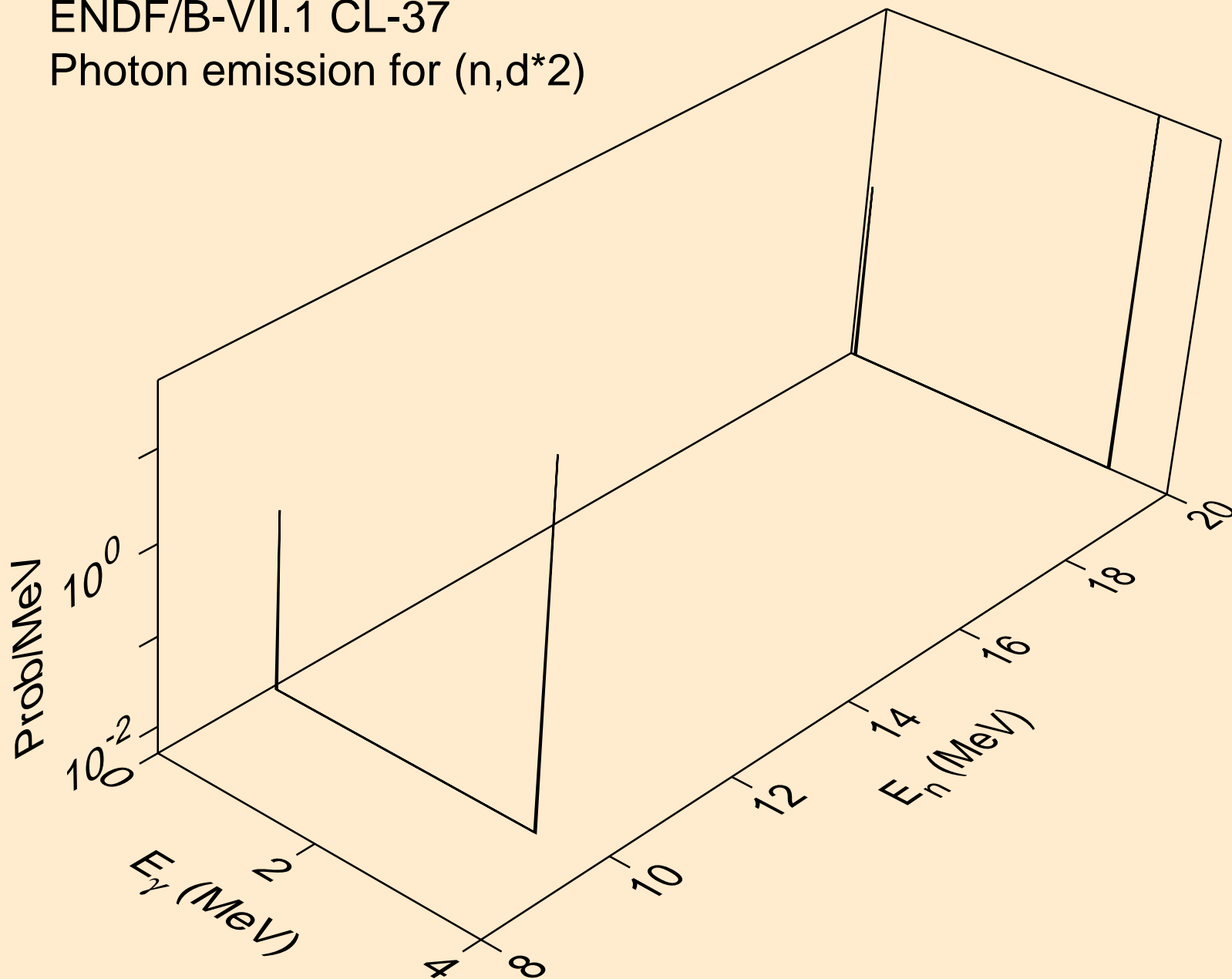

ENDF/B-VII.1 CL-37
Photon emission for (n,d*3)

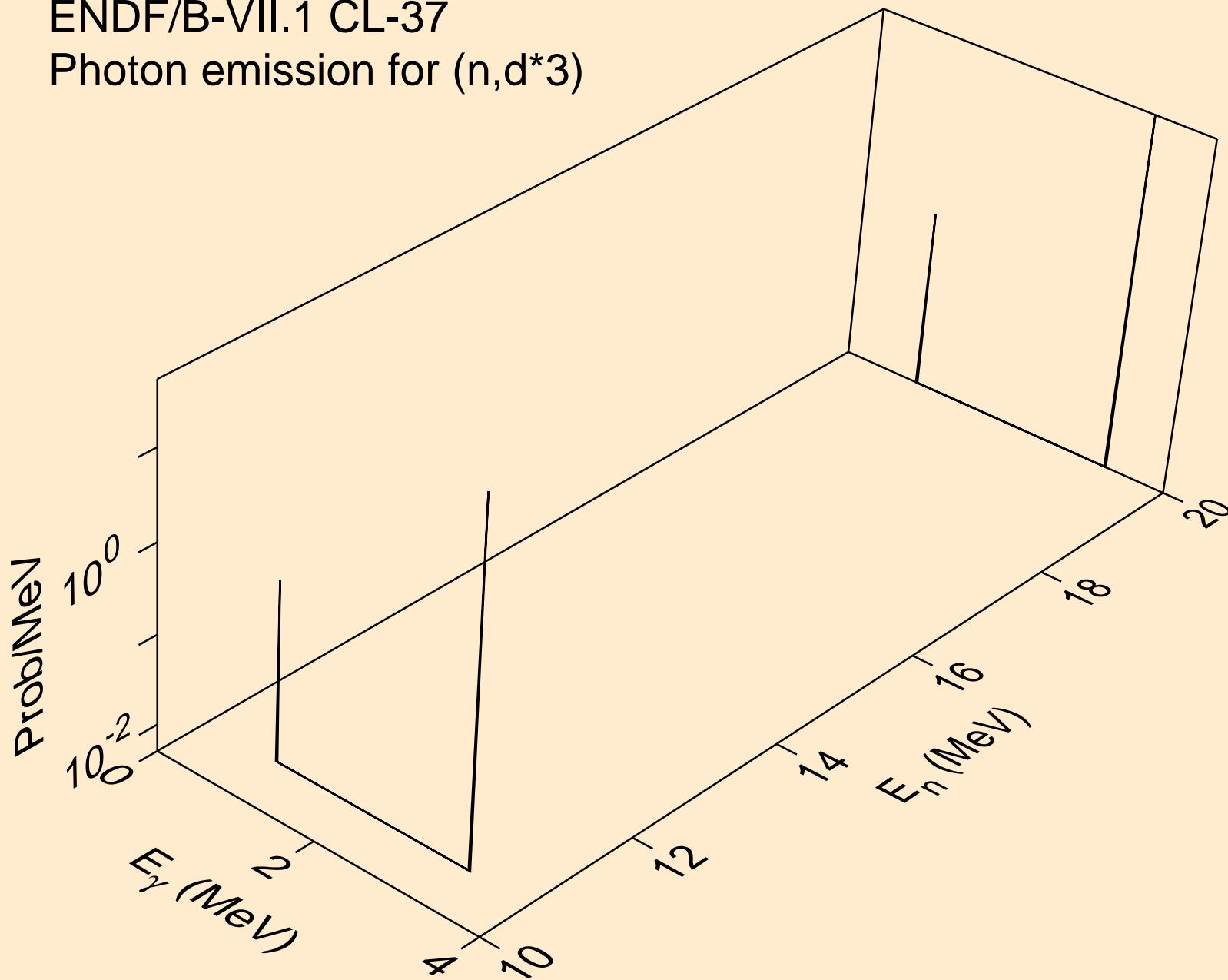

ENDF/B-VII.1 CL-37
Photon emission for (n,d*4)

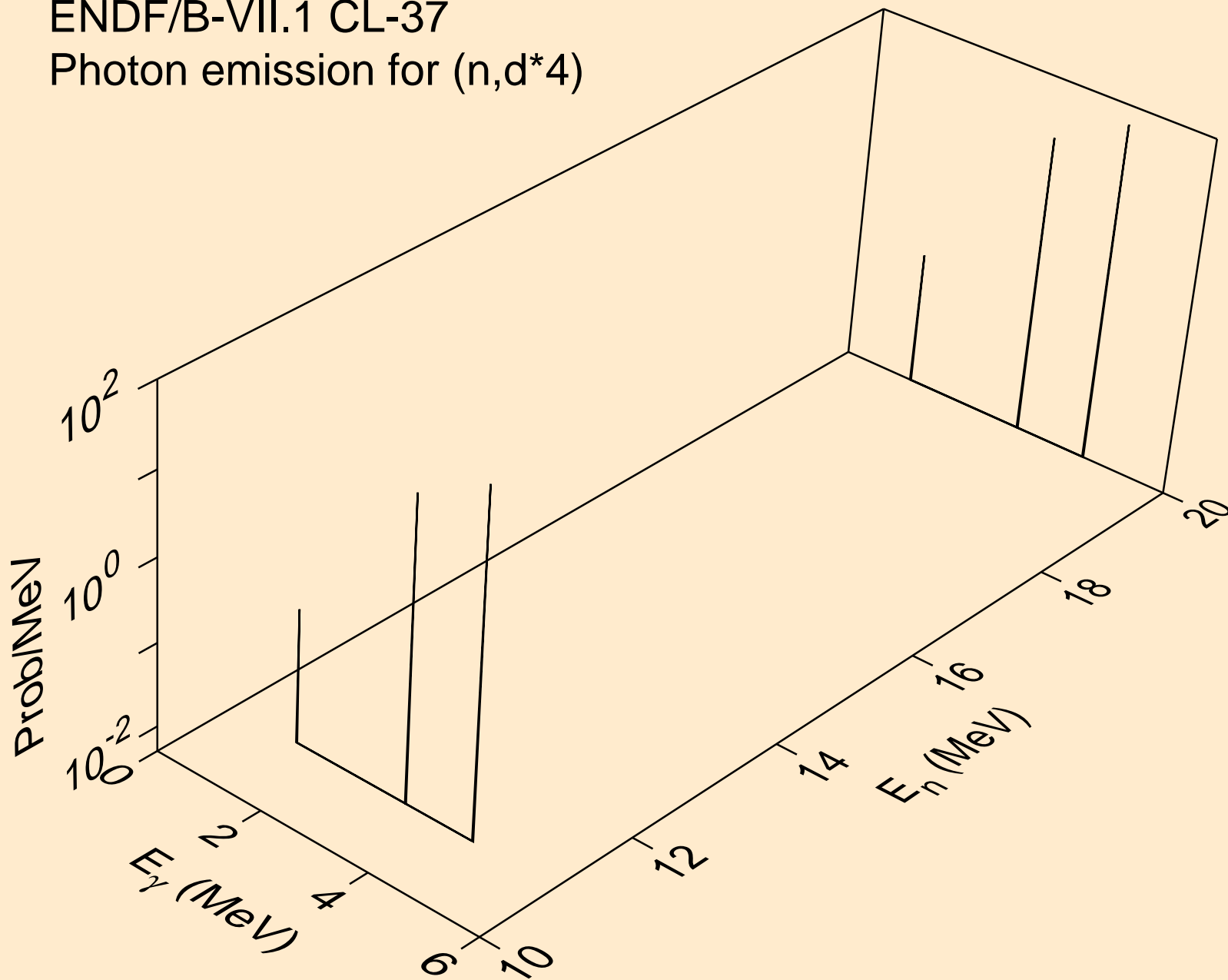

ENDF/B-VII.1 CL-37
Photon emission for (n,d*5)

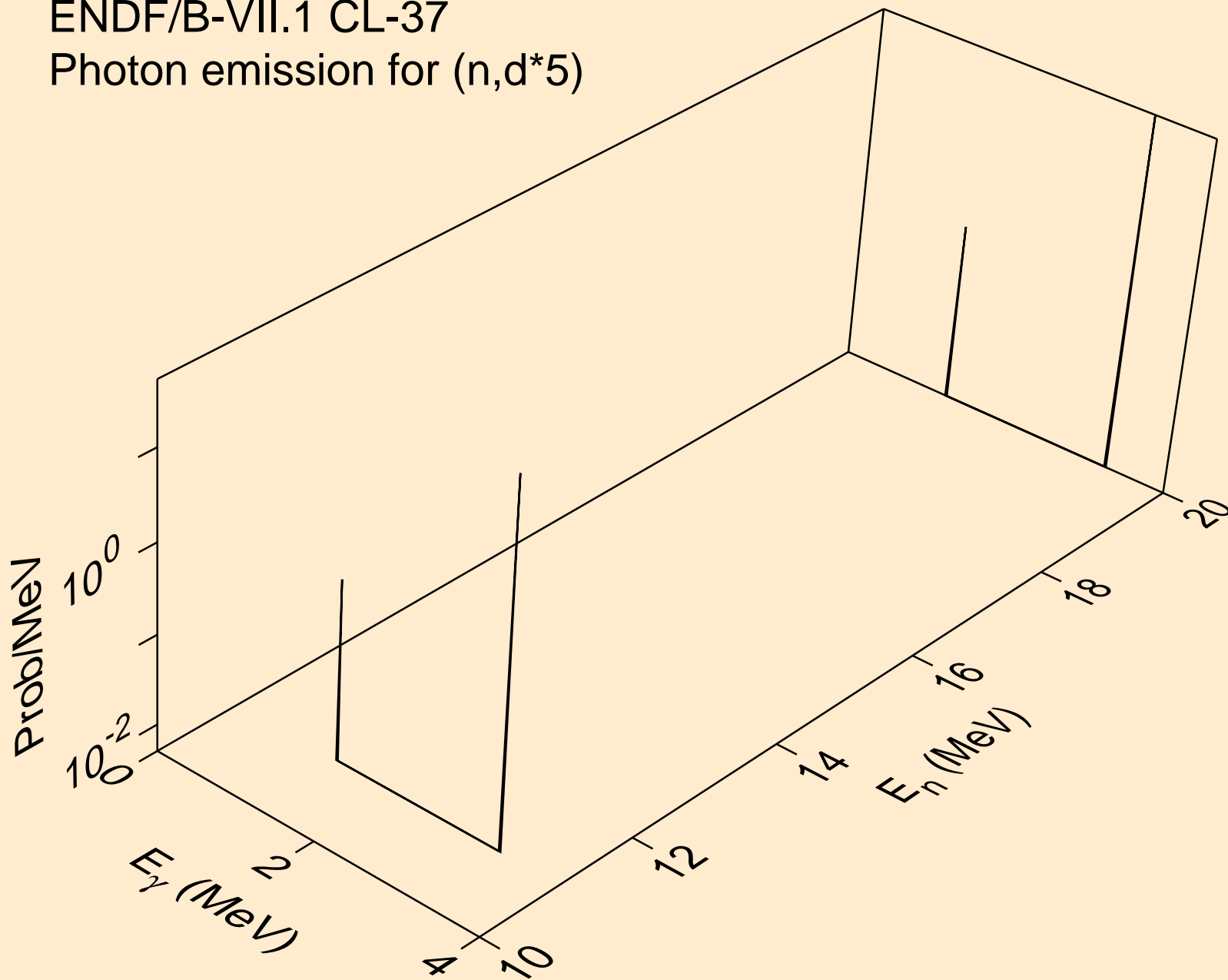

ENDF/B-VII.1 CL-37
Photon emission for (n,d*6)

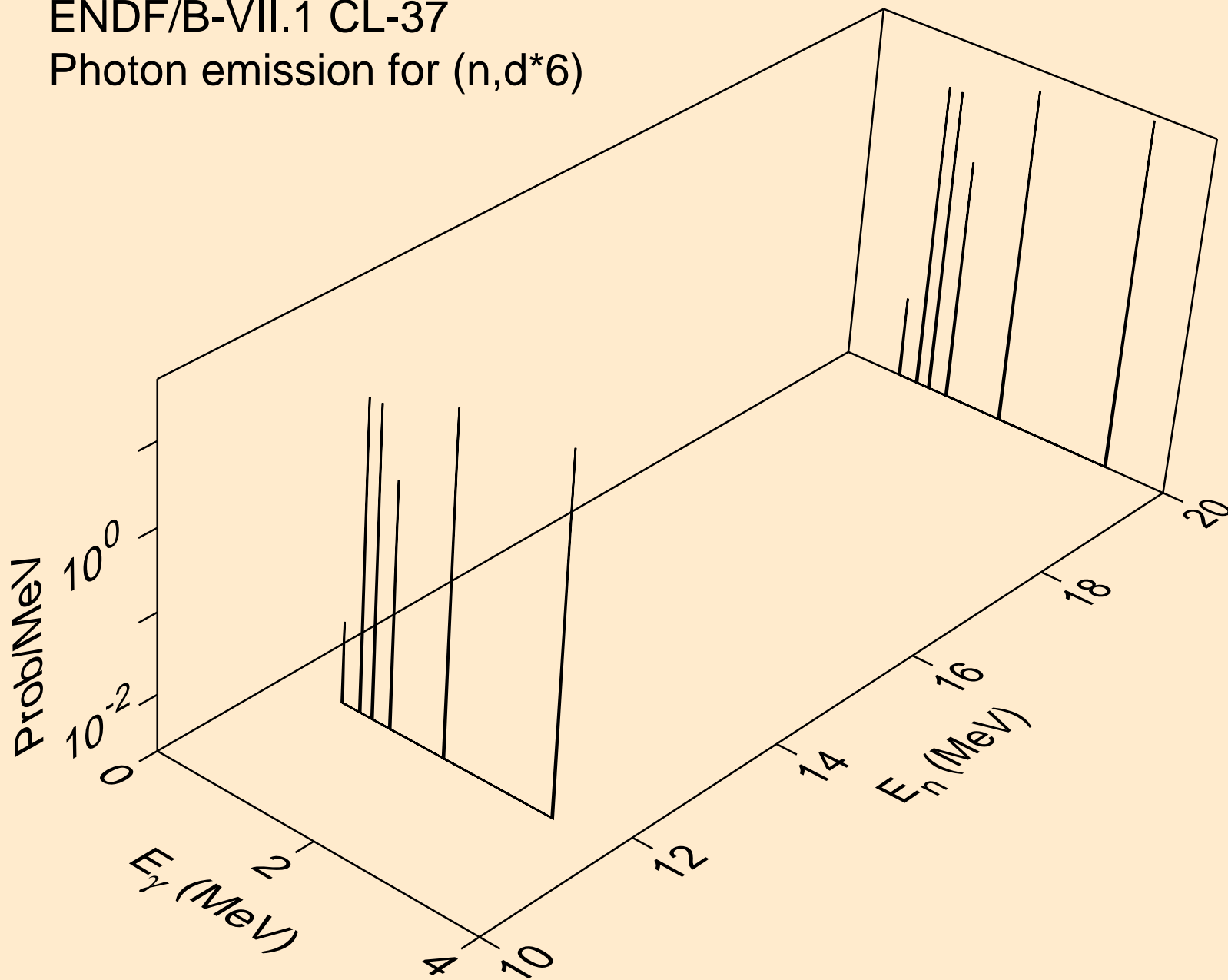

ENDF/B-VII.1 CL-37
Photon emission for (n,d*7)

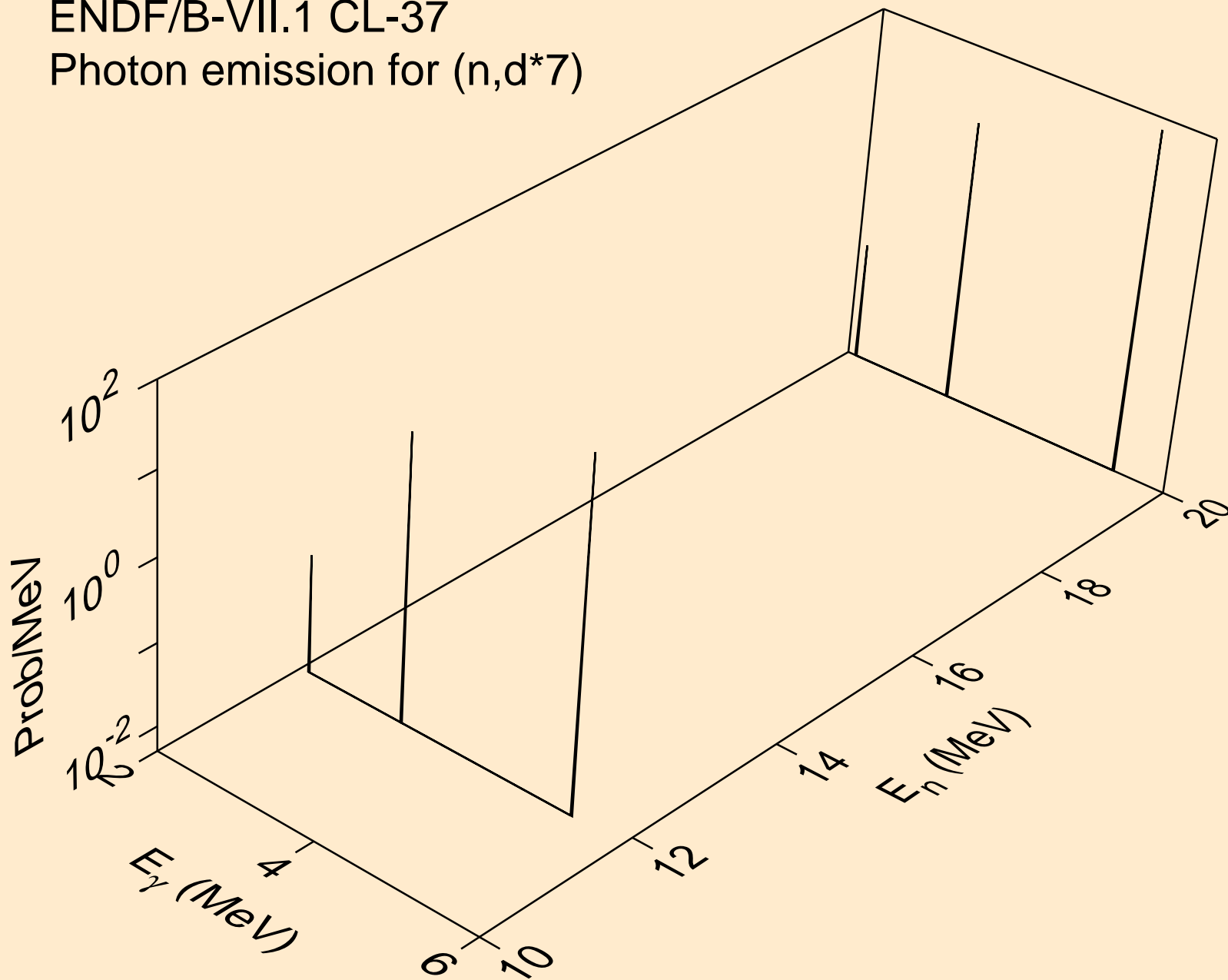

ENDF/B-VII.1 CL-37
Photon emission for (n,d*8)

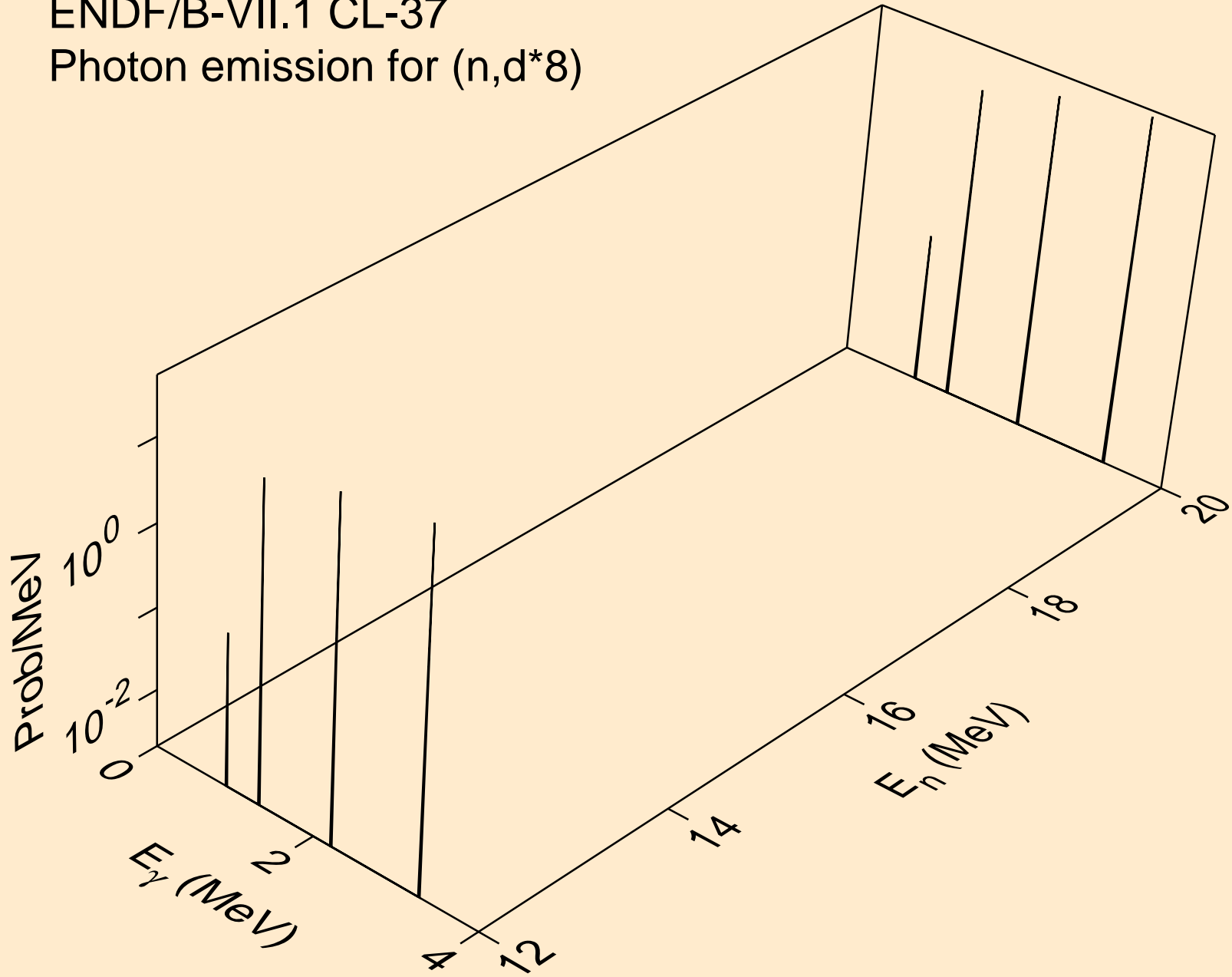

ENDF/B-VII.1 CL-37
Photon emission for (n,d*9)

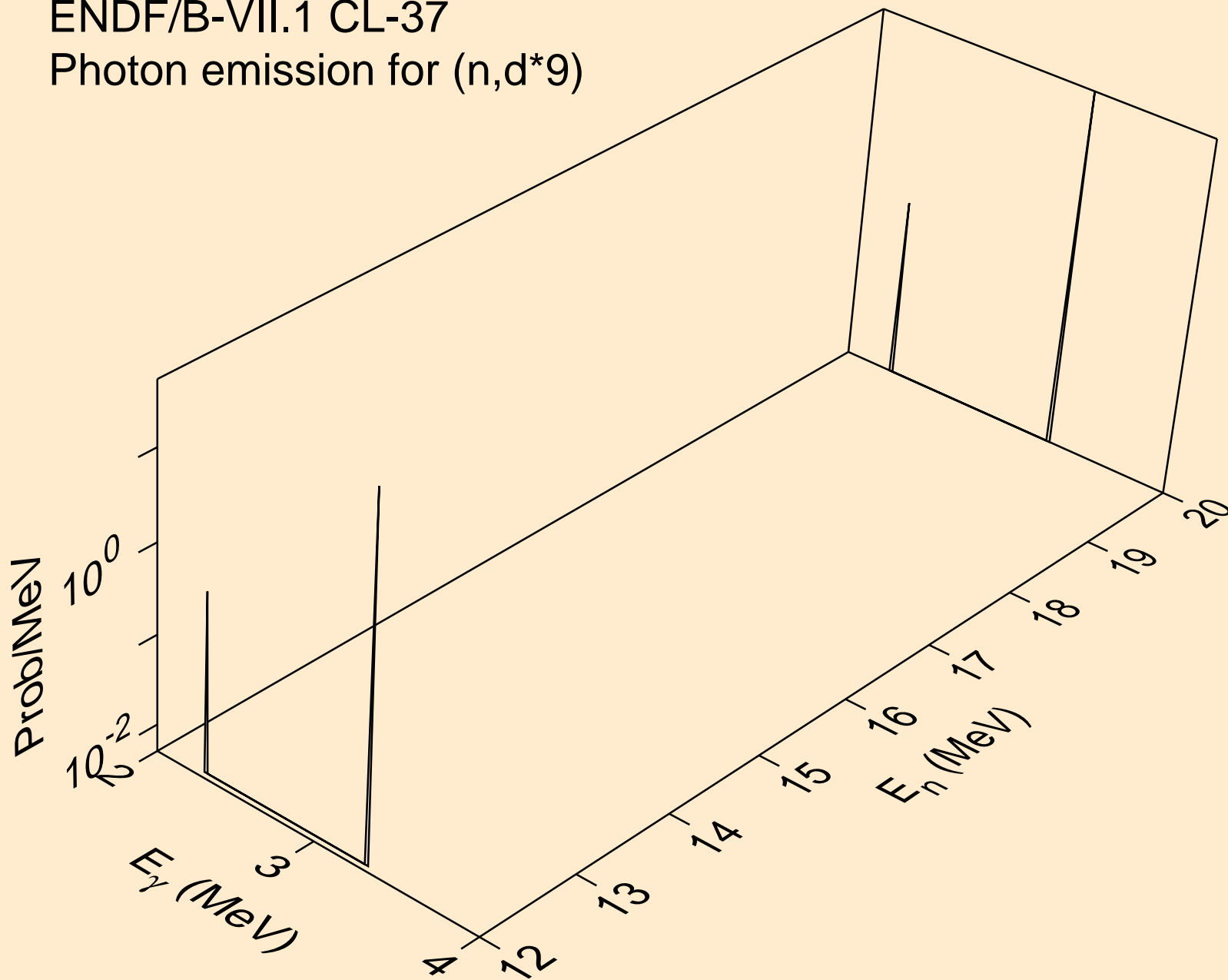

ENDF/B-VII.1 CL-37
Photon emission for (n,d*10)

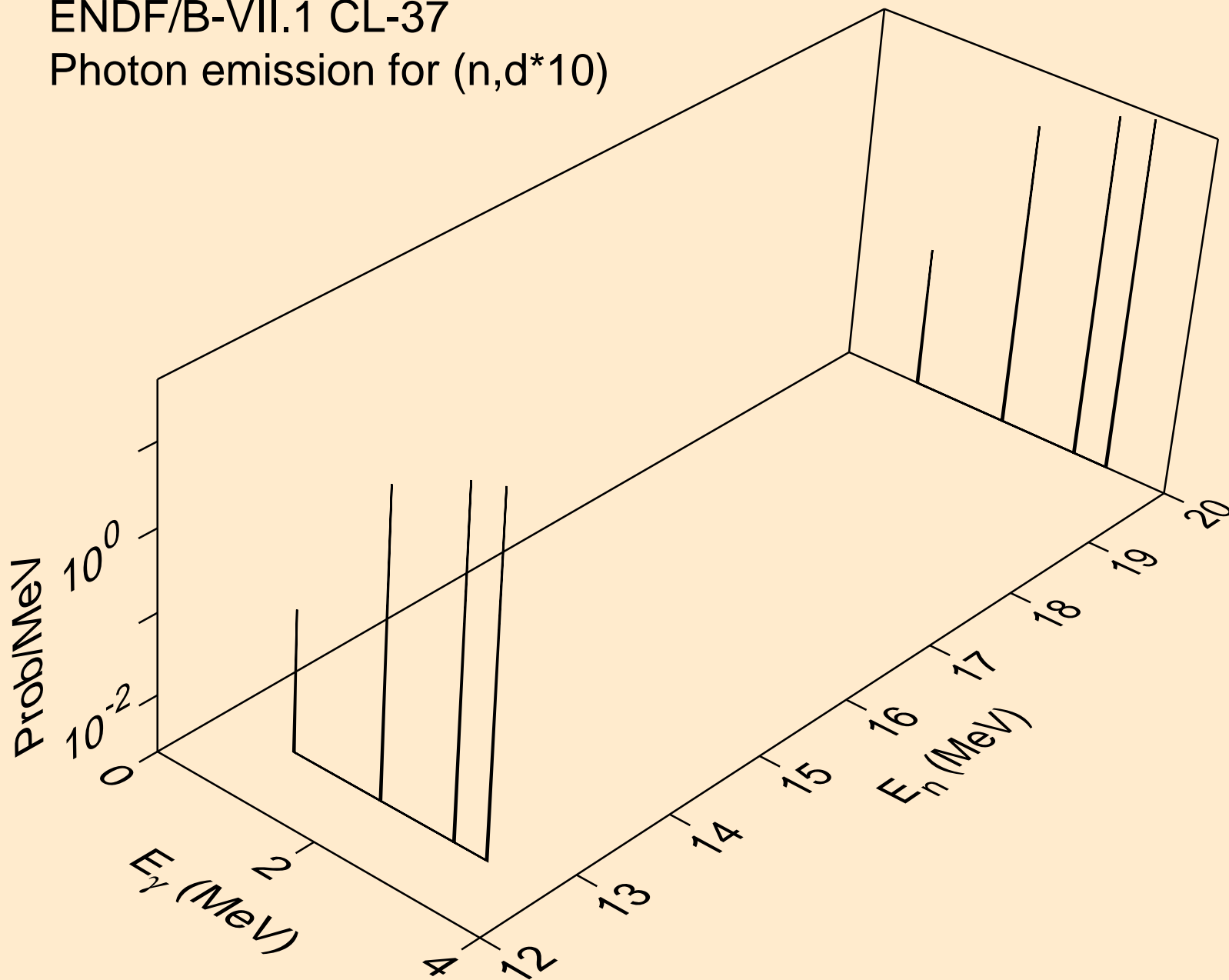

ENDF/B-VII.1 CL-37
Photon emission for (n,d*11)

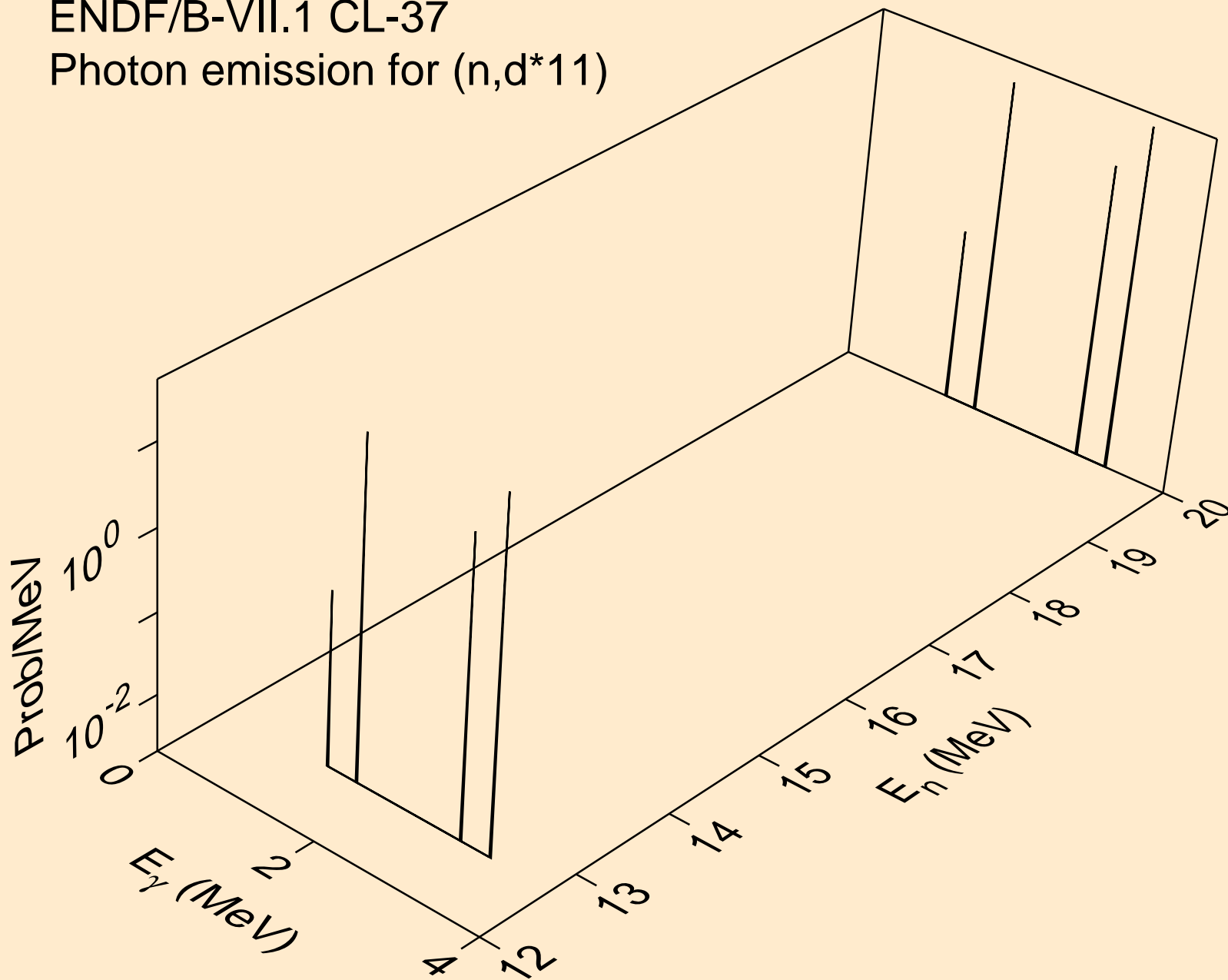

ENDF/B-VII.1 CL-37
Photon emission for (n,d*c)

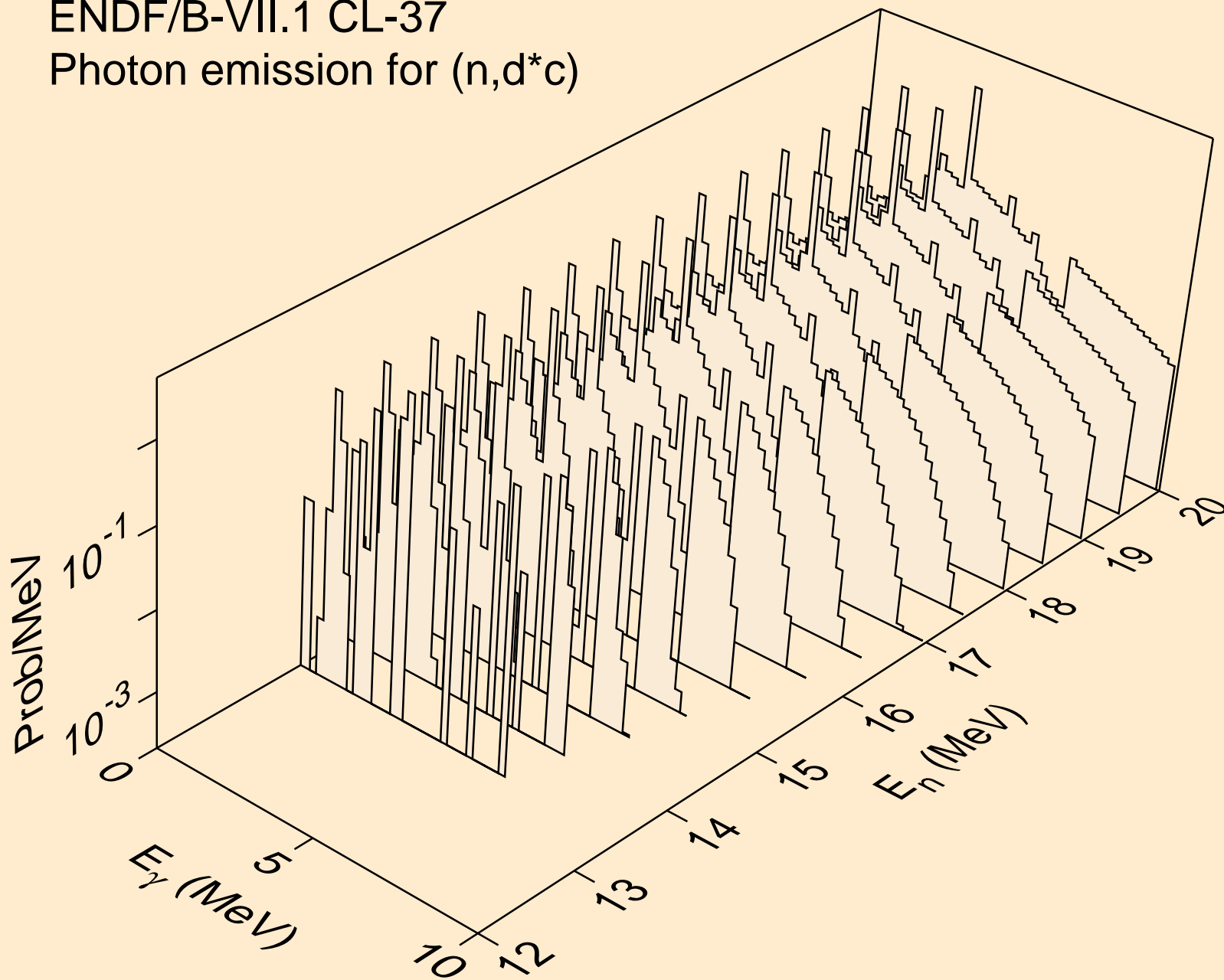

ENDF/B-VII.1 CL-37
Photon emission for (n,t*1)

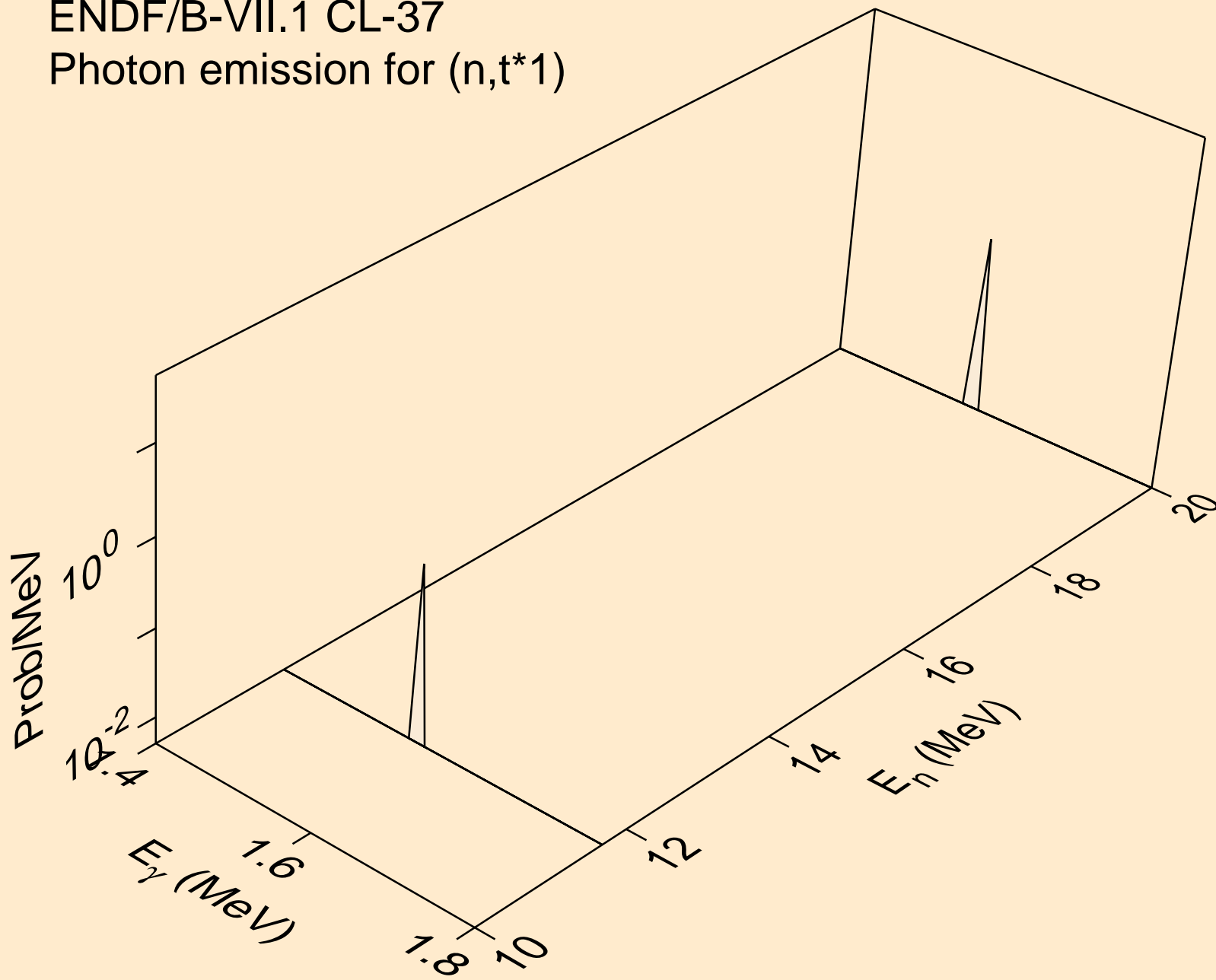

ENDF/B-VII.1 CL-37
Photon emission for (n,t*2)

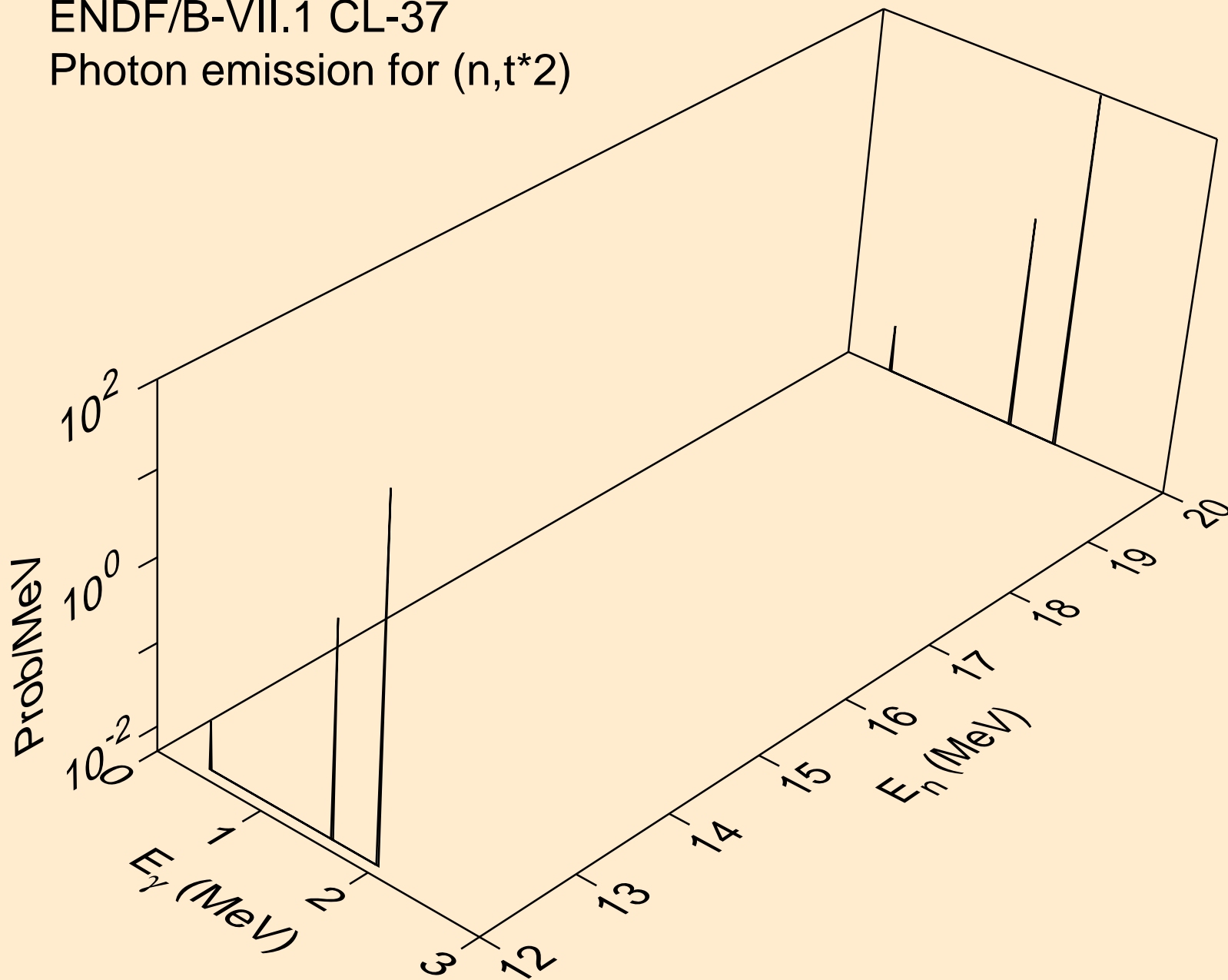

ENDF/B-VII.1 CL-37
Photon emission for (n,t*3)

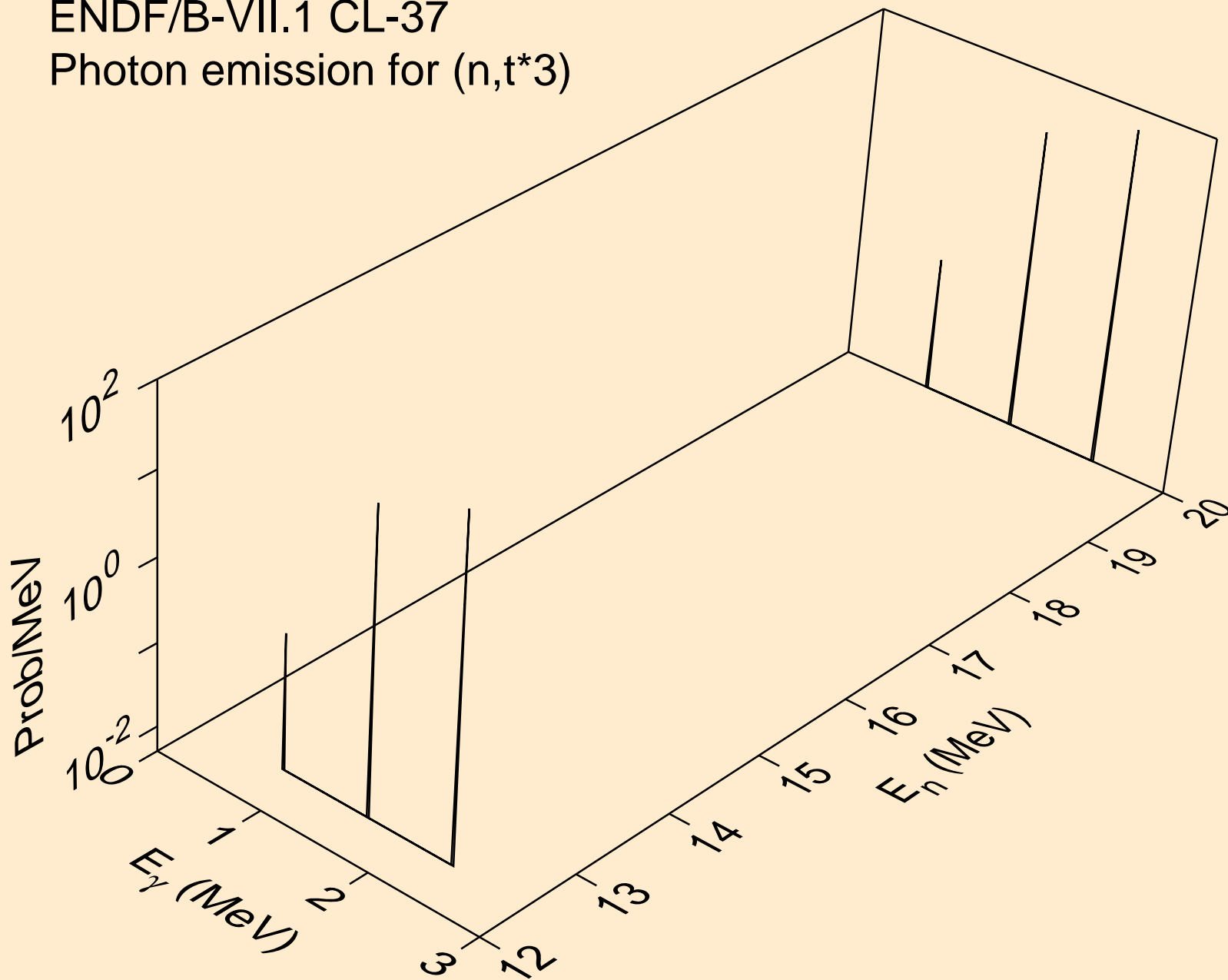

ENDF/B-VII.1 CL-37
Photon emission for (n,t*4)

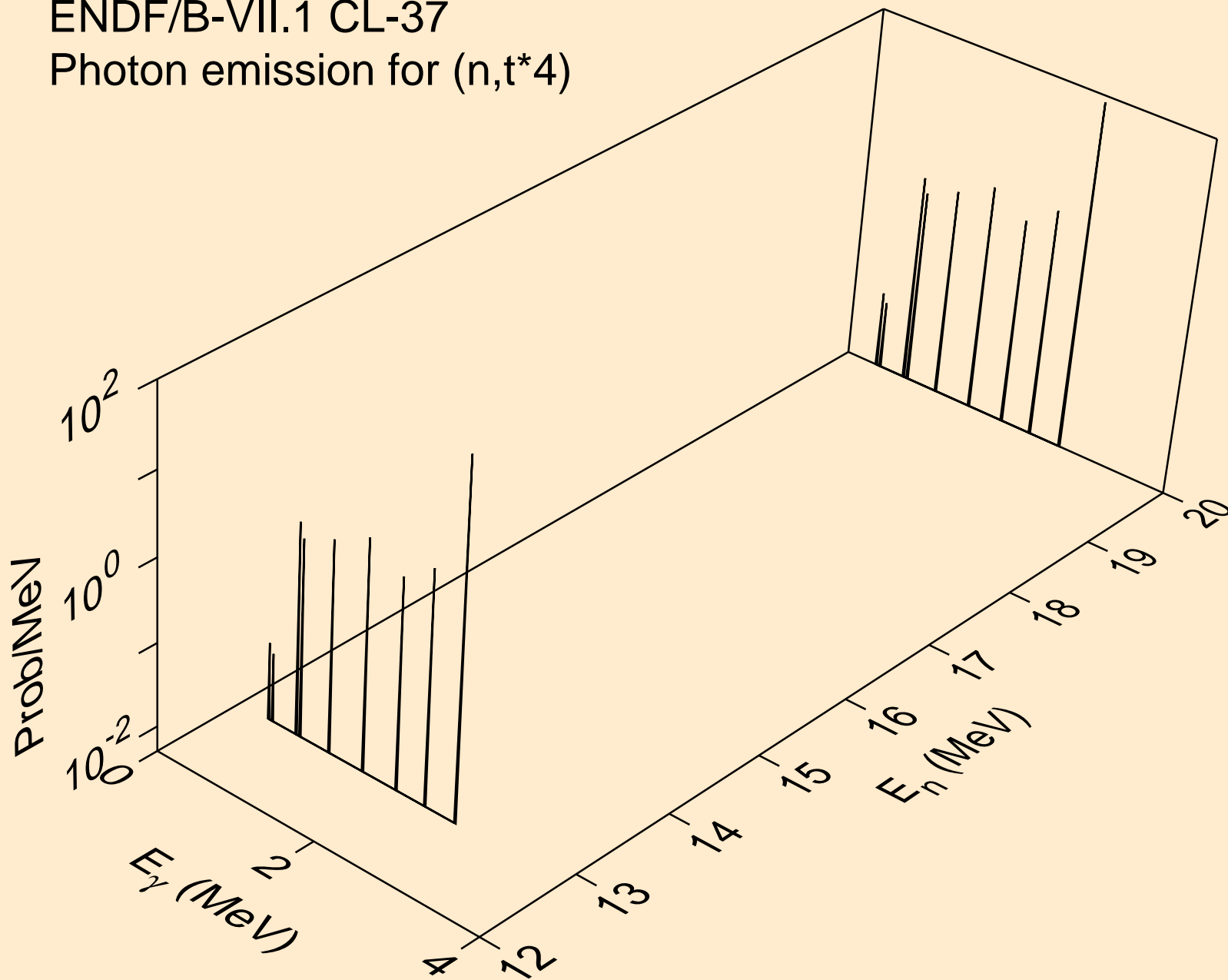

ENDF/B-VII.1 CL-37
Photon emission for (n,t*5)

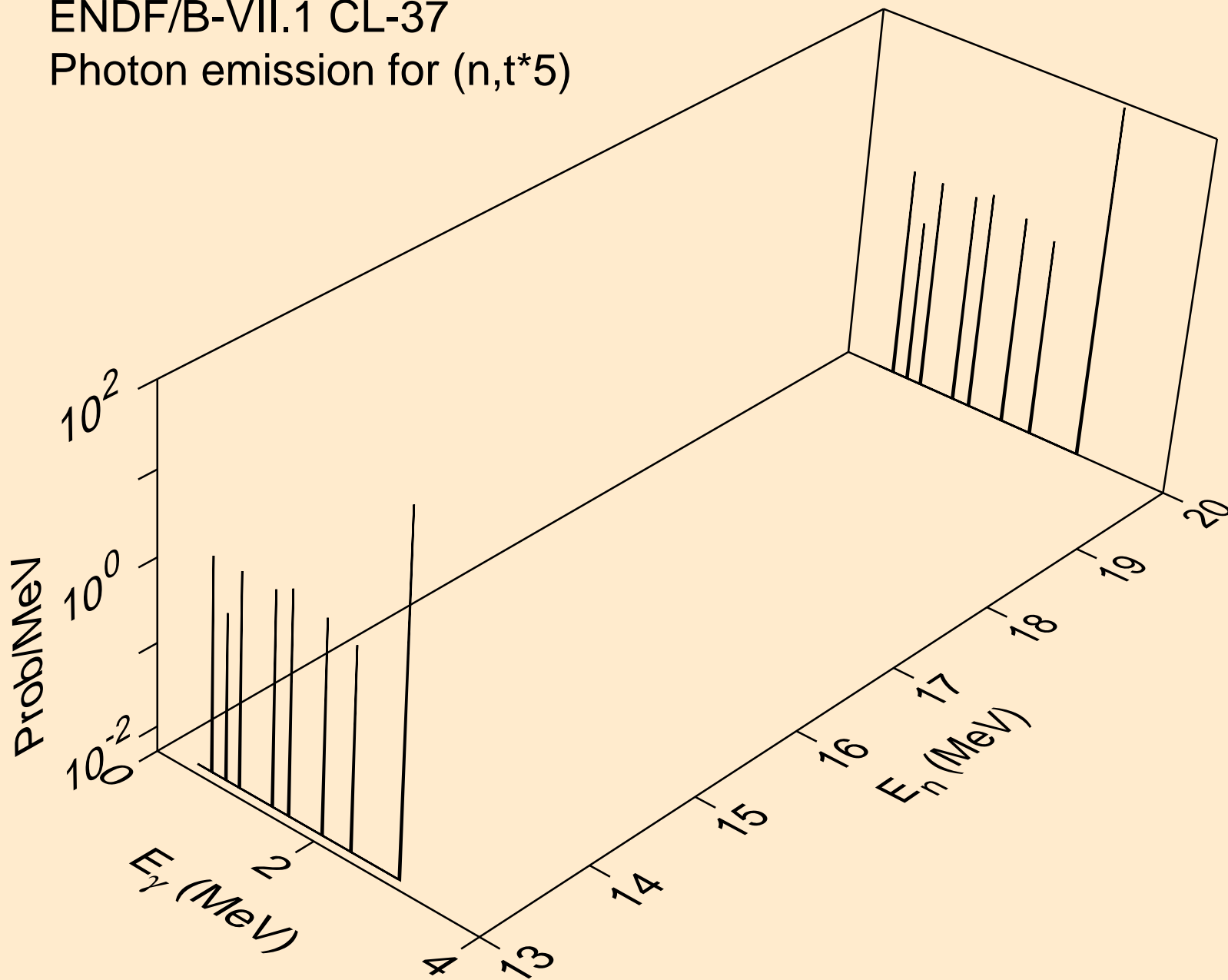

ENDF/B-VII.1 CL-37
Photon emission for (n,t*6)

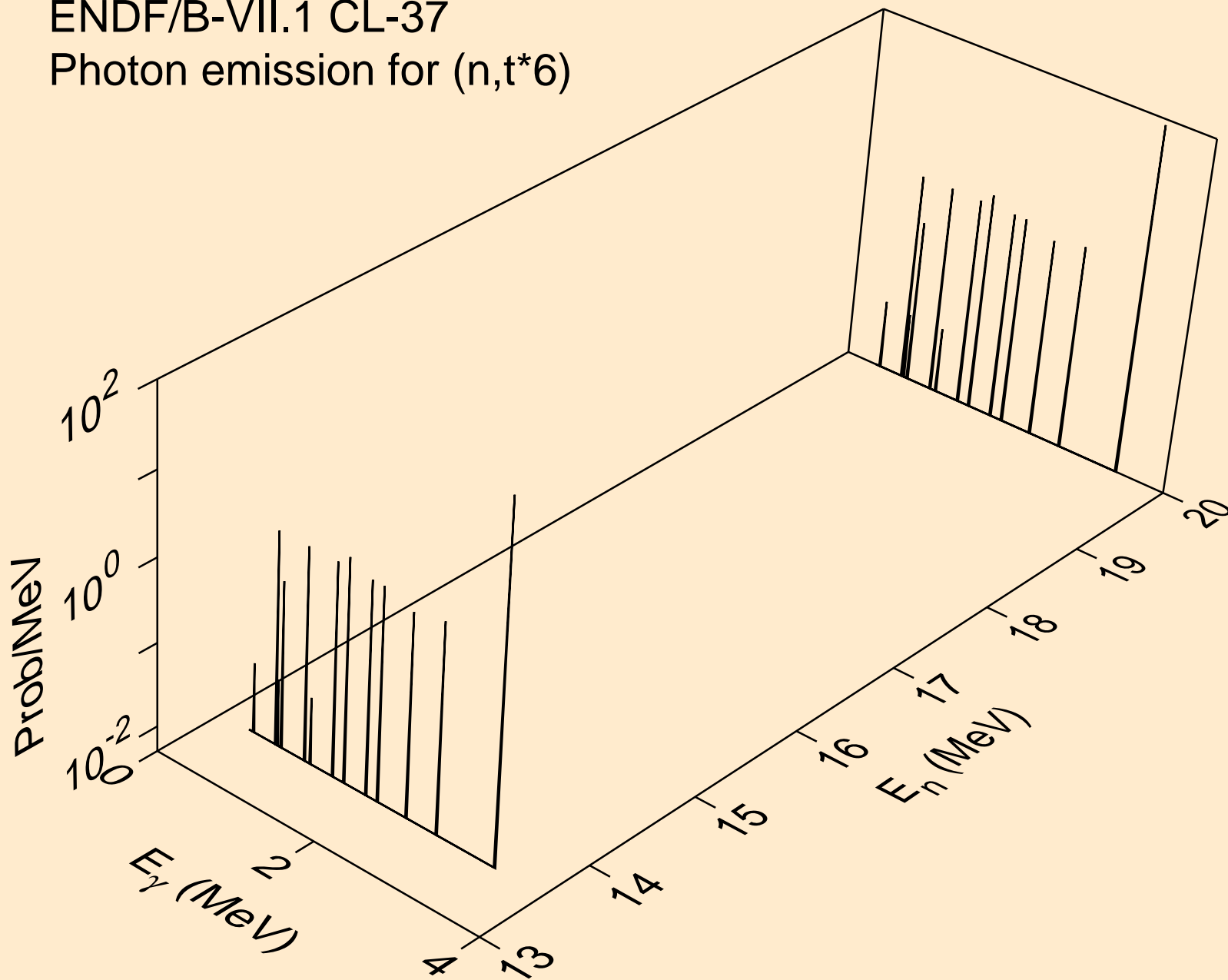

ENDF/B-VII.1 CL-37
Photon emission for (n,t*7)

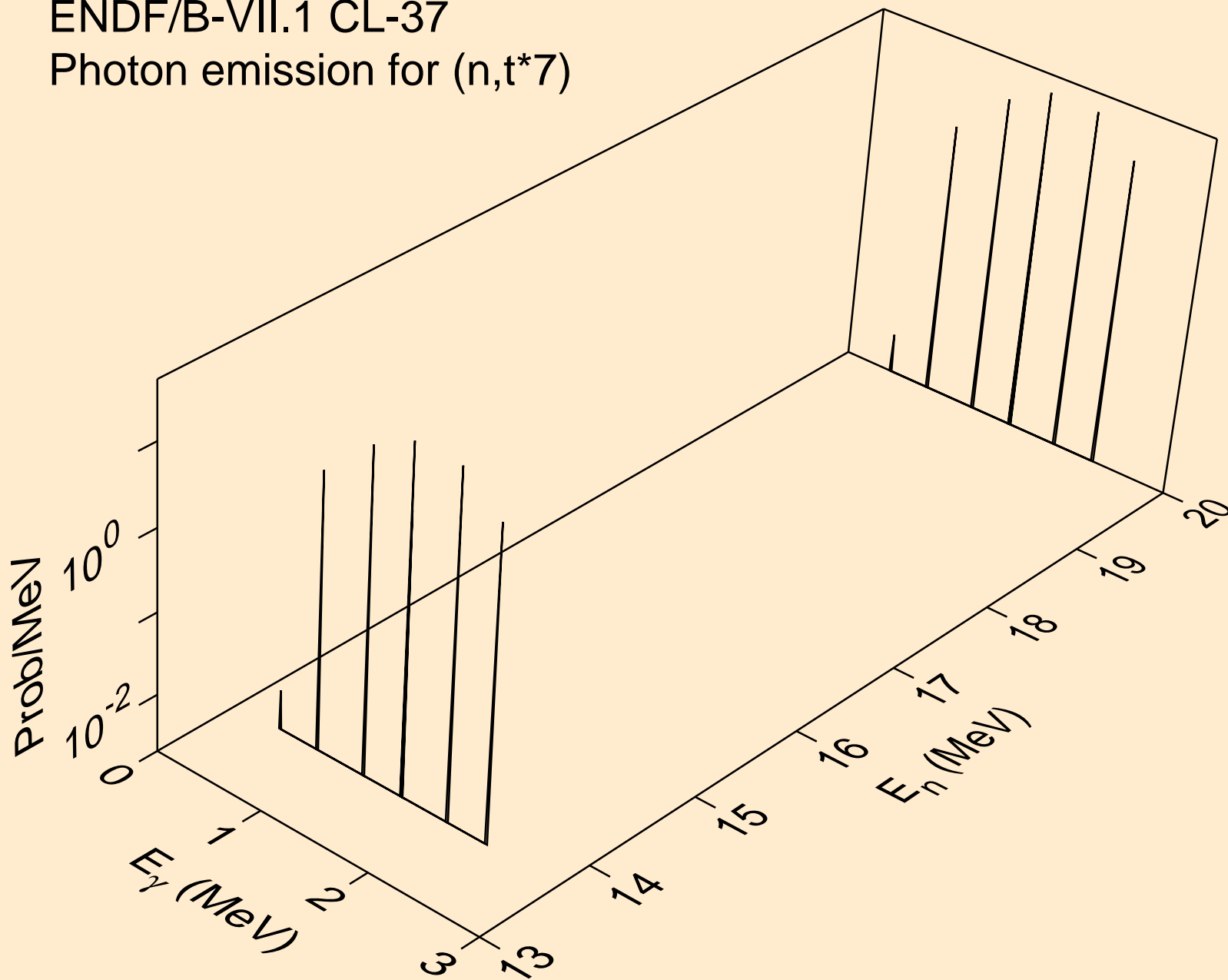

ENDF/B-VII.1 CL-37
Photon emission for (n,t*8)

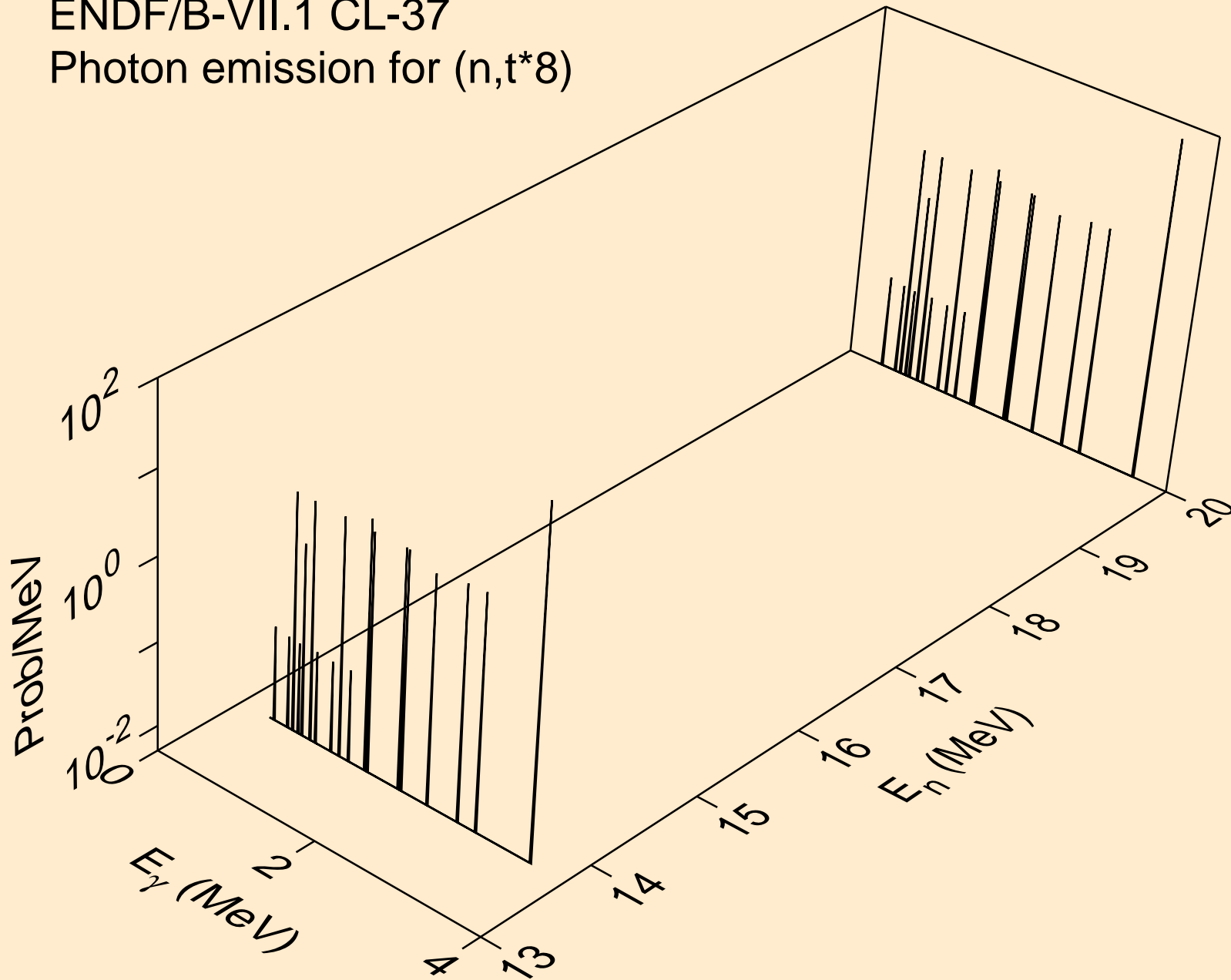

ENDF/B-VII.1 CL-37
Photon emission for (n,t*9)

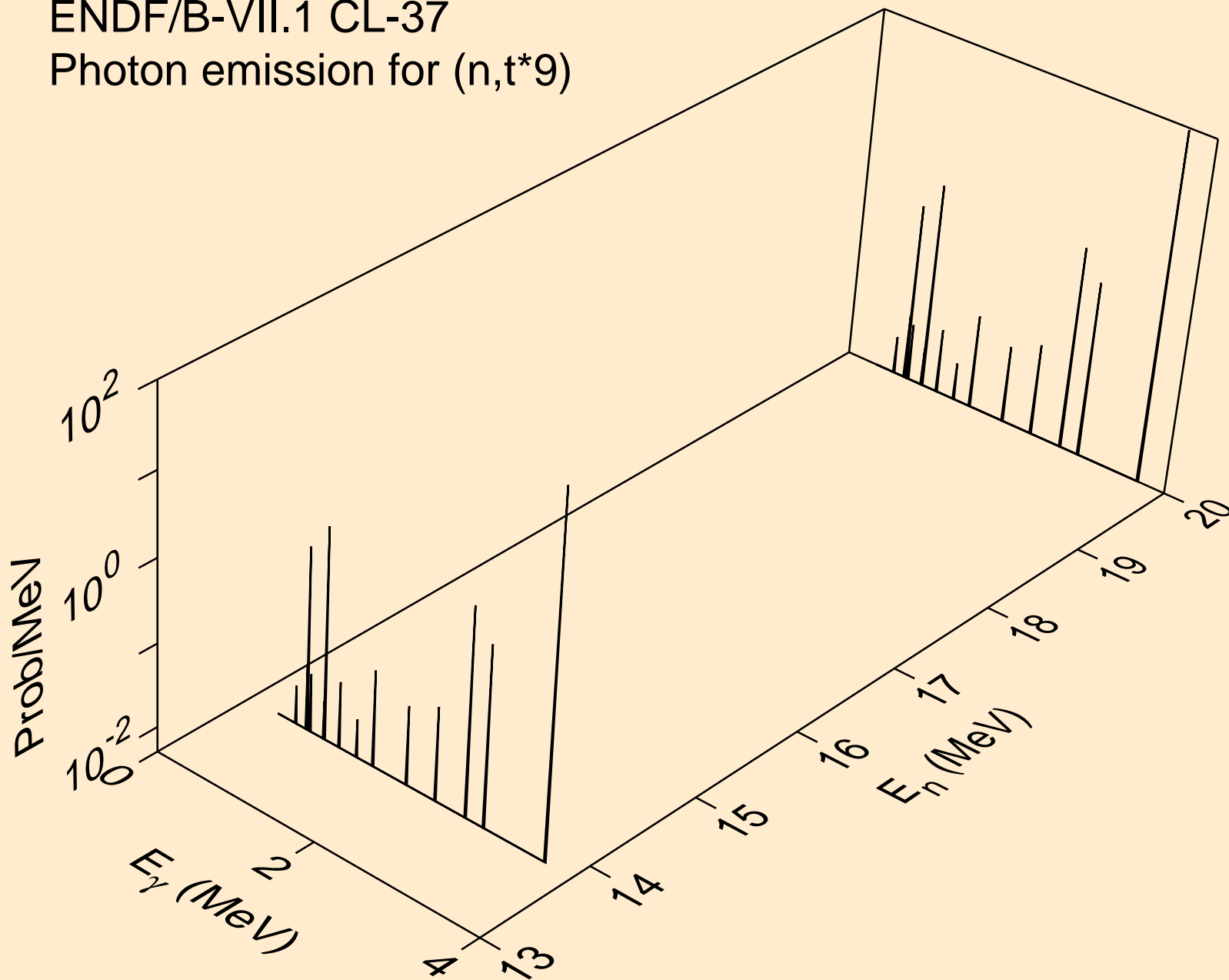

ENDF/B-VII.1 CL-37
Photon emission for (n,t*10)

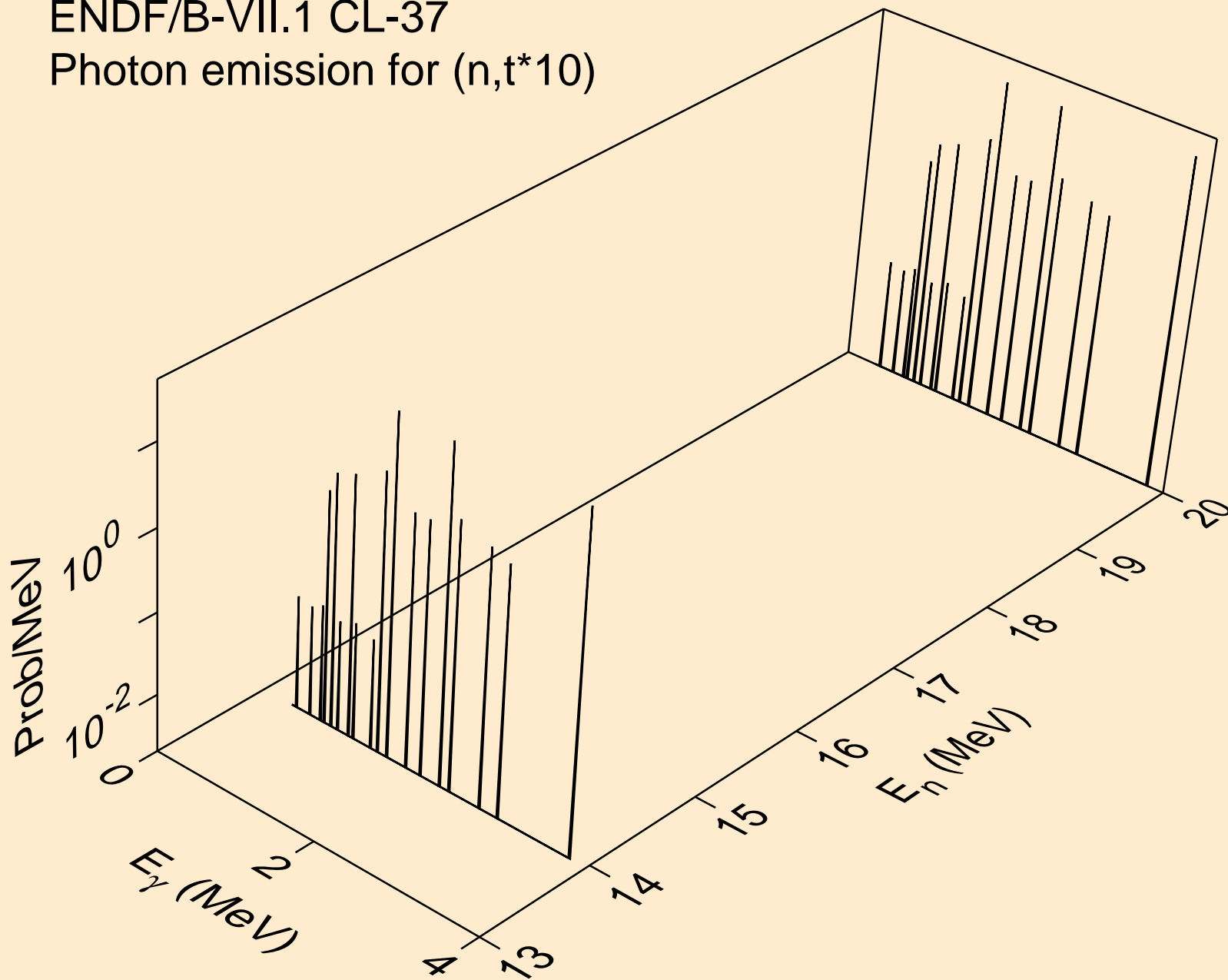

ENDF/B-VII.1 CL-37
Photon emission for (n,t*11)

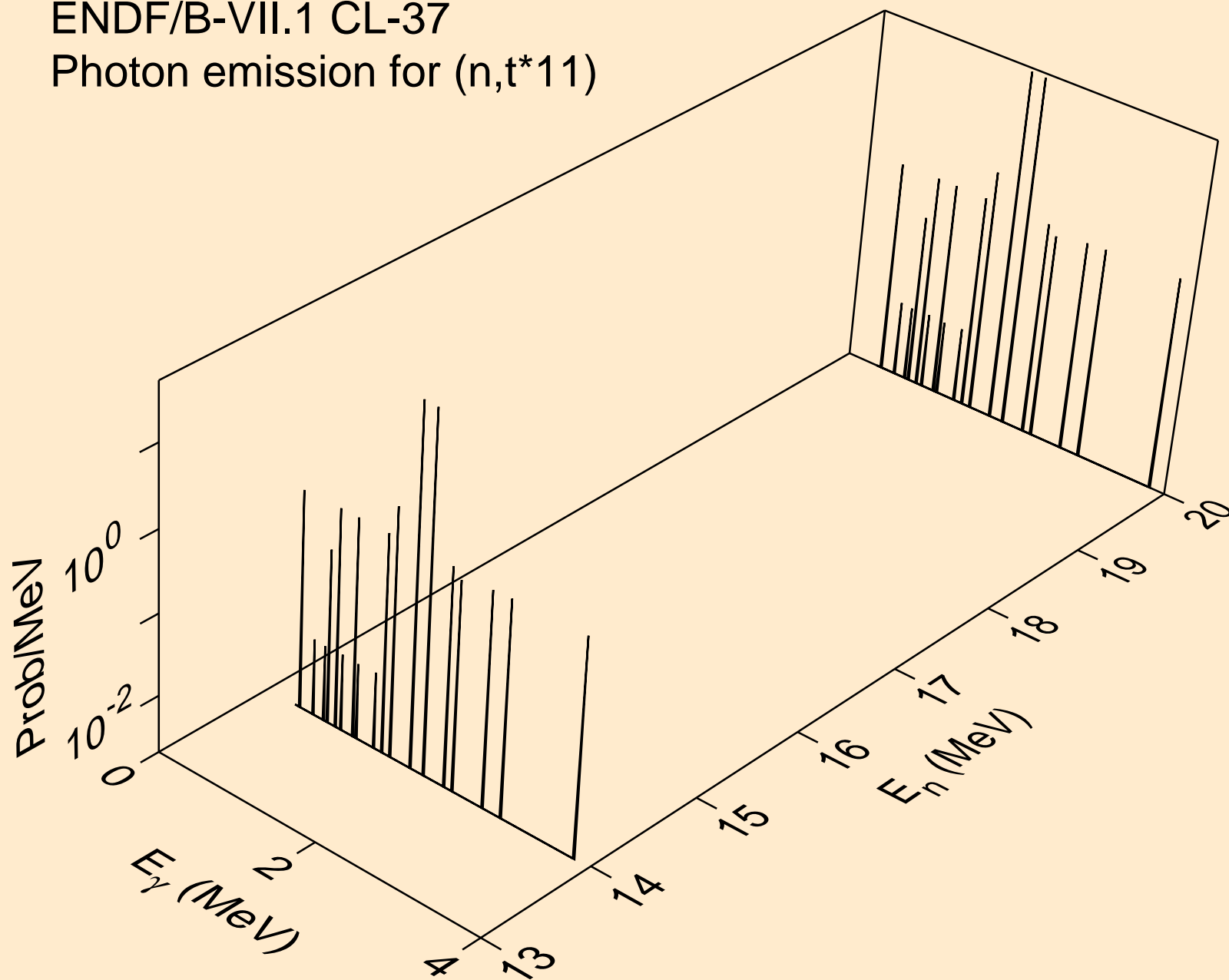

ENDF/B-VII.1 CL-37
Photon emission for (n,t*12)

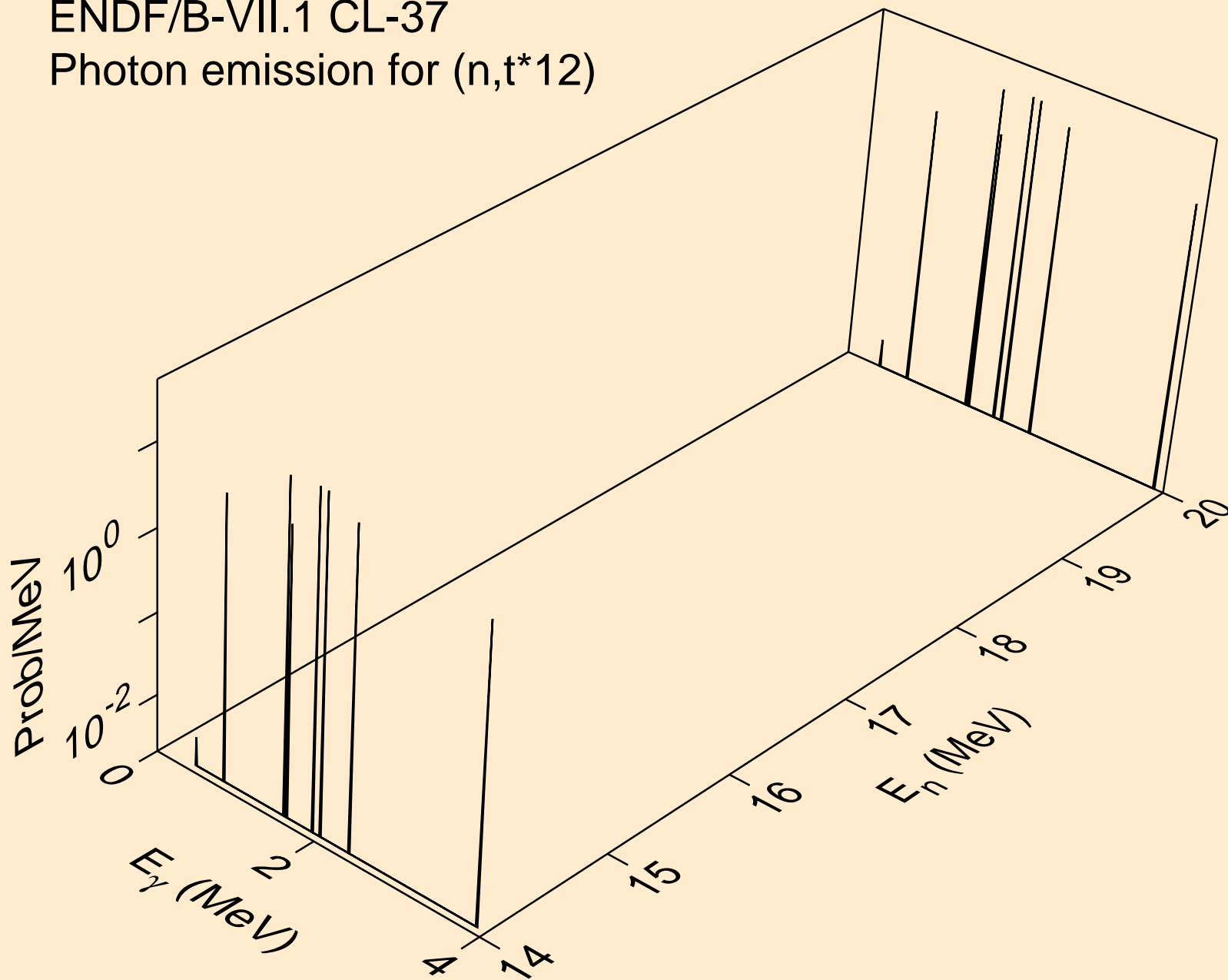

ENDF/B-VII.1 CL-37
Photon emission for (n,t*13)

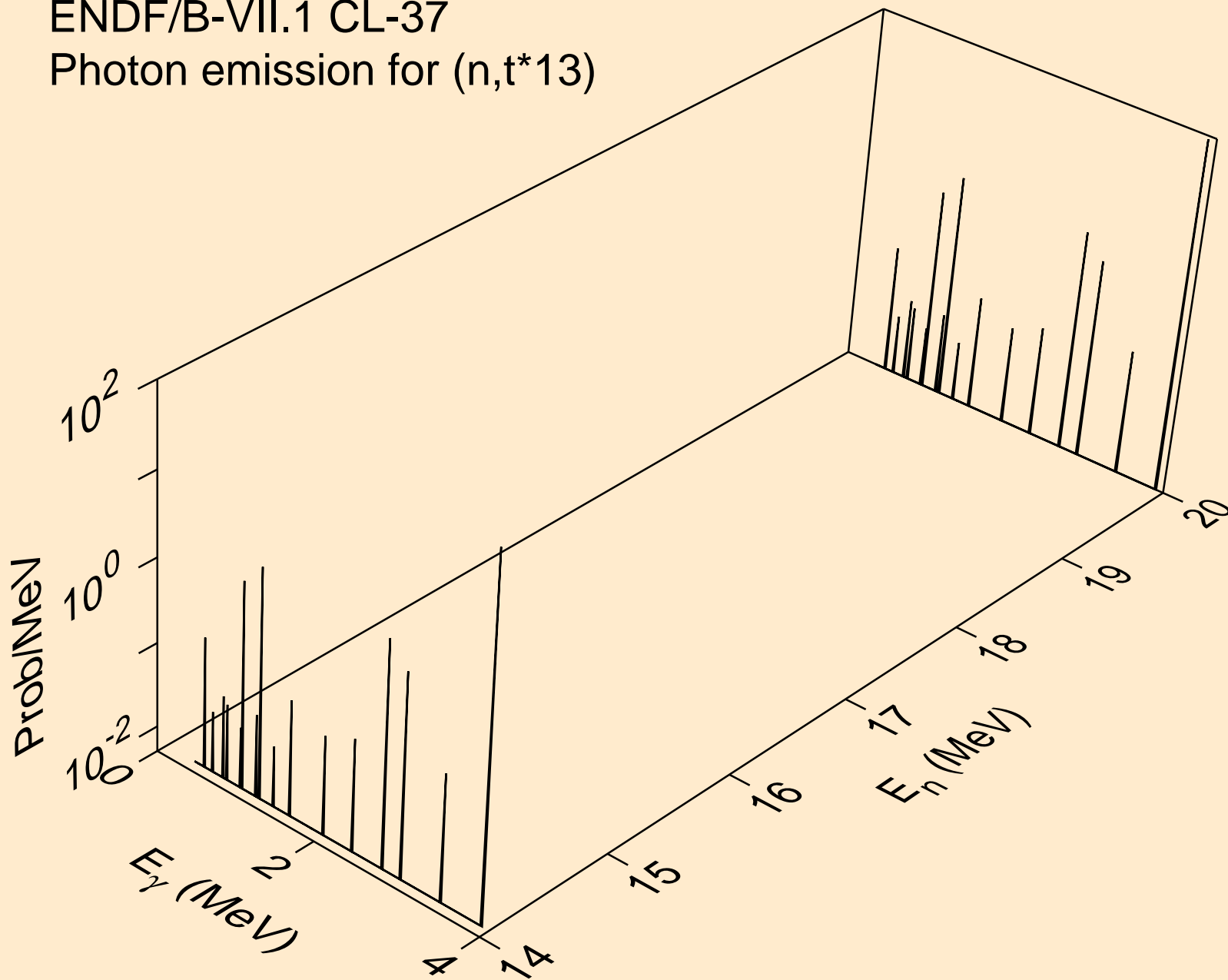

ENDF/B-VII.1 CL-37
Photon emission for (n,t*14)

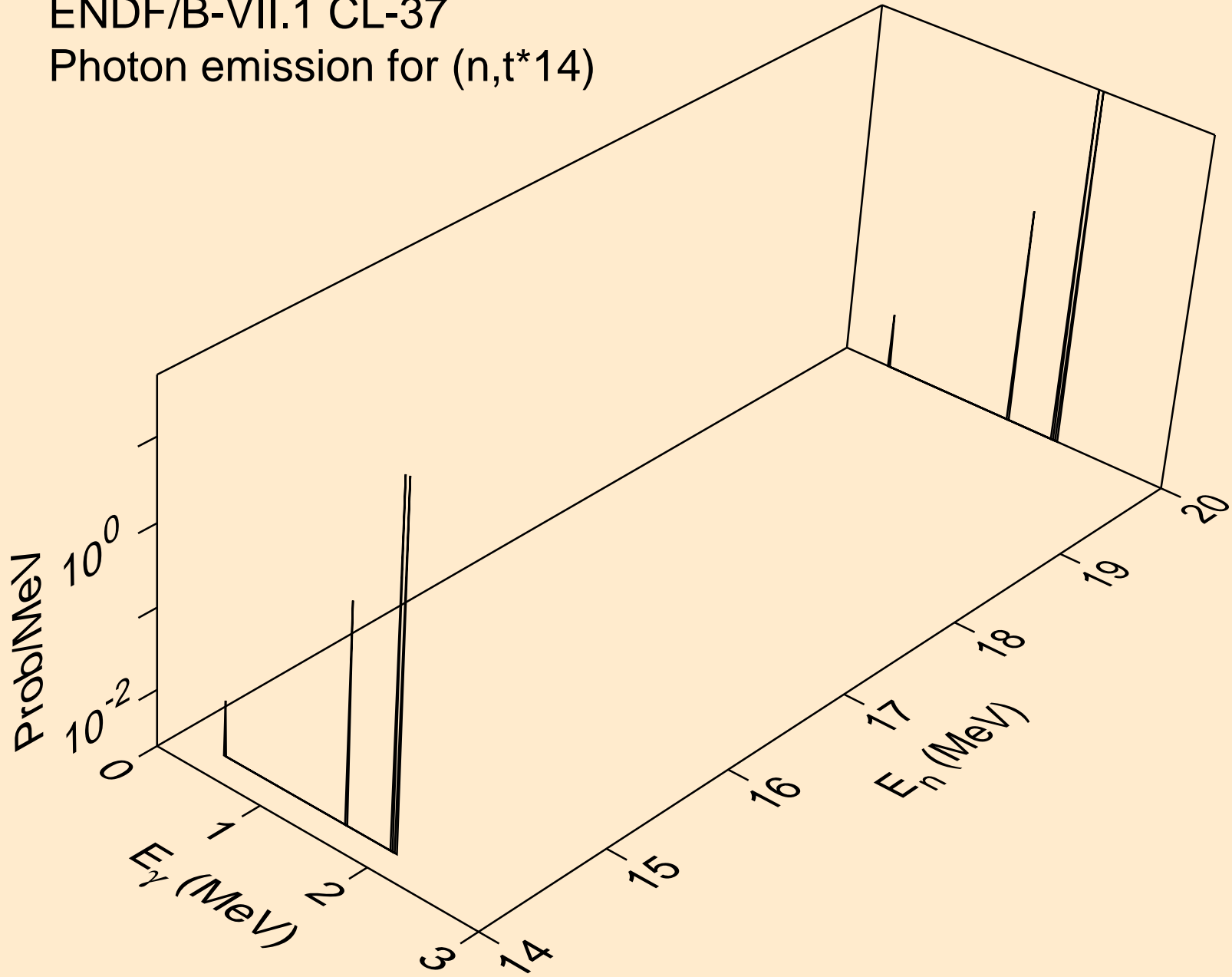

ENDF/B-VII.1 CL-37
Photon emission for (n,t*15)

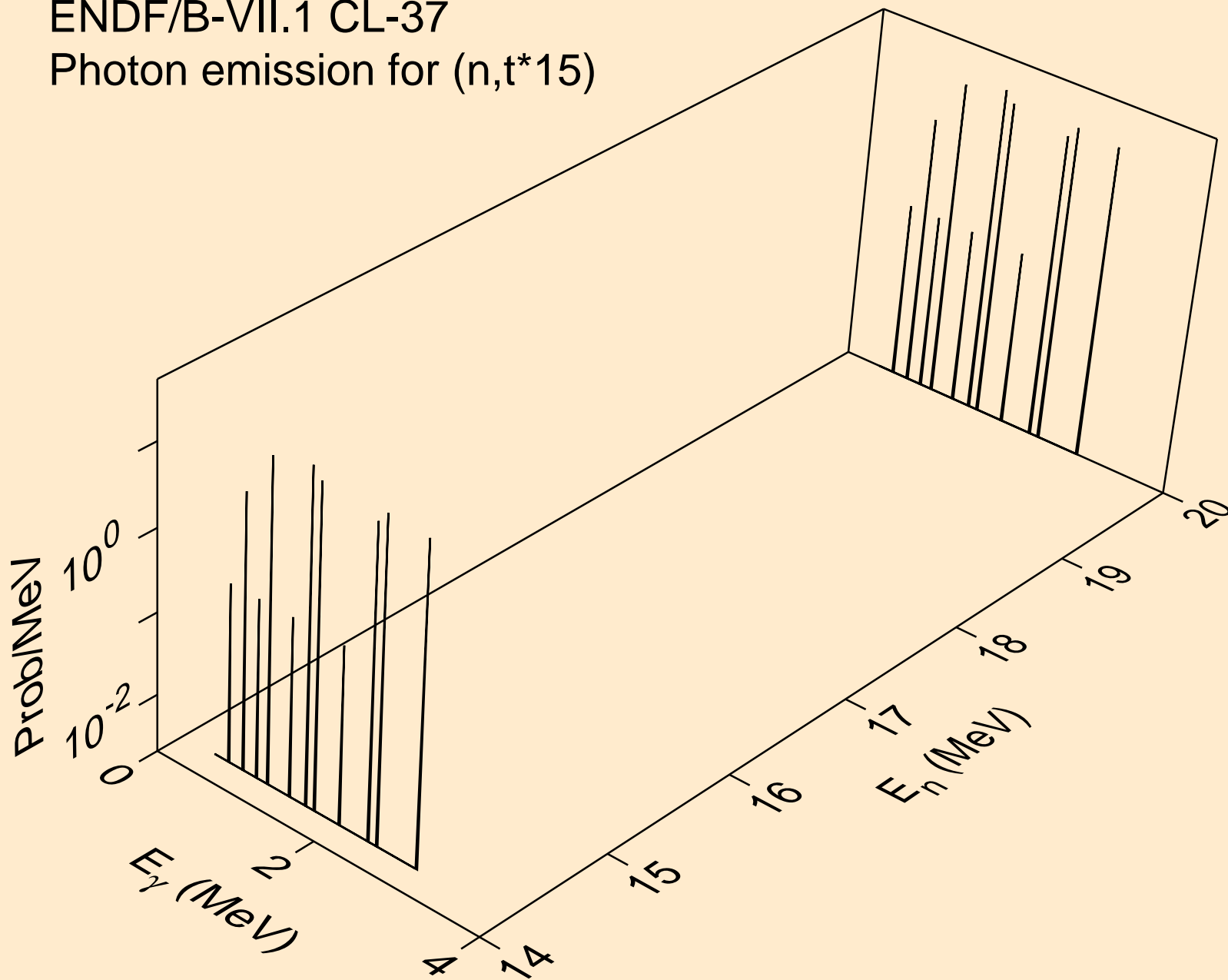

ENDF/B-VII.1 CL-37
Photon emission for (n,t*c)

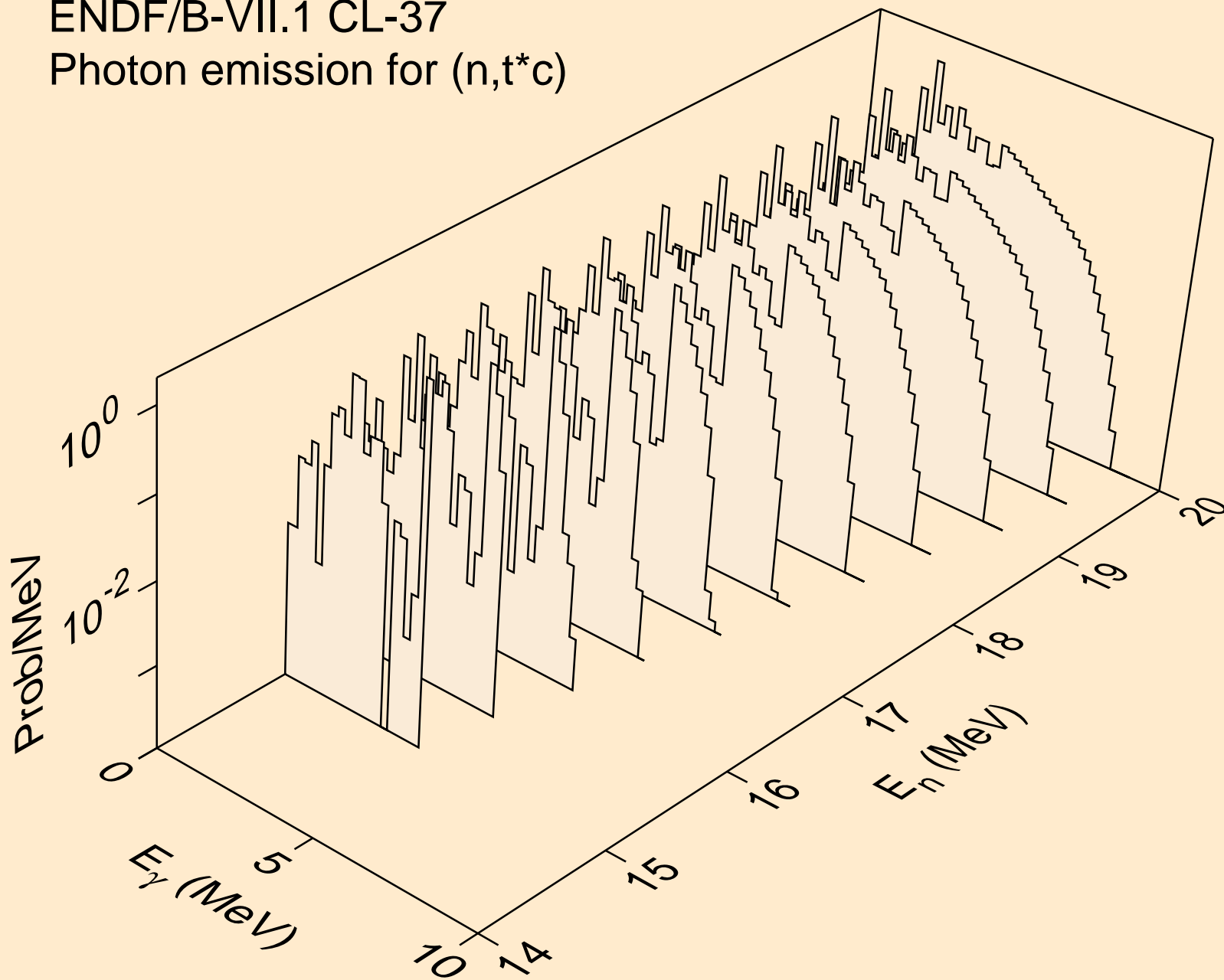

ENDF/B-VII.1 CL-37
Photon emission for (n,a*1)

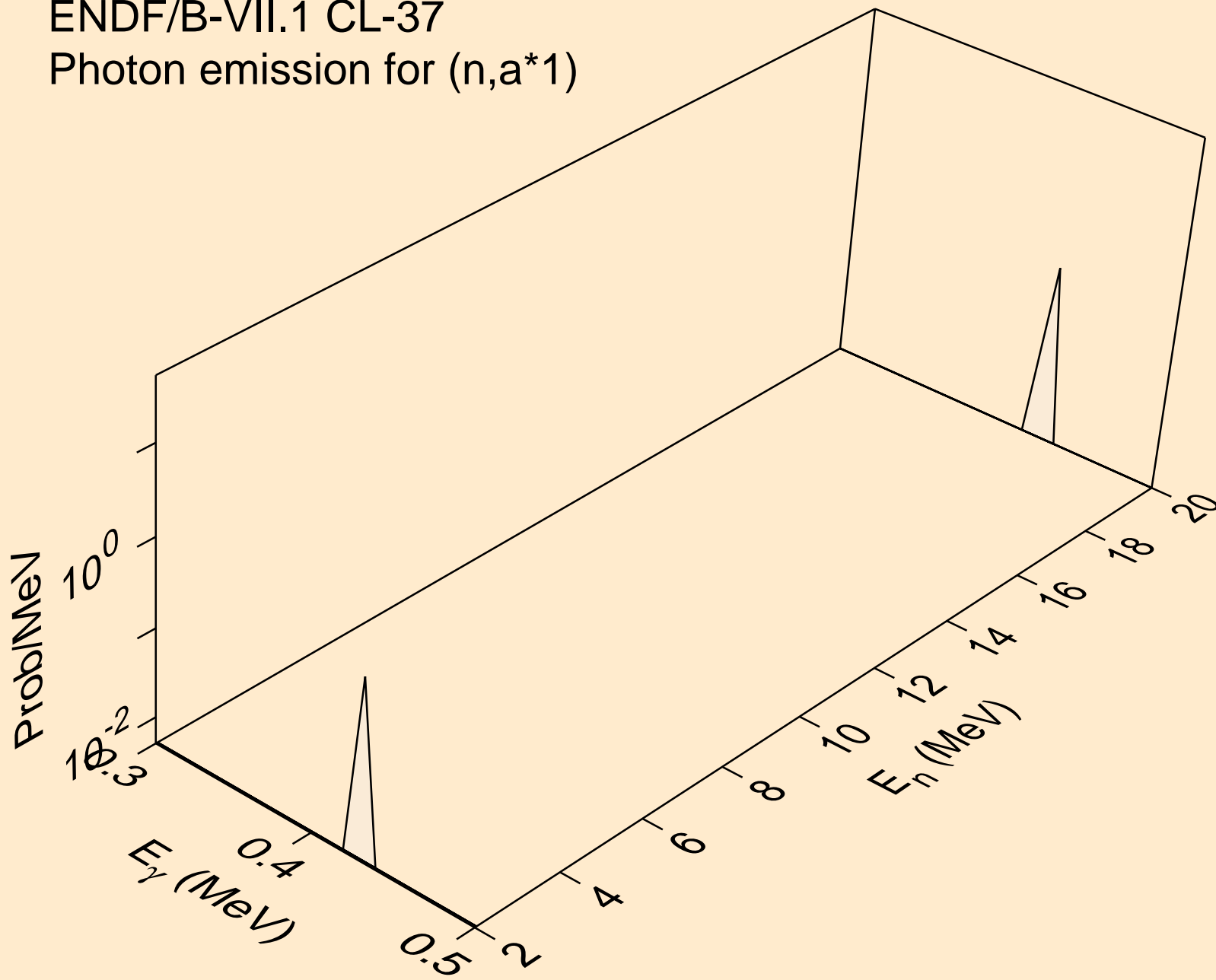

ENDF/B-VII.1 CL-37
Photon emission for (n,a*2)

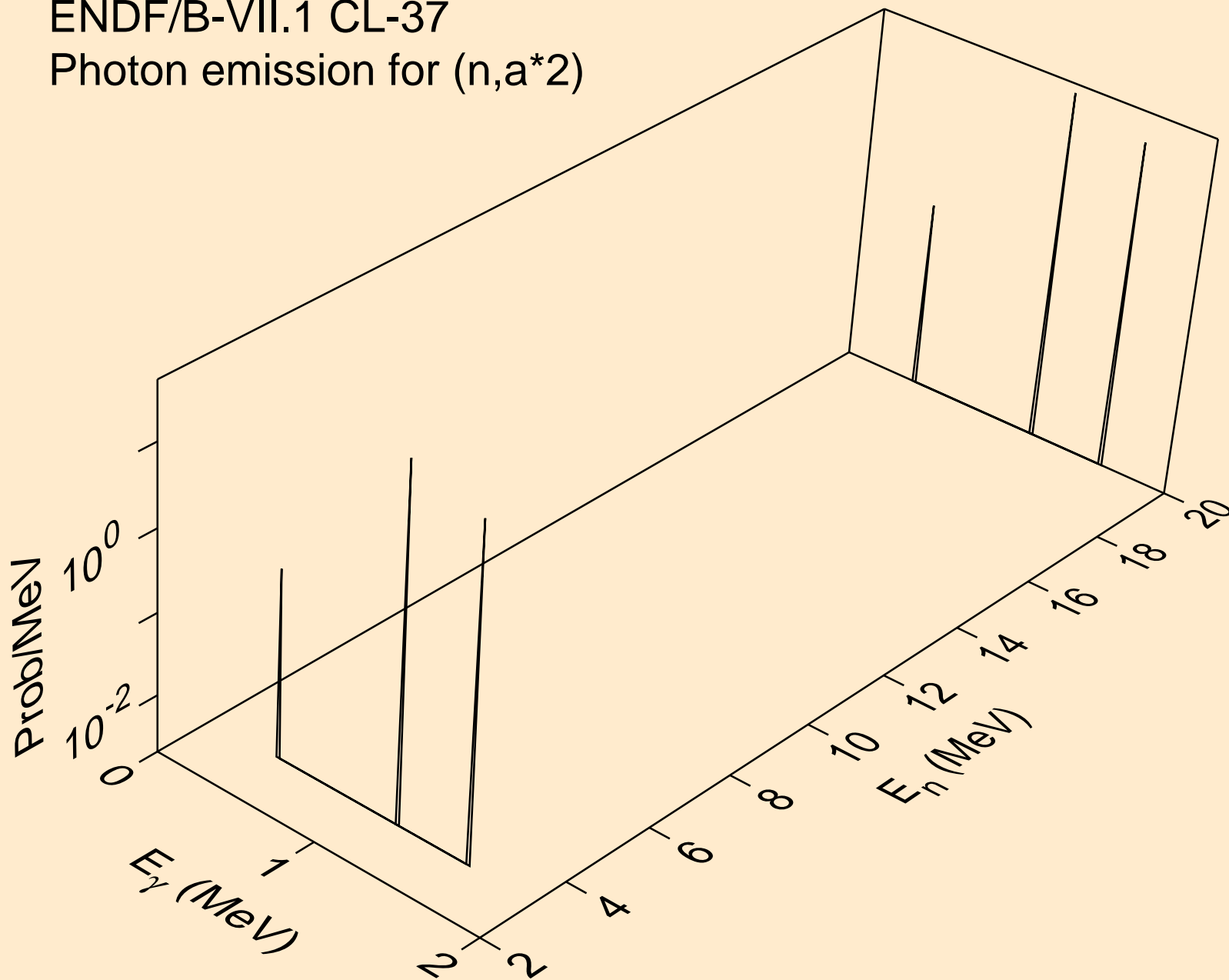

ENDF/B-VII.1 CL-37
Photon emission for (n,a*3)

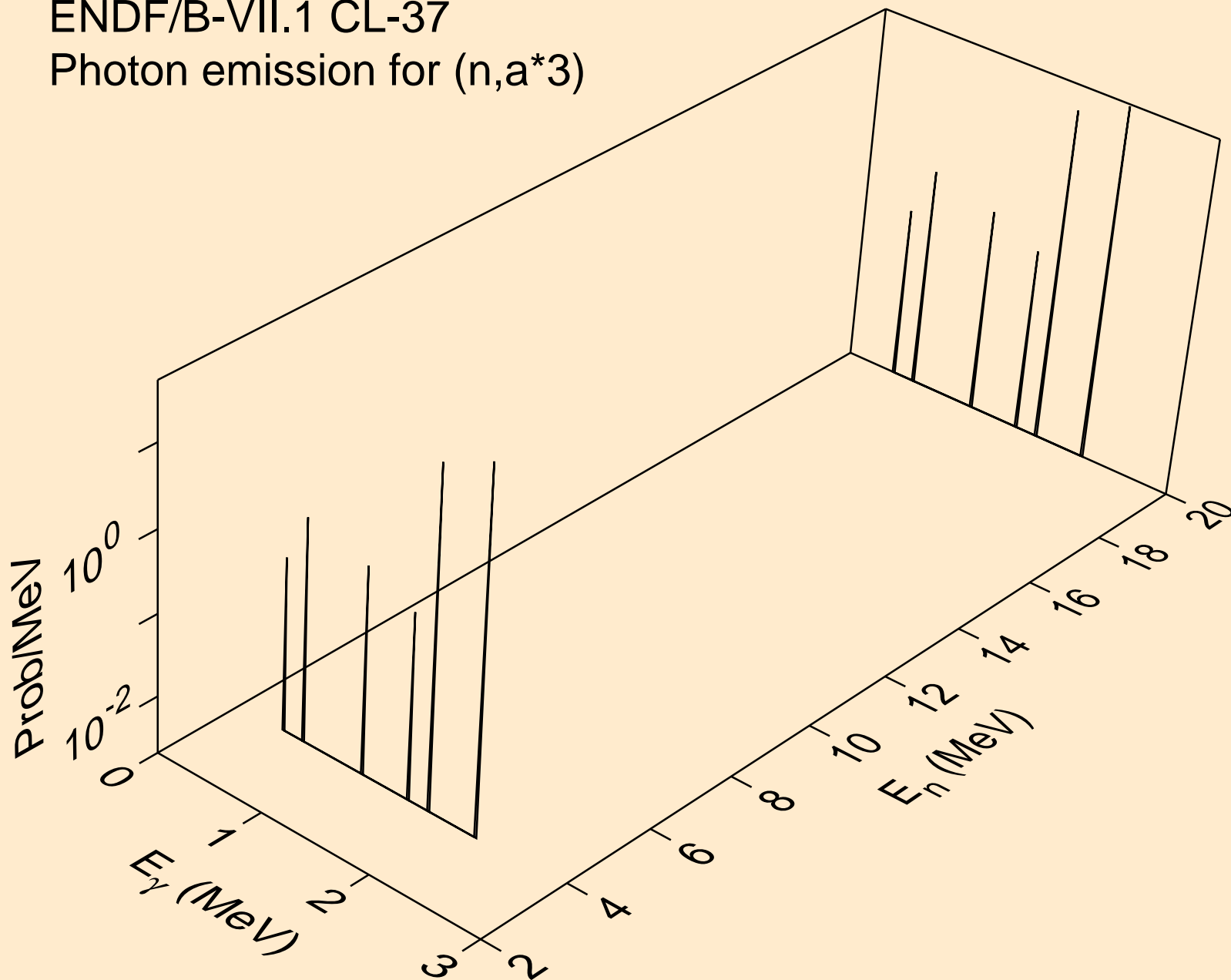

ENDF/B-VII.1 CL-37
Photon emission for (n,a*4)

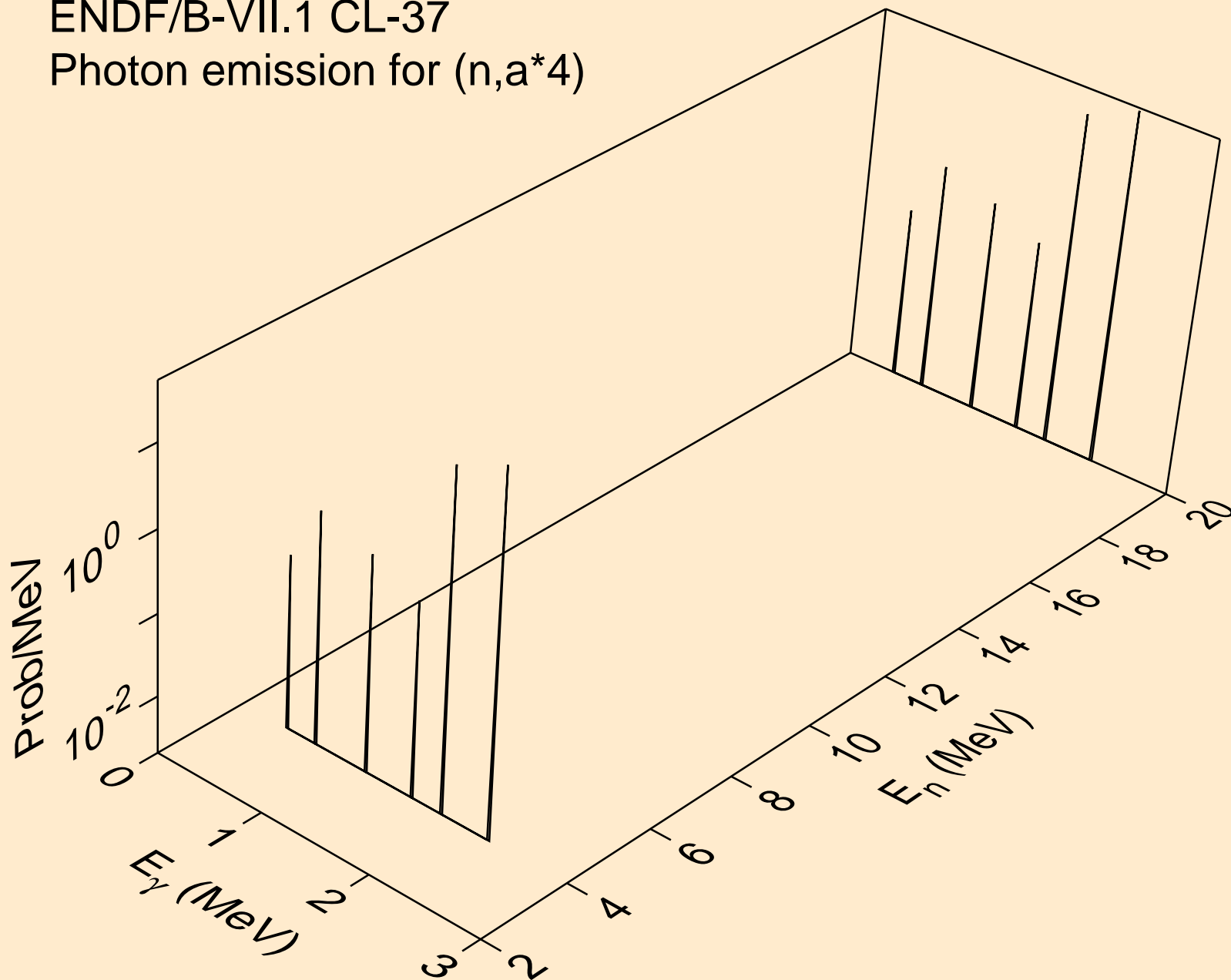

ENDF/B-VII.1 CL-37
Photon emission for (n,a*5)

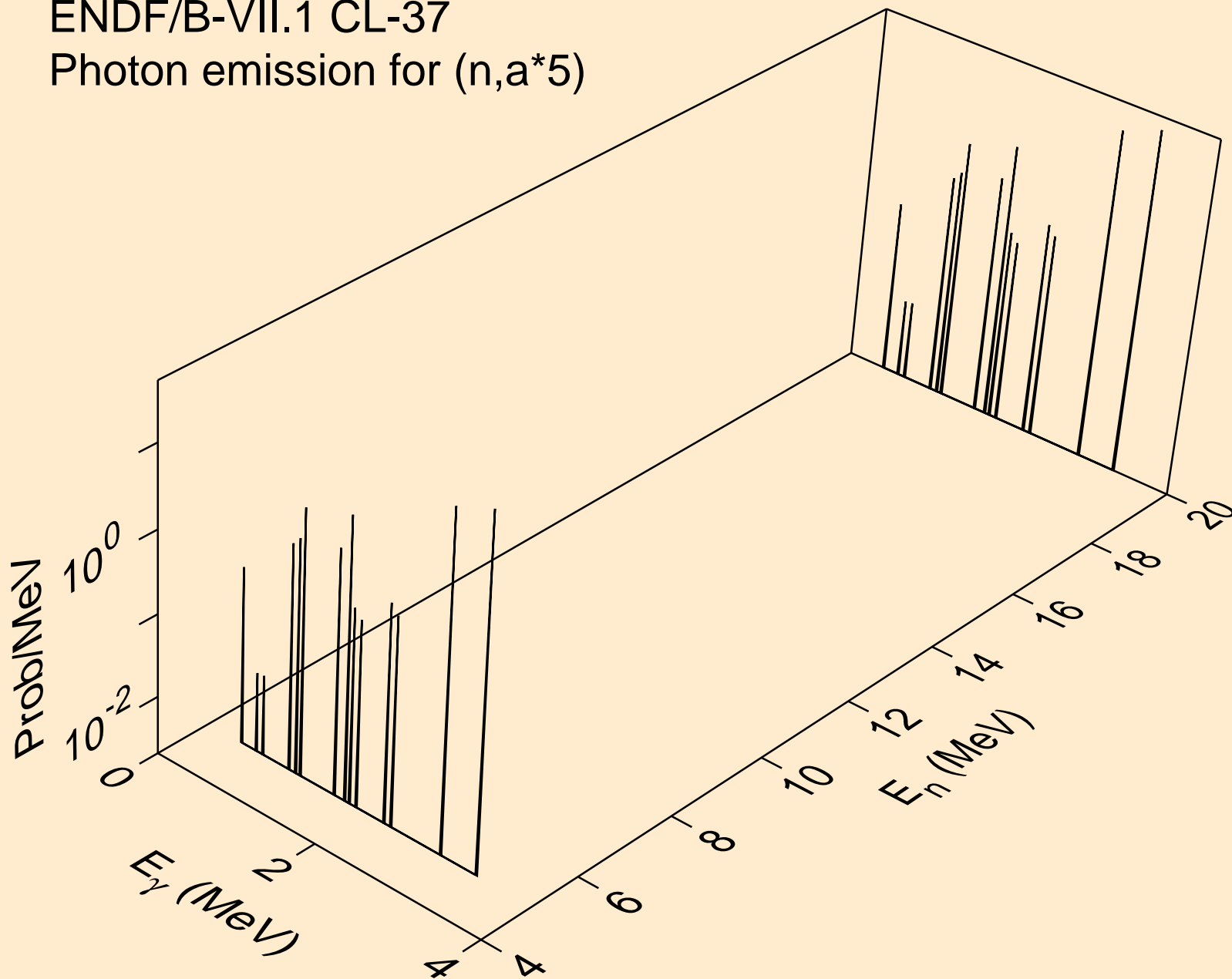

ENDF/B-VII.1 CL-37
Photon emission for (n,a*c)

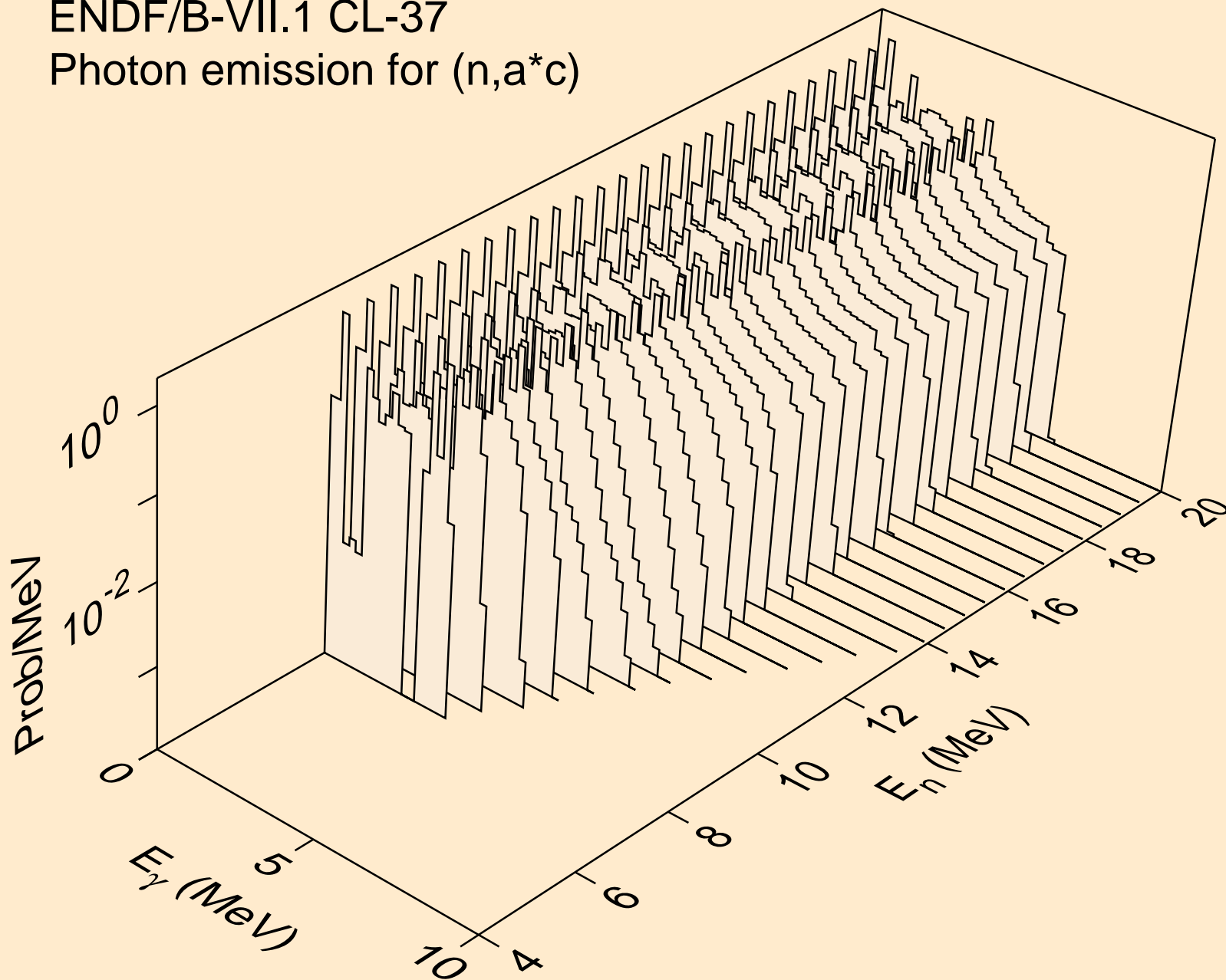

ENDF/B-VII.1 CL-37
thermal capture photon spectrum

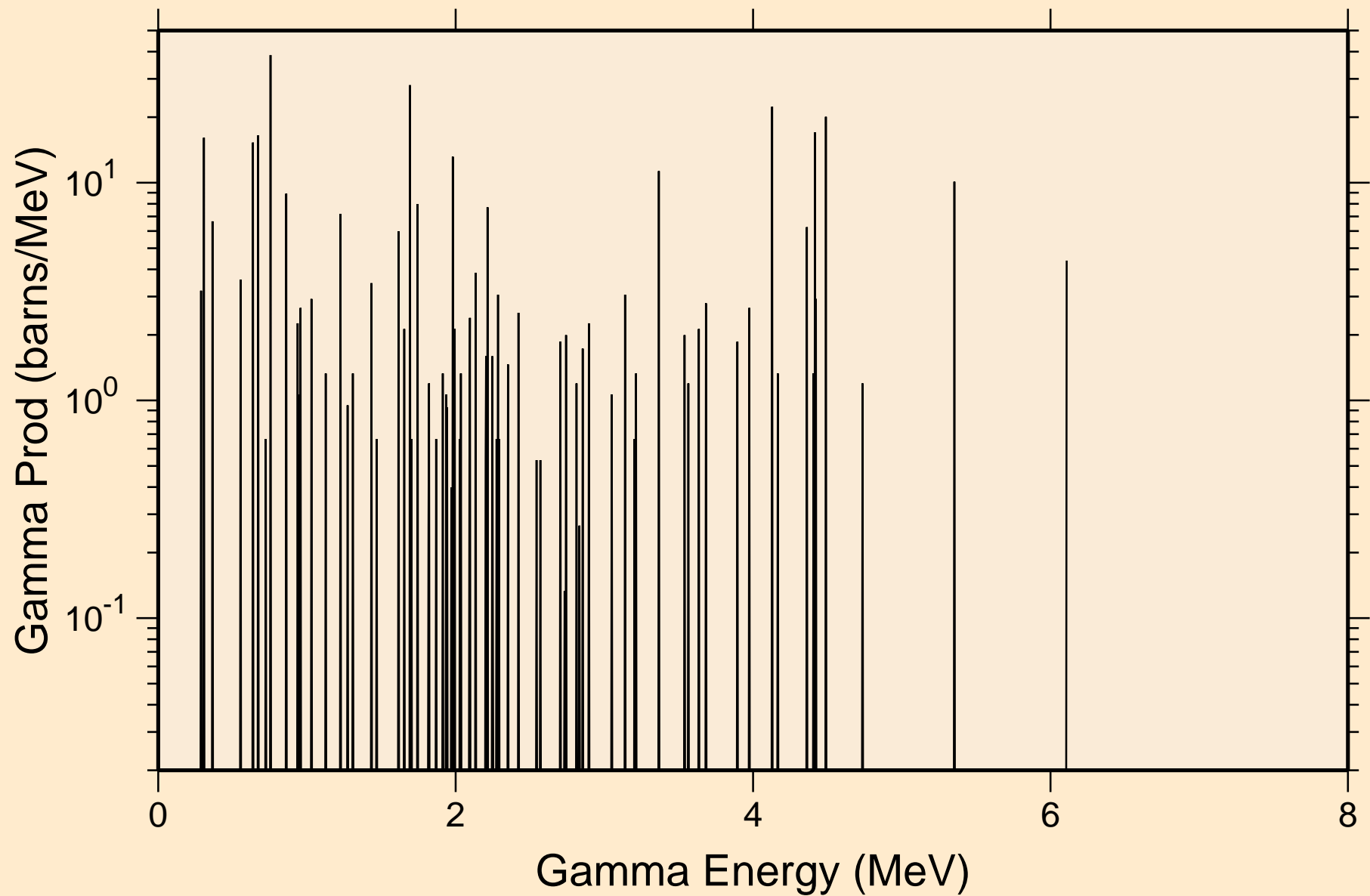

ENDF/B-VII.1 CL-37
14 MeV photon spectrum

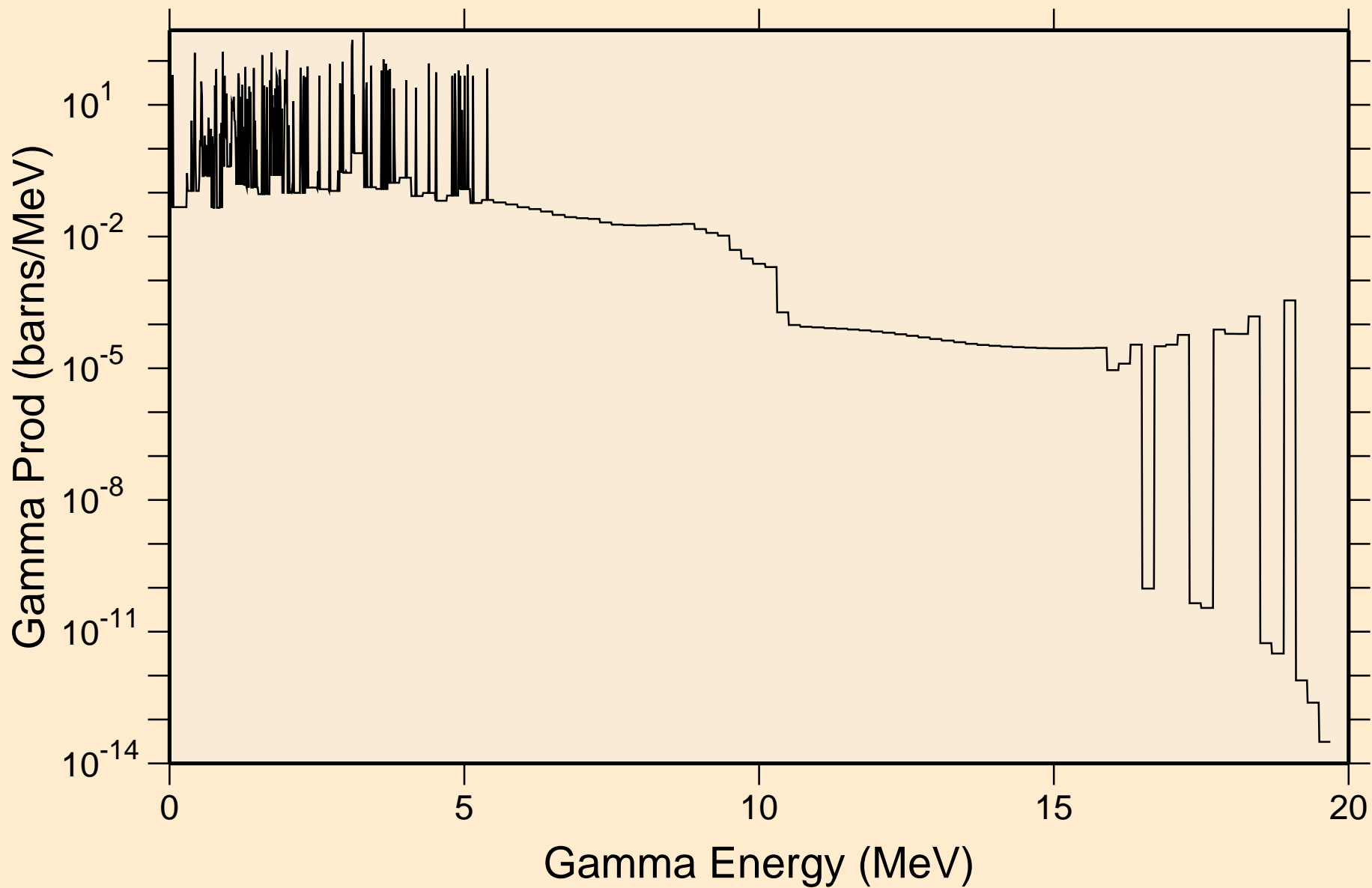

ENDF/B-VII.1 CL-37

Particle heating contributions

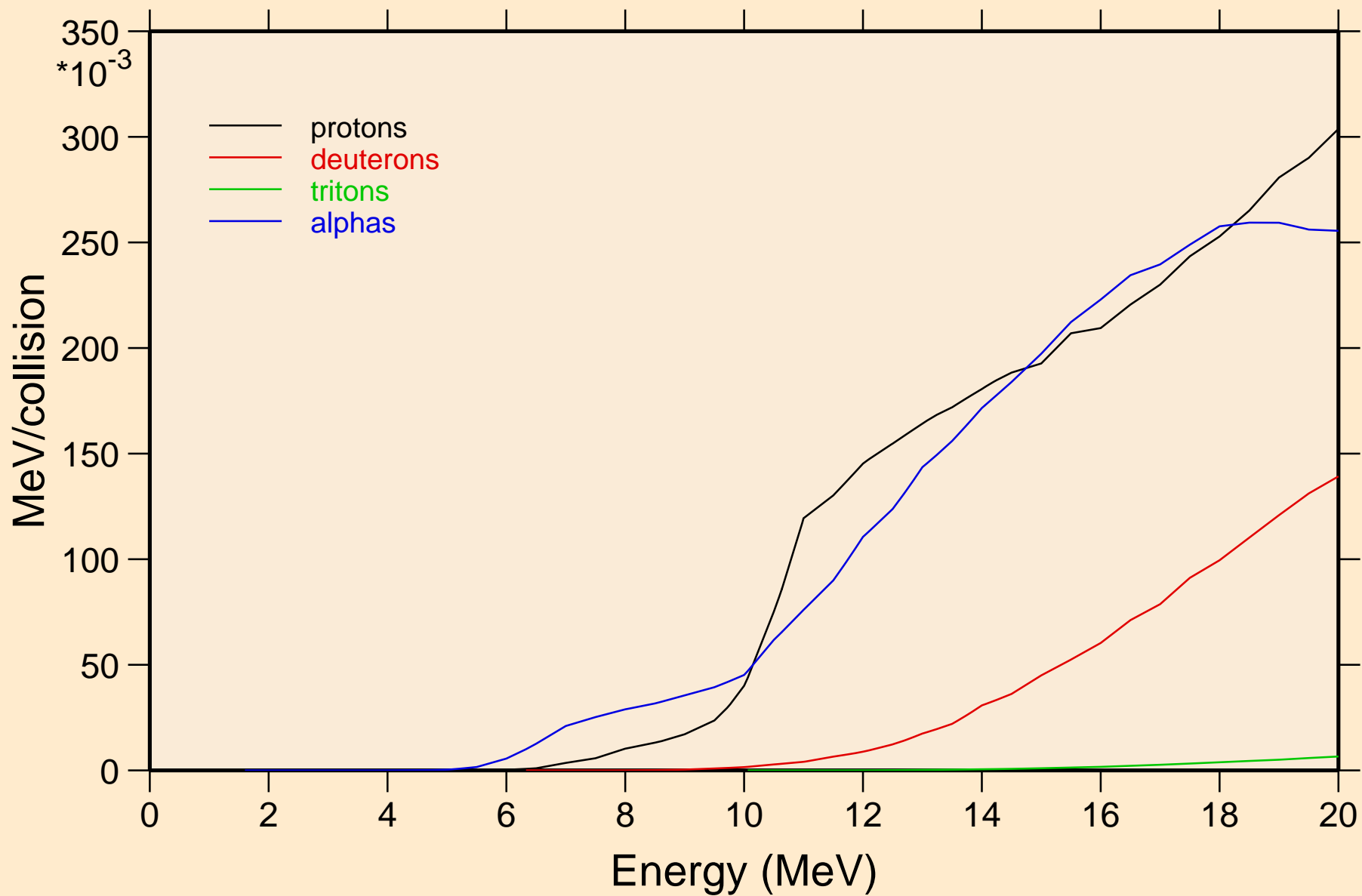

ENDF/B-VII.1 CL-37 Recoil Heating

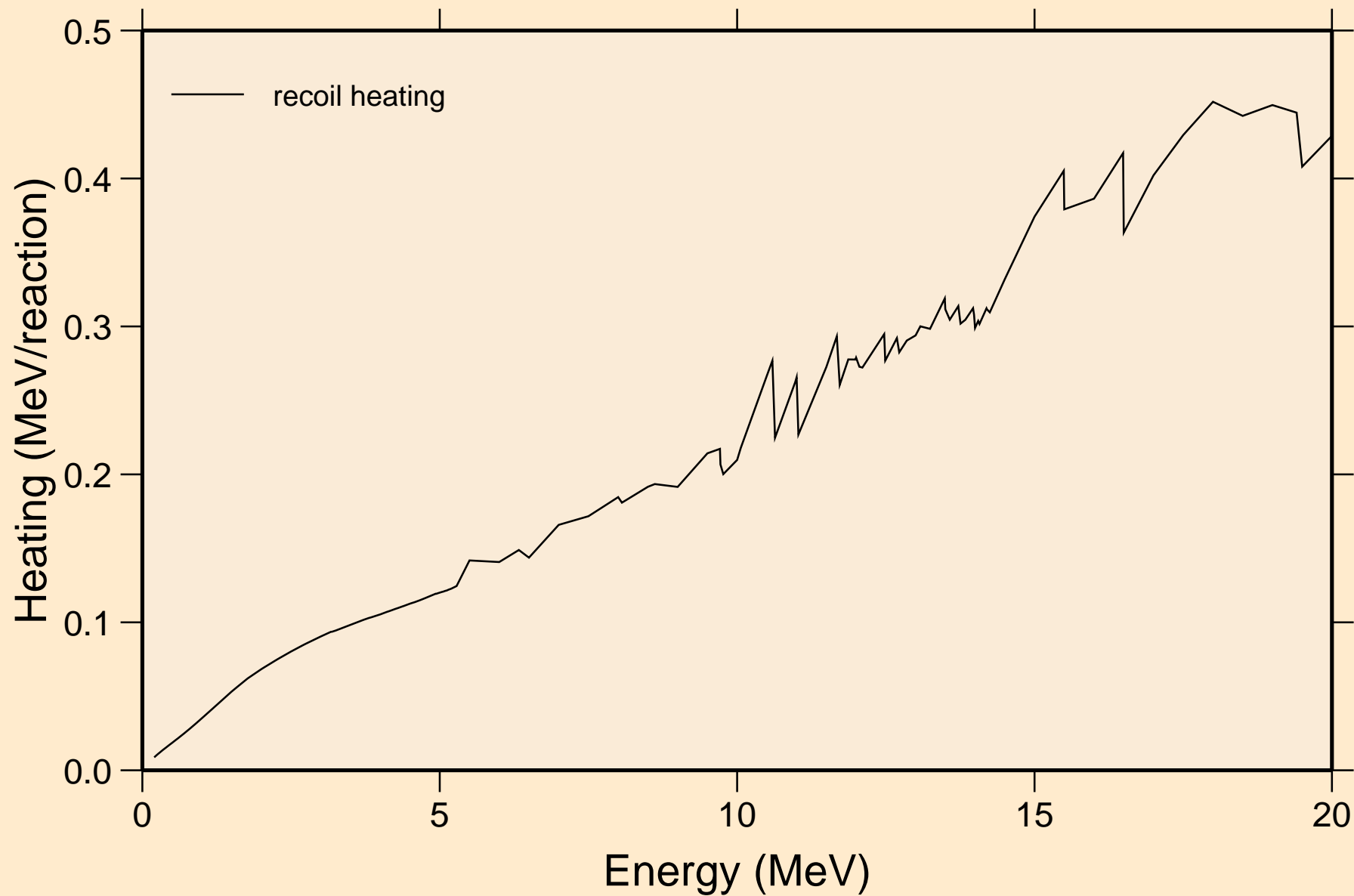

ENDF/B-VII.1 CL-37

Particle production cross sections

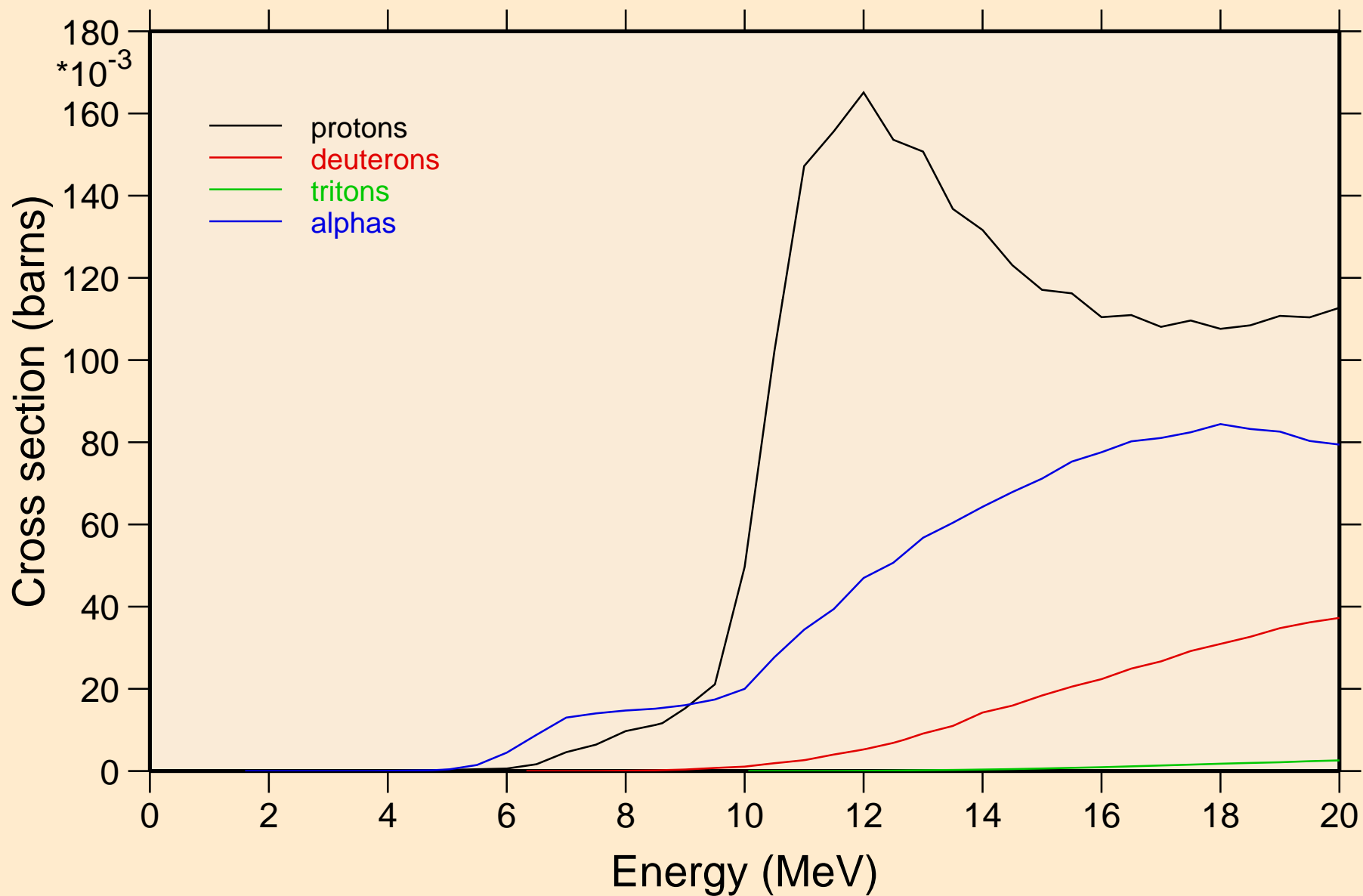

ENDF/B-VII.1 CL-37
protons from (n,n*)p

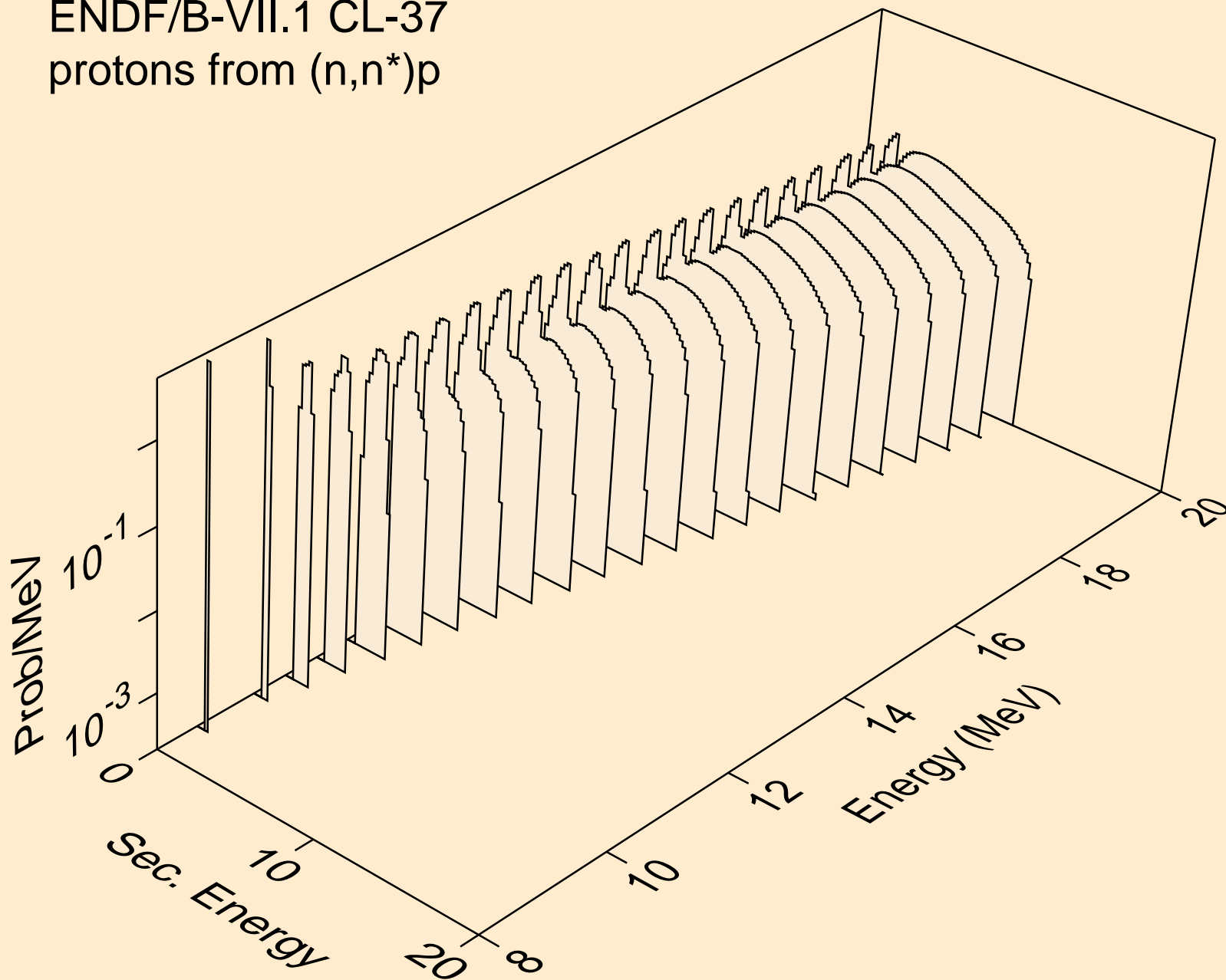

ENDF/B-VII.1 CL-37
protons from (n,p*c)

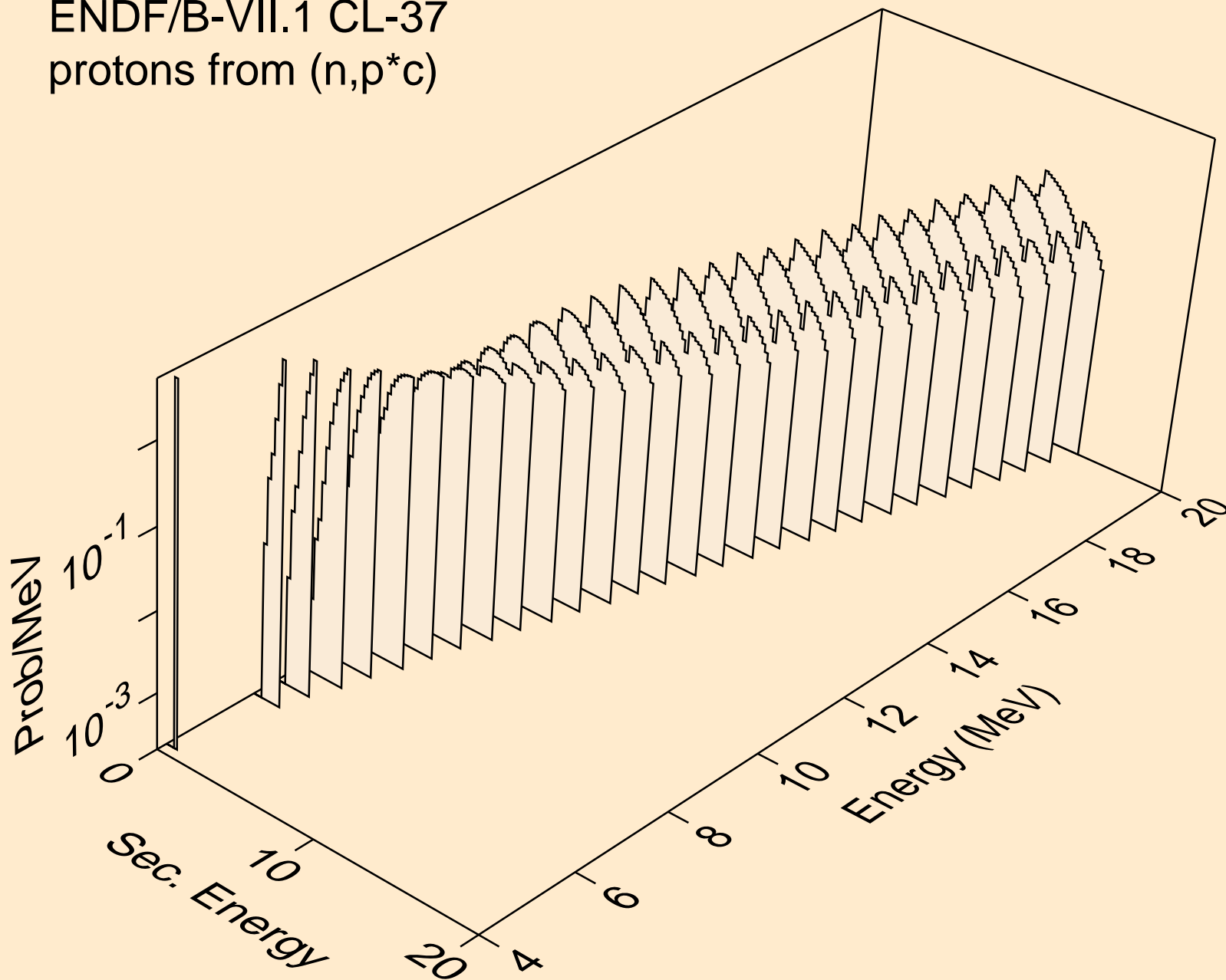

ENDF/B-VII.1 CL-37
deuterons from (n,n*)d

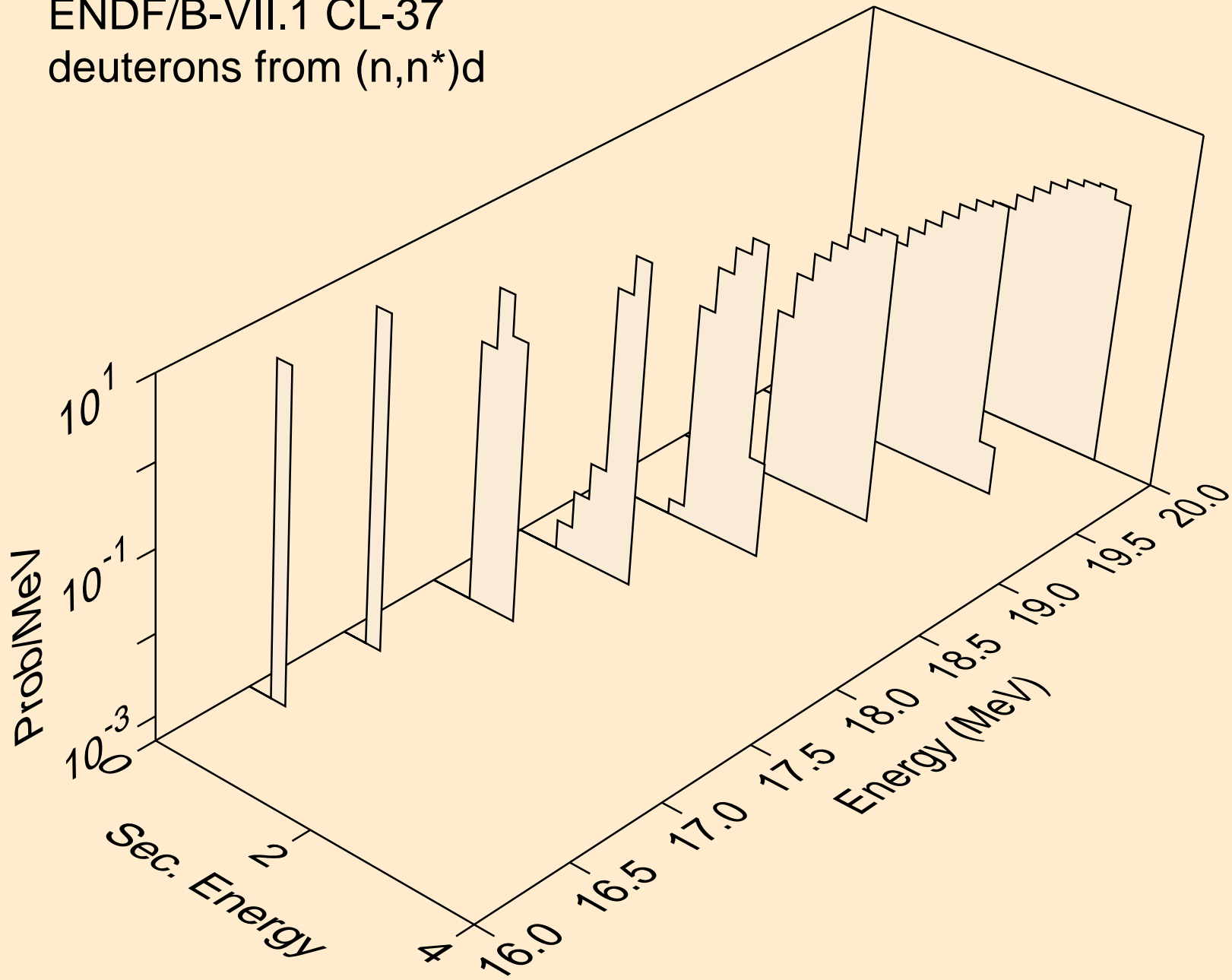

ENDF/B-VII.1 CL-37

angular distribution for (n,d*0) deuteron

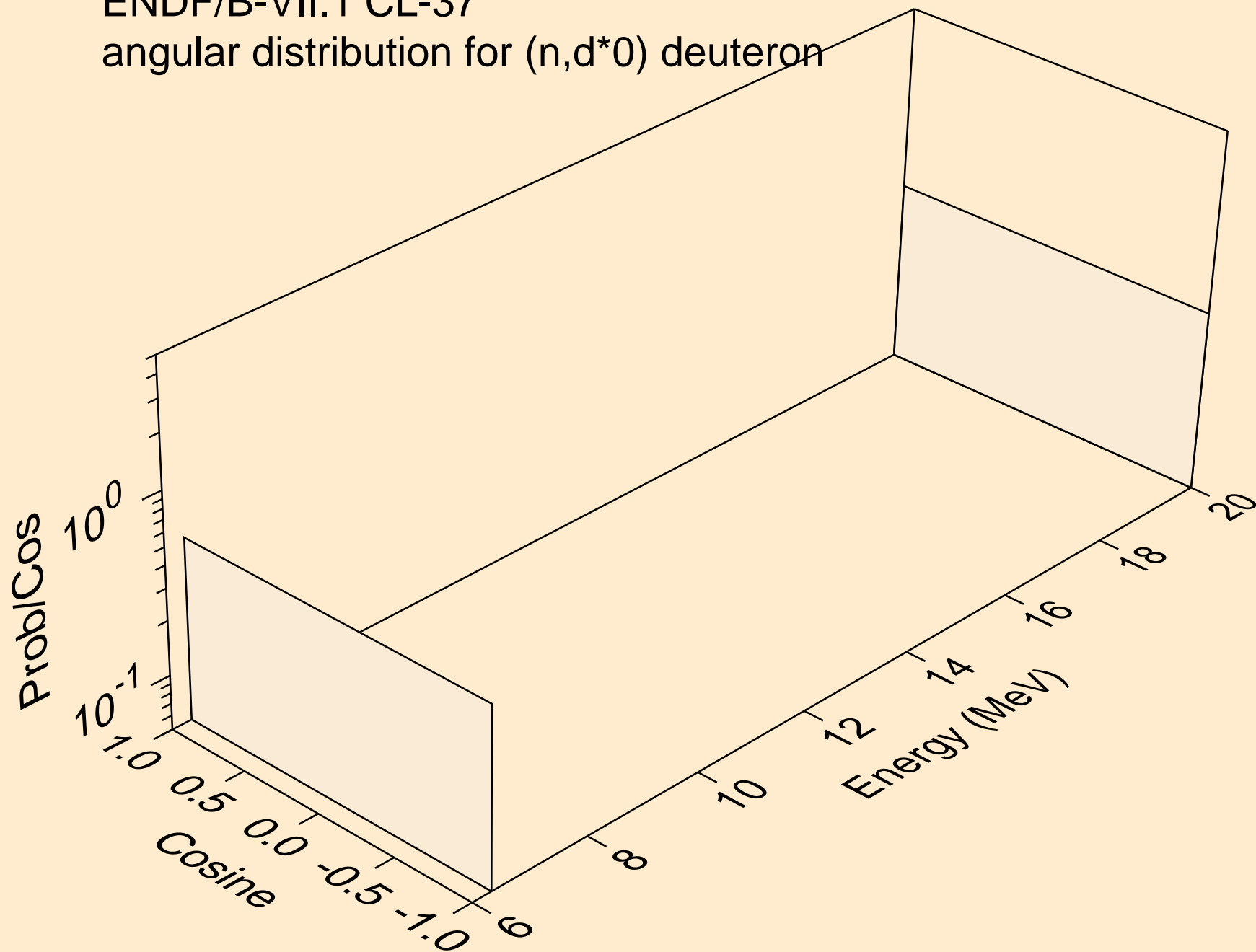

ENDF/B-VII.1 CL-37

angular distribution for (n,d*1) deuteron

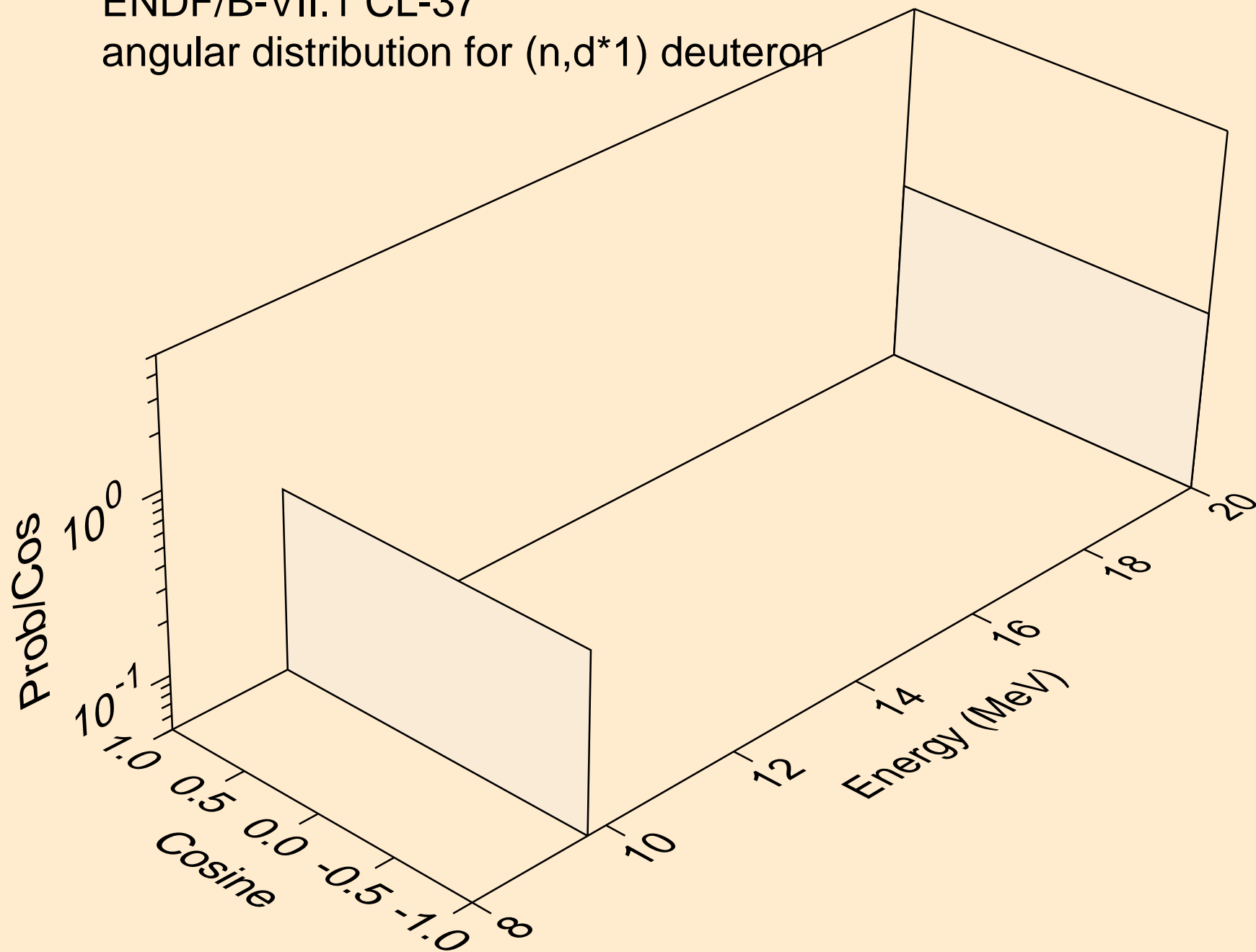

ENDF/B-VII.1 CL-37

angular distribution for (n,d*2) deuteron

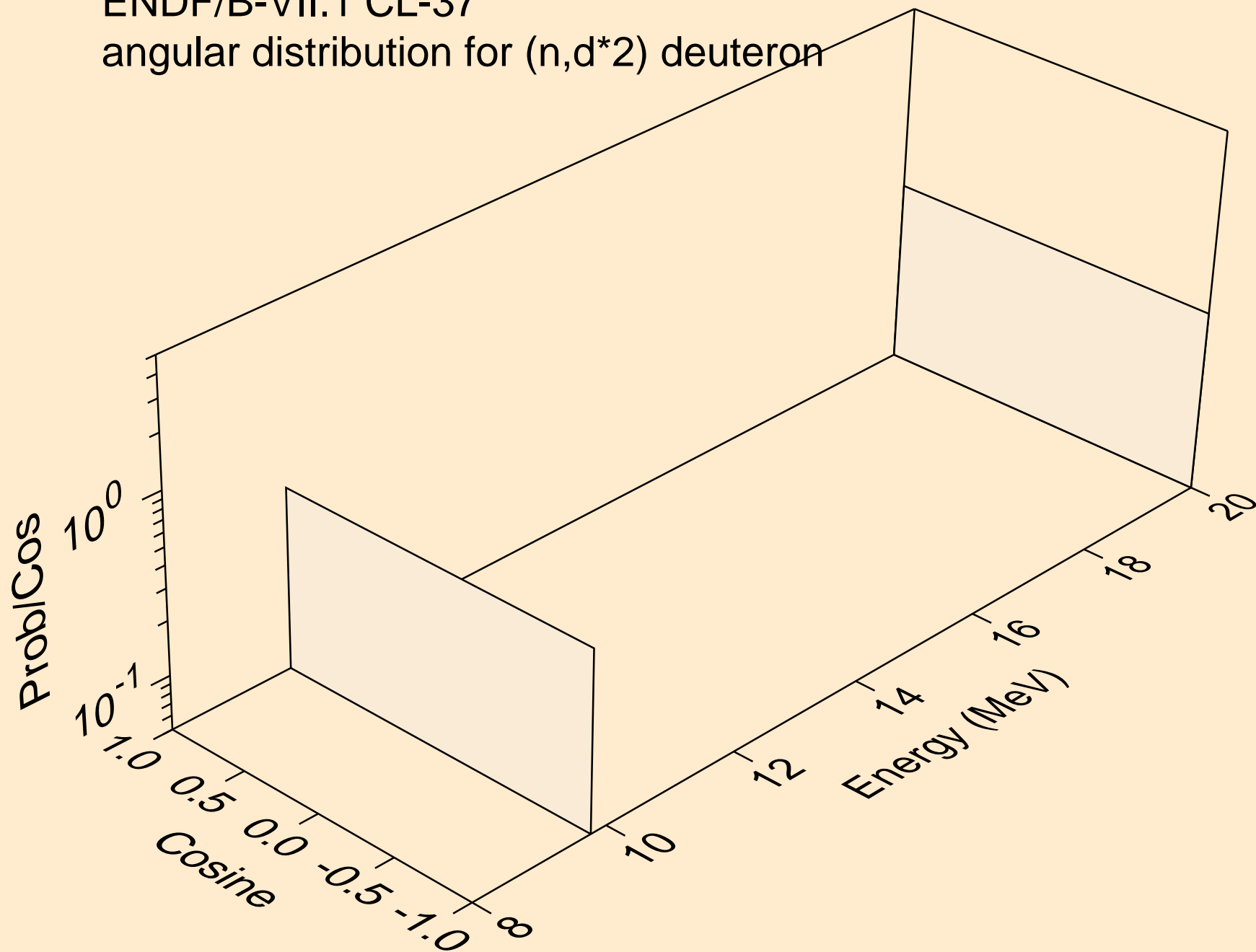

ENDF/B-VII.1 CL-37

angular distribution for (n,d*3) deuteron

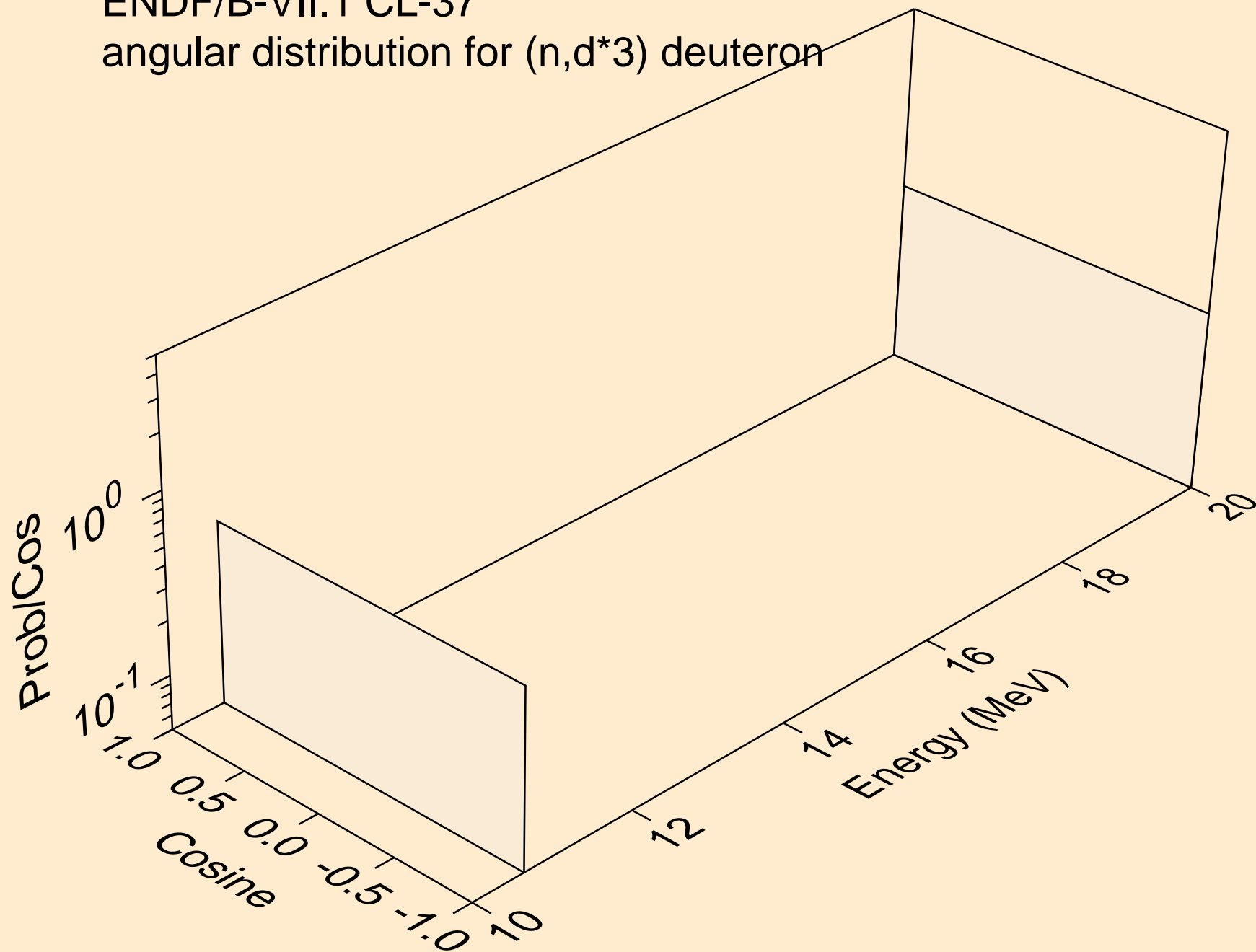

ENDF/B-VII.1 CL-37

angular distribution for (n,d*4) deuteron

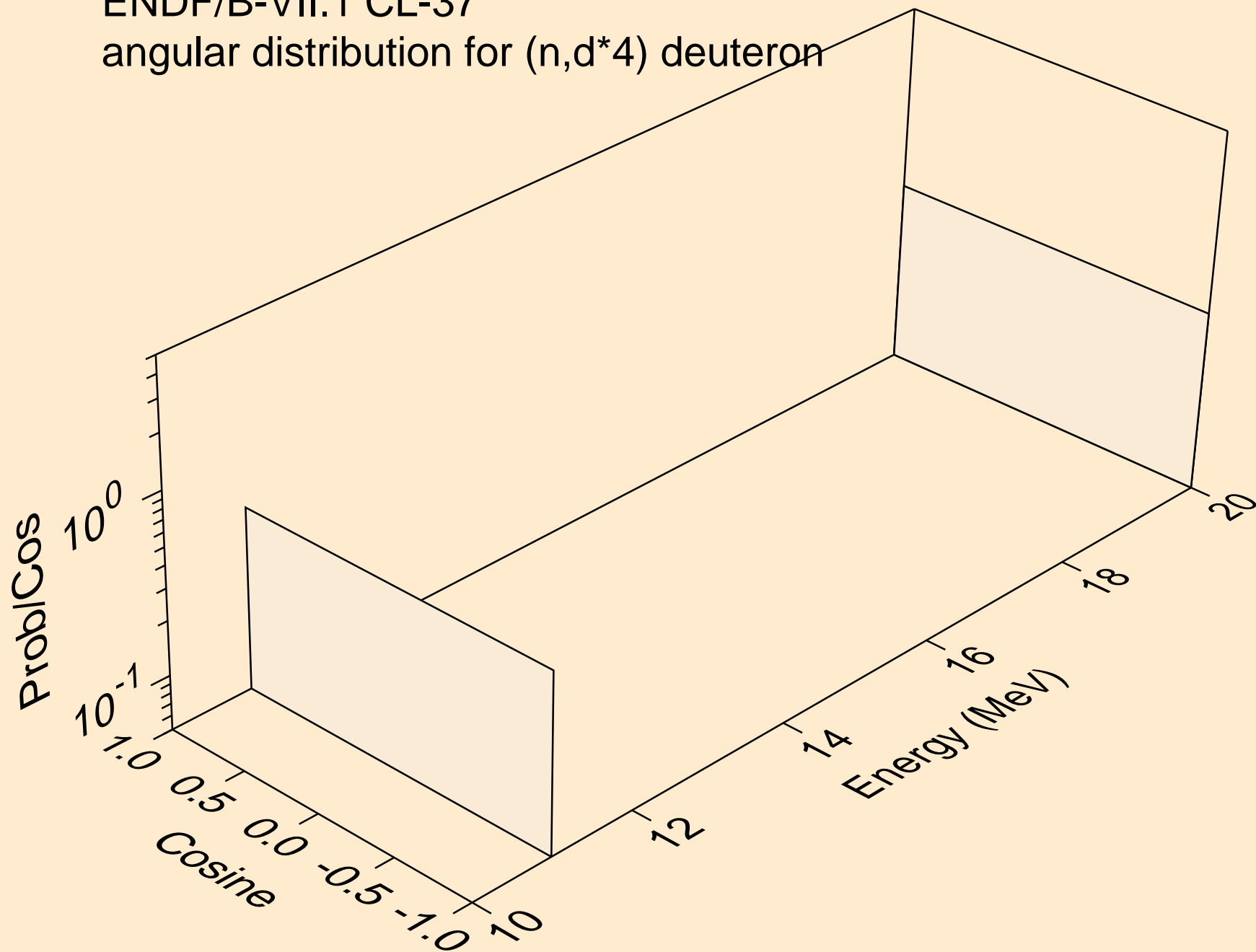

ENDF/B-VII.1 CL-37

angular distribution for (n,d*5) deuteron

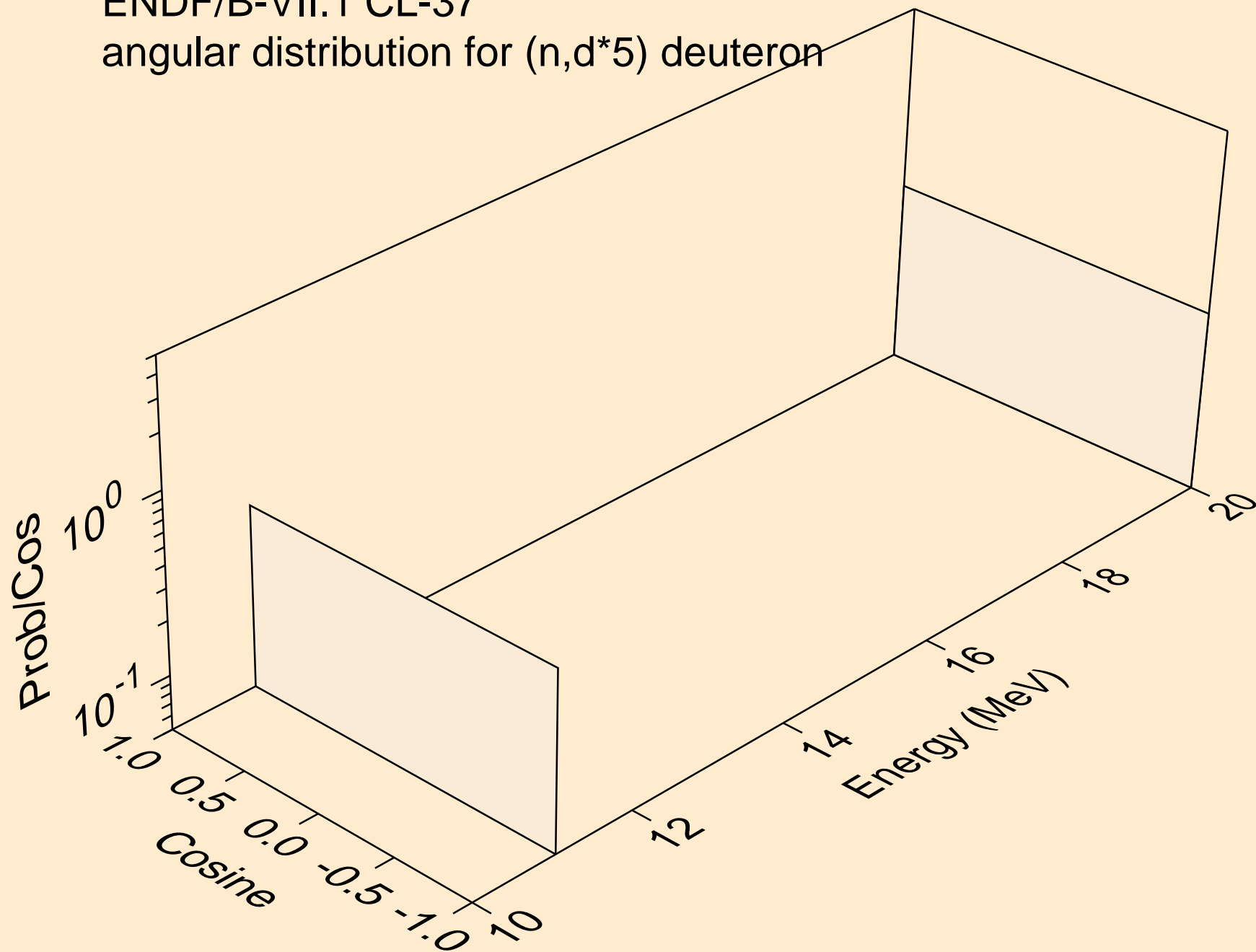

ENDF/B-VII.1 CL-37

angular distribution for (n,d*6) deuteron

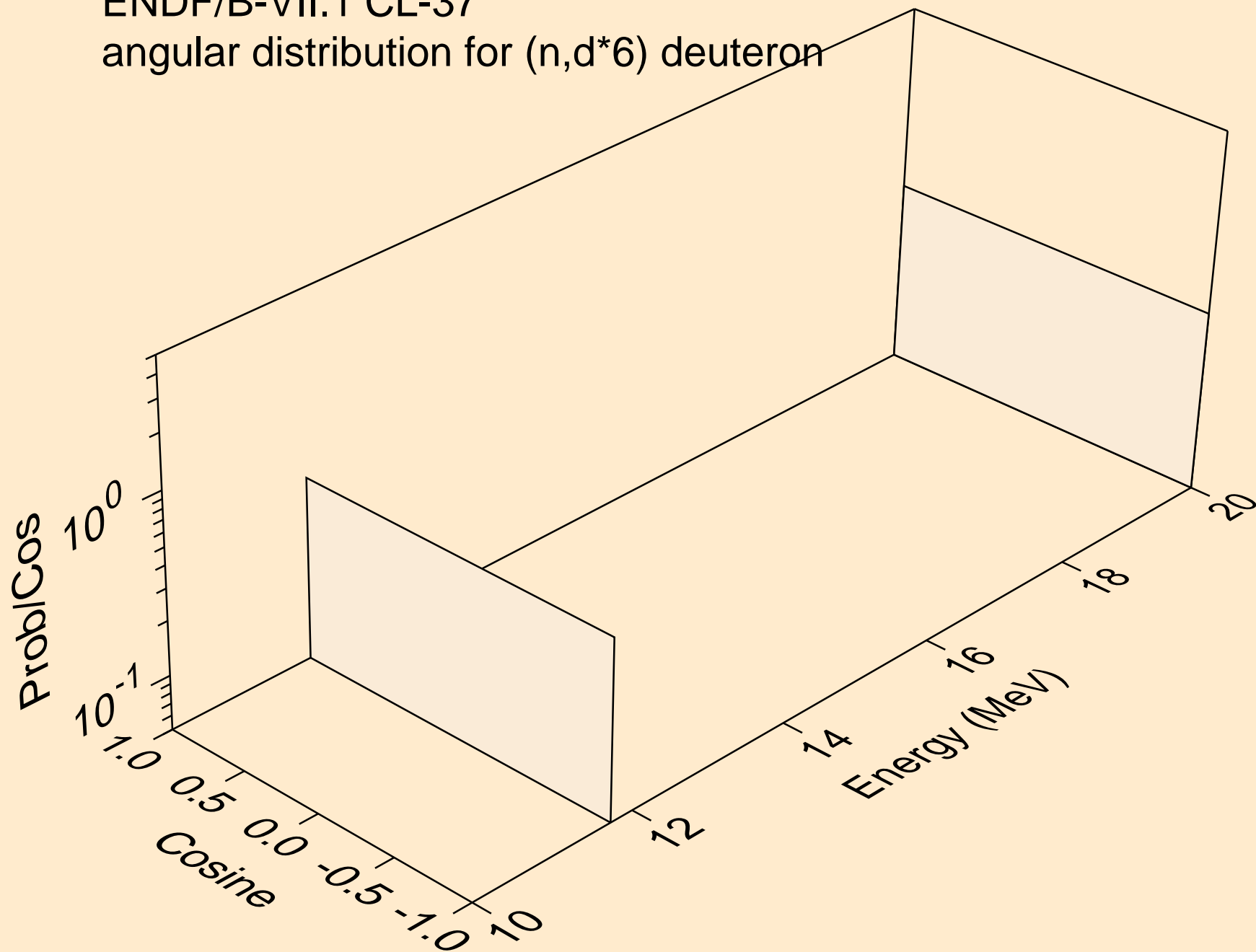

ENDF/B-VII.1 CL-37

angular distribution for (n,d*7) deuteron

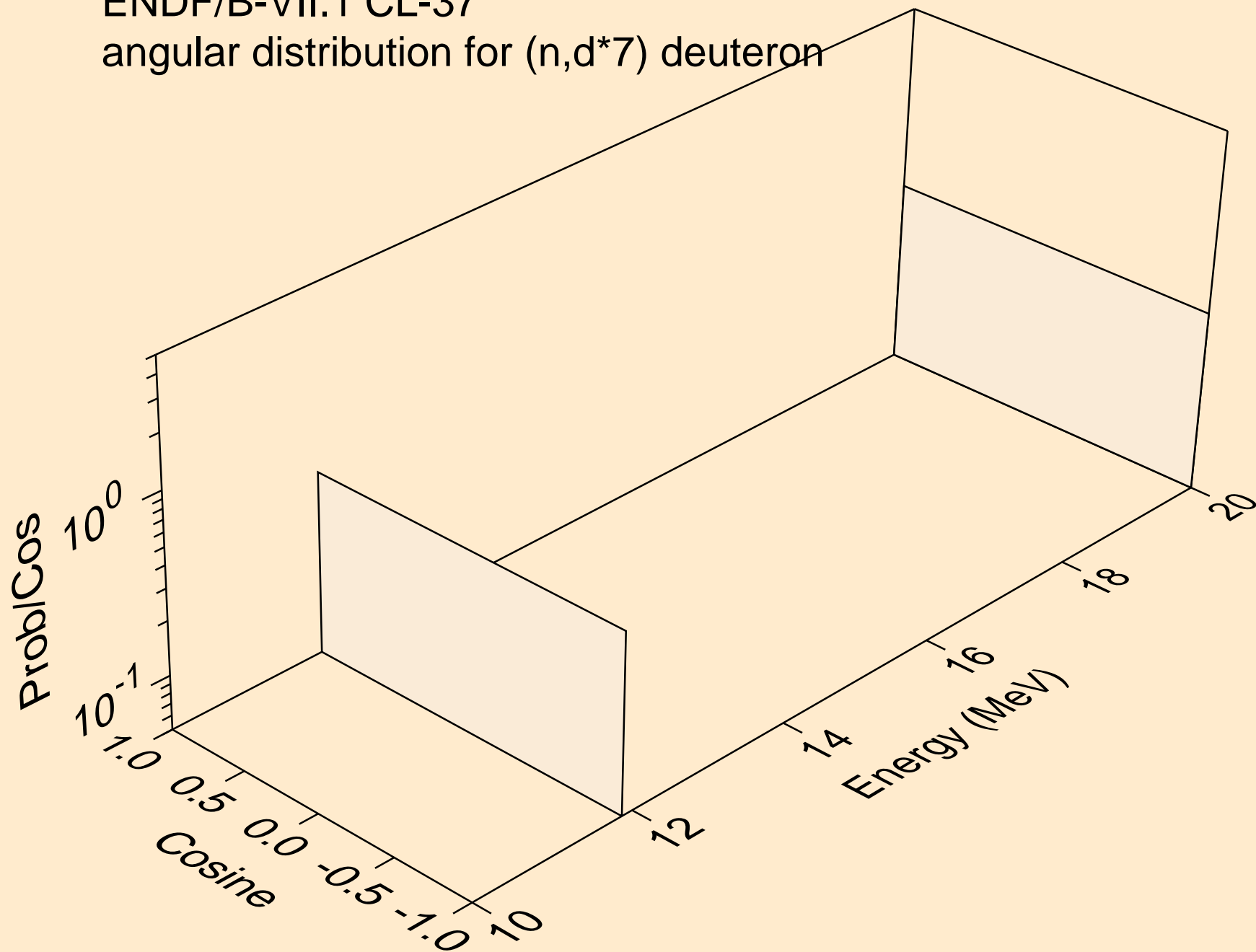

ENDF/B-VII.1 CL-37

angular distribution for (n,d*8) deuteron

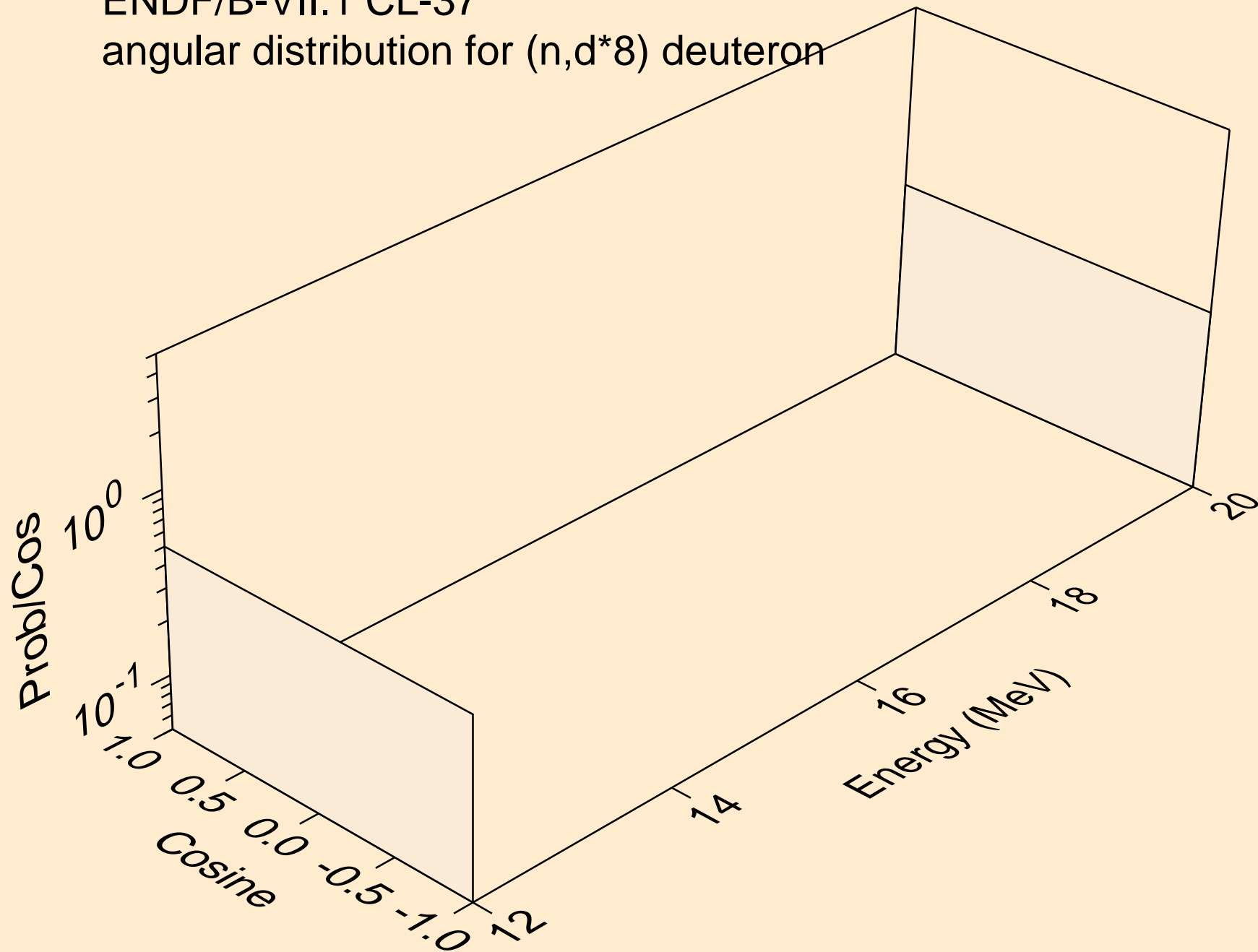

ENDF/B-VII.1 CL-37

angular distribution for (n,d*9) deuteron

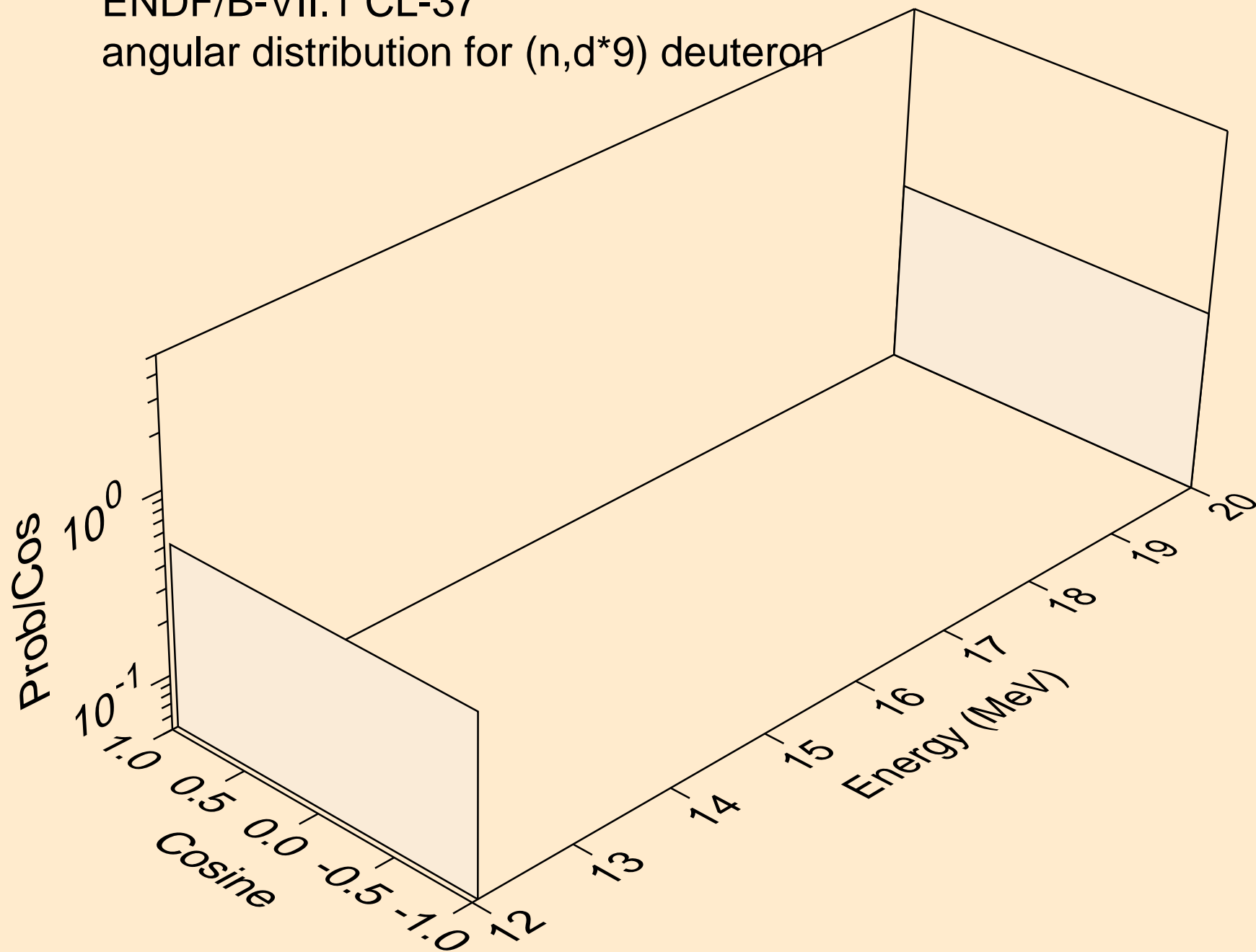

ENDF/B-VII.1 CL-37

angular distribution for (n,d*10) deuteron

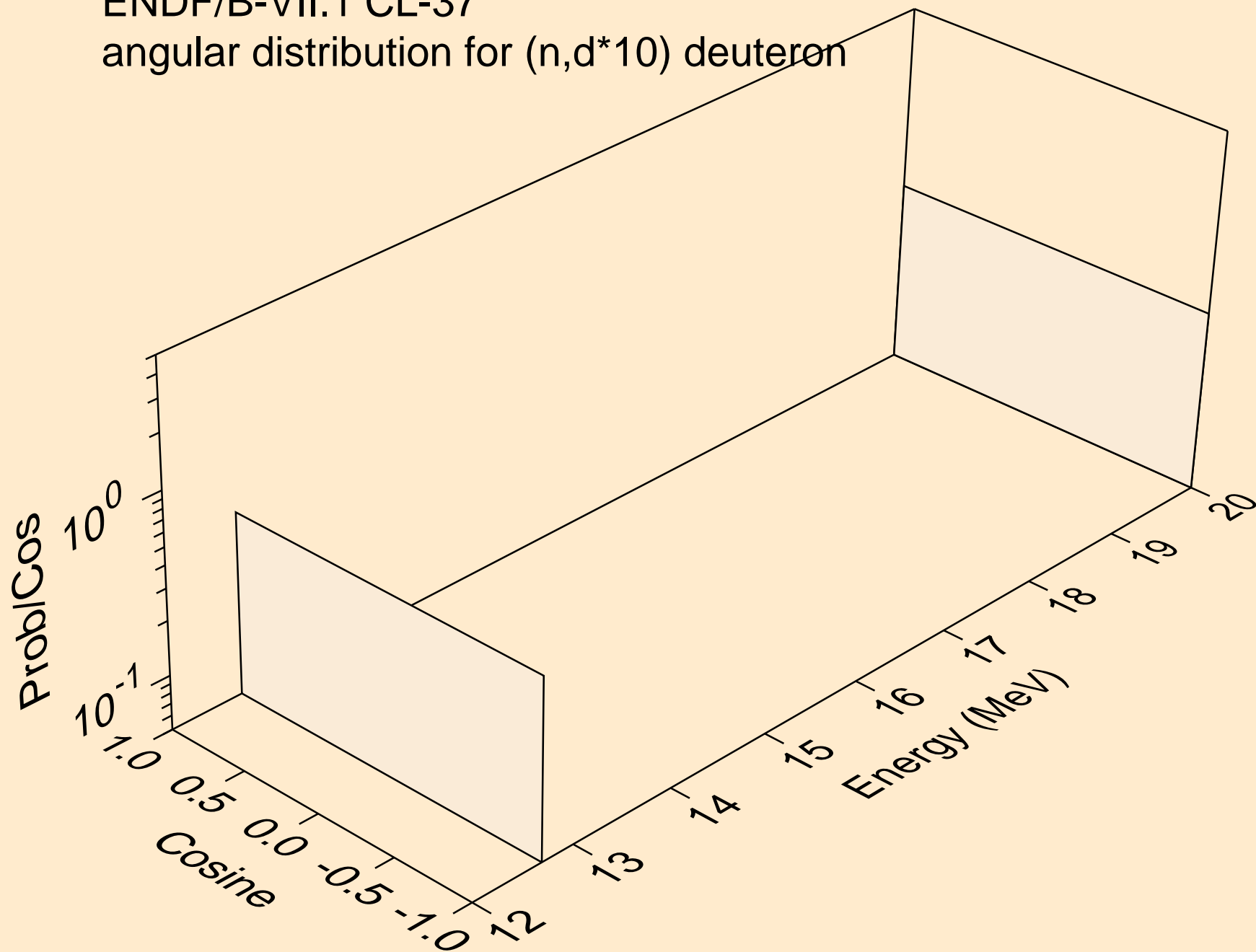

ENDF/B-VII.1 CL-37

angular distribution for (n,d*11) deuteron

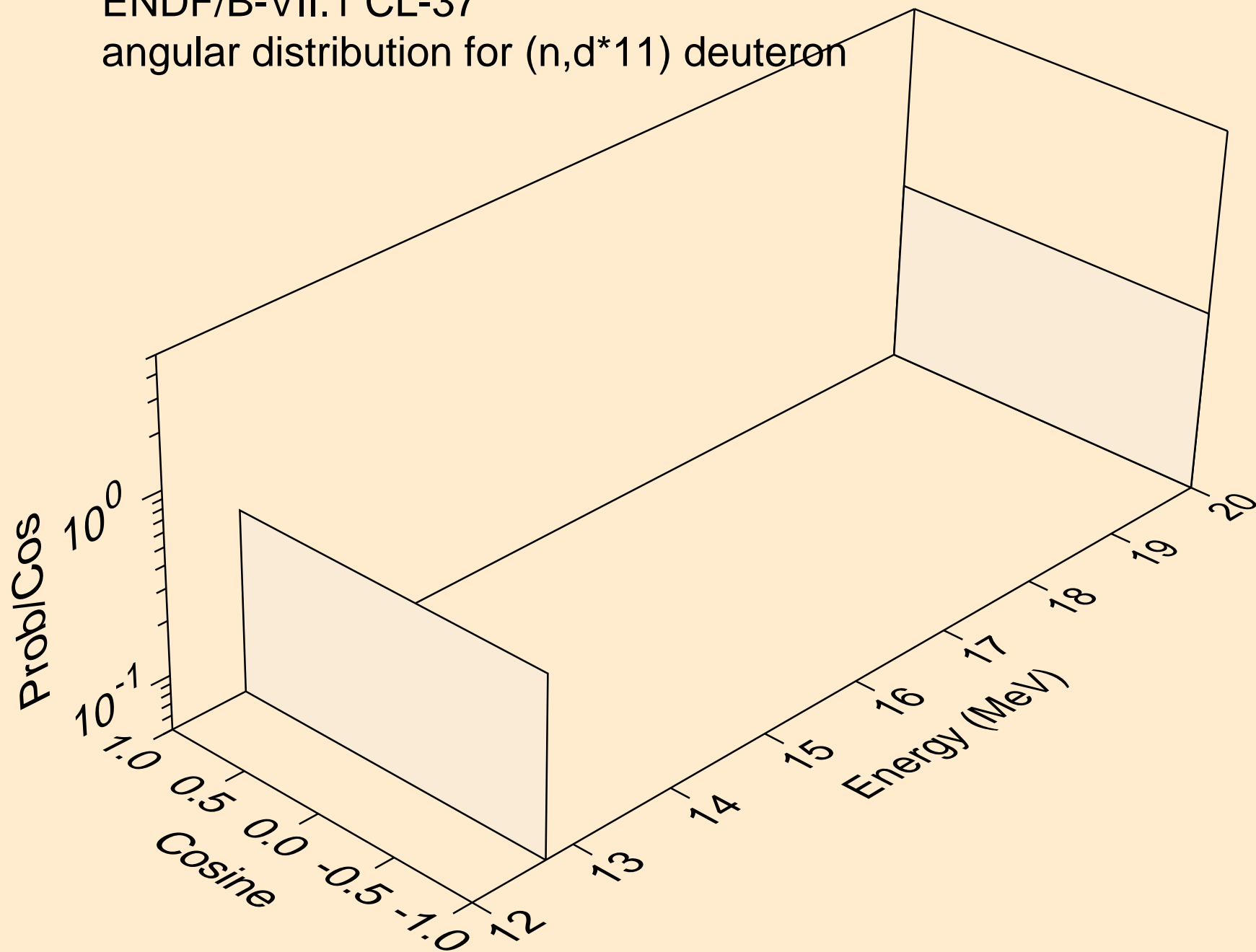

ENDF/B-VII.1 CL-37
deuterons from (n,d*c)

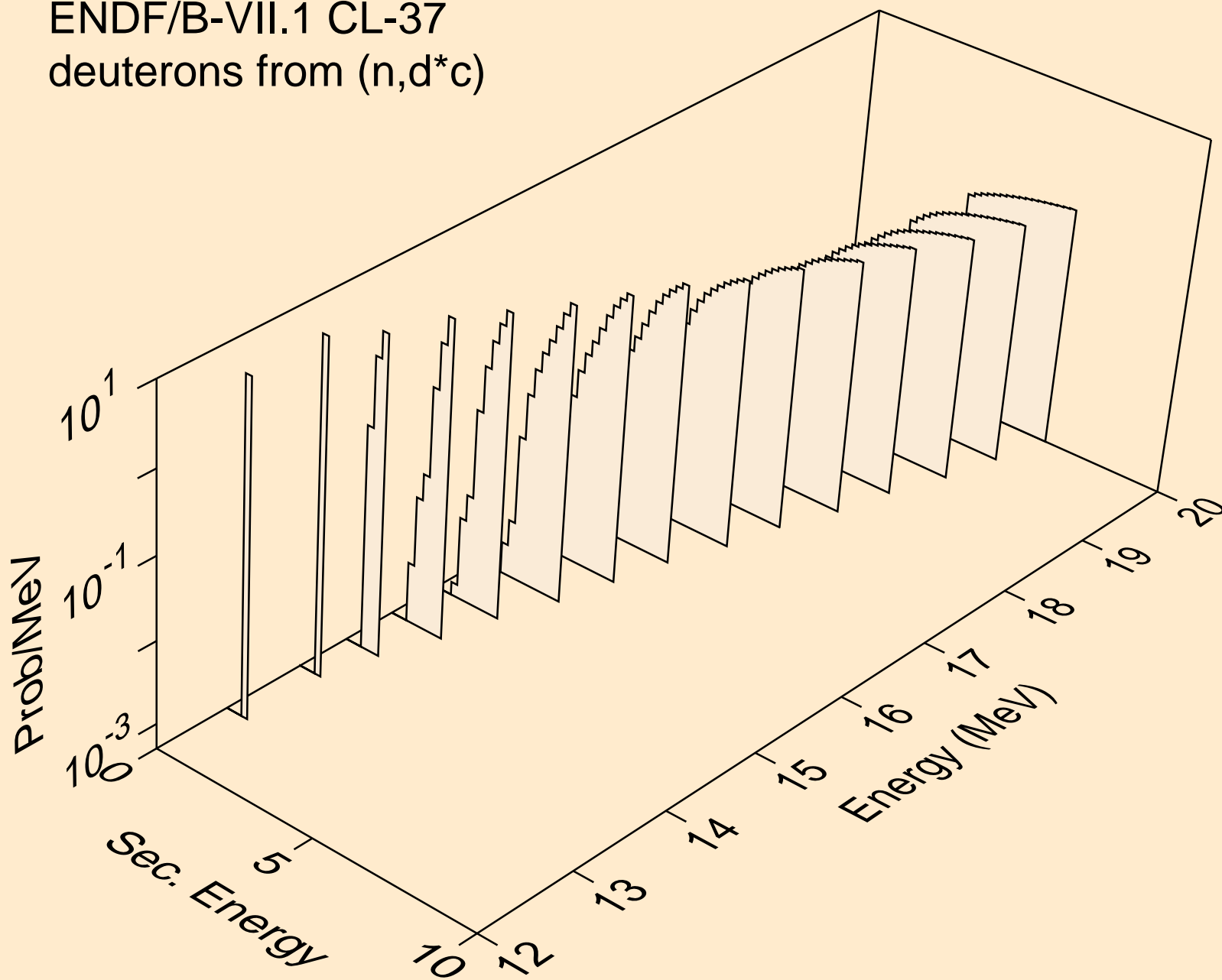

ENDF/B-VII.1 CL-37
angular distribution for (n,t*0) triton

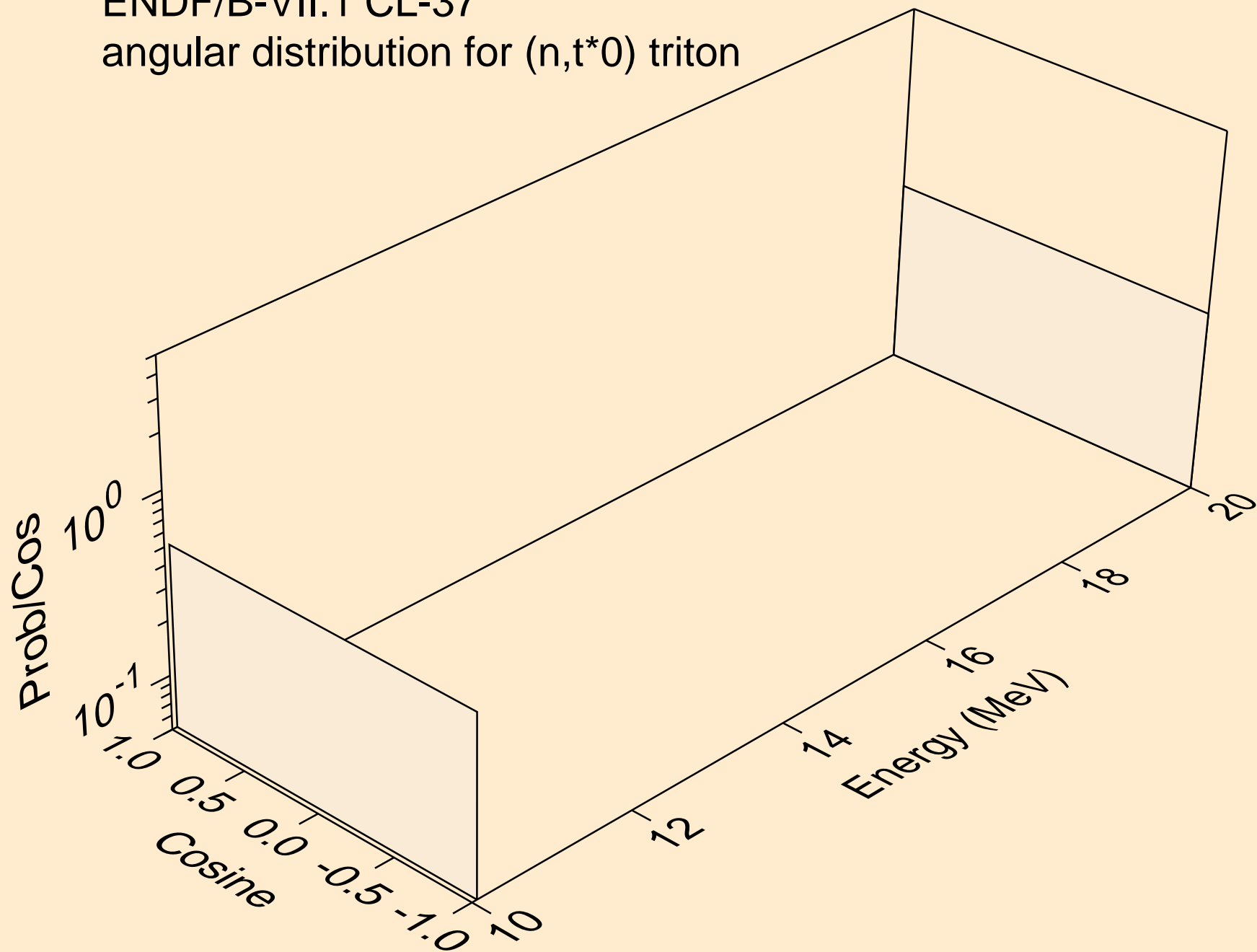

ENDF/B-VII.1 CL-37
angular distribution for (n,t*1) triton

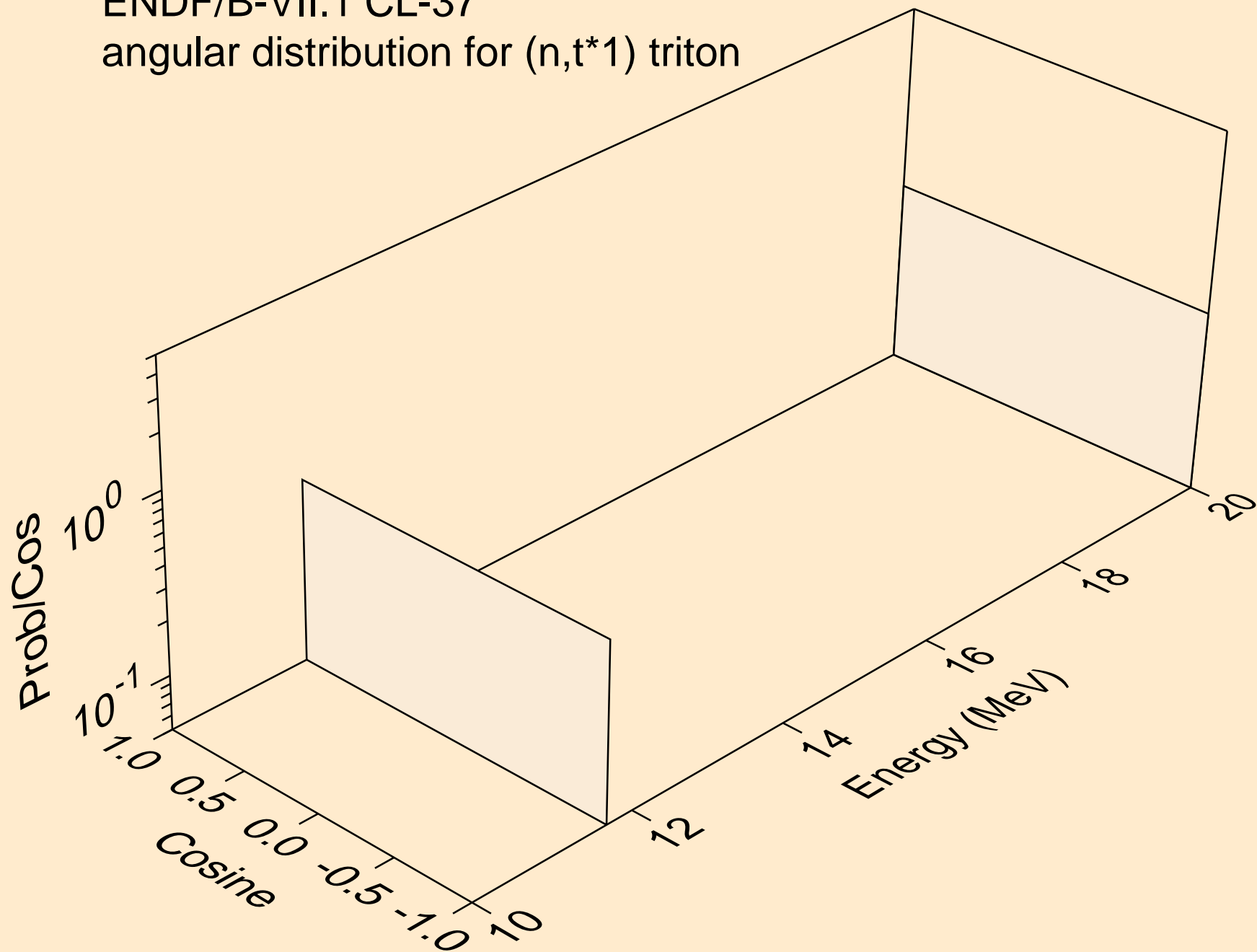

ENDF/B-VII.1 CL-37
angular distribution for (n,t*2) triton

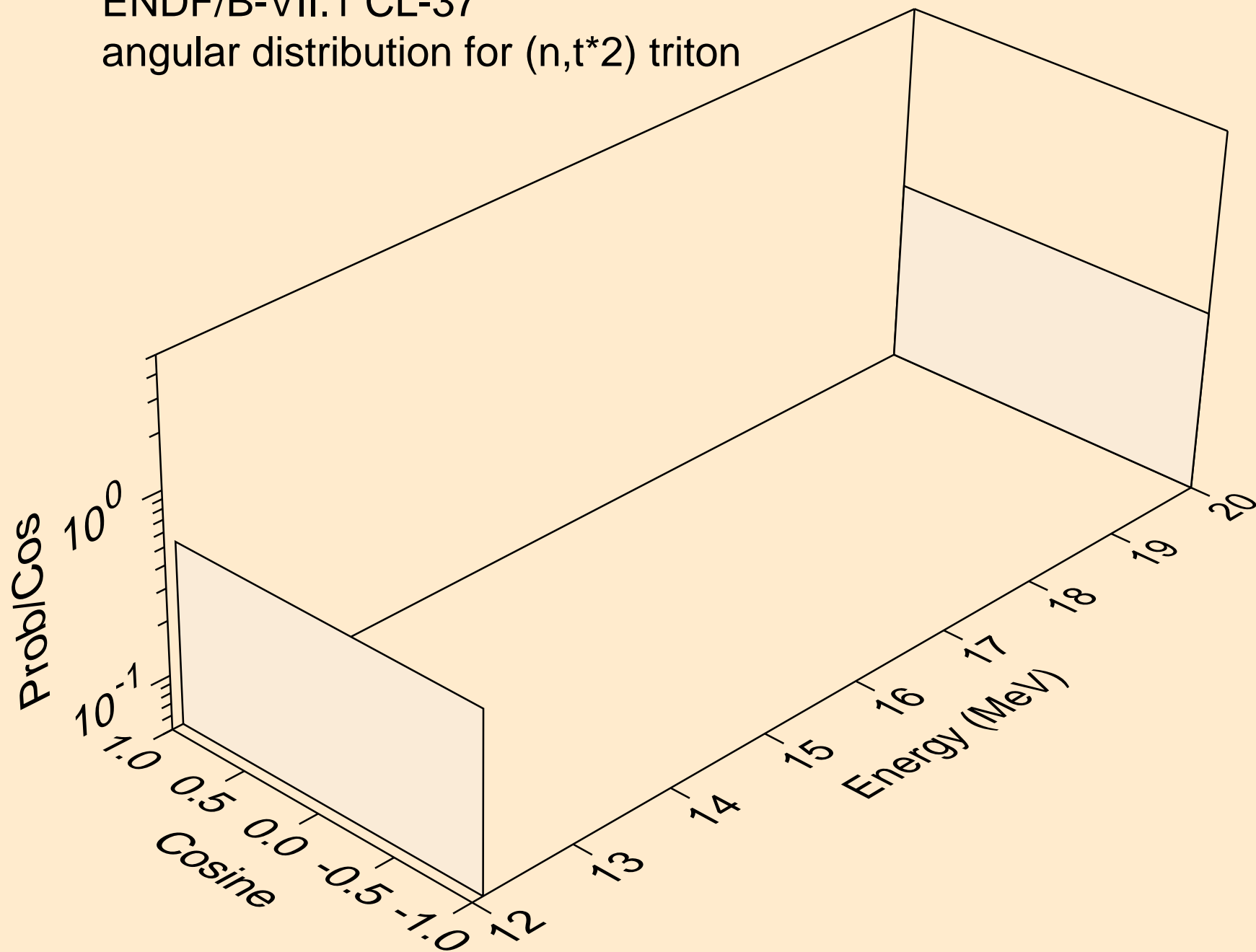

ENDF/B-VII.1 CL-37
angular distribution for (n,t*3) triton

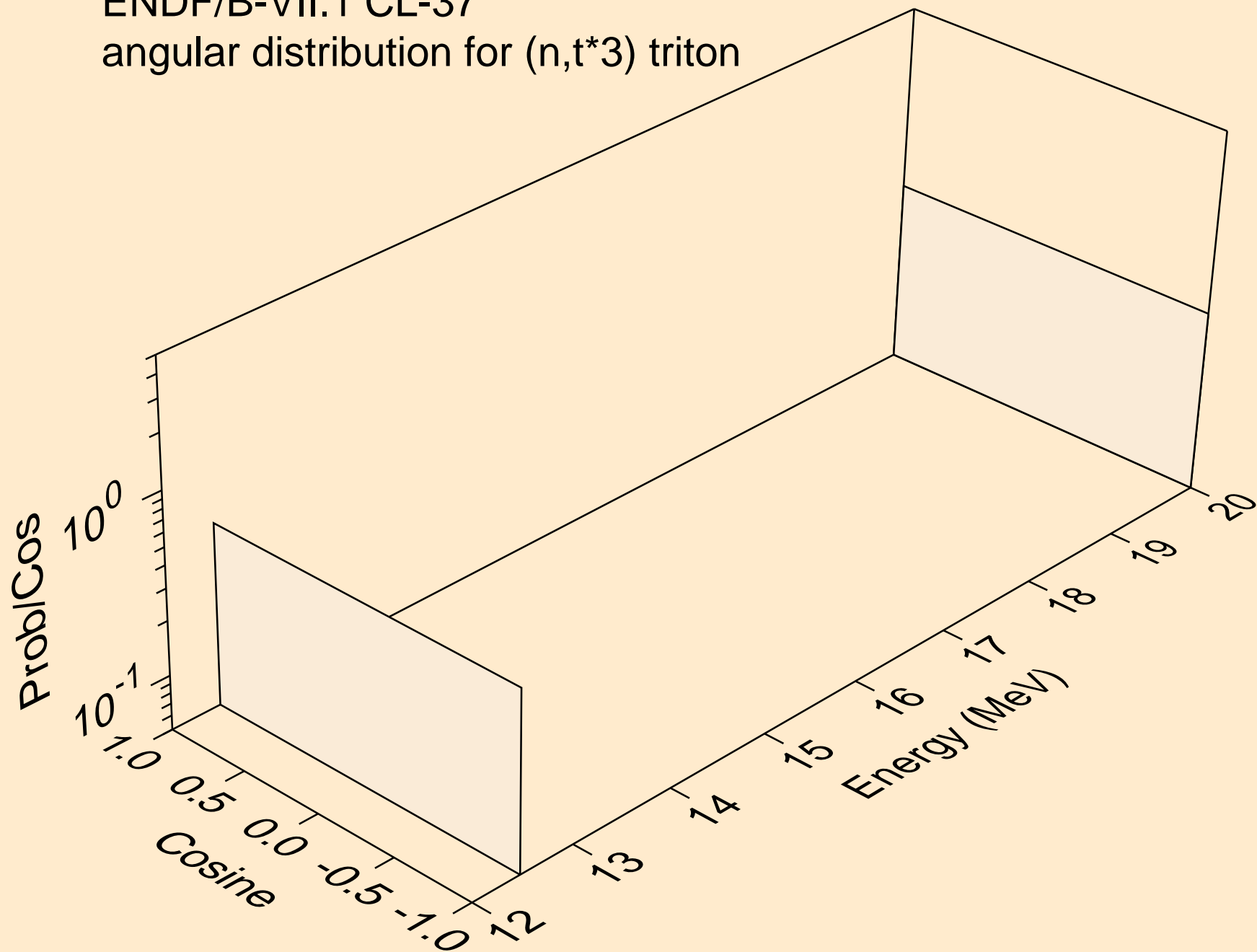

ENDF/B-VII.1 CL-37
angular distribution for (n,t*4) triton

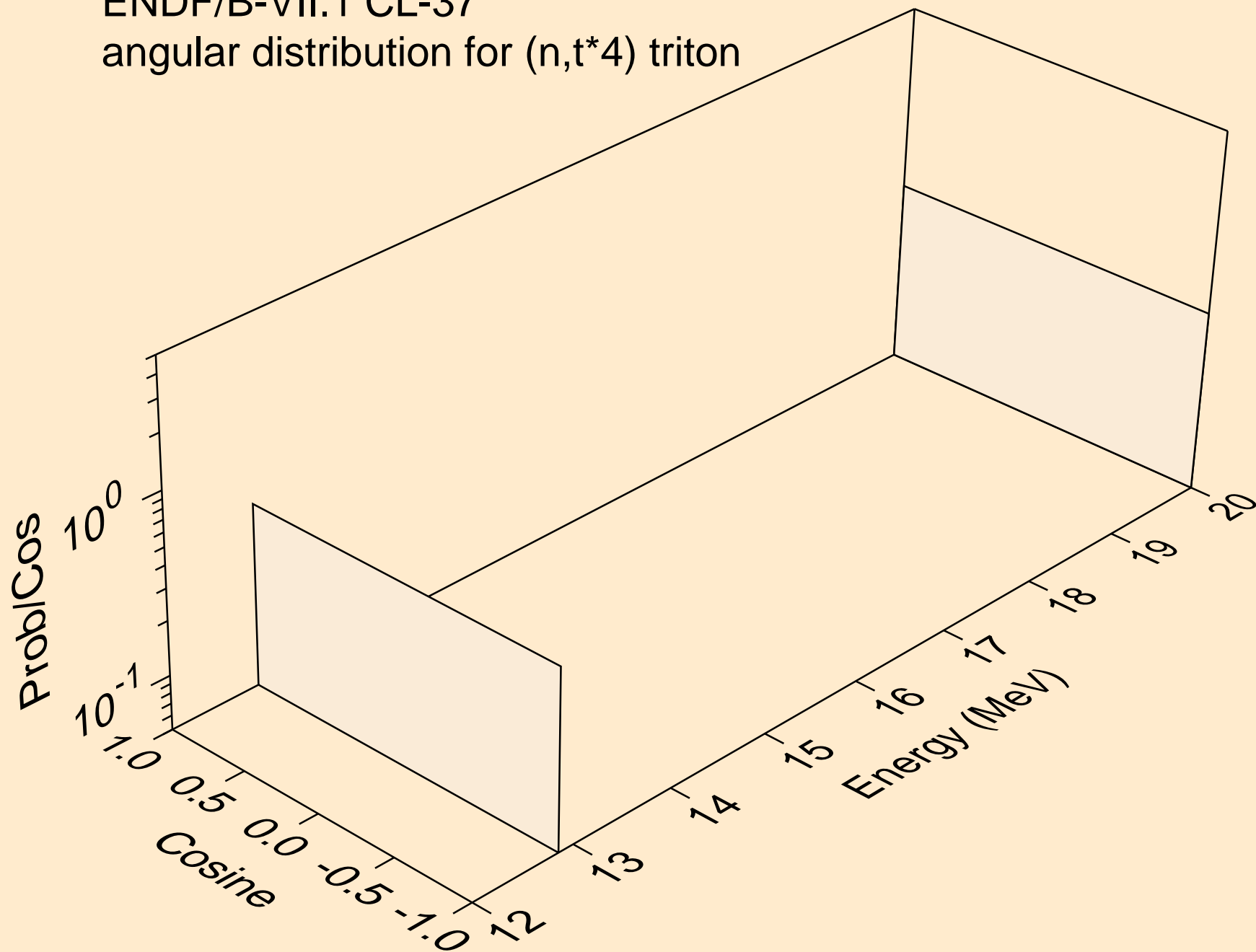

ENDF/B-VII.1 CL-37
angular distribution for (n,t*5) triton

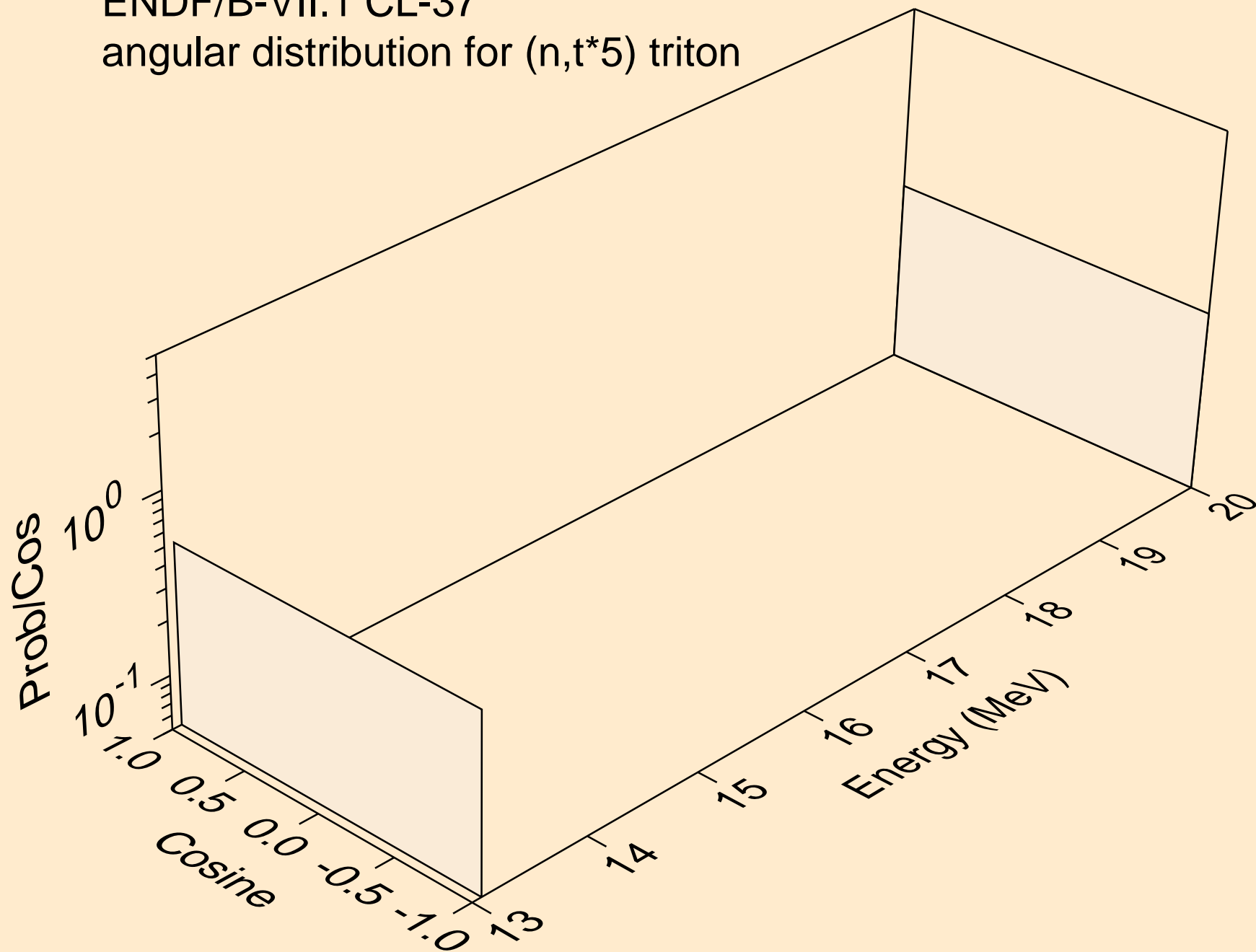

ENDF/B-VII.1 CL-37
angular distribution for (n,t*6) triton

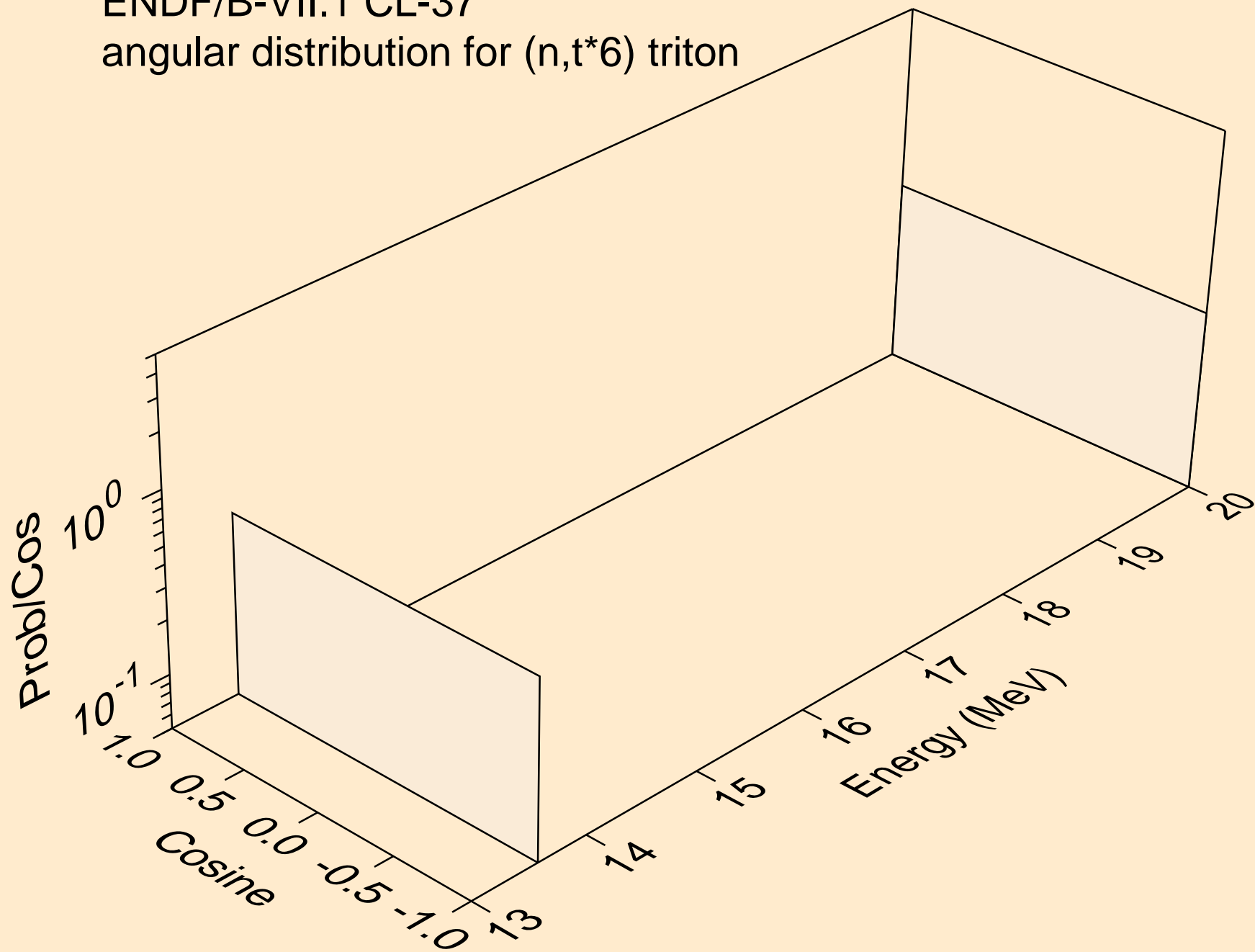

ENDF/B-VII.1 CL-37
angular distribution for (n,t*7) triton

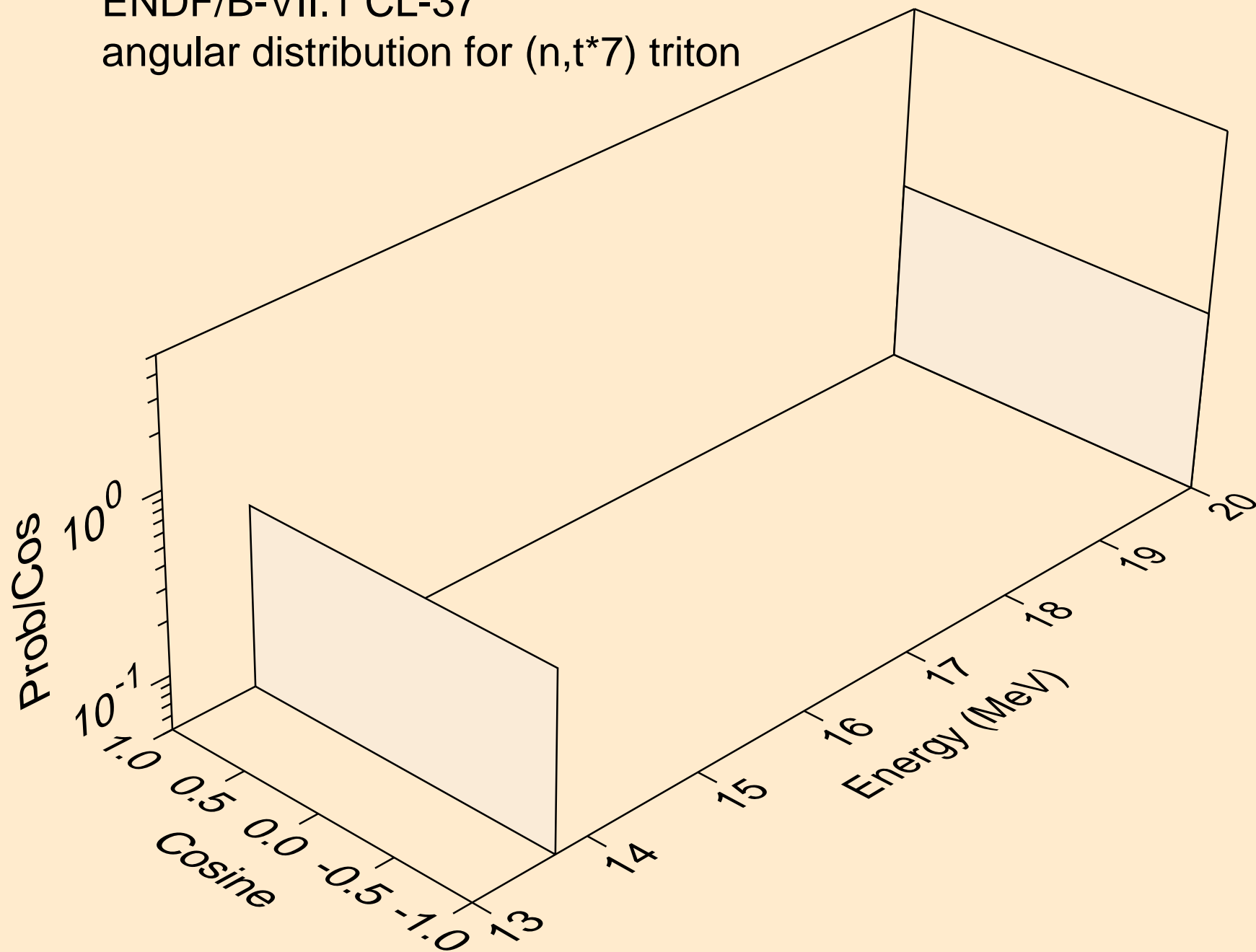

ENDF/B-VII.1 CL-37
angular distribution for (n,t*8) triton

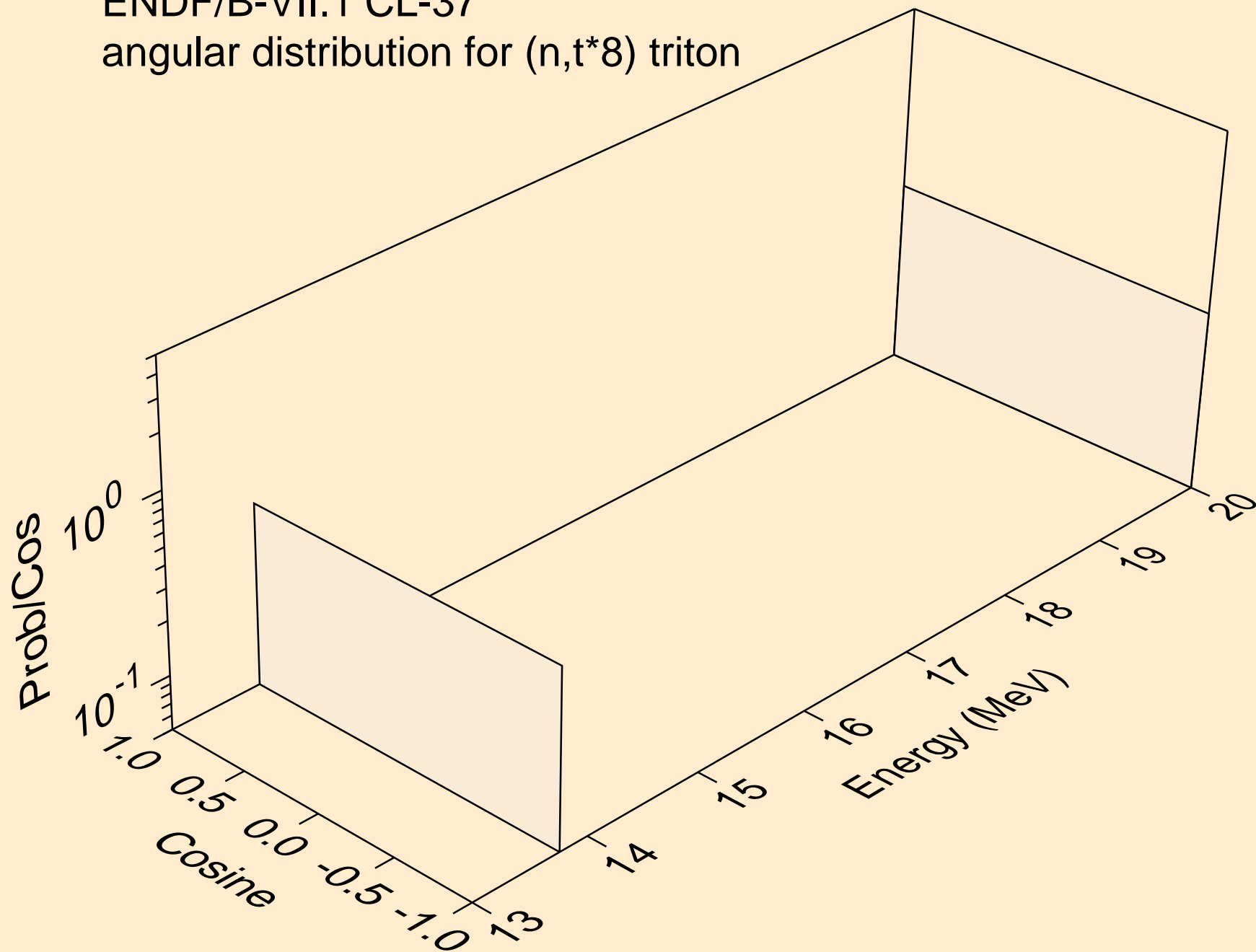

ENDF/B-VII.1 CL-37
angular distribution for (n,t*9) triton

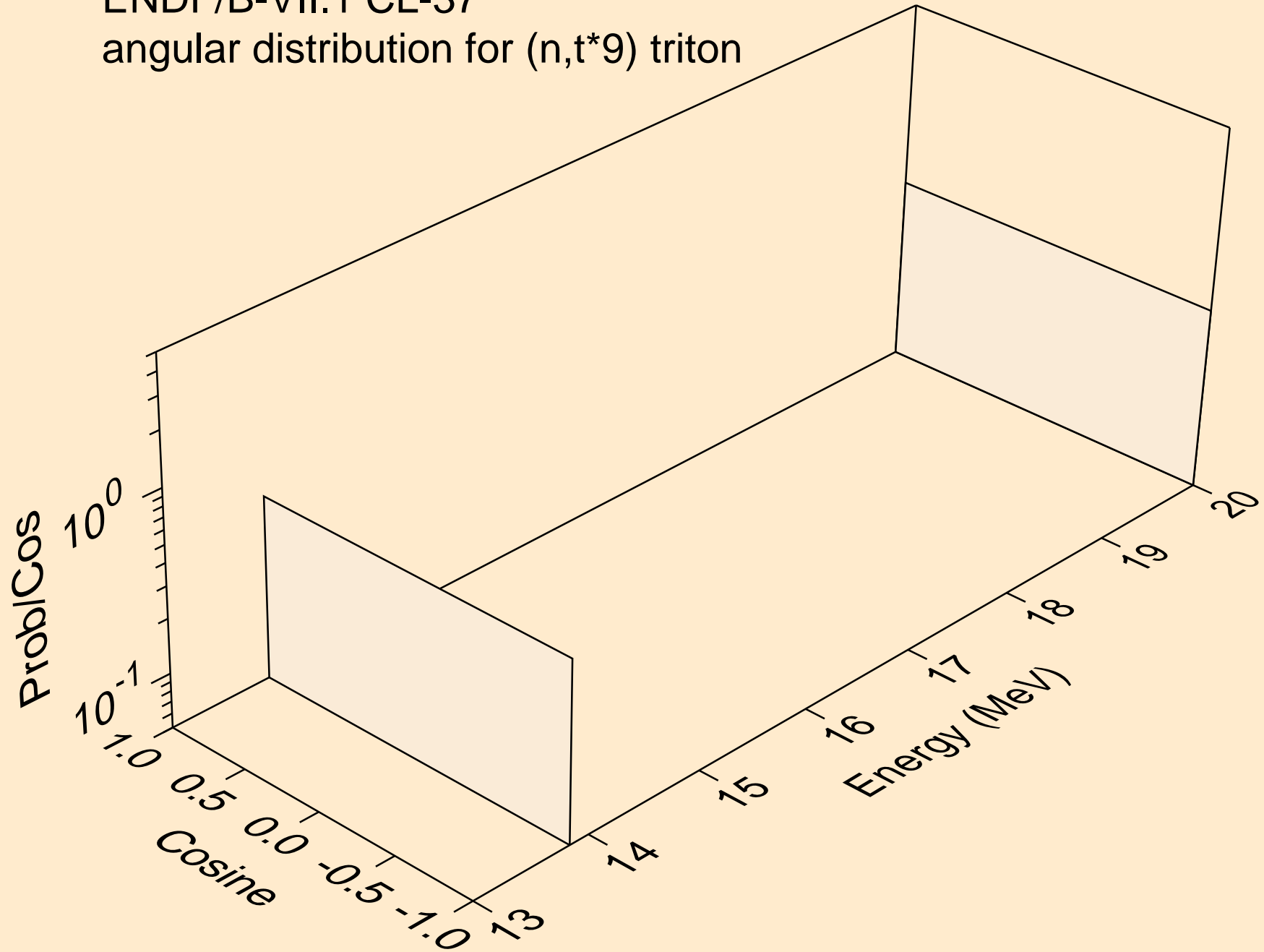

ENDF/B-VII.1 CL-37
angular distribution for (n,t*10) triton

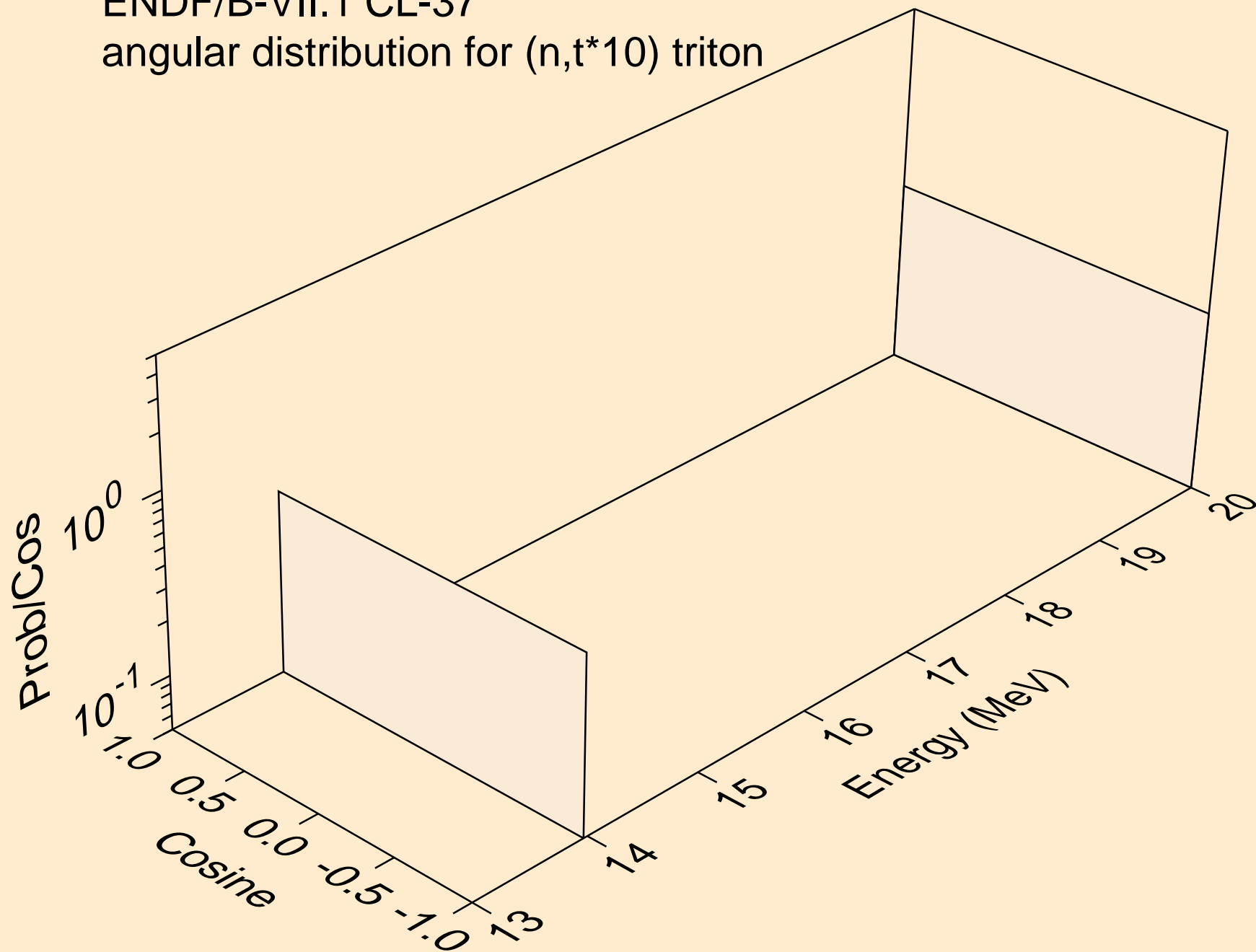

ENDF/B-VII.1 CL-37
angular distribution for (n,t*11) triton

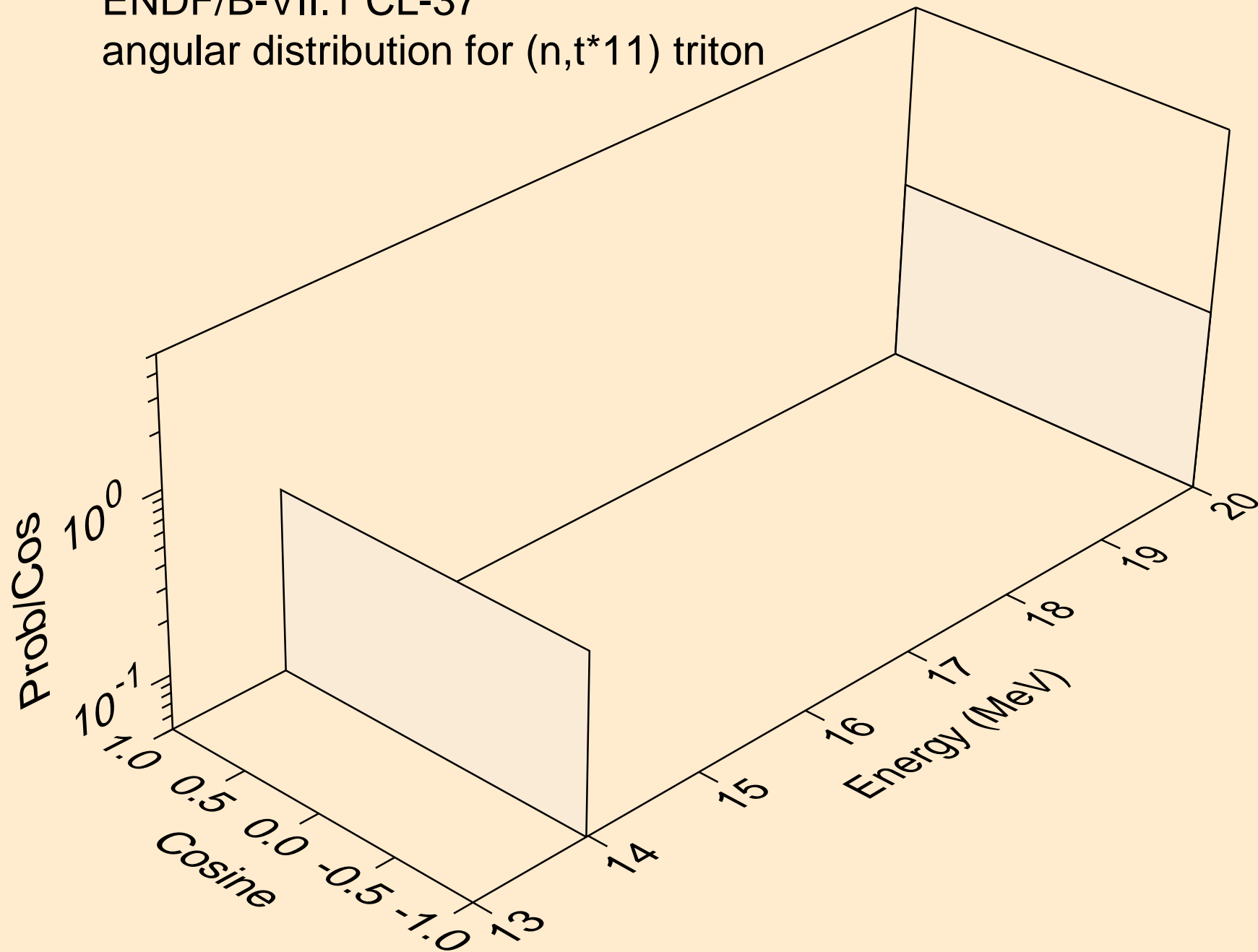

ENDF/B-VII.1 CL-37
angular distribution for (n,t*12) triton

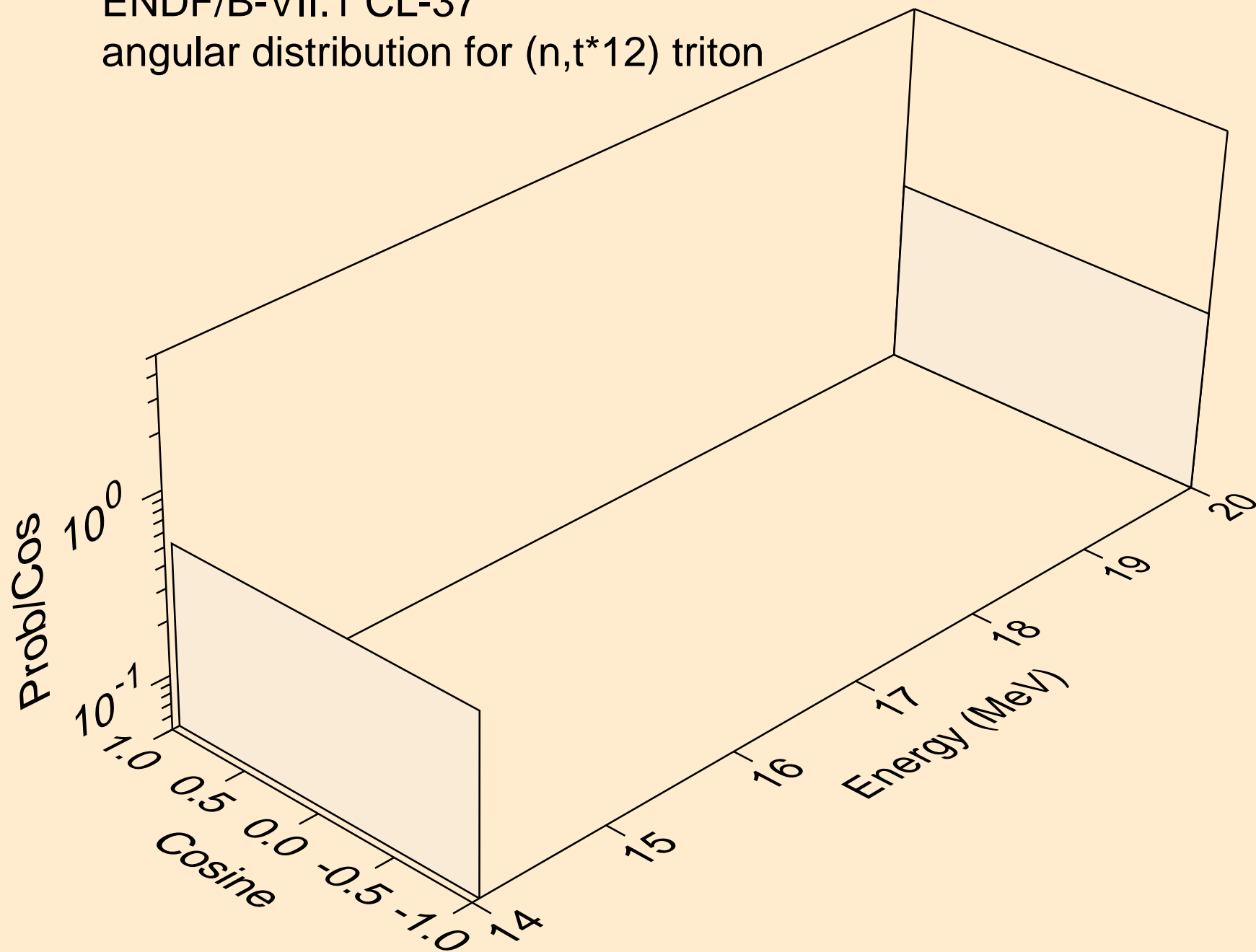

ENDF/B-VII.1 CL-37
angular distribution for (n,t*13) triton

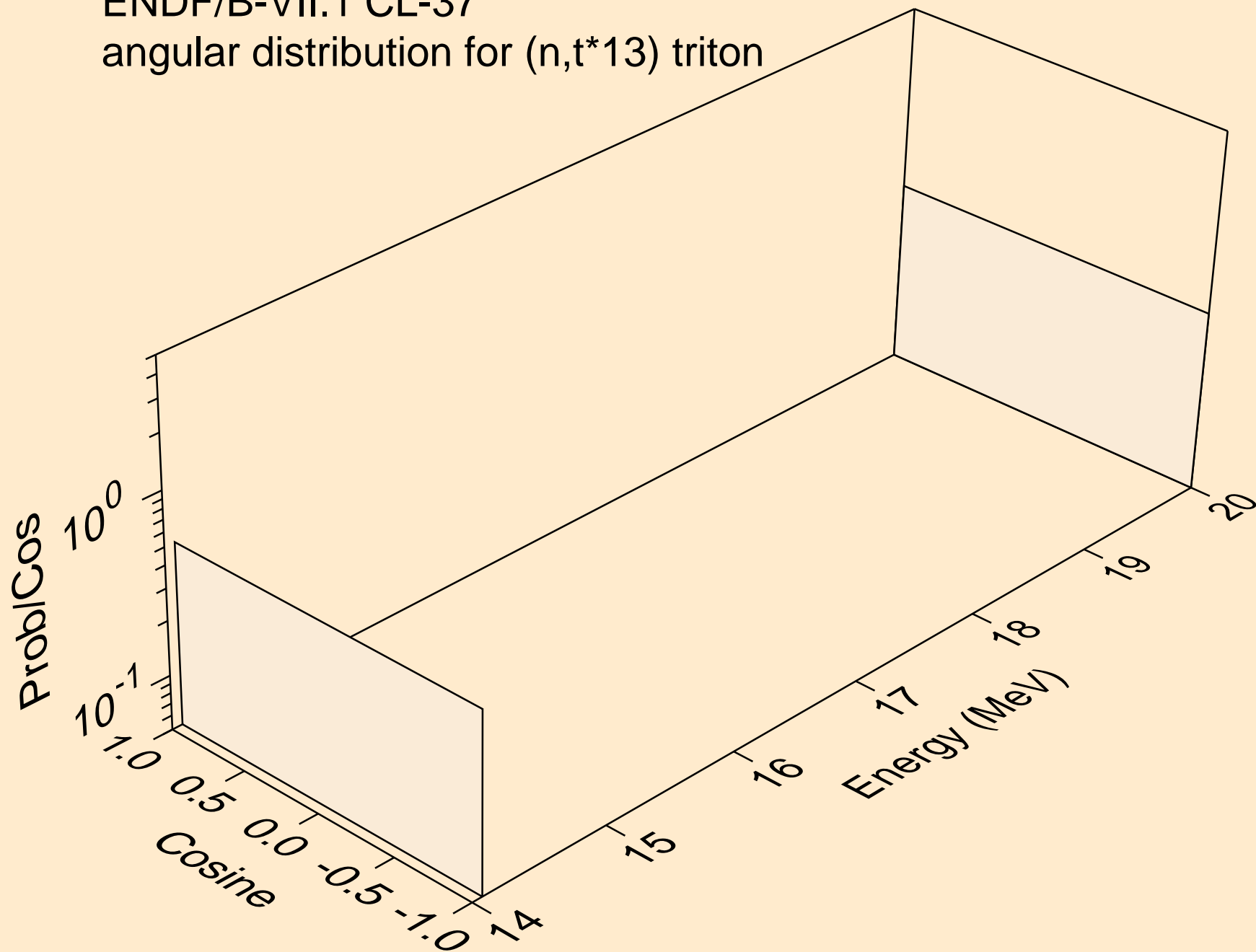

ENDF/B-VII.1 CL-37
angular distribution for (n,t*14) triton

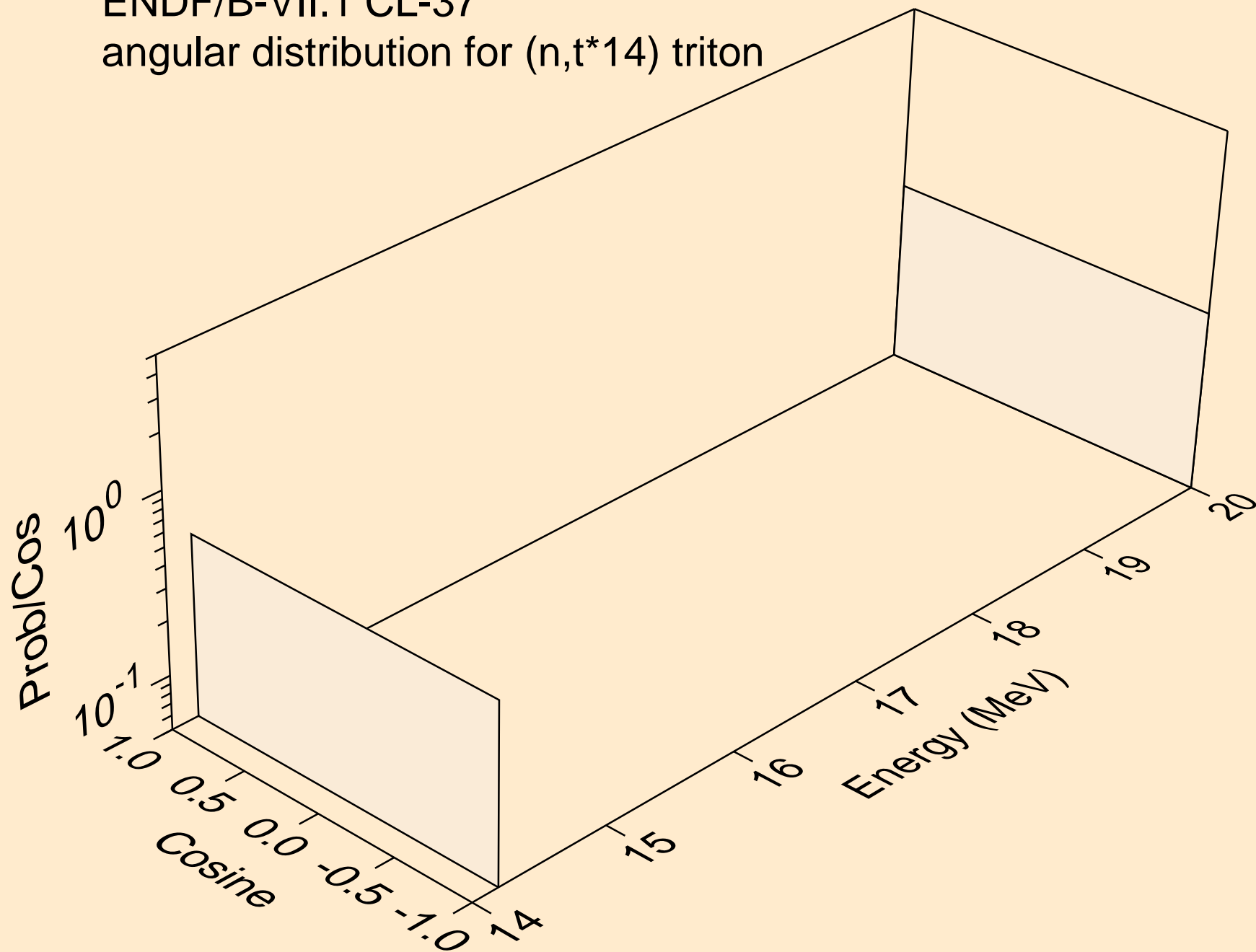

ENDF/B-VII.1 CL-37
angular distribution for (n,t*15) triton

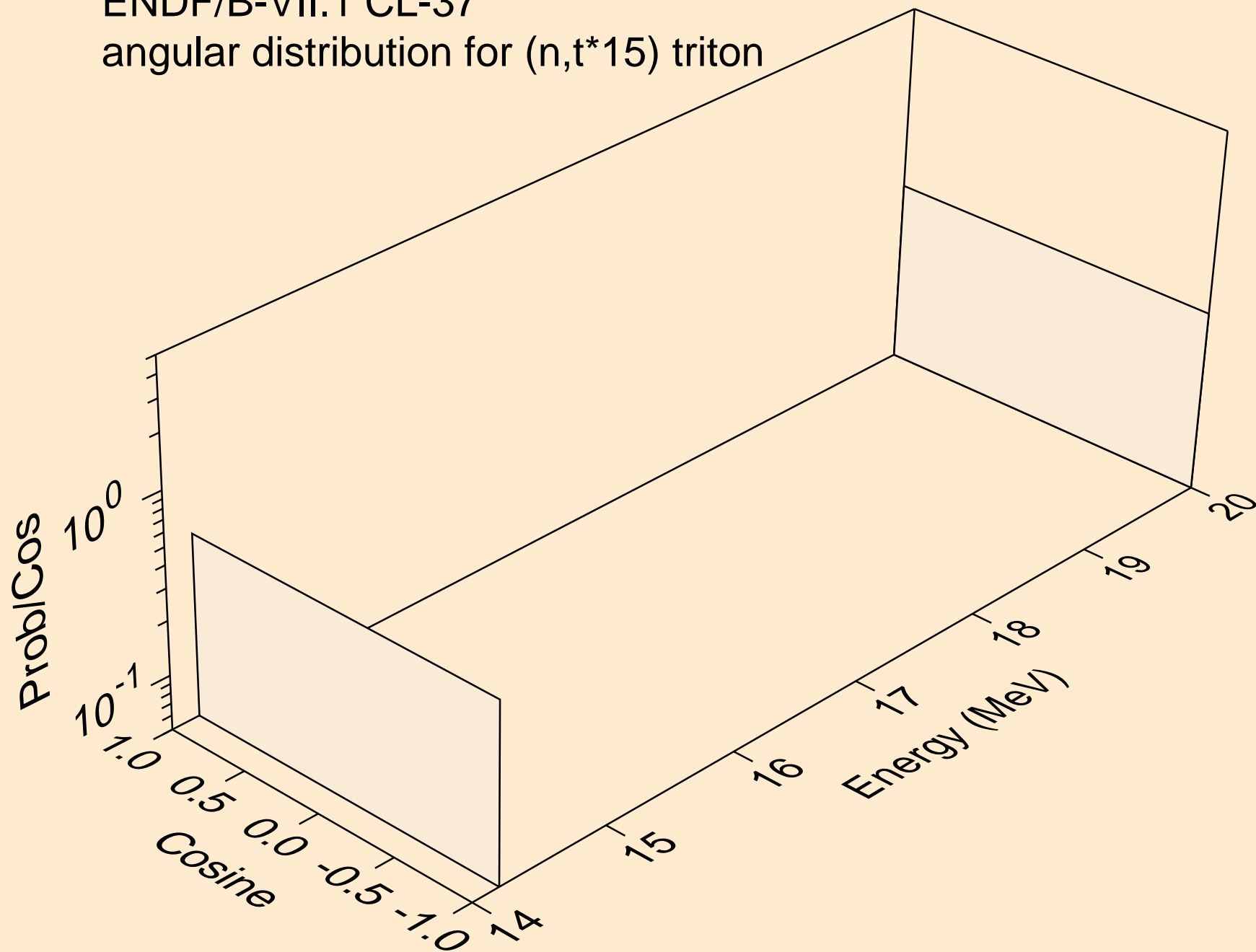

ENDF/B-VII.1 CL-37
tritons from (n,t*c)

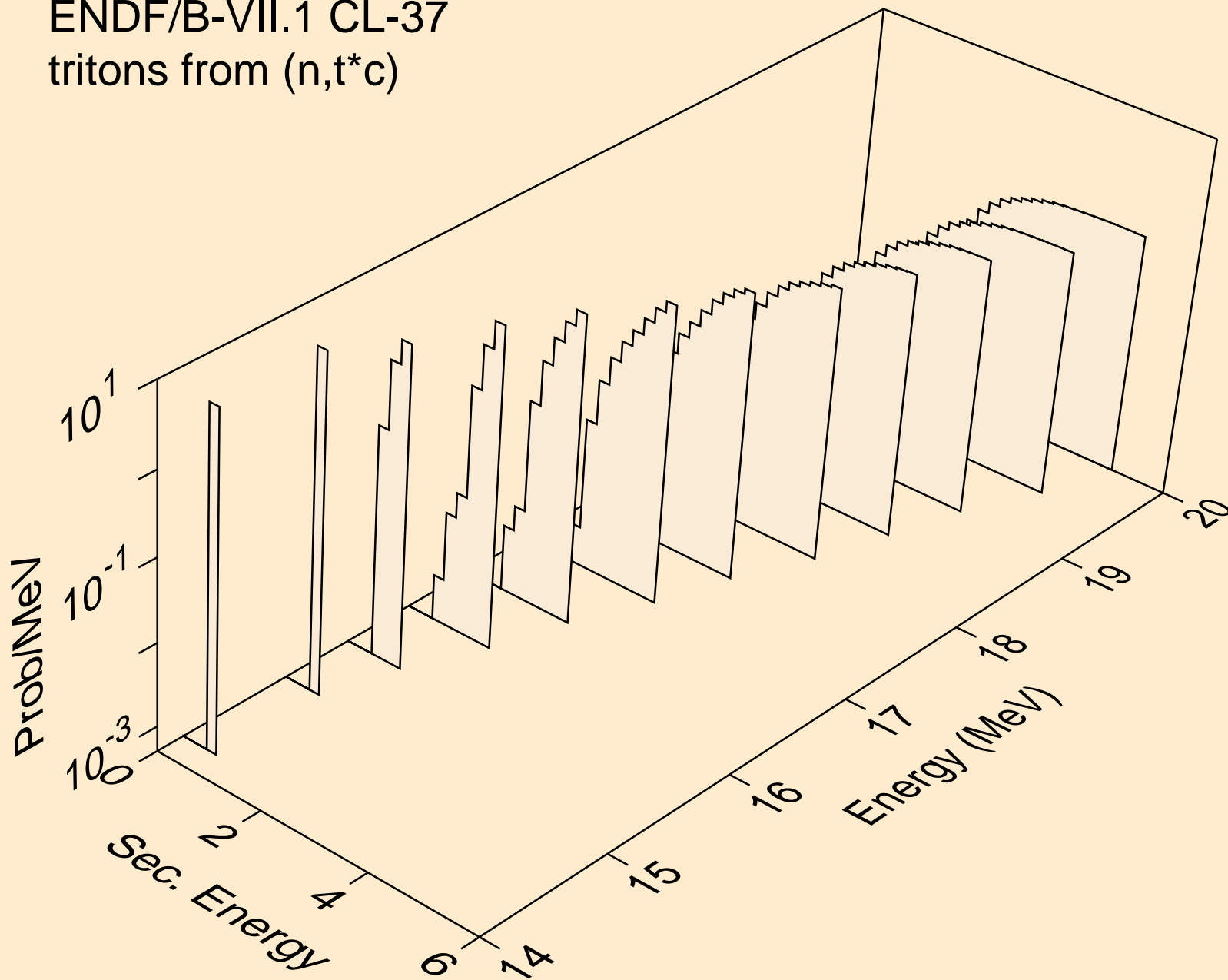

ENDF/B-VII.1 CL-37
alphas from (n,n*)a

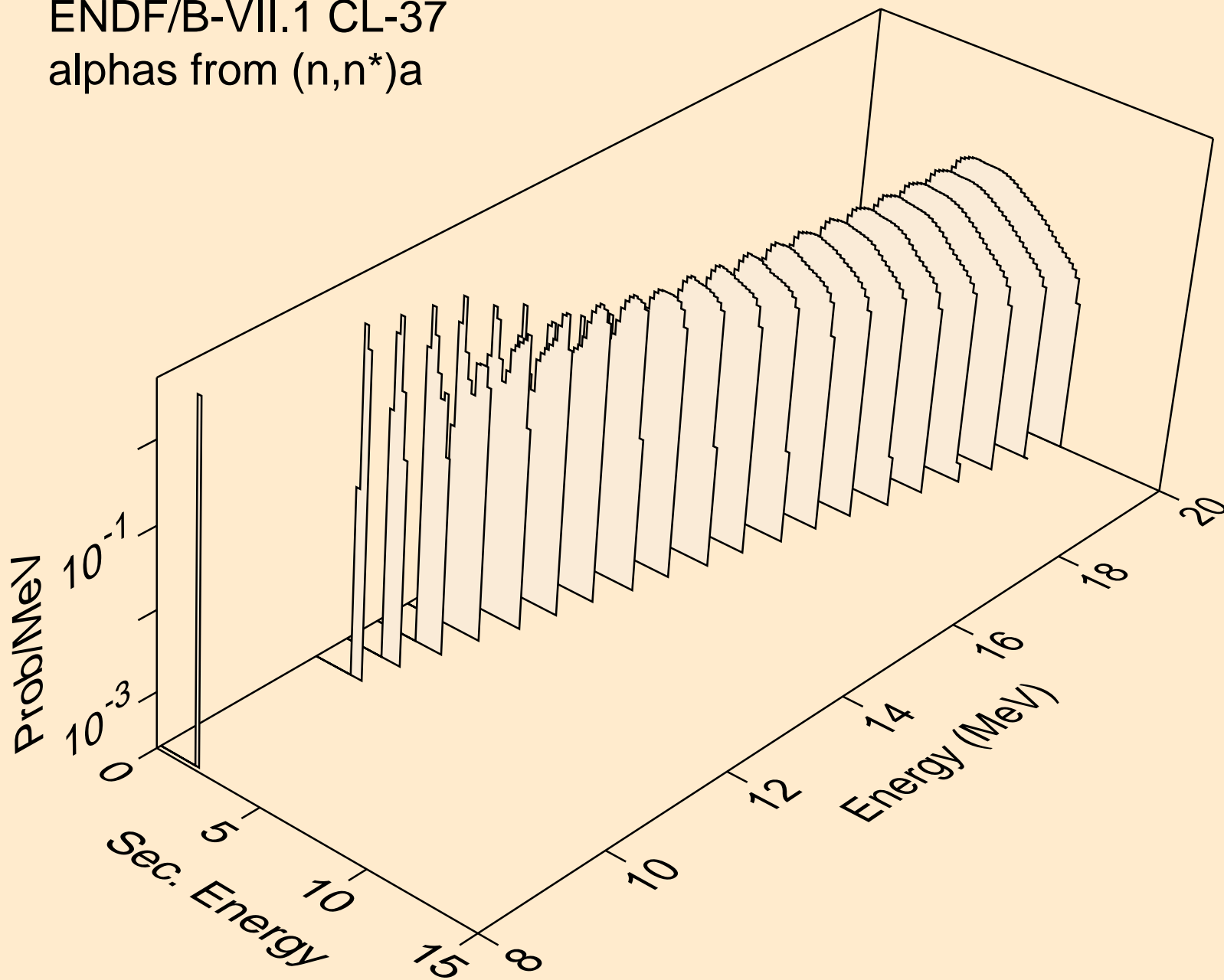

ENDF/B-VII.1 CL-37
angular distribution for (n,a*0) alpha

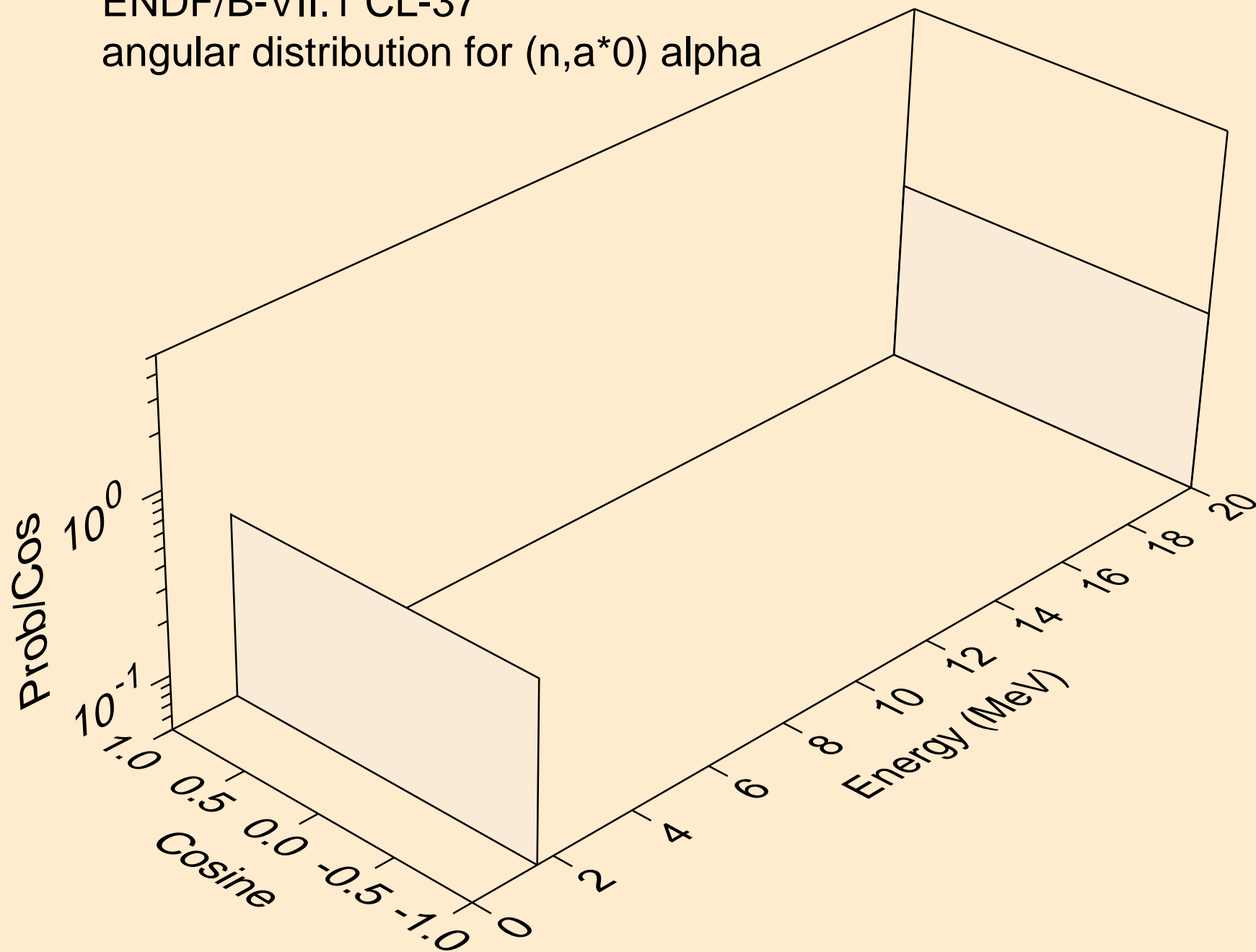

ENDF/B-VII.1 CL-37
angular distribution for (n,a*1) alpha

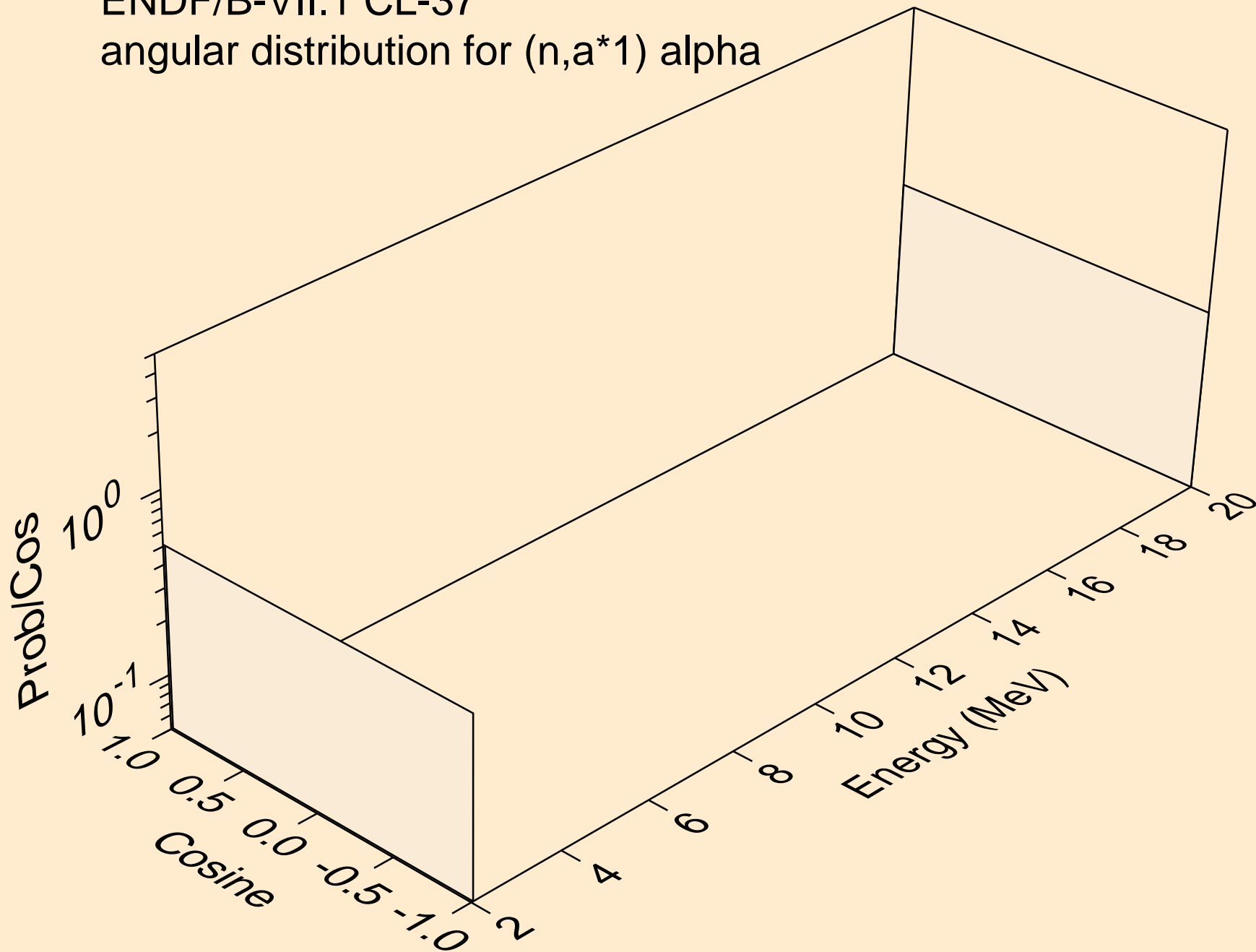

ENDF/B-VII.1 CL-37
angular distribution for (n,a*2) alpha

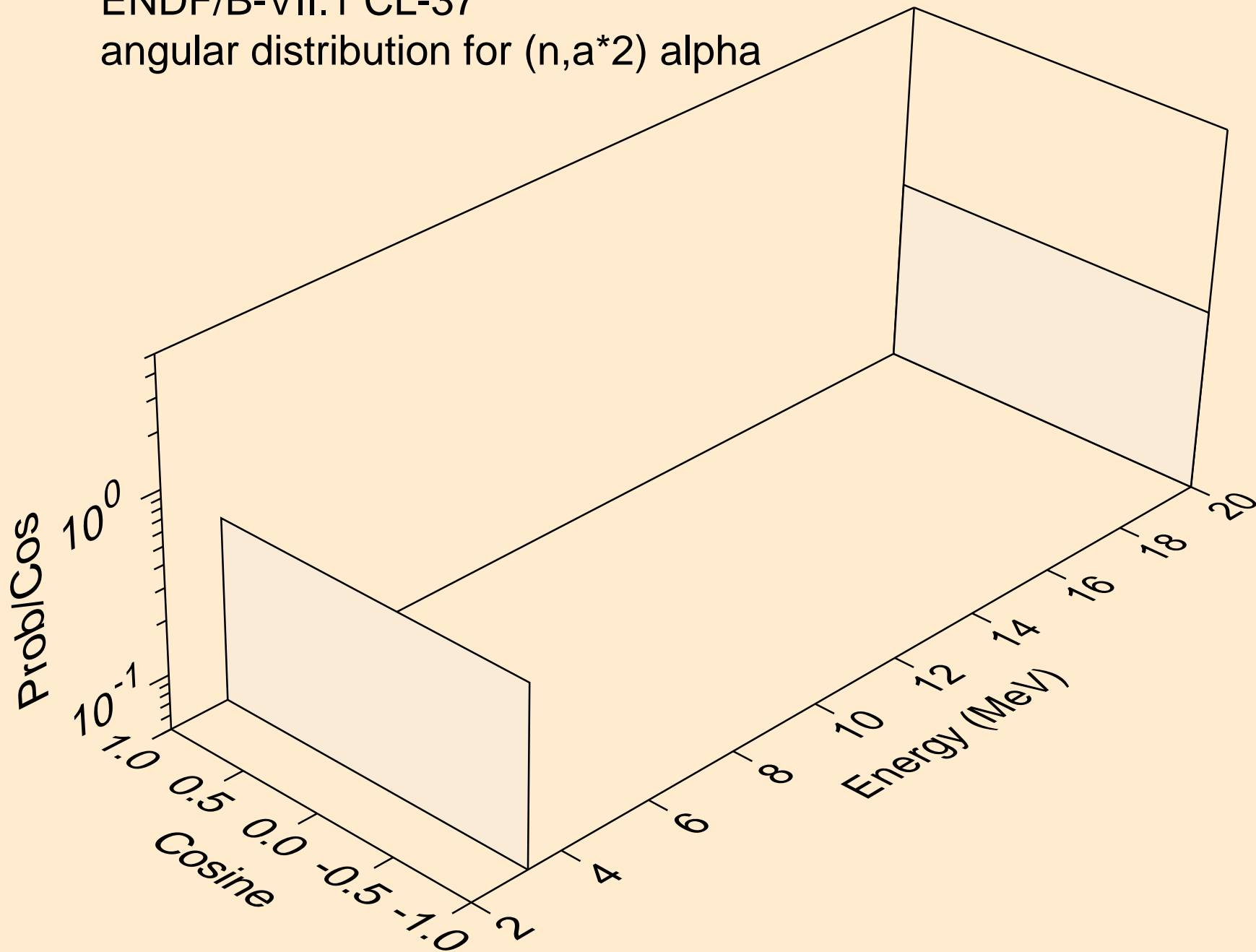

ENDF/B-VII.1 CL-37
angular distribution for (n, α^3) alpha

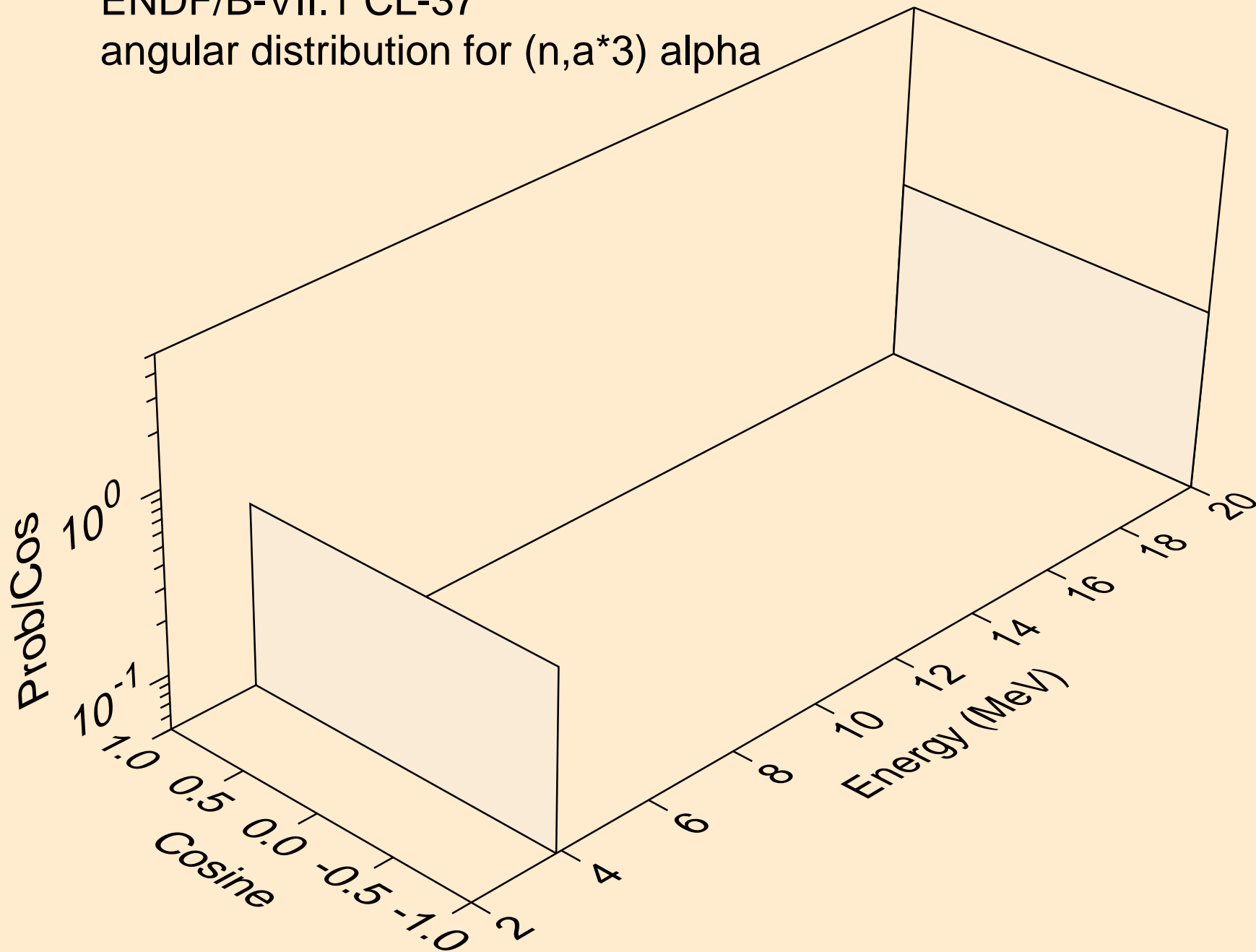

ENDF/B-VII.1 CL-37
angular distribution for (n, α *4) alpha

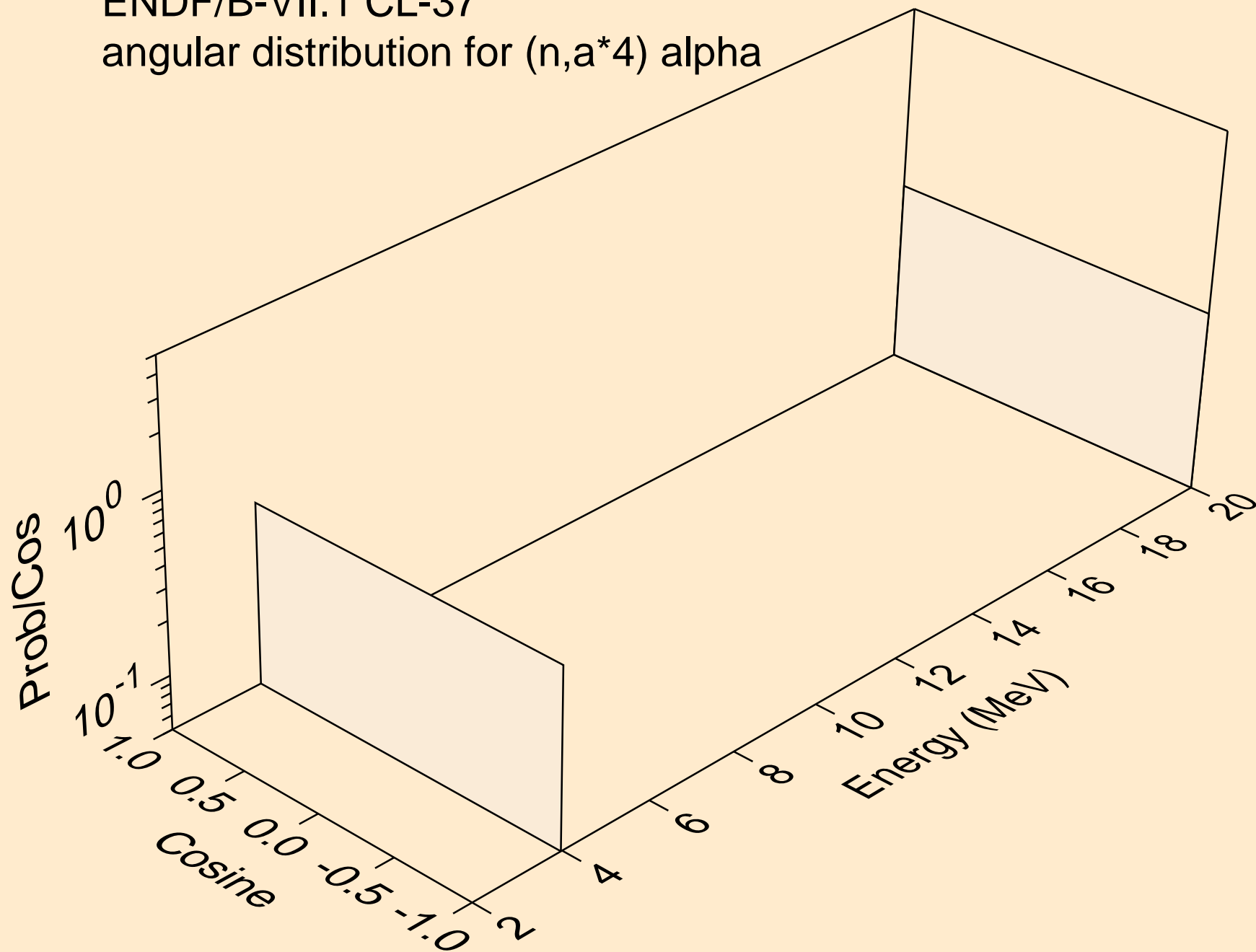

ENDF/B-VII.1 CL-37
angular distribution for (n, α *5) alpha

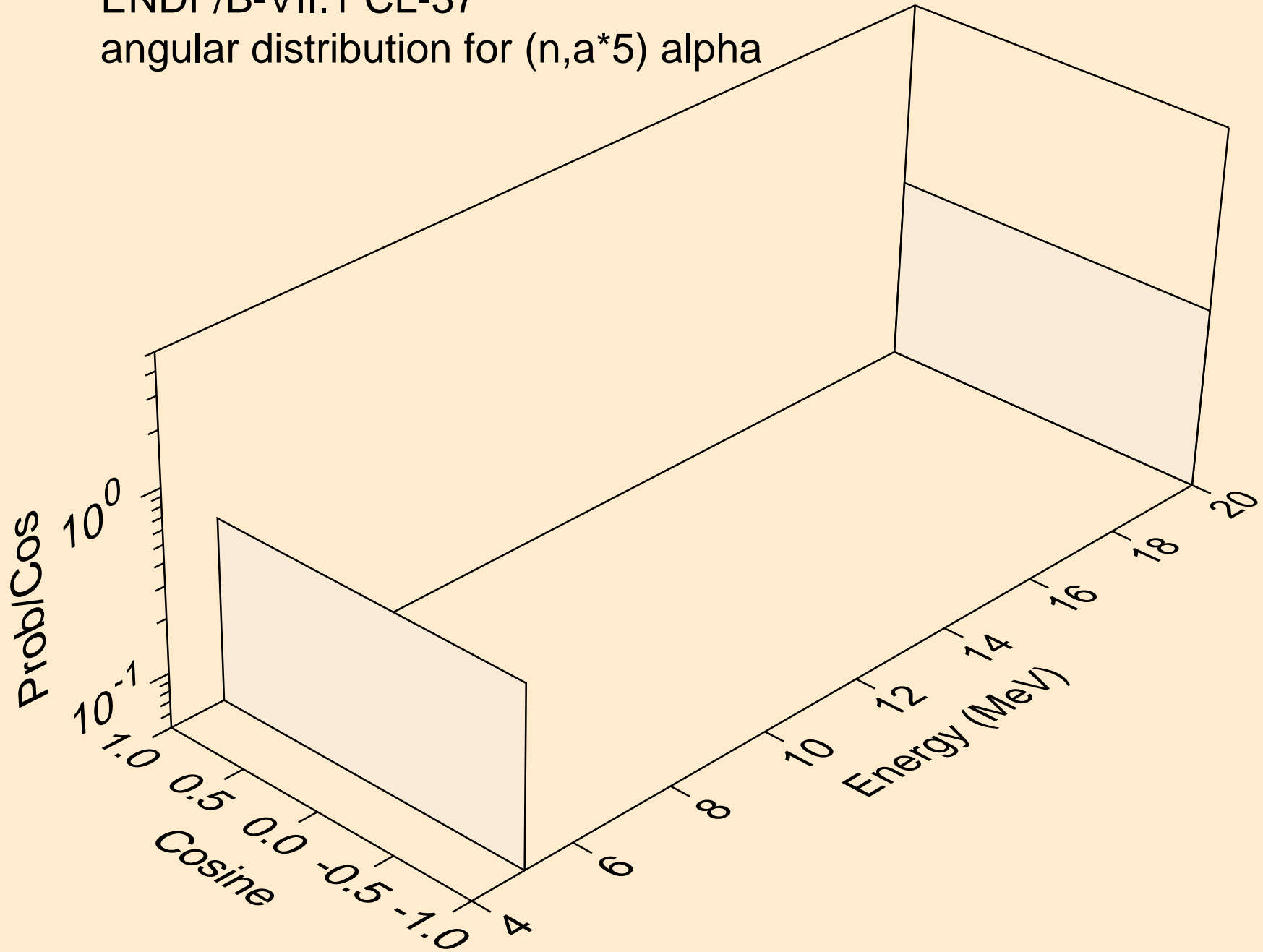

ENDF/B-VII.1 CL-37
alphas from (n,a*c)

