

# ENDF/B-VII.1 CD-111

## Principal cross sections

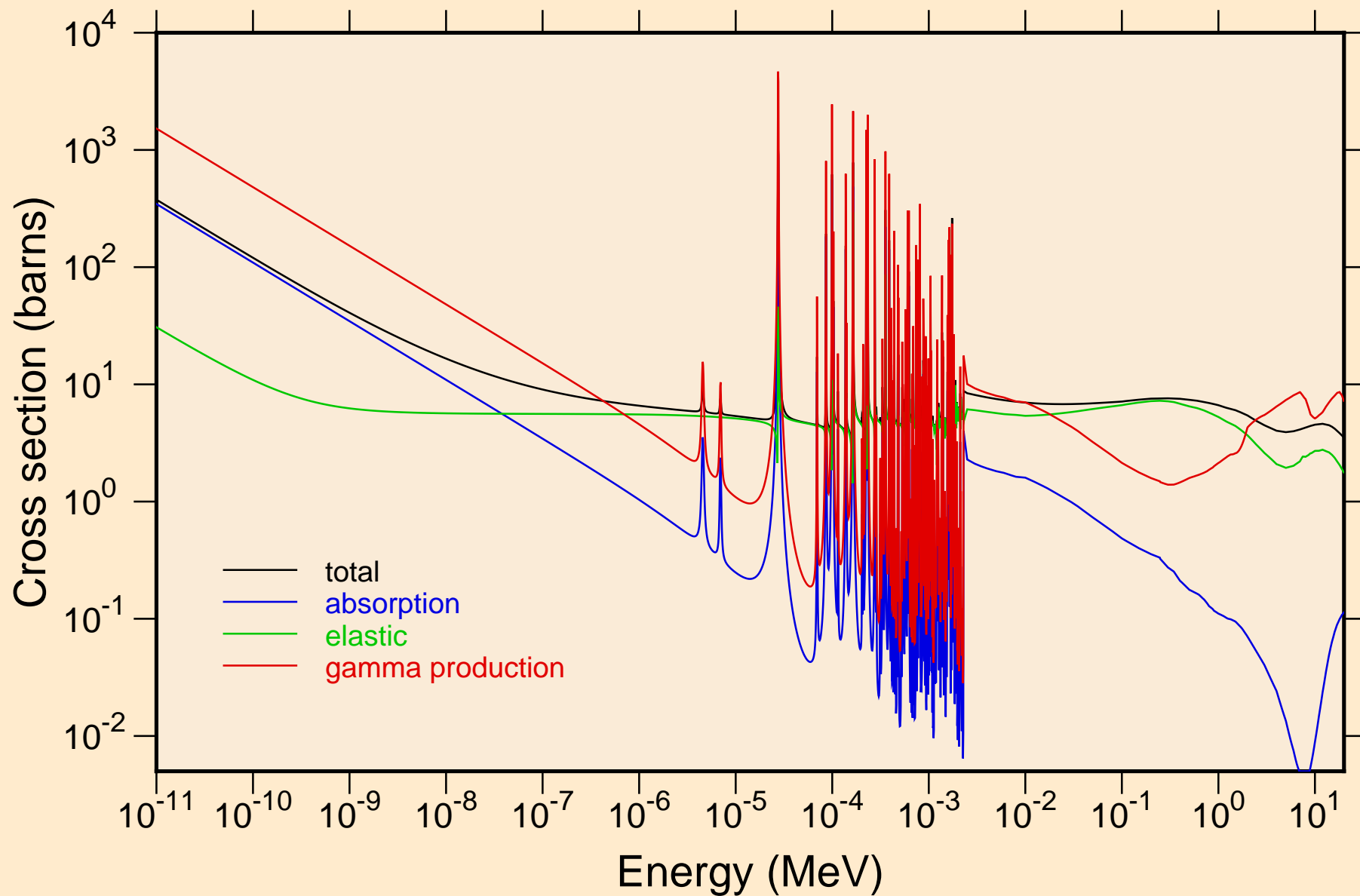

ENDF/B-VII.1 CD-111  
resonance total cross section

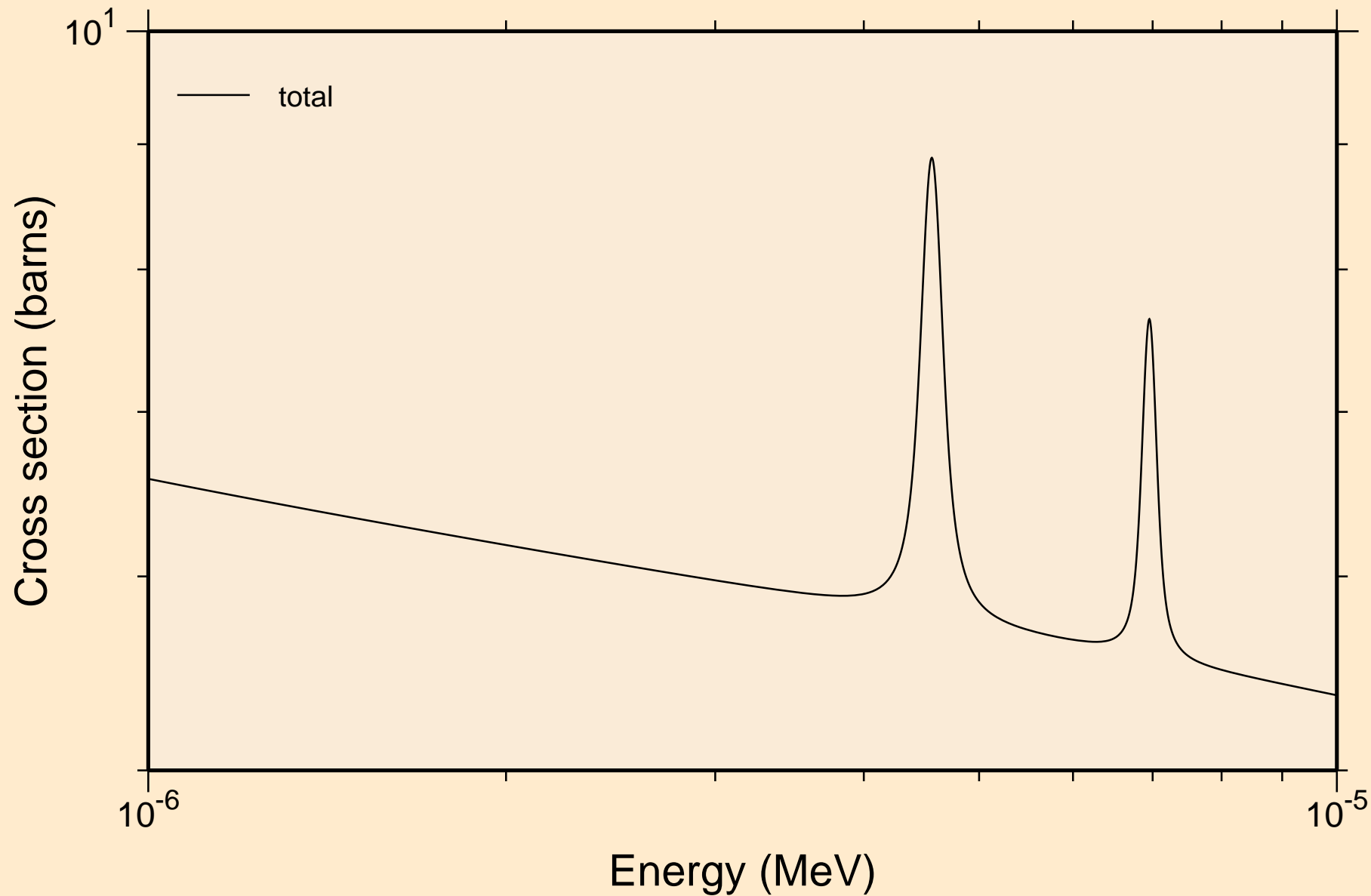

ENDF/B-VII.1 CD-111  
resonance total cross section

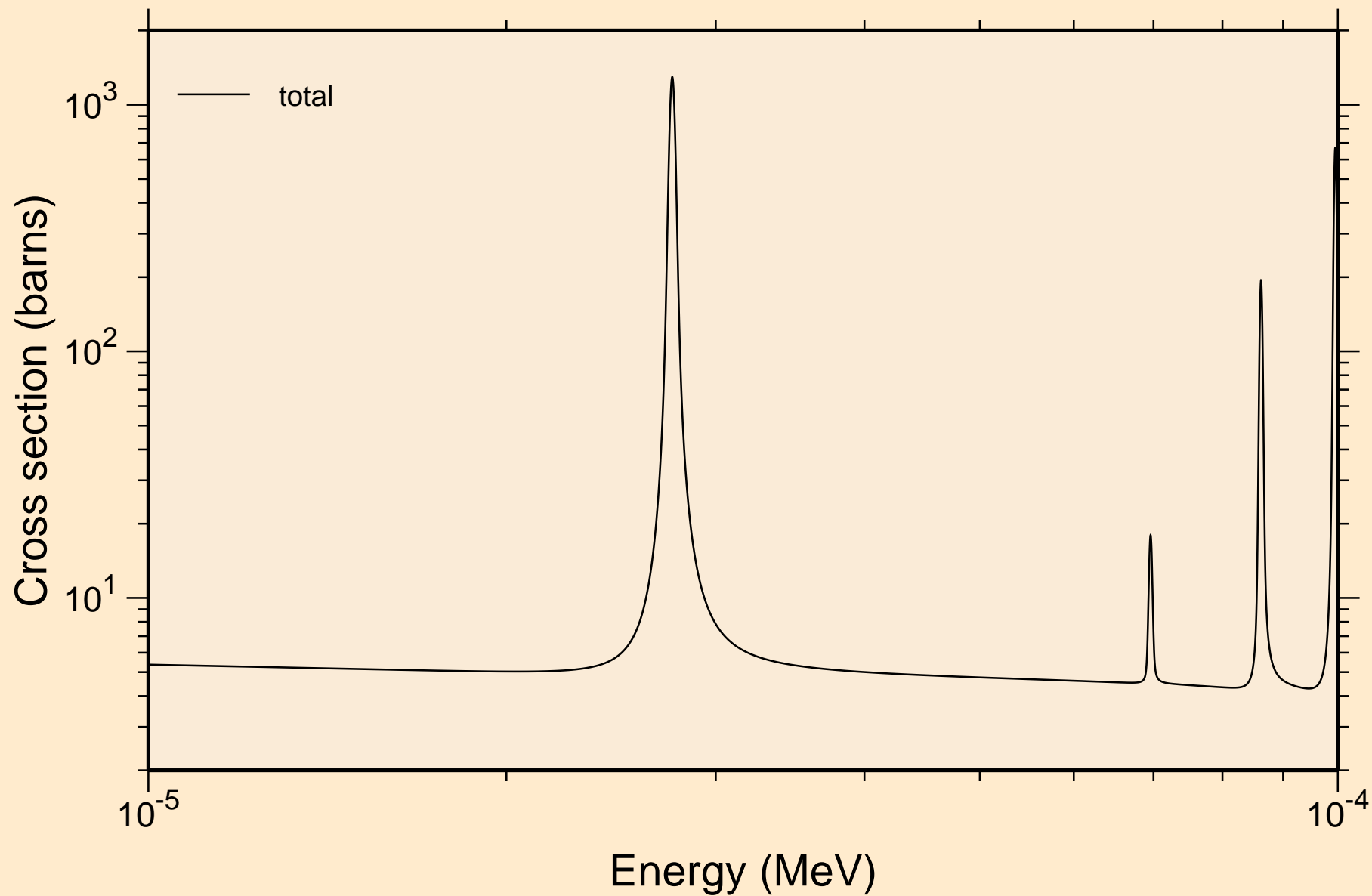

ENDF/B-VII.1 CD-111  
resonance total cross section

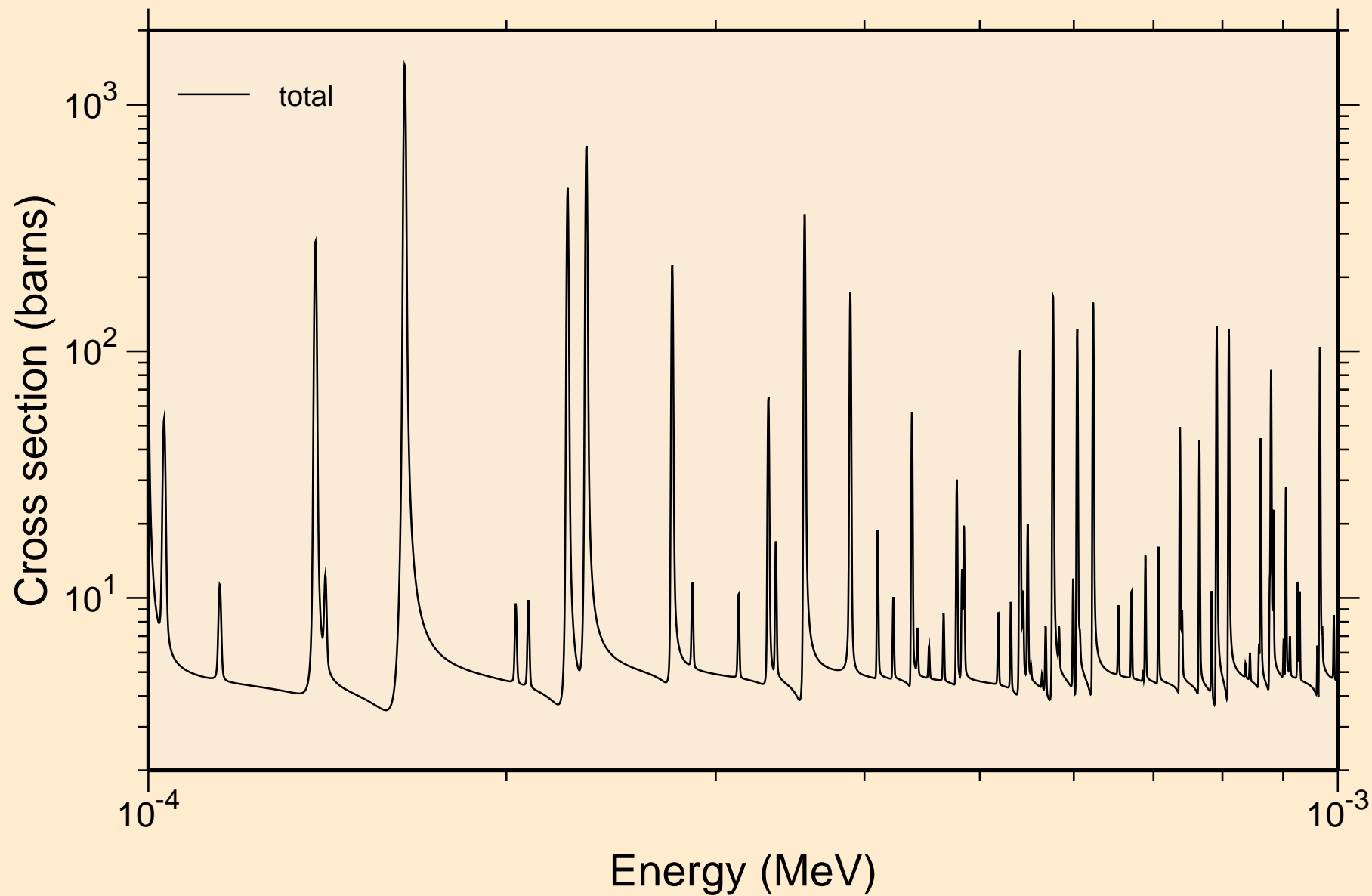

ENDF/B-VII.1 CD-111  
resonance total cross section

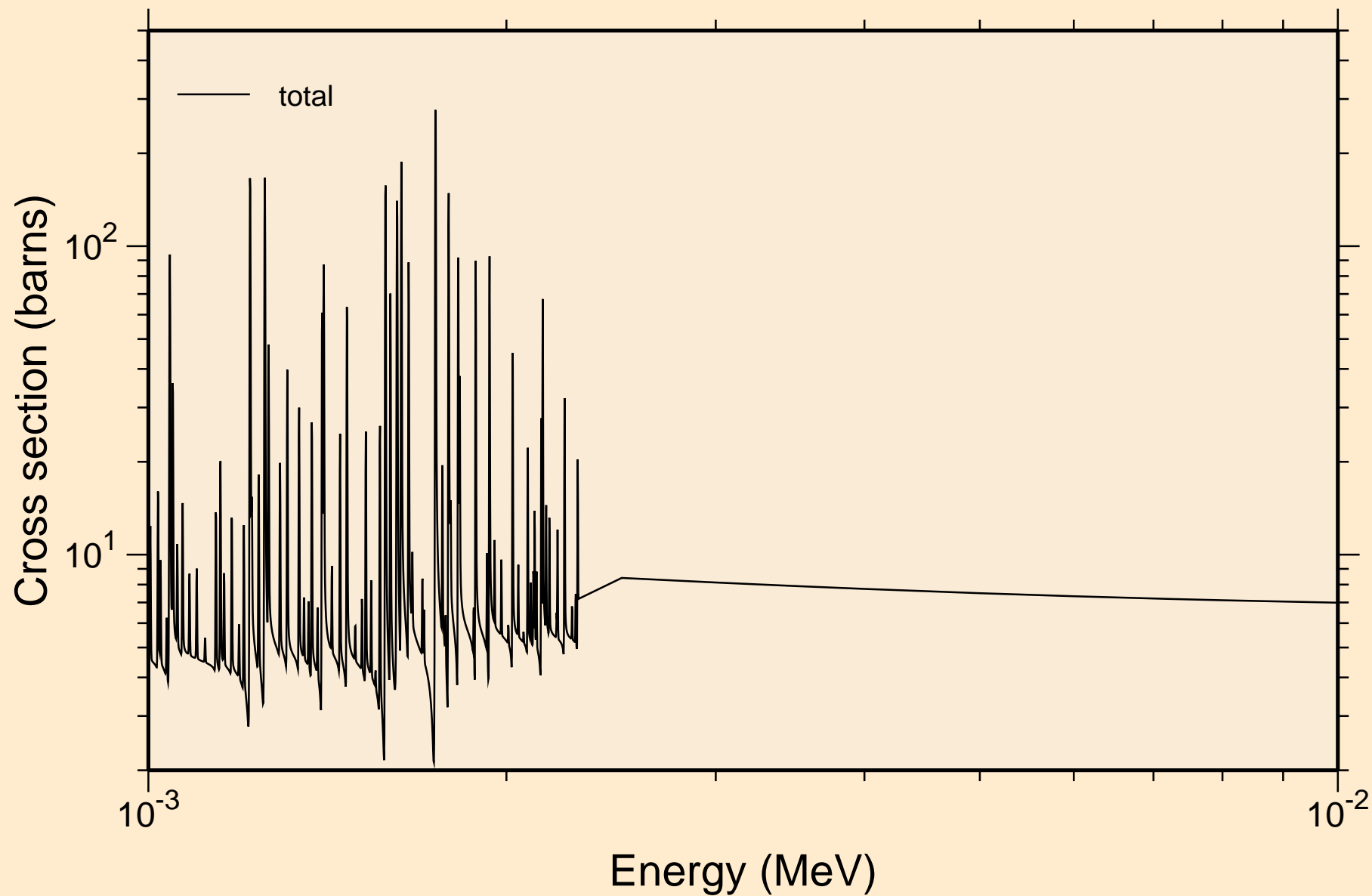

ENDF/B-VII.1 CD-111  
resonance total cross section

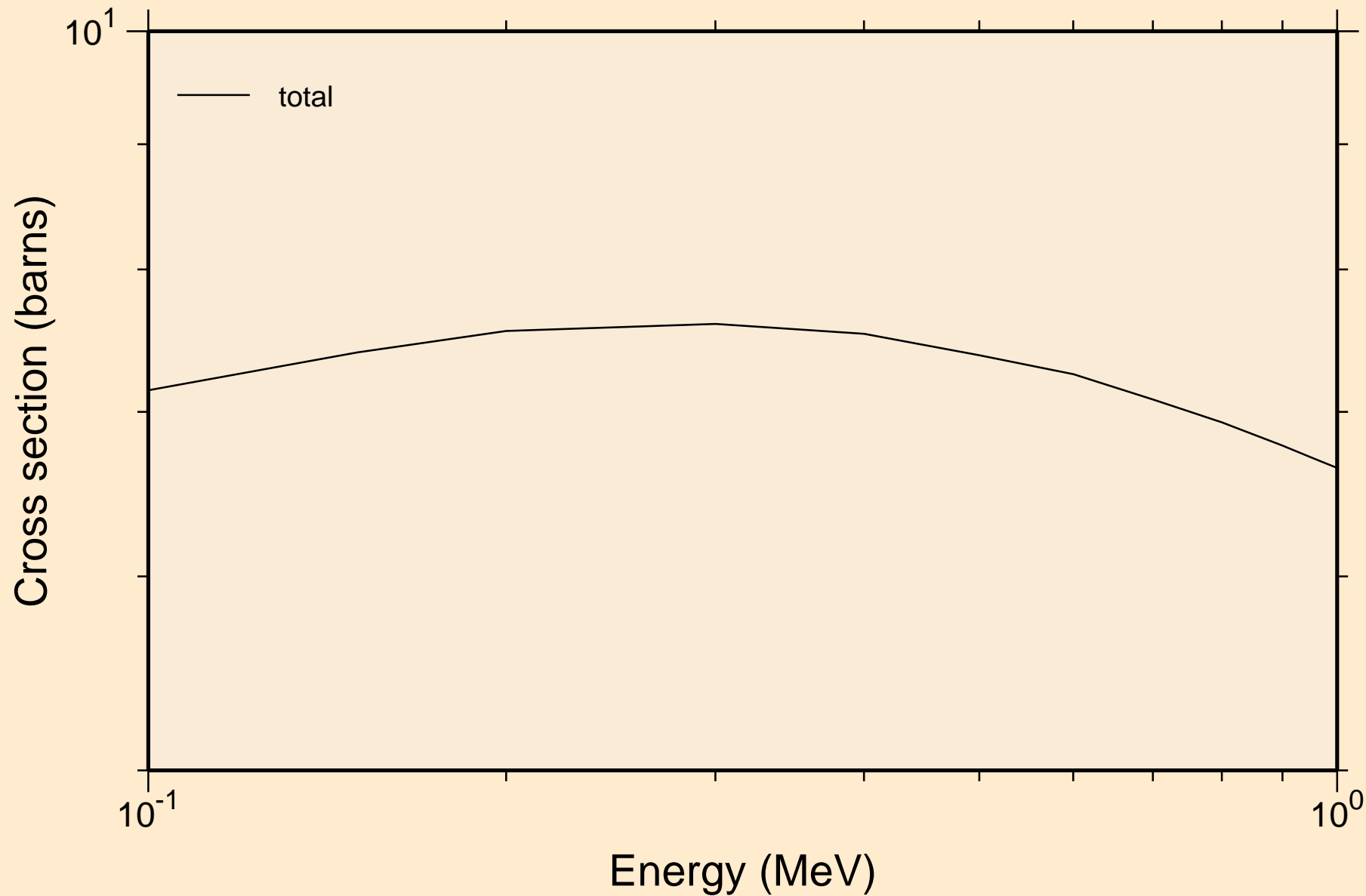

ENDF/B-VII.1 CD-111  
resonance total cross section

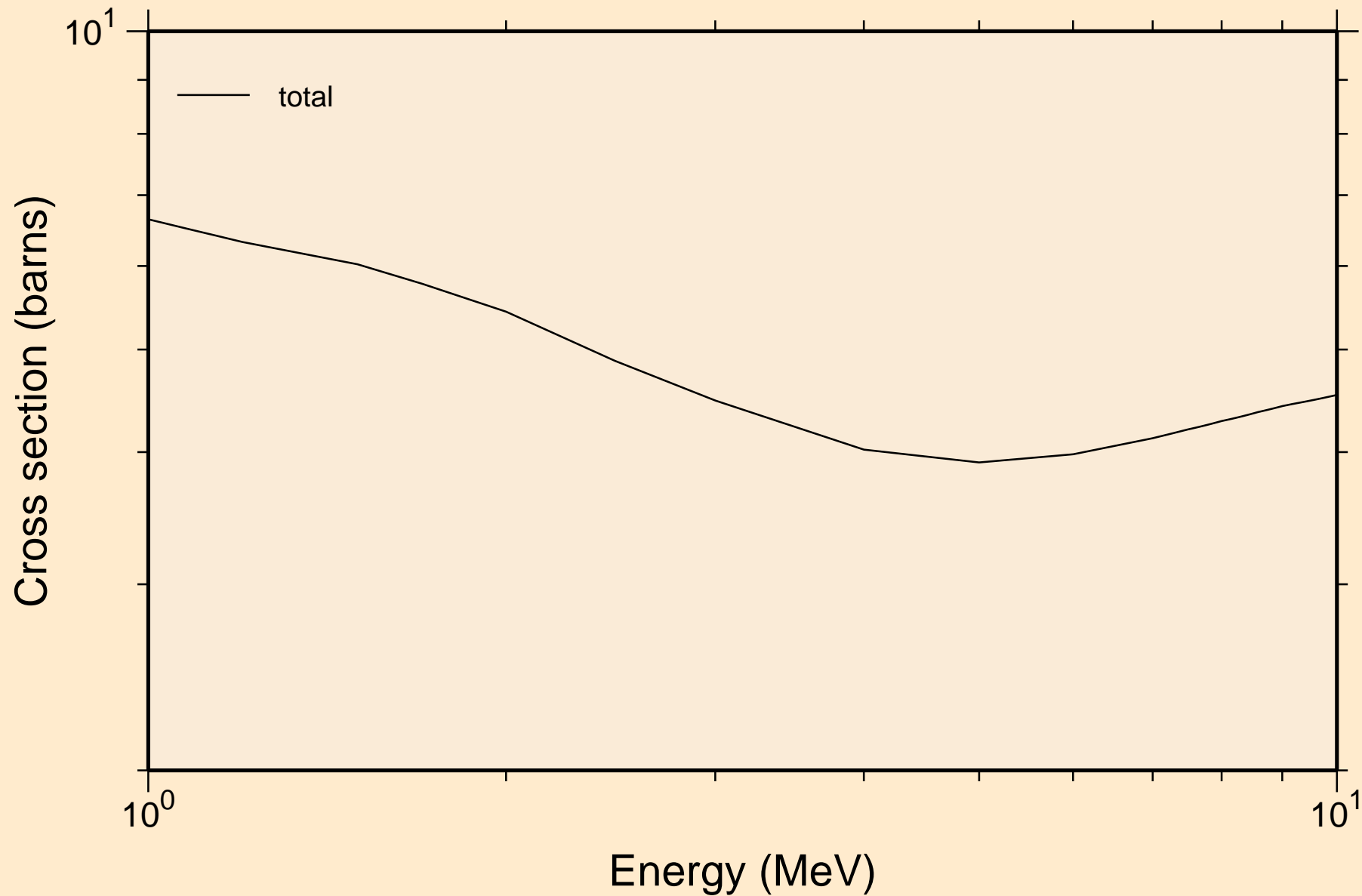

ENDF/B-VII.1 CD-111  
resonance absorption cross sections

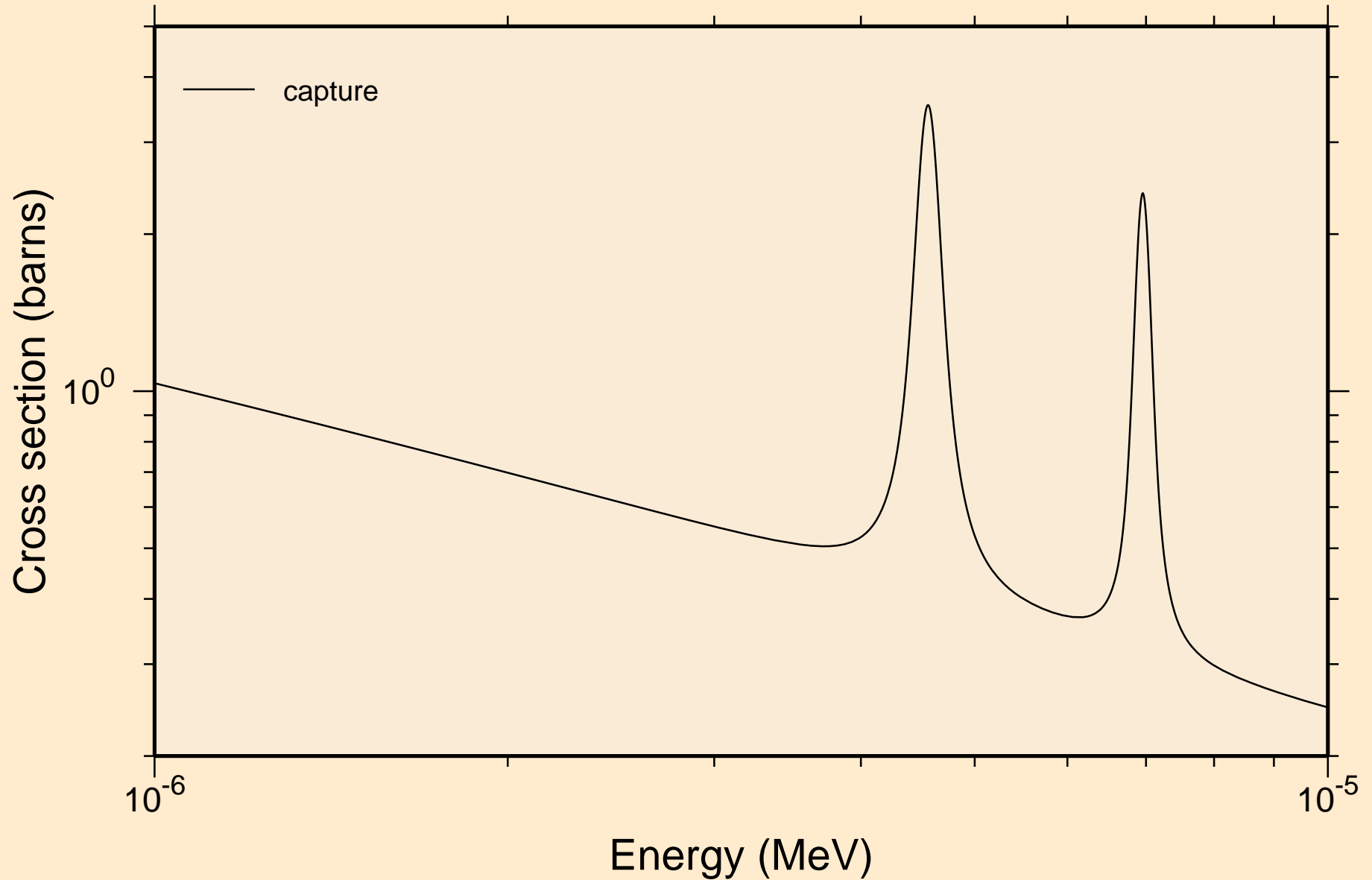



ENDF/B-VII.1 CD-111  
resonance absorption cross sections

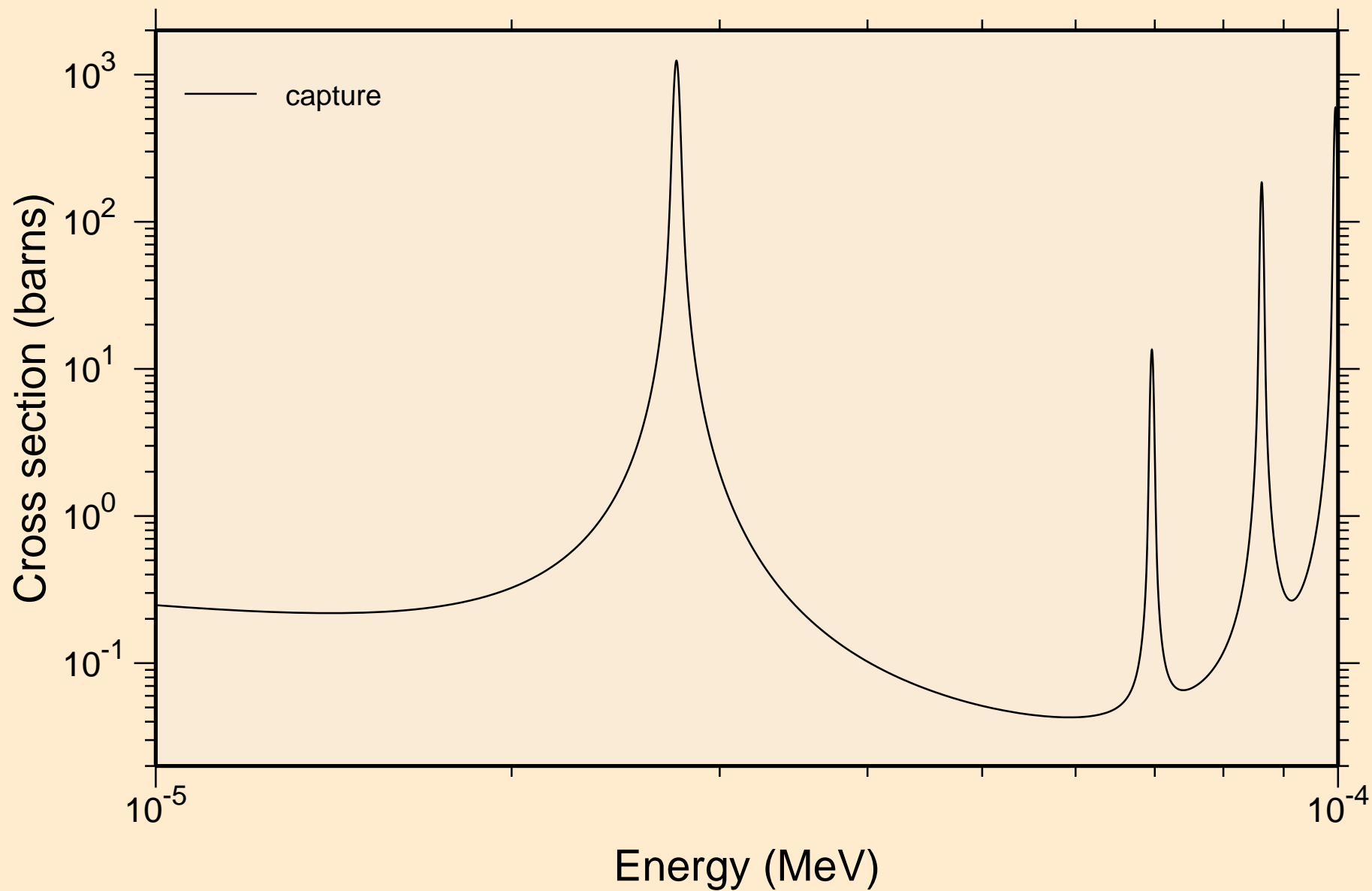

# ENDF/B-VII.1 CD-111 resonance absorption cross sections

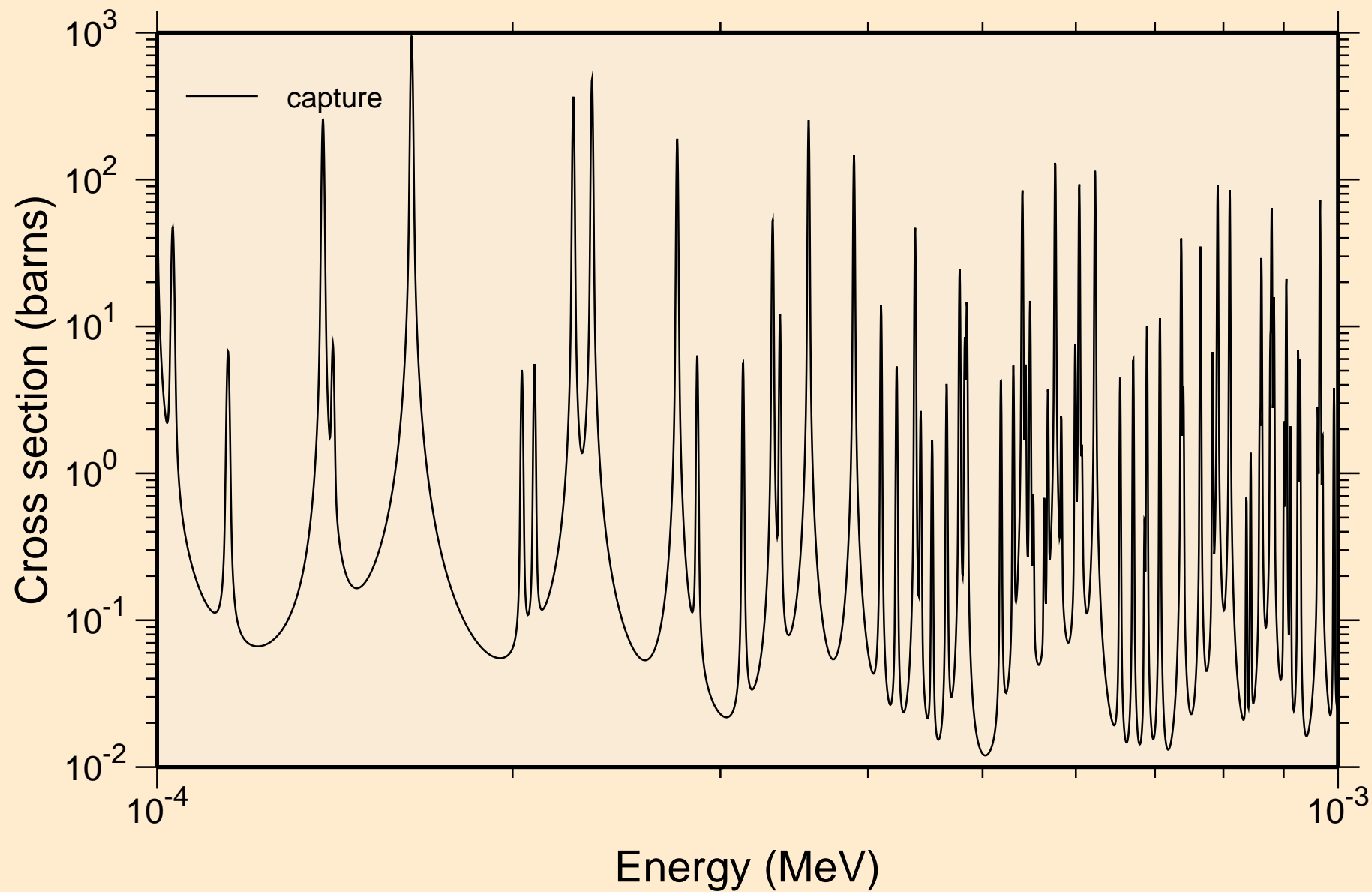

ENDF/B-VII.1 CD-111  
resonance absorption cross sections

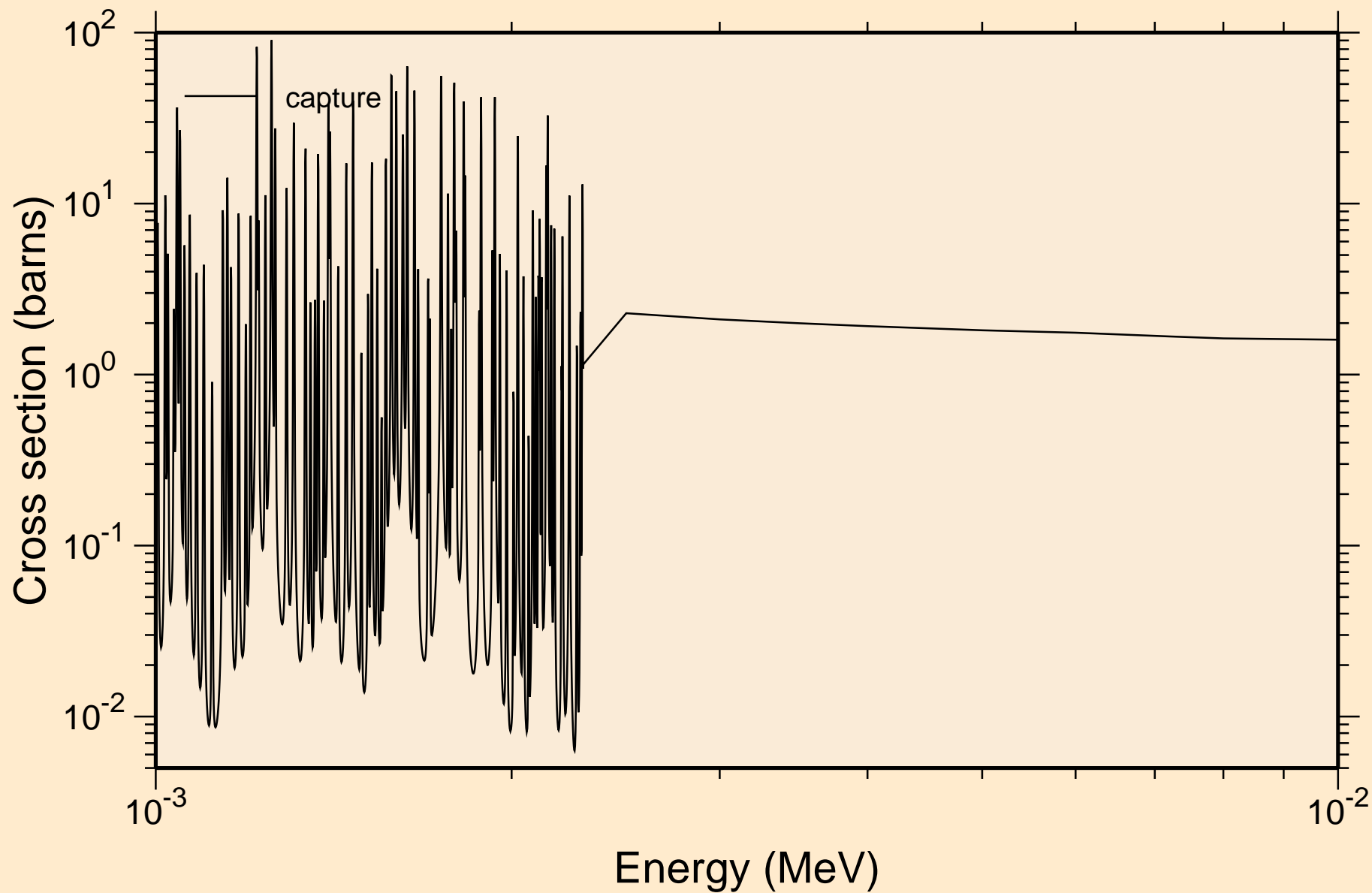

ENDF/B-VII.1 CD-111  
resonance absorption cross sections

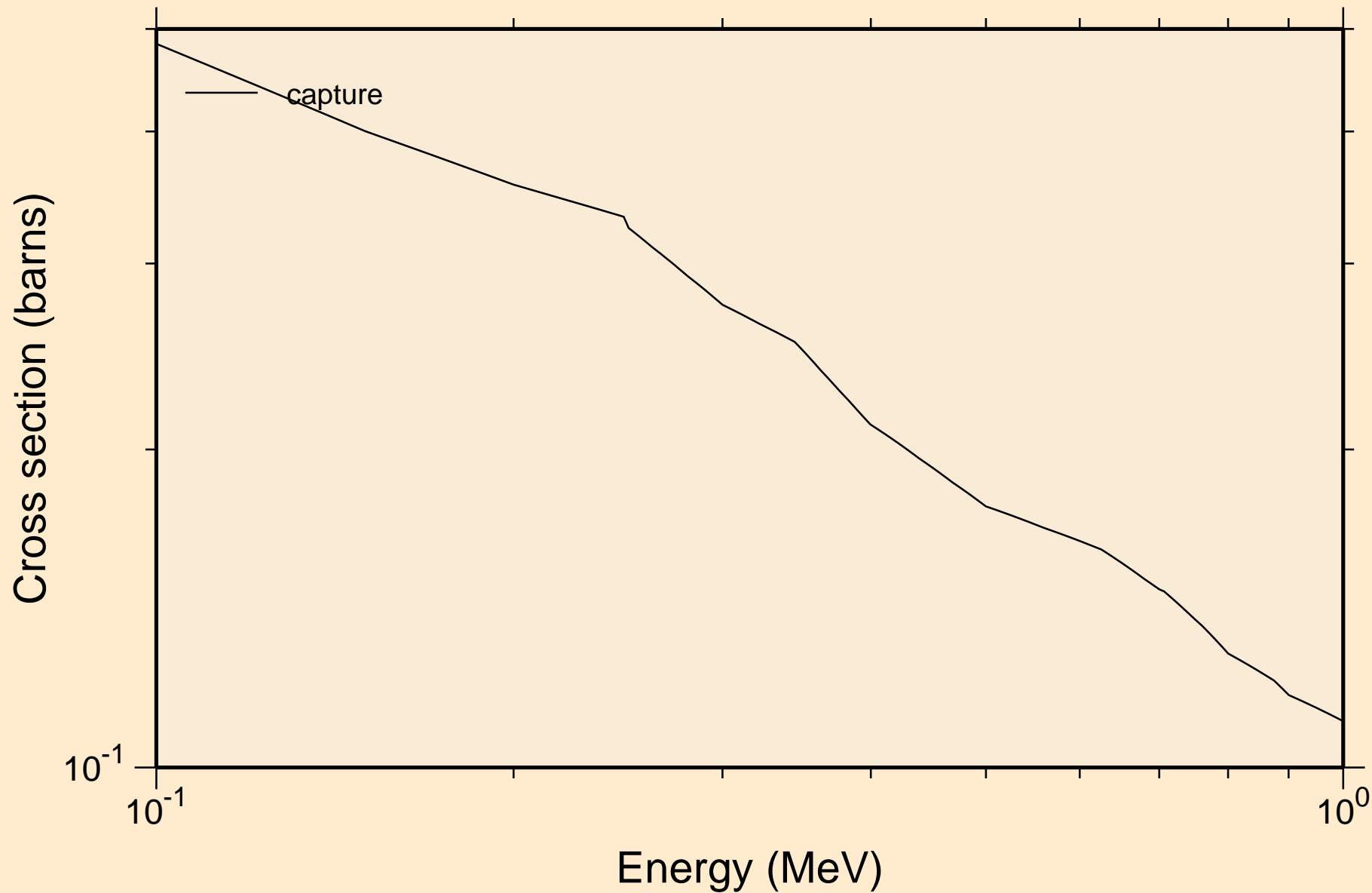

ENDF/B-VII.1 CD-111  
resonance absorption cross sections

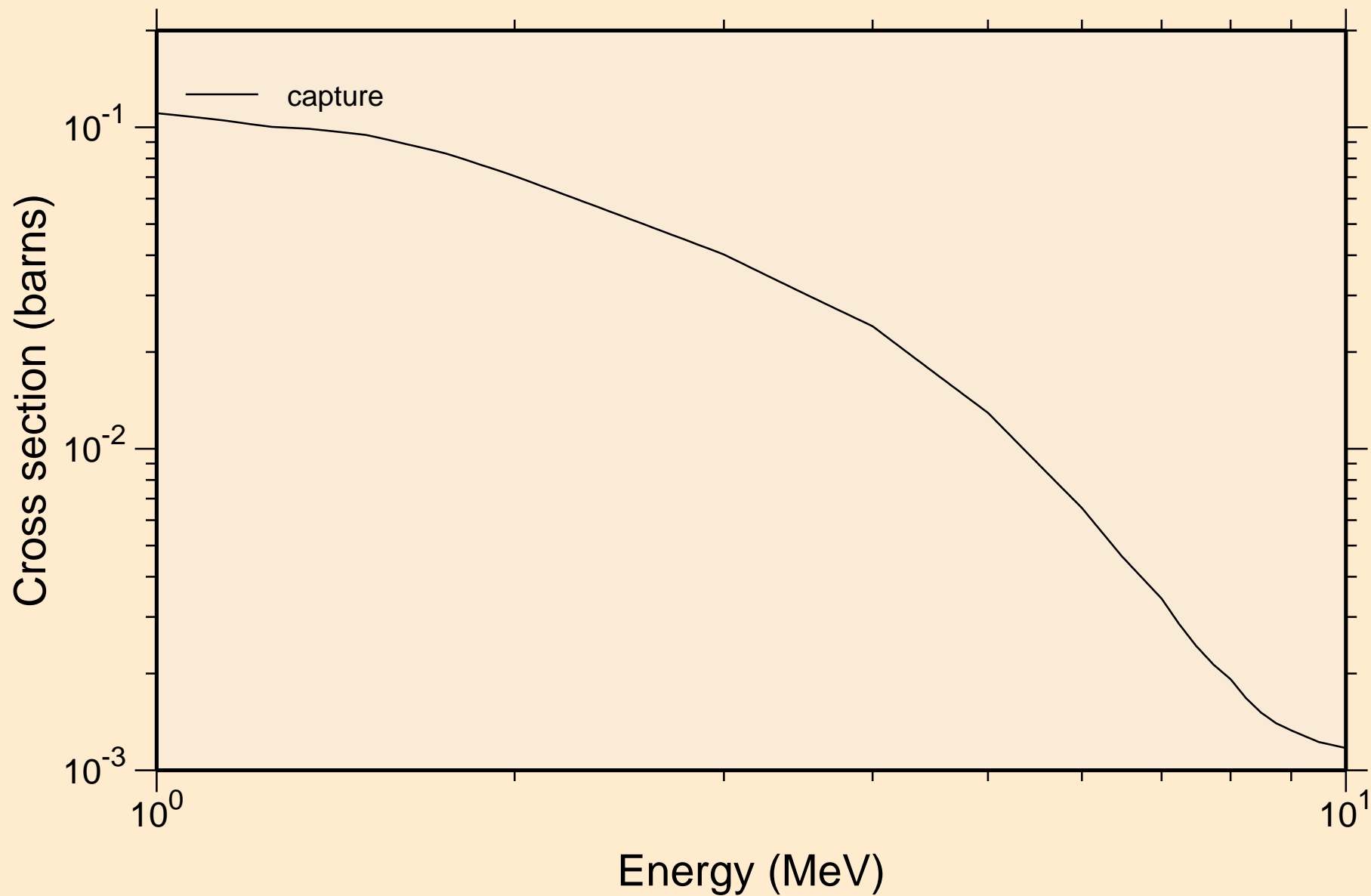

ENDF/B-VII.1 CD-111  
UR total cross section

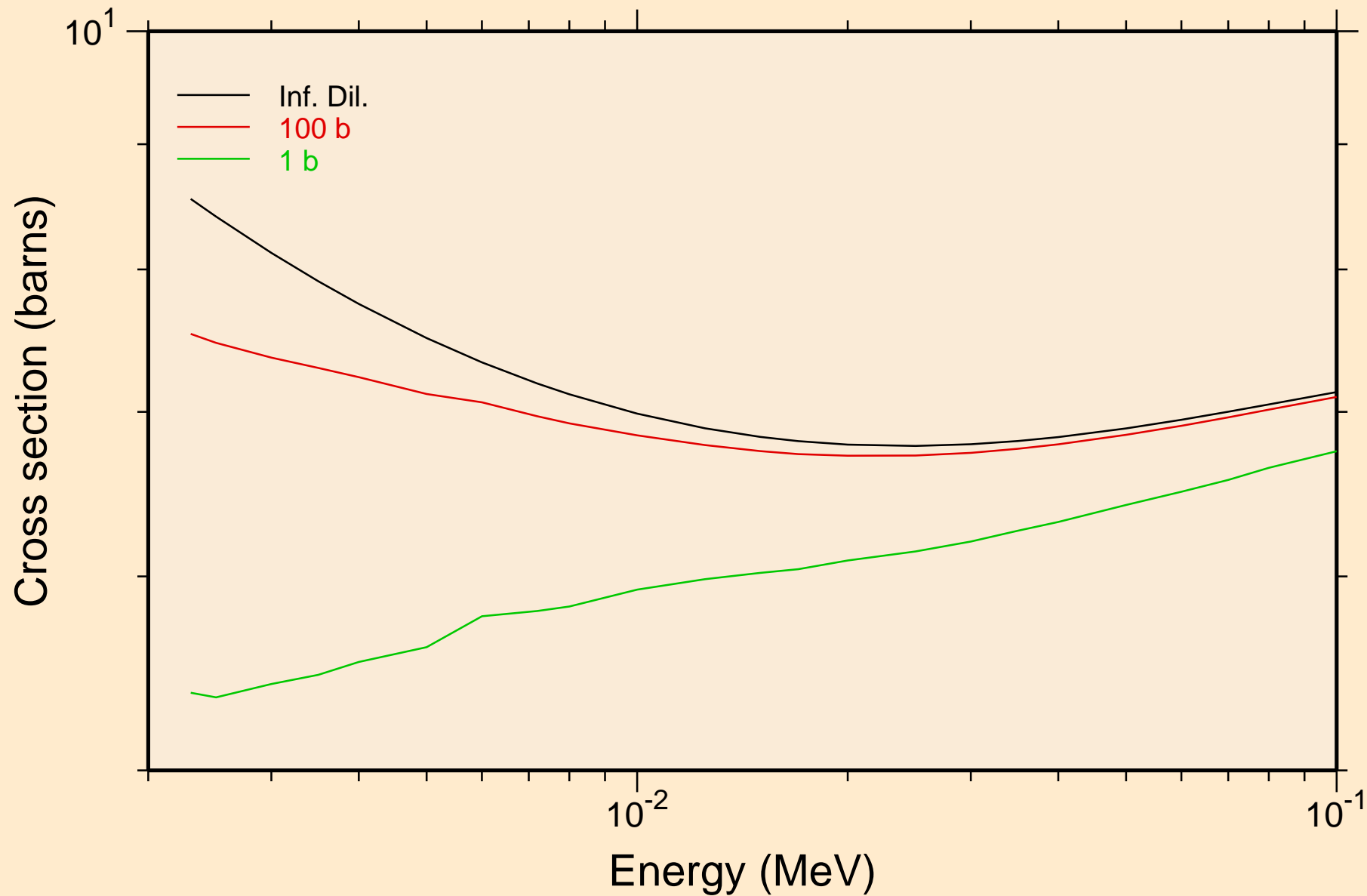

ENDF/B-VII.1 CD-111  
UR elastic cross section

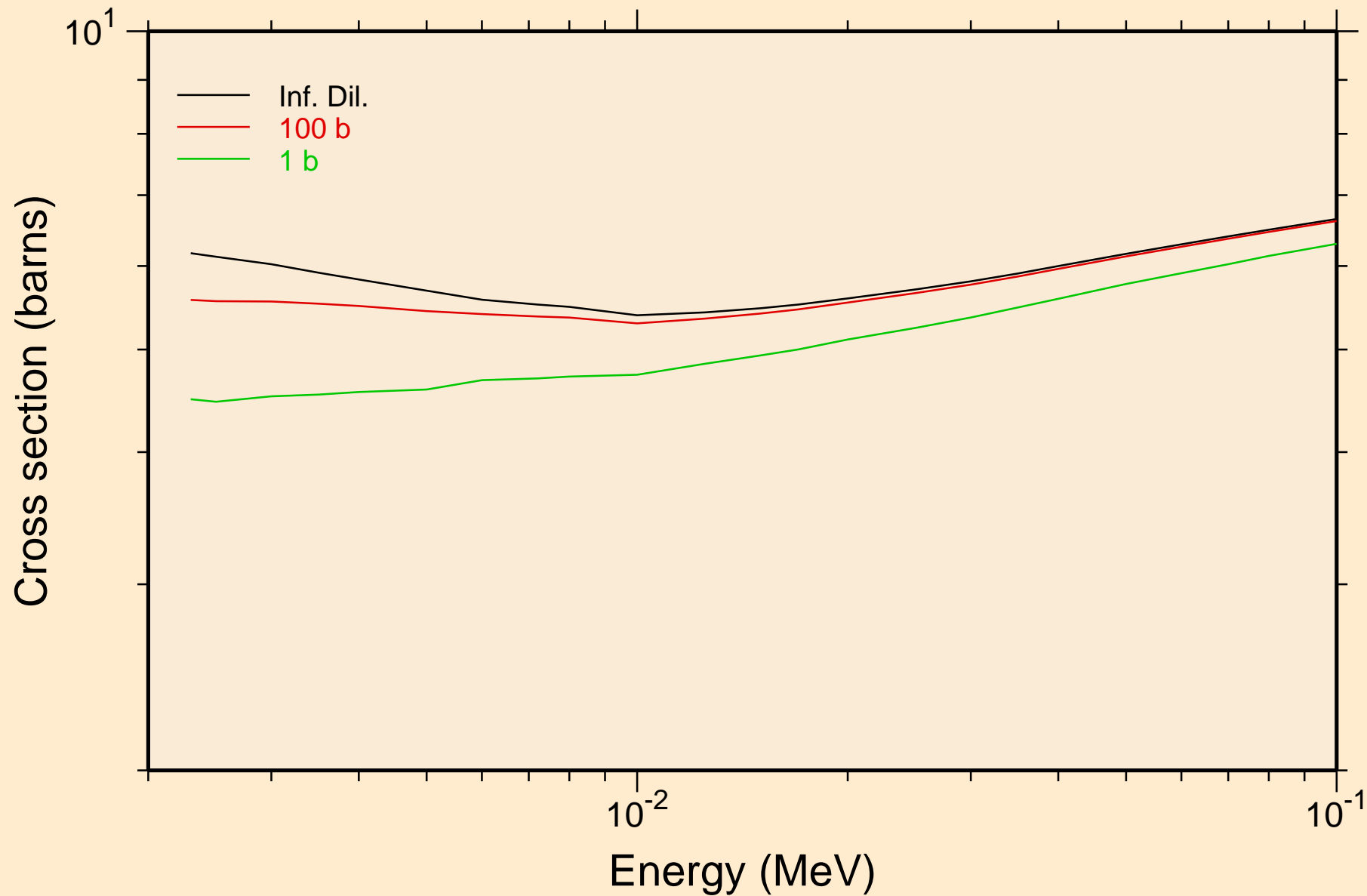

ENDF/B-VII.1 CD-111  
UR capture cross section

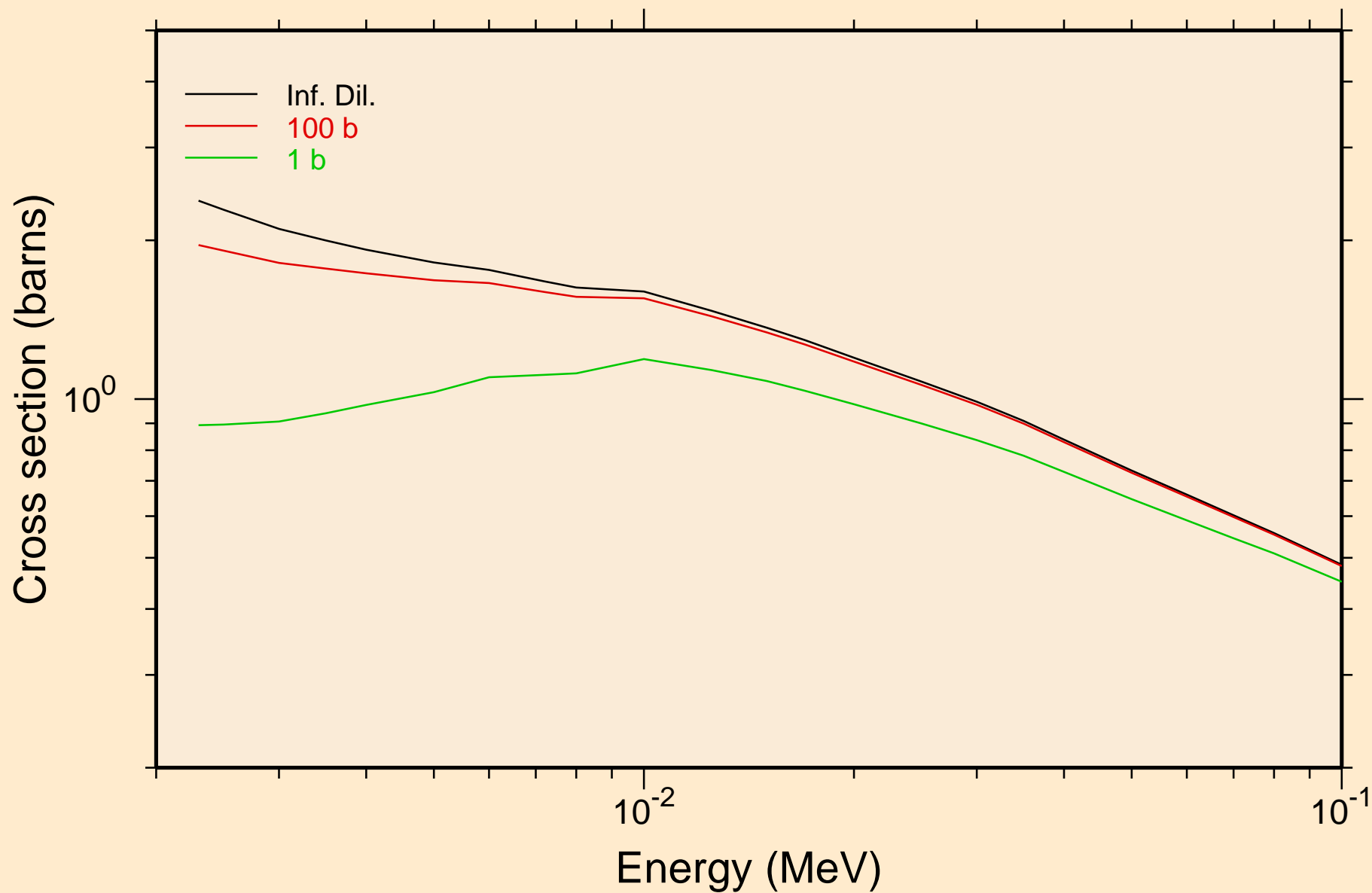



# ENDF/B-VII.1 CD-111

## Heating

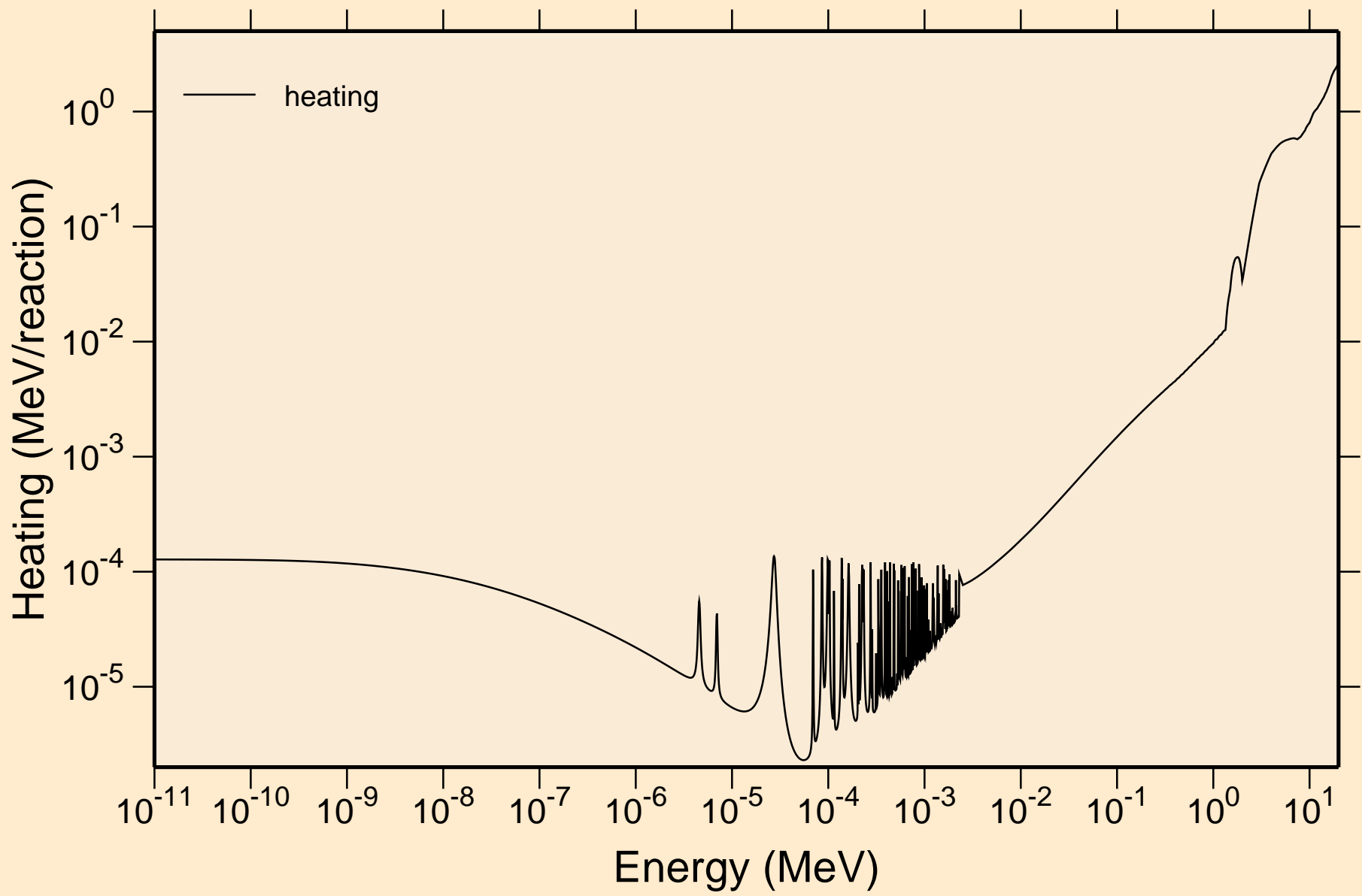

# ENDF/B-VII.1 CD-111 Damage

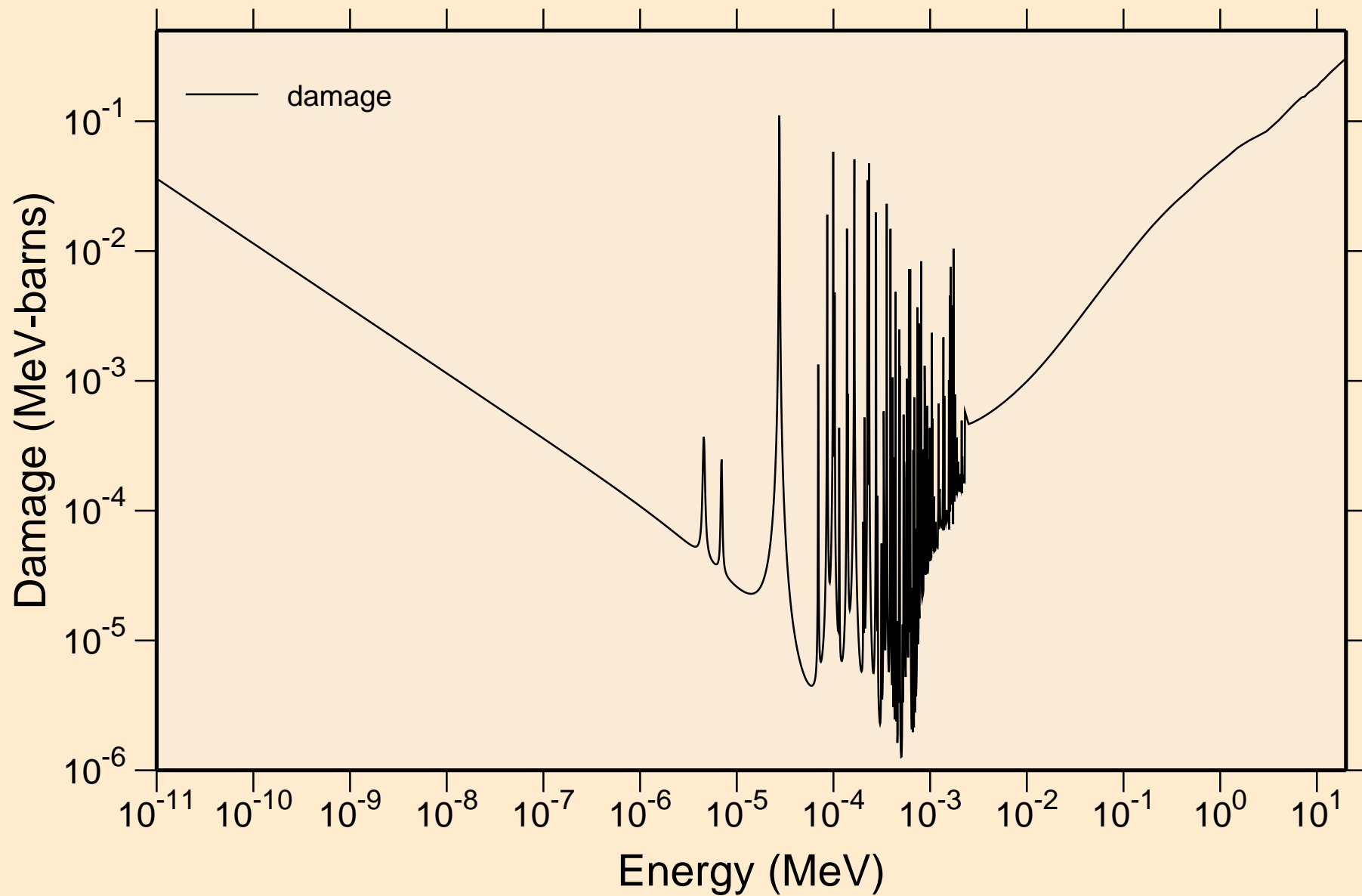

ENDF/B-VII.1 CD-111  
Non-threshold reactions

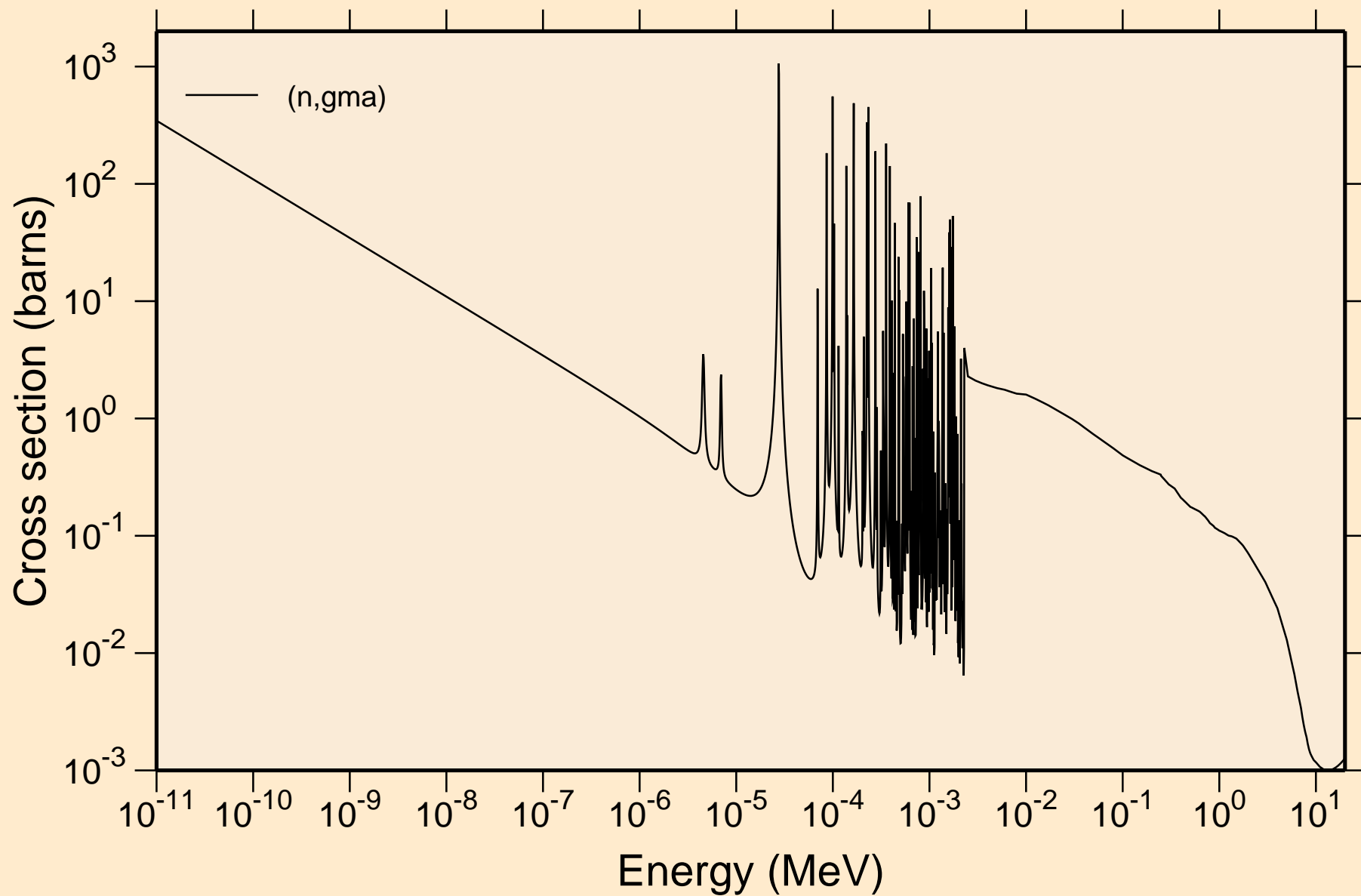

ENDF/B-VII.1 CD-111  
Principal cross sections

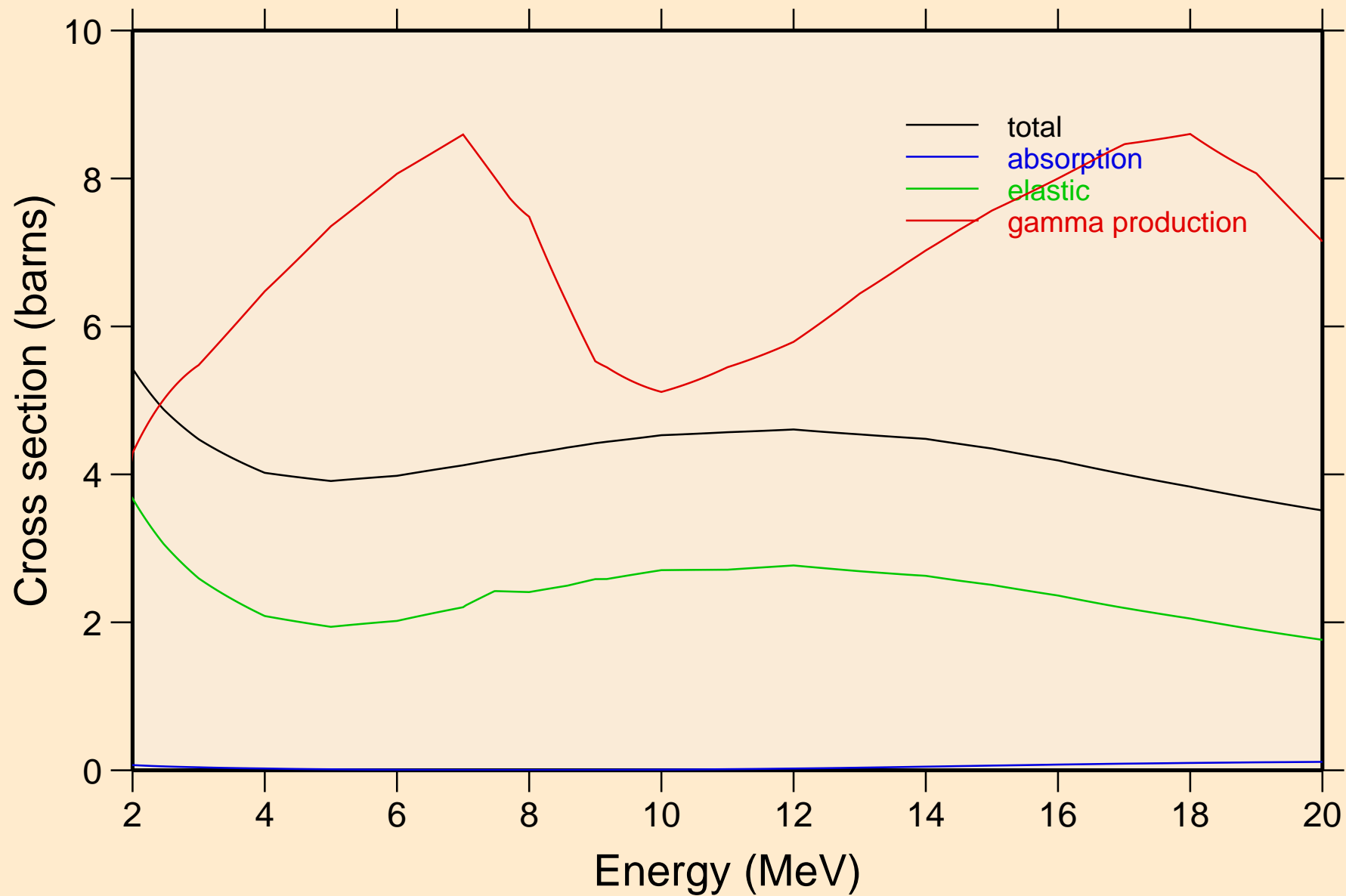

# ENDF/B-VII.1 CD-111

## Heating

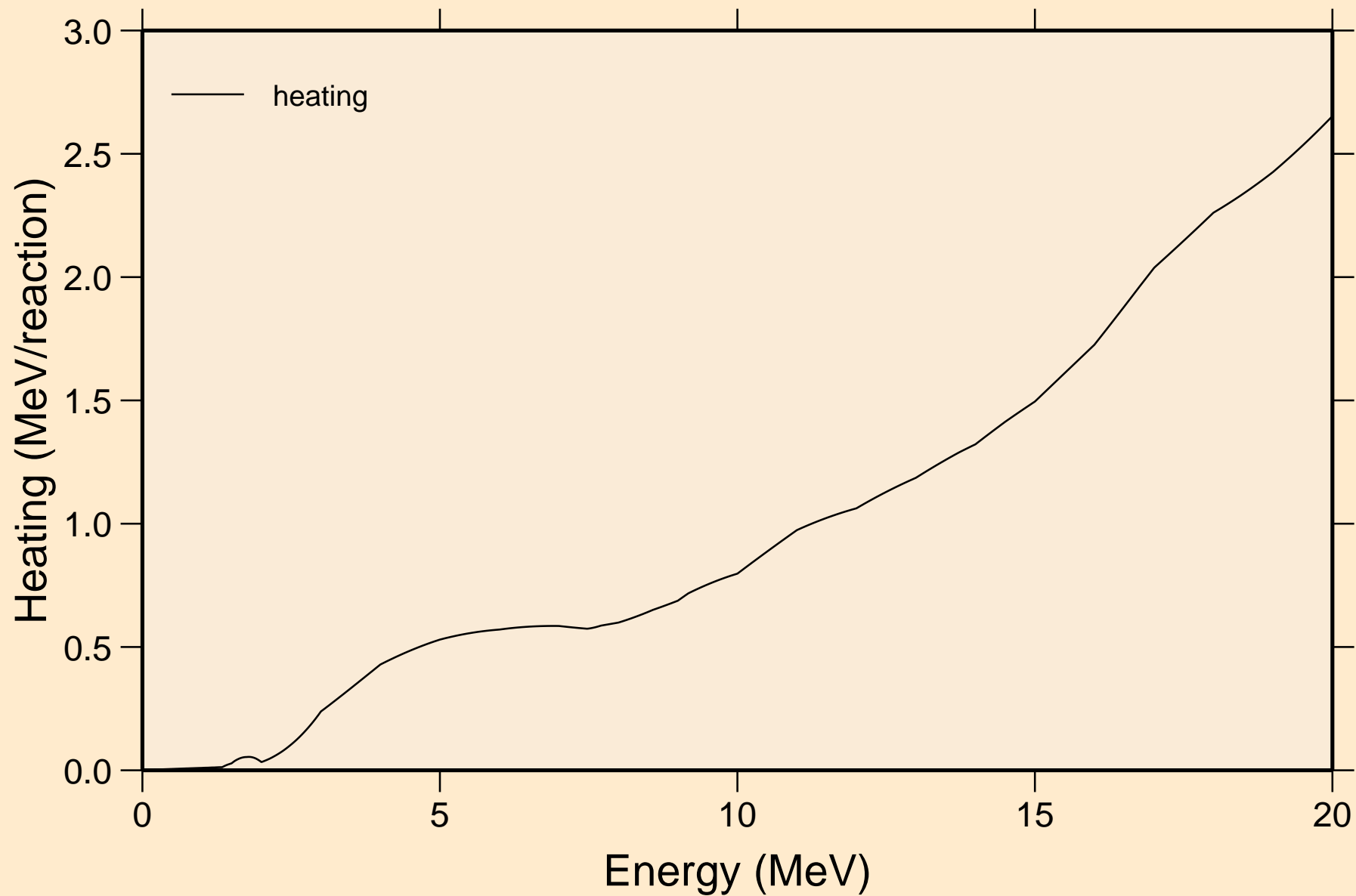

# ENDF/B-VII.1 CD-111

## Damage

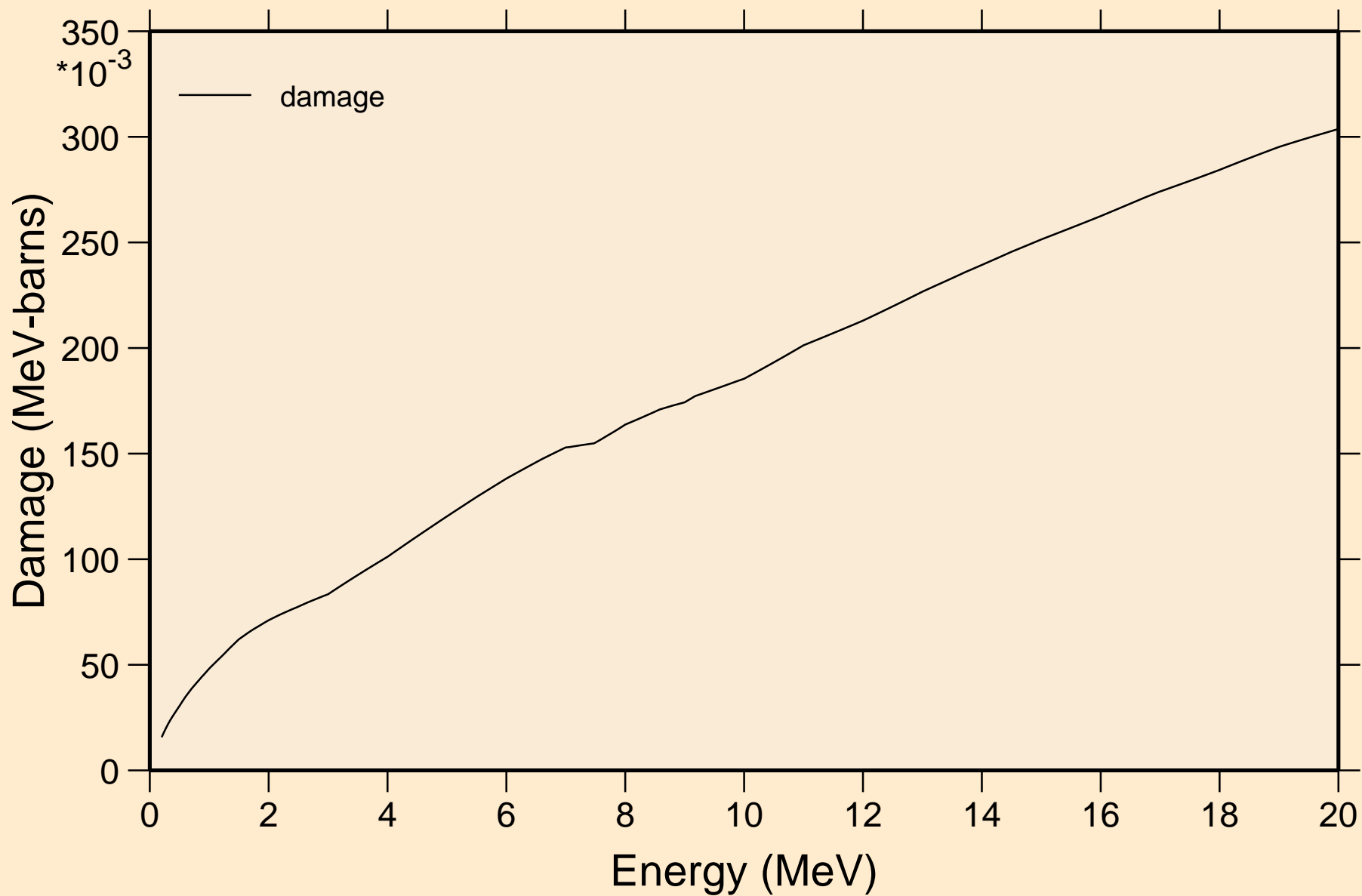

ENDF/B-VII.1 CD-111  
Non-threshold reactions

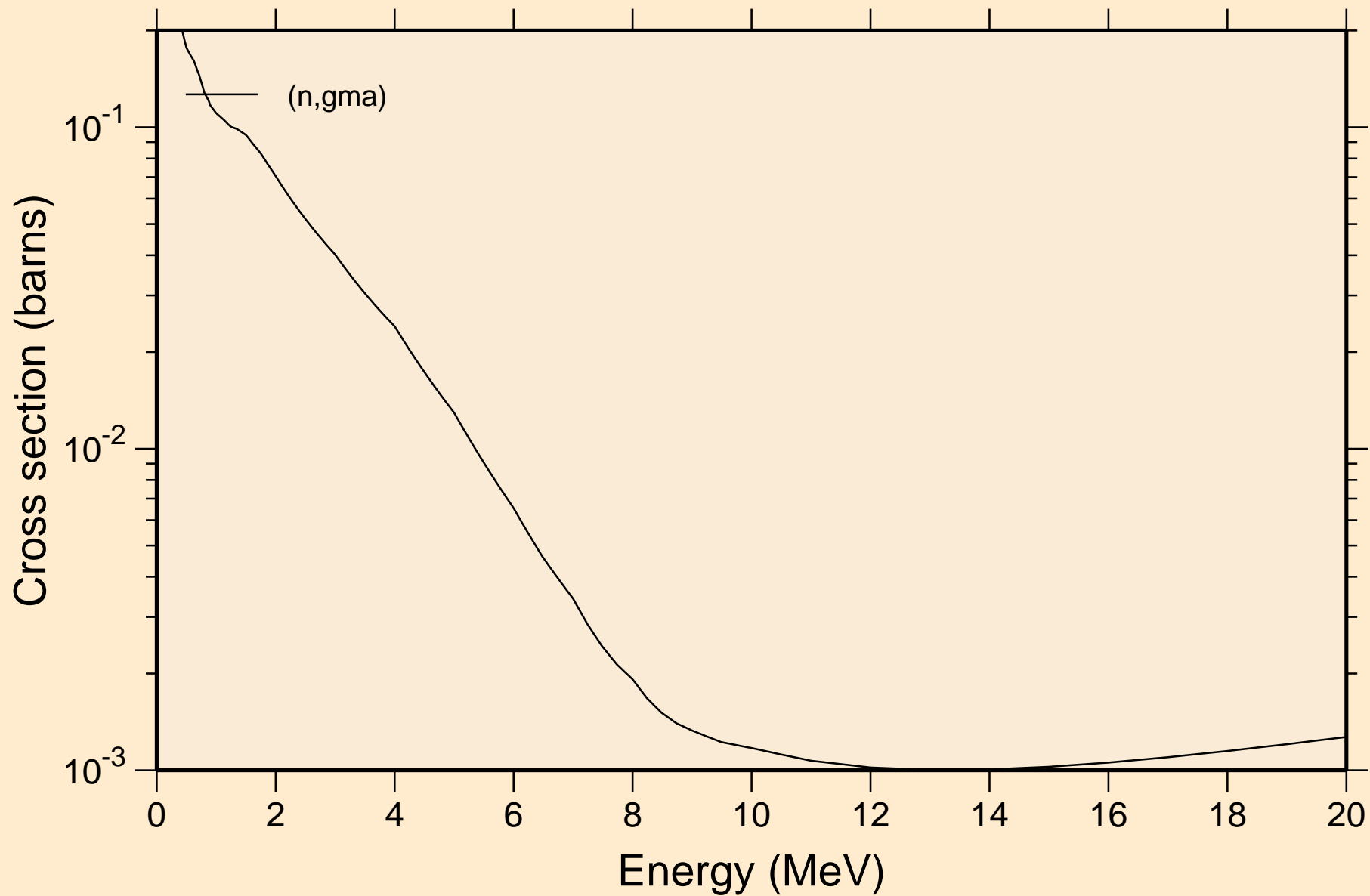

# ENDF/B-VII.1 CD-111

## Inelastic levels

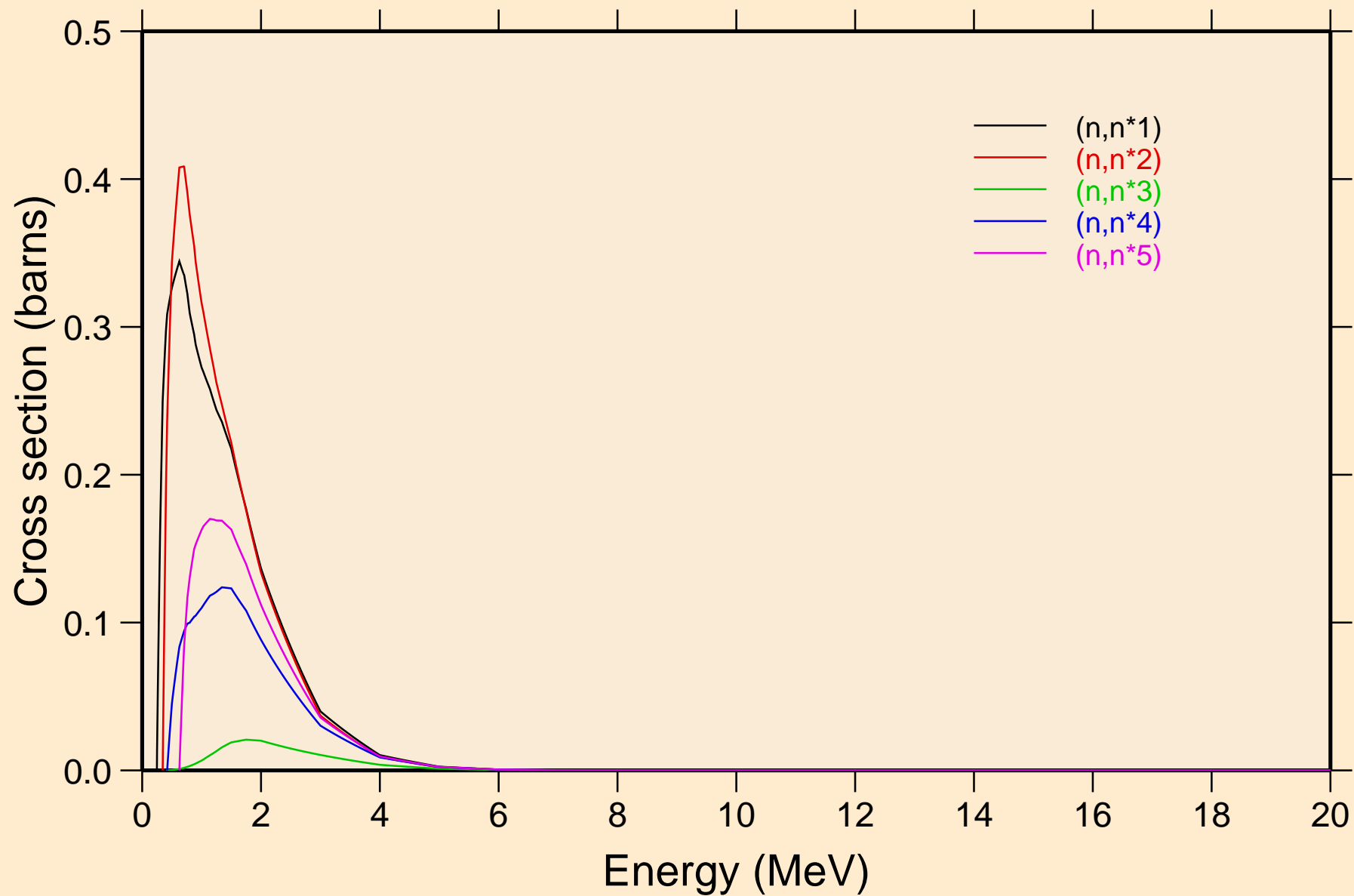



# ENDF/B-VII.1 CD-111

## Inelastic levels

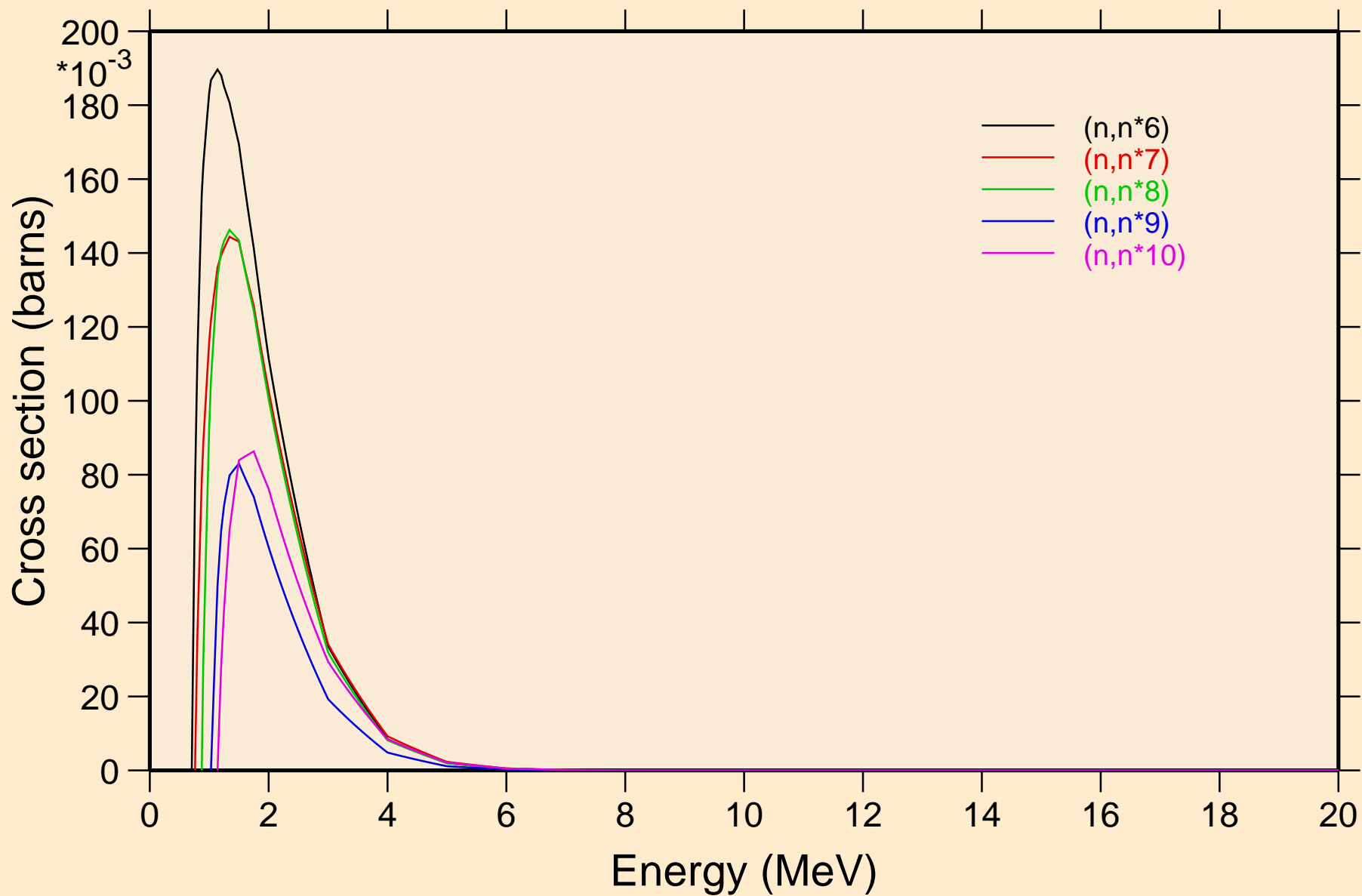

# ENDF/B-VII.1 CD-111

## Inelastic levels

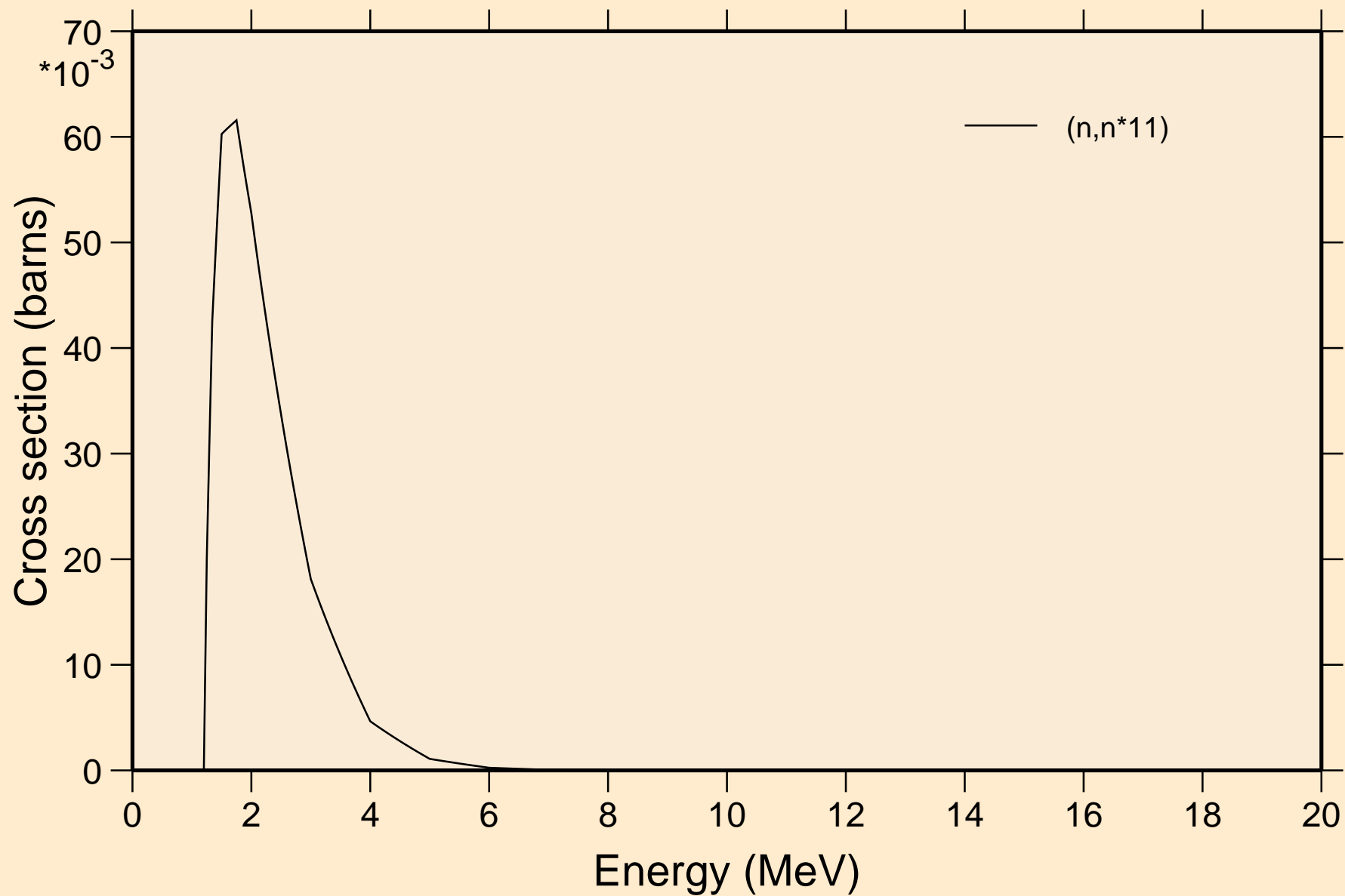

# ENDF/B-VII.1 CD-111

## Threshold reactions

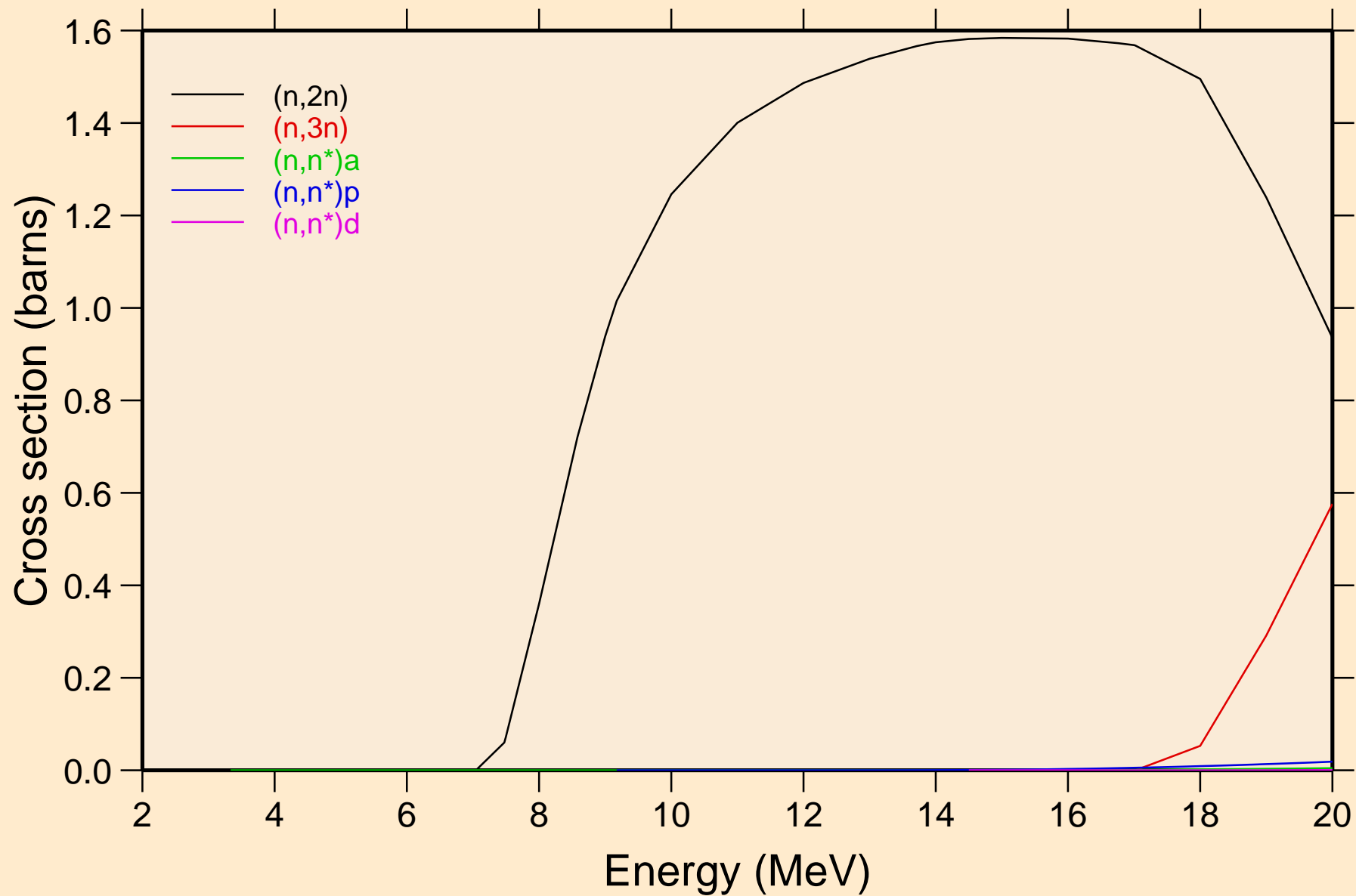

# ENDF/B-VII.1 CD-111

## Threshold reactions

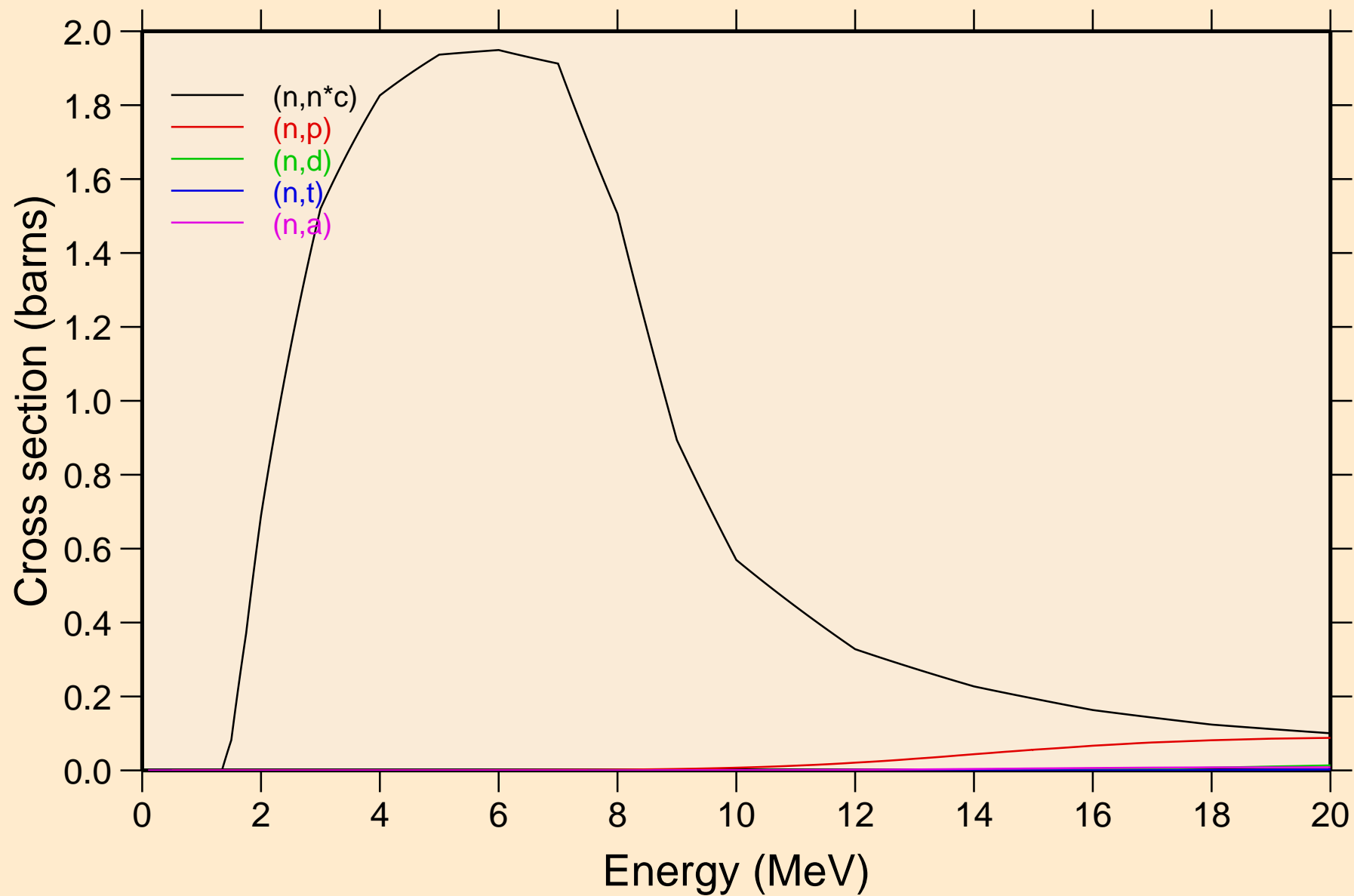

# ENDF/B-VII.1 CD-111

## Threshold reactions

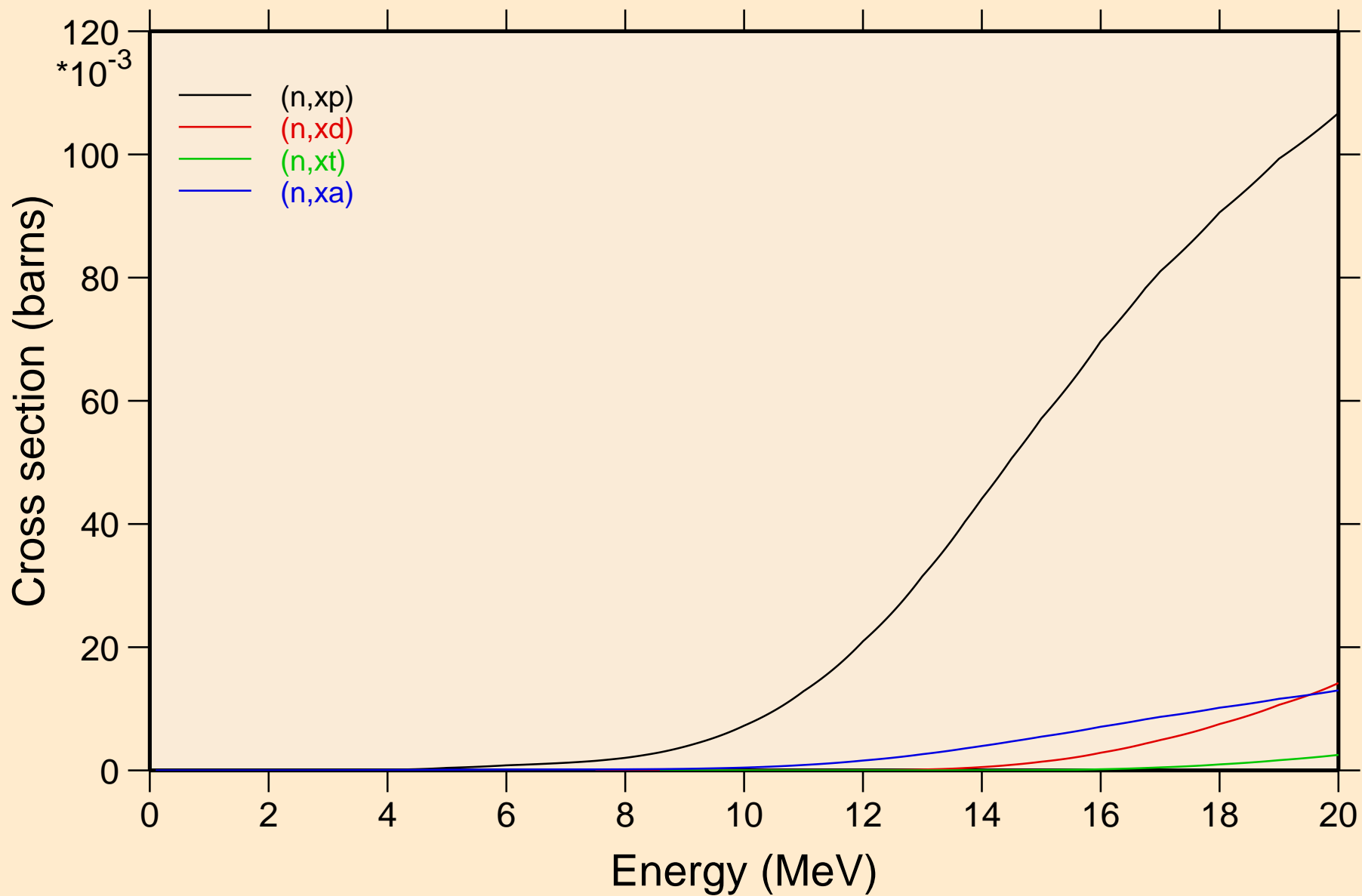

ENDF/B-VII.1 CD-111  
angular distribution for elastic

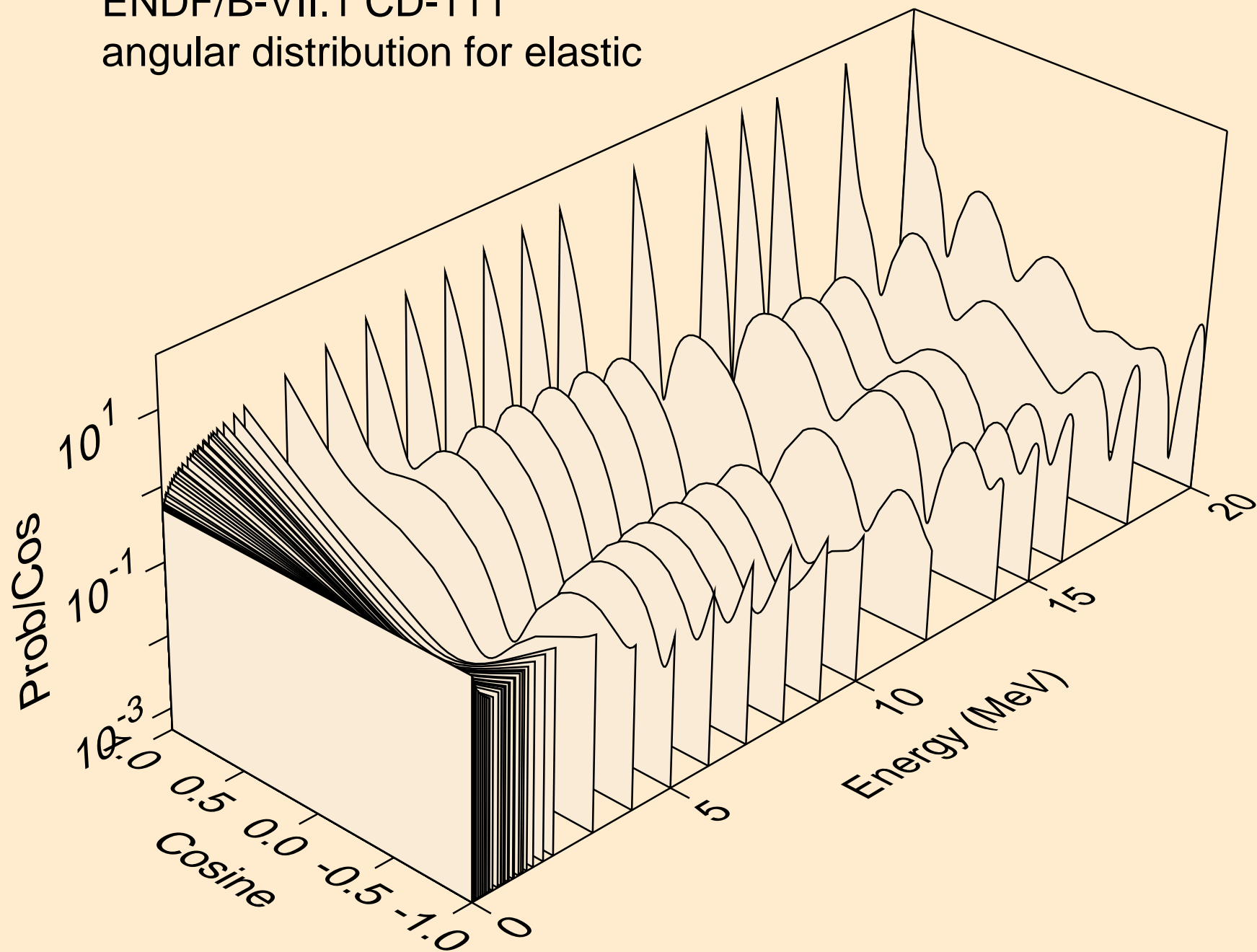

ENDF/B-VII.1 CD-111  
angular distribution for (n,2n)

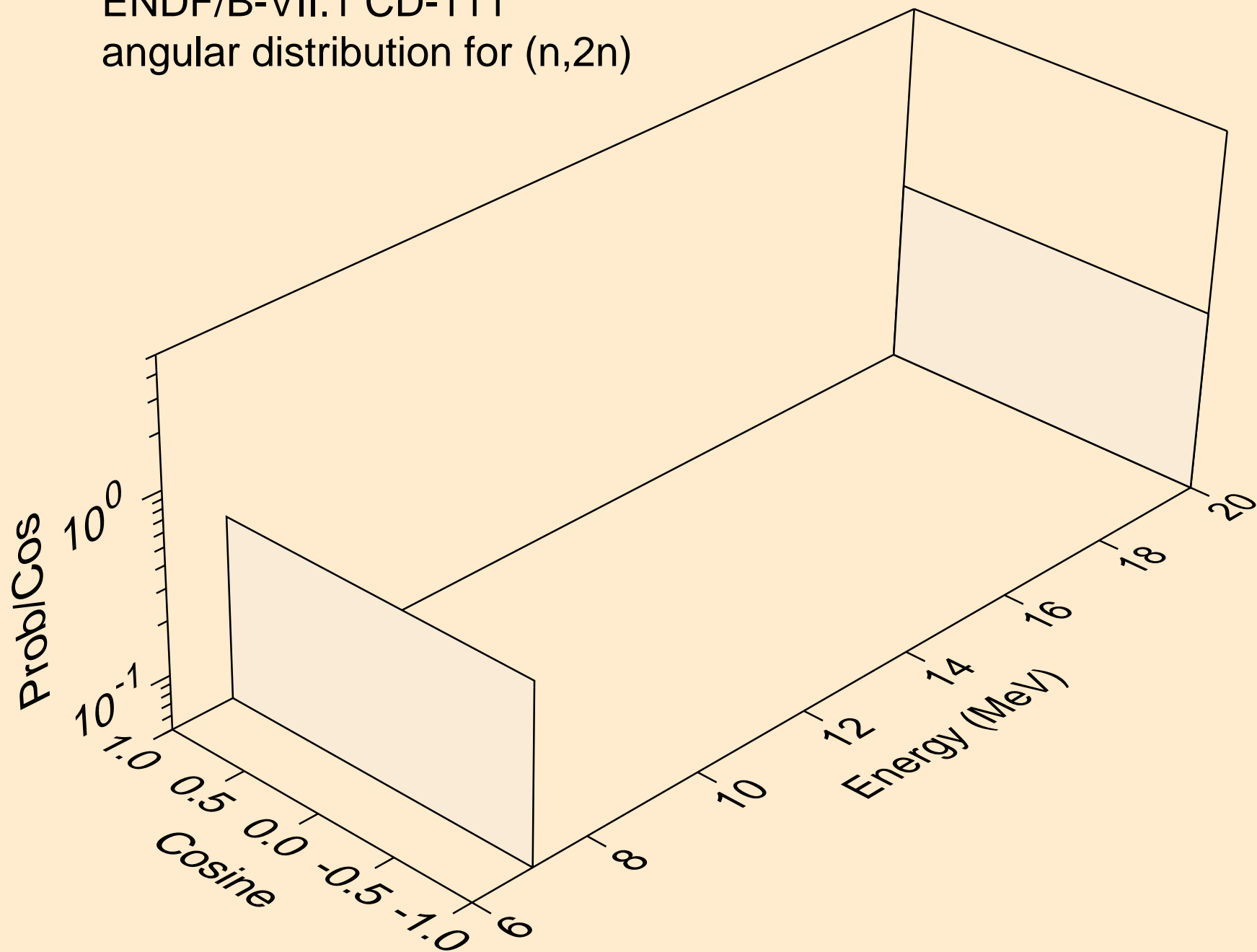

ENDF/B-VII.1 CD-111  
angular distribution for (n,3n)

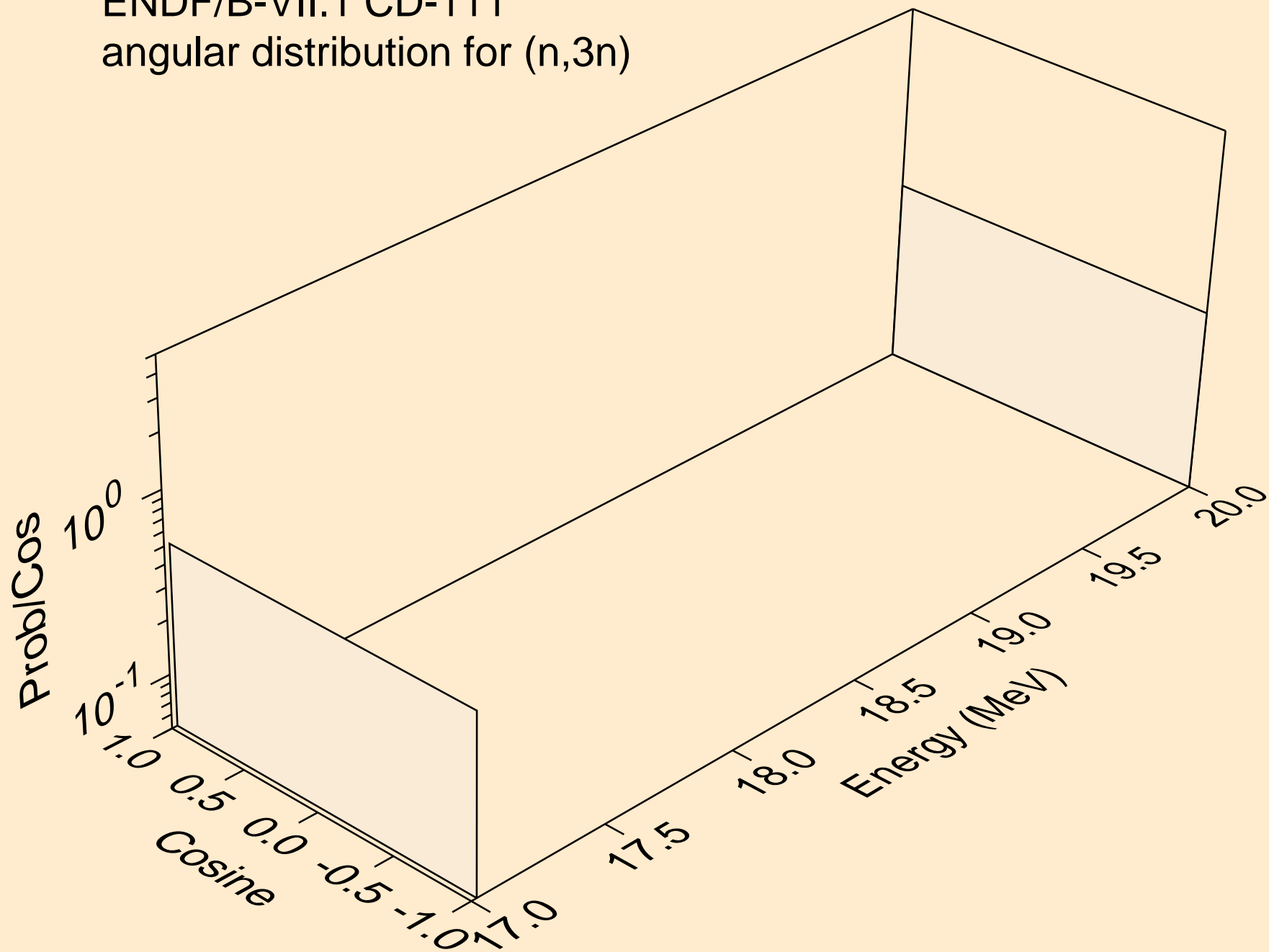



ENDF/B-VII.1 CD-111  
angular distribution for (n,n\*)a

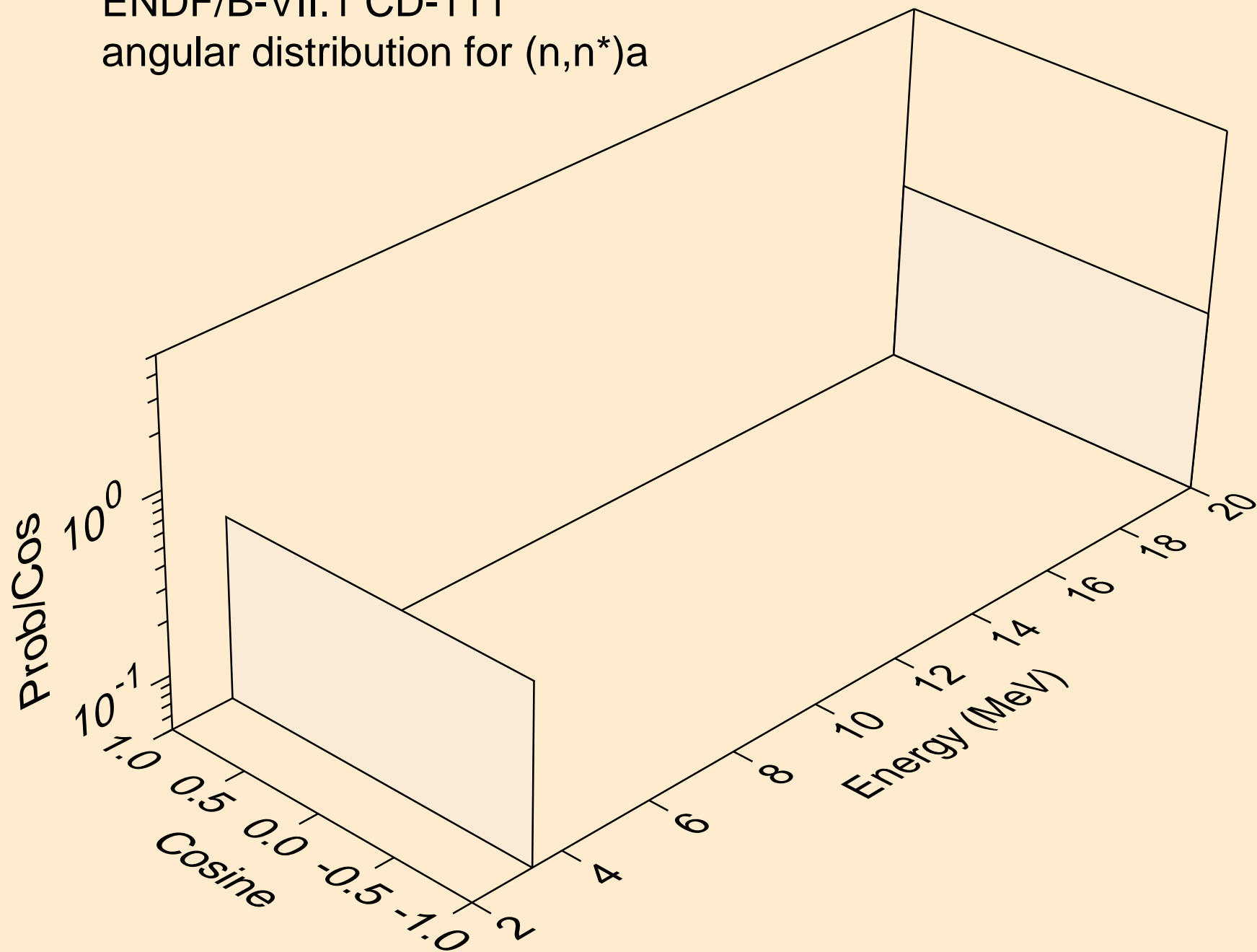

ENDF/B-VII.1 CD-111  
angular distribution for (n,n\*)p

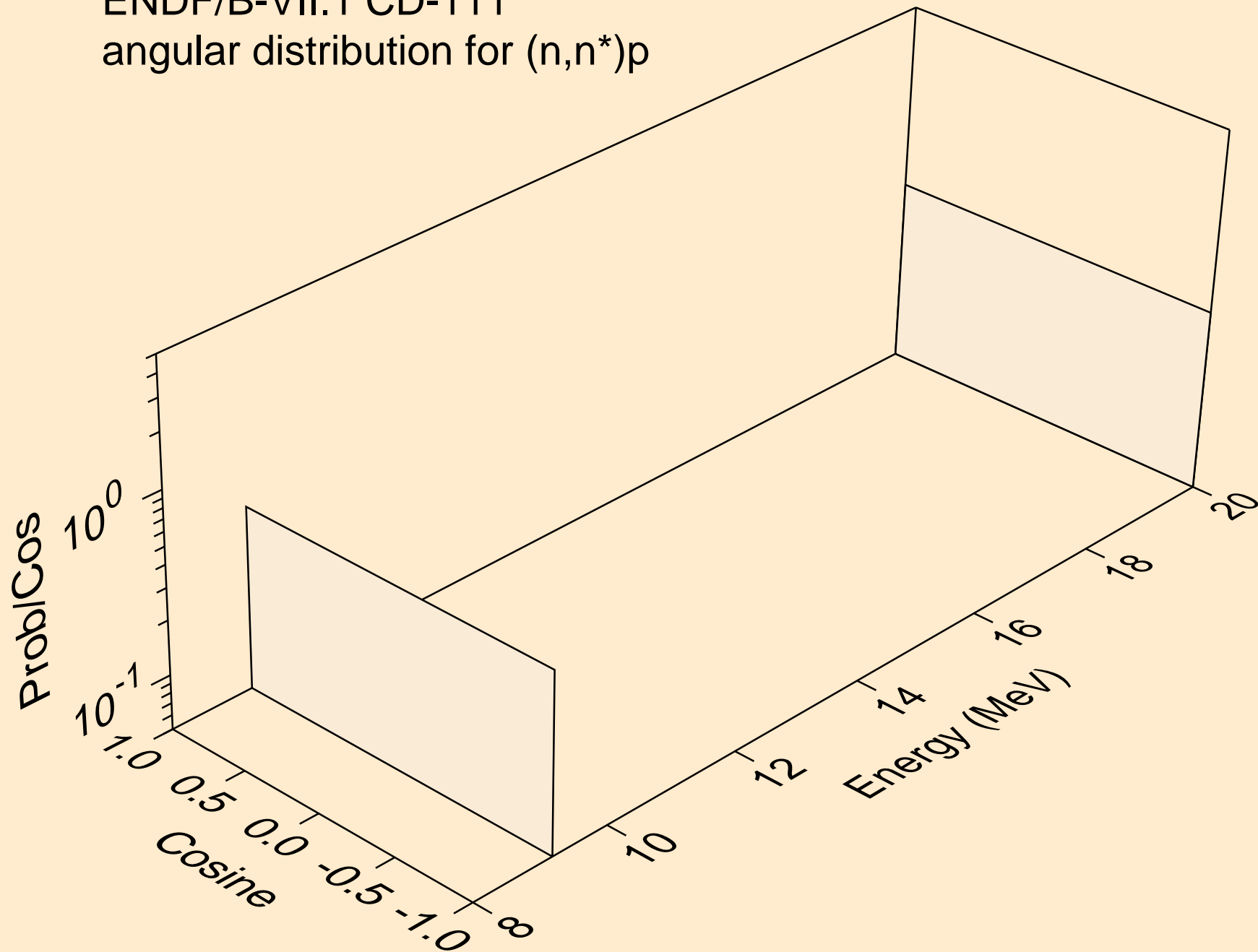

ENDF/B-VII.1 CD-111  
angular distribution for (n,n\*)d

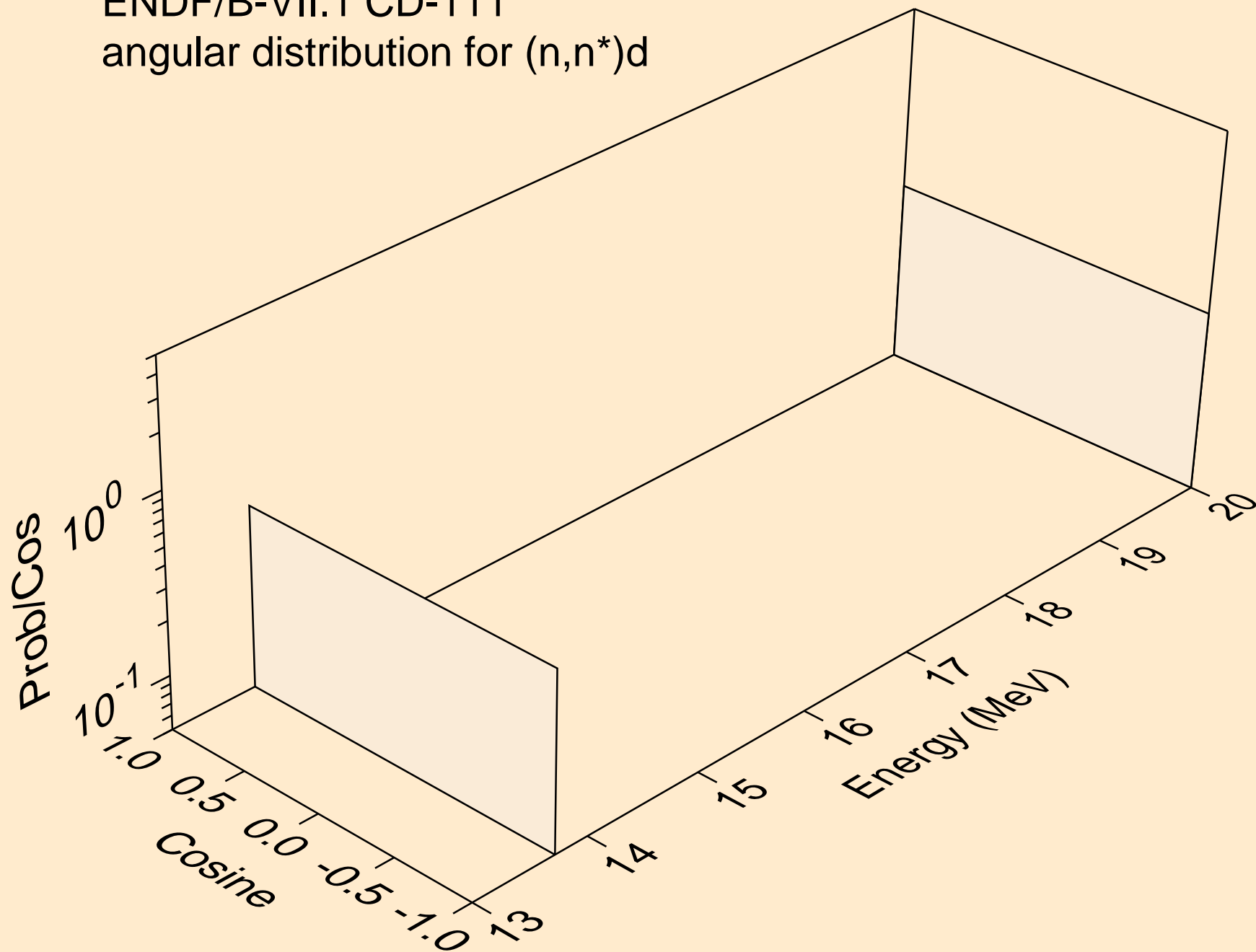

ENDF/B-VII.1 CD-111  
angular distribution for (n,n\*1)

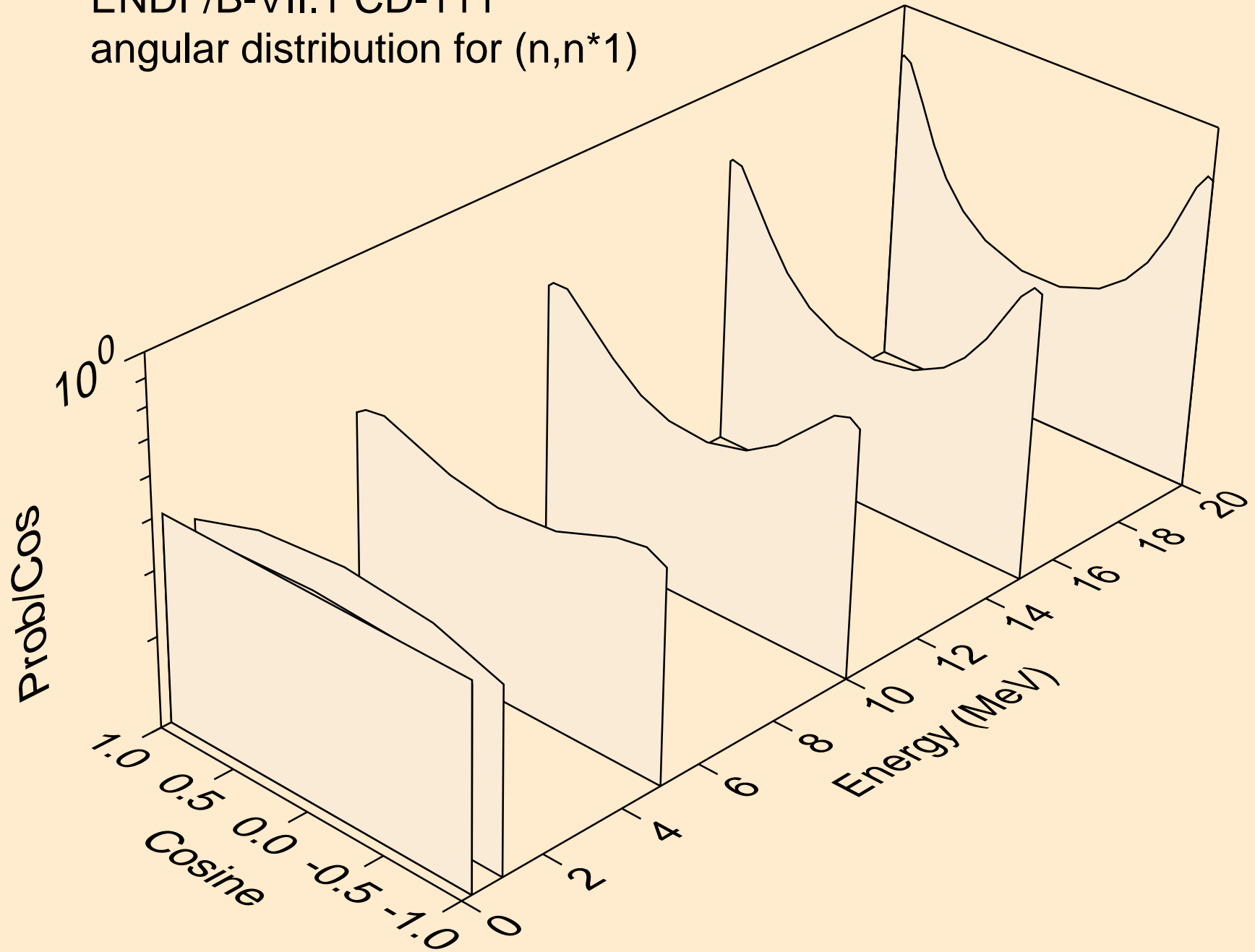

ENDF/B-VII.1 CD-111  
angular distribution for (n,n\*2)

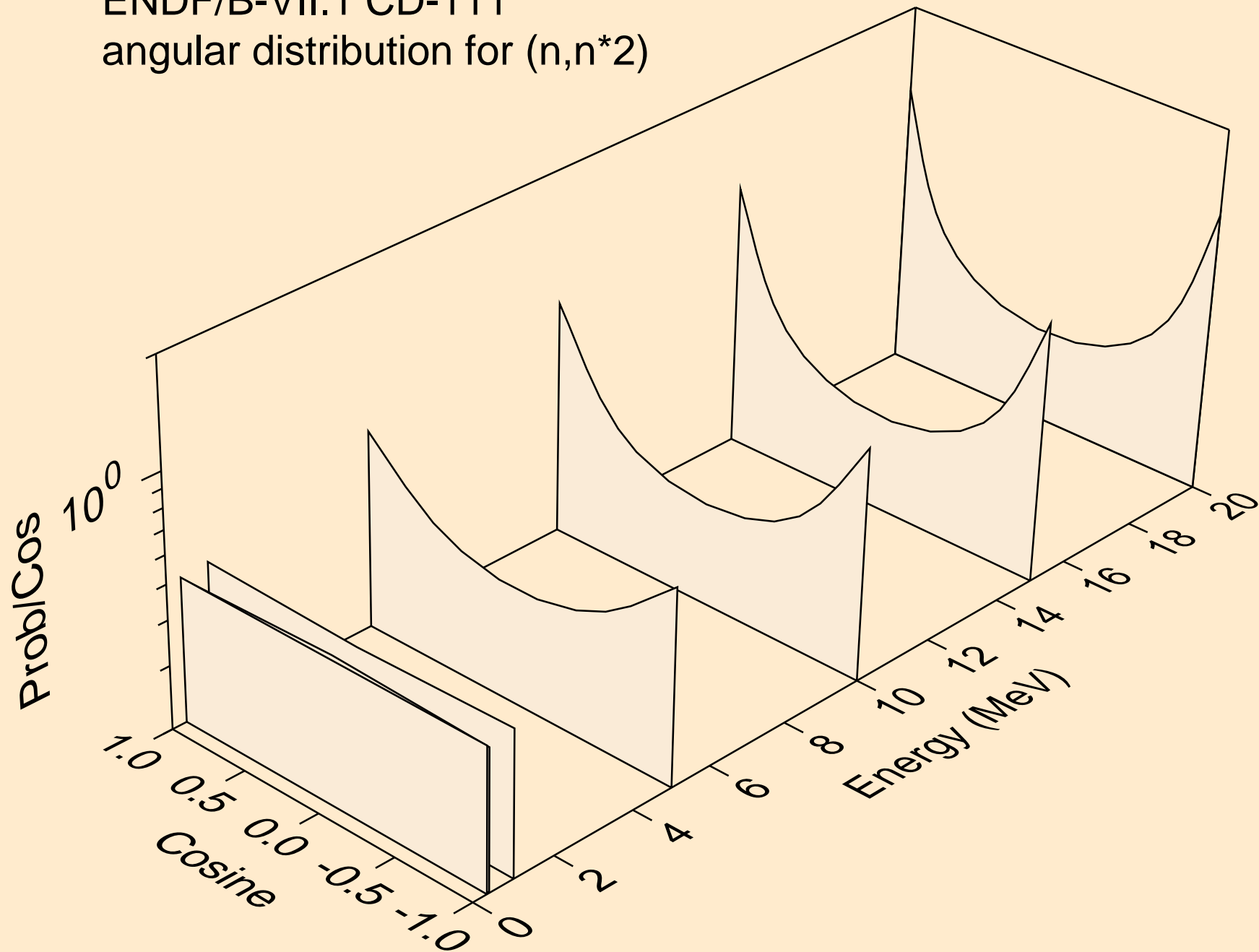

ENDF/B-VII.1 CD-111  
angular distribution for (n,n\*3)

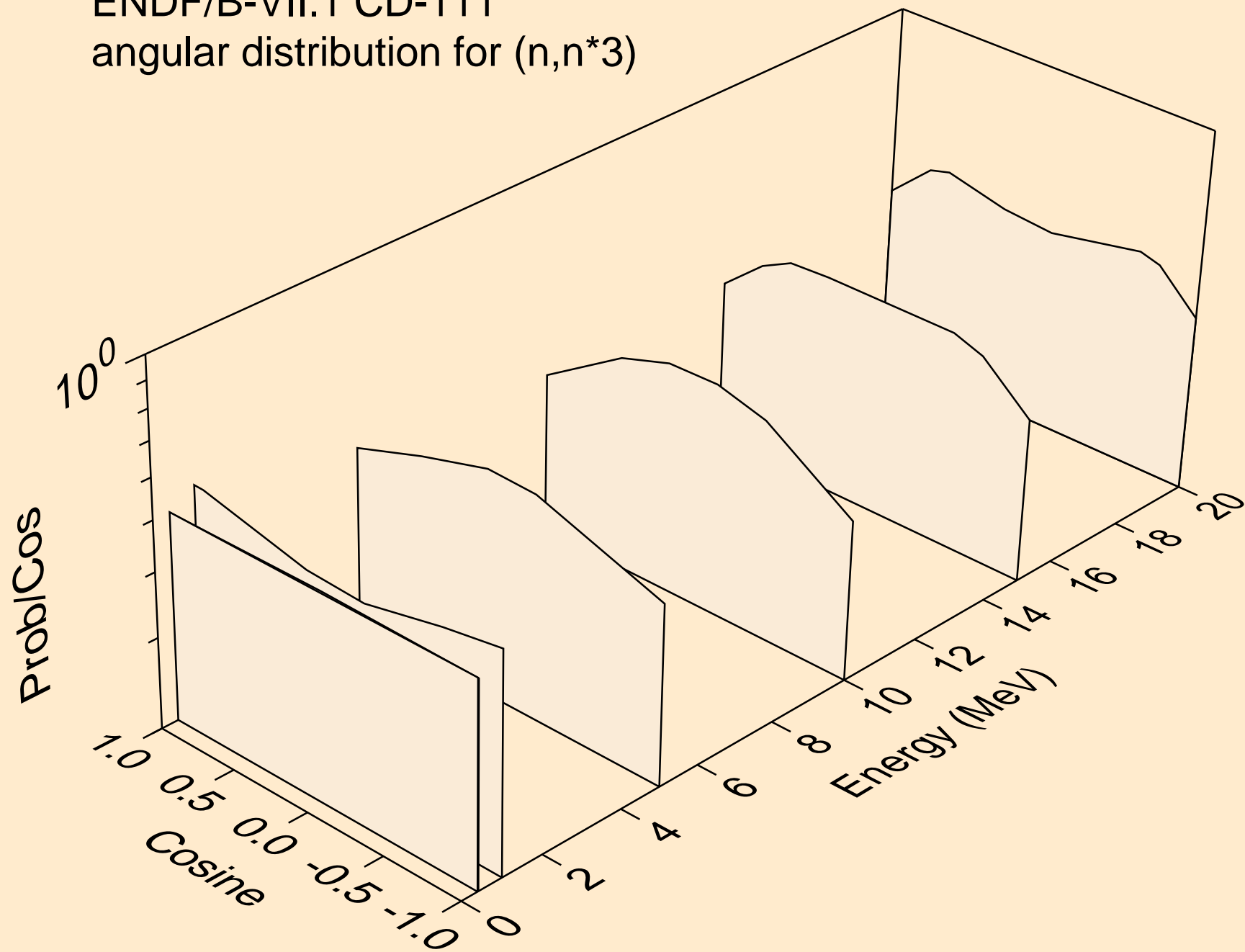

ENDF/B-VII.1 CD-111  
angular distribution for (n,n\*4)

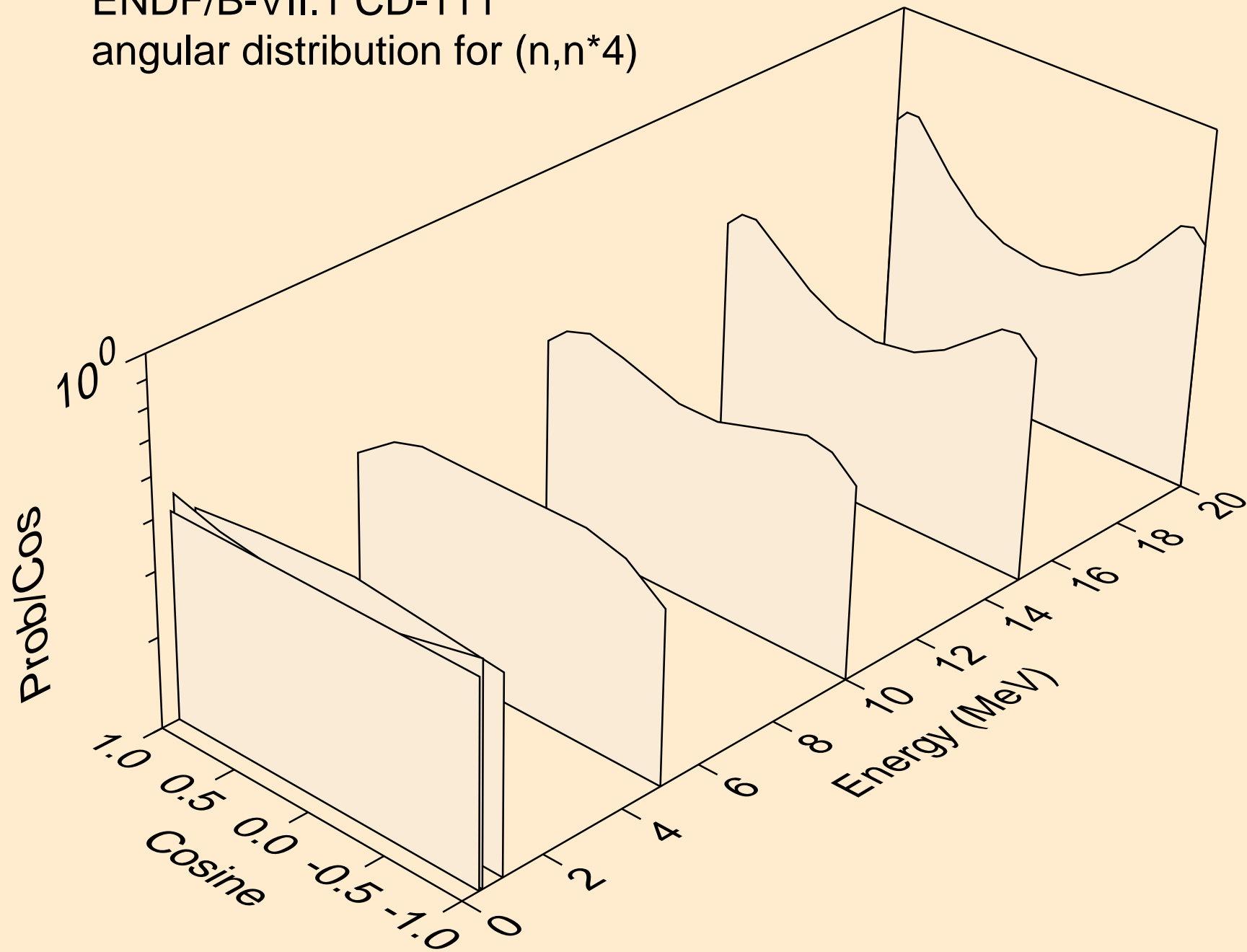

ENDF/B-VII.1 CD-111  
angular distribution for (n,n\*5)

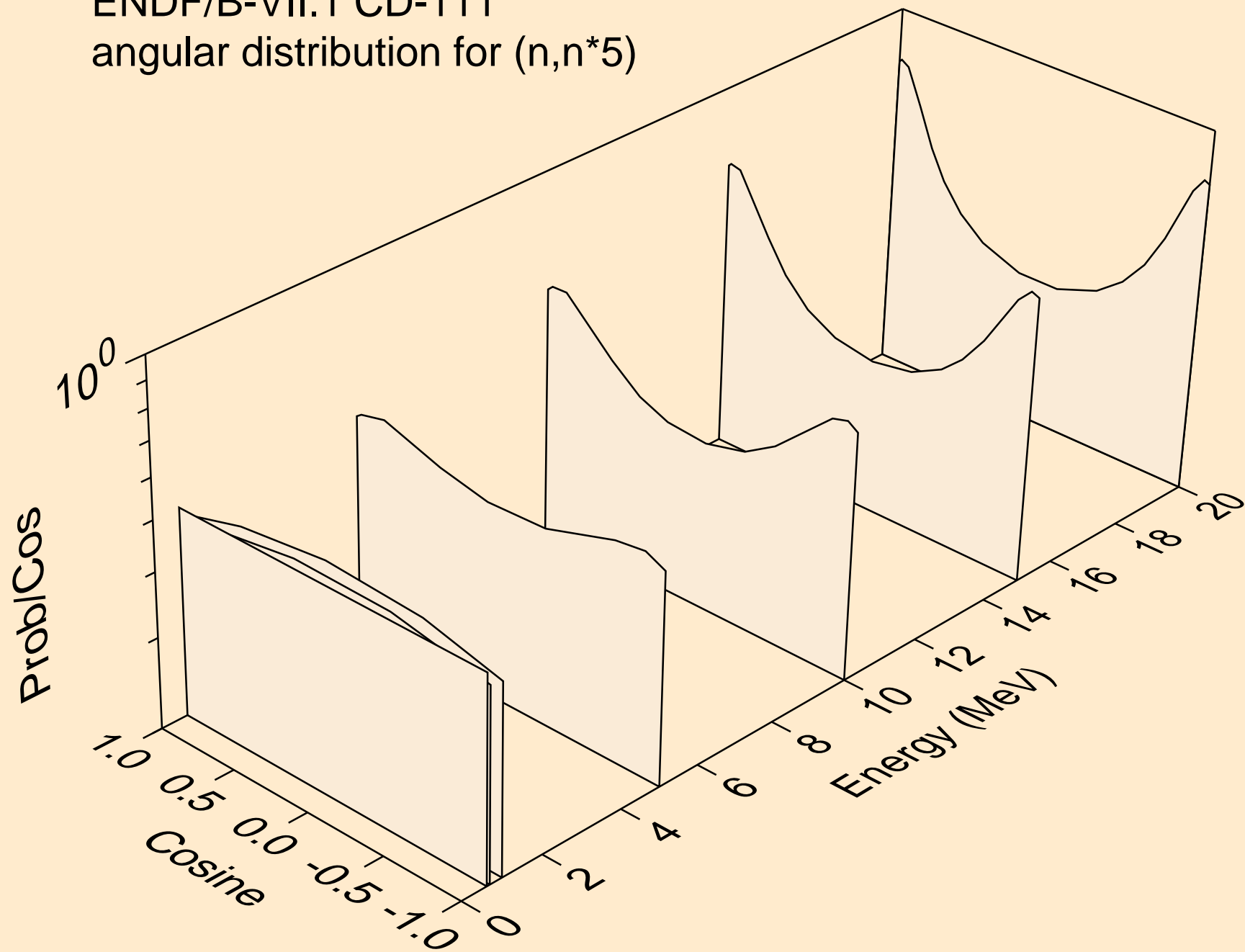



ENDF/B-VII.1 CD-111  
angular distribution for (n,n\*6)

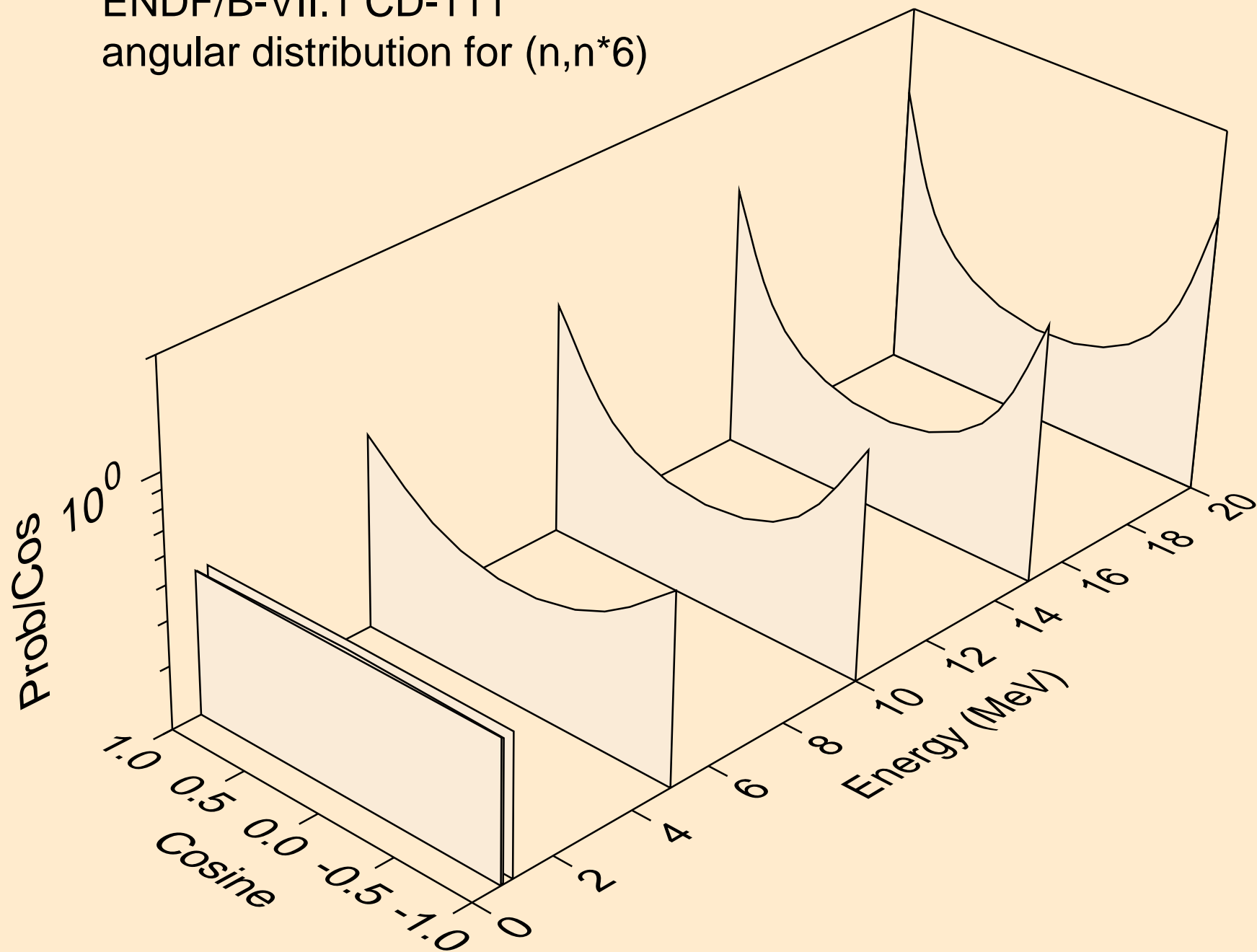

ENDF/B-VII.1 CD-111  
angular distribution for (n,n\*7)

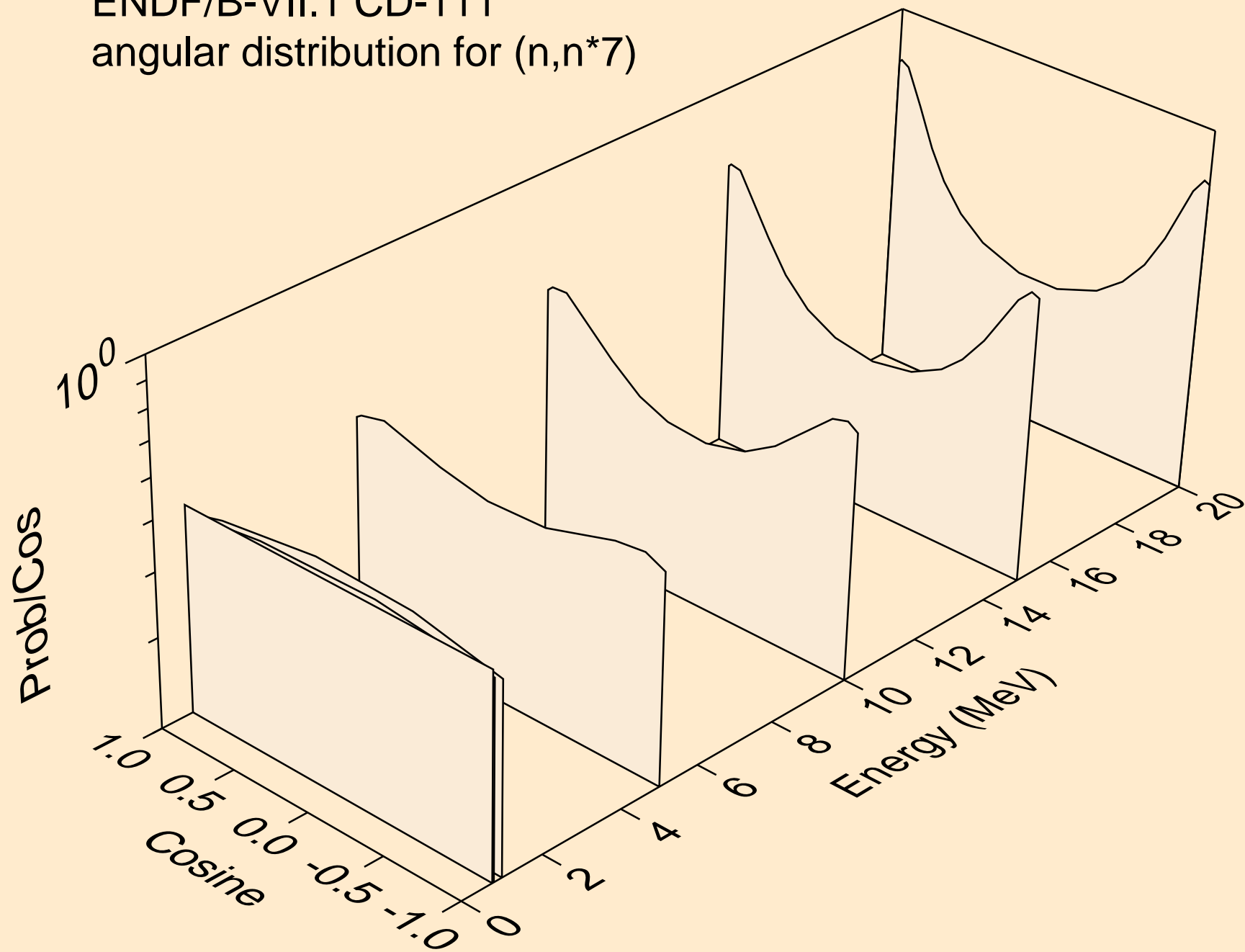

ENDF/B-VII.1 CD-111  
angular distribution for (n,n\*8)

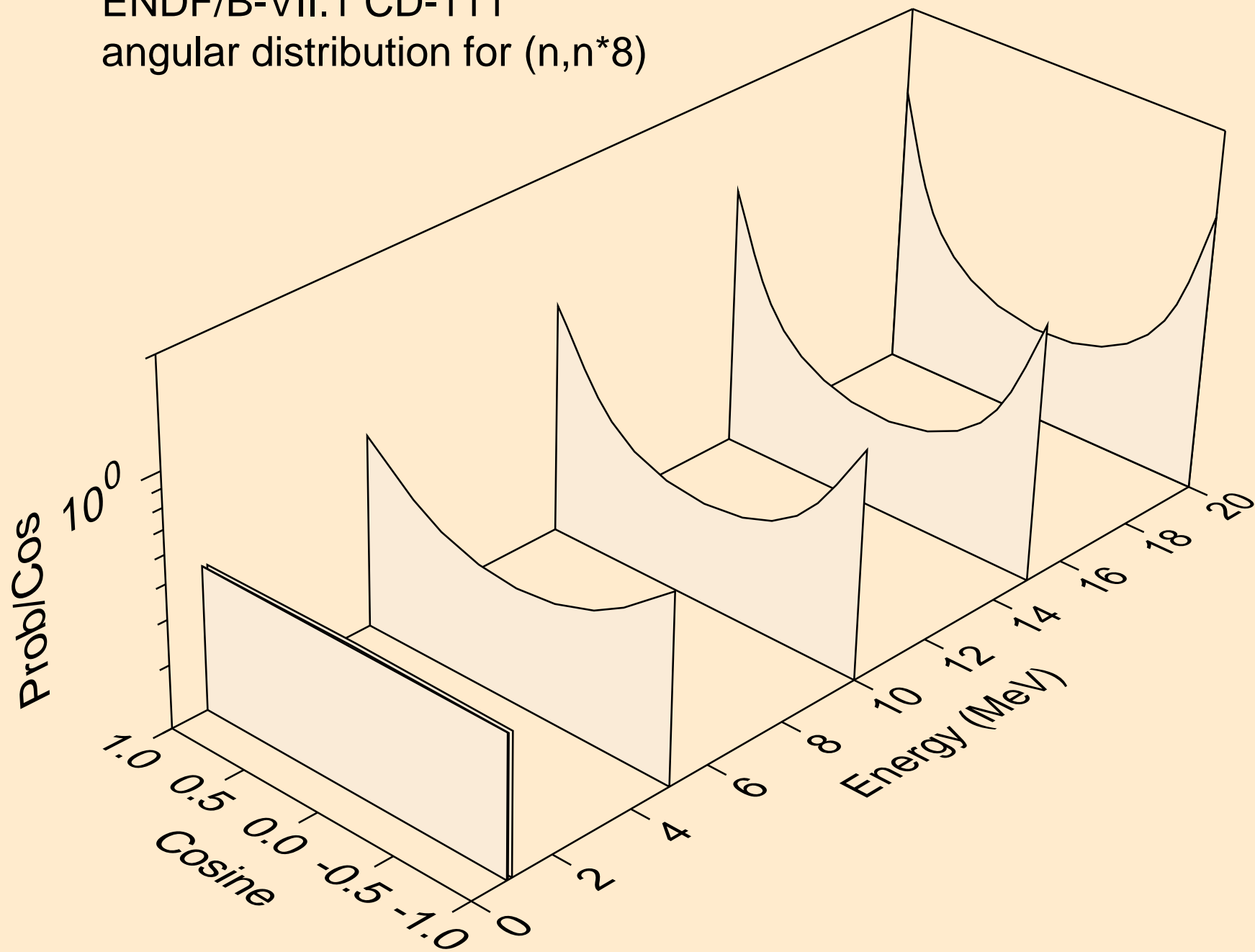

ENDF/B-VII.1 CD-111  
angular distribution for (n,n\*9)

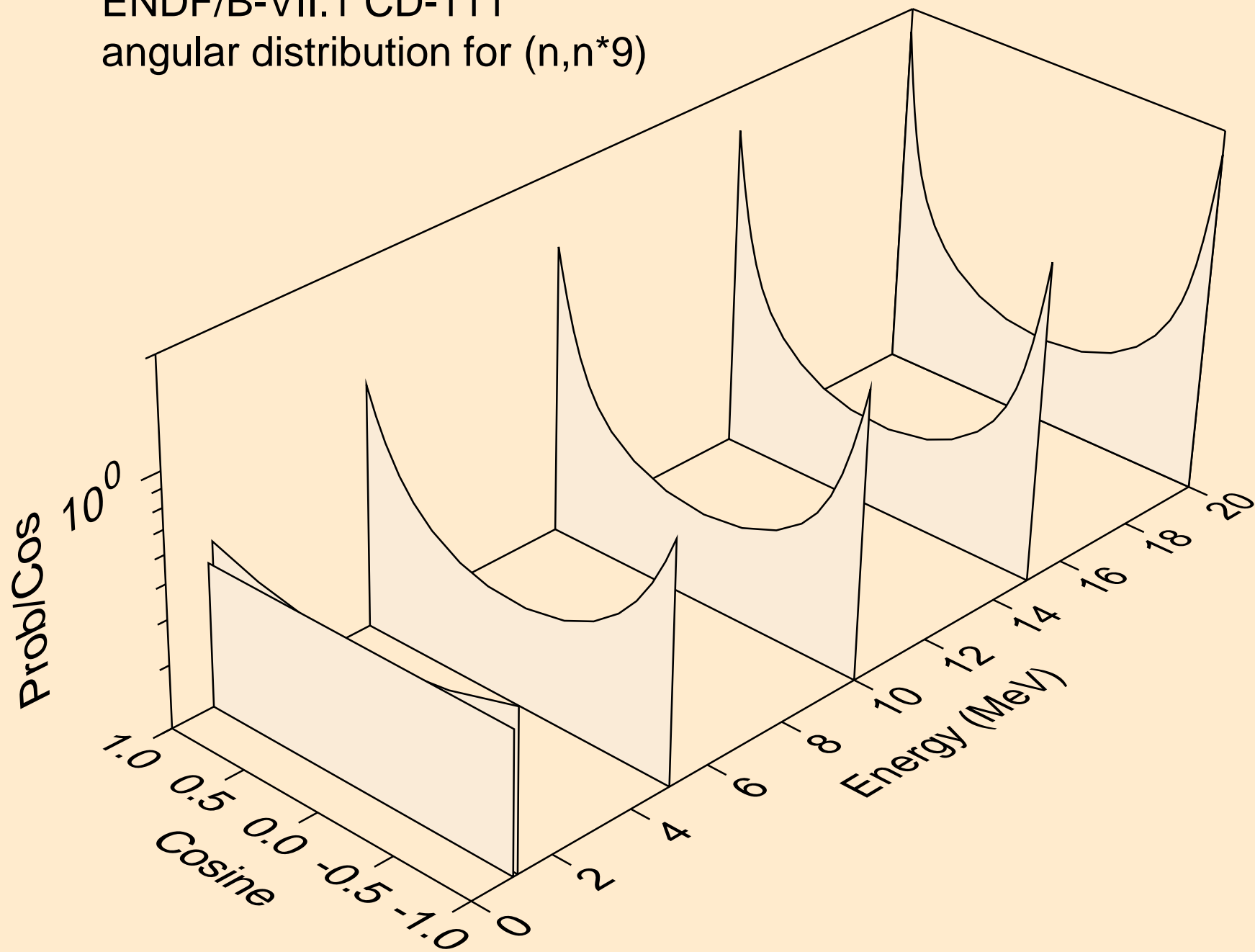

ENDF/B-VII.1 CD-111  
angular distribution for (n,n\*10)

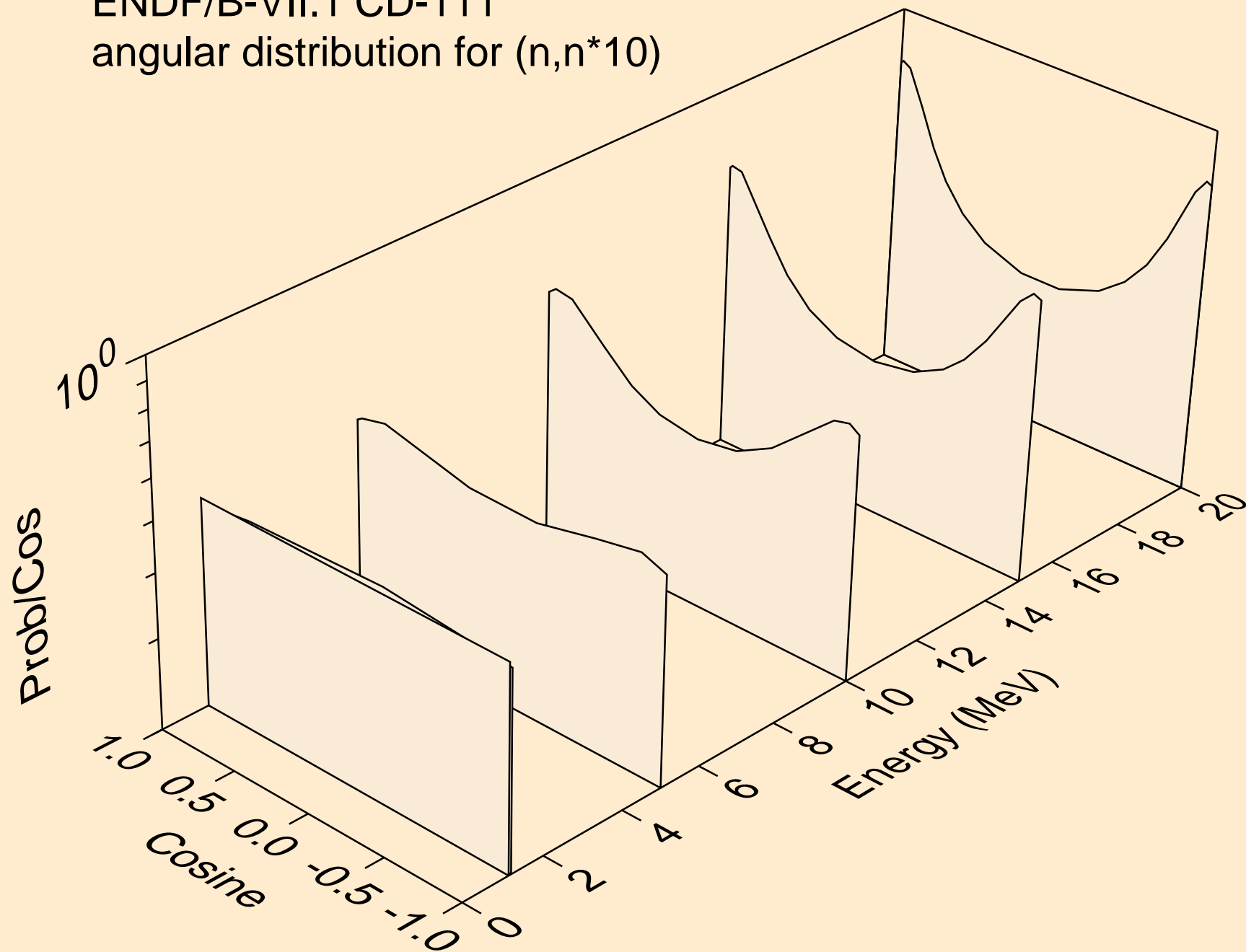

ENDF/B-VII.1 CD-111  
angular distribution for (n,n\*11)

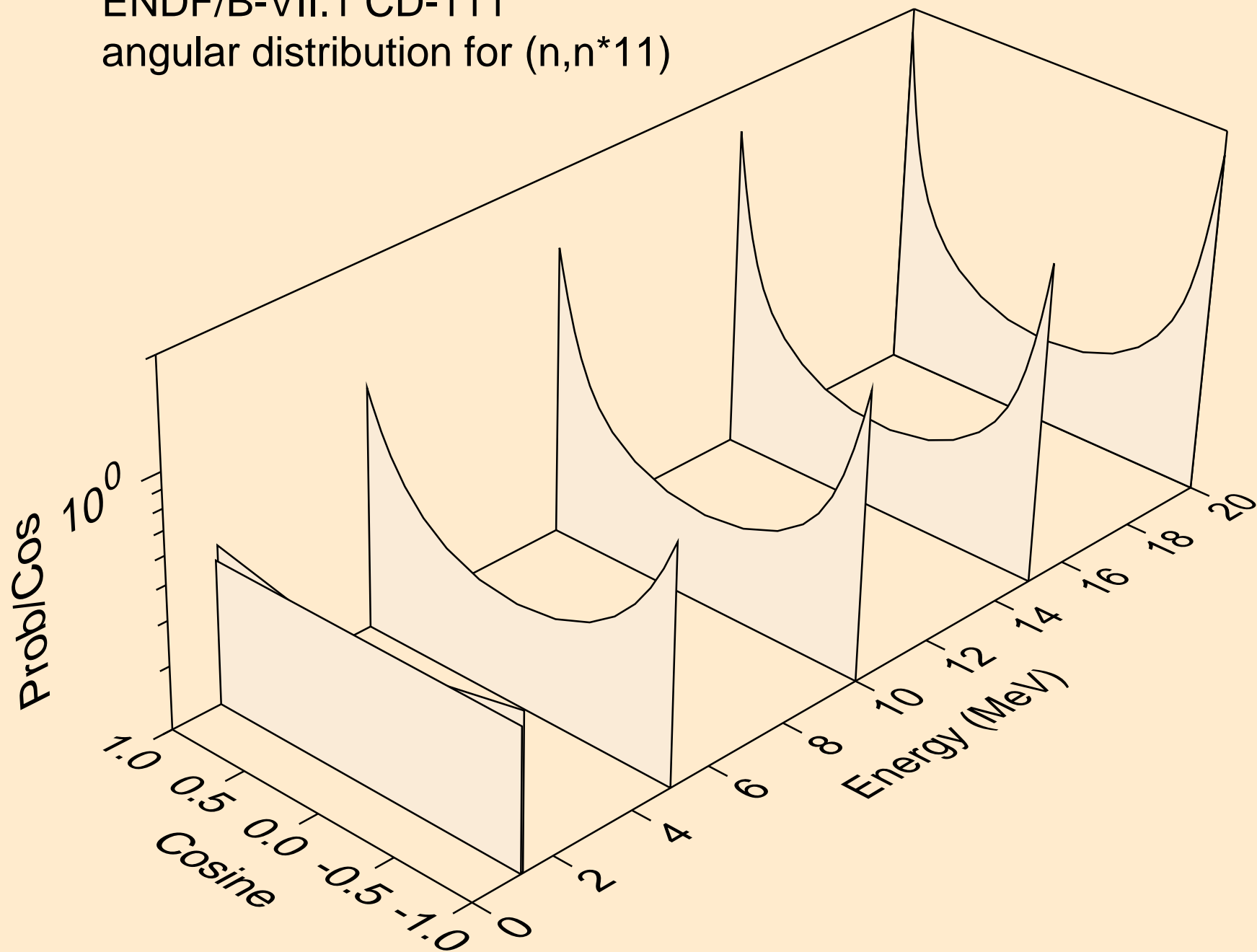

ENDF/B-VII.1 CD-111  
angular distribution for (n,n\*c)

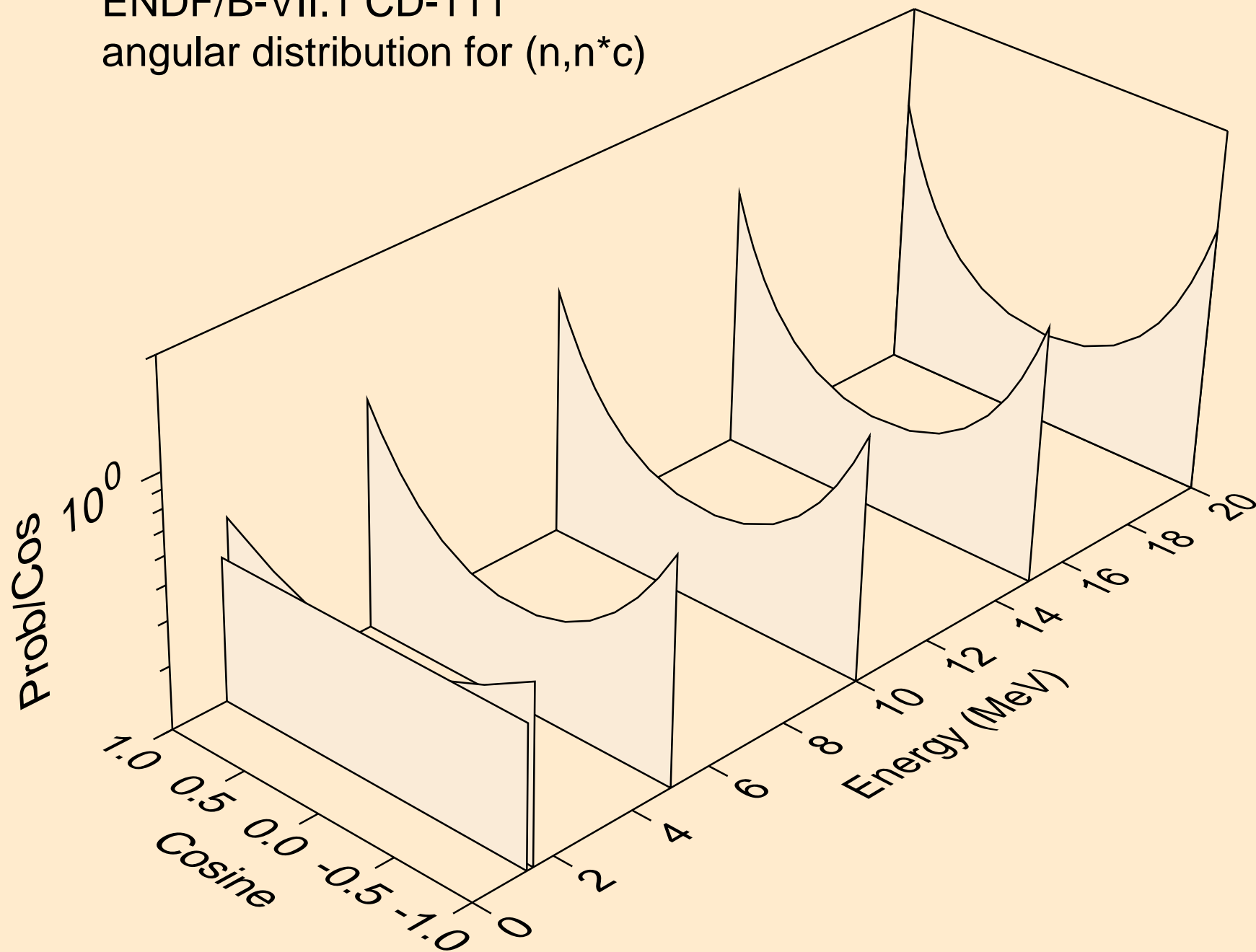

ENDF/B-VII.1 CD-111  
Neutron emission for (n,2n)

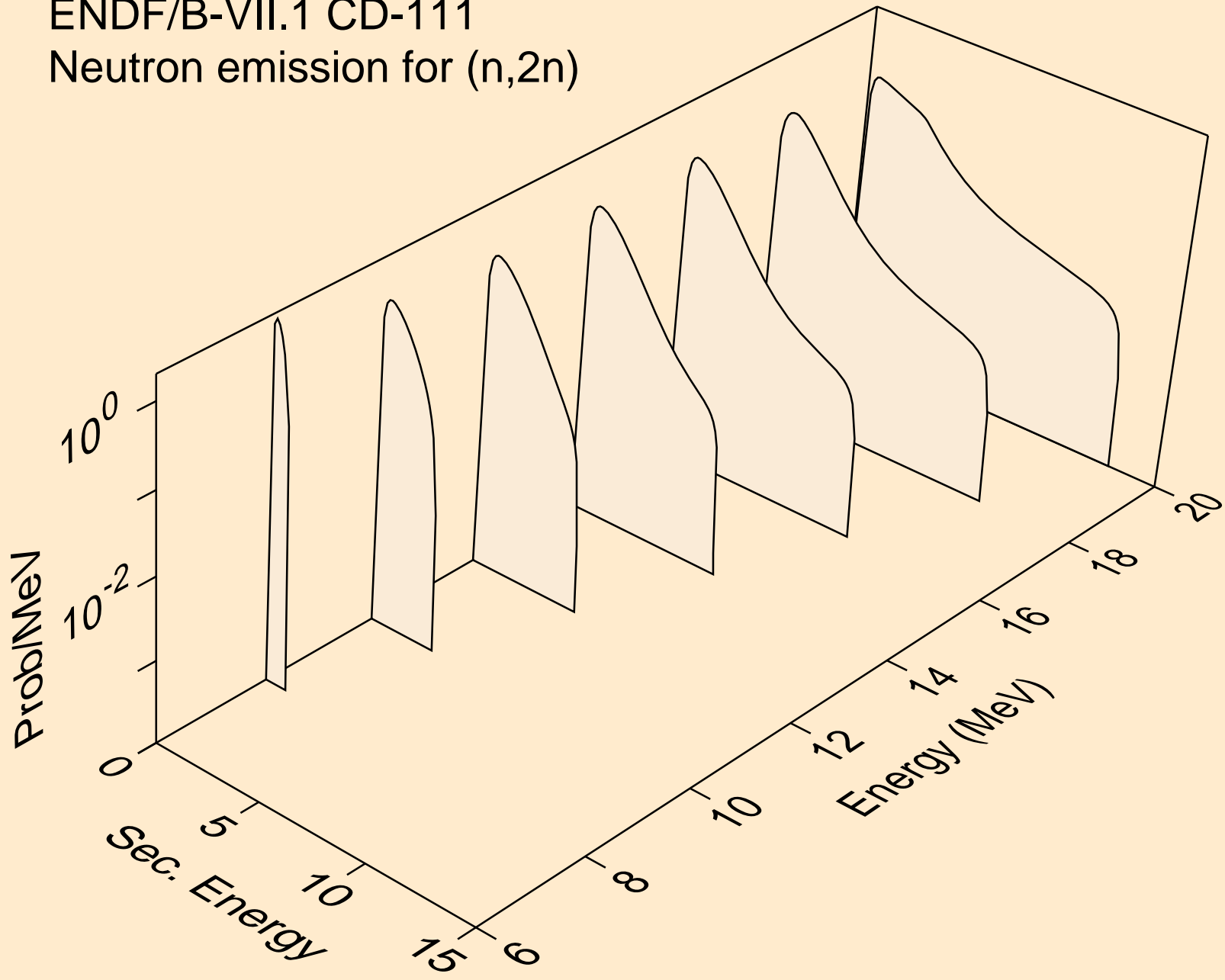



ENDF/B-VII.1 CD-111  
Neutron emission for (n,3n)

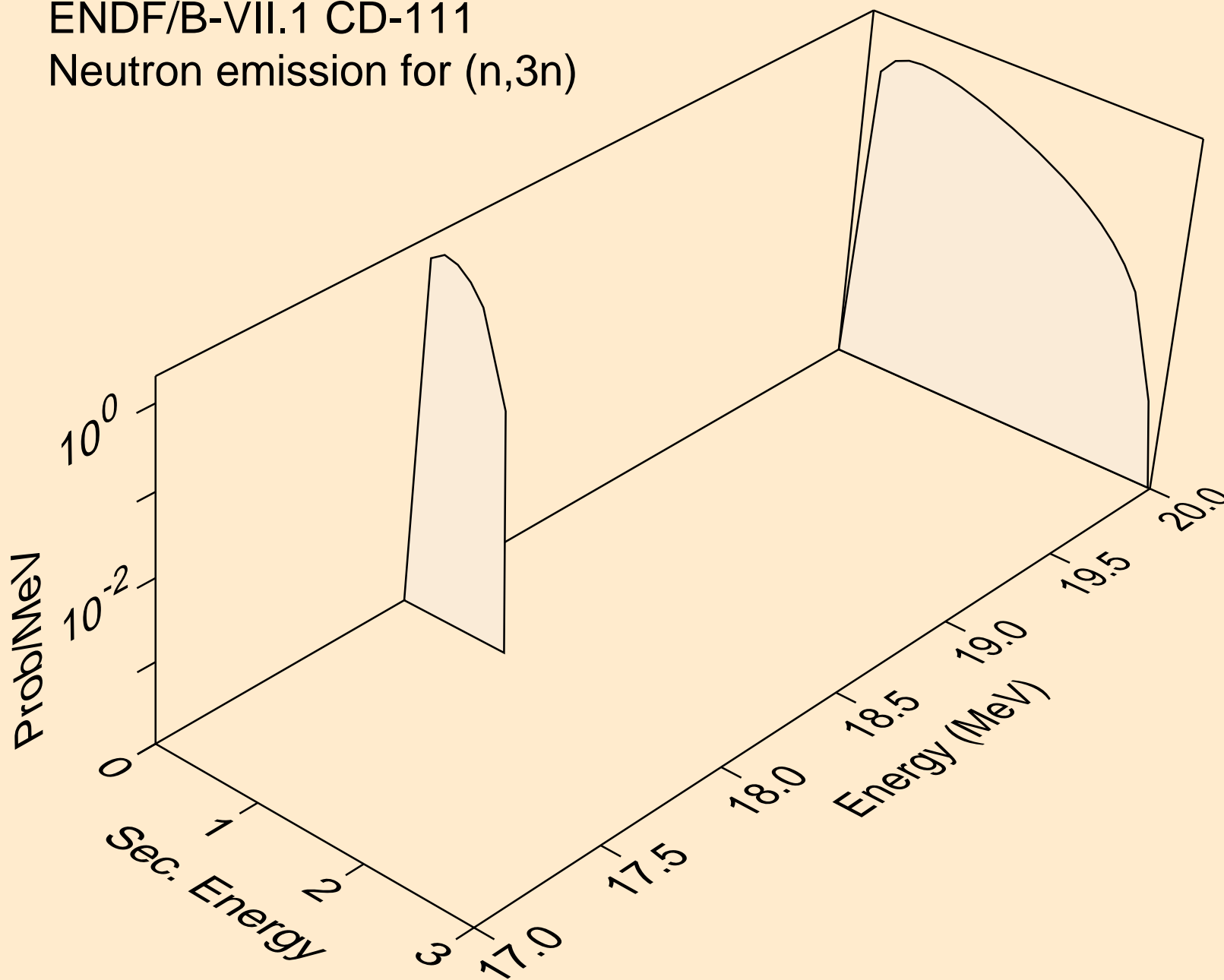

ENDF/B-VII.1 CD-111  
Neutron emission for (n,n\*)a

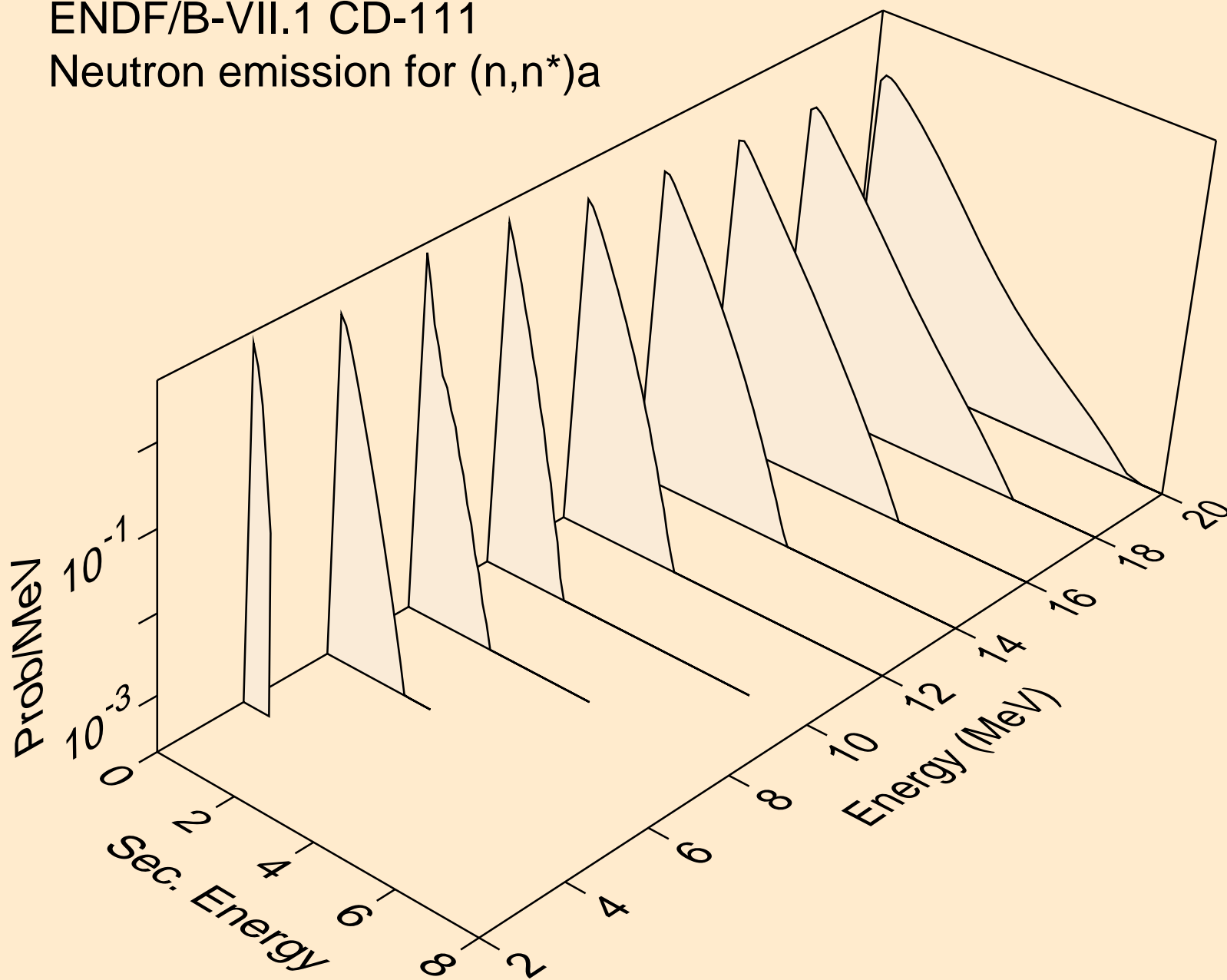

ENDF/B-VII.1 CD-111  
Neutron emission for (n,n\*)p

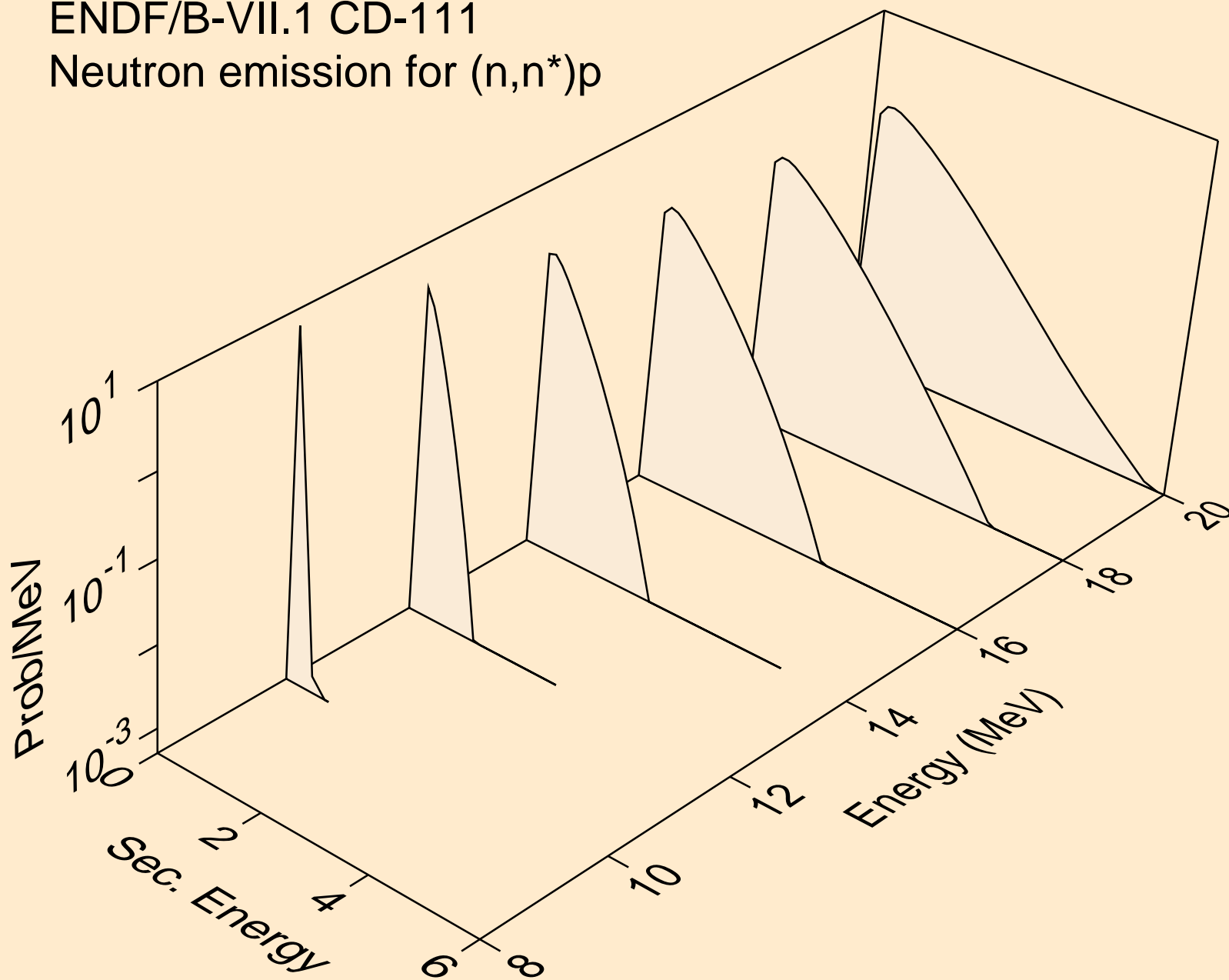

ENDF/B-VII.1 CD-111  
Neutron emission for (n,n\*)d

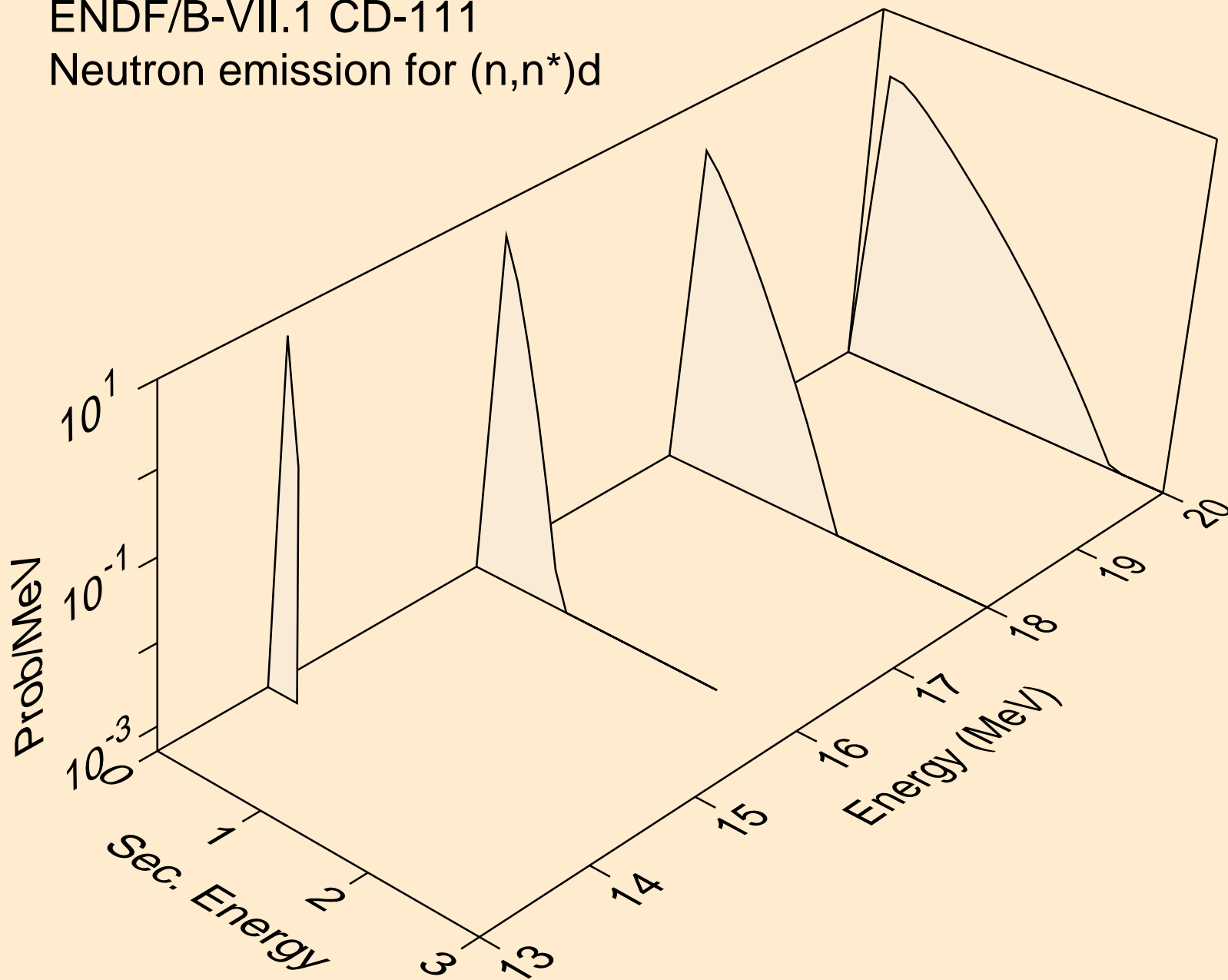

ENDF/B-VII.1 CD-111  
Neutron emission for (n,n\*c)

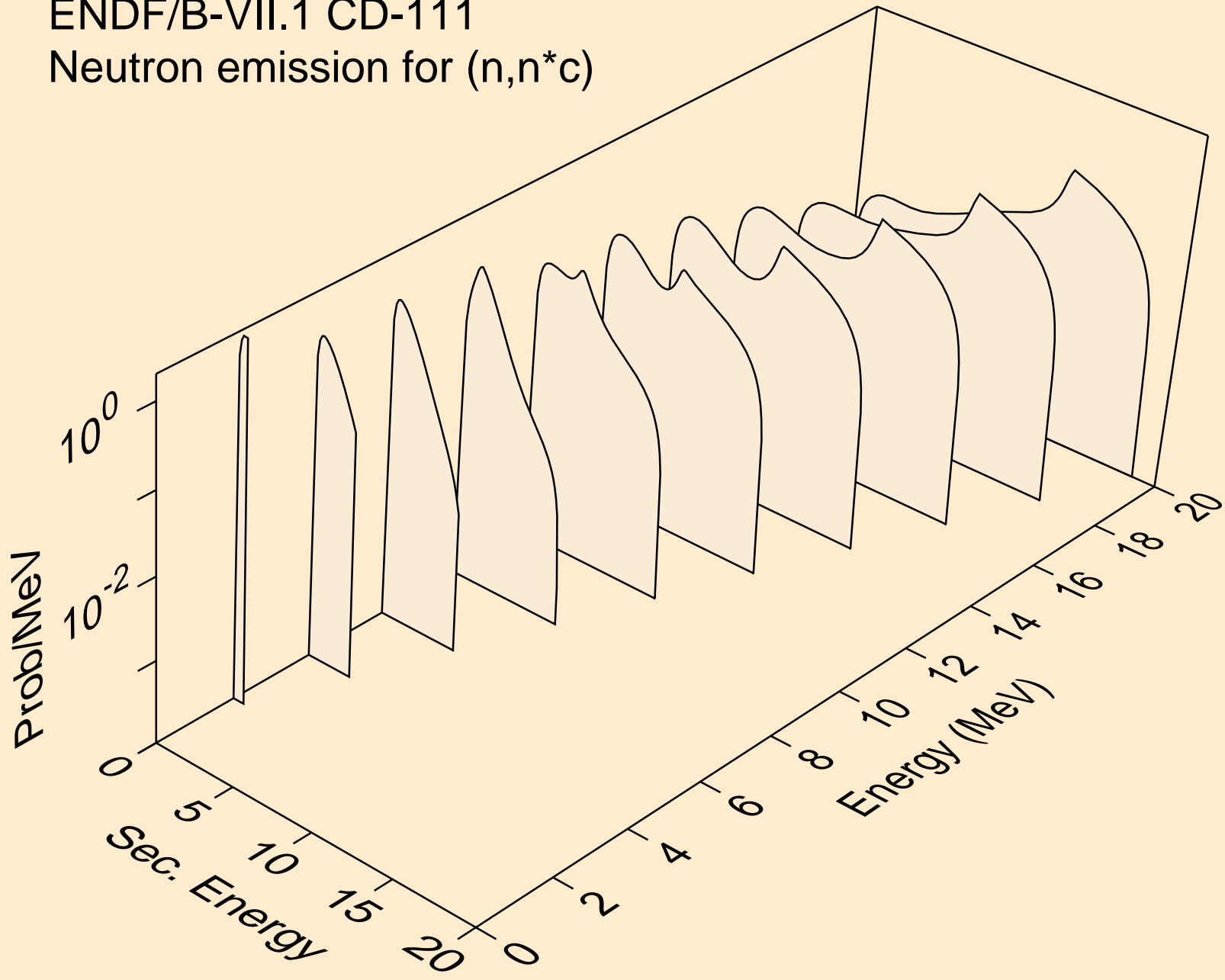

ENDF/B-VII.1 CD-111  
Photon emission for (n,2n)

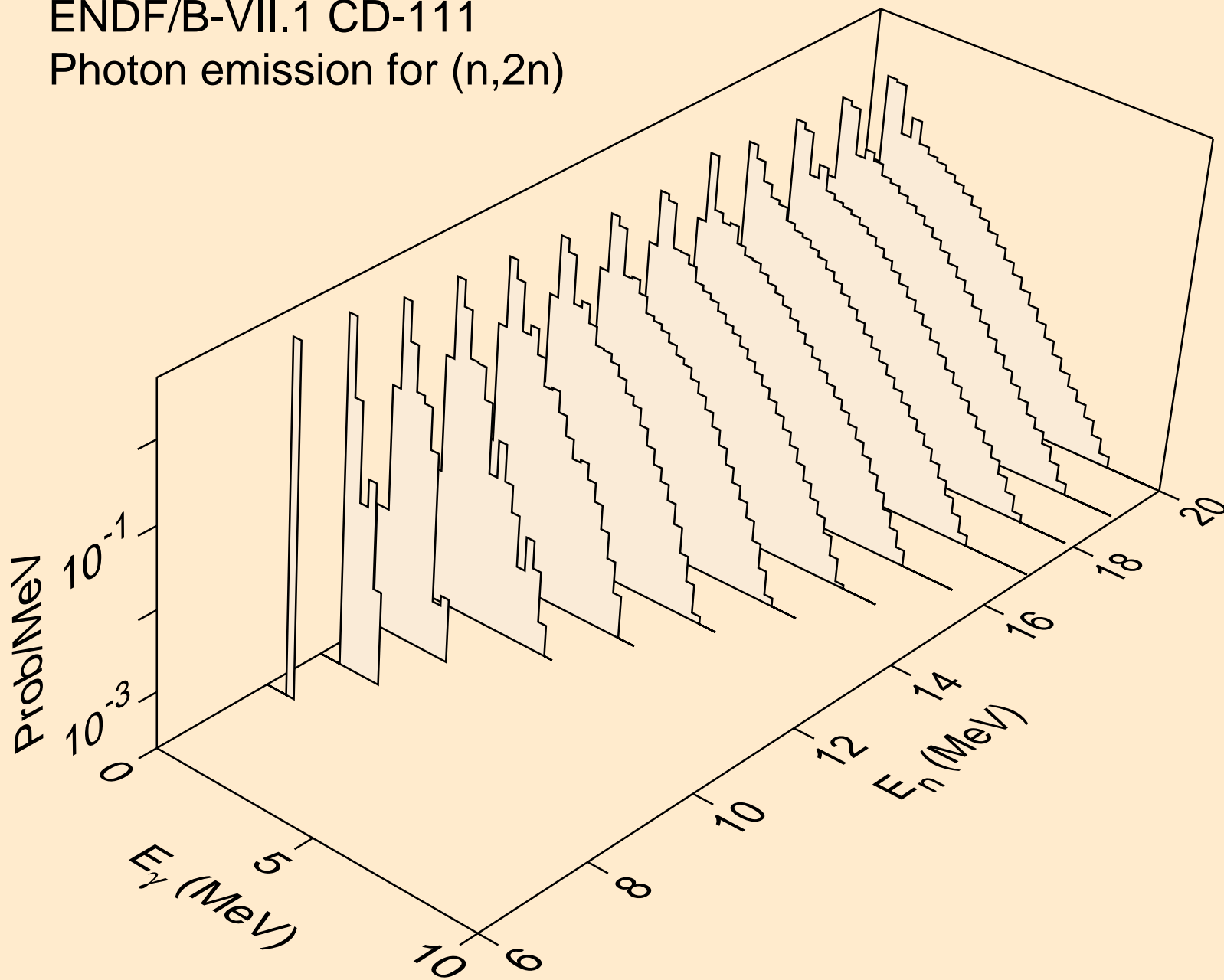

ENDF/B-VII.1 CD-111  
Photon emission for (n,3n)

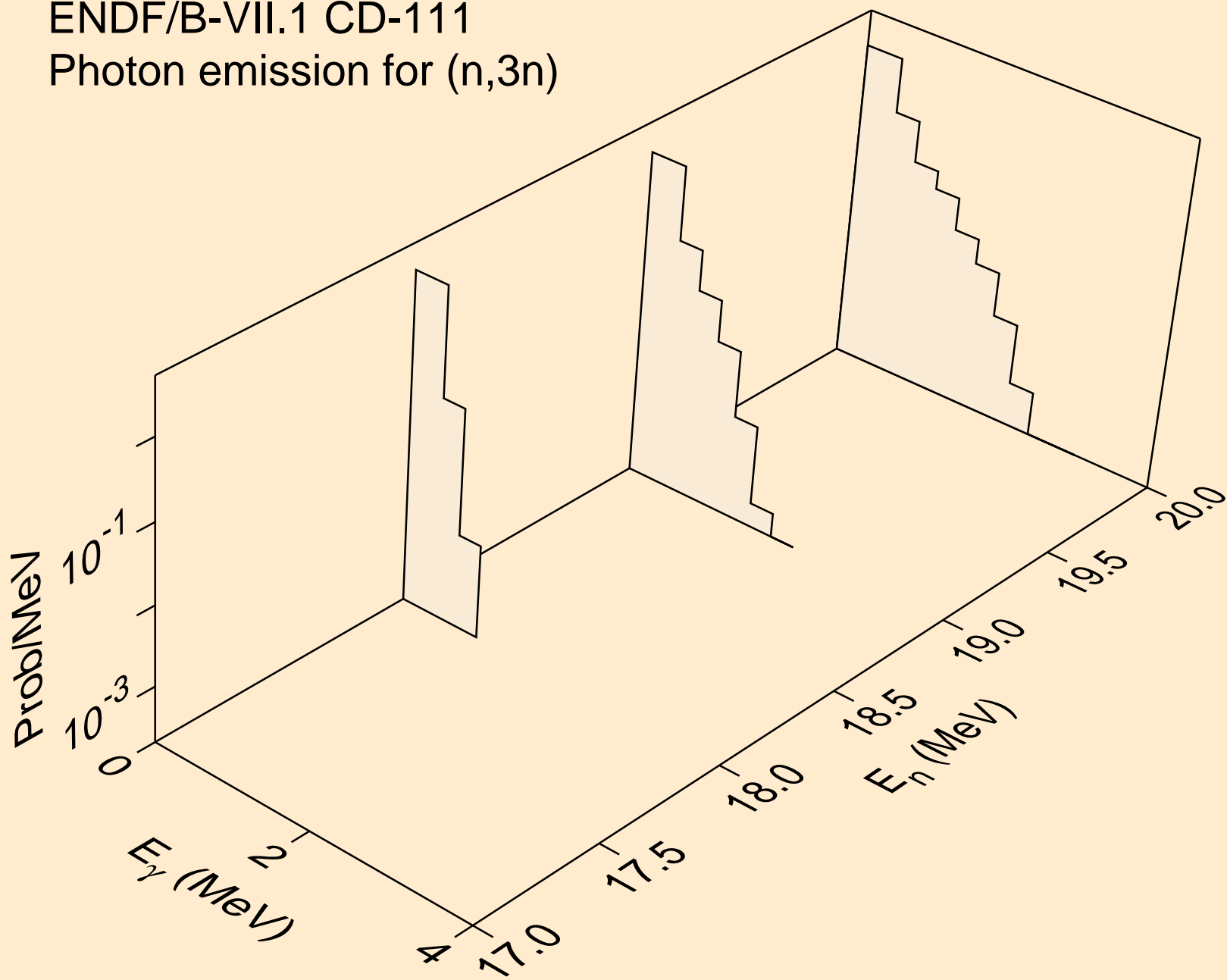

ENDF/B-VII.1 CD-111  
Photon emission for (n,n\*)a

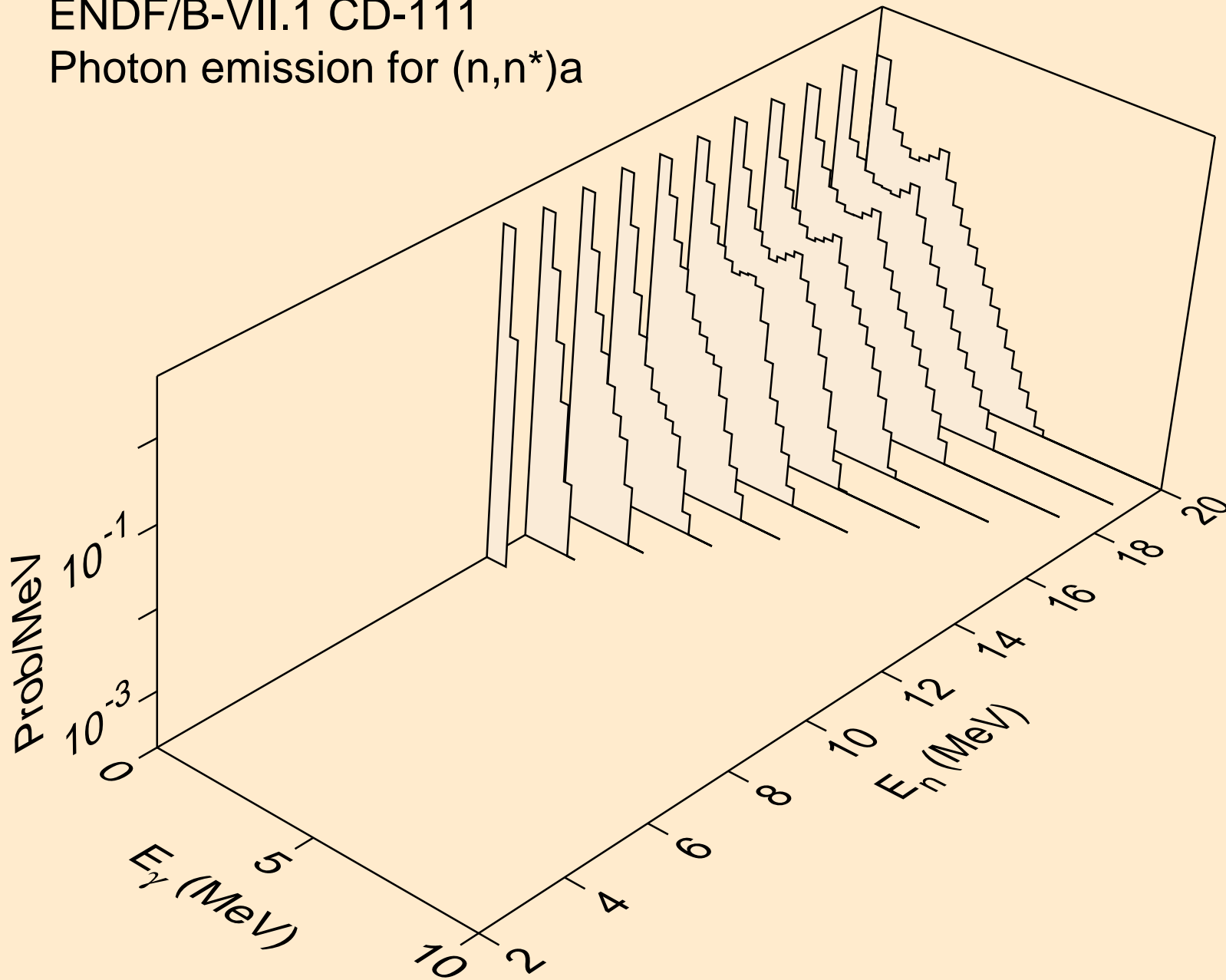



ENDF/B-VII.1 CD-111  
Photon emission for (n,n\*)p

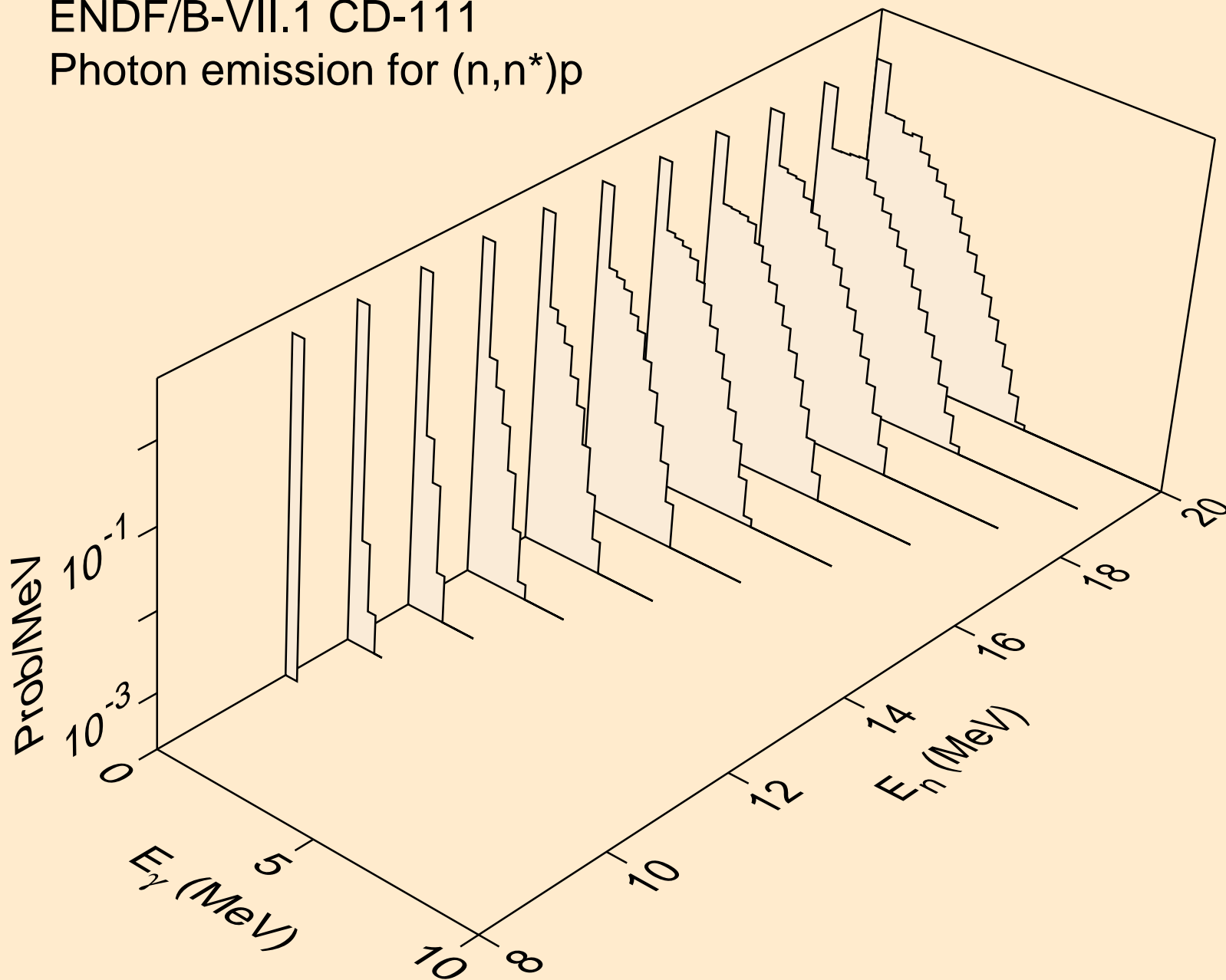

ENDF/B-VII.1 CD-111  
Photon emission for (n,n\*c)

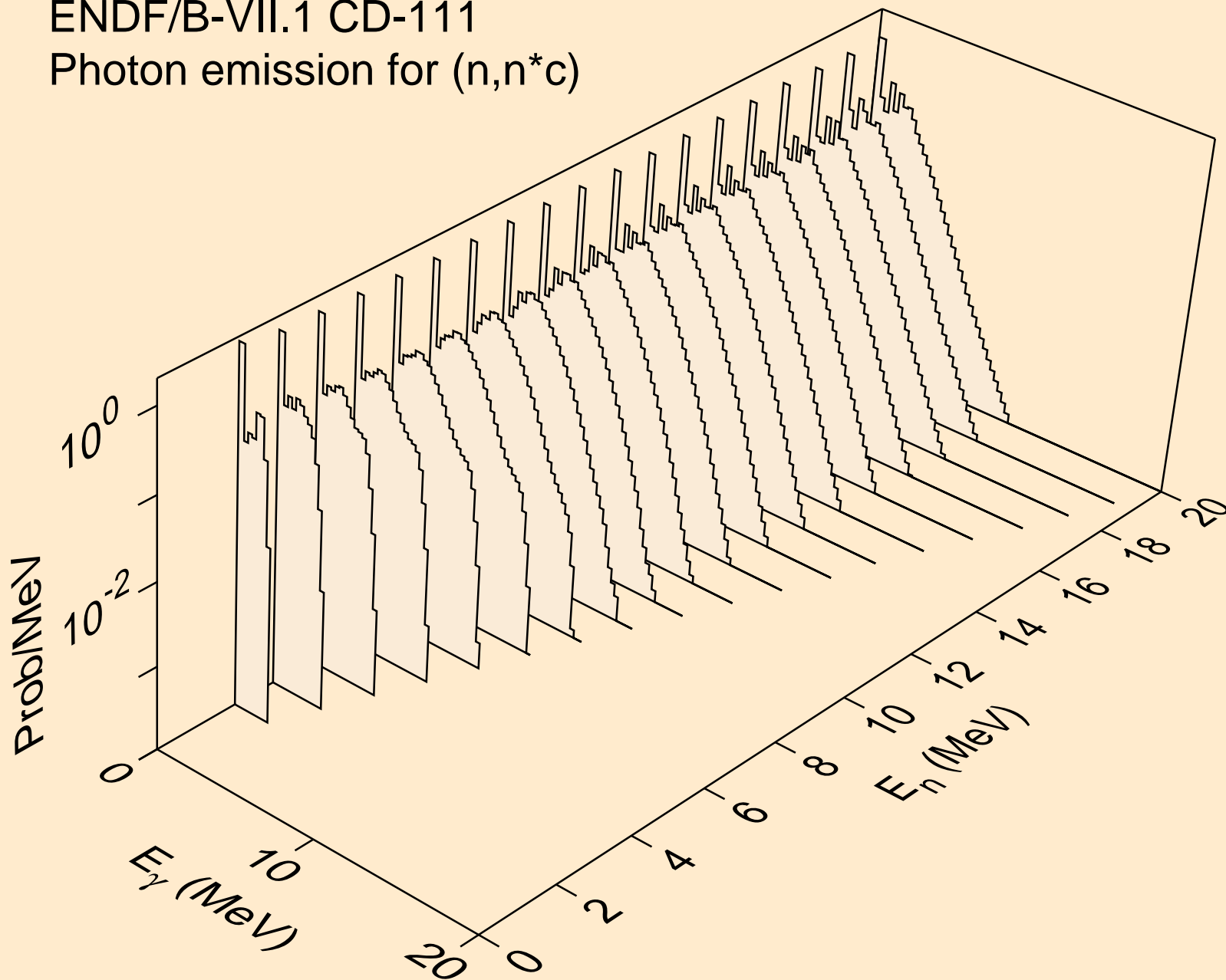

ENDF/B-VII.1 CD-111  
Photon emission for (n,gma)

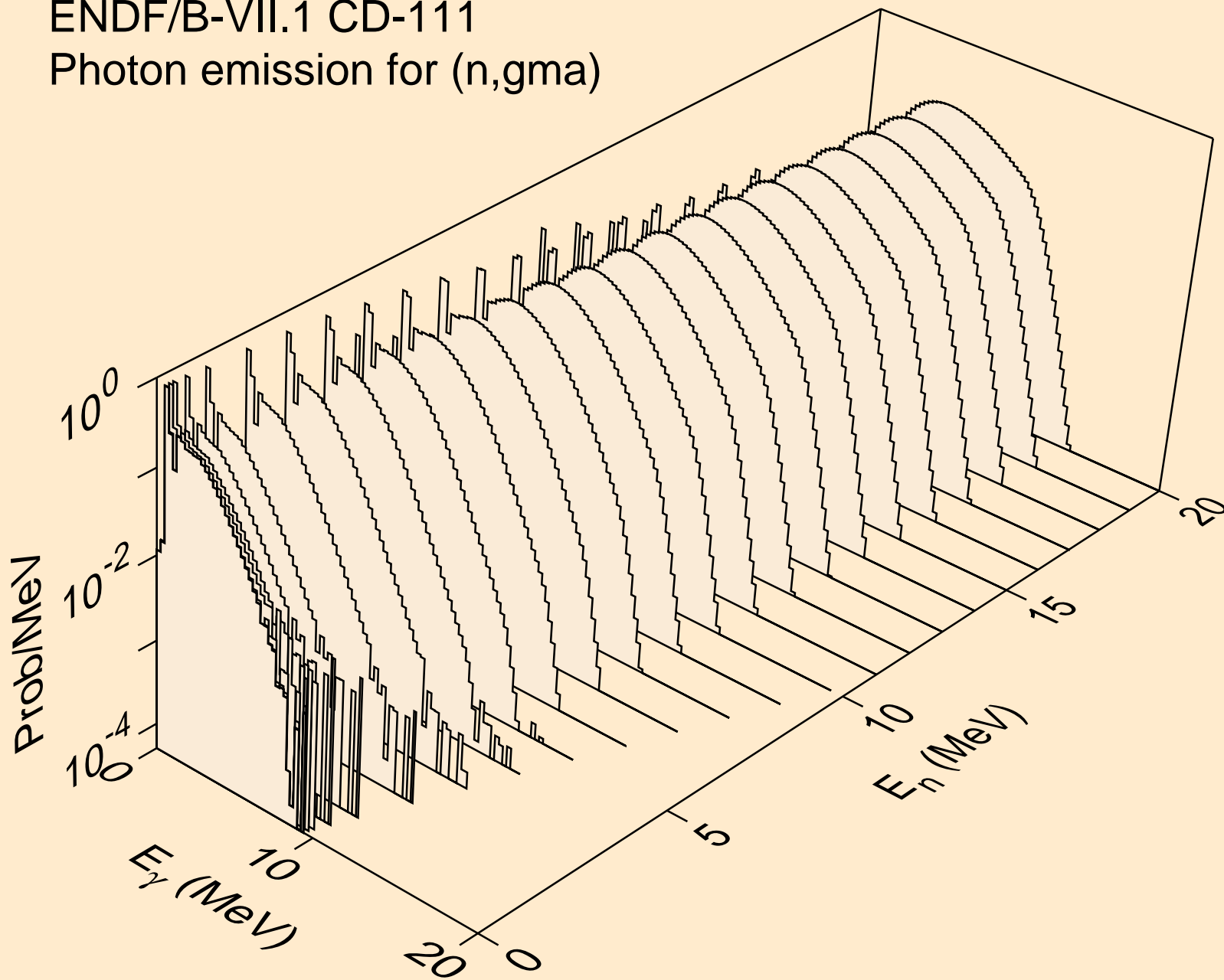

ENDF/B-VII.1 CD-111  
Photon emission for (n,p)

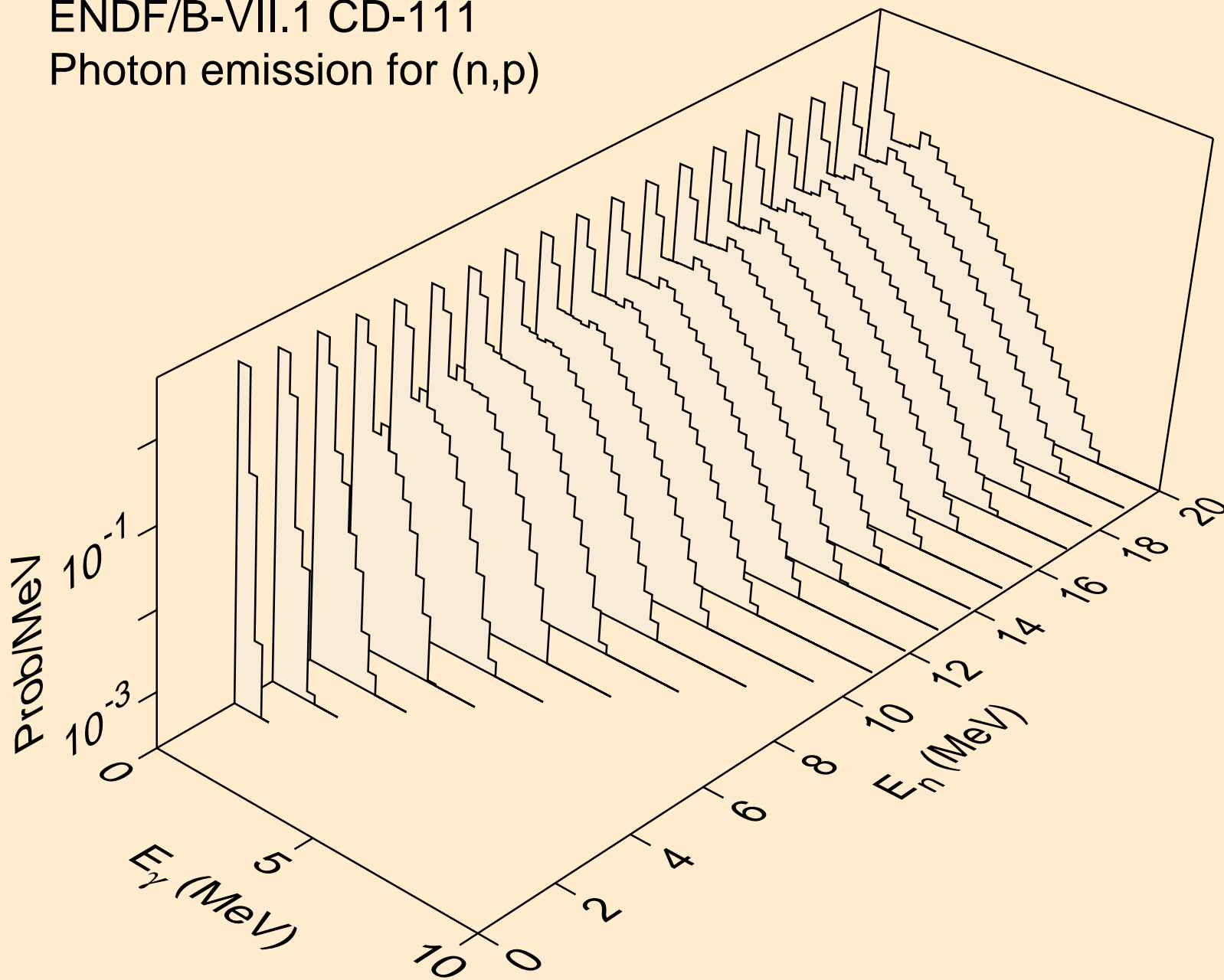

ENDF/B-VII.1 CD-111  
Photon emission for (n,a)

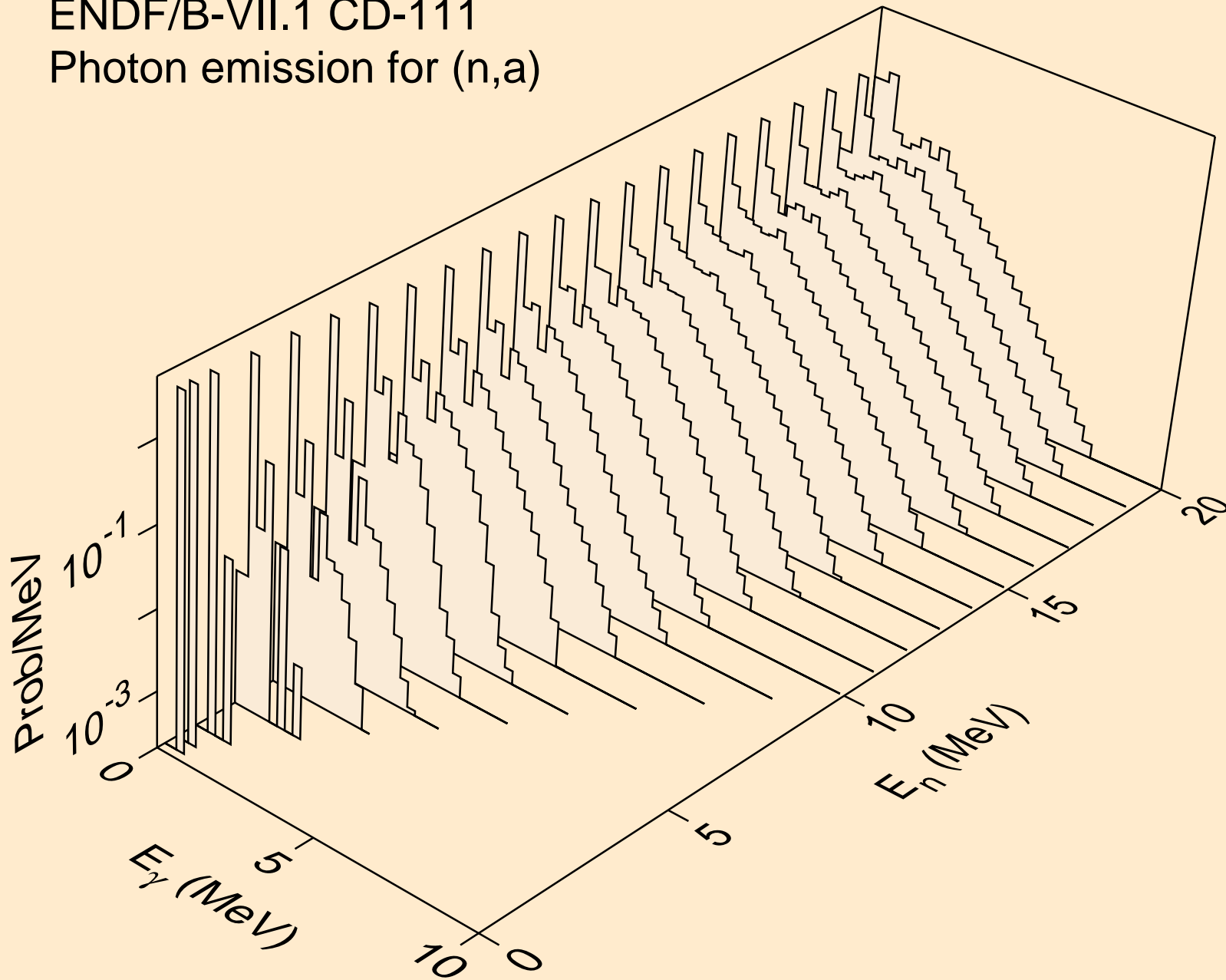

ENDF/B-VII.1 CD-111  
thermal capture photon spectrum

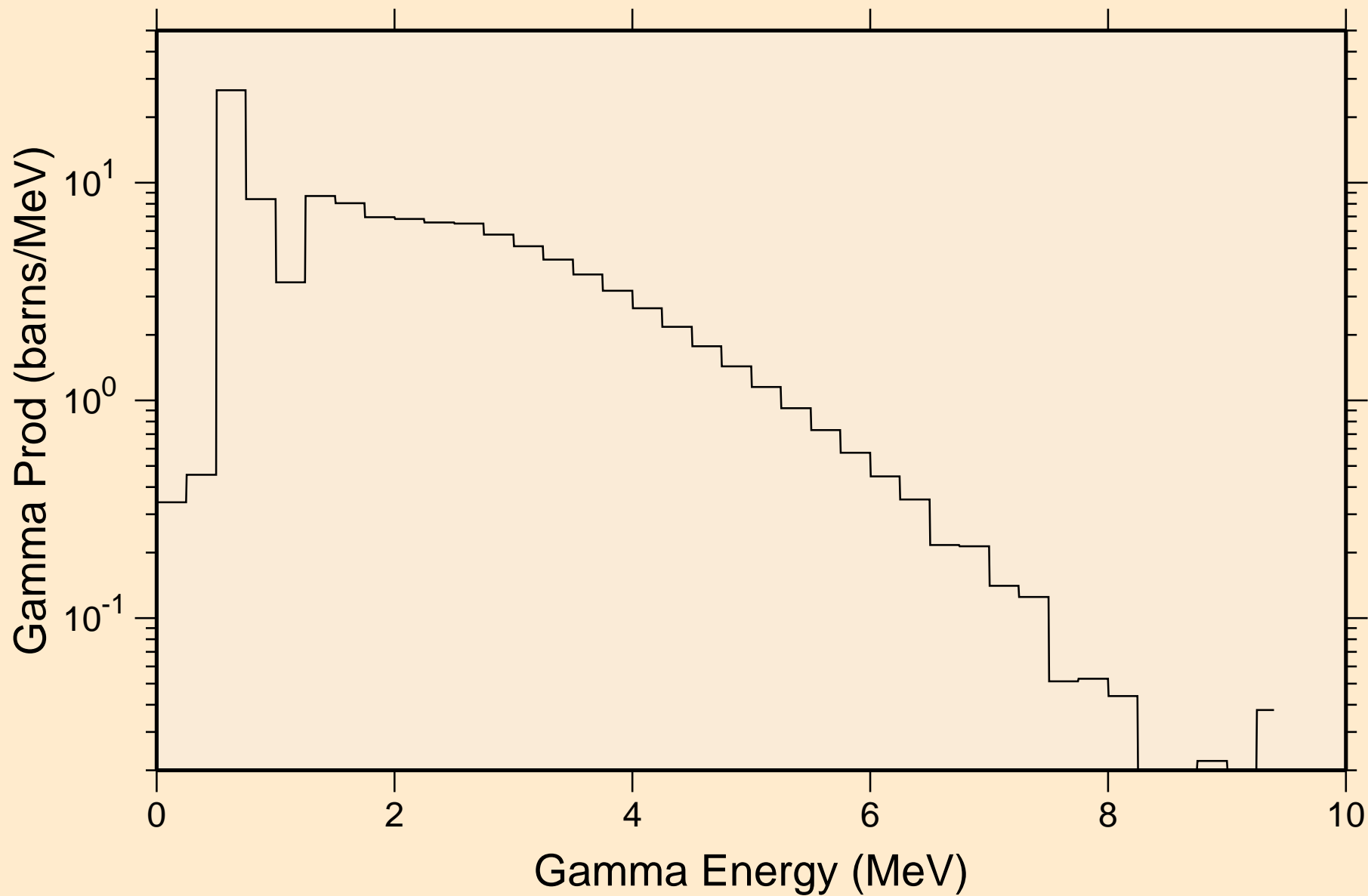

ENDF/B-VII.1 CD-111  
14 MeV photon spectrum

