

ENDF/B-VII PD-102

Principal cross sections

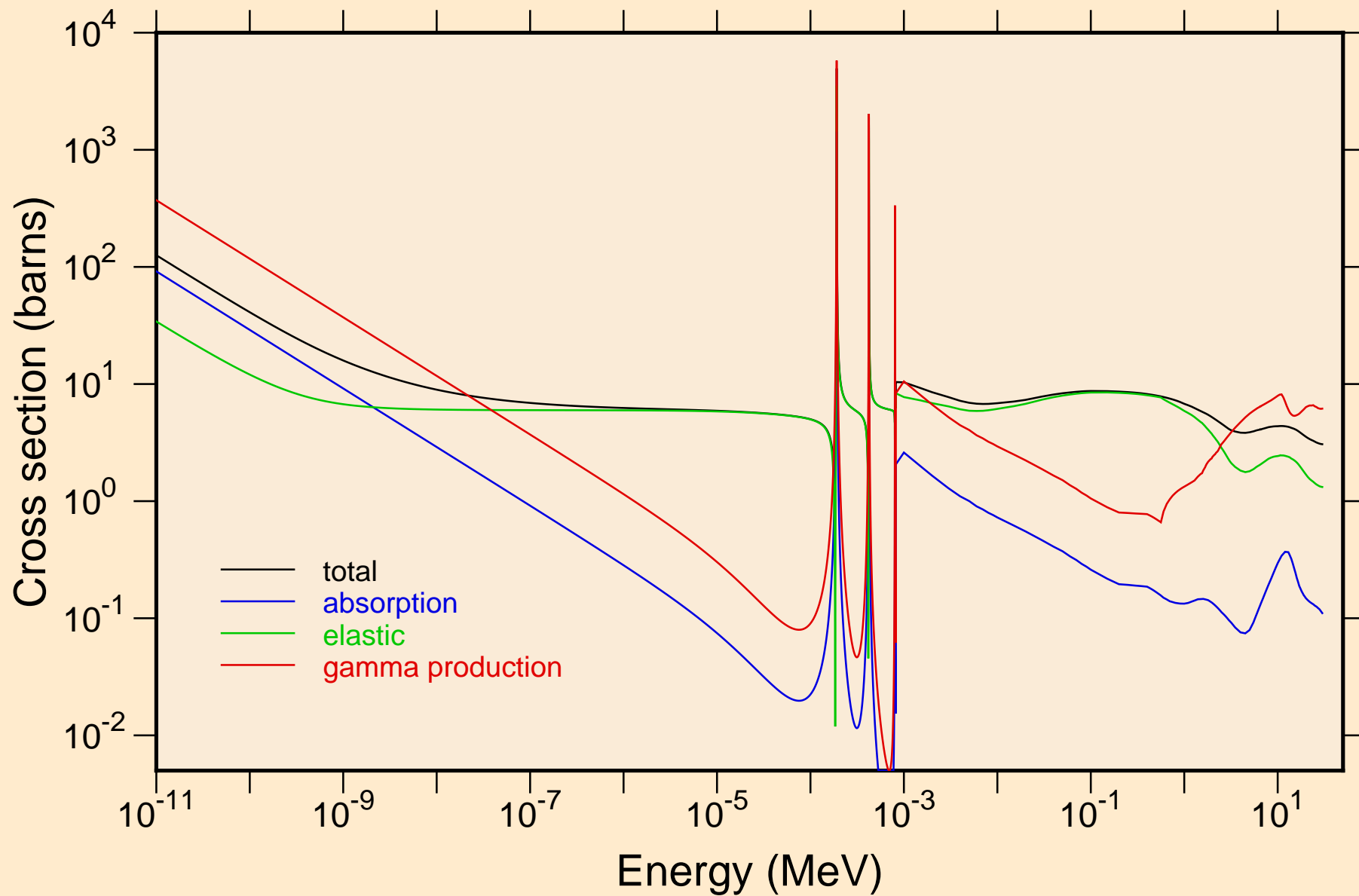

ENDF/B-VII PD-102
resonance total cross section

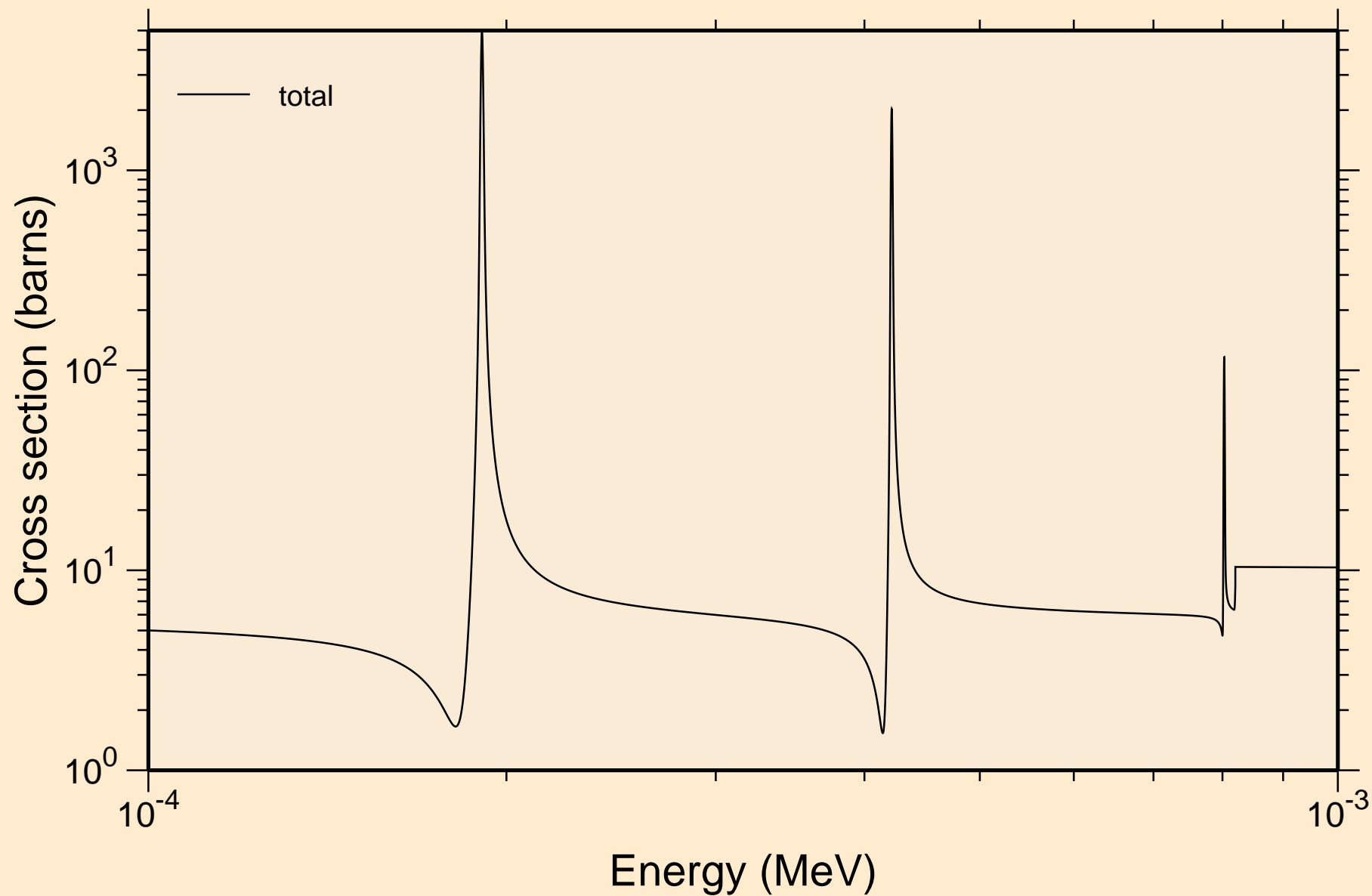

ENDF/B-VII PD-102
resonance absorption cross sections

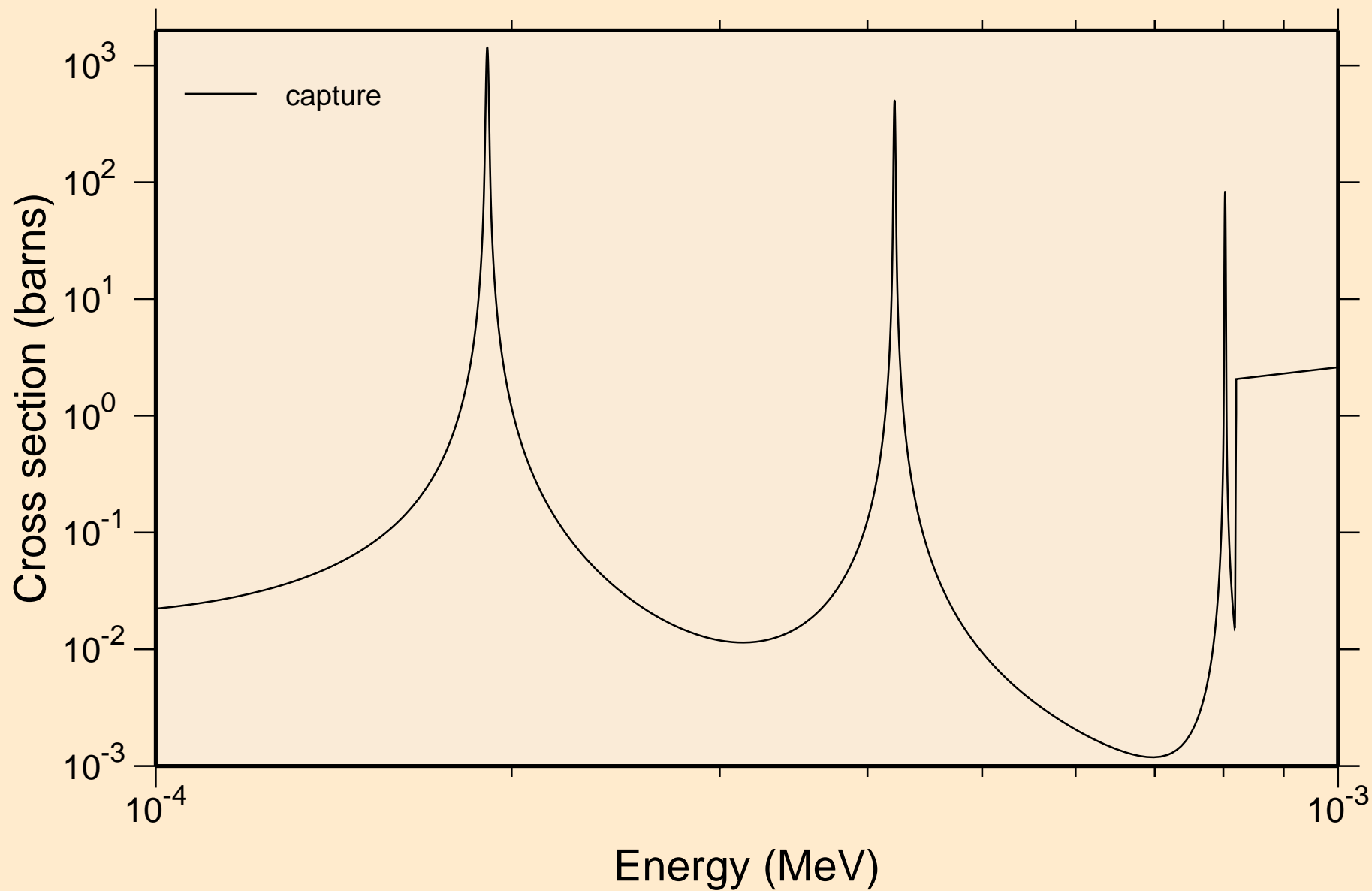

ENDF/B-VII PD-102
resonance absorption cross sections

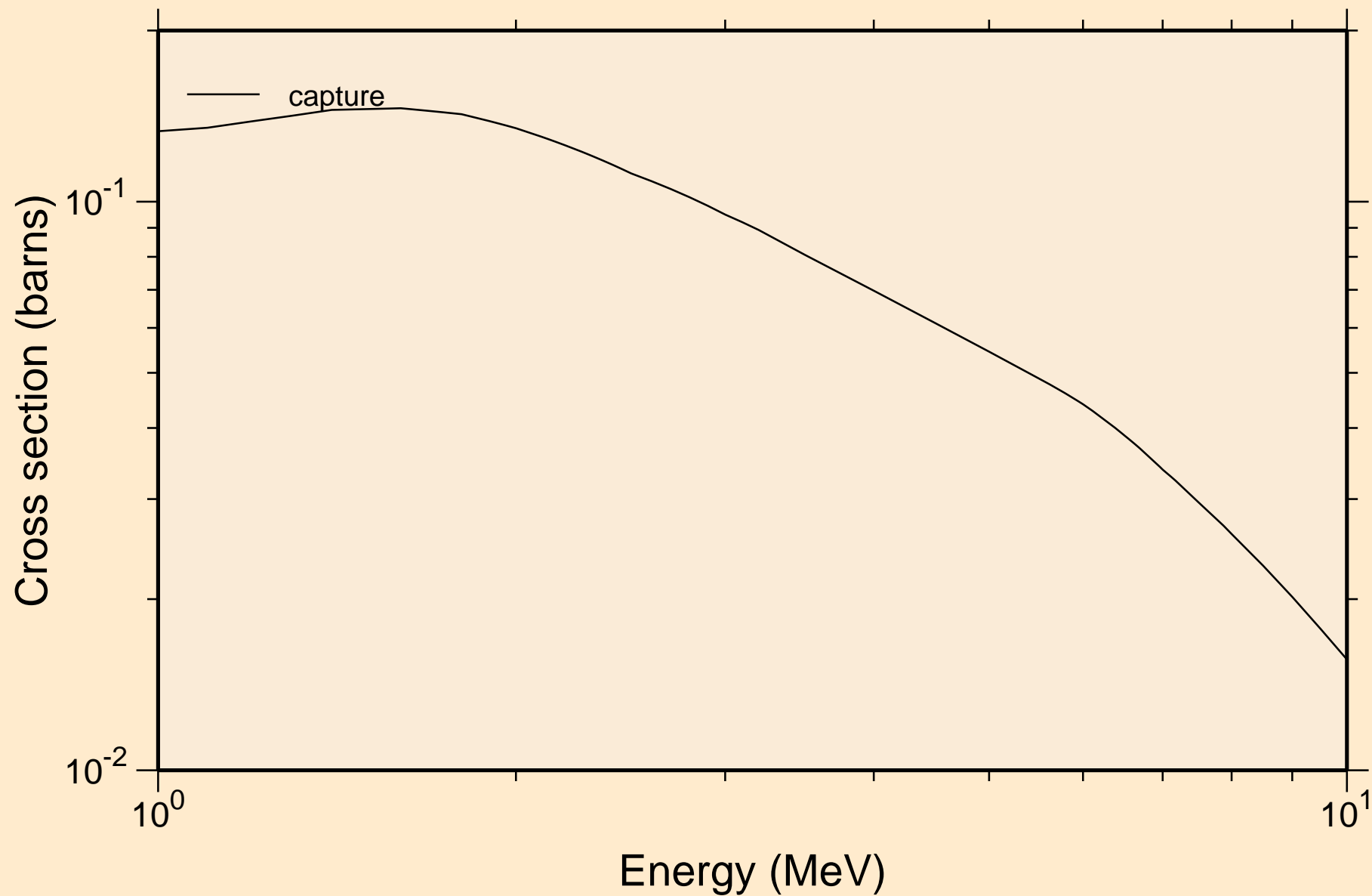

ENDF/B-VII PD-102

Heating

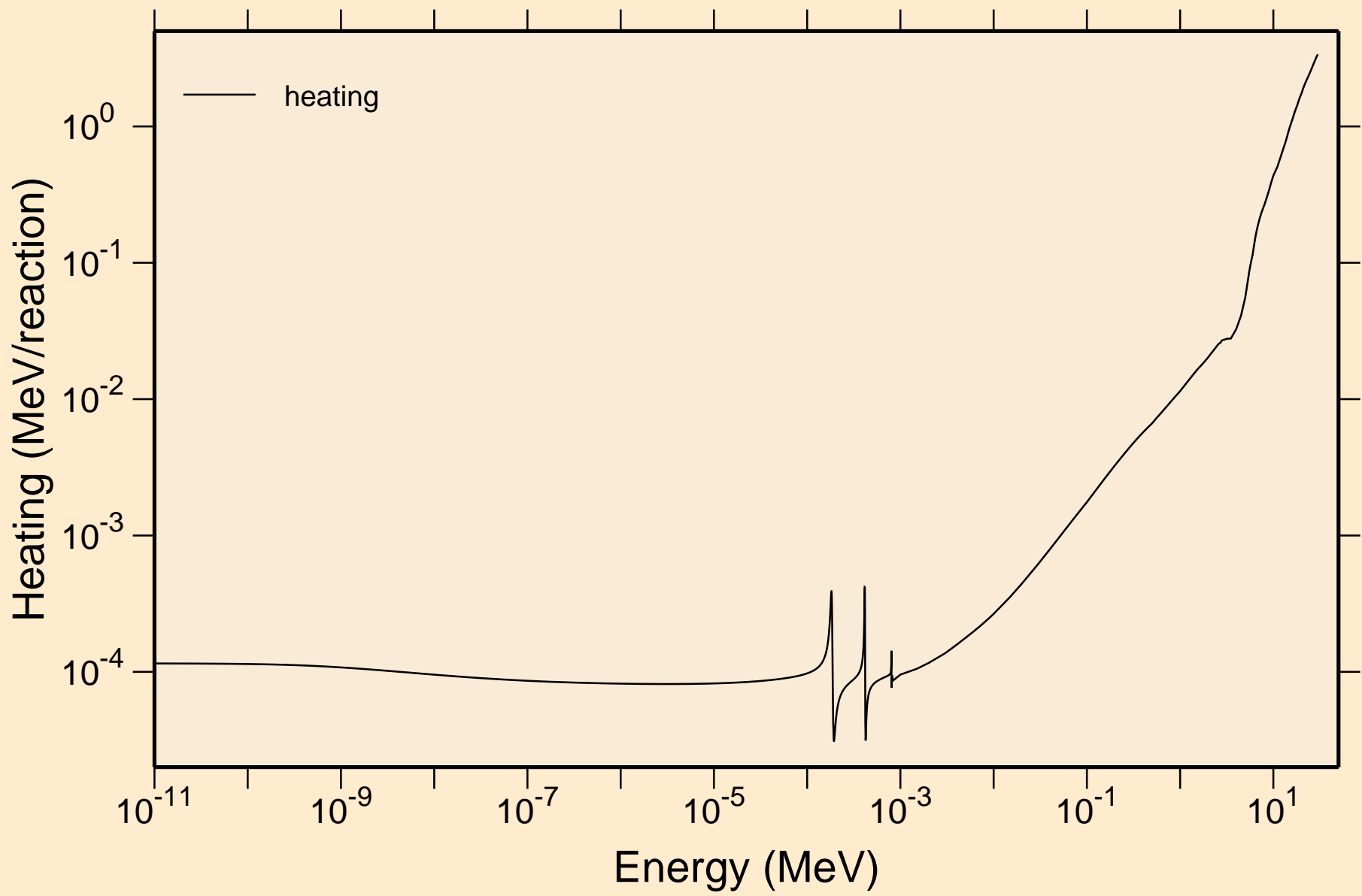

ENDF/B-VII PD-102

Damage

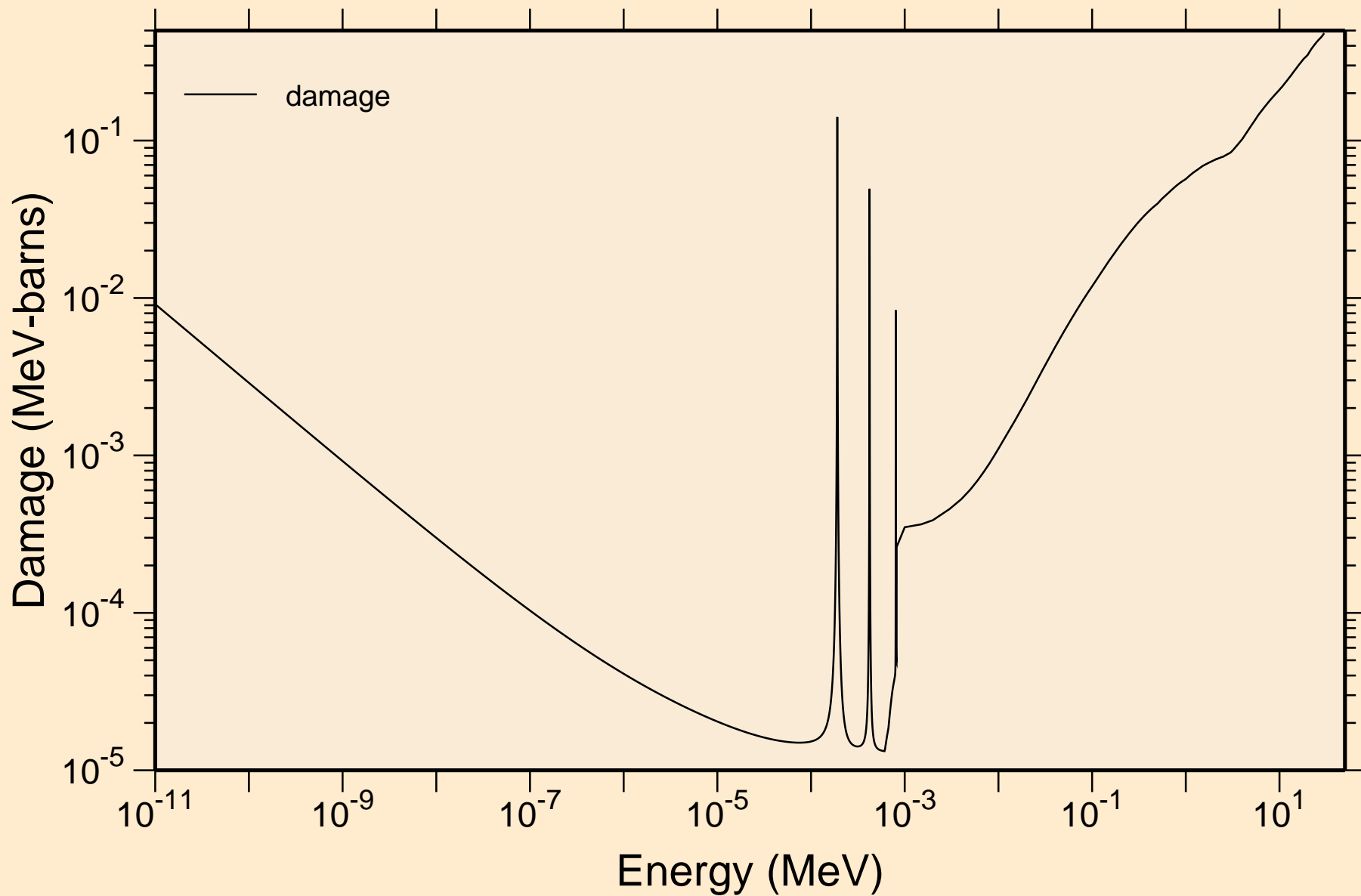

ENDF/B-VII PD-102

Non-threshold reactions

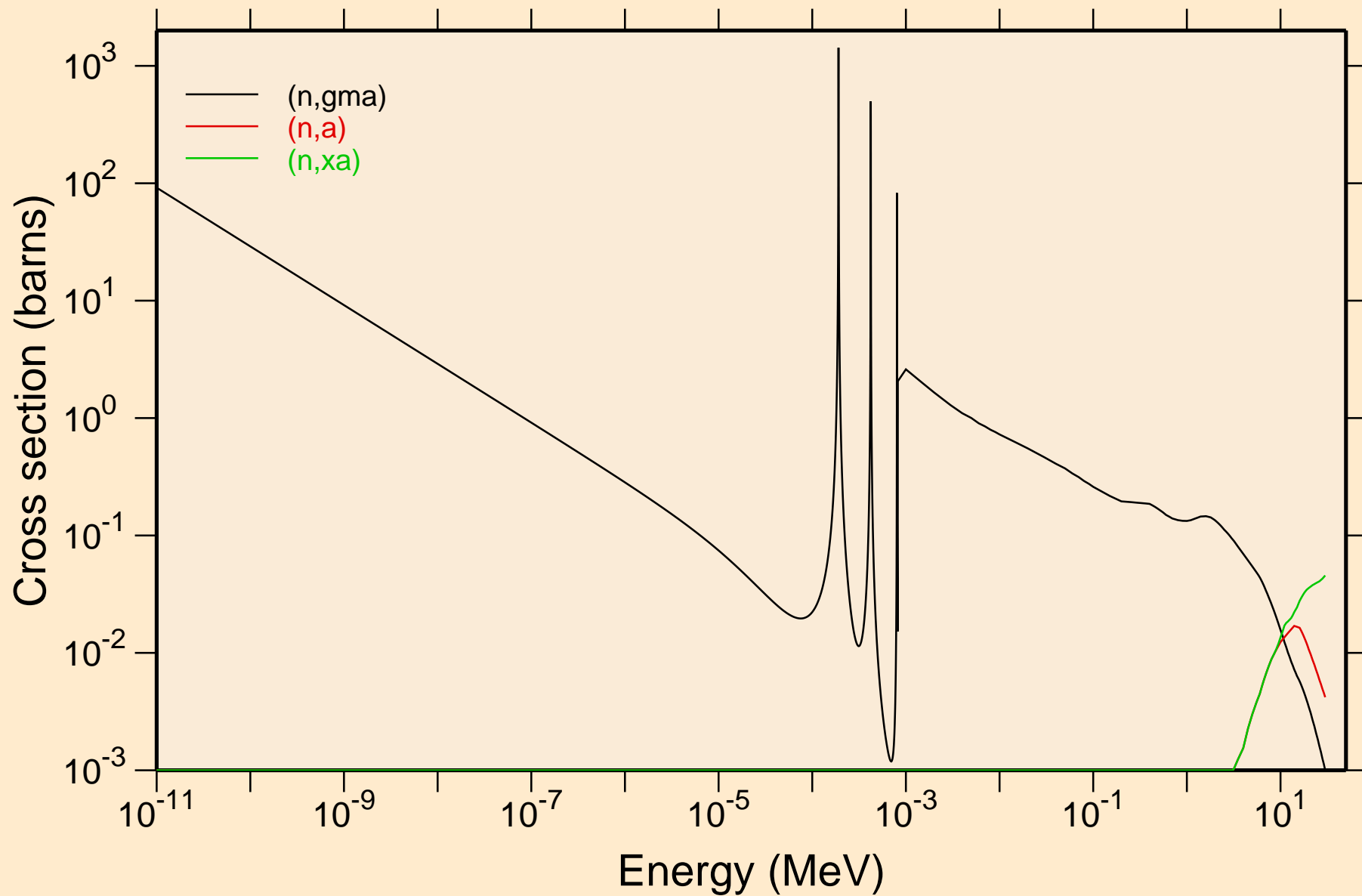

ENDF/B-VII PD-102

Principal cross sections

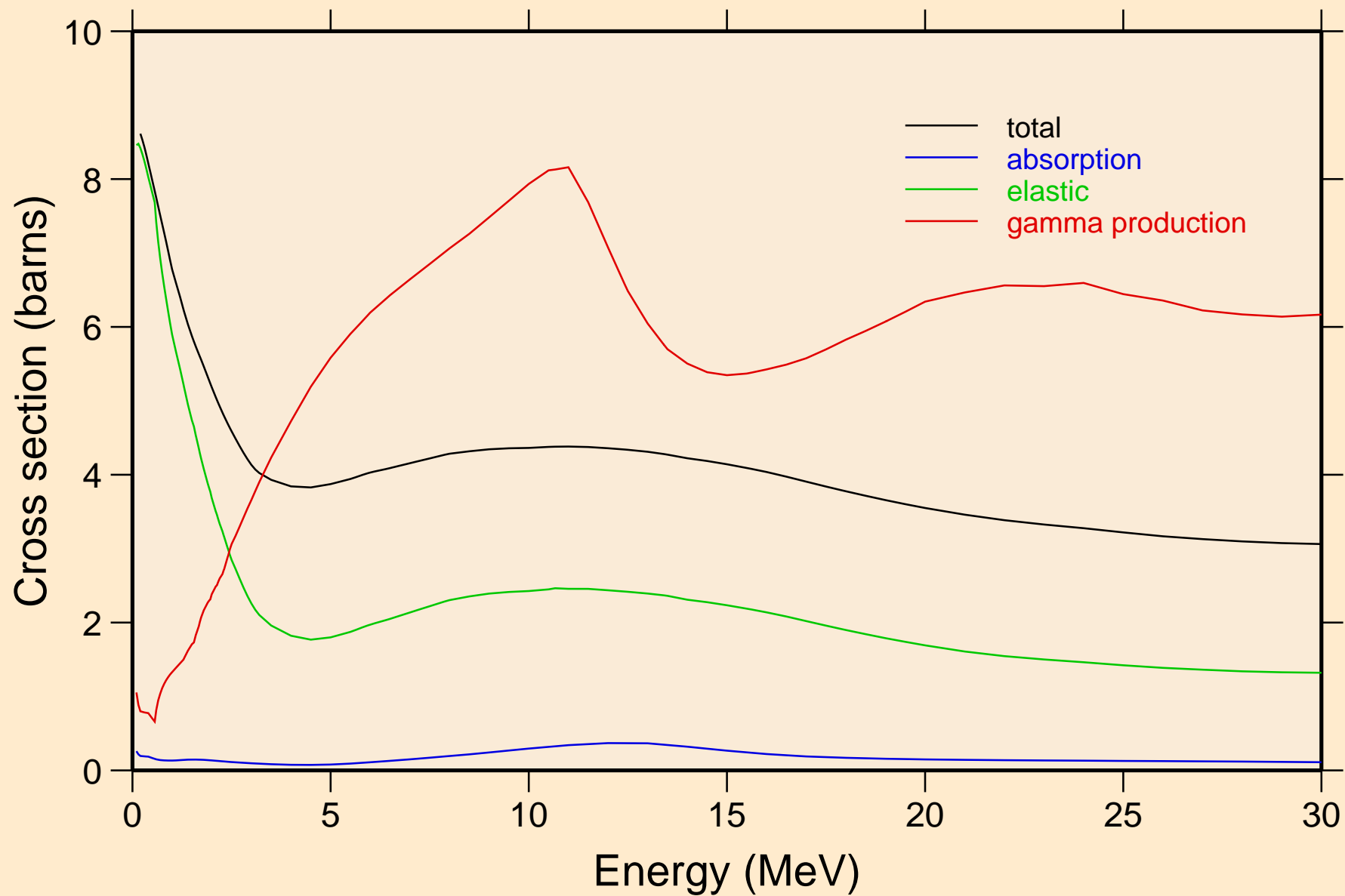

ENDF/B-VII PD-102

Heating

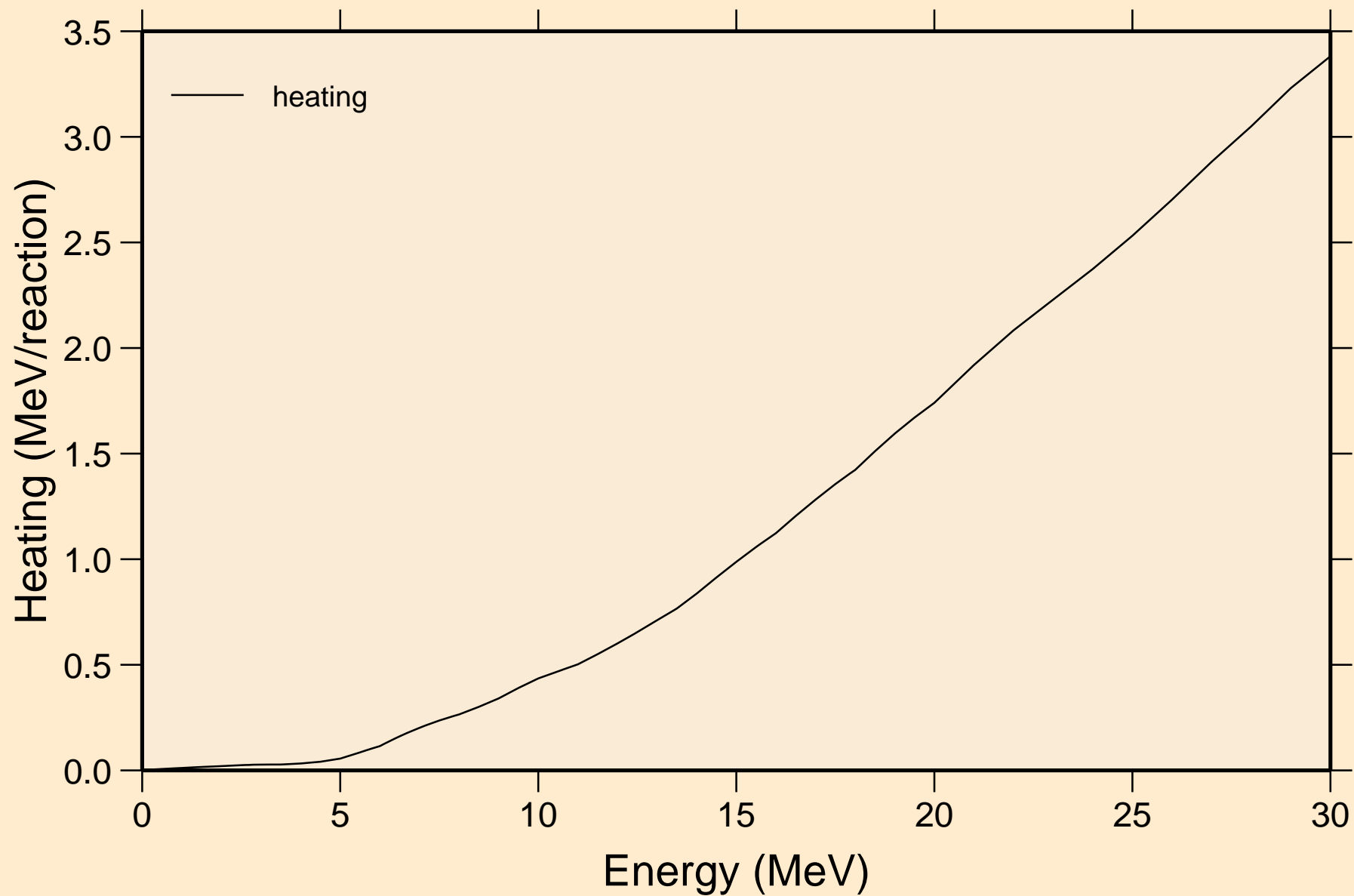

ENDF/B-VII PD-102

Damage

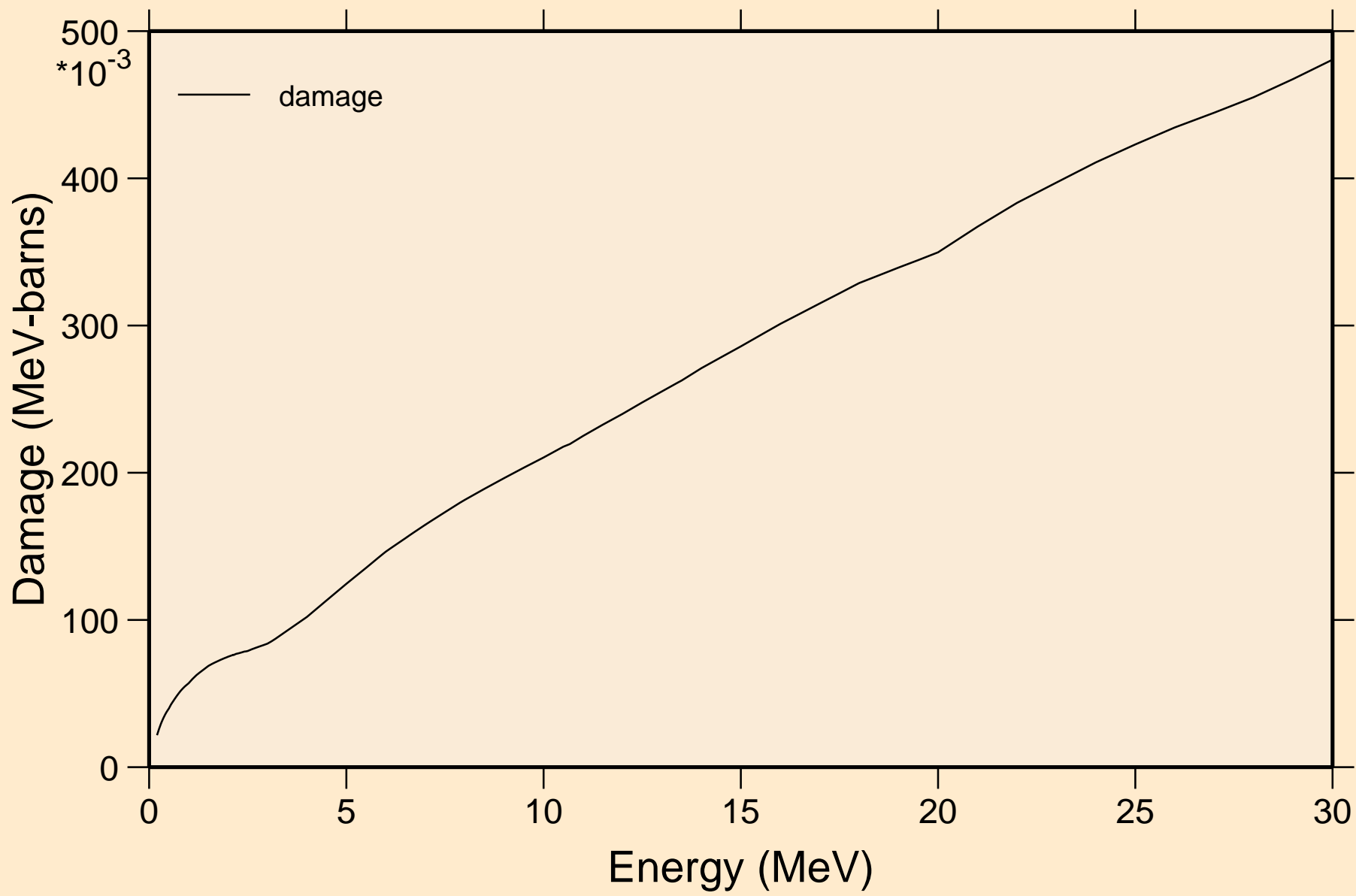

ENDF/B-VII PD-102
Non-threshold reactions

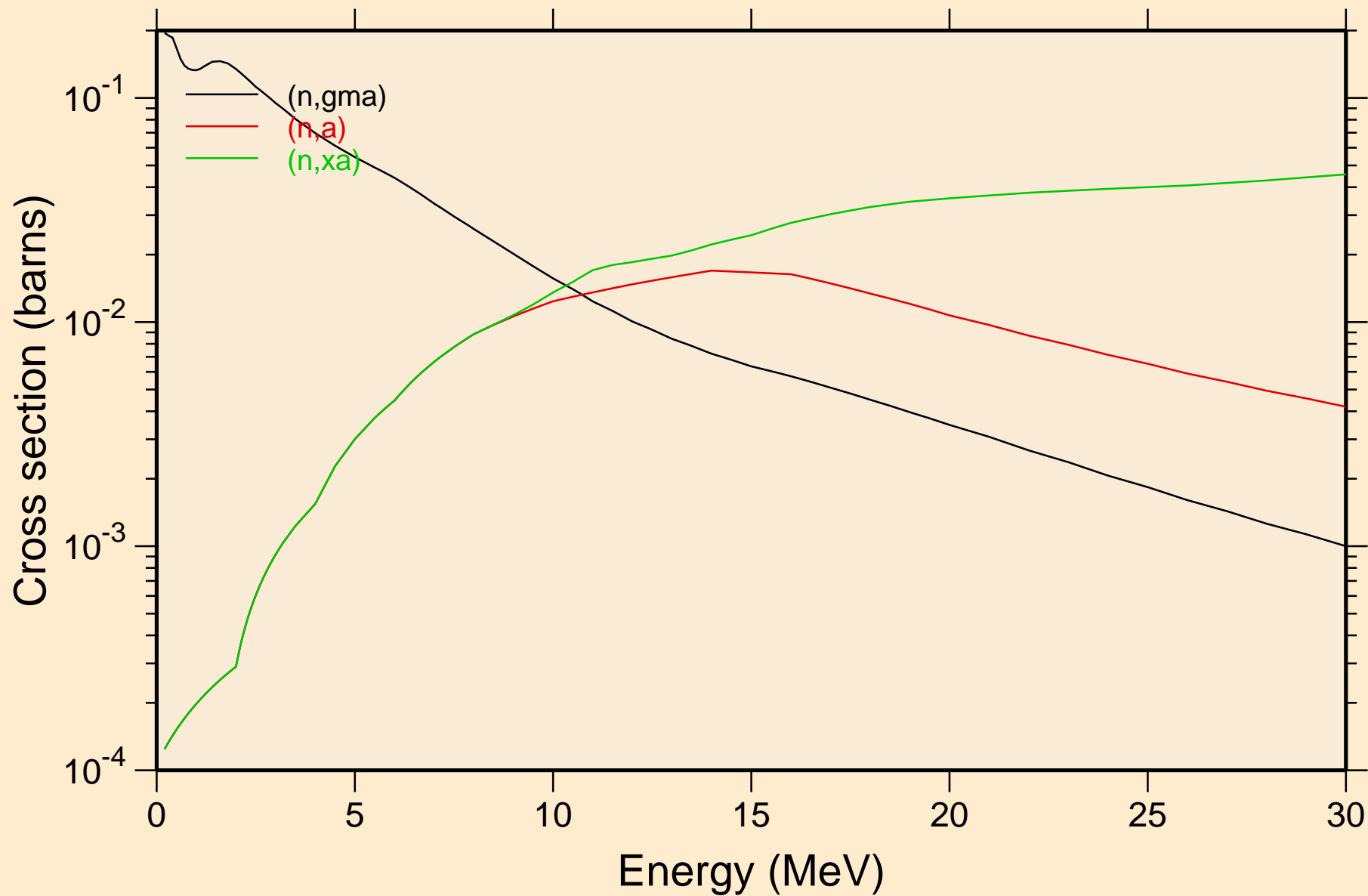

ENDF/B-VII PD-102

Inelastic levels

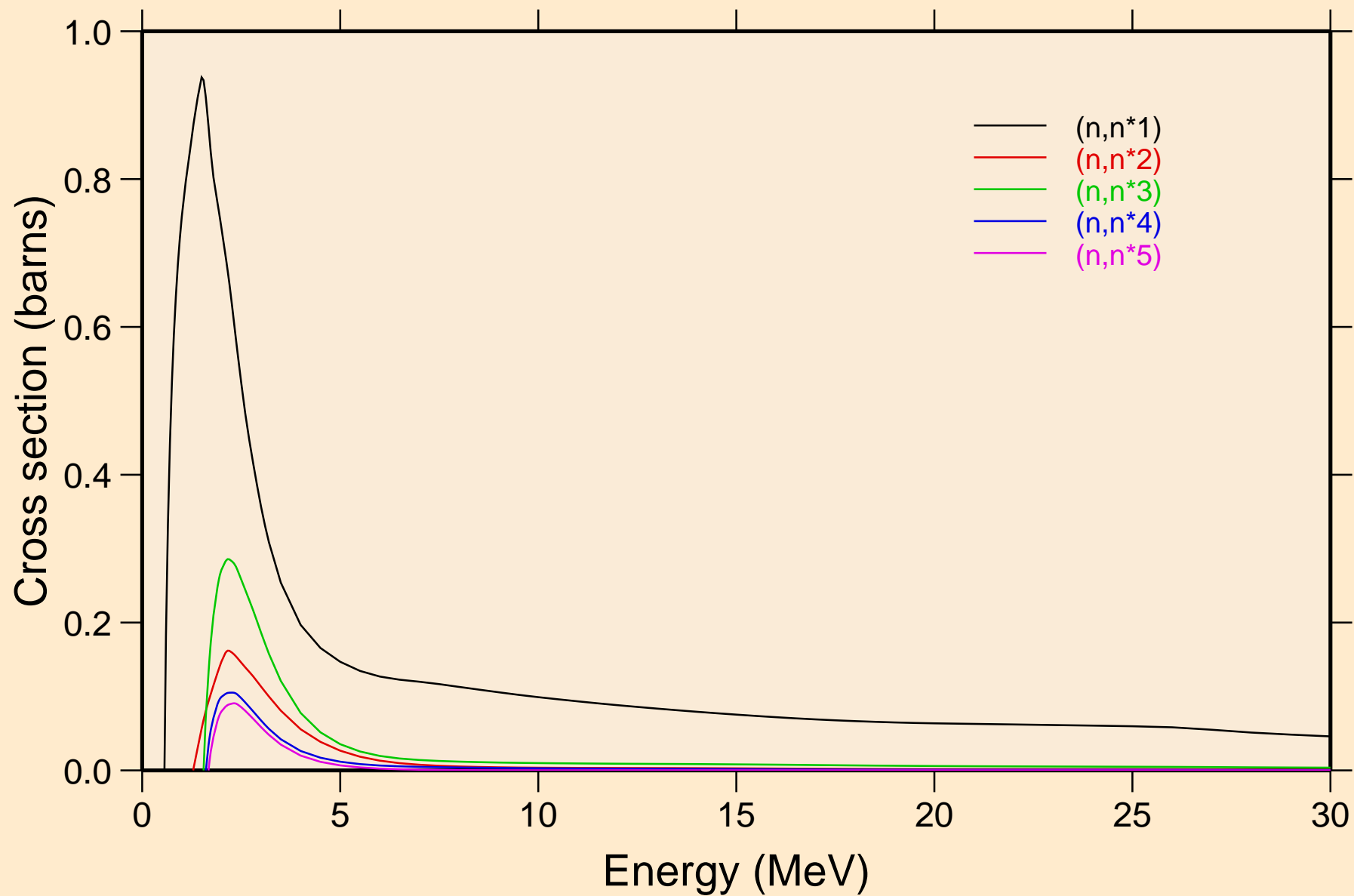

ENDF/B-VII PD-102

Inelastic levels

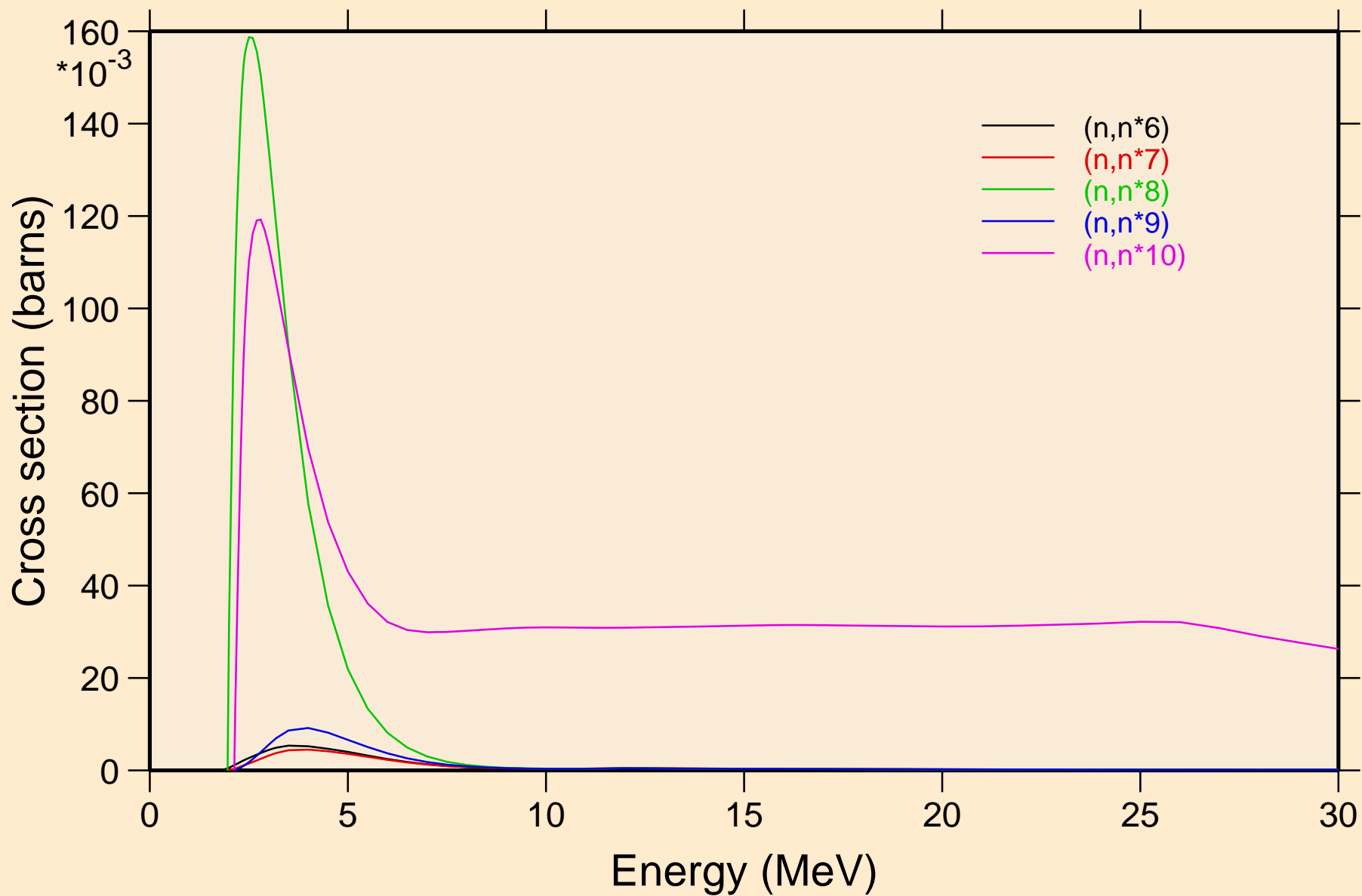

ENDF/B-VII PD-102

Inelastic levels

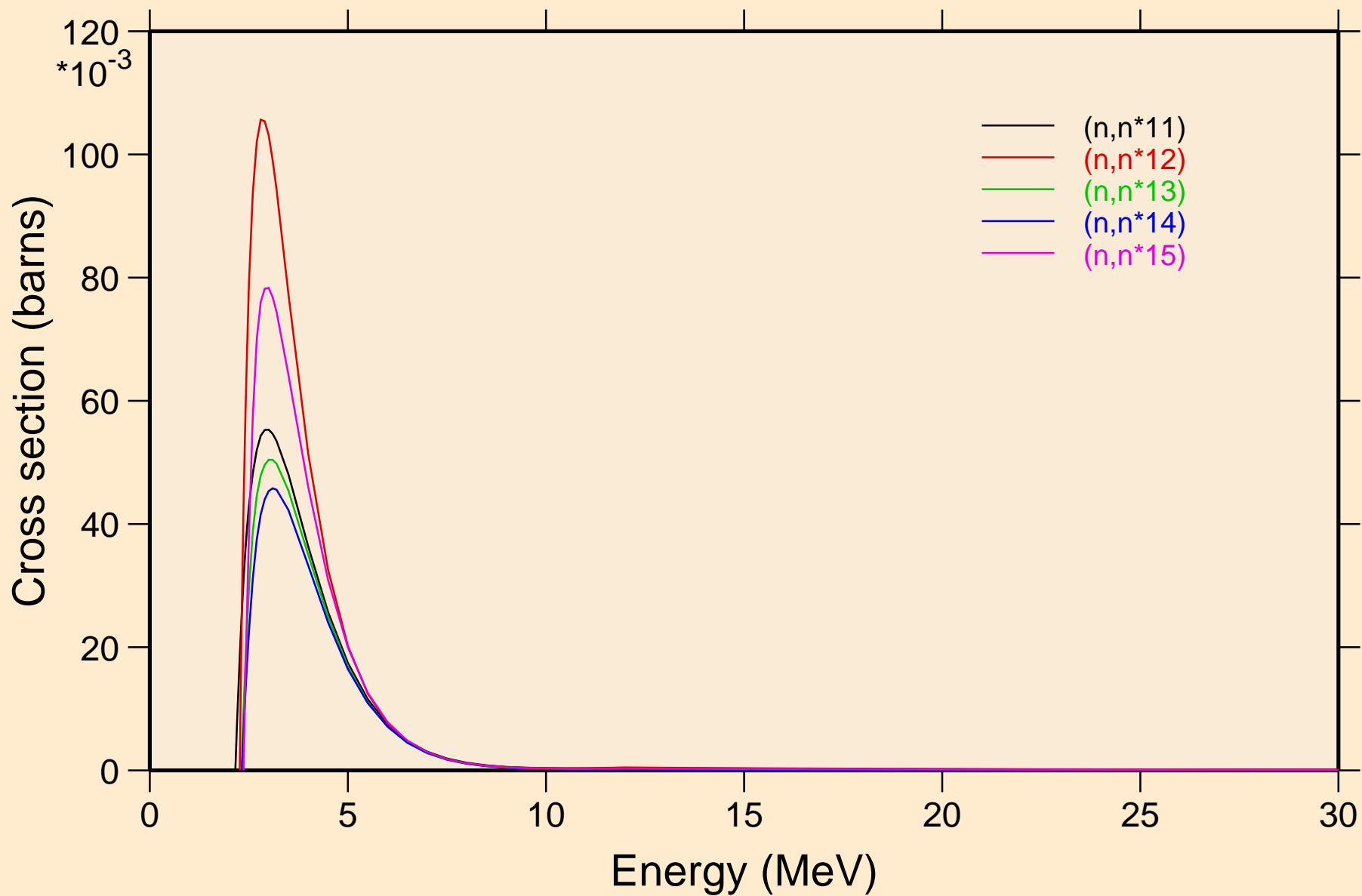

ENDF/B-VII PD-102

Inelastic levels

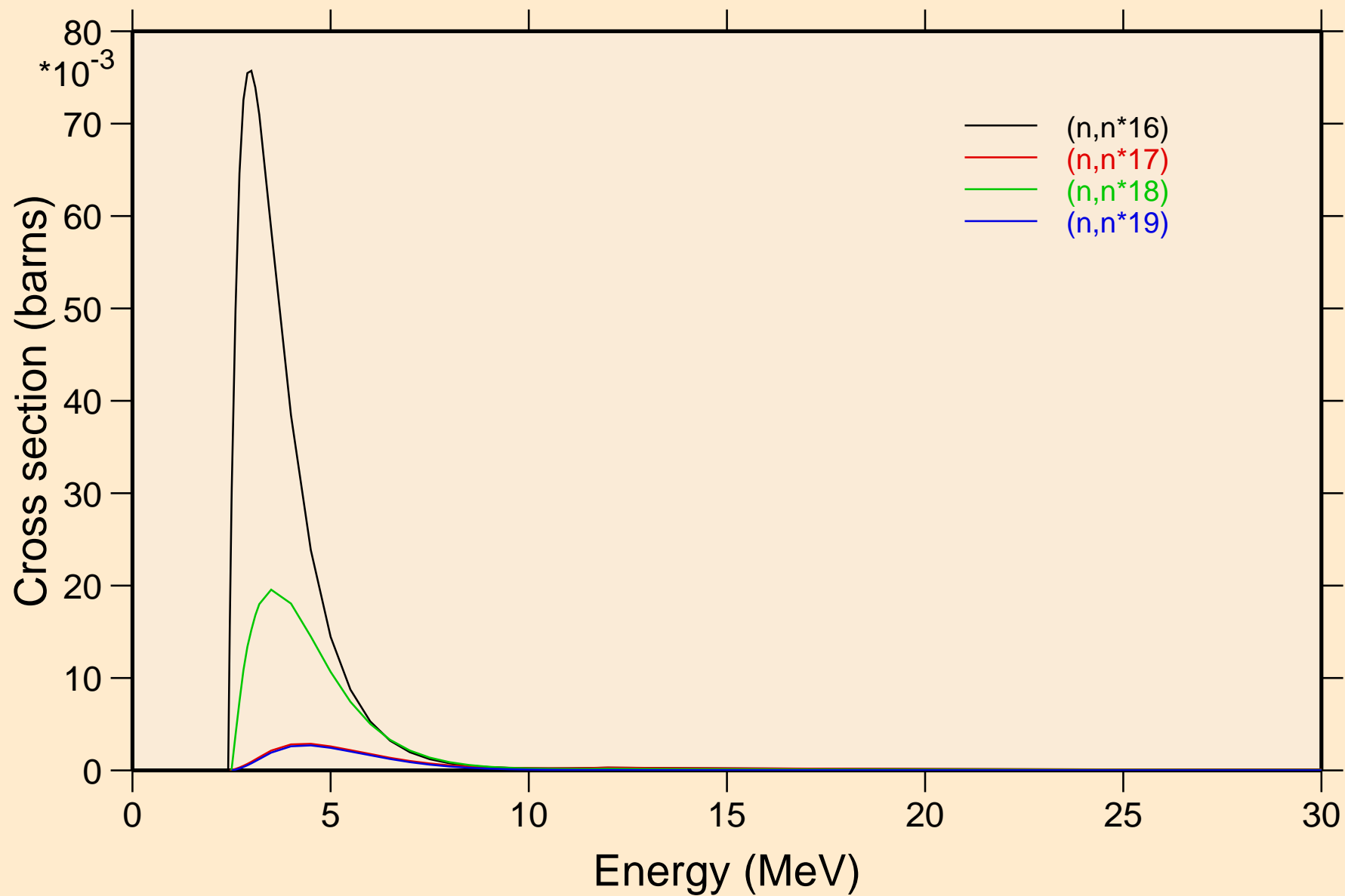

ENDF/B-VII PD-102

Threshold reactions

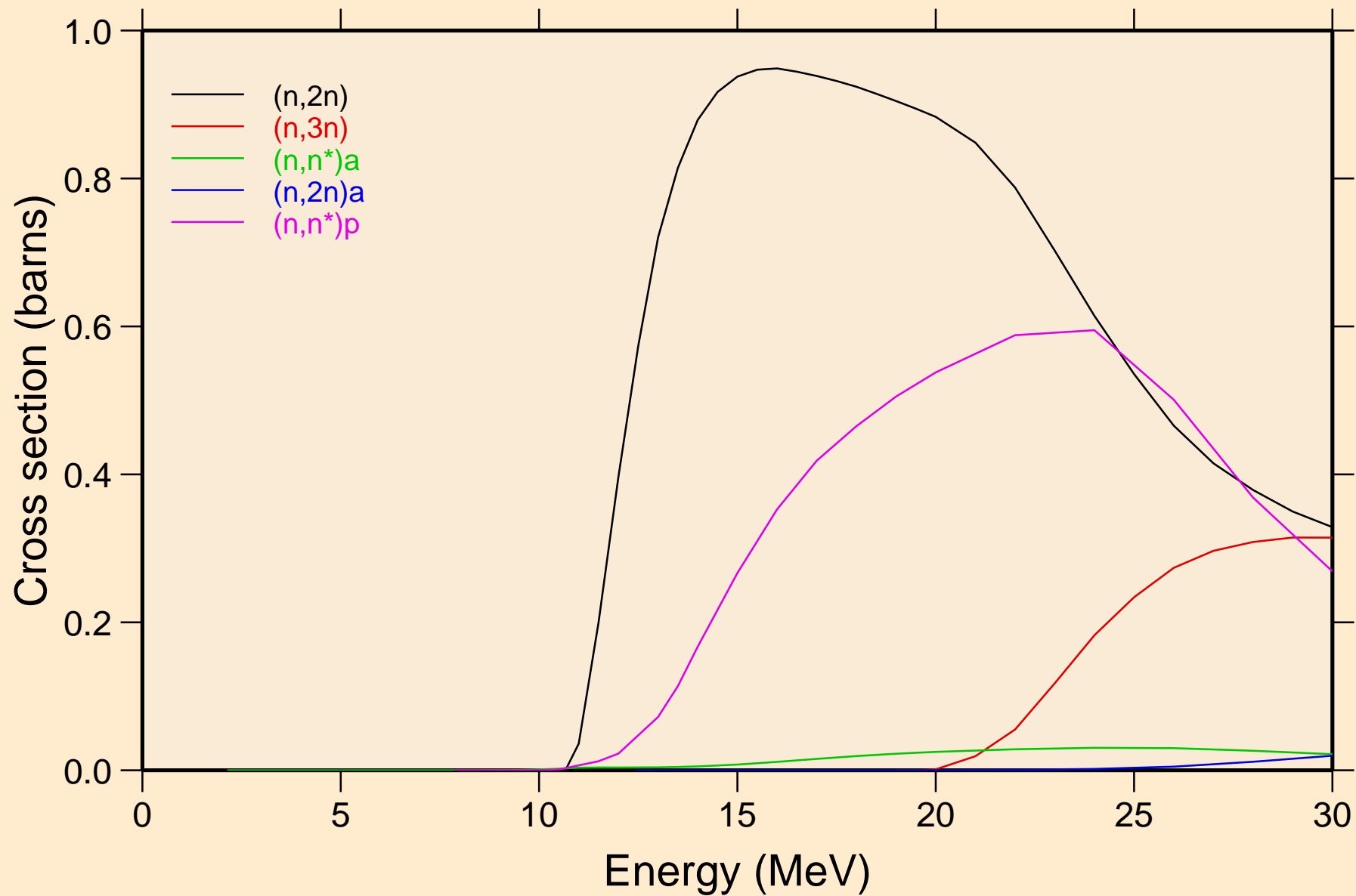

ENDF/B-VII PD-102

Threshold reactions

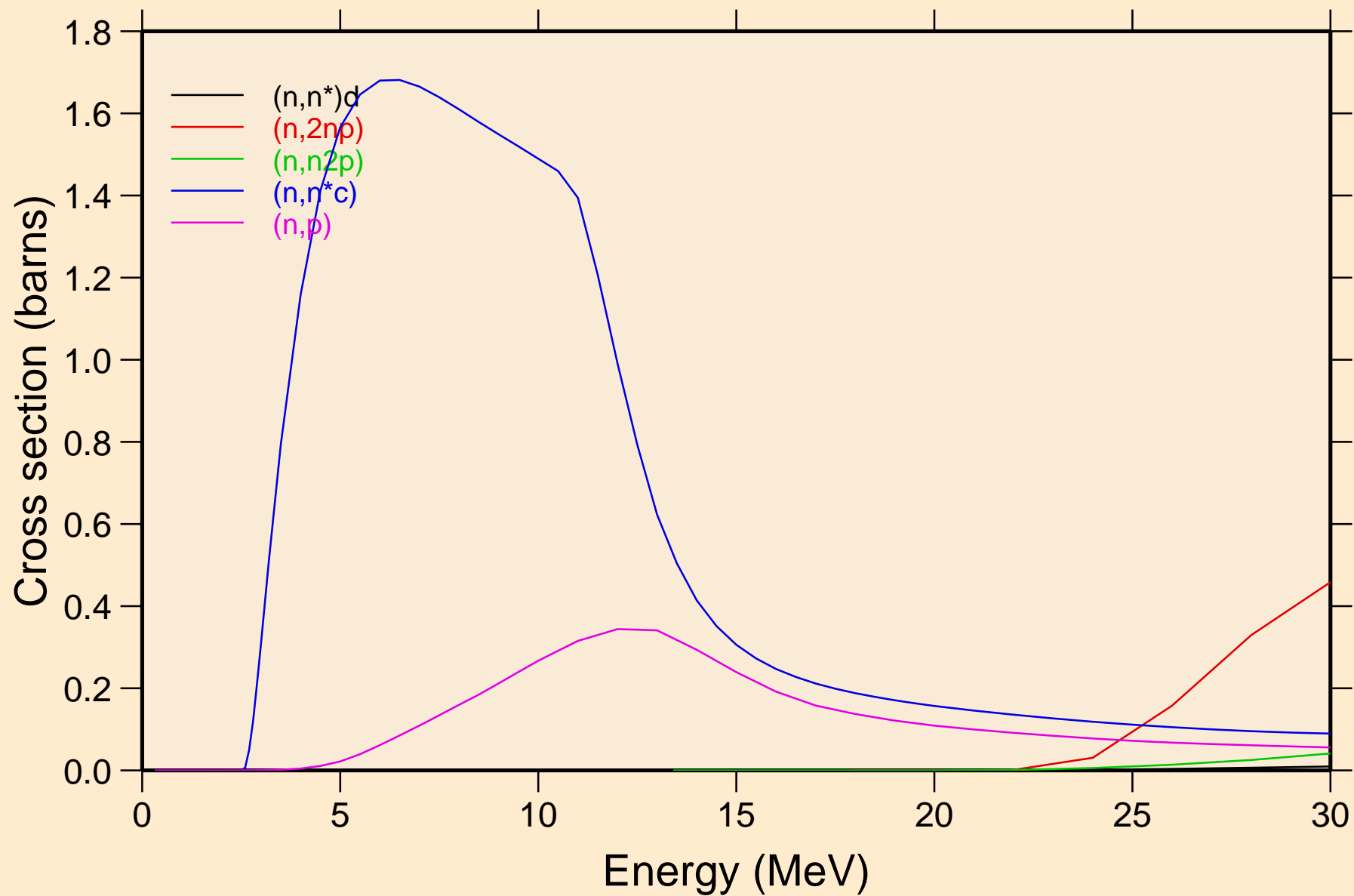

ENDF/B-VII PD-102

Threshold reactions

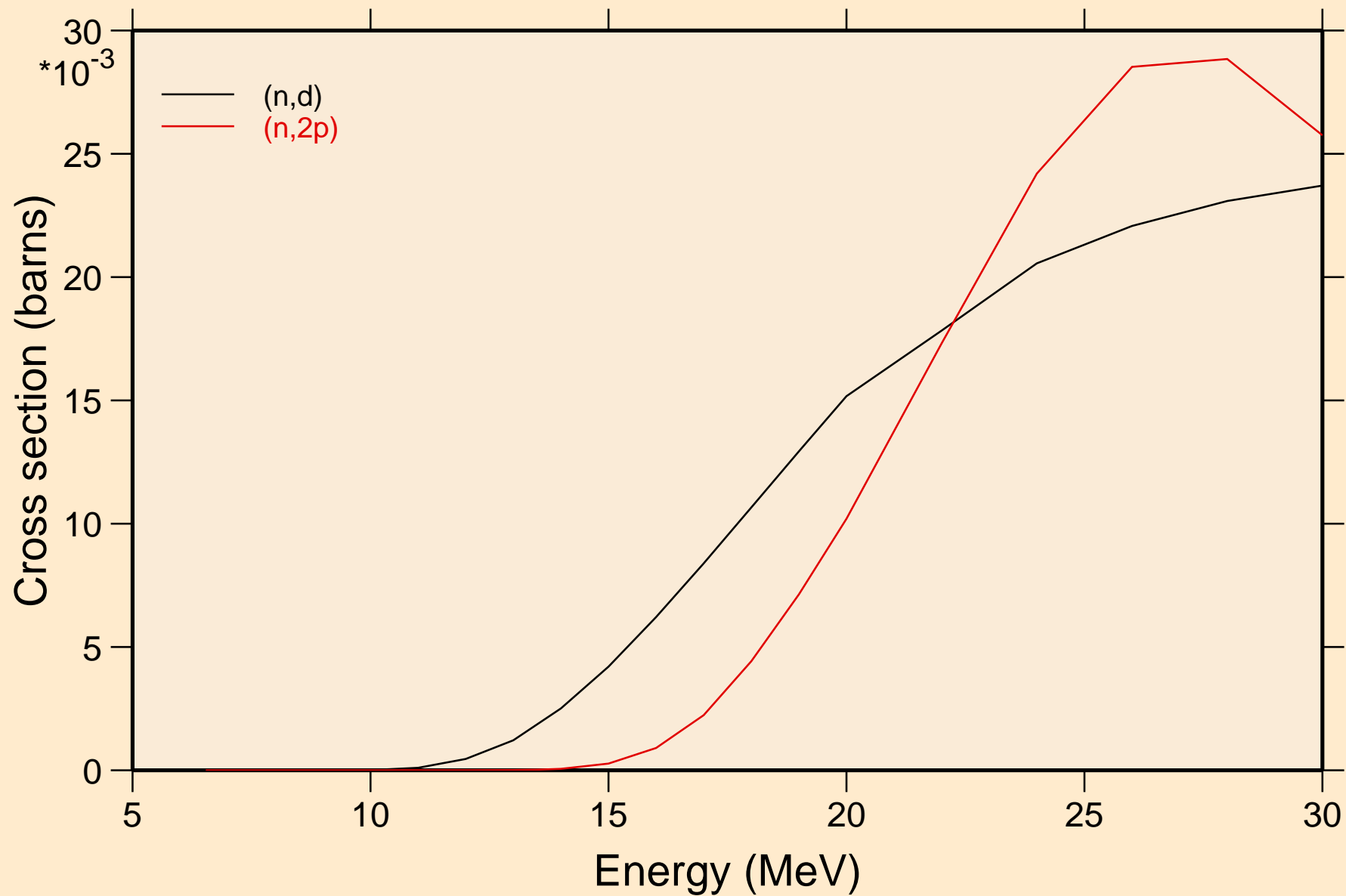

ENDF/B-VII PD-102

Threshold reactions

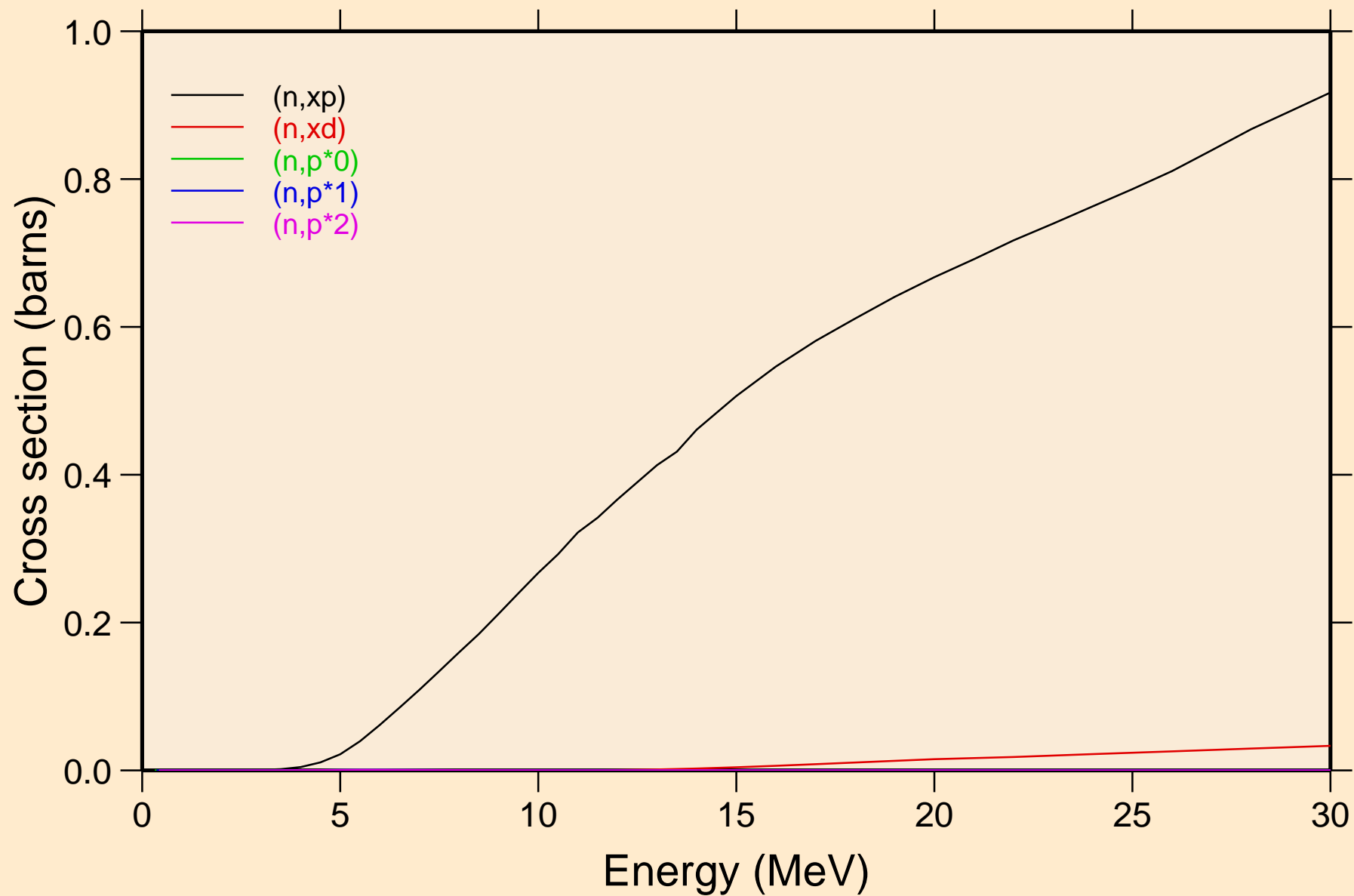

ENDF/B-VII PD-102

Threshold reactions

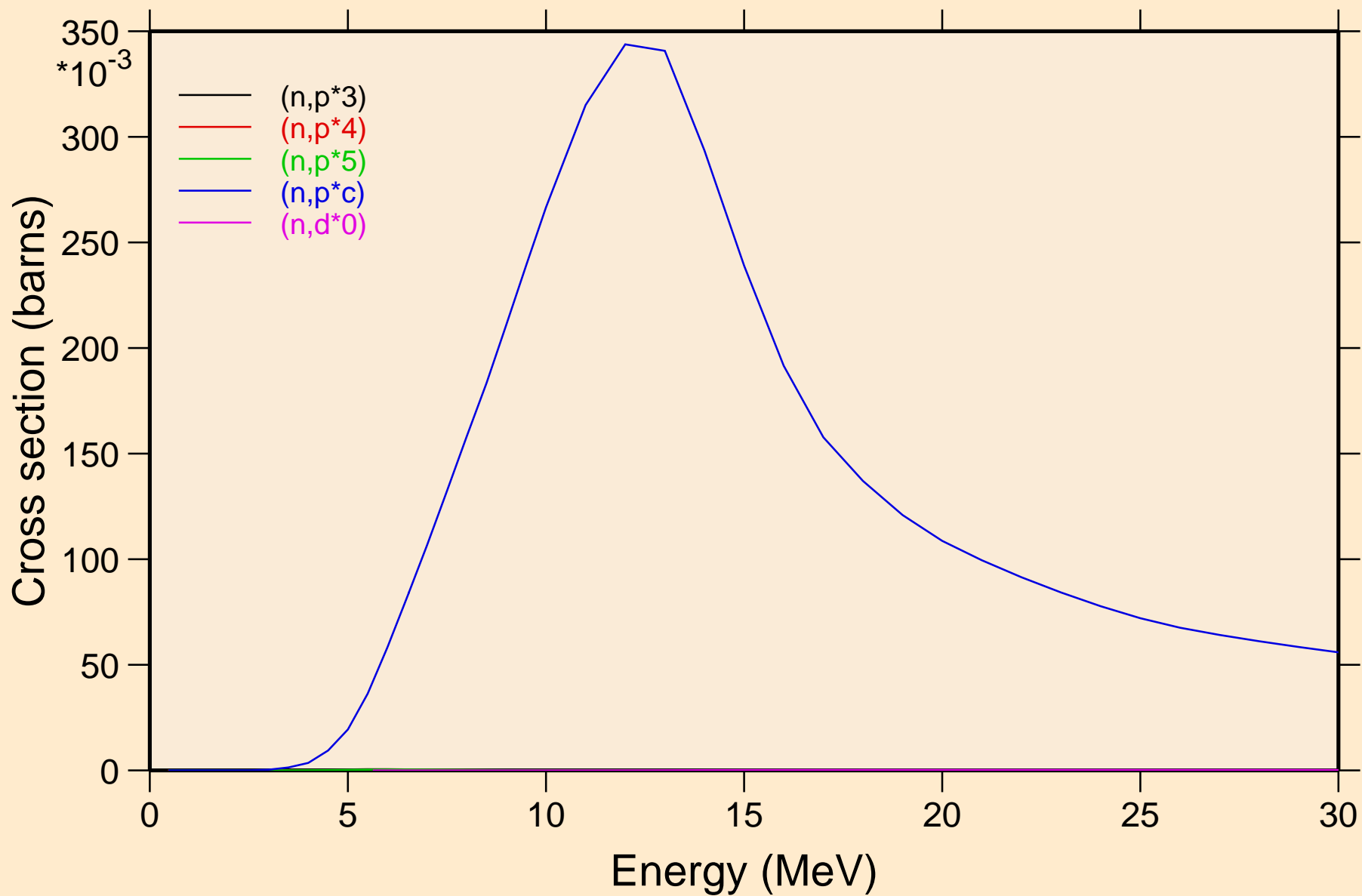

ENDF/B-VII PD-102

Threshold reactions

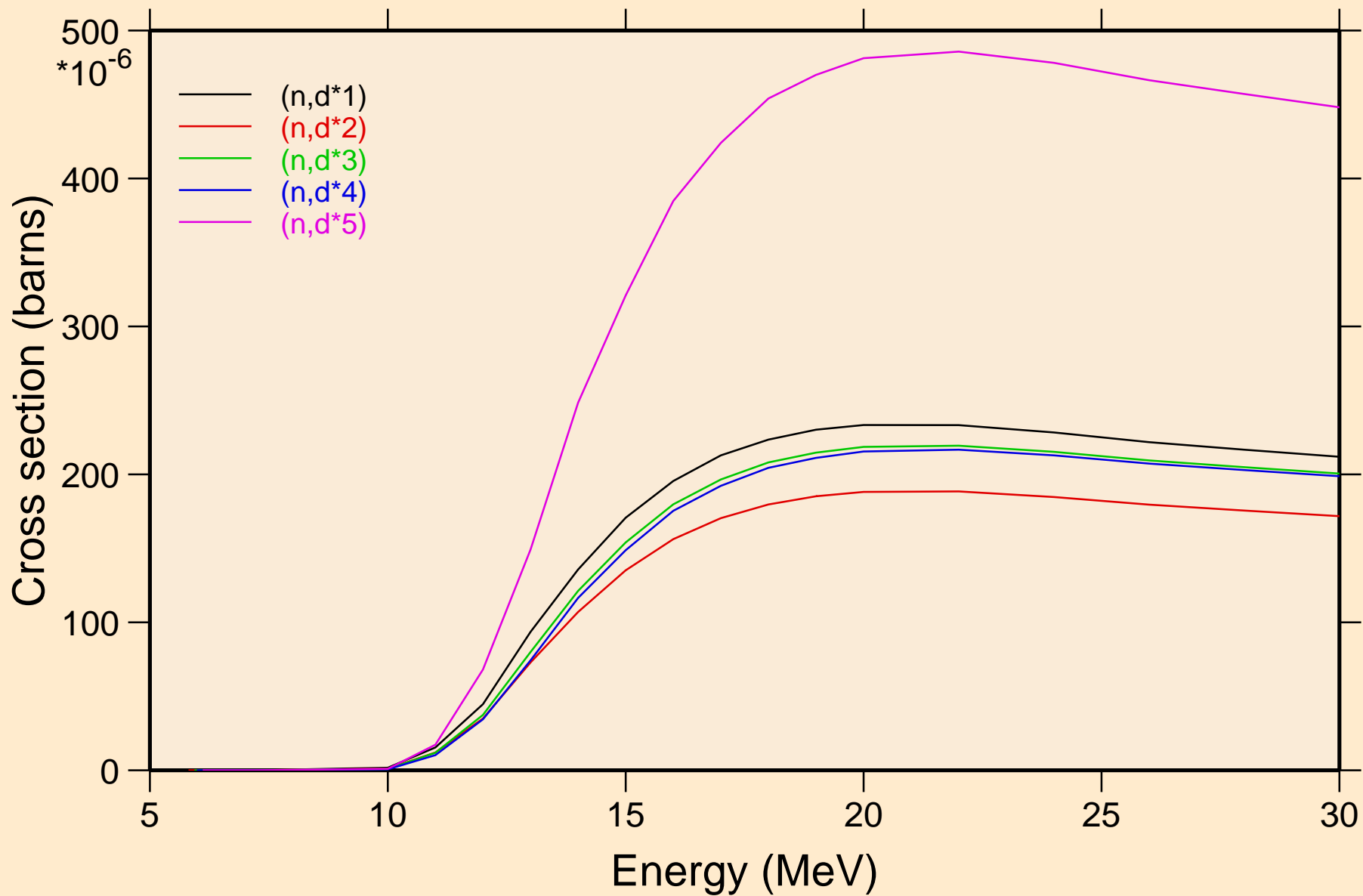

ENDF/B-VII PD-102

Threshold reactions

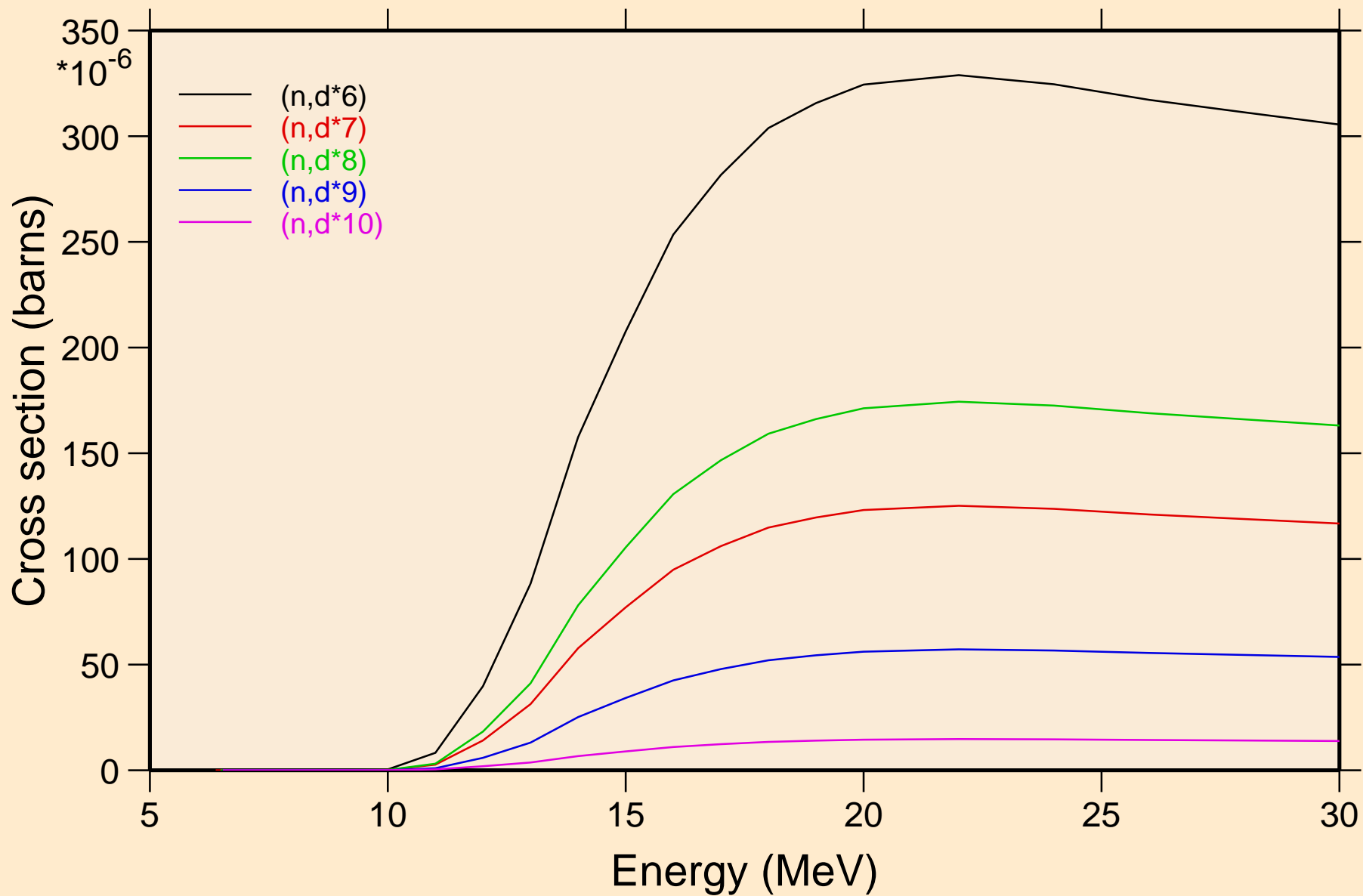

ENDF/B-VII PD-102

Threshold reactions

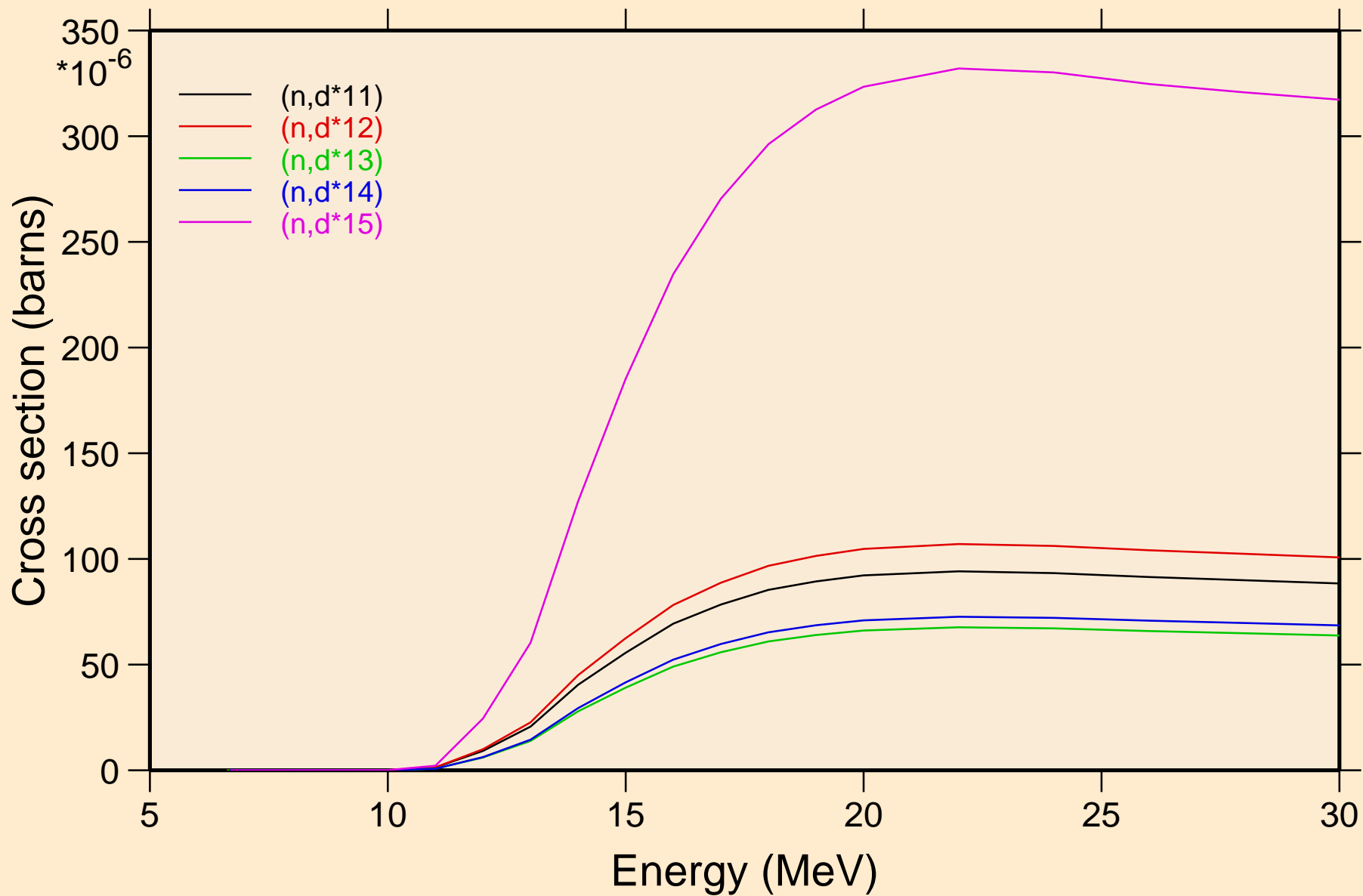

ENDF/B-VII PD-102

Threshold reactions

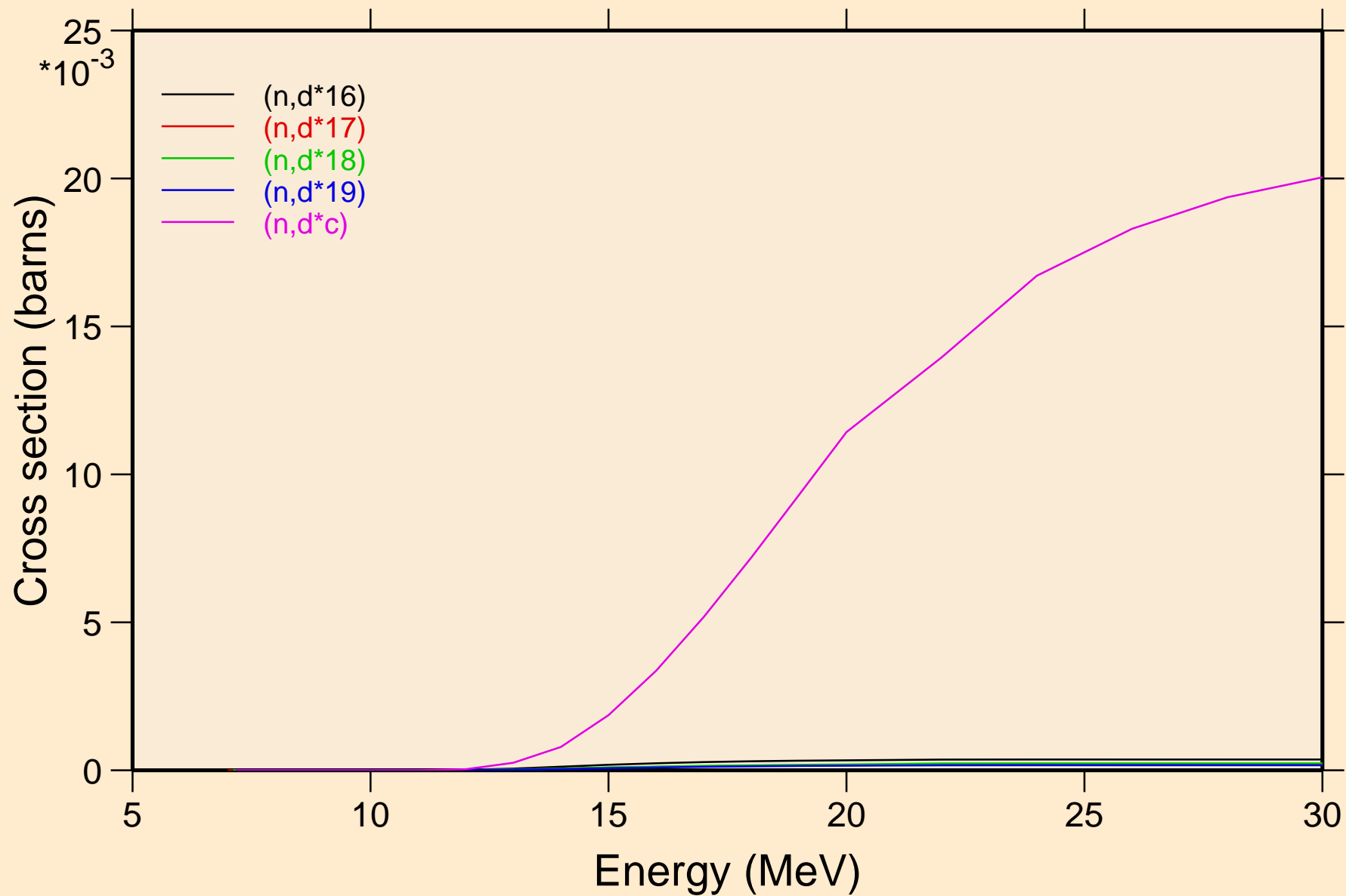

ENDF/B-VII PD-102
angular distribution for elastic

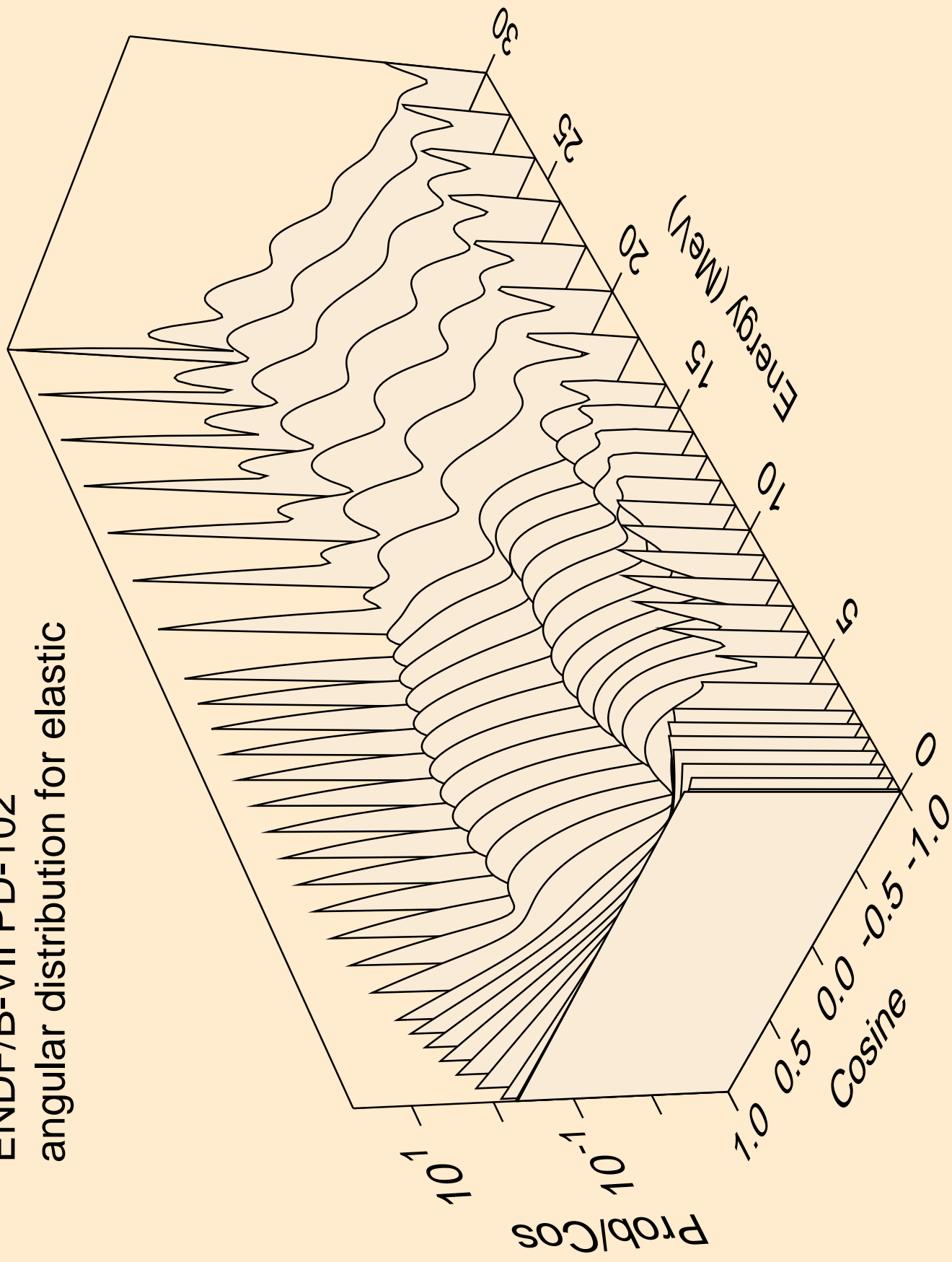

ENDF/B-VII PD-102
angular distribution for (n,n*1)

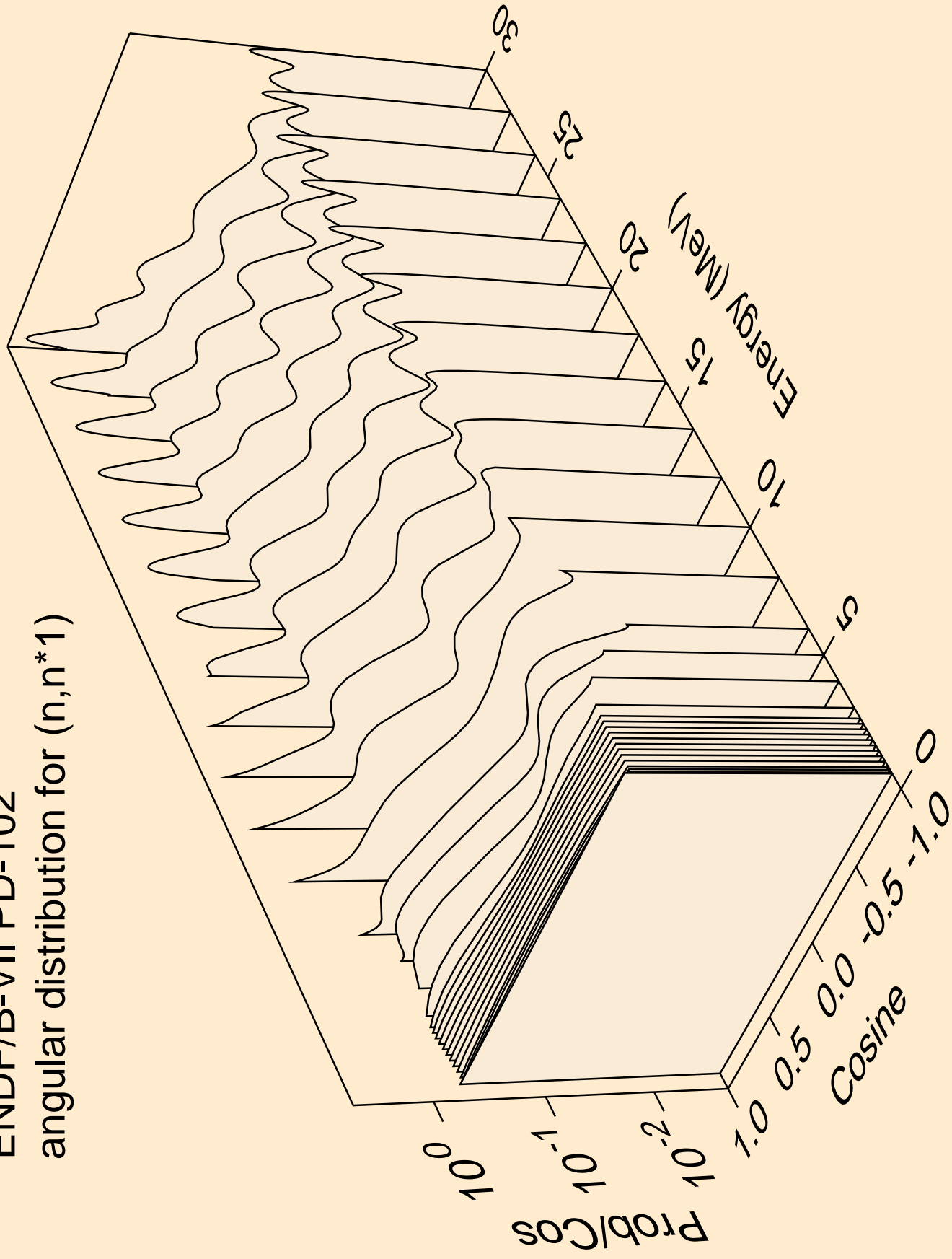

ENDF/B-VII PD-102
angular distribution for (n,n*2)

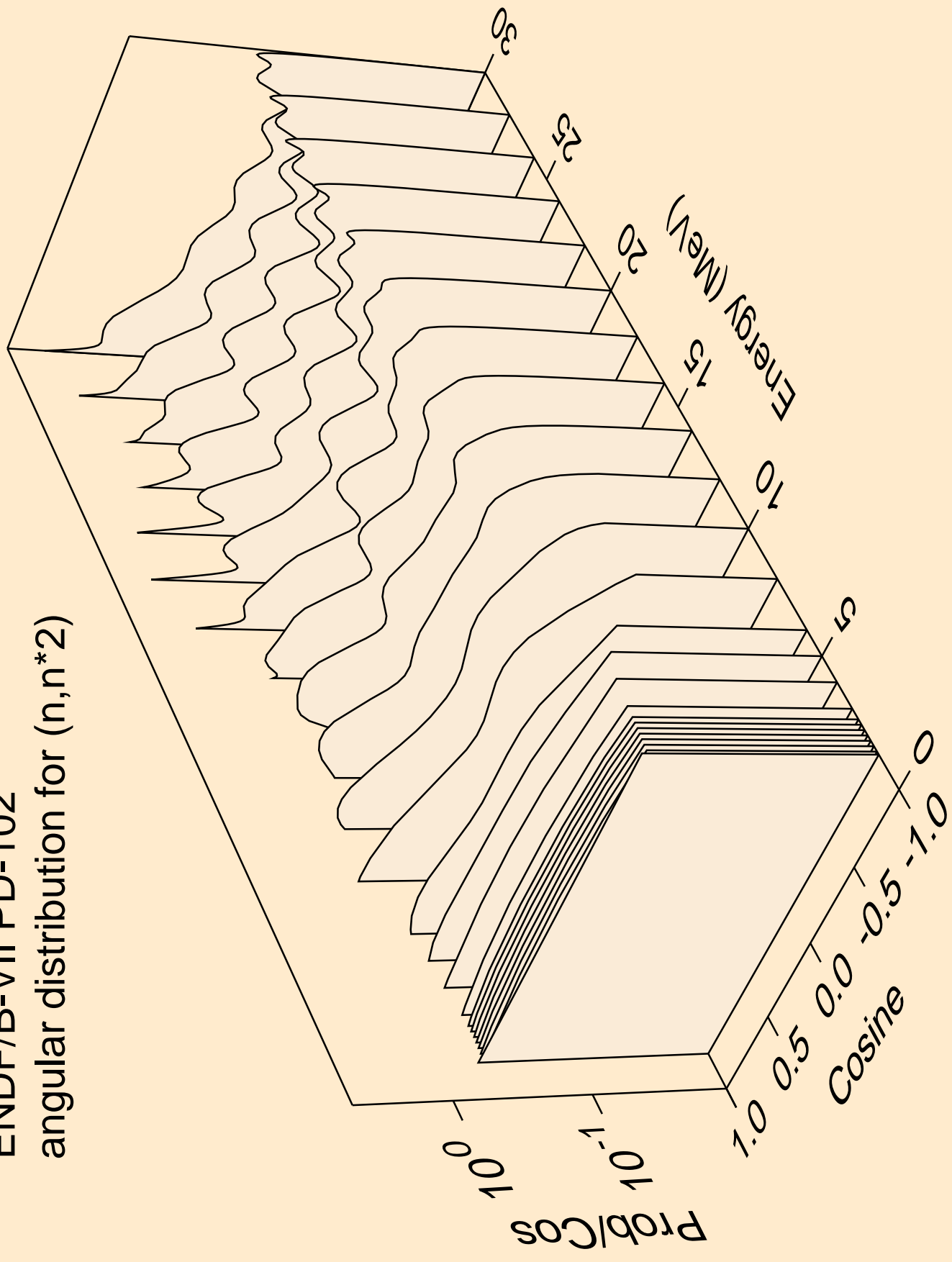

ENDF/B-VII PD-102
angular distribution for (n,n*3)

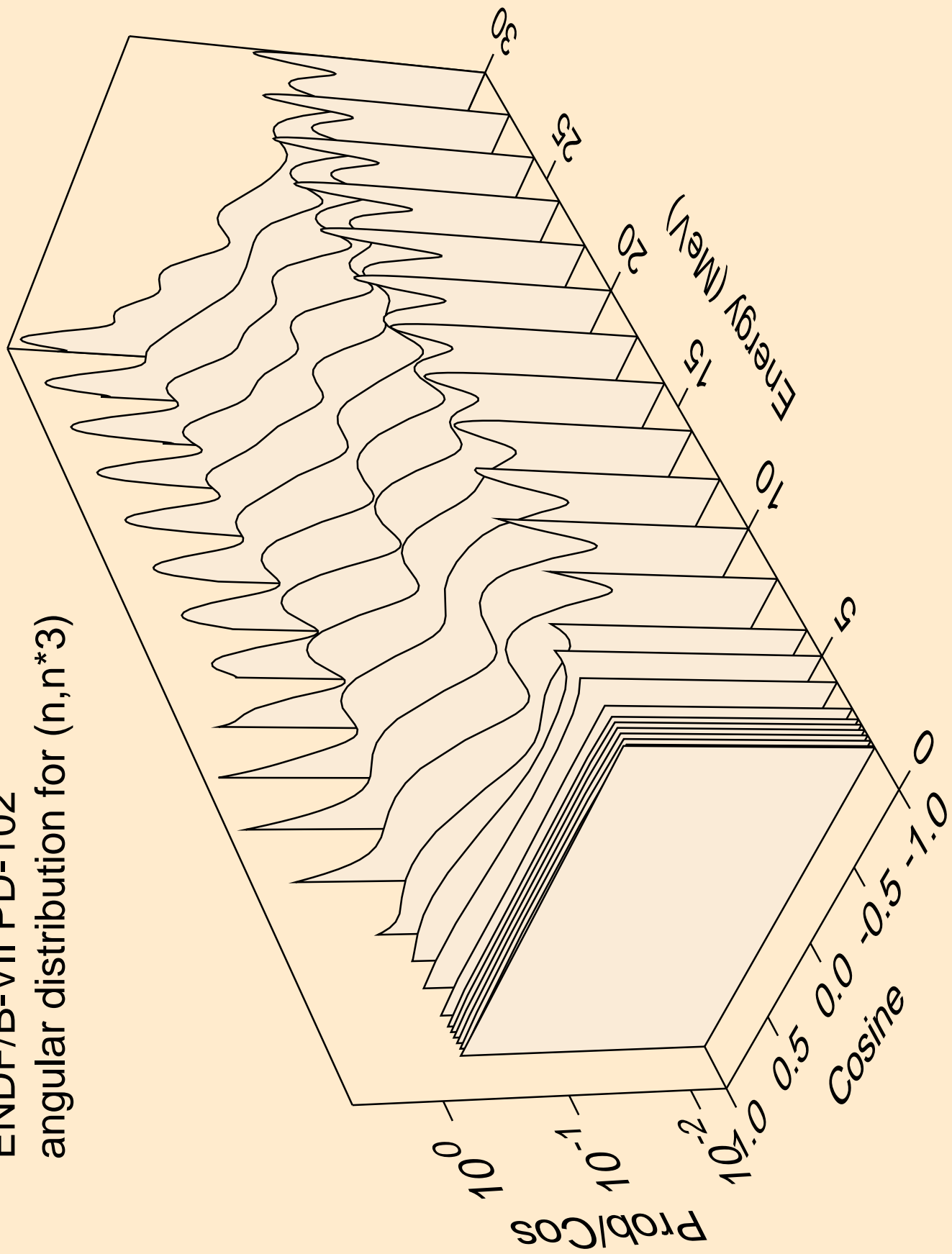

ENDF/B-VII PD-102
angular distribution for (n,n*4)

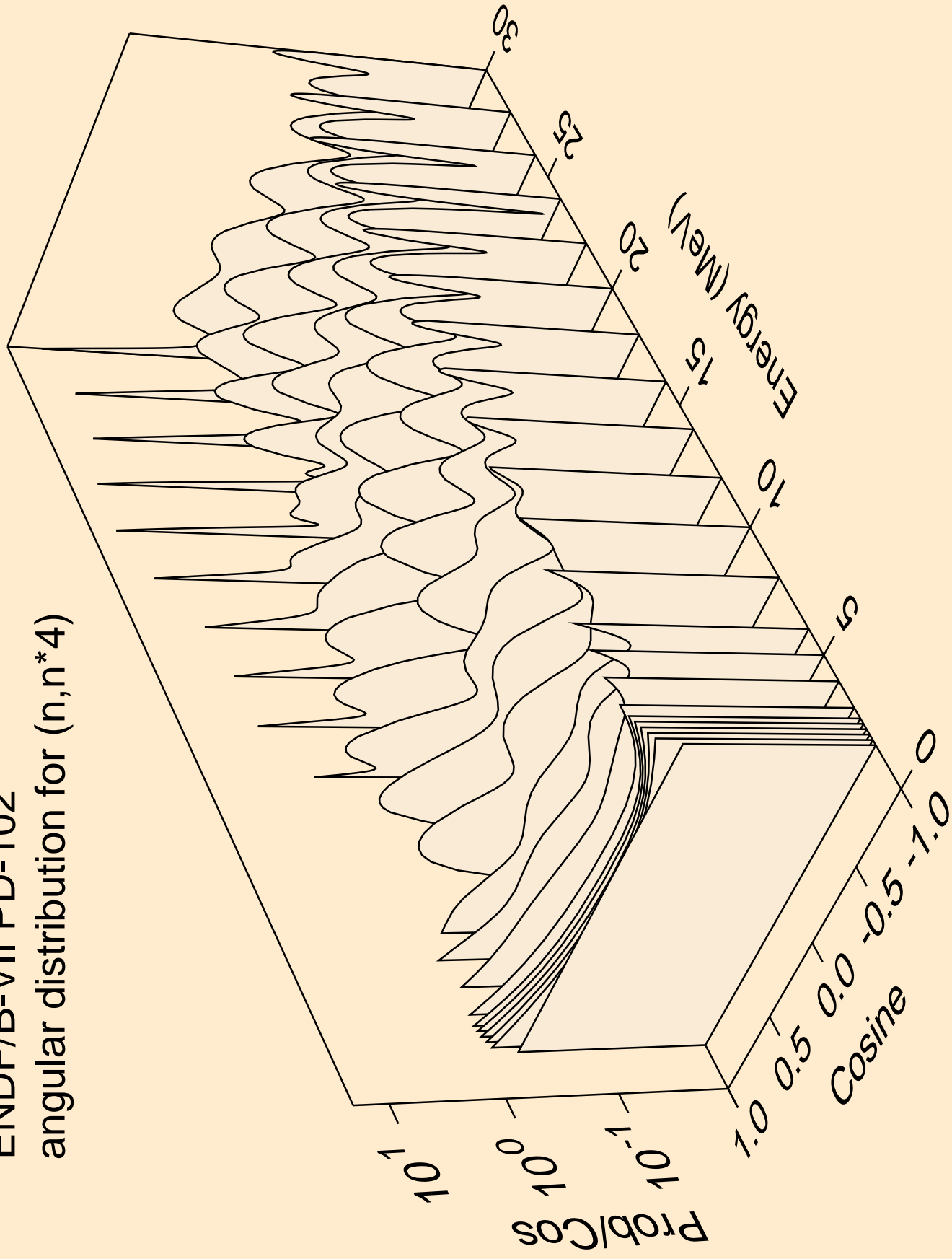

ENDF/B-VII PD-102
angular distribution for (n,n*5)

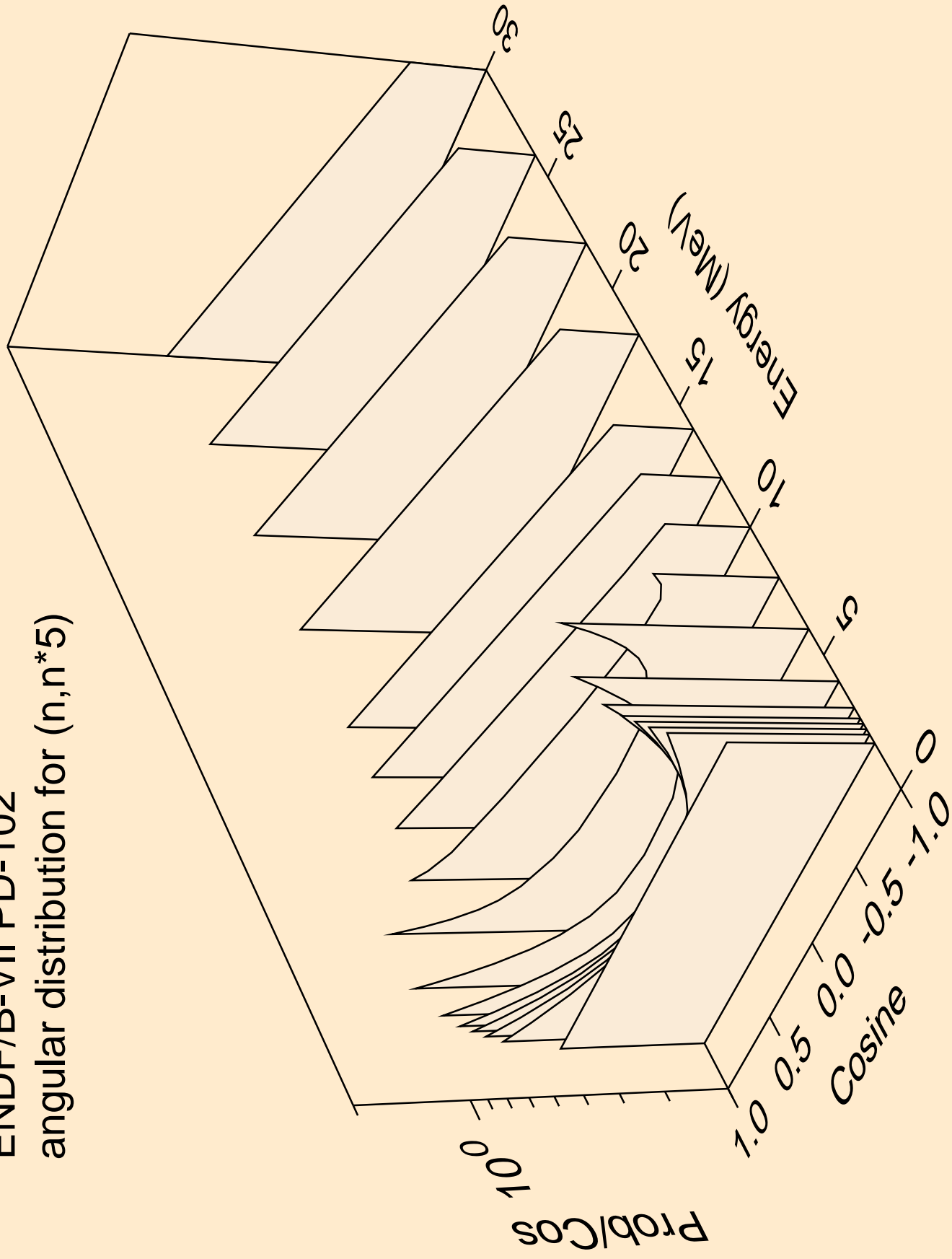

ENDF/B-VII PD-102
angular distribution for (n,n*6)

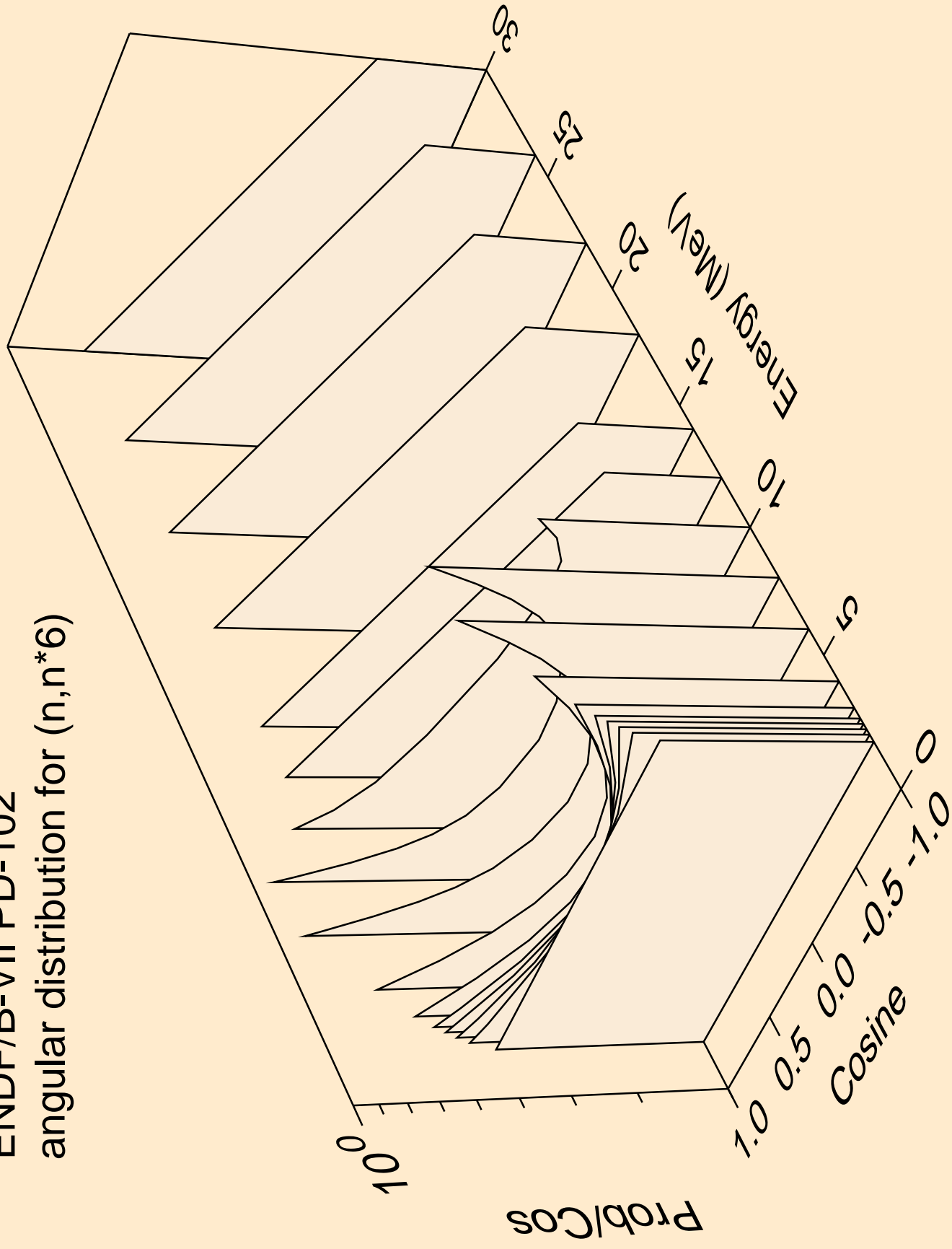

ENDF/B-VII PD-102
angular distribution for (n,n*7)

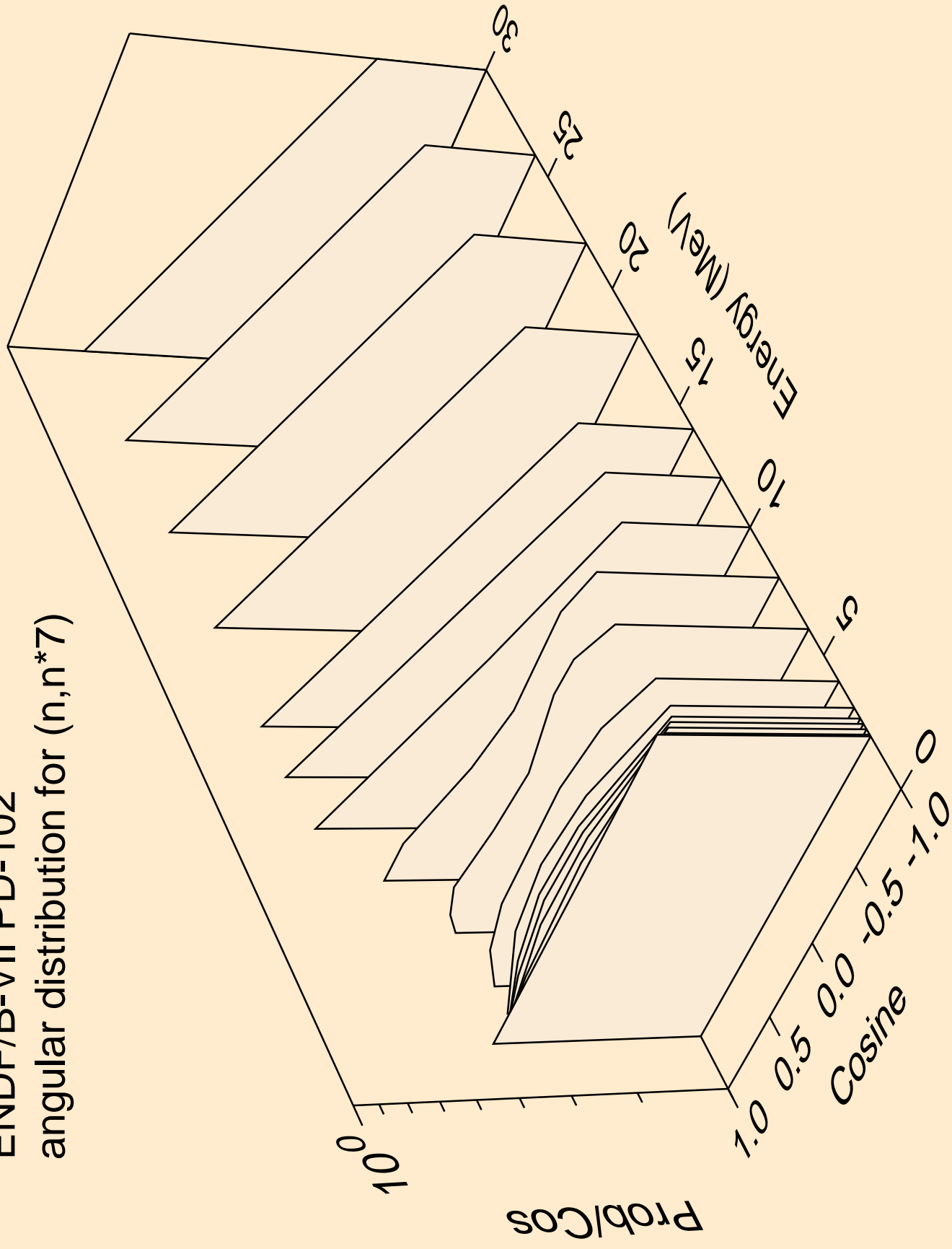

ENDF/B-VII PD-102
angular distribution for (n,n*8)

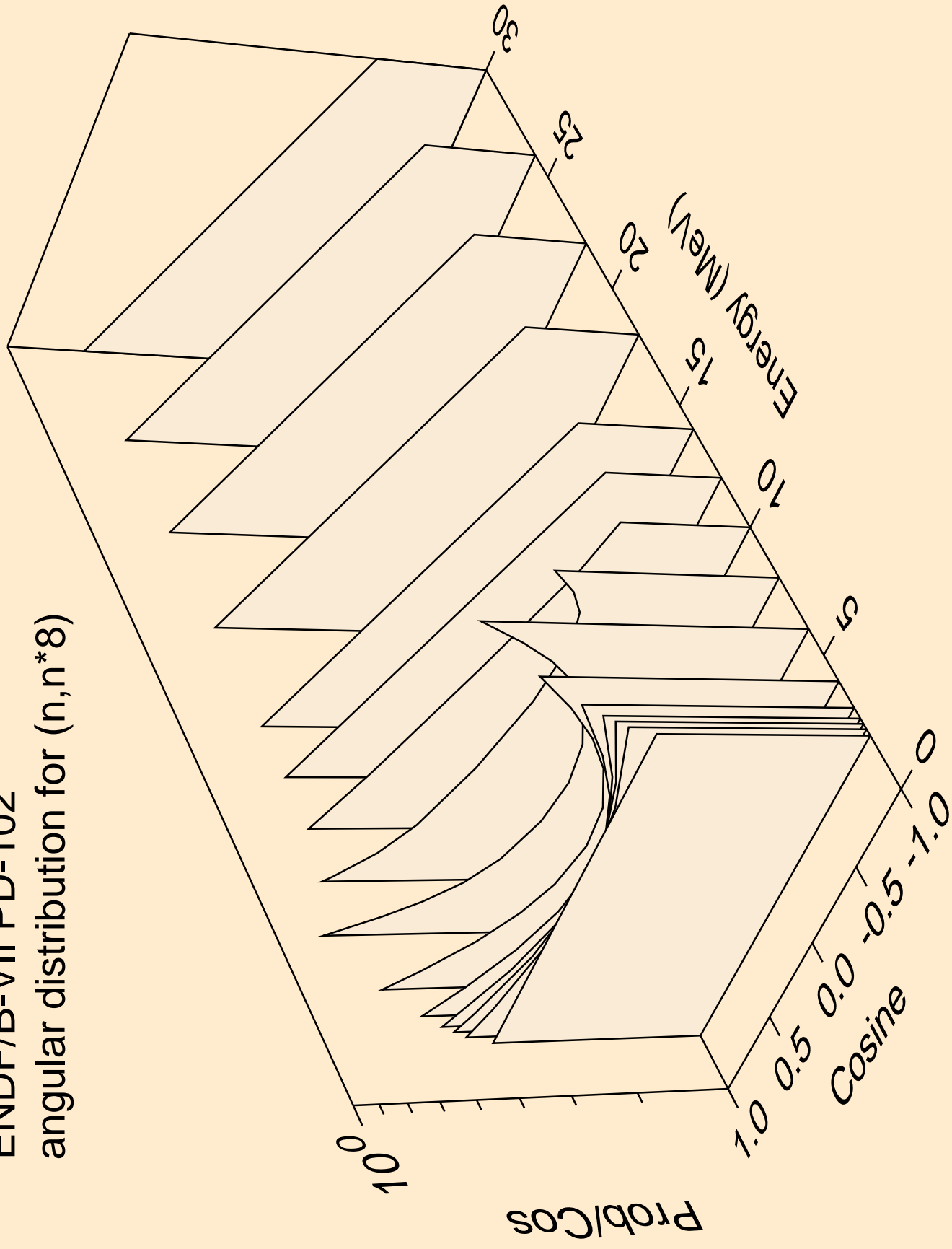

ENDF/B-VII PD-102
angular distribution for (n,n*9)

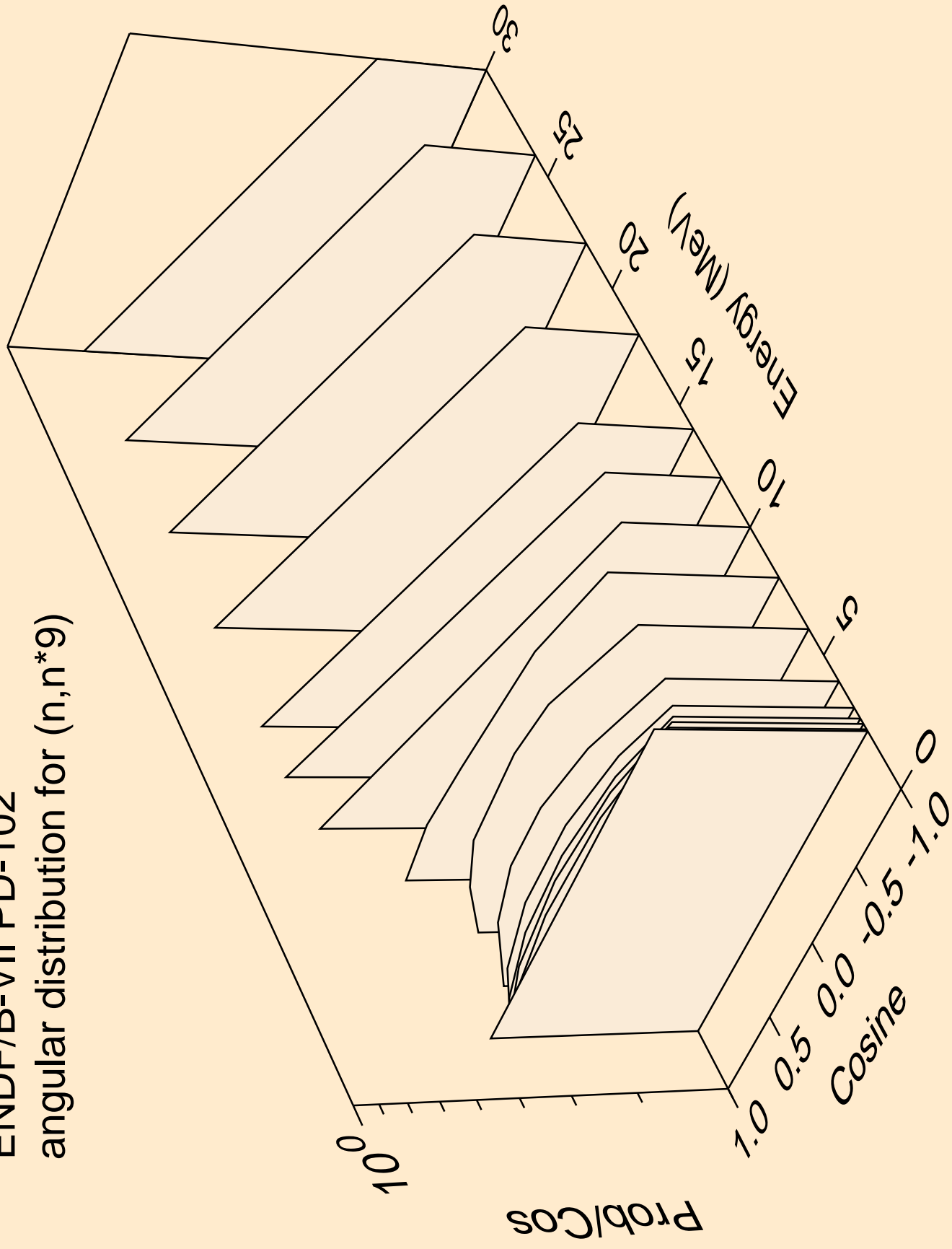

ENDF/B-VII PD-102
angular distribution for (n,n*10)

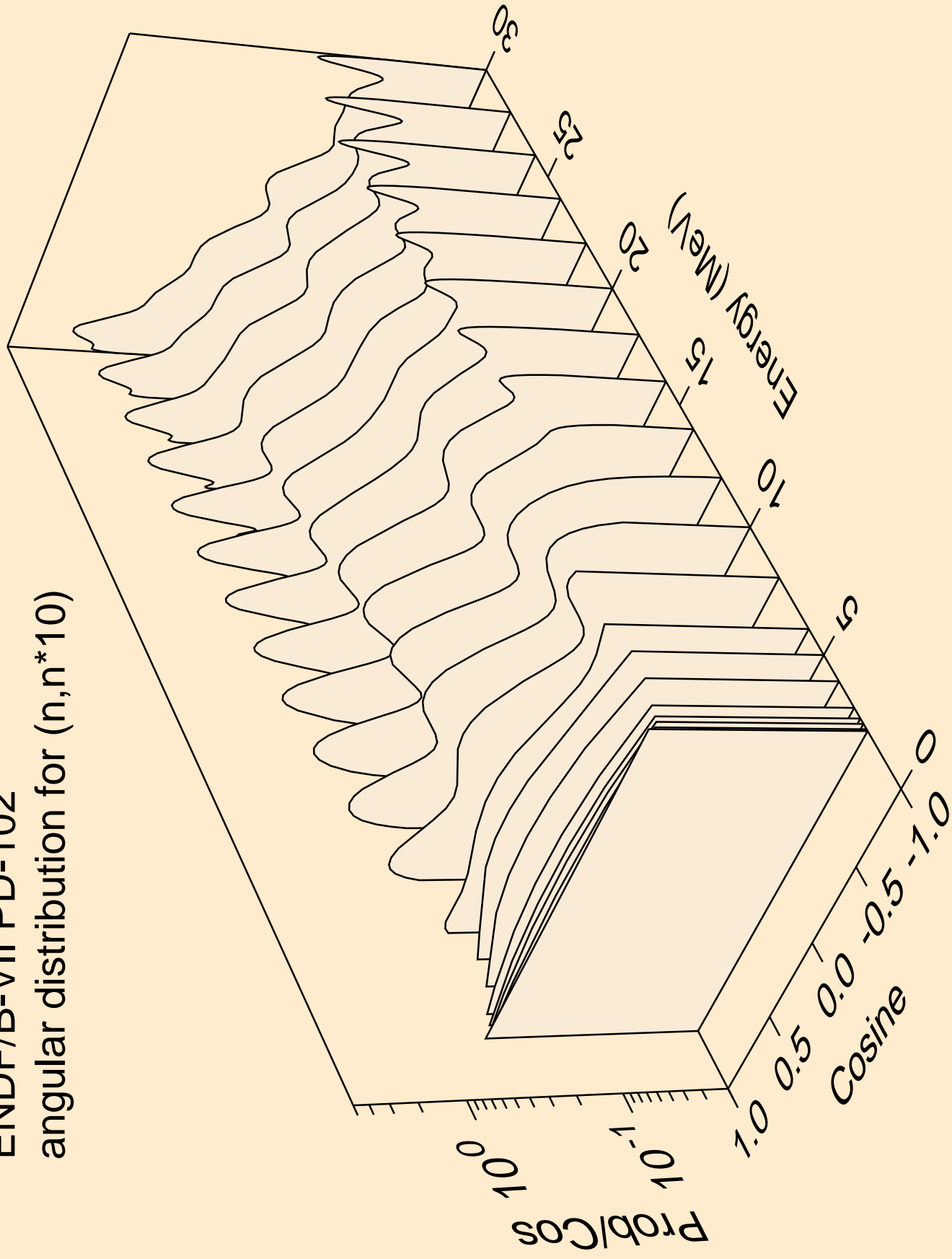

ENDF/B-VII PD-102
angular distribution for (n,n*11)

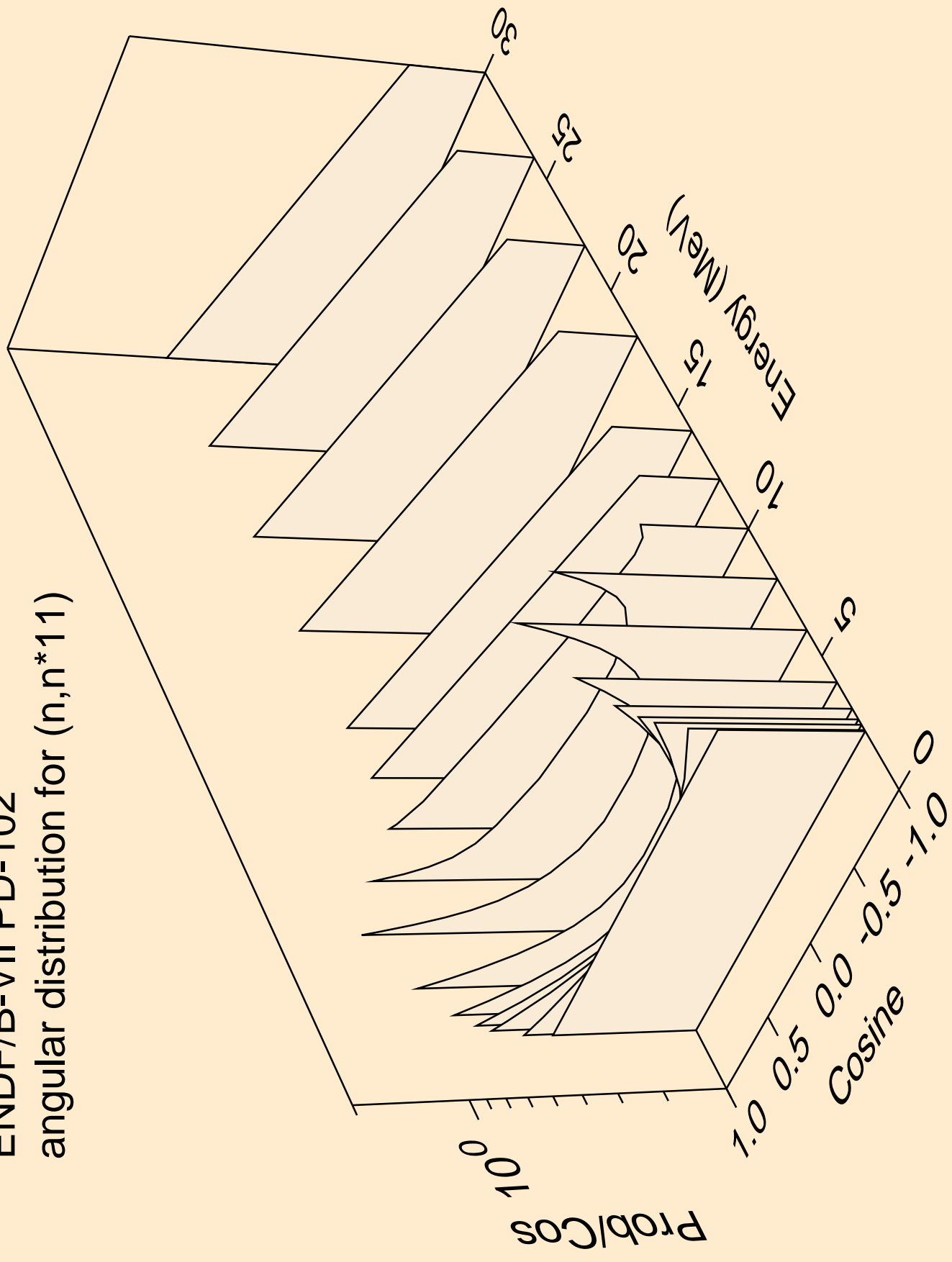

ENDF/B-VII PD-102
angular distribution for (n,n*12)

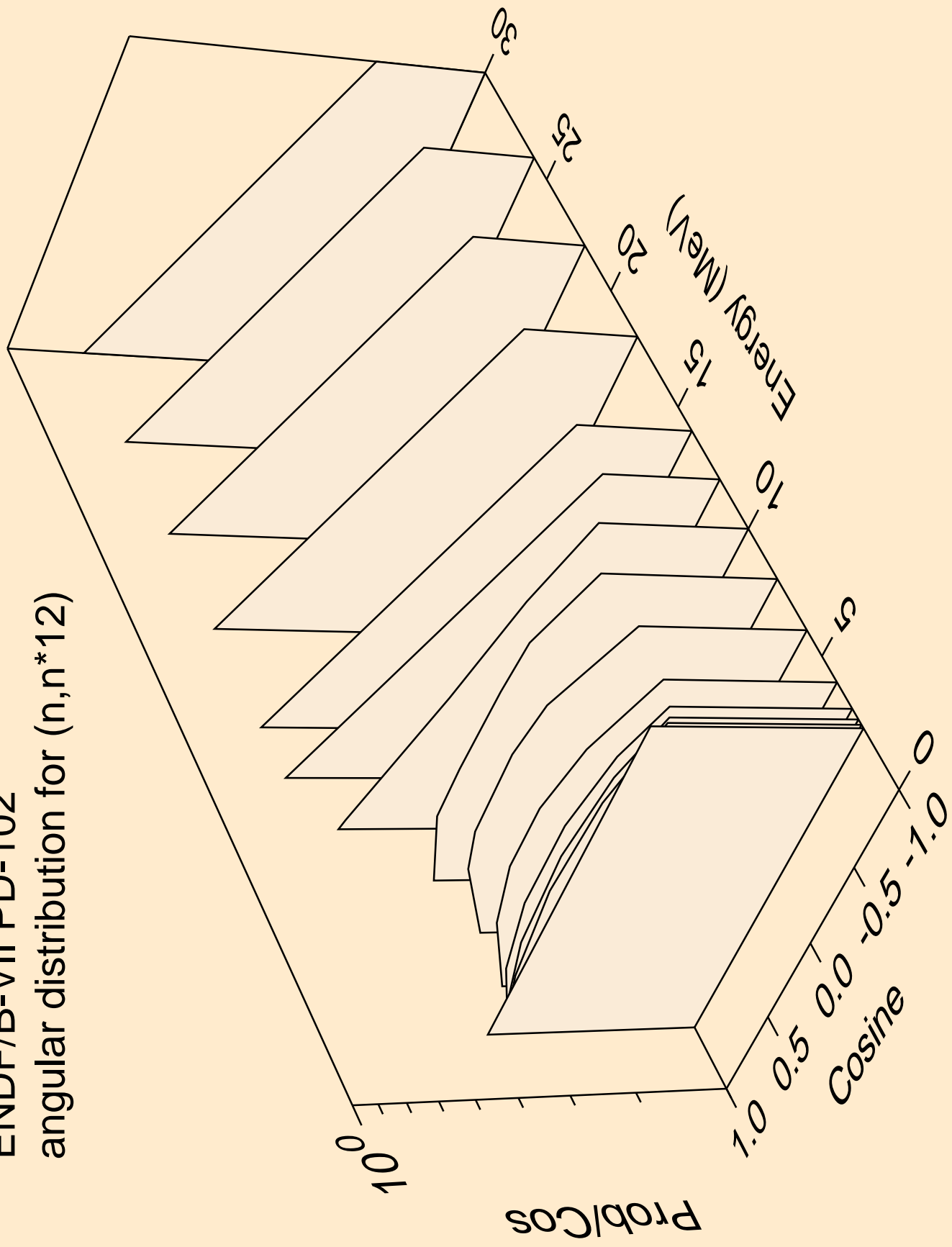

ENDF/B-VII PD-102
angular distribution for (n,n*13)

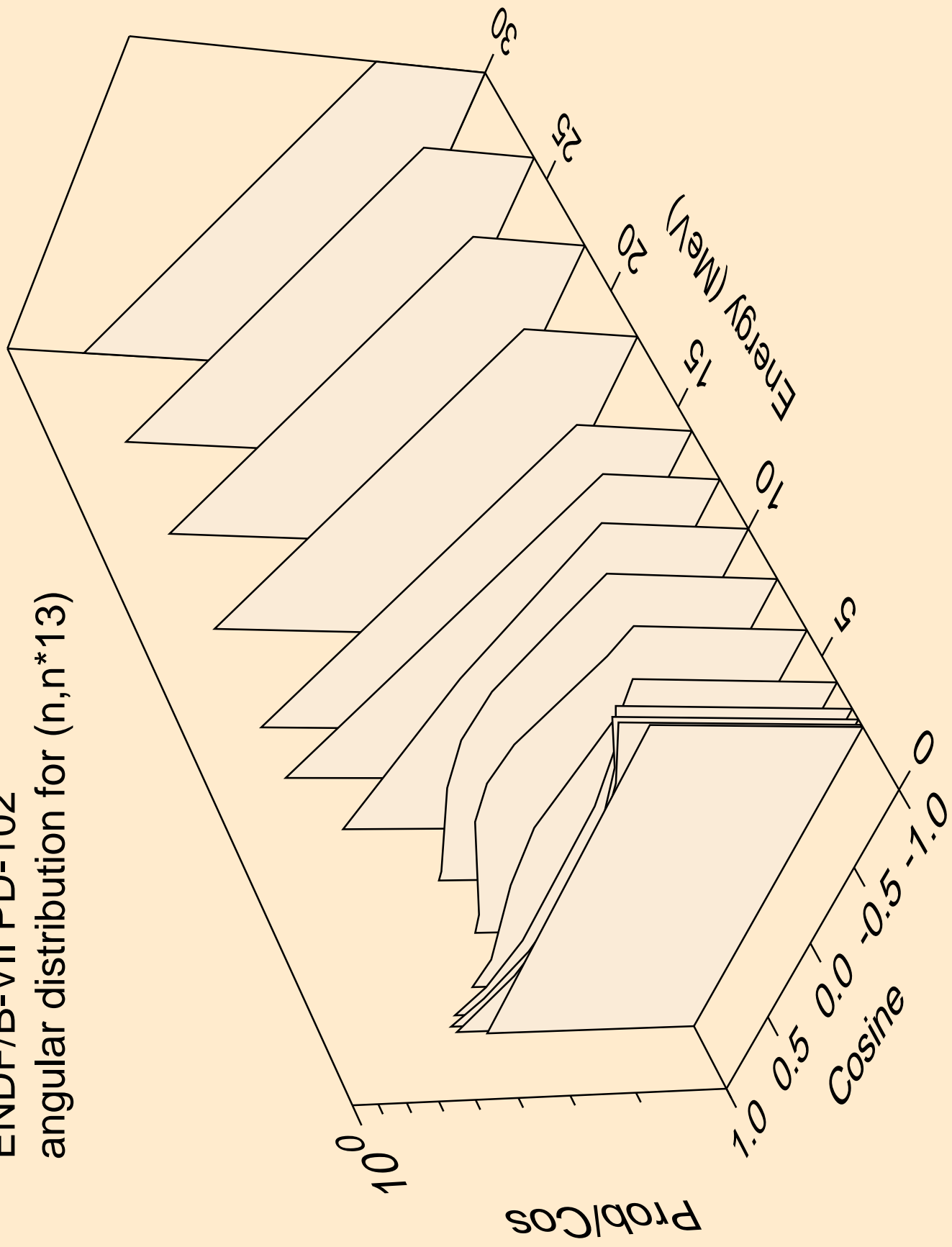

ENDF/B-VII PD-102
angular distribution for (n,n*14)

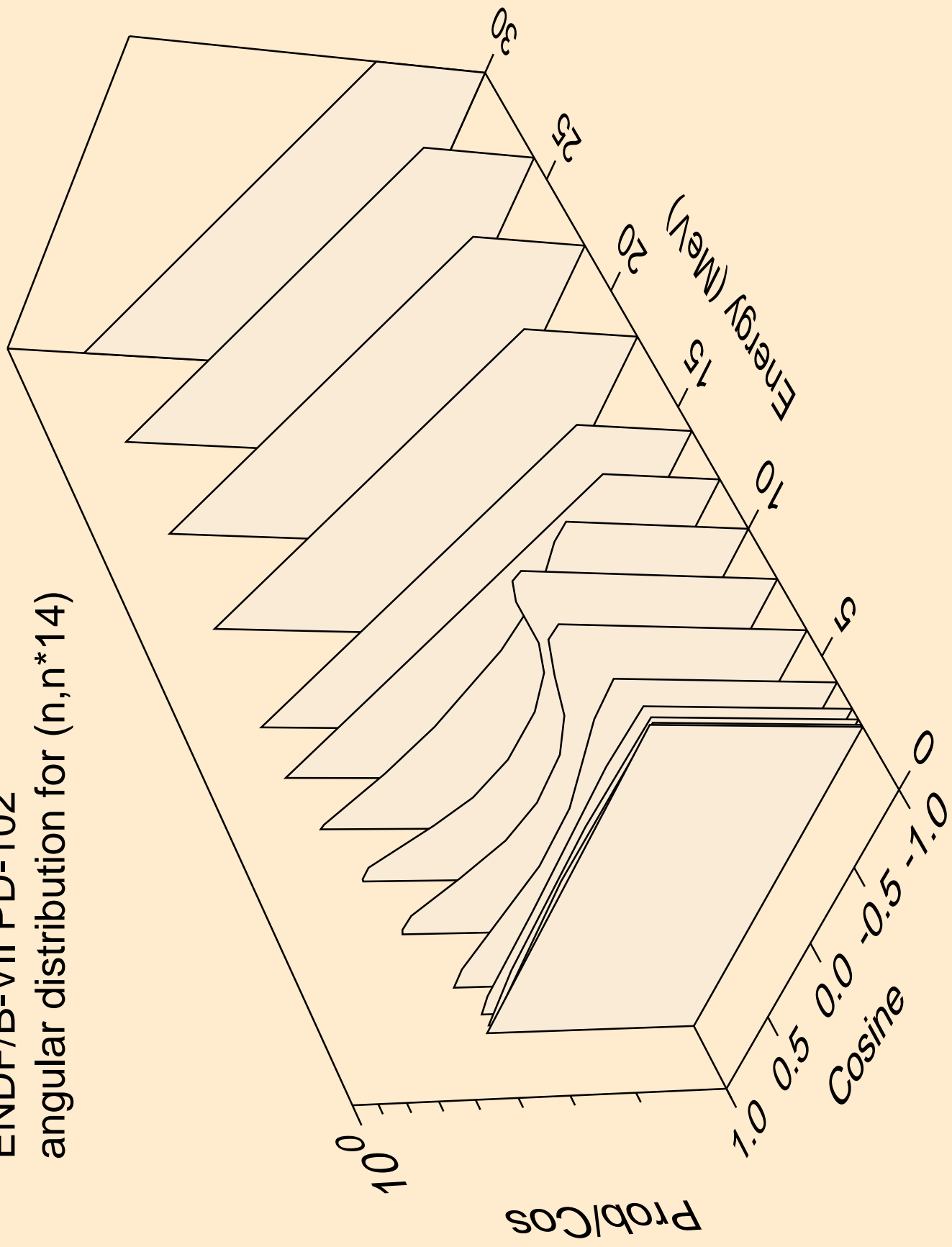

ENDF/B-VII PD-102
angular distribution for (n,n*15)

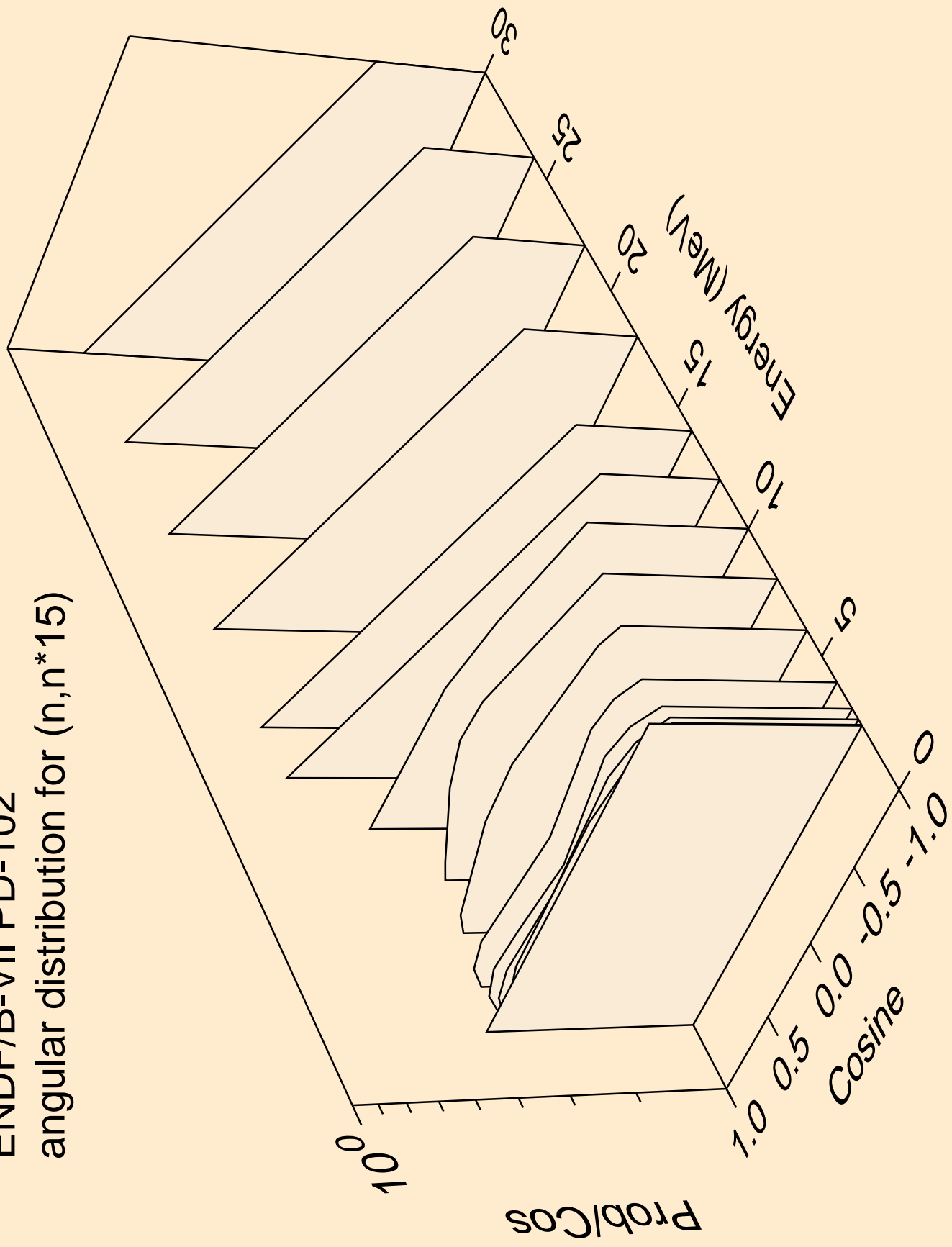

ENDF/B-VII PD-102
angular distribution for (n,n*16)

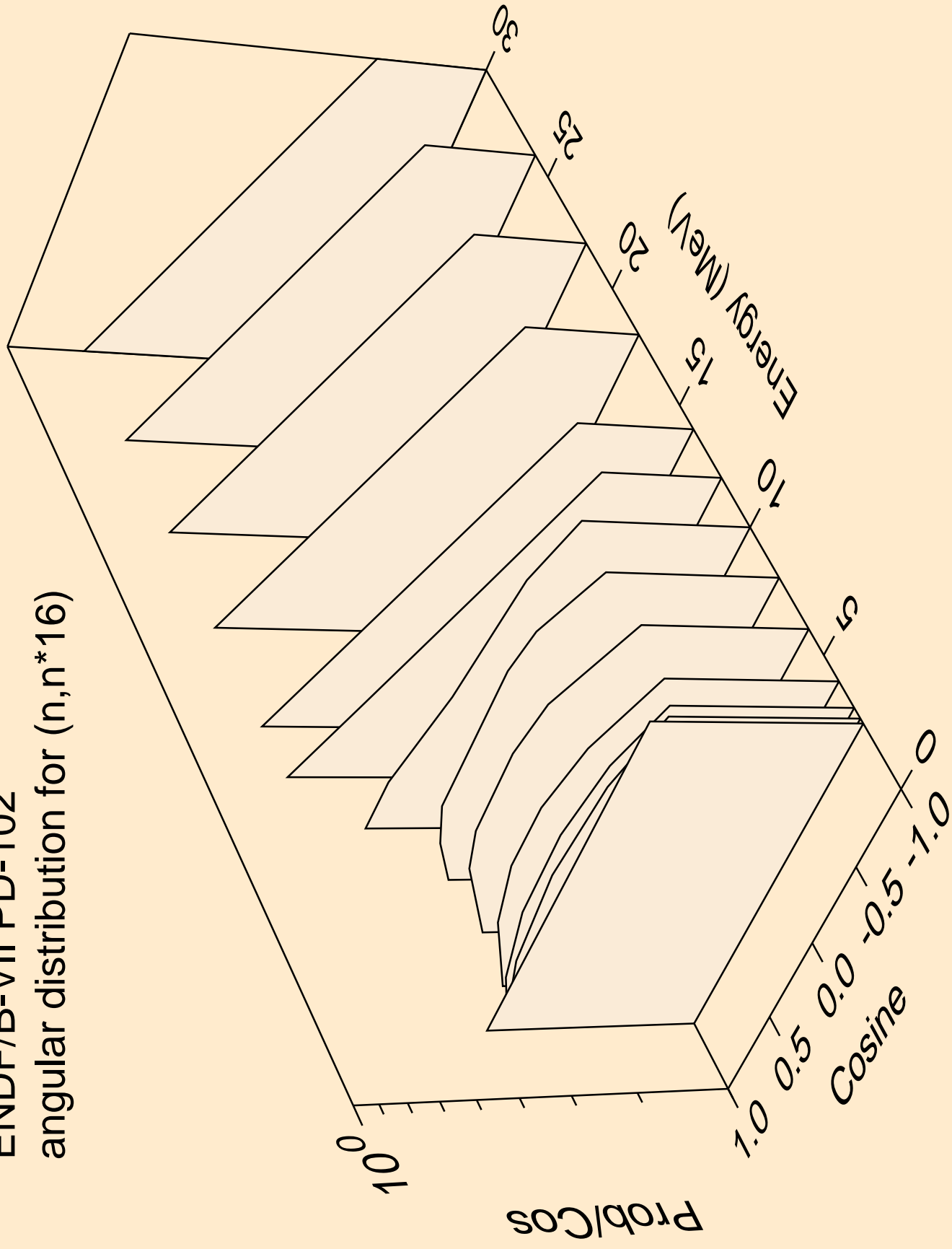

ENDF/B-VII PD-102
angular distribution for (n,n*17)

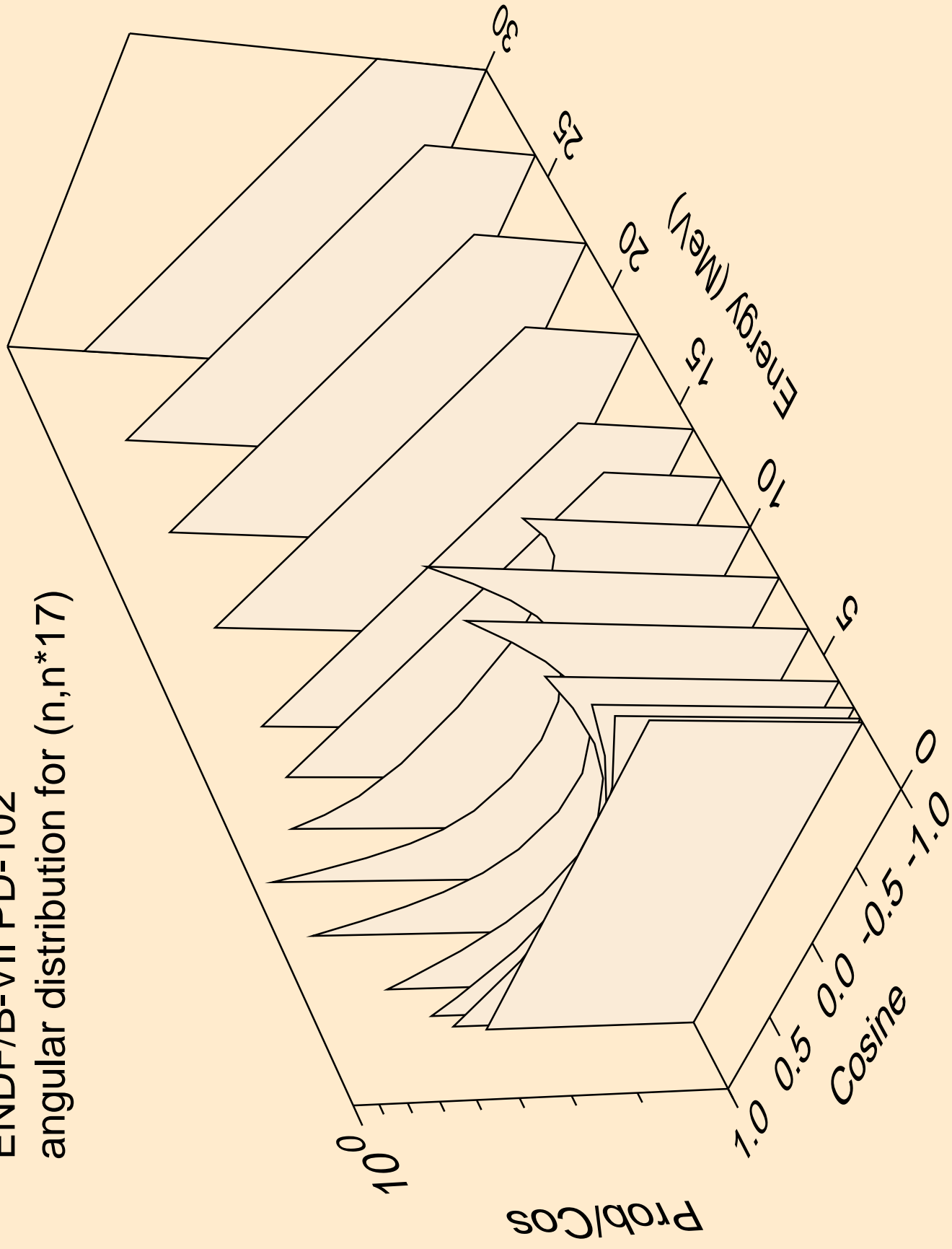

ENDF/B-VII PD-102
angular distribution for (n,n*18)

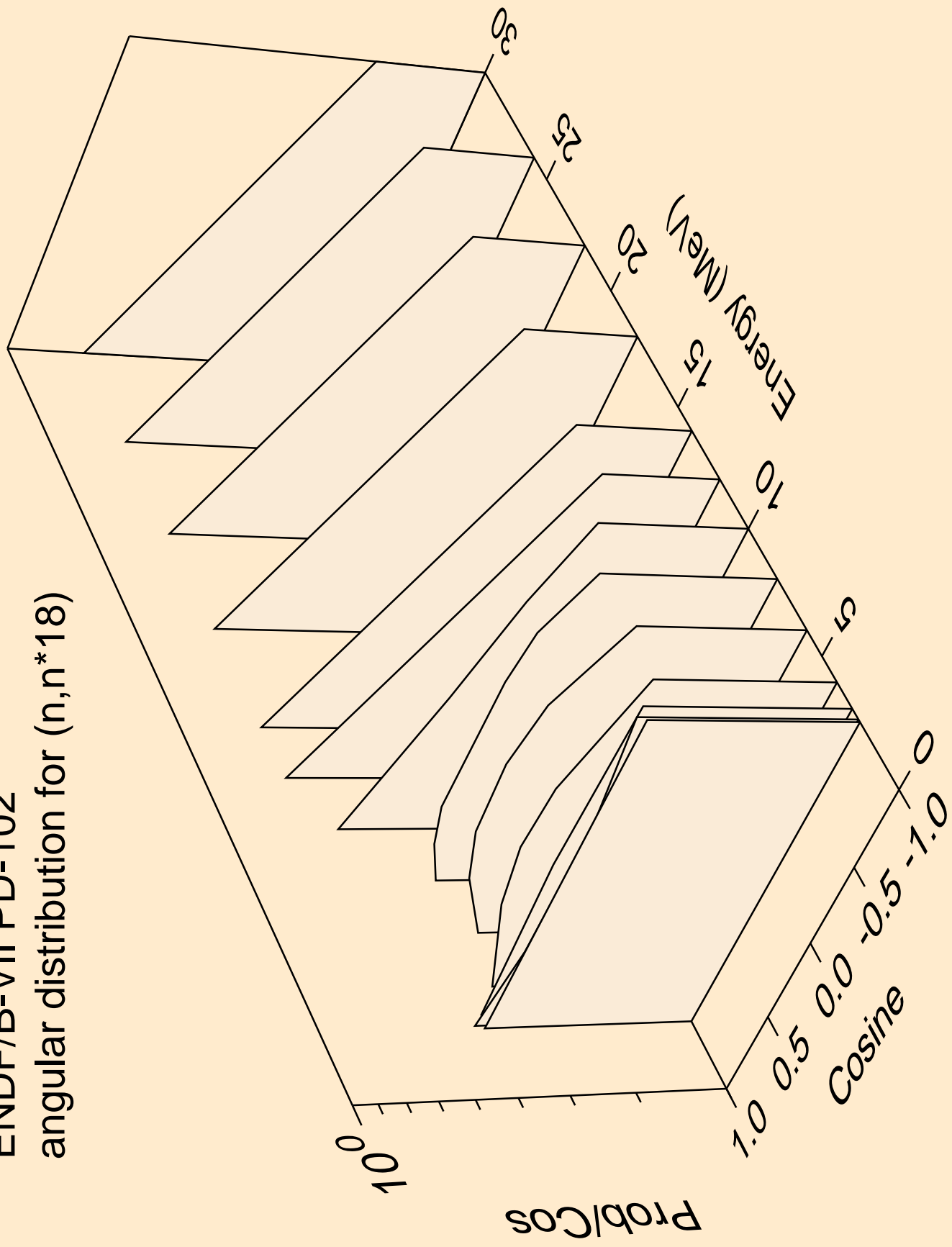

ENDF/B-VII PD-102
angular distribution for (n,n*19)

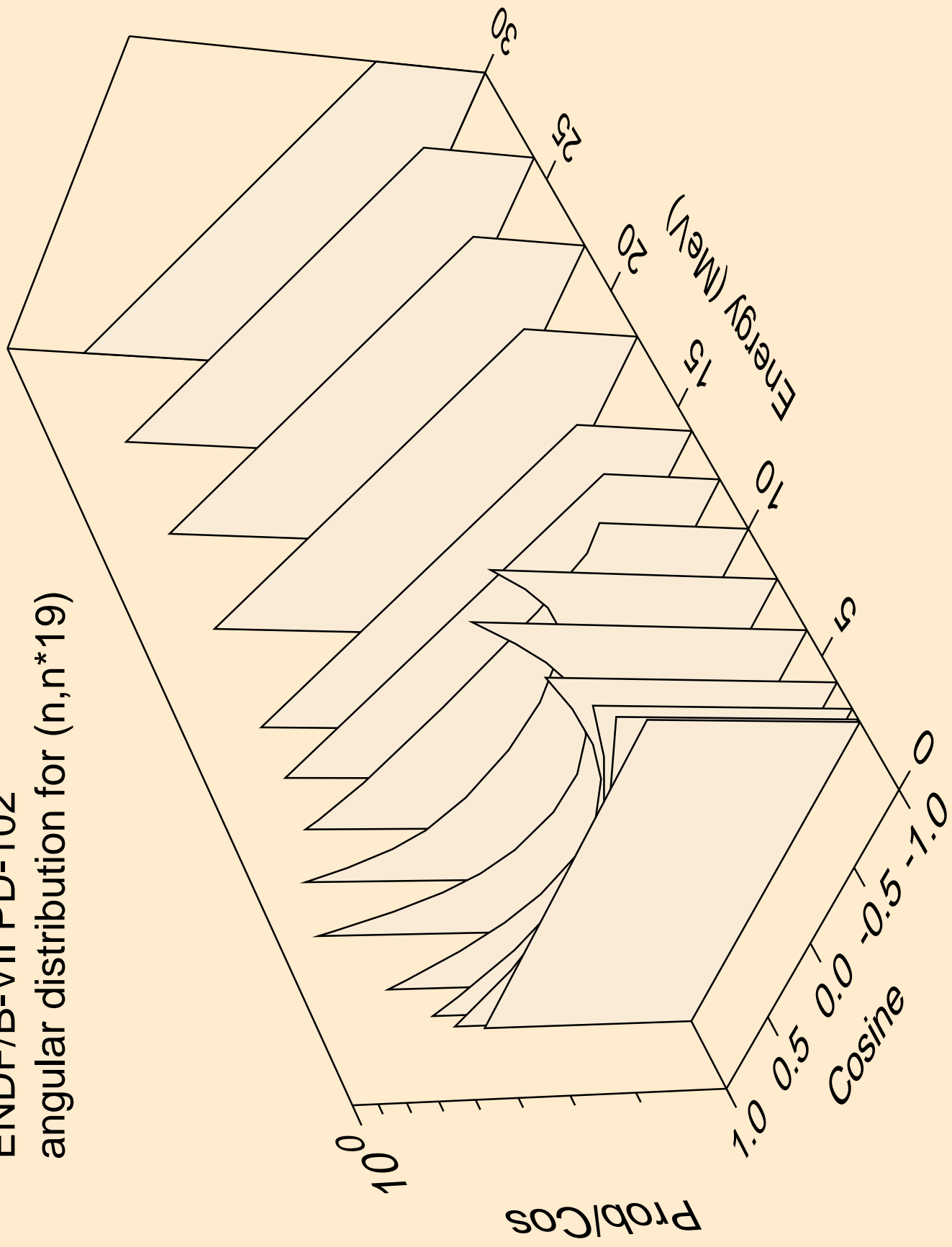

ENDF/B-VII PD-102
Neutron emission for (n,2n)

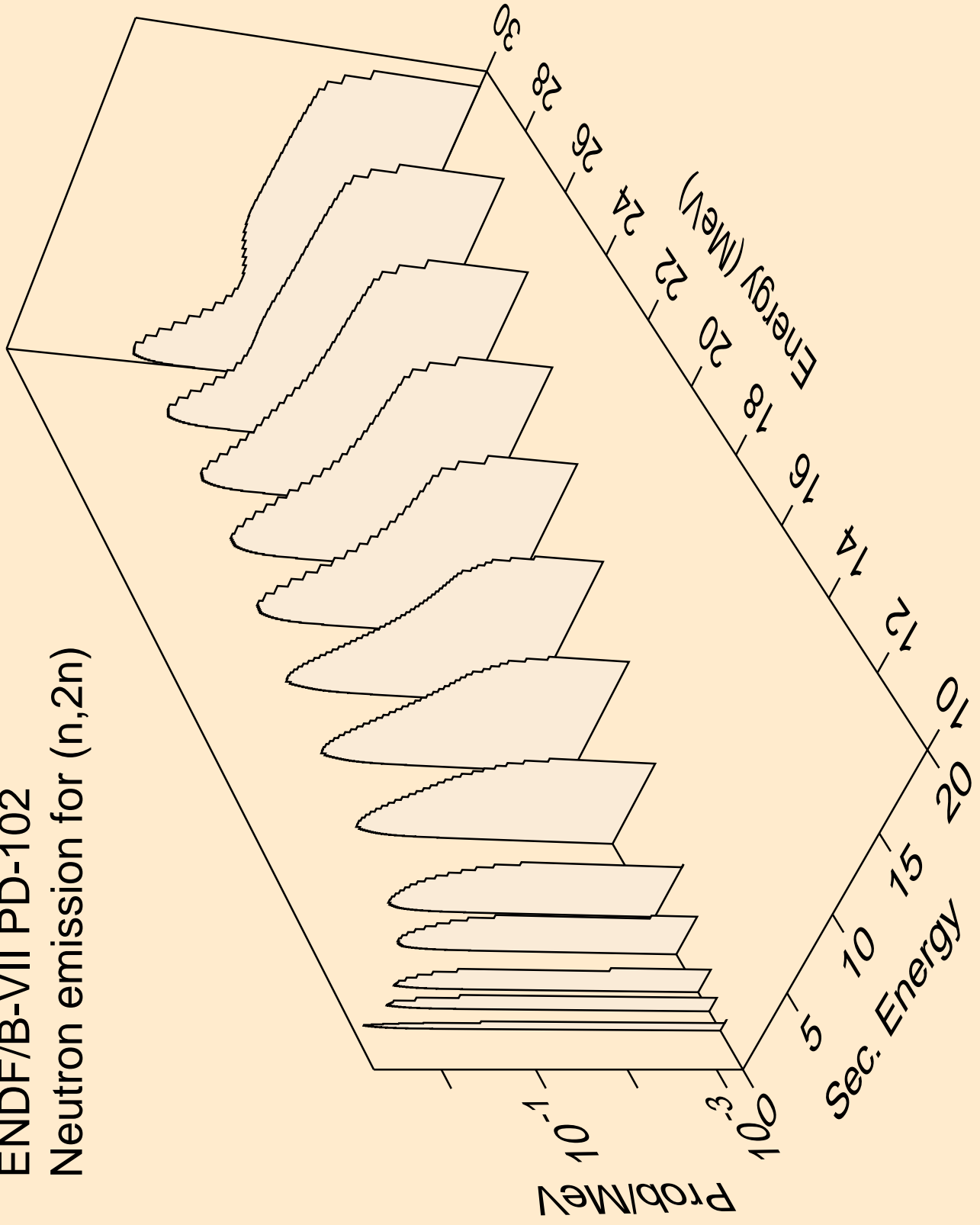

ENDF/B-VII PD-102
Neutron emission for (n,3n)

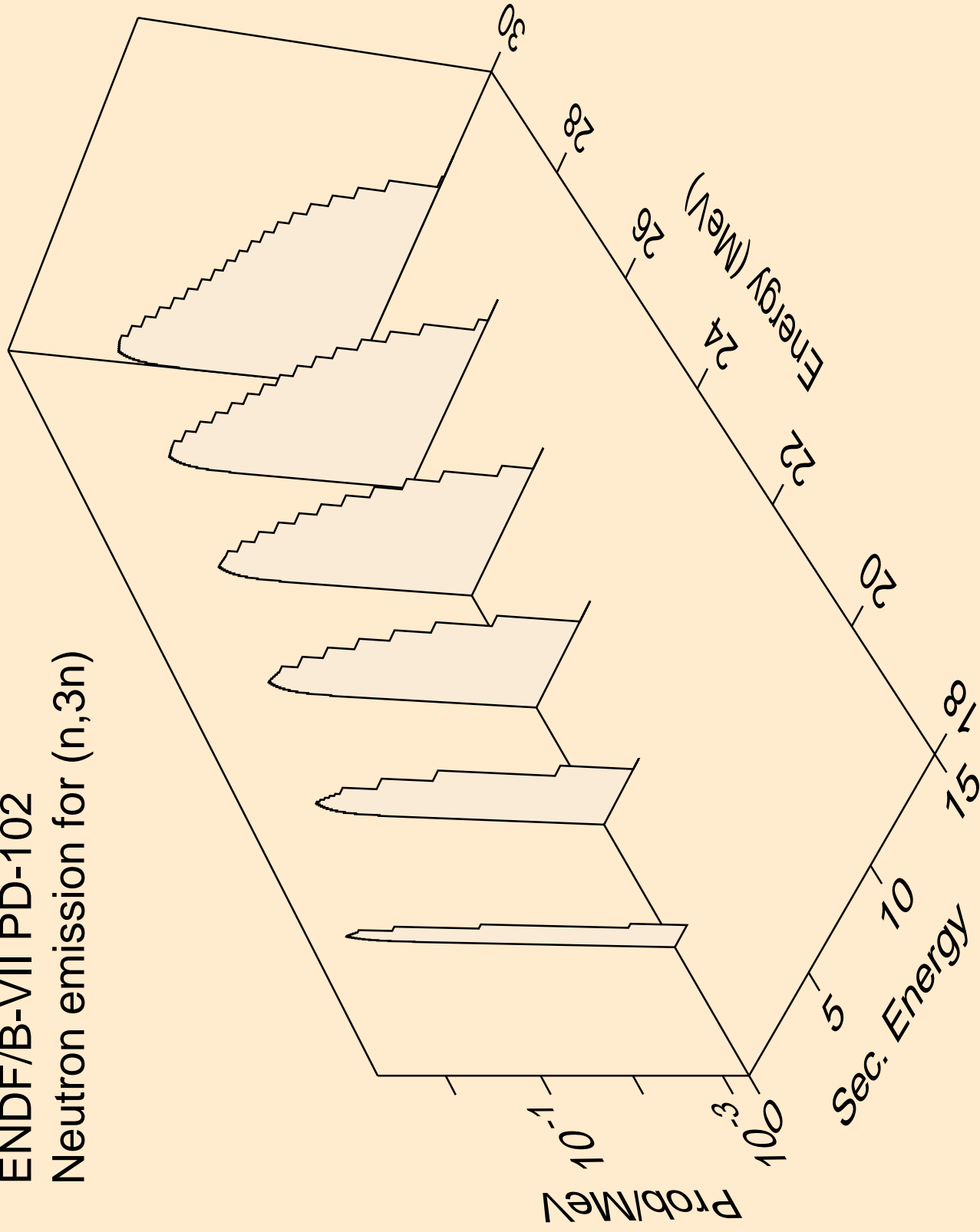

ENDF/B-VII PD-102
Neutron emission for (n,n*)a

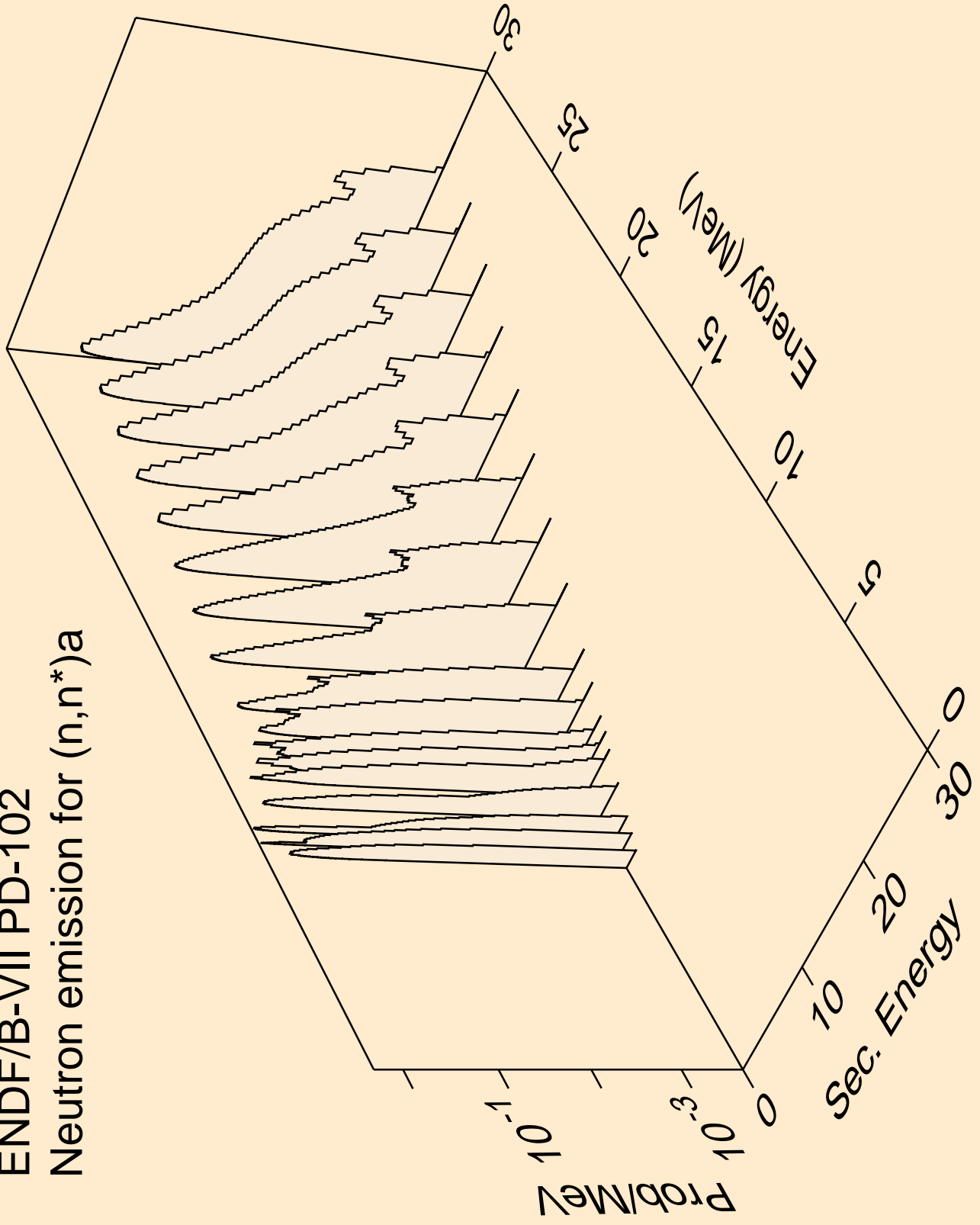

ENDF/B-VII PD-102
Neutron emission for (n,2n)a

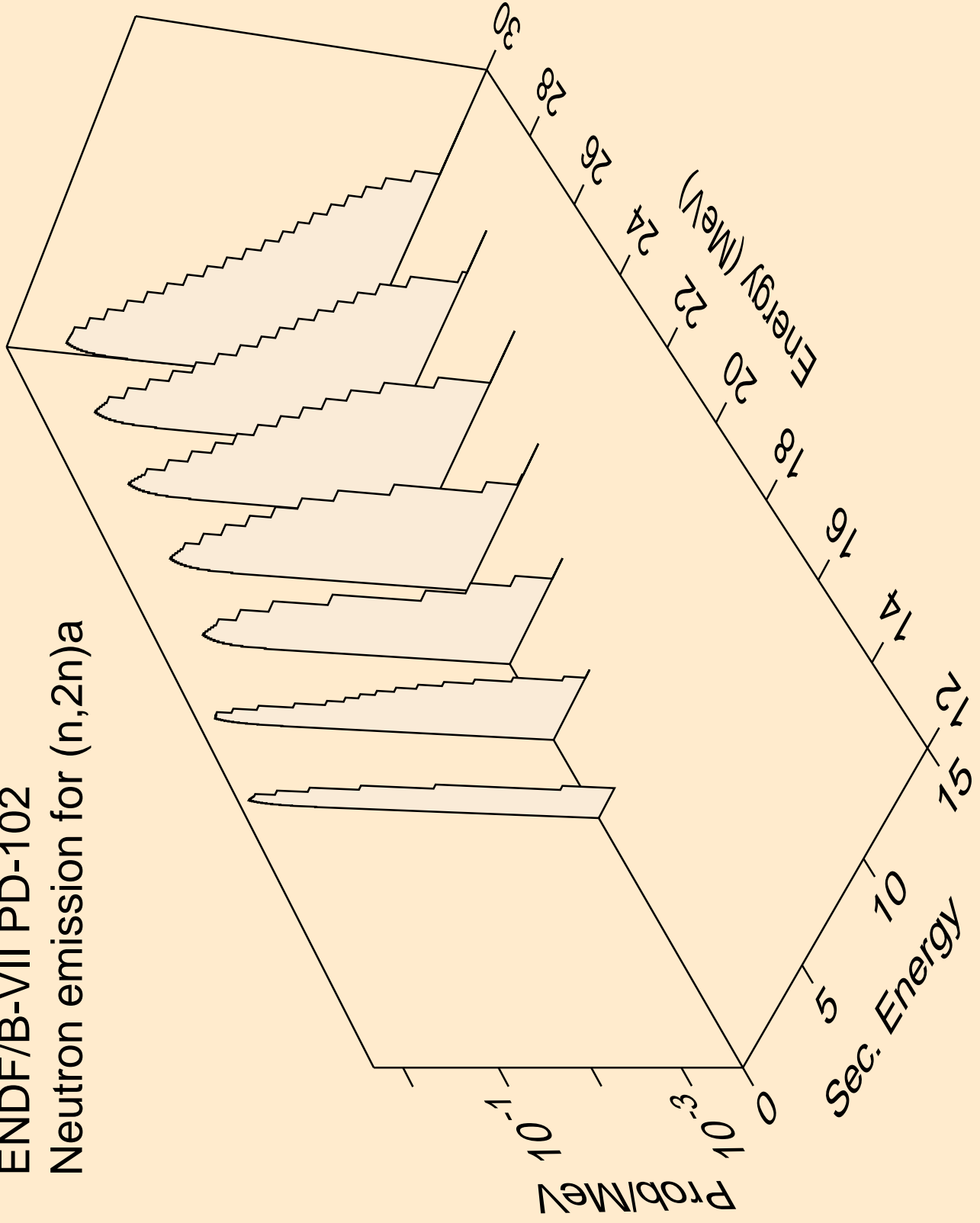

ENDF/B-VII PD-102
Neutron emission for (n,n*)p

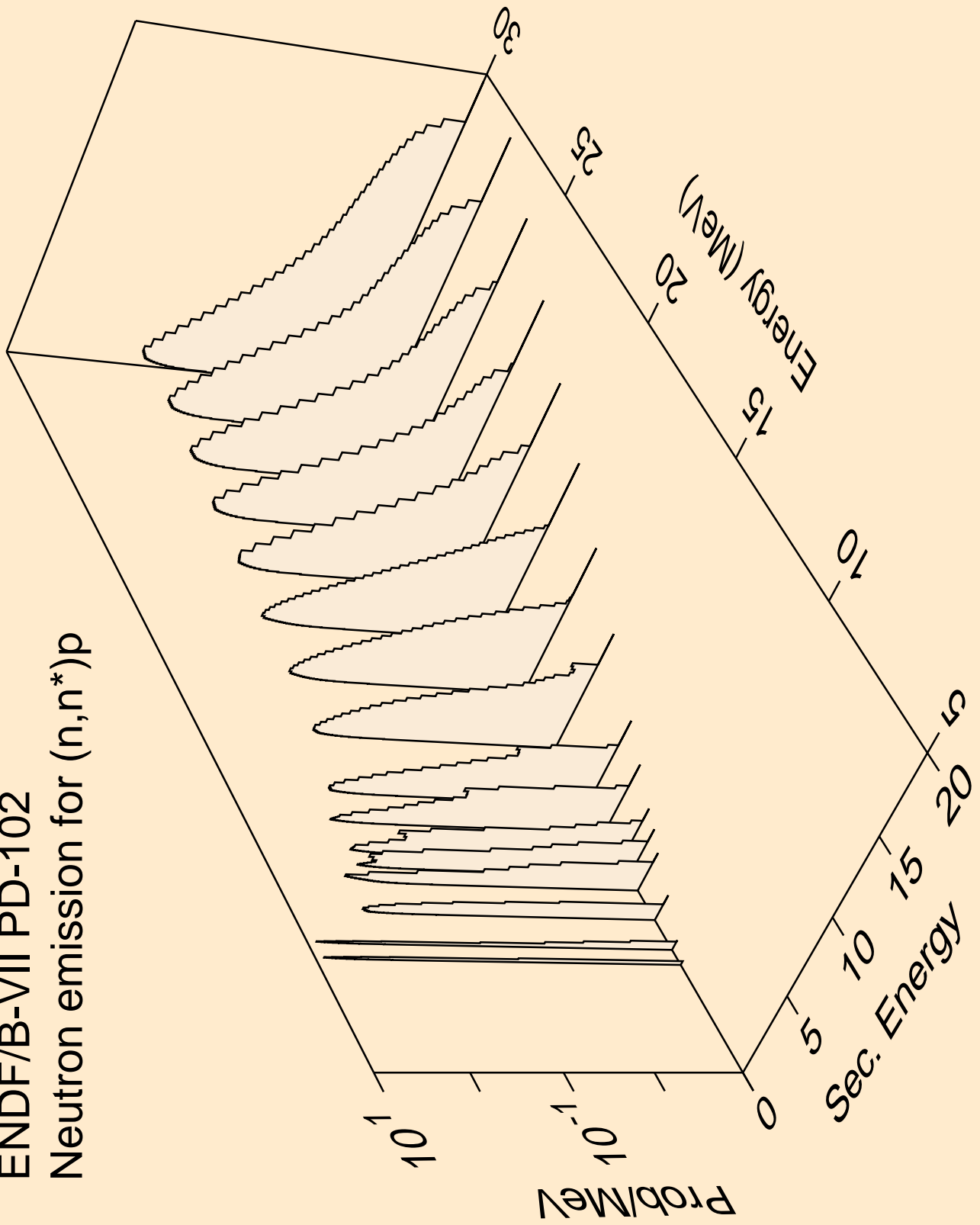

ENDF/B-VII PD-102
Neutron emission for (n,n*)d

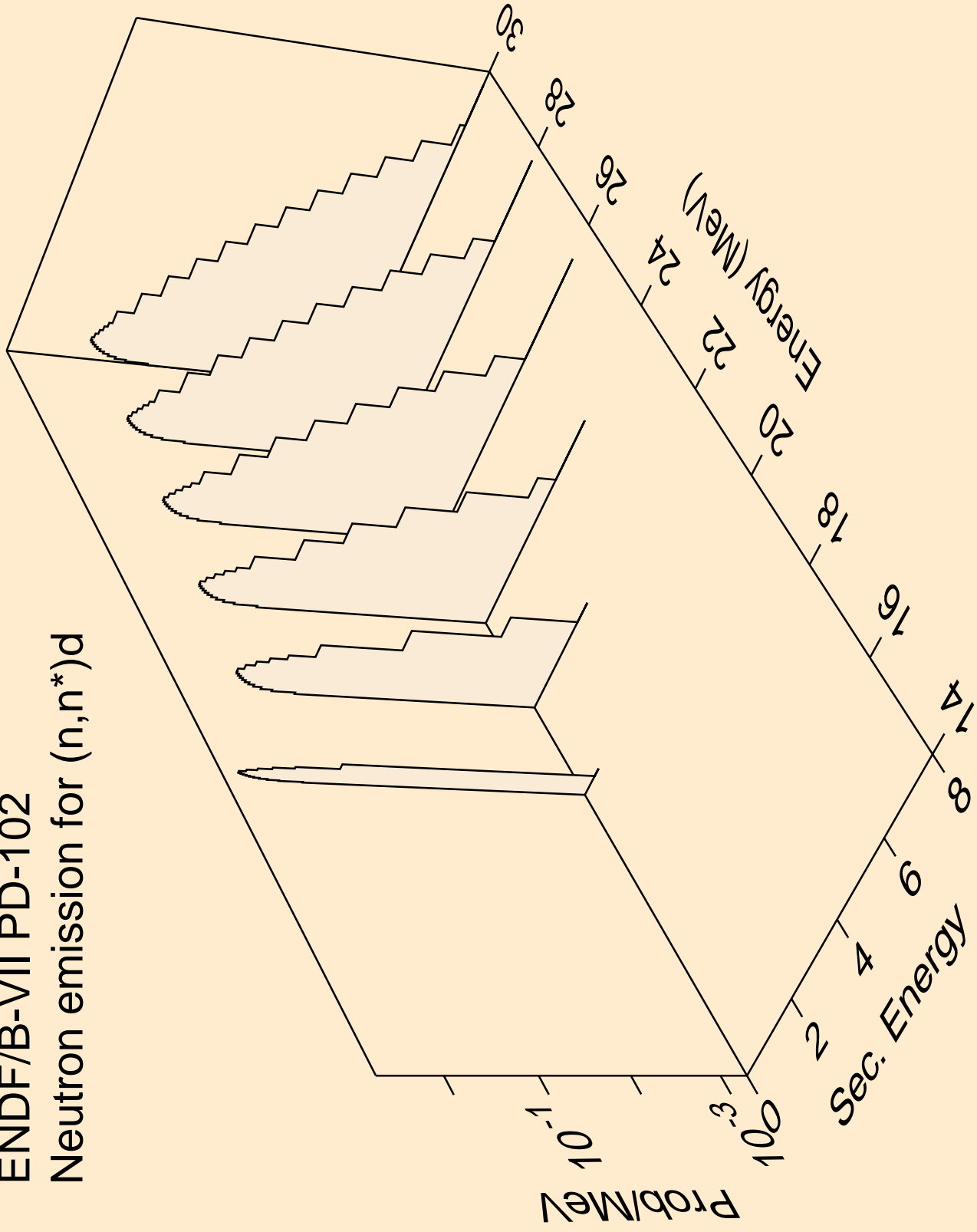

ENDF/B-VII PD-102
Neutron emission for (n,2np)

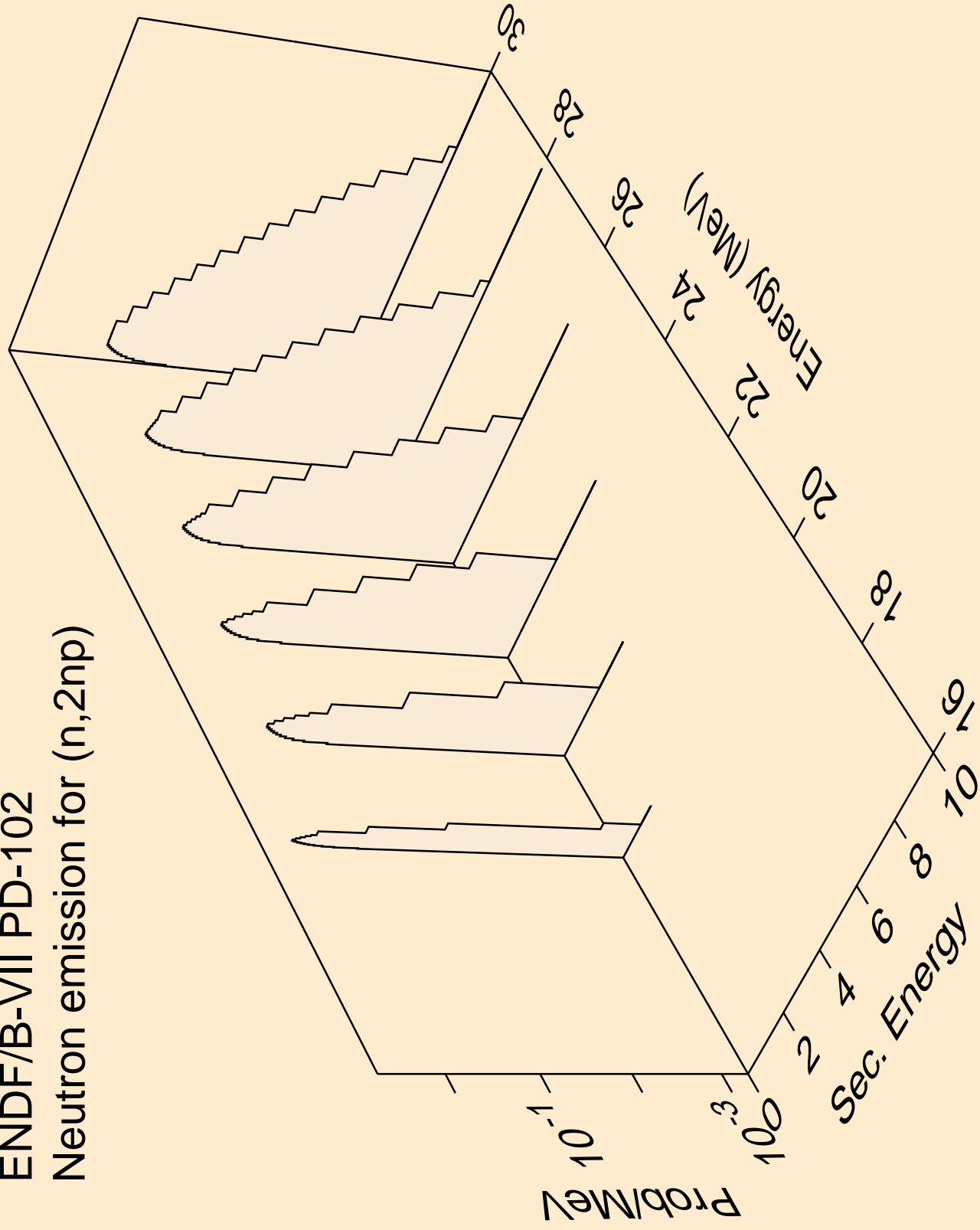

ENDF/B-VII PD-102
Neutron emission for (n,n2p)

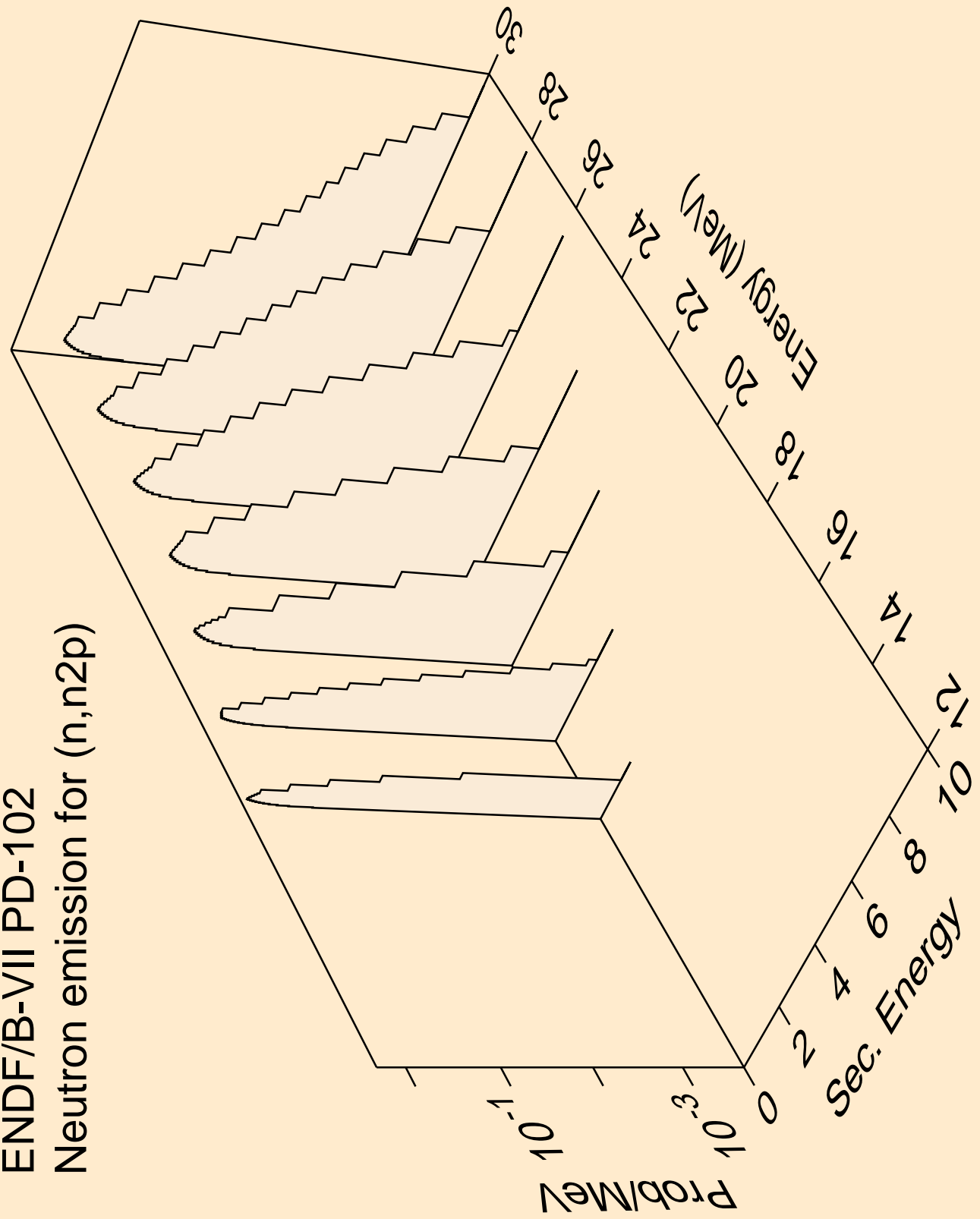

ENDF/B-VII PD-102
Neutron emission for (n,n*c)

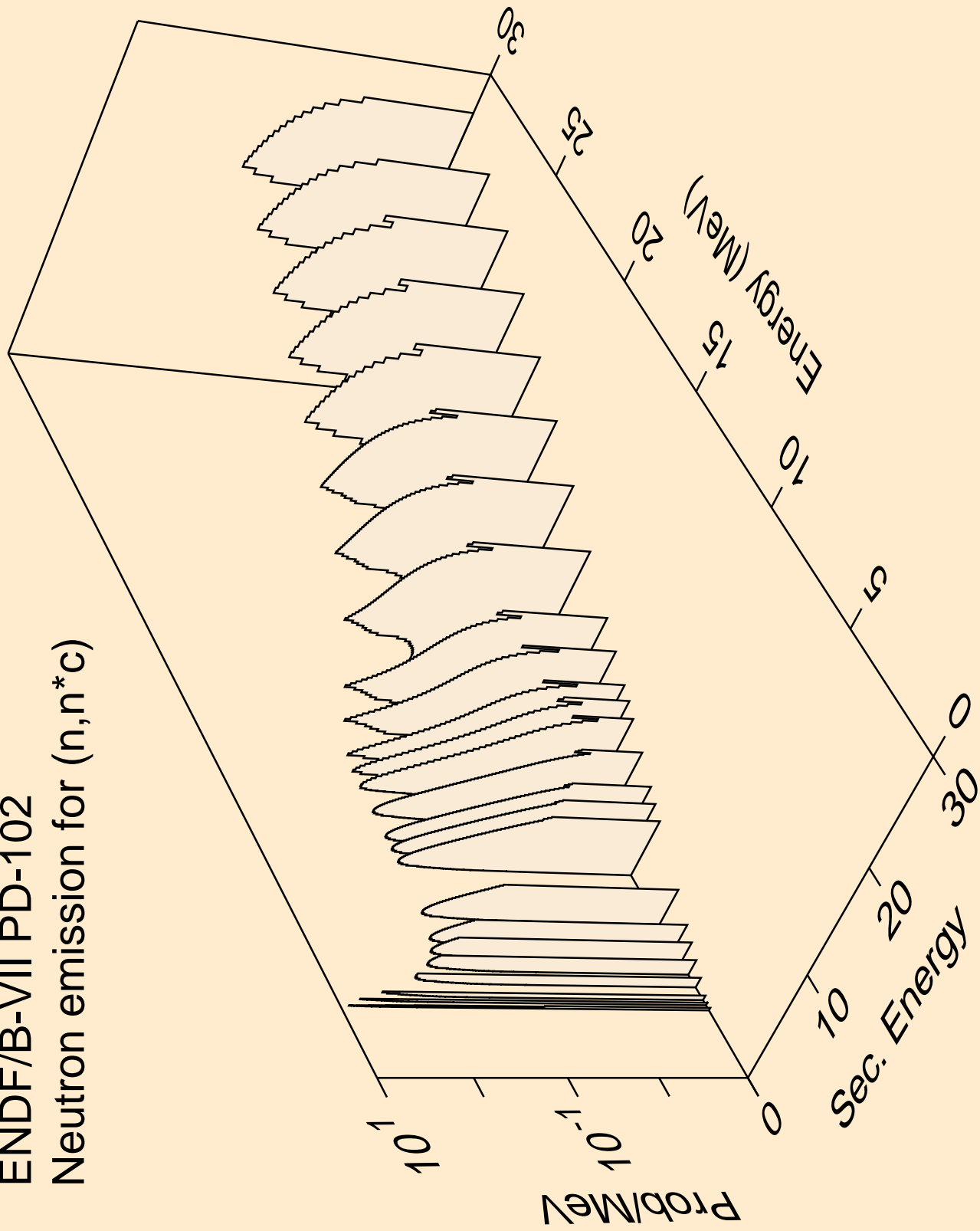

ENDF/B-VII PD-102
Photon emission for (n,gma)

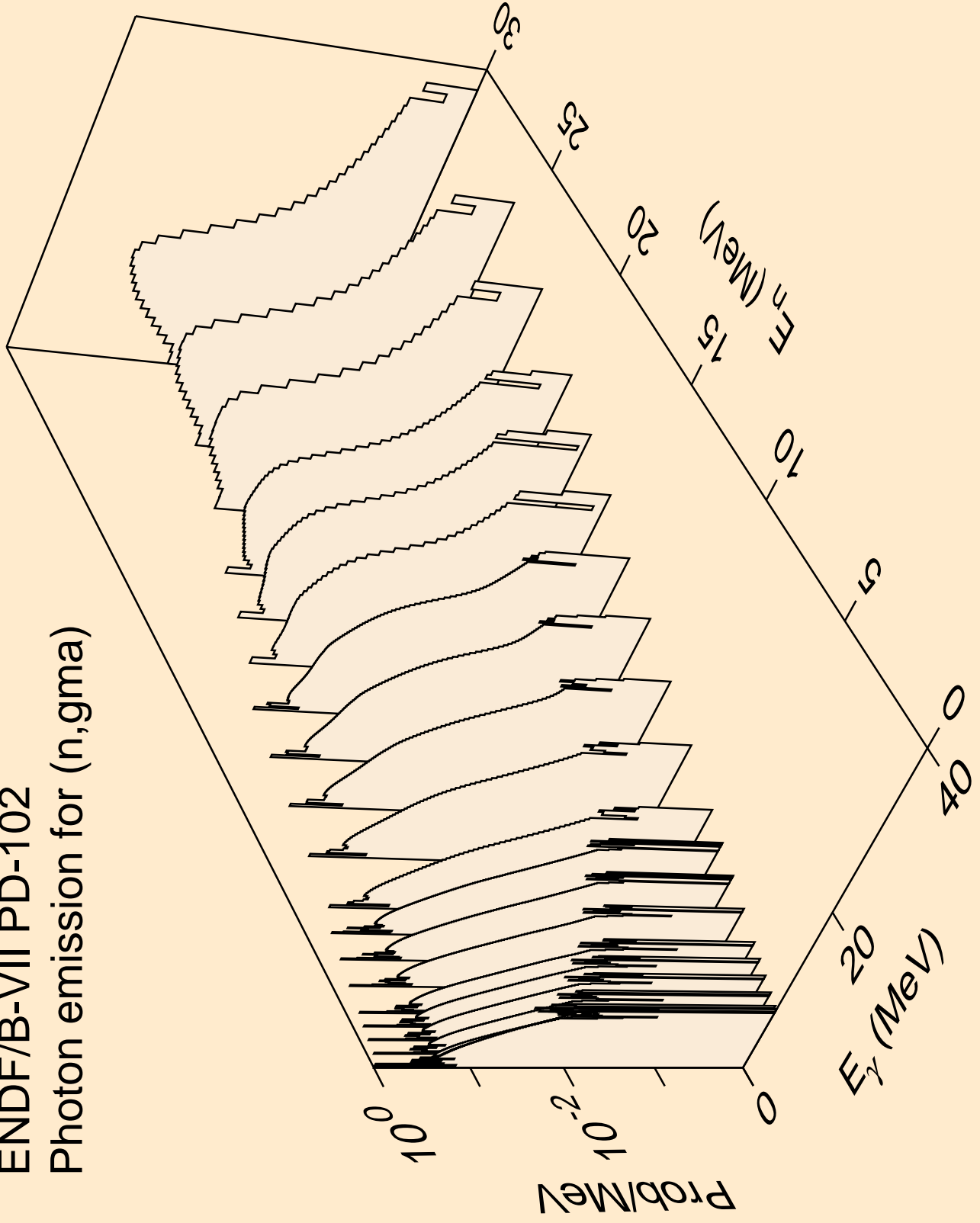

ENDF/B-VII PD-102
Photon emission for (n,2n)

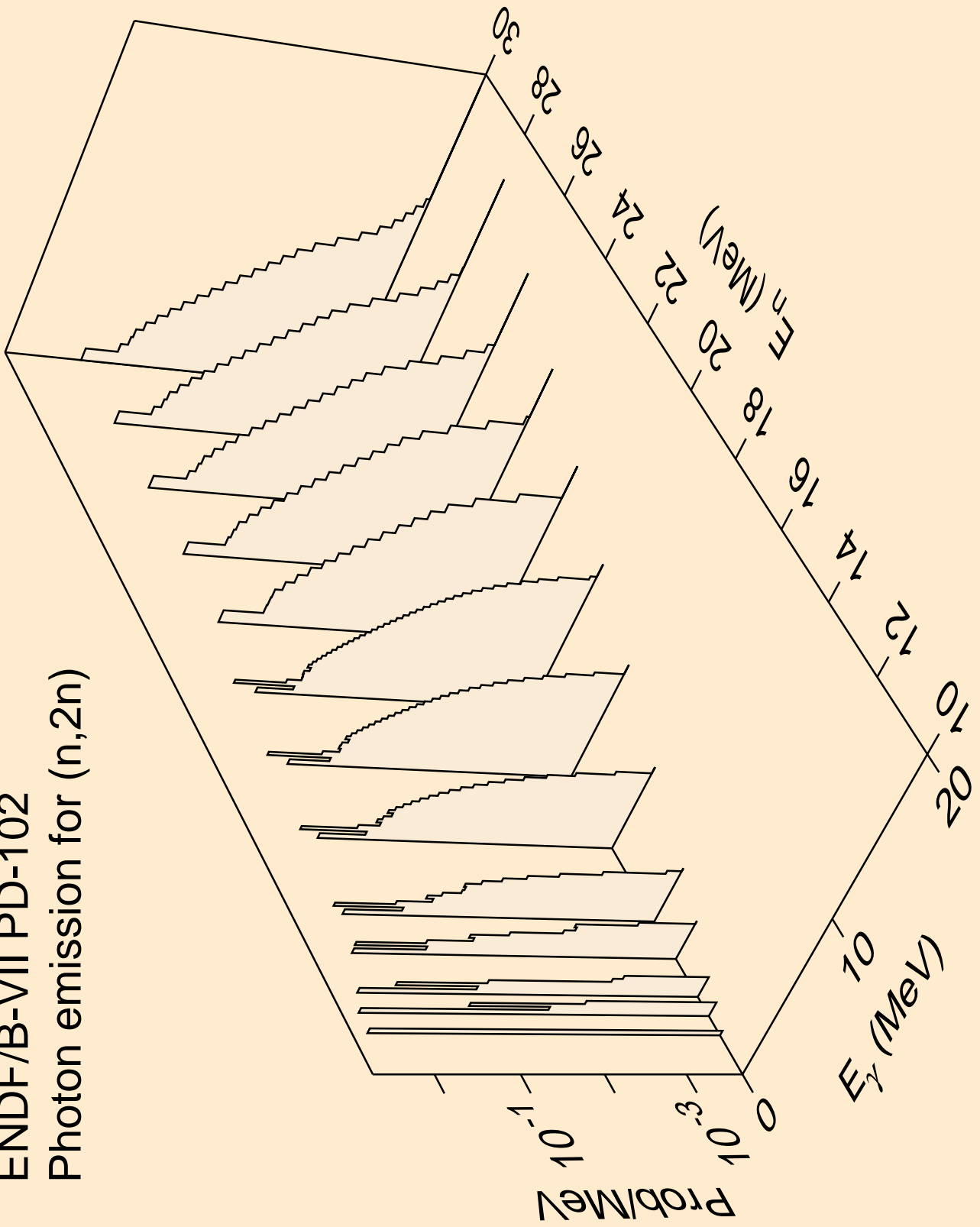

ENDF/B-VII PD-102
Photon emission for (n,3n)

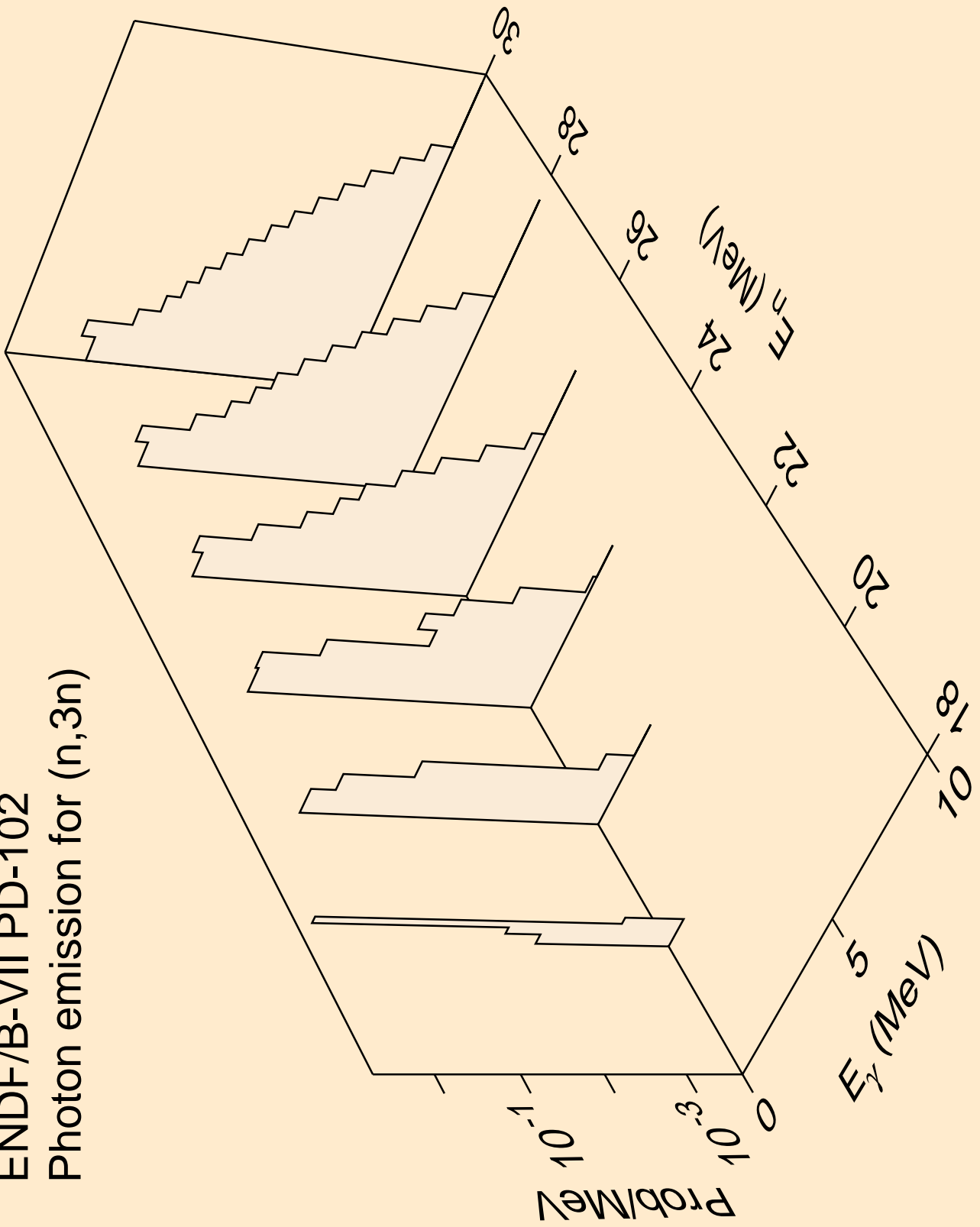

ENDF/B-VII PD-102
Photon emission for (n,n*)a

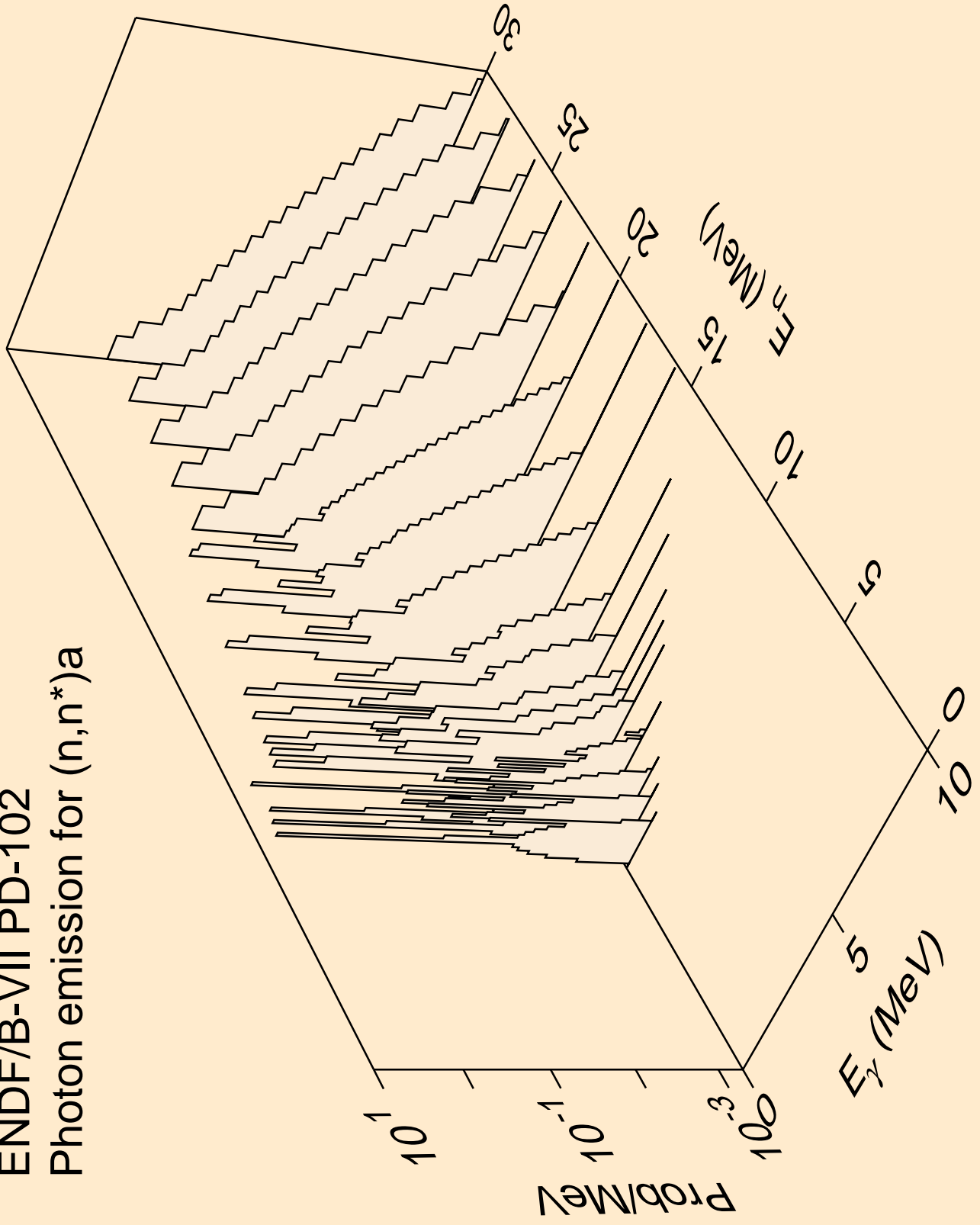

ENDF/B-VII PD-102
Photon emission for (n,2n)a

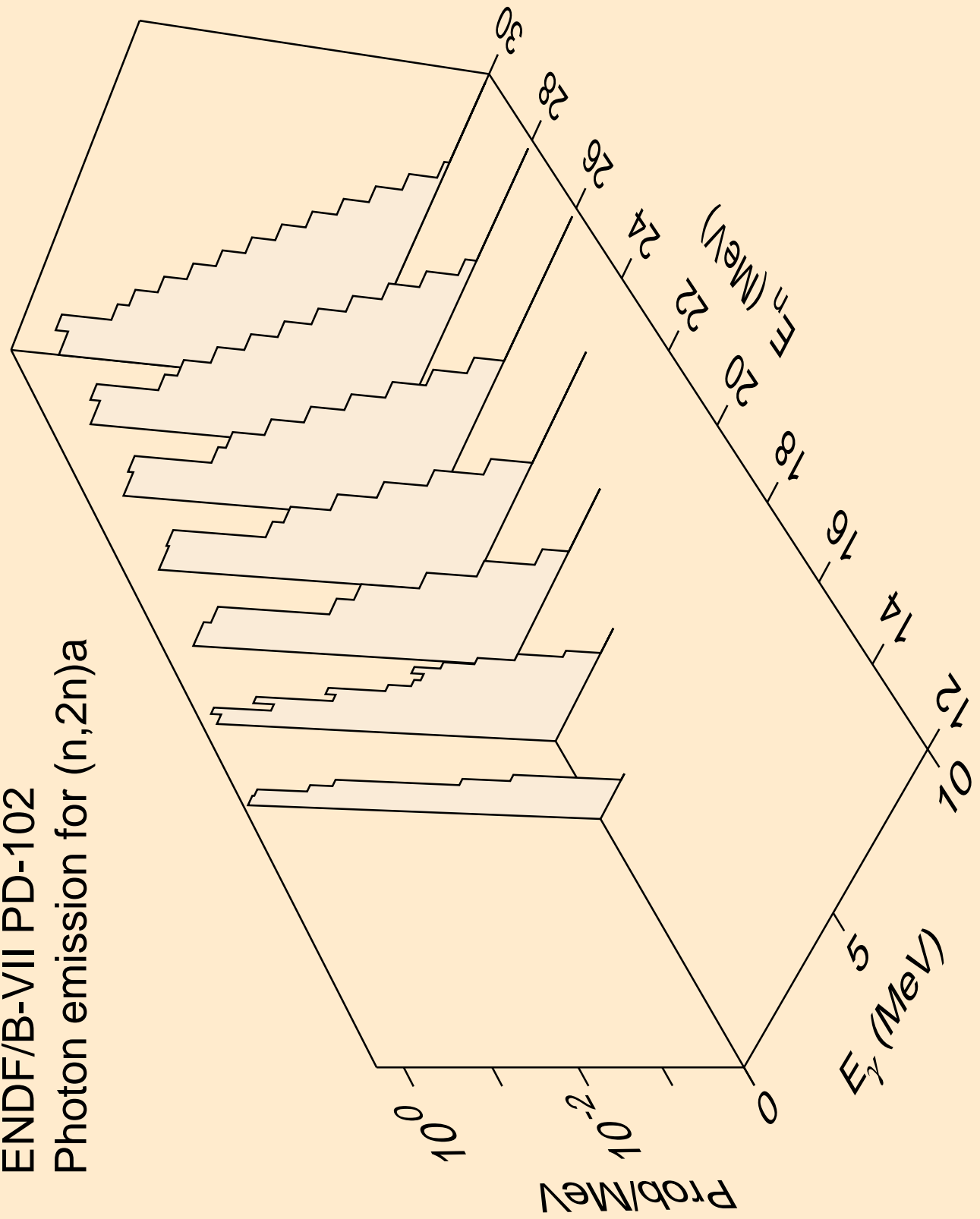

ENDF/B-VII PD-102
Photon emission for (n,n*)p

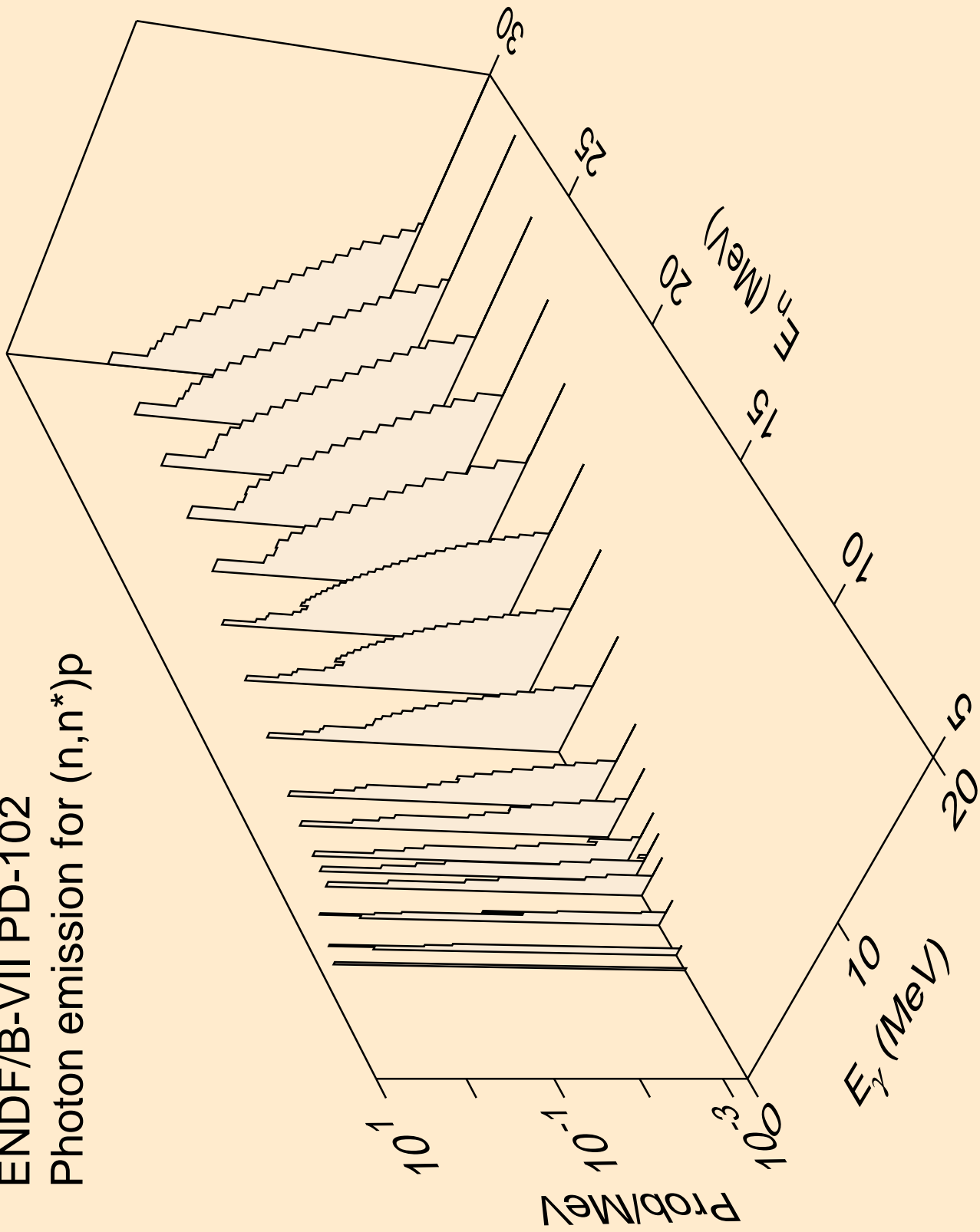

ENDF/B-VII PD-102
Photon emission for (n,n*)d

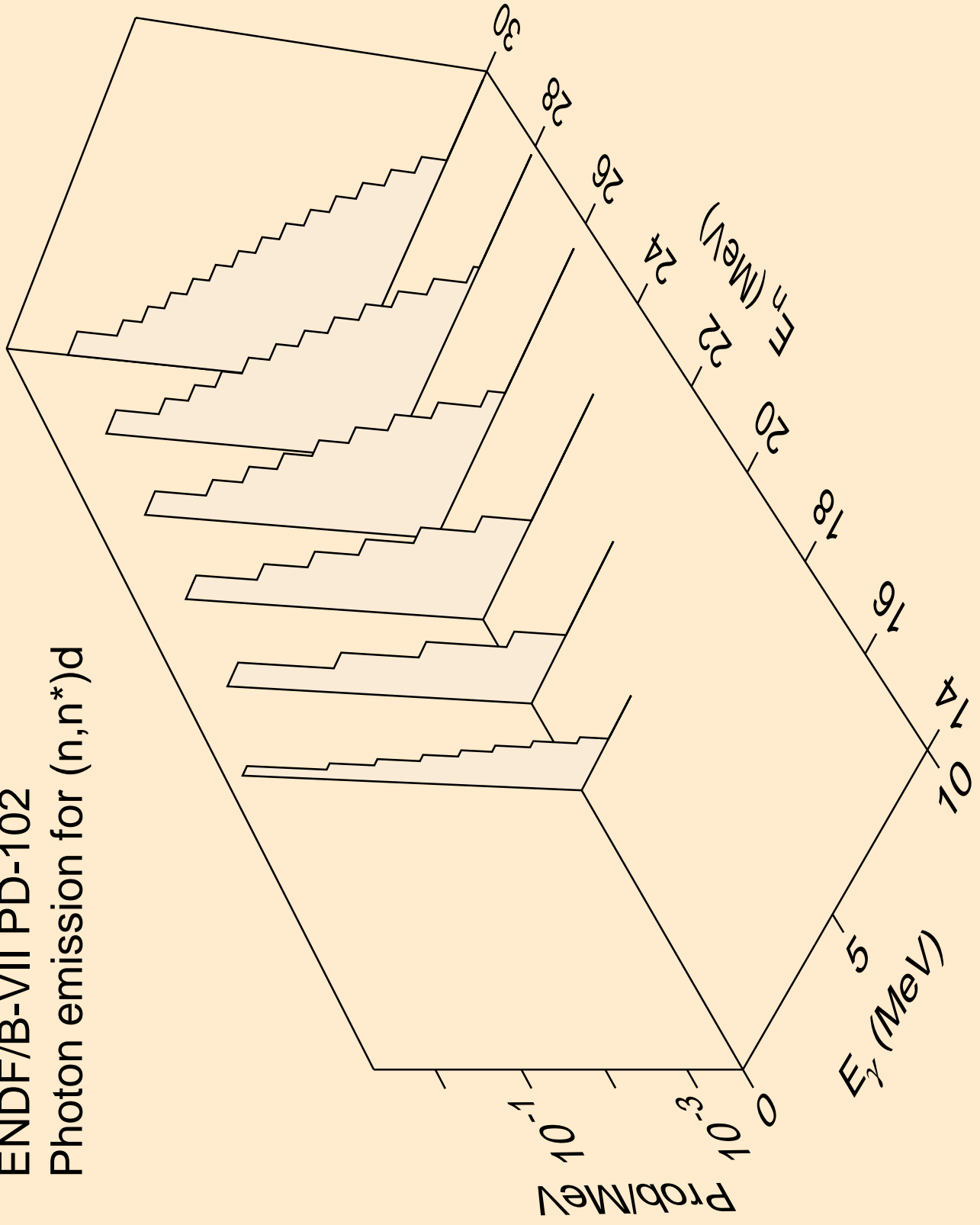

ENDF/B-VII PD-102
Photon emission for (n,2np)

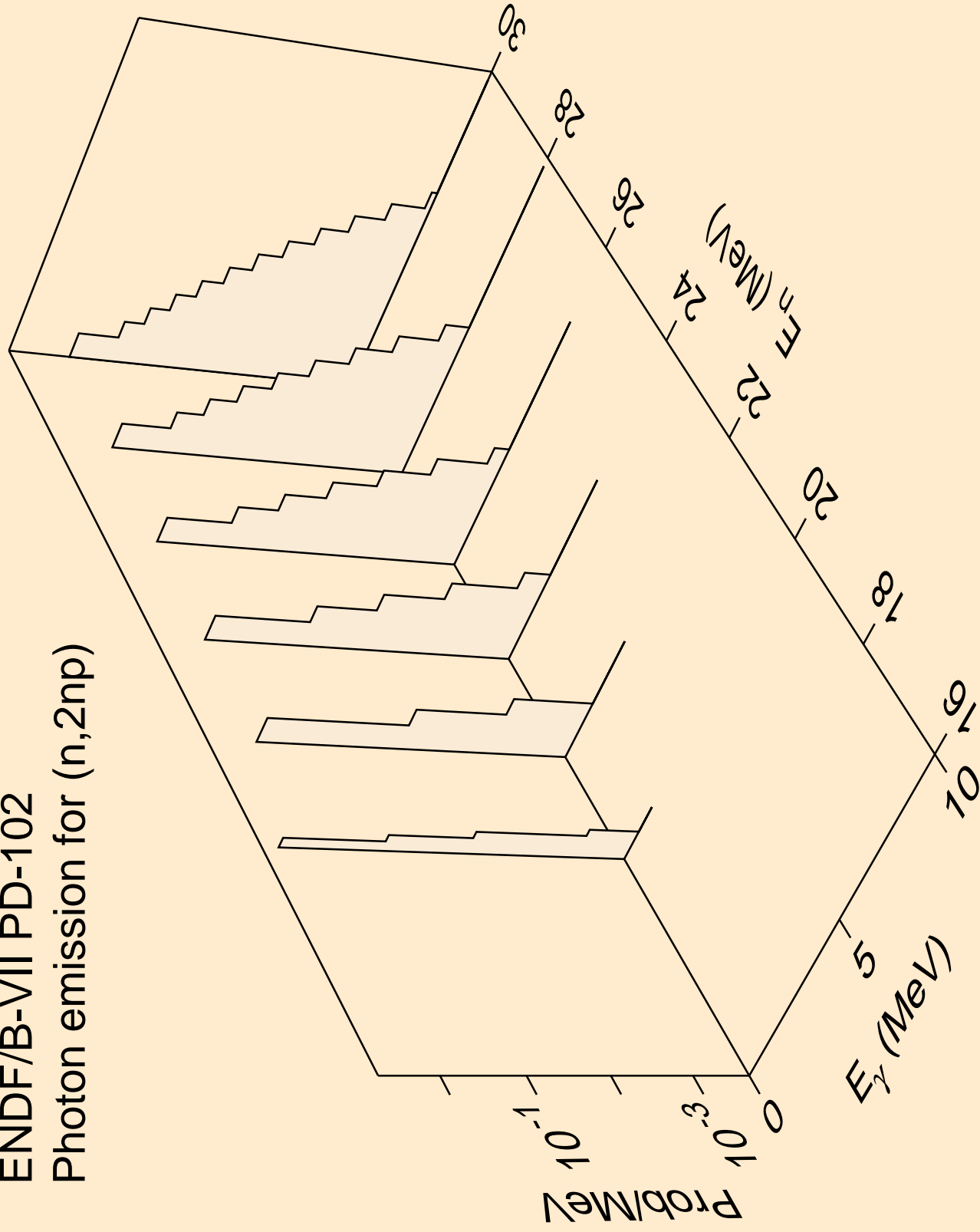

ENDF/B-VII PD-102
Photon emission for (n,n2p)

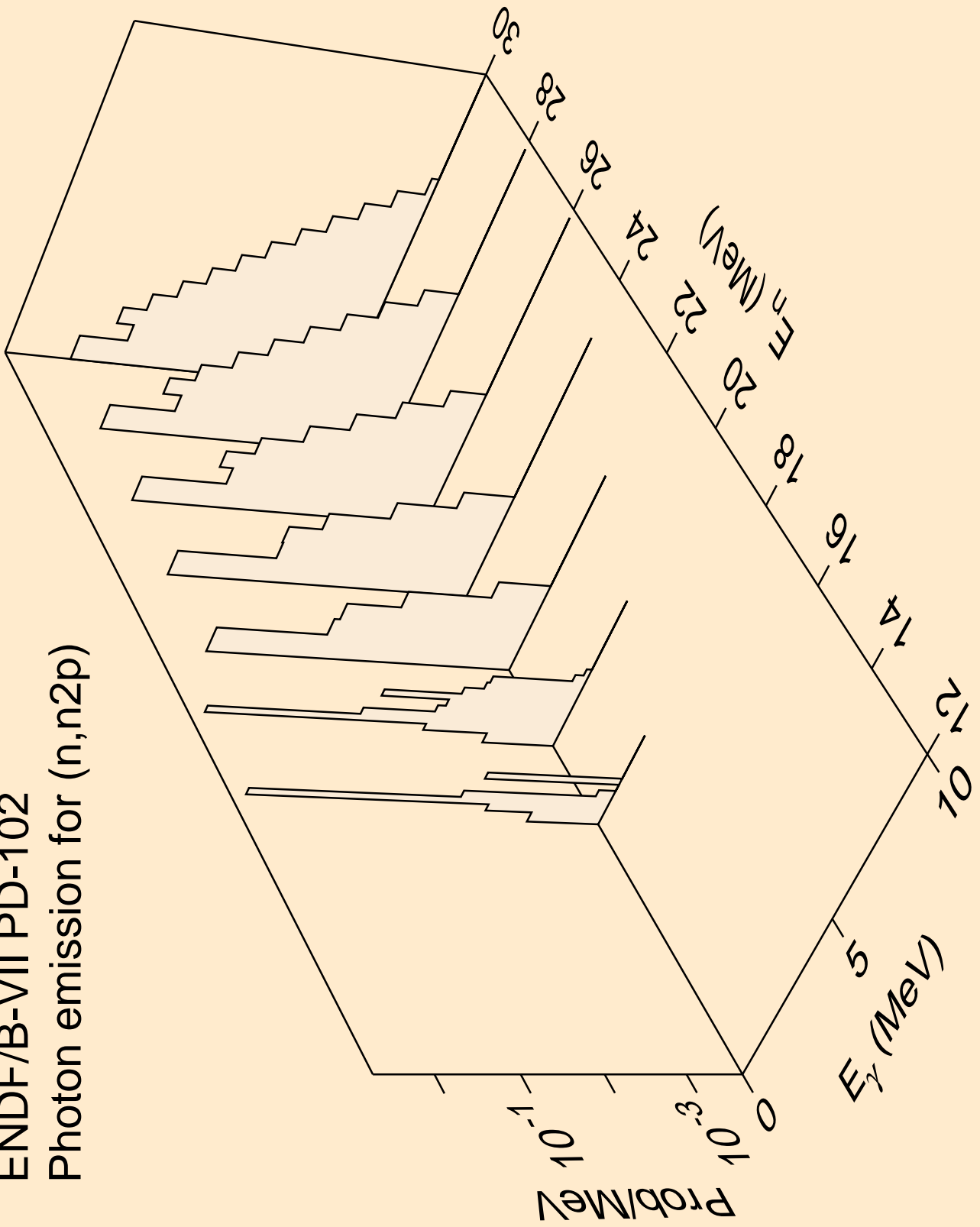

ENDF/B-VII PD-102
Photon emission for (n,n*1)

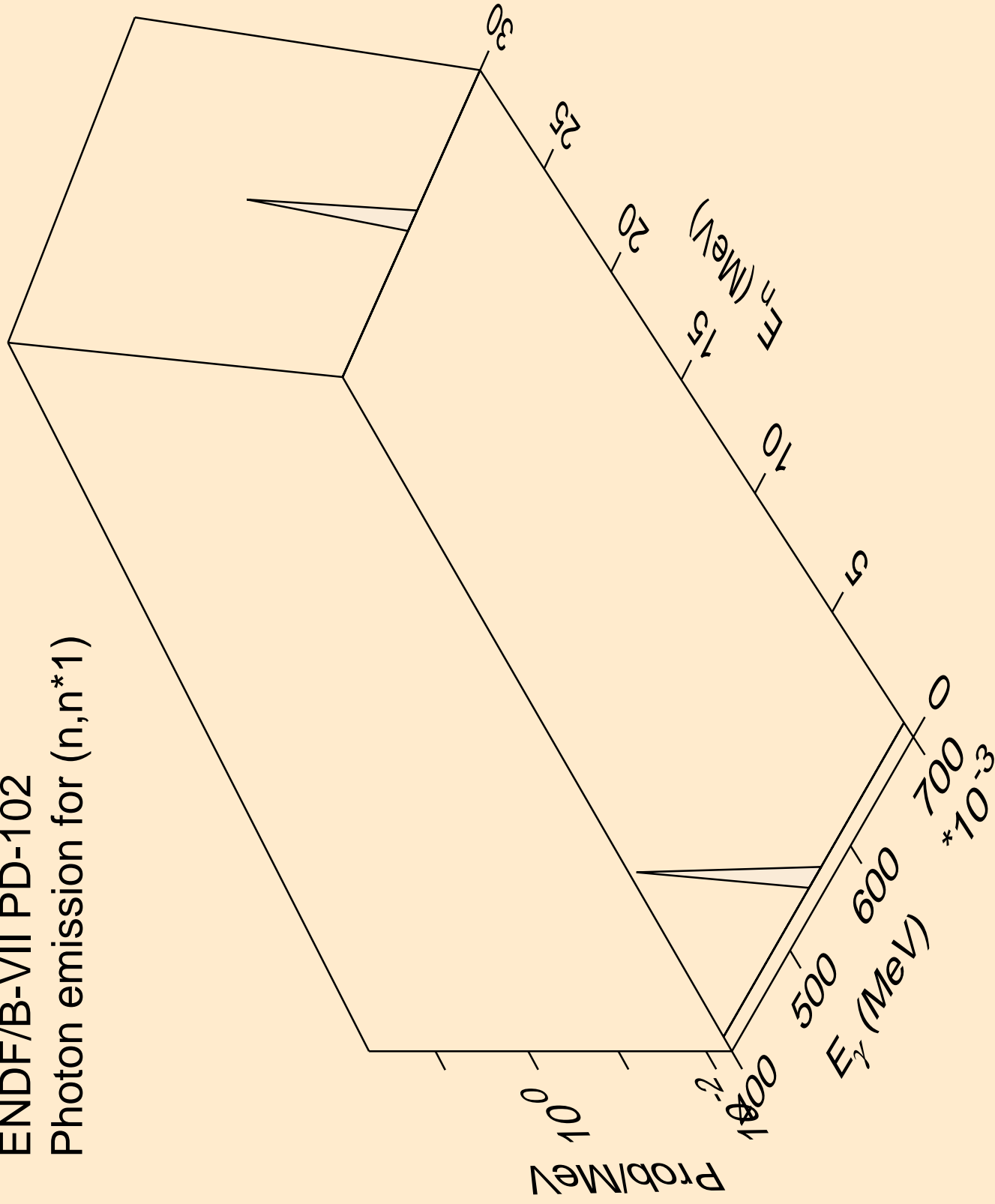

ENDF/B-VII PD-102
Photon emission for (n,n*2)

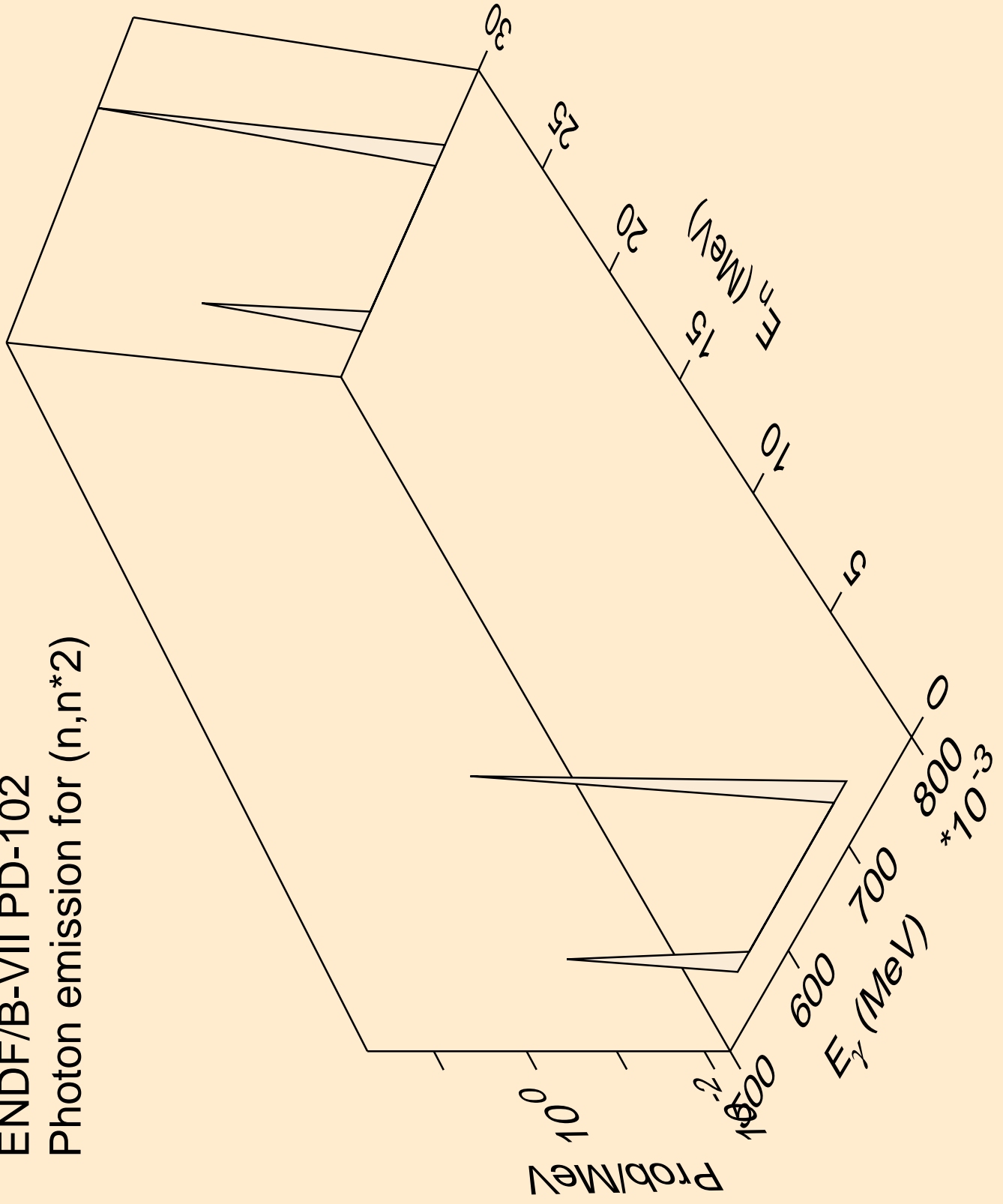

ENDF/B-VII PD-102
Photon emission for (n,n*3)

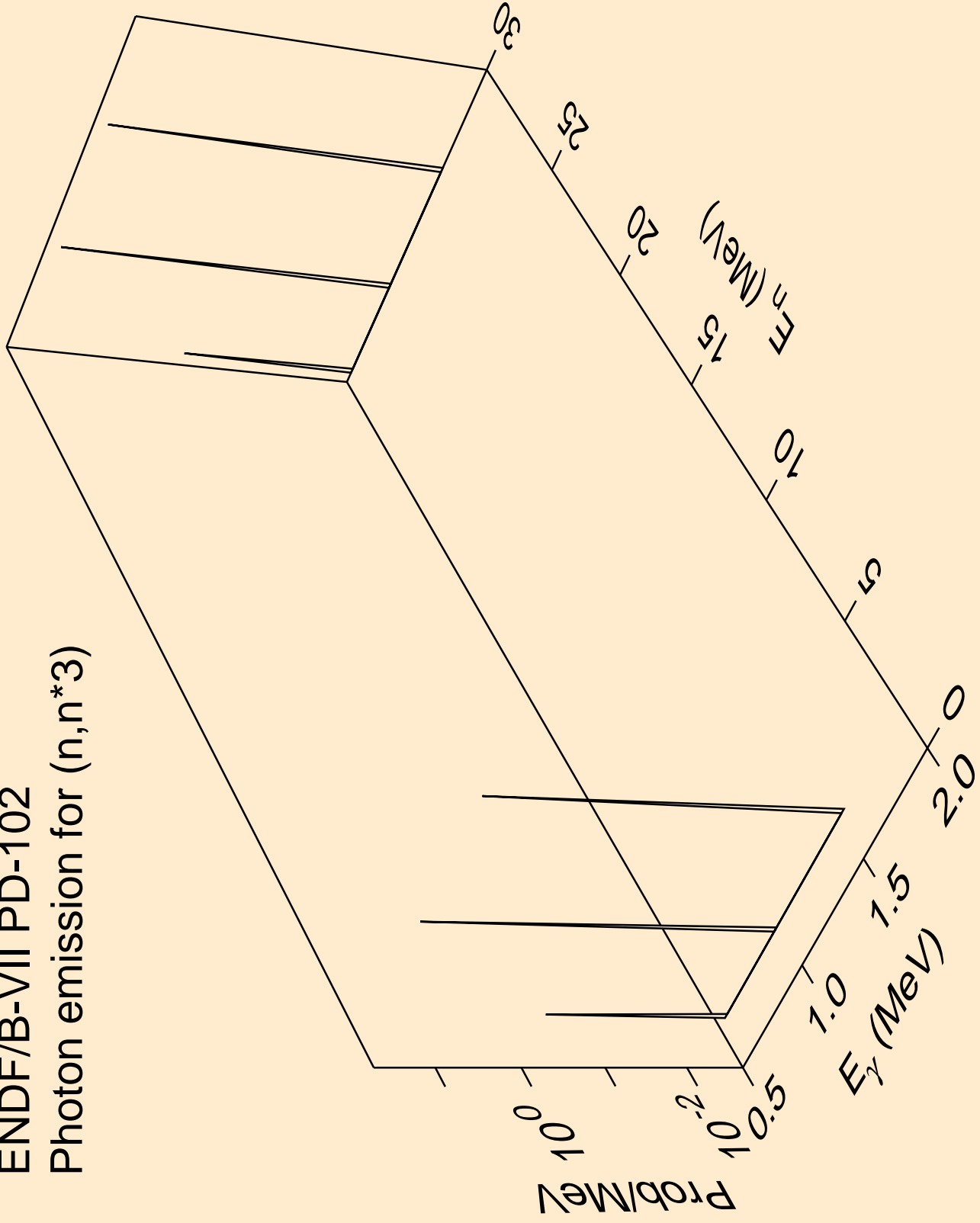

ENDF/B-VII PD-102
Photon emission for (n,n*4)

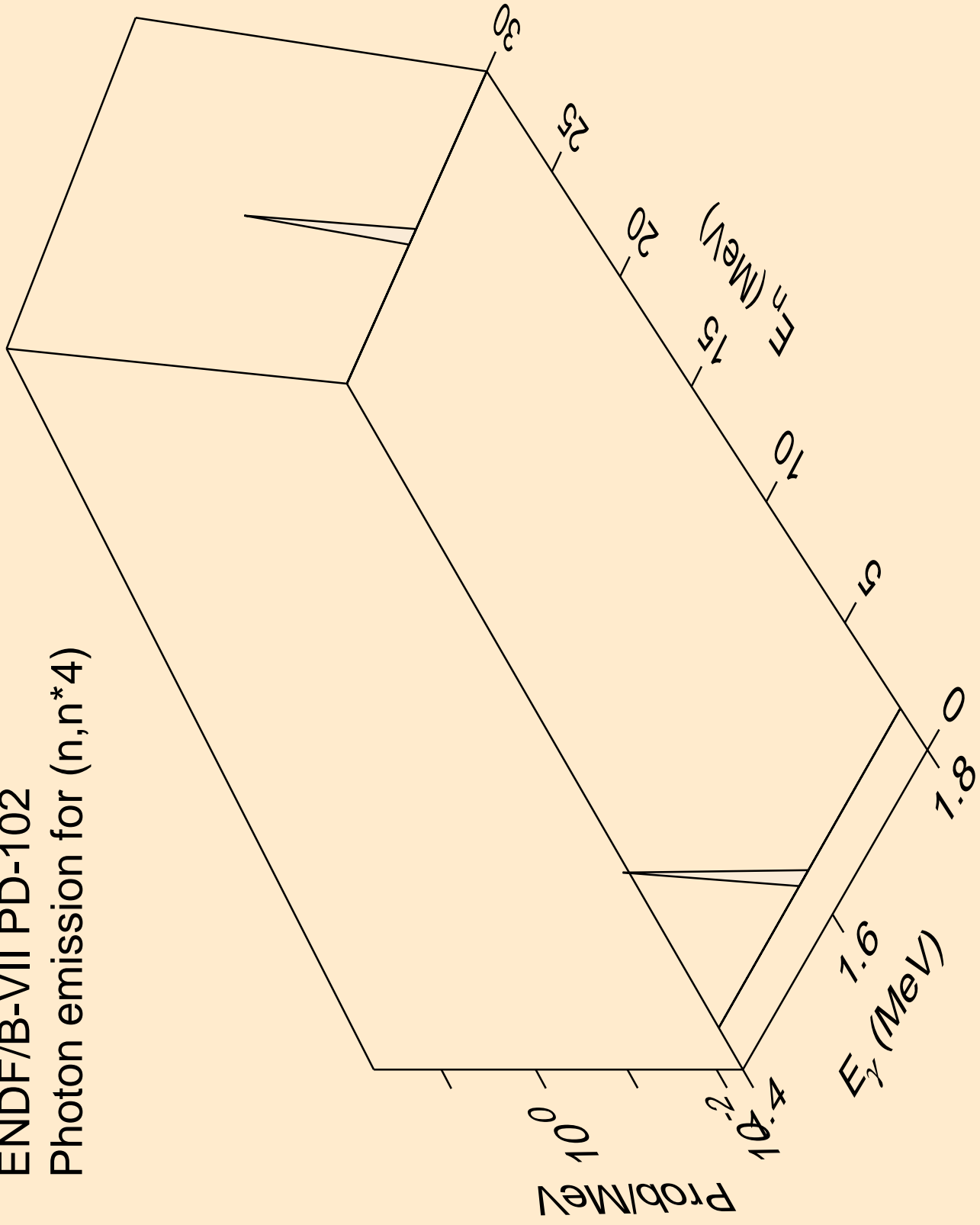

ENDF/B-VII PD-102
Photon emission for (n,n*5)

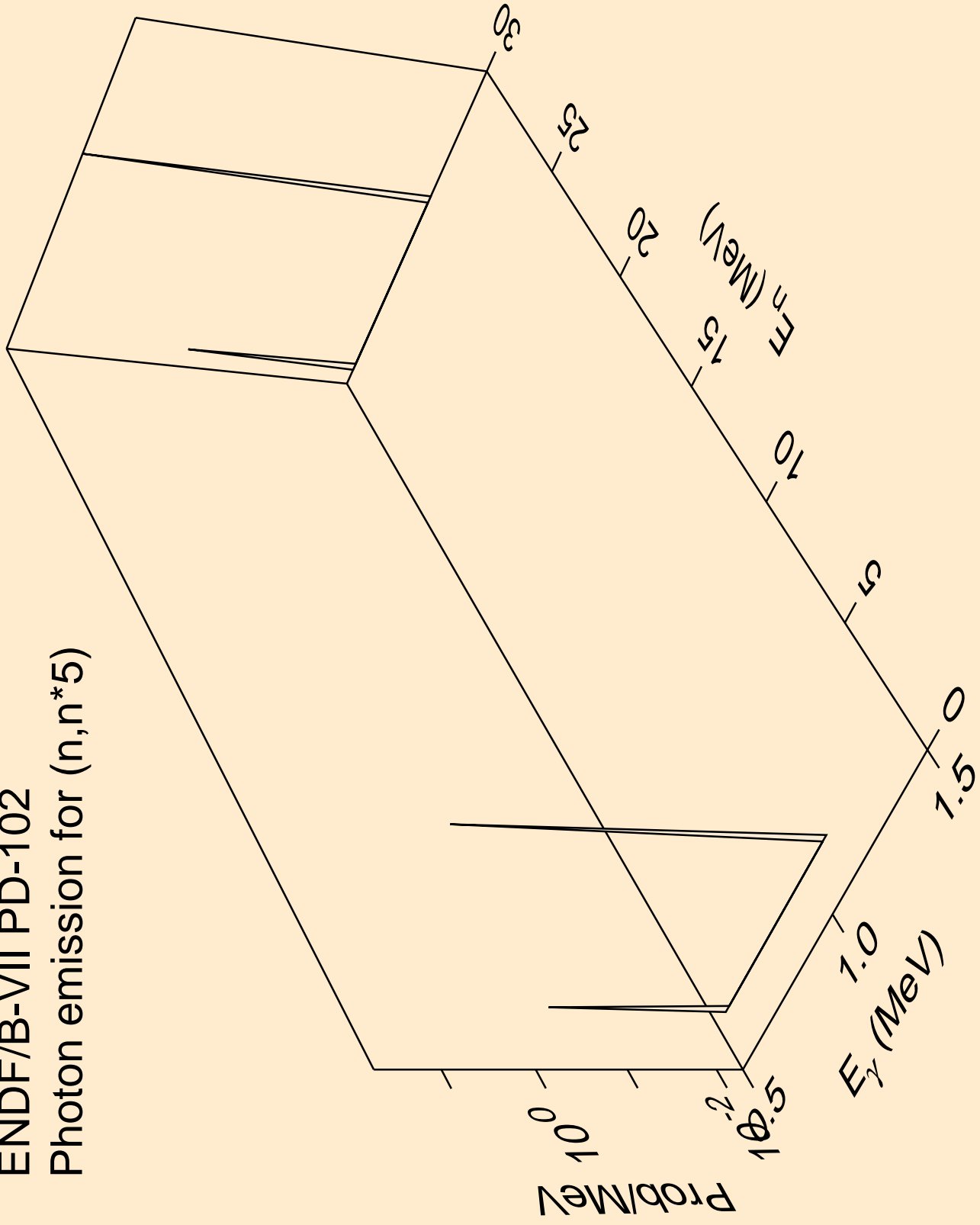

ENDF/B-VII PD-102
Photon emission for (n,n*6)

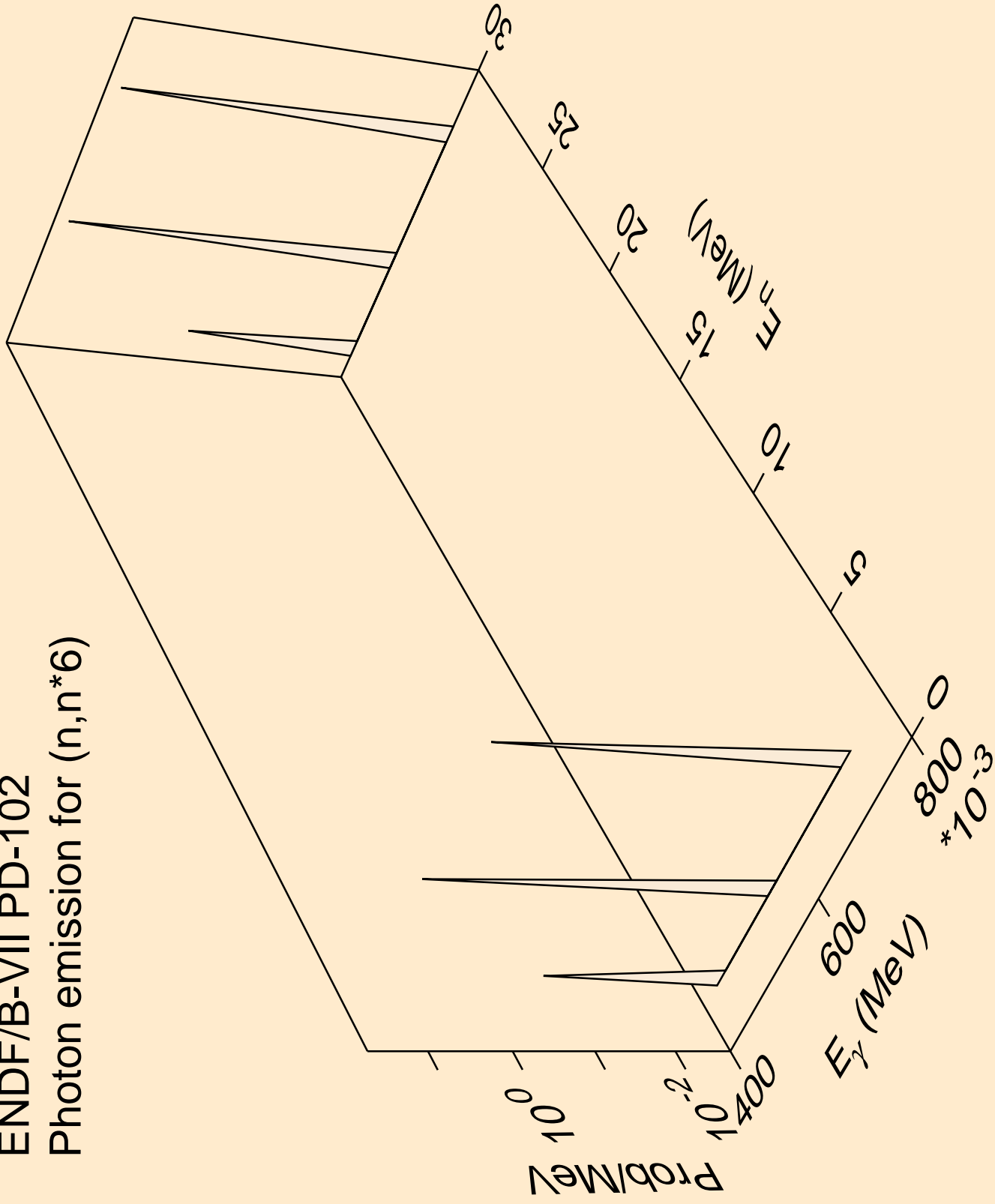

ENDF/B-VII PD-102
Photon emission for (n,n*7)

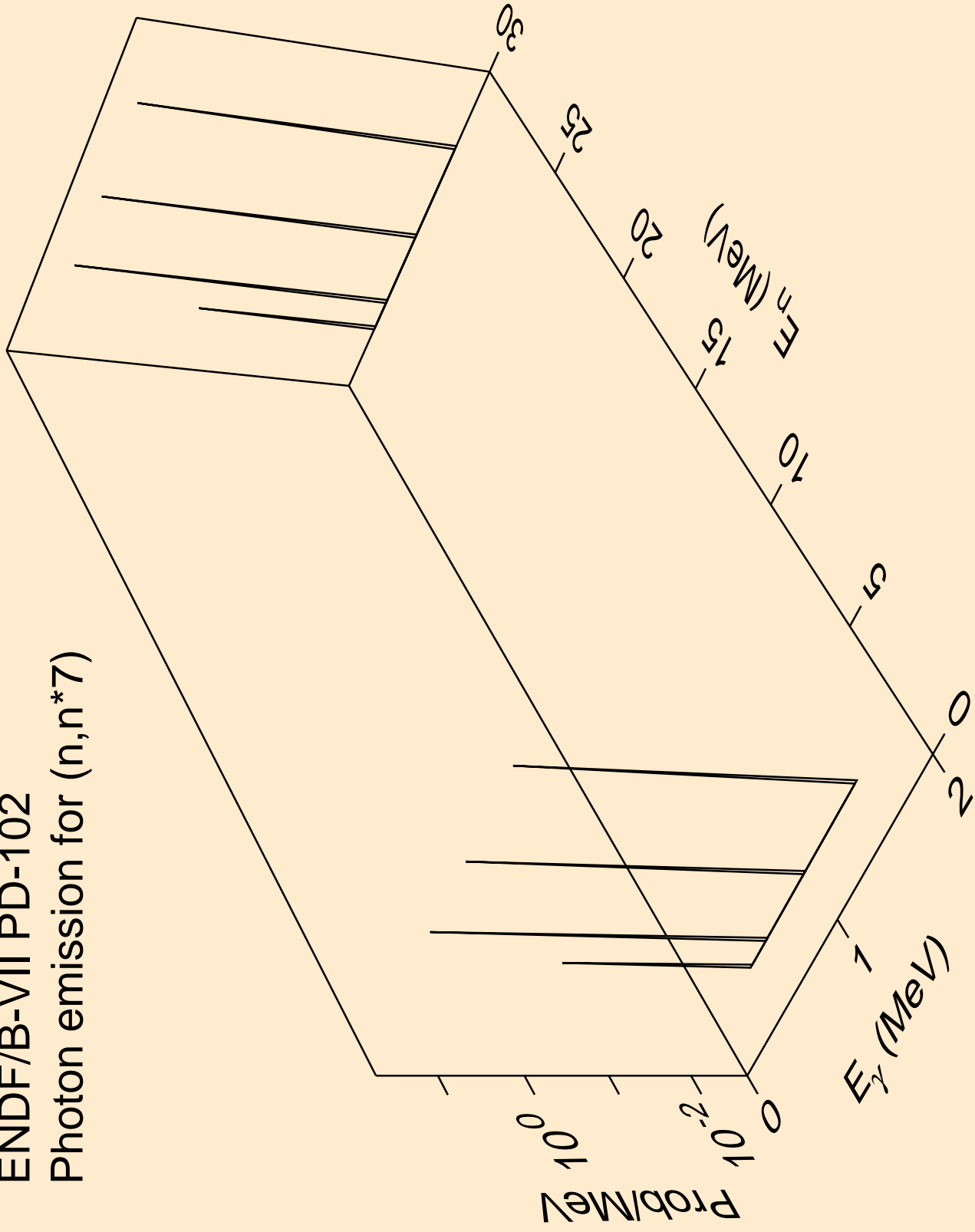

ENDF/B-VII PD-102
Photon emission for (n,n*8)

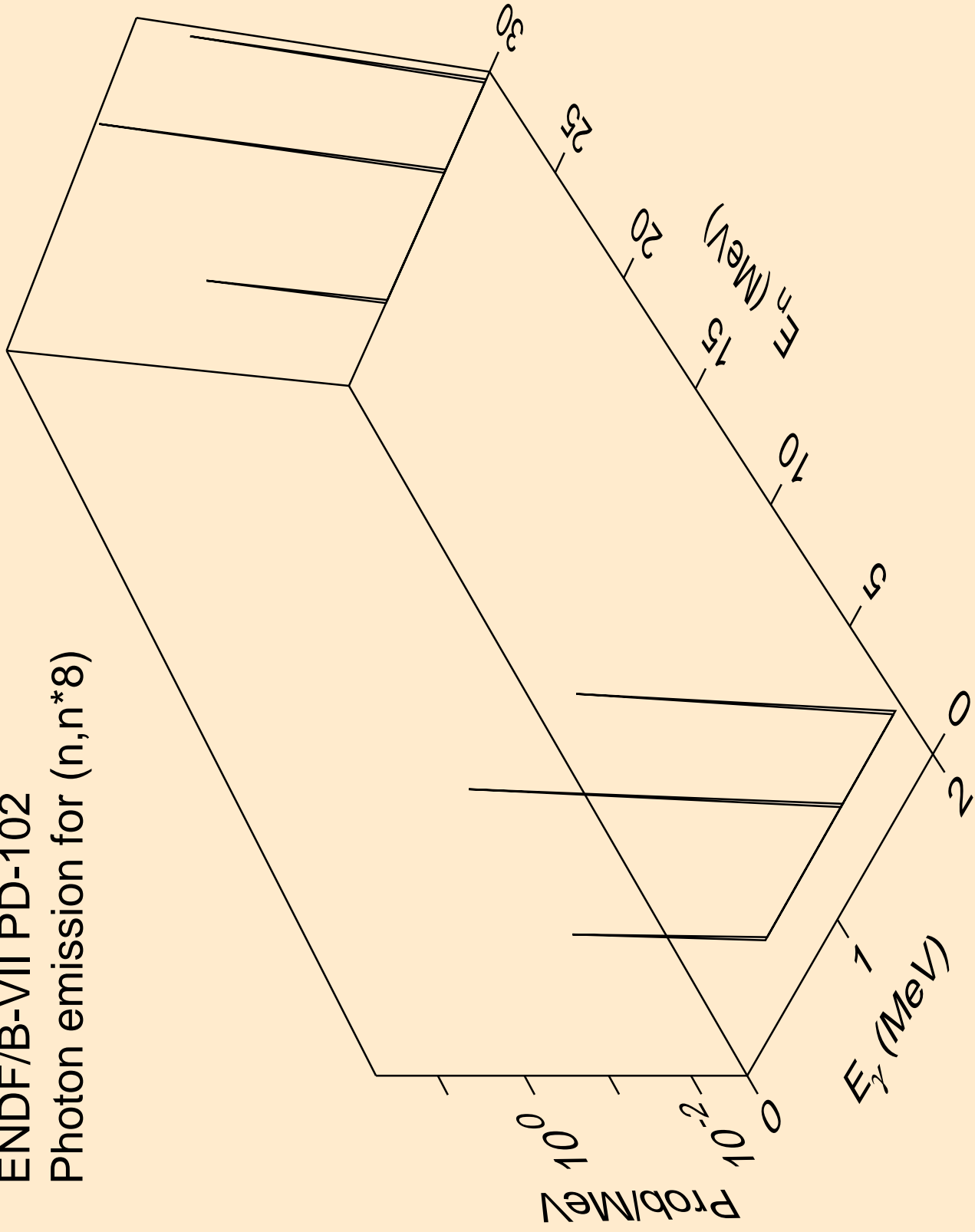

ENDF/B-VII PD-102
Photon emission for (n,n*9)

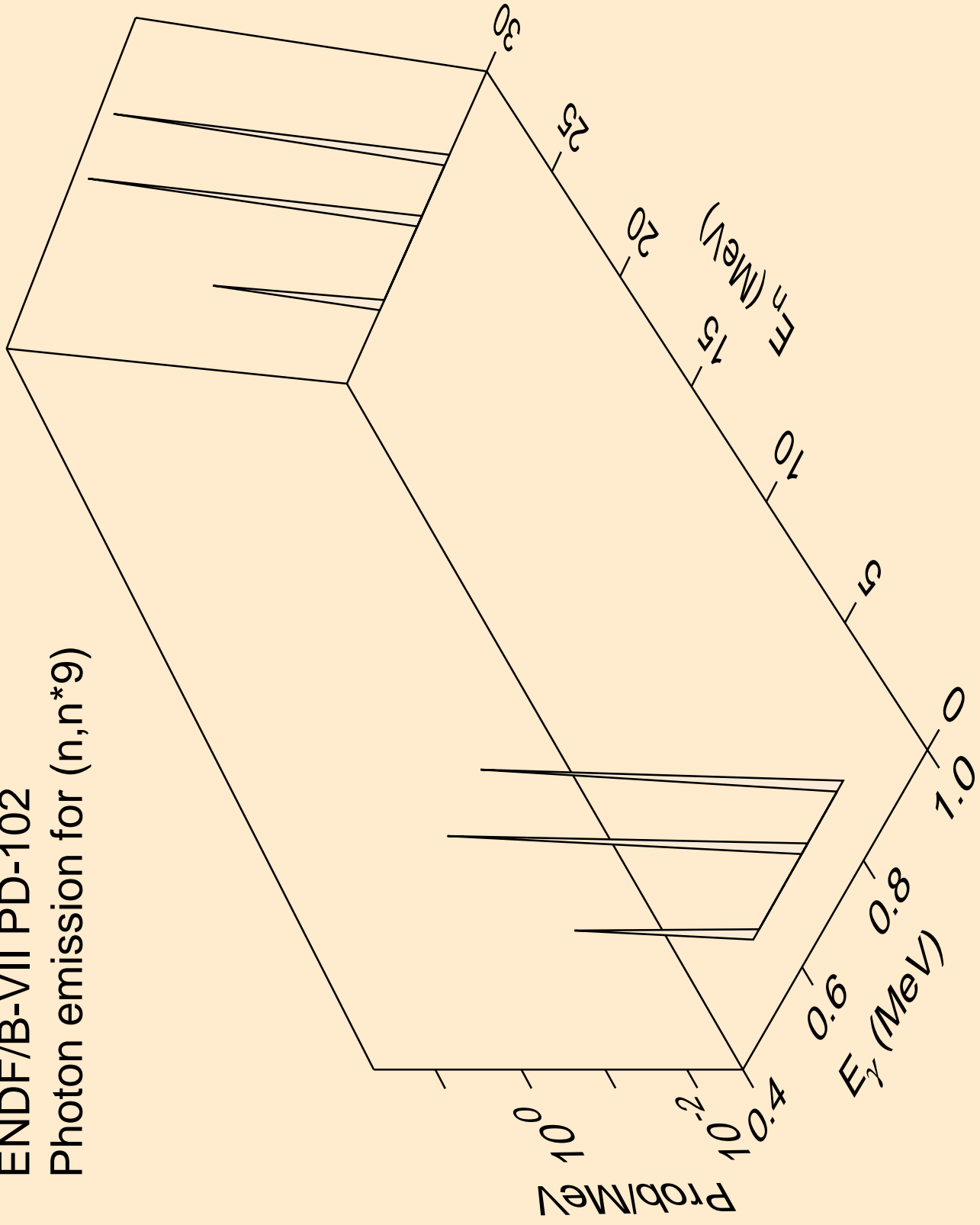

ENDF/B-VII PD-102
Photon emission for (n,n*10)

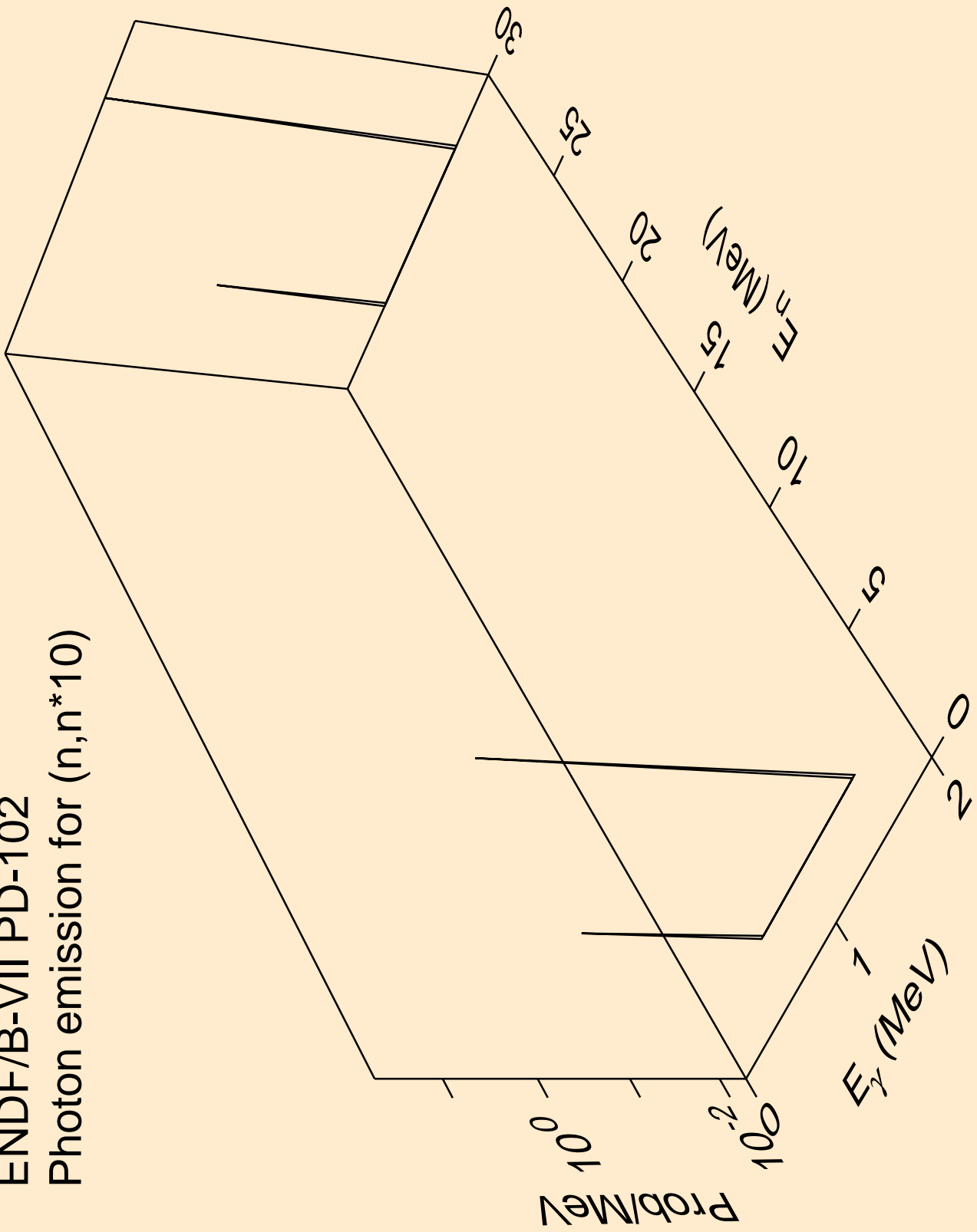

ENDF/B-VII PD-102
Photon emission for (n,n*11)

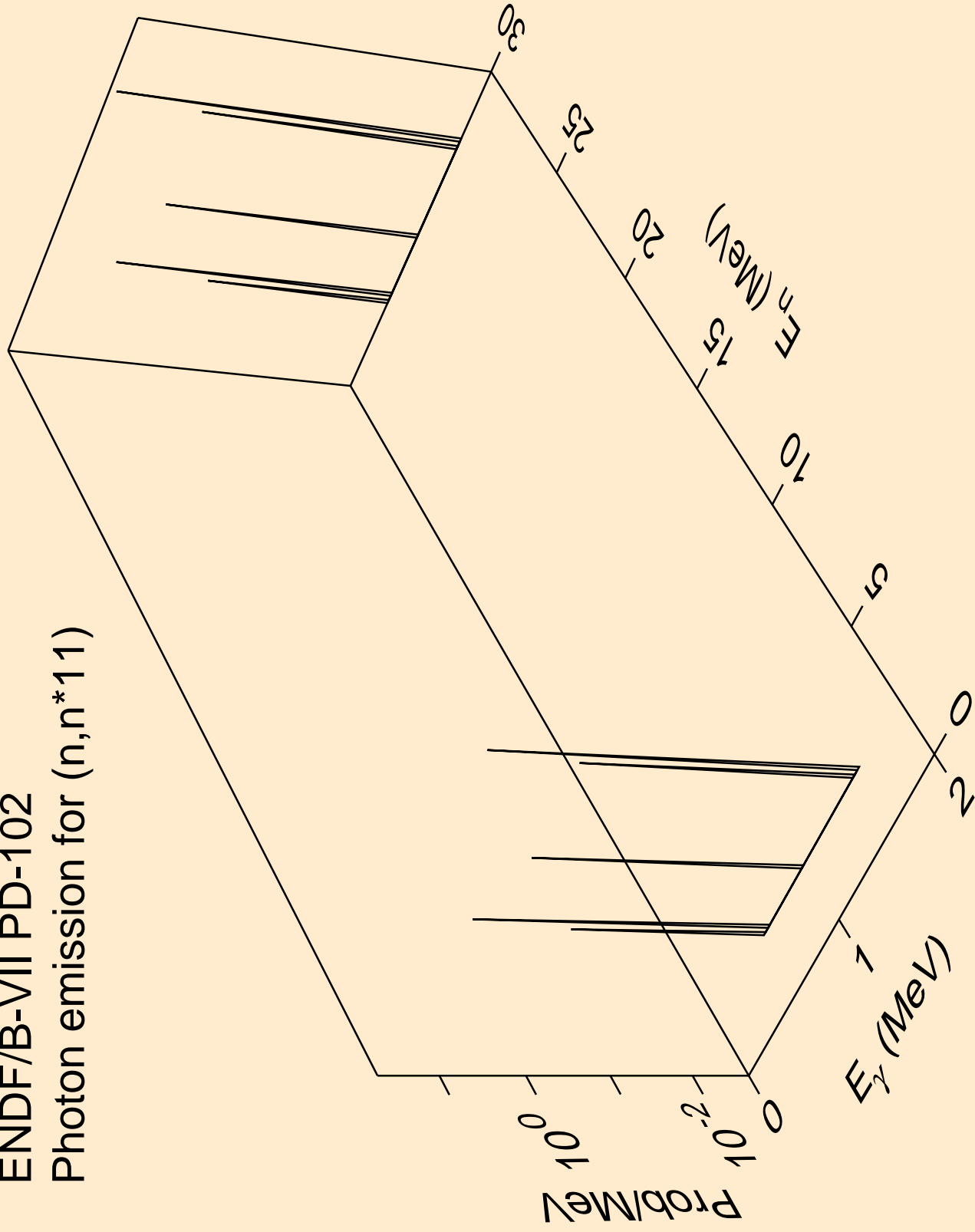

ENDF/B-VII PD-102
Photon emission for (n,n*12)

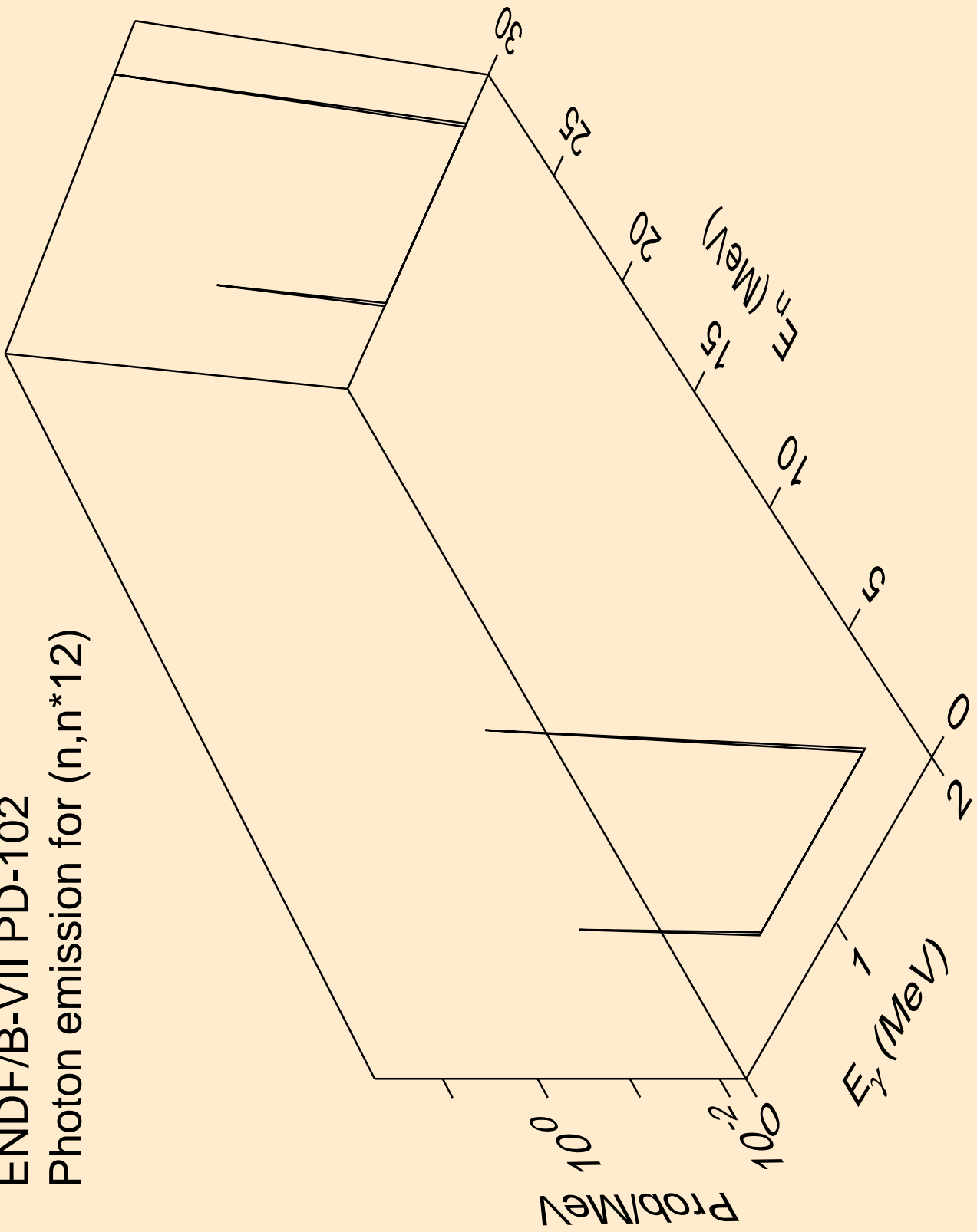

ENDF/B-VII PD-102
Photon emission for (n,n*13)

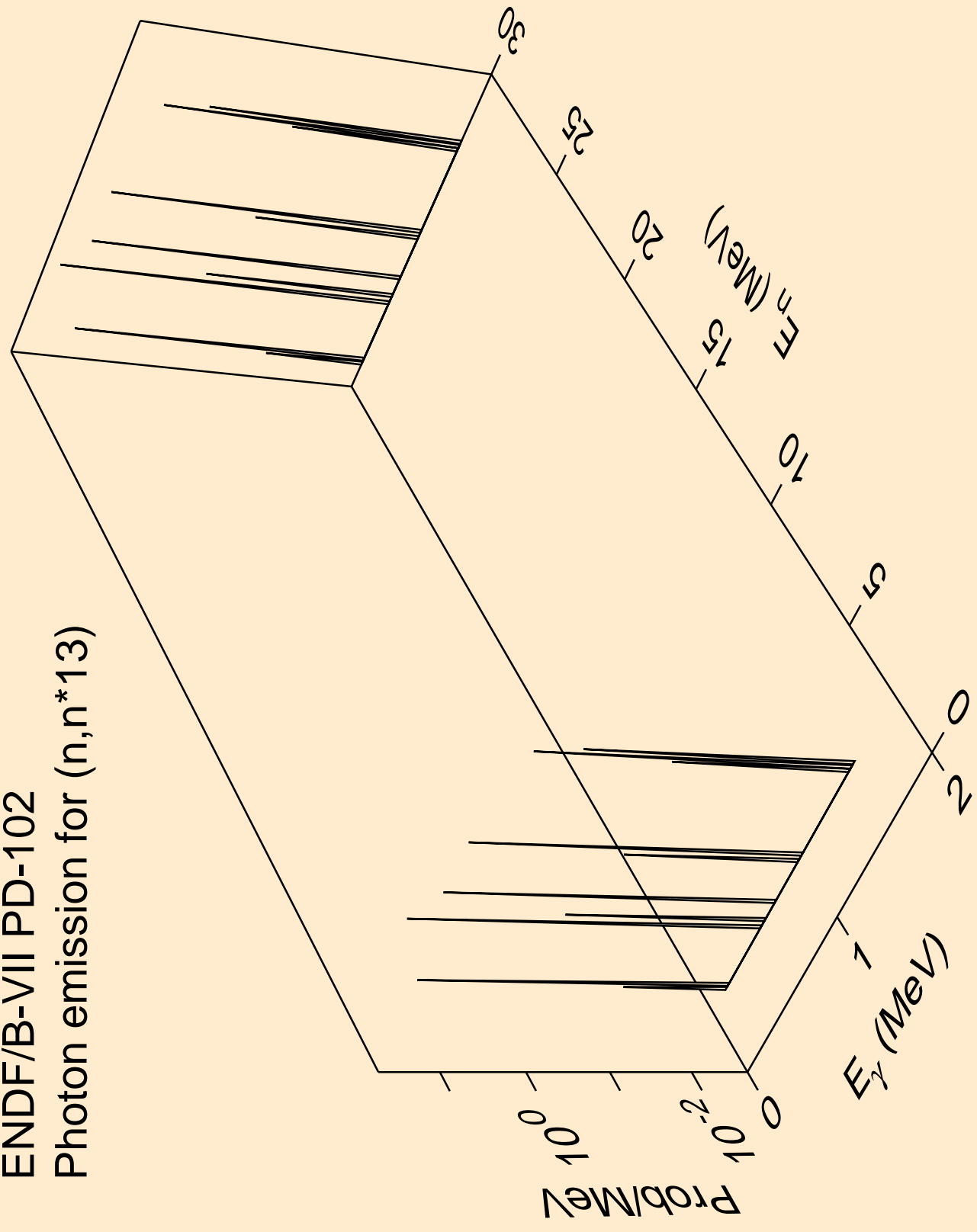

ENDF/B-VII PD-102
Photon emission for (n,n*14)

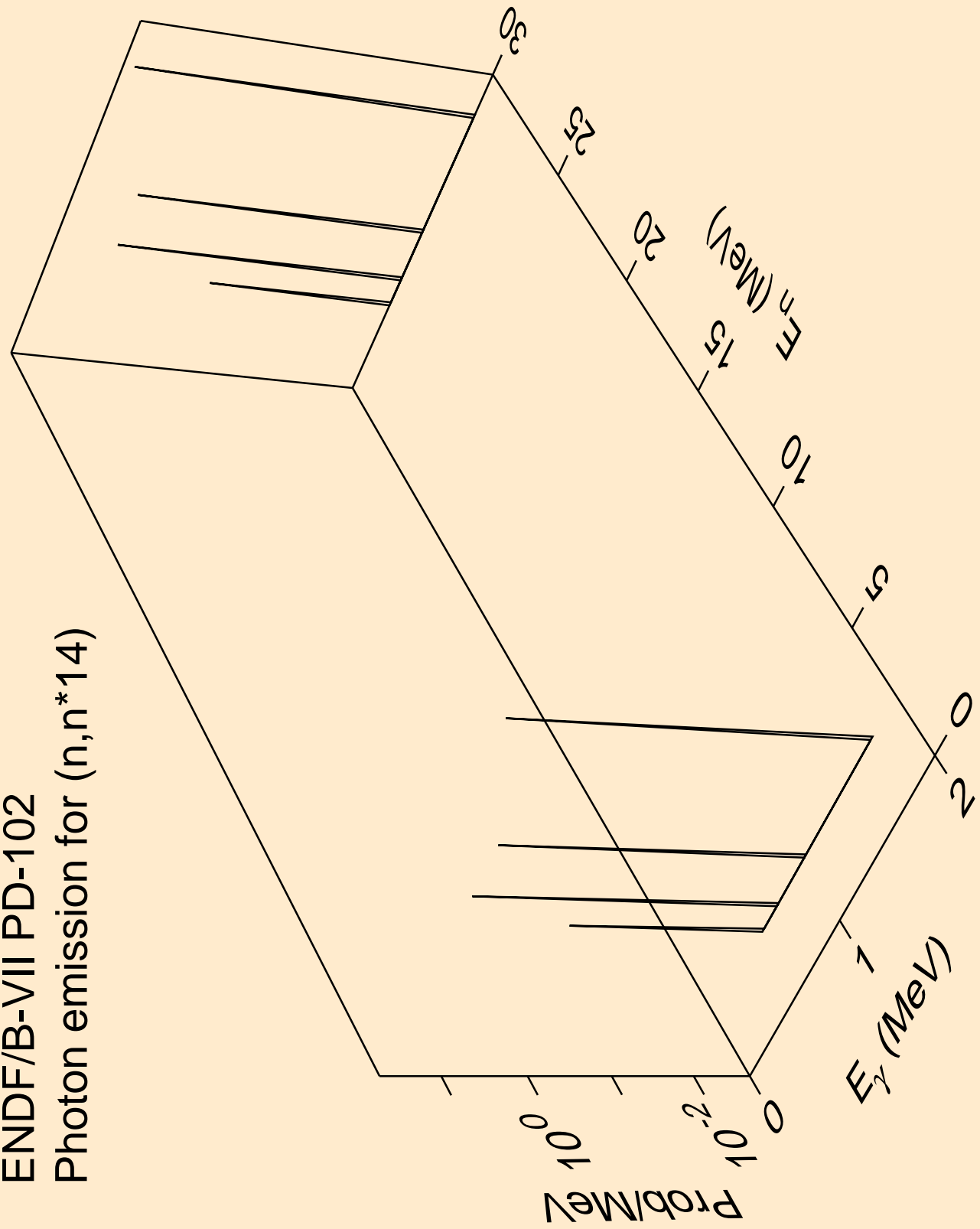

ENDF/B-VII PD-102
Photon emission for (n,n*15)

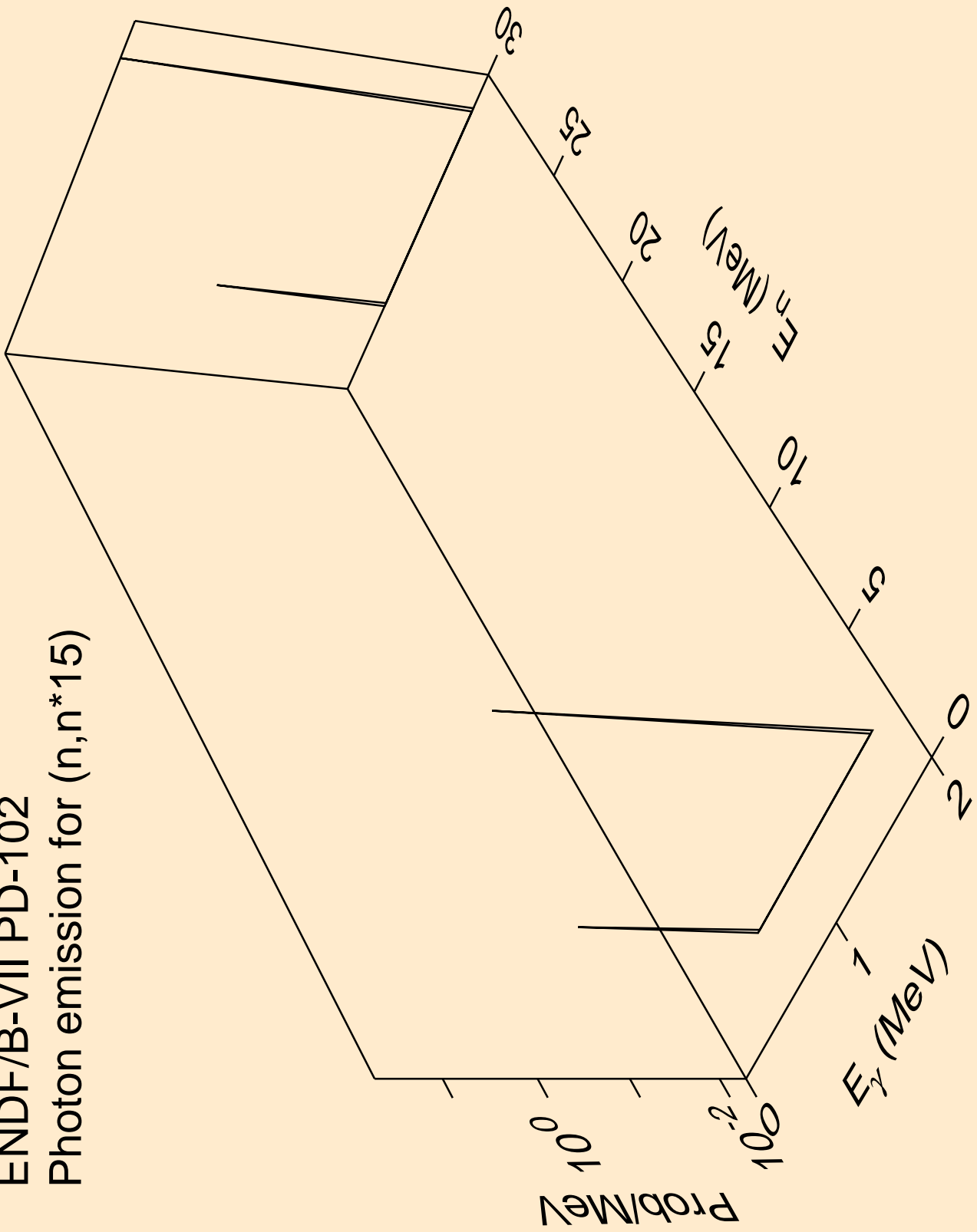

ENDF/B-VII PD-102
Photon emission for (n,n*16)

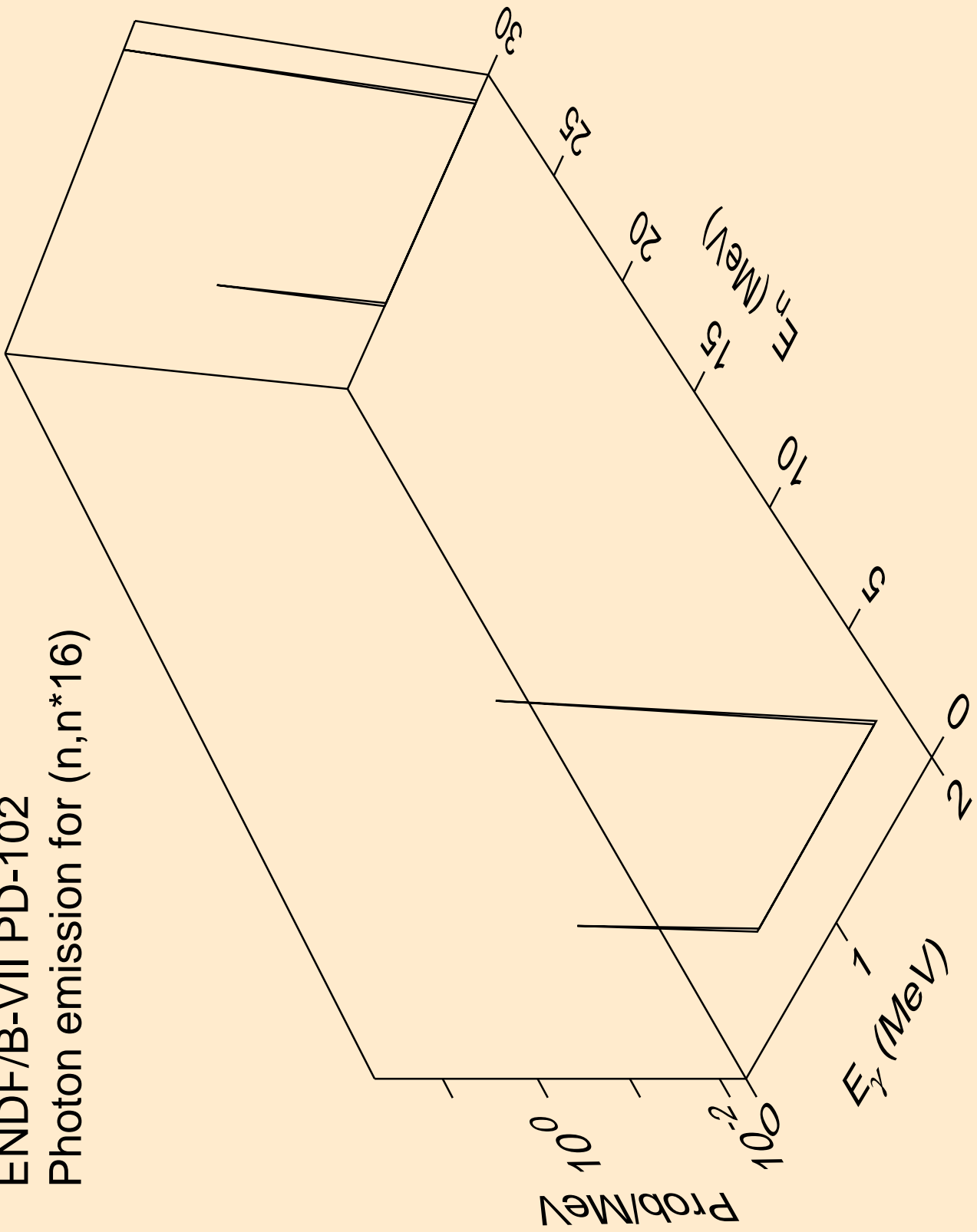

ENDF/B-VII PD-102
Photon emission for (n,n*17)

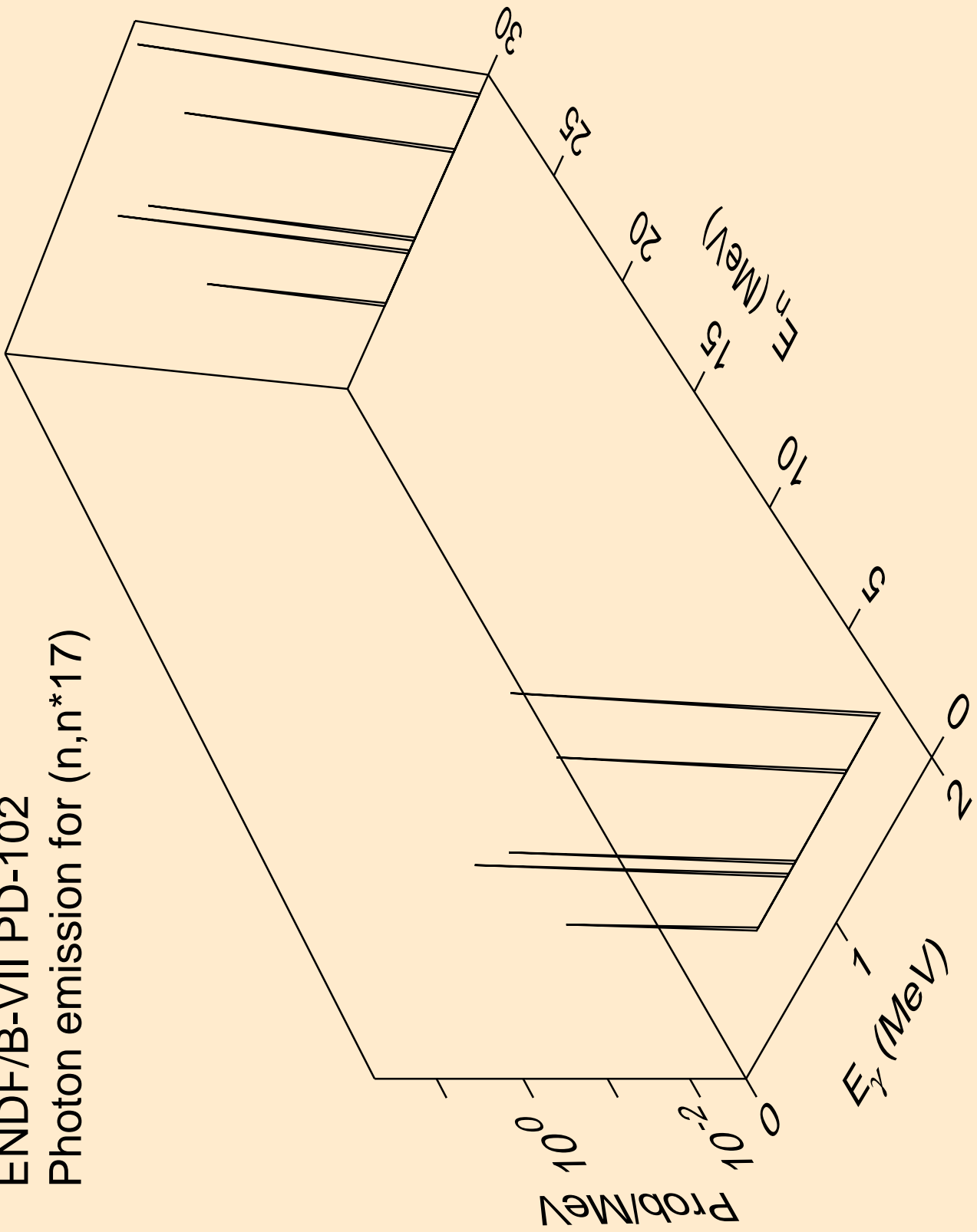

ENDF/B-VII PD-102
Photon emission for (n,n*18)

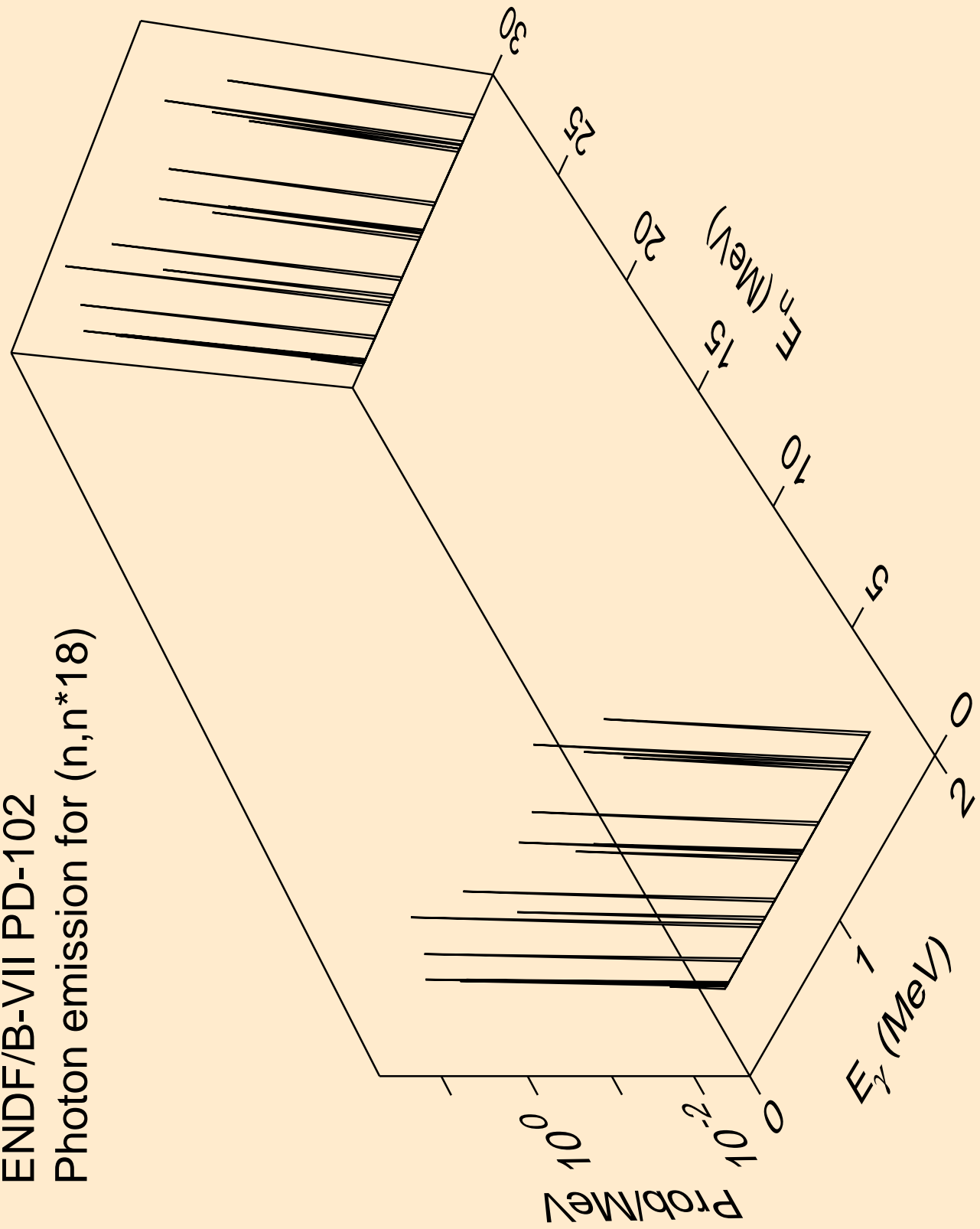

ENDF/B-VII PD-102
Photon emission for (n,n*19)

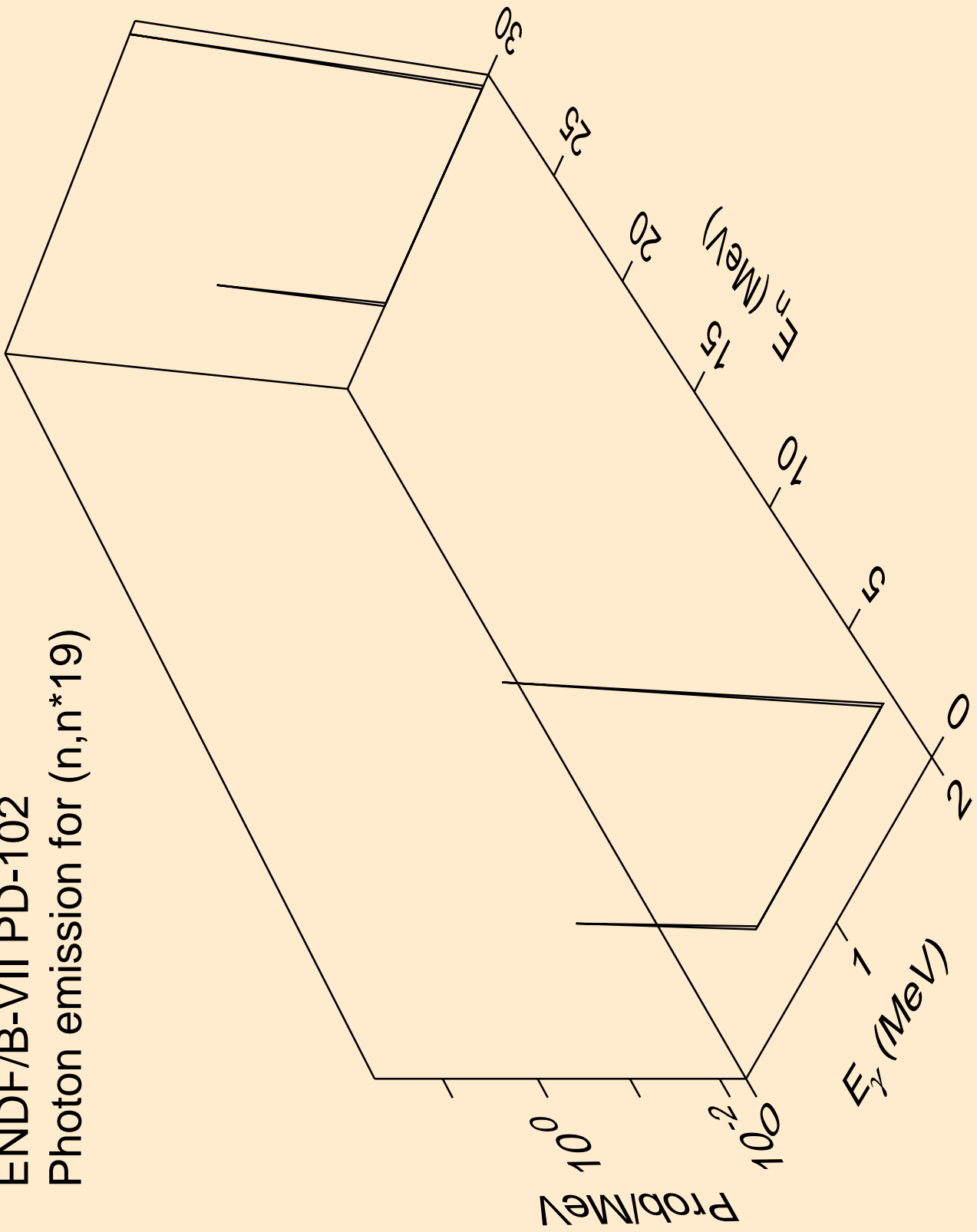

ENDF/B-VII PD-102
Photon emission for (n,n*c)

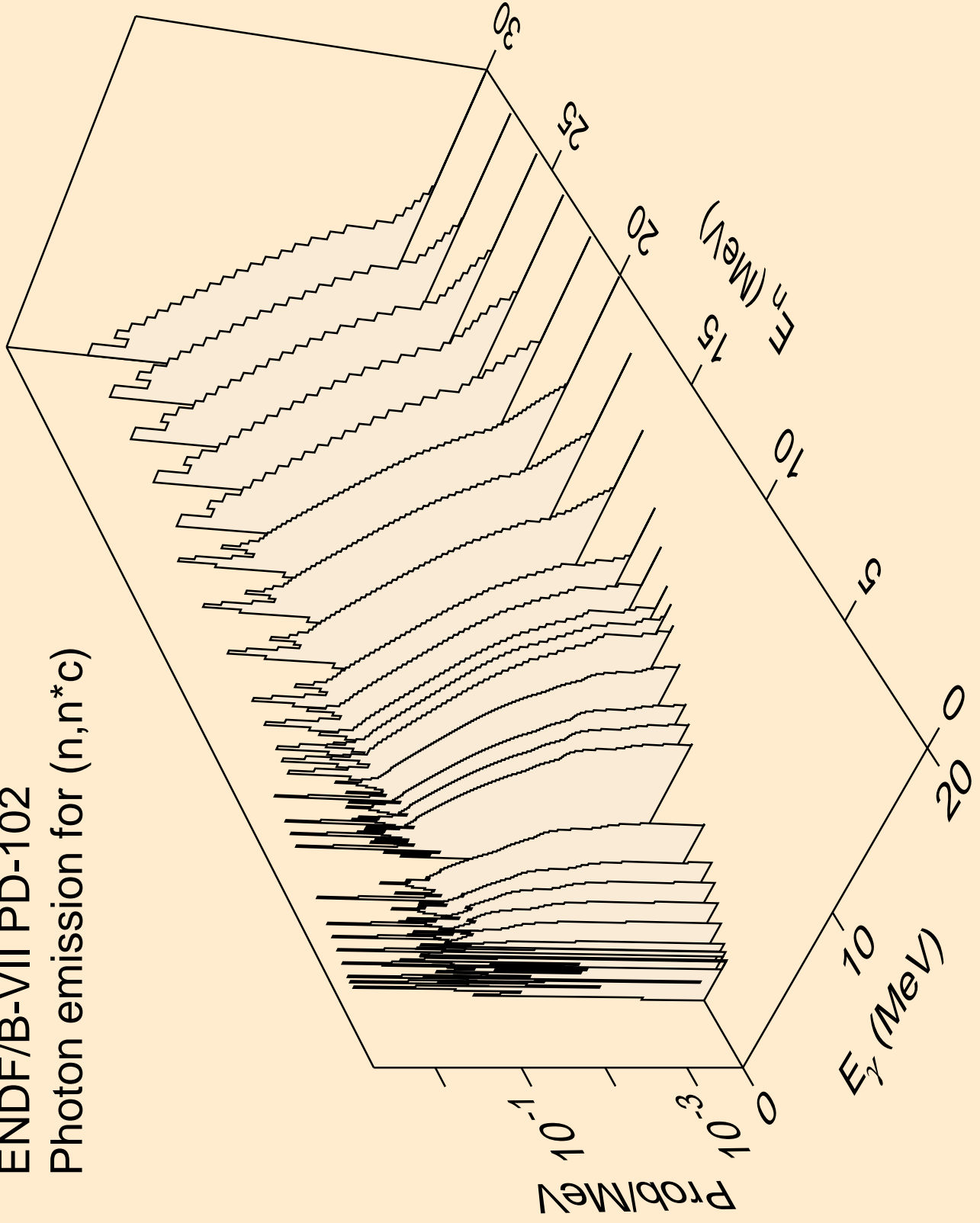

ENDF/B-VII PD-102
Photon emission for (n,2p)

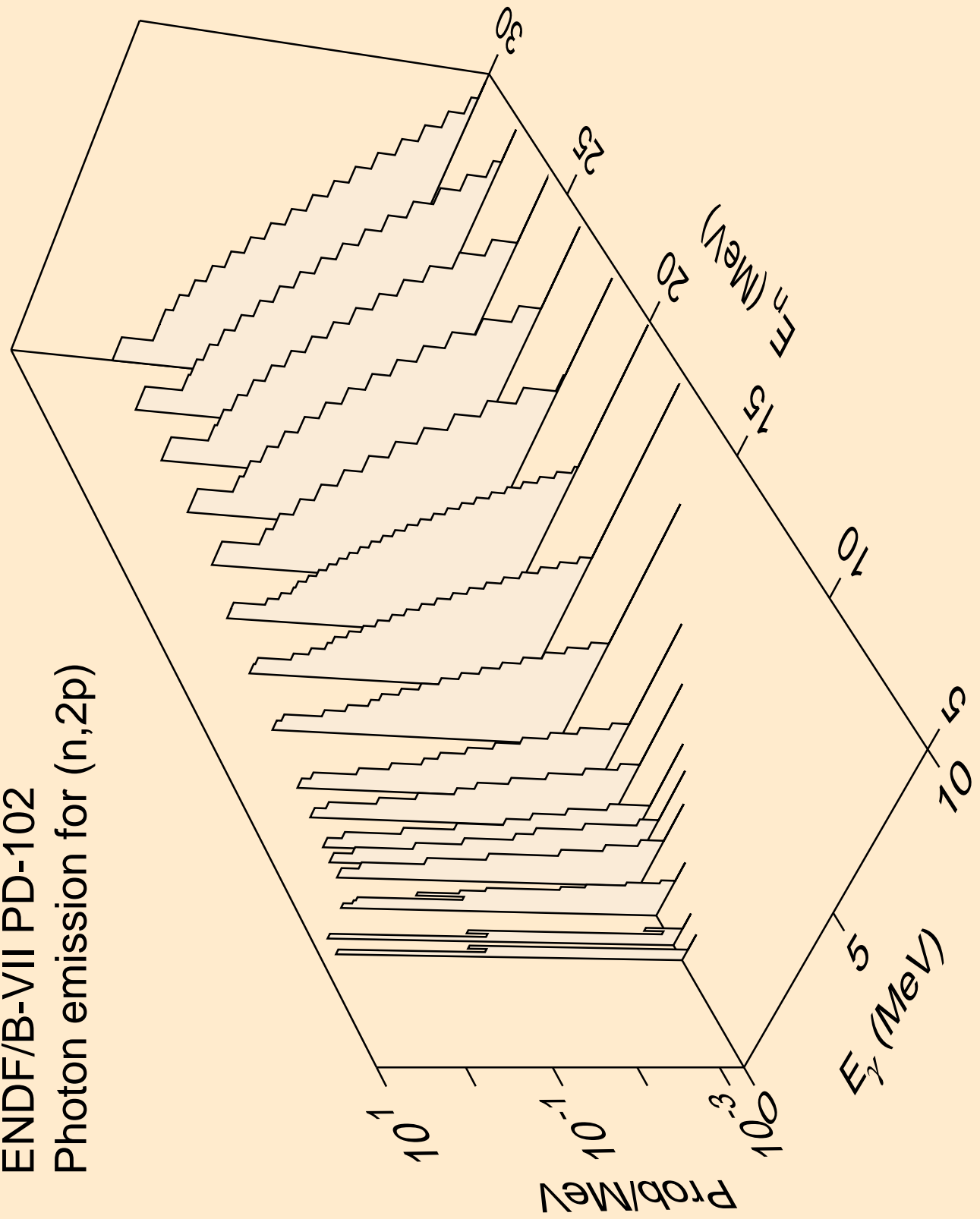

ENDF/B-VII PD-102
Photon emission for (n,p*1)

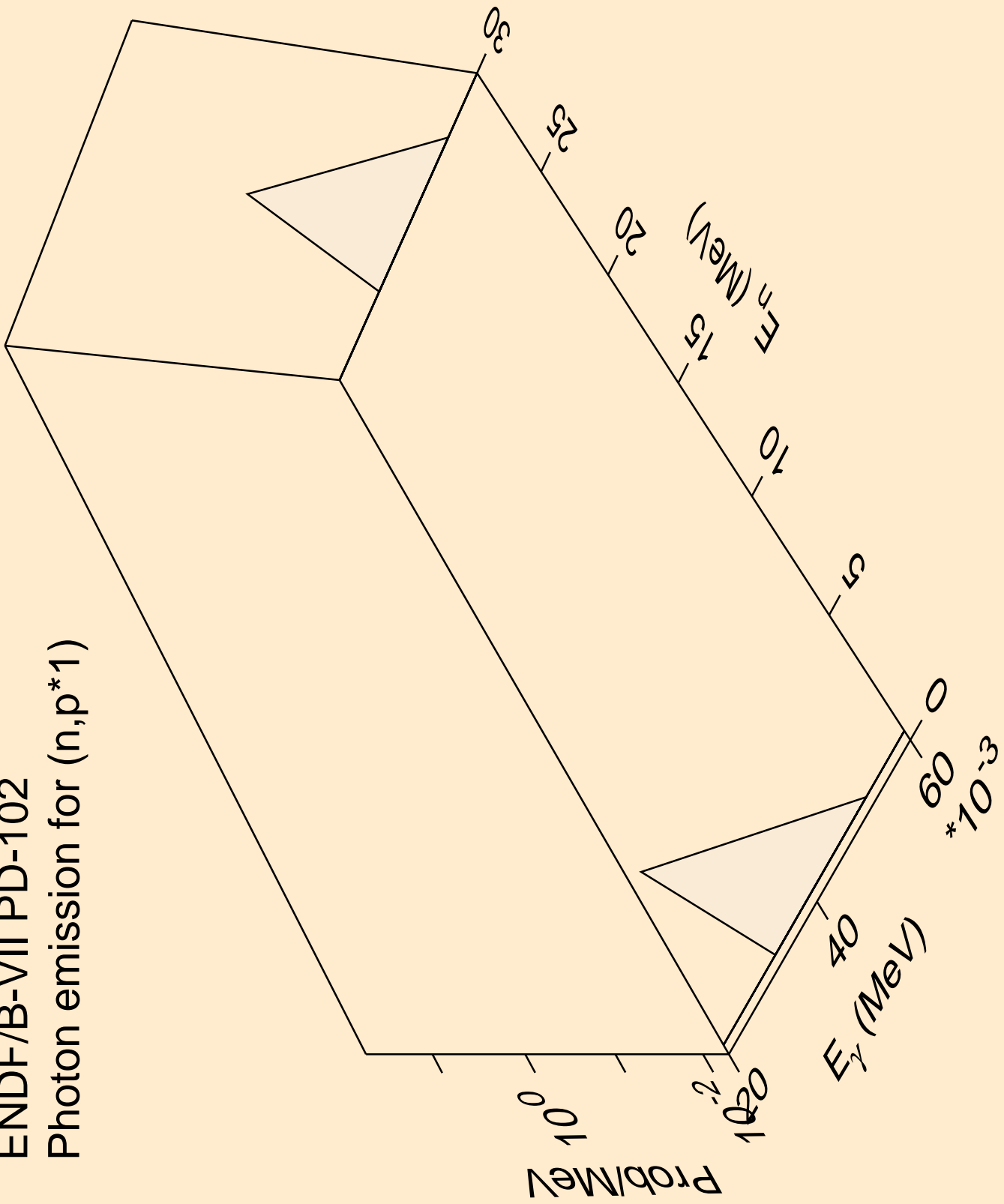

ENDF/B-VII PD-102
Photon emission for (n,p*2)

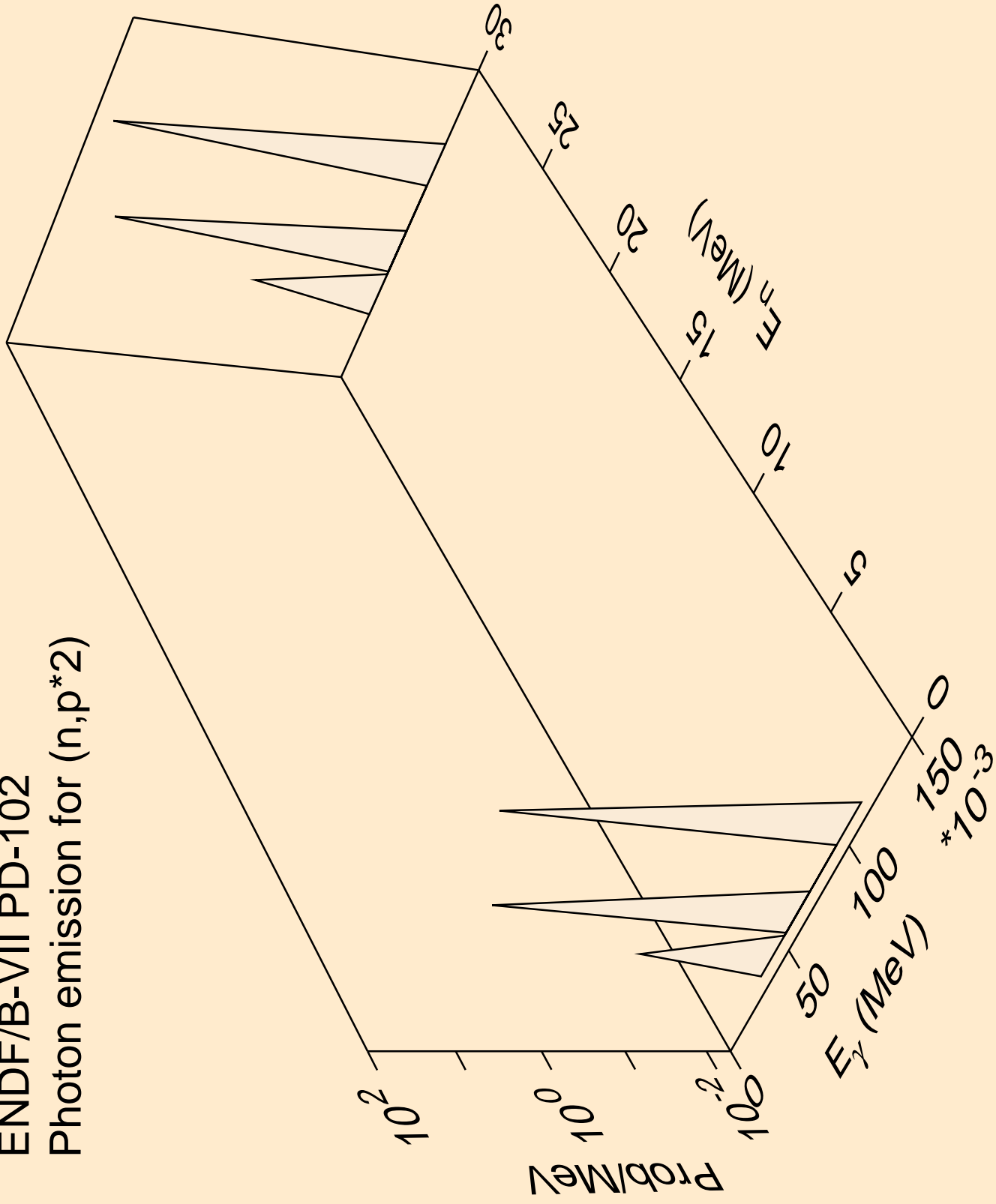

ENDF/B-VII PD-102
Photon emission for (n,p*3)

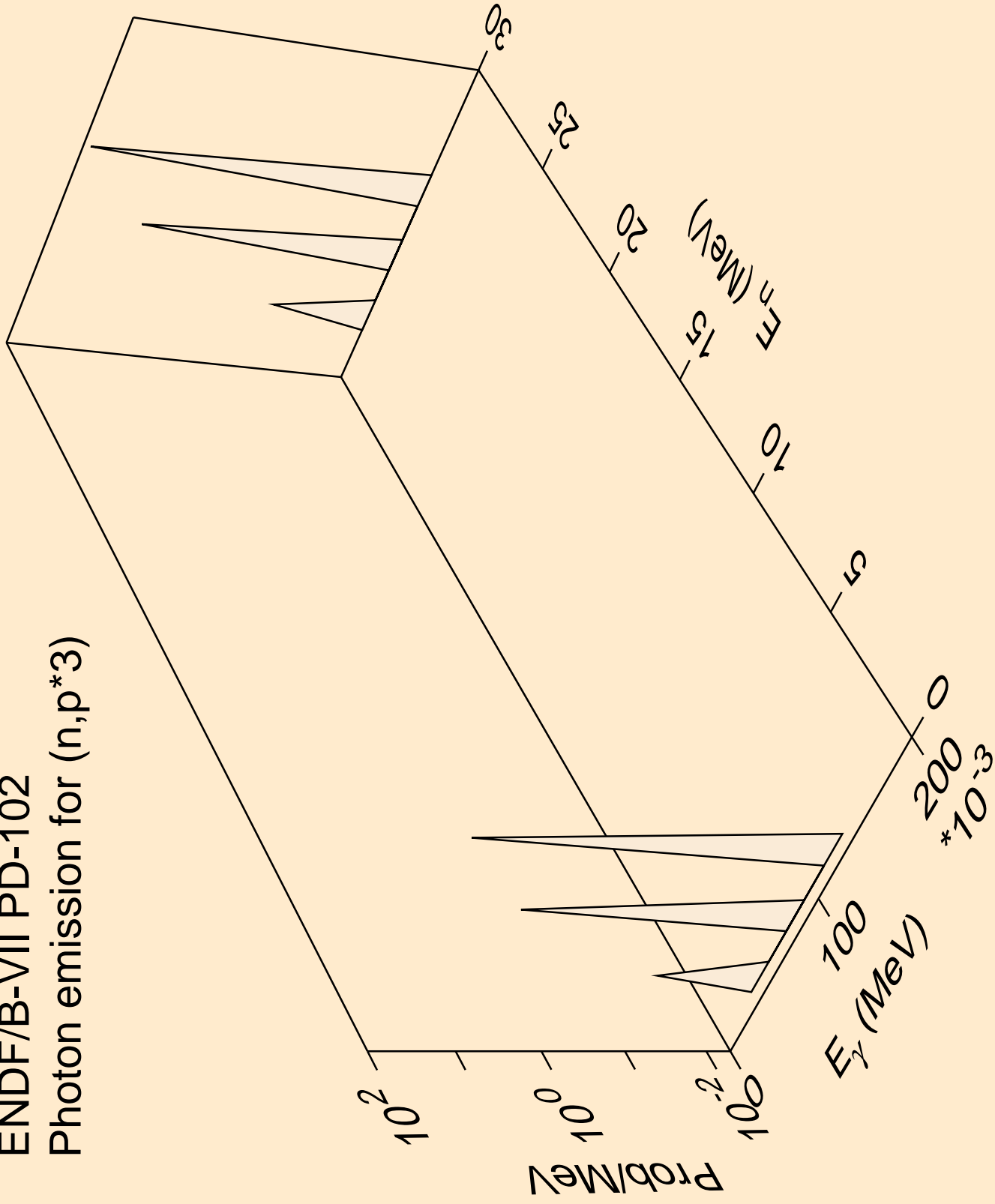

ENDF/B-VII PD-102
Photon emission for (n,p*4)

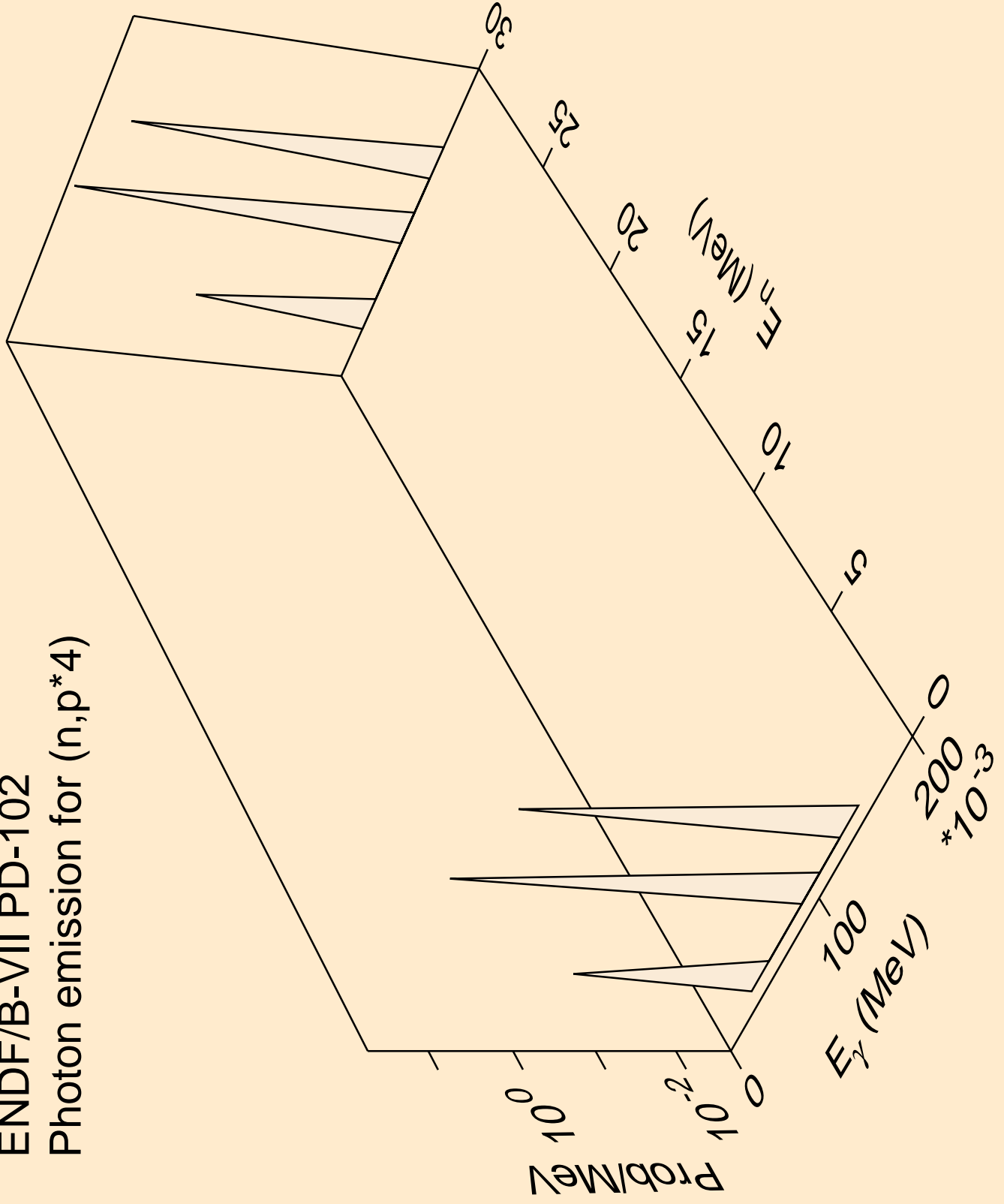

ENDF/B-VII PD-102
Photon emission for (n,p*5)

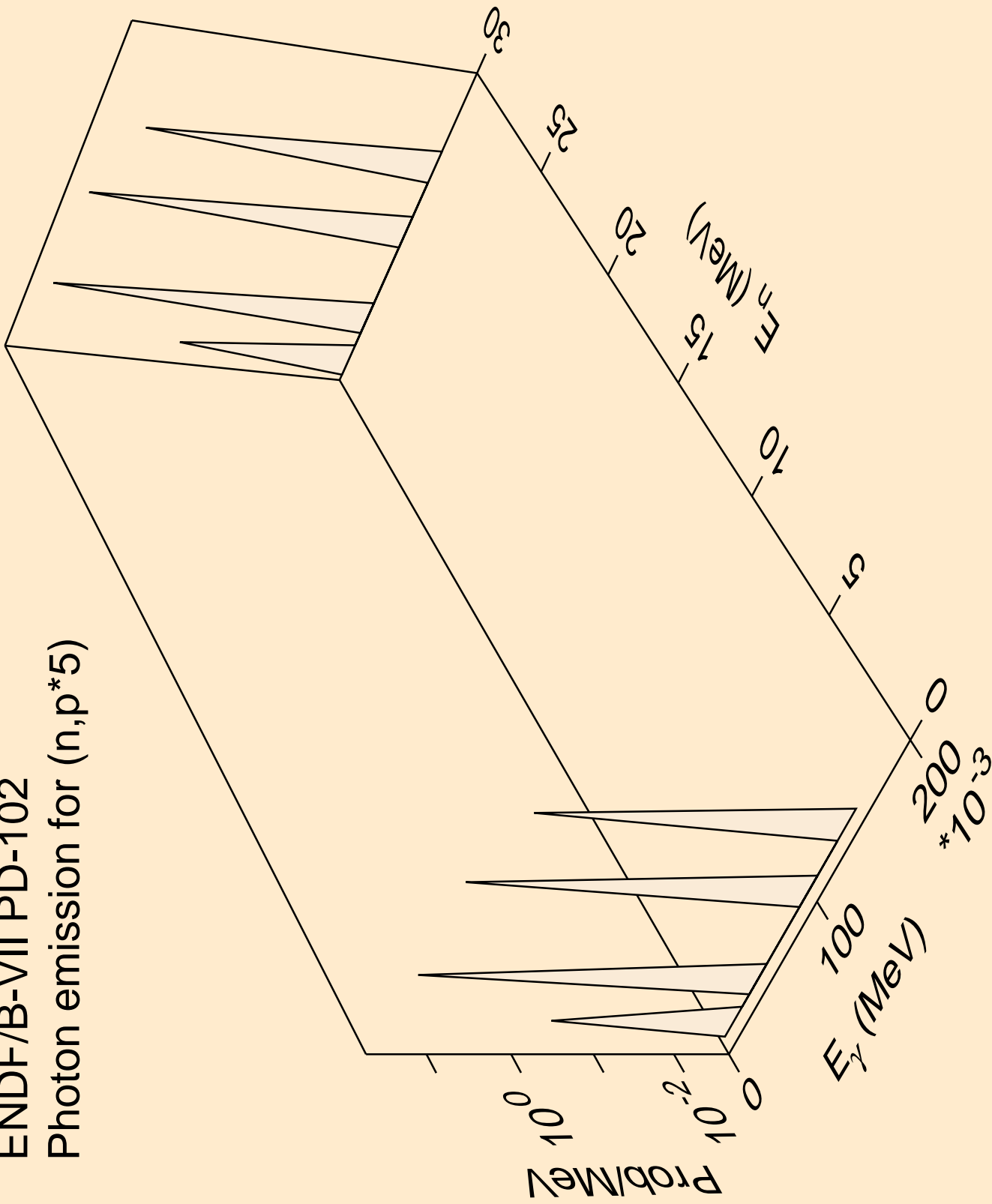

ENDF/B-VII PD-102
Photon emission for (n,p*c)

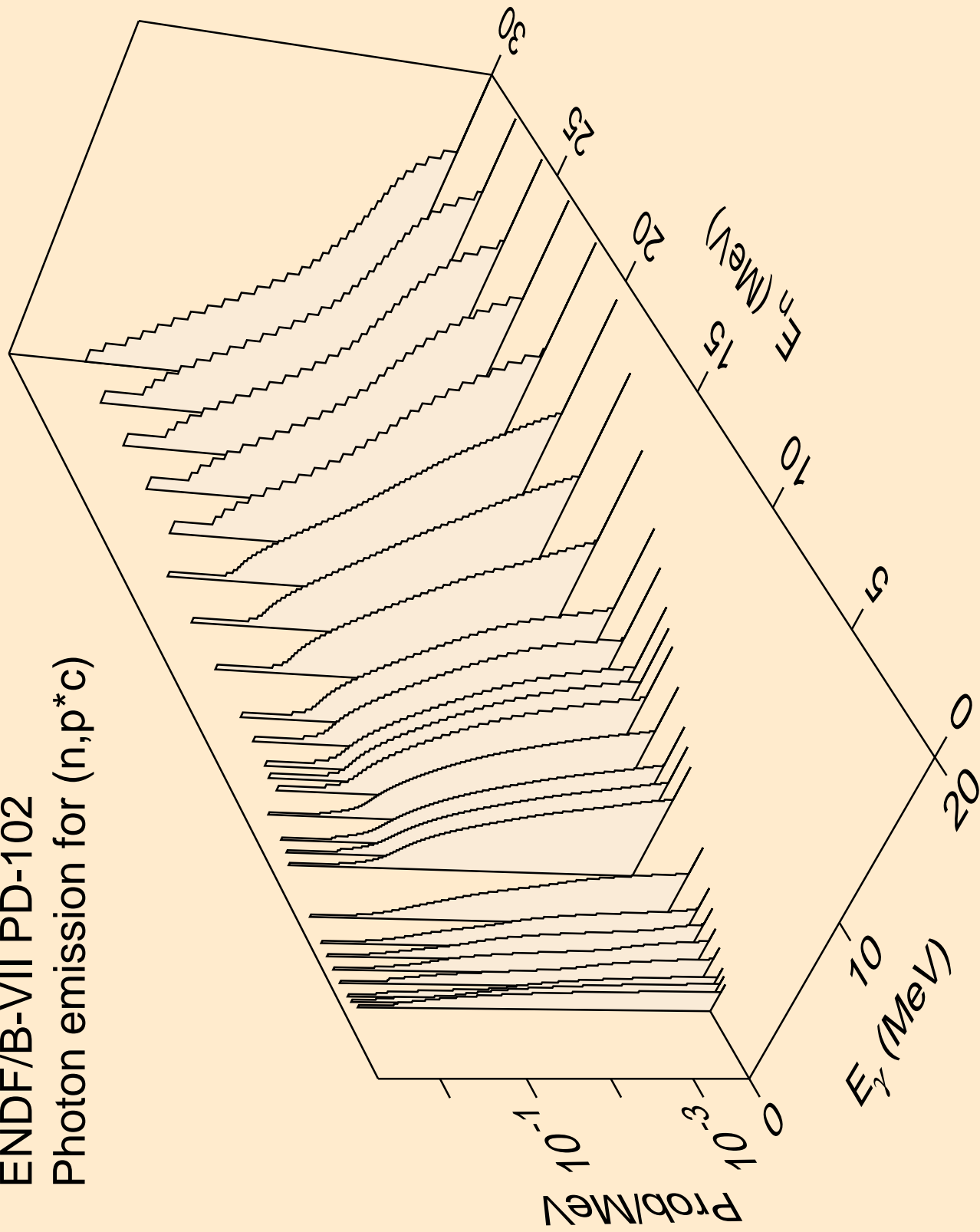

ENDF/B-VII PD-102
Photon emission for (n,d*1)

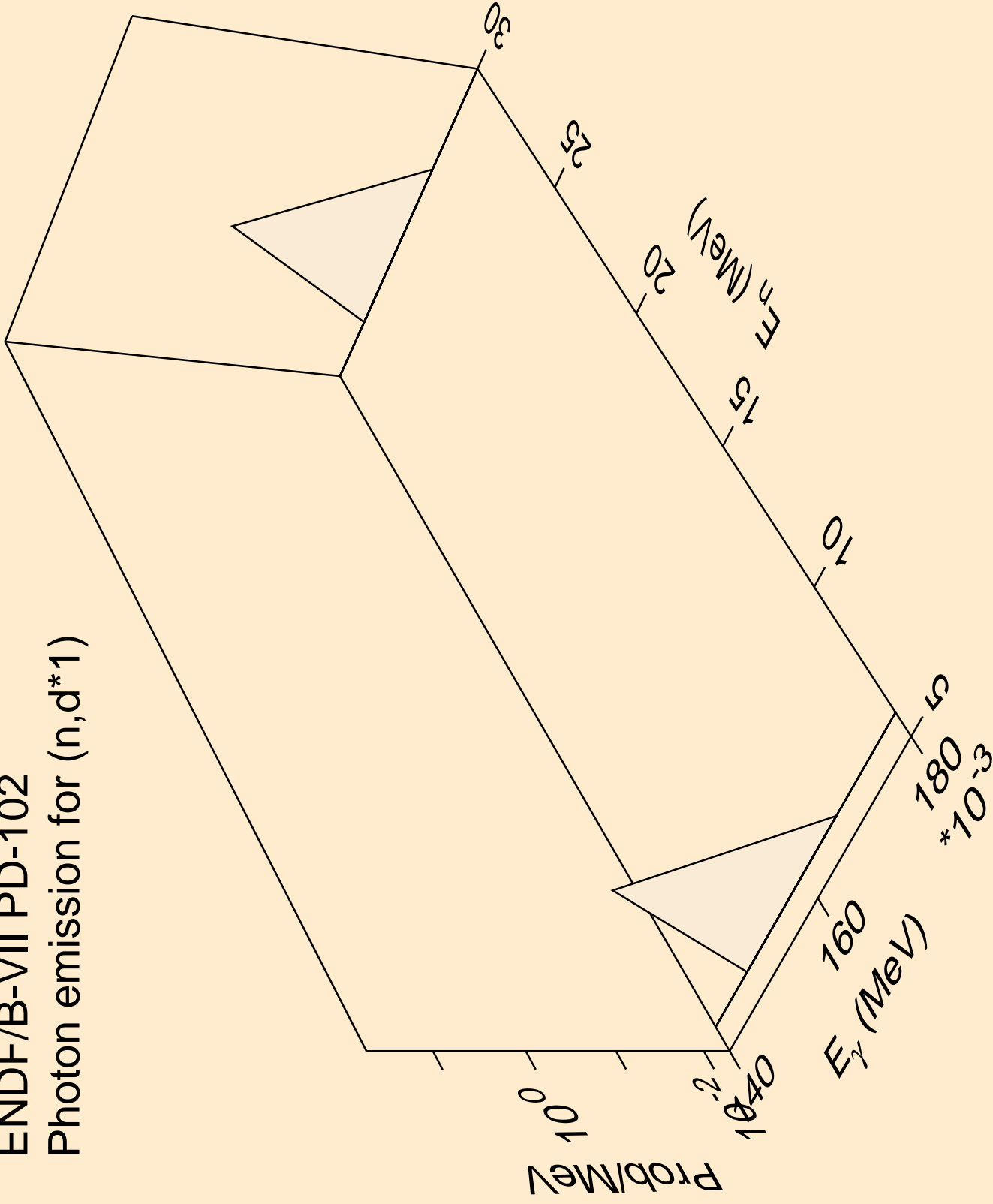

ENDF/B-VII PD-102
Photon emission for (n,d*2)

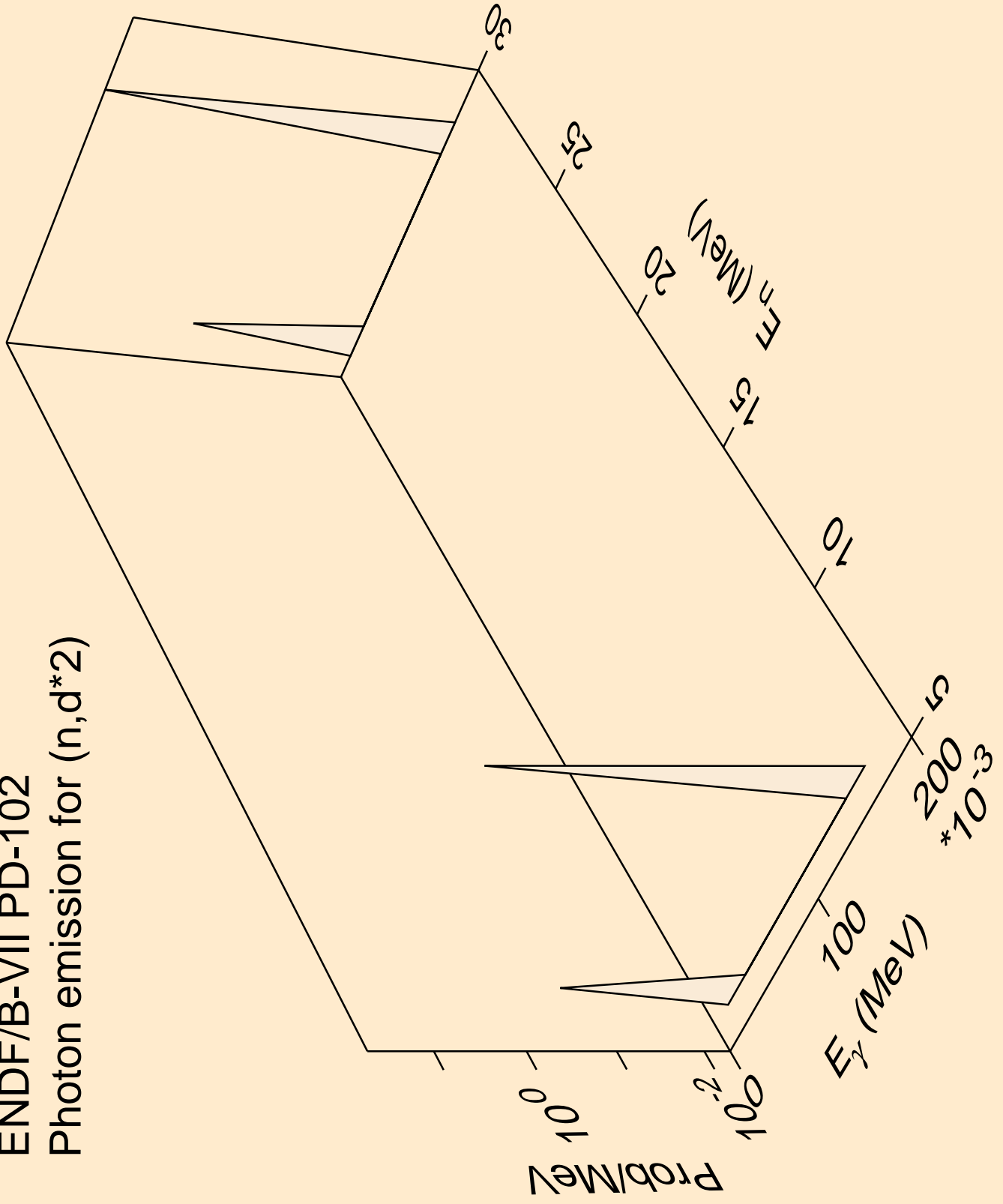

ENDF/B-VII PD-102
Photon emission for (n,d*3)

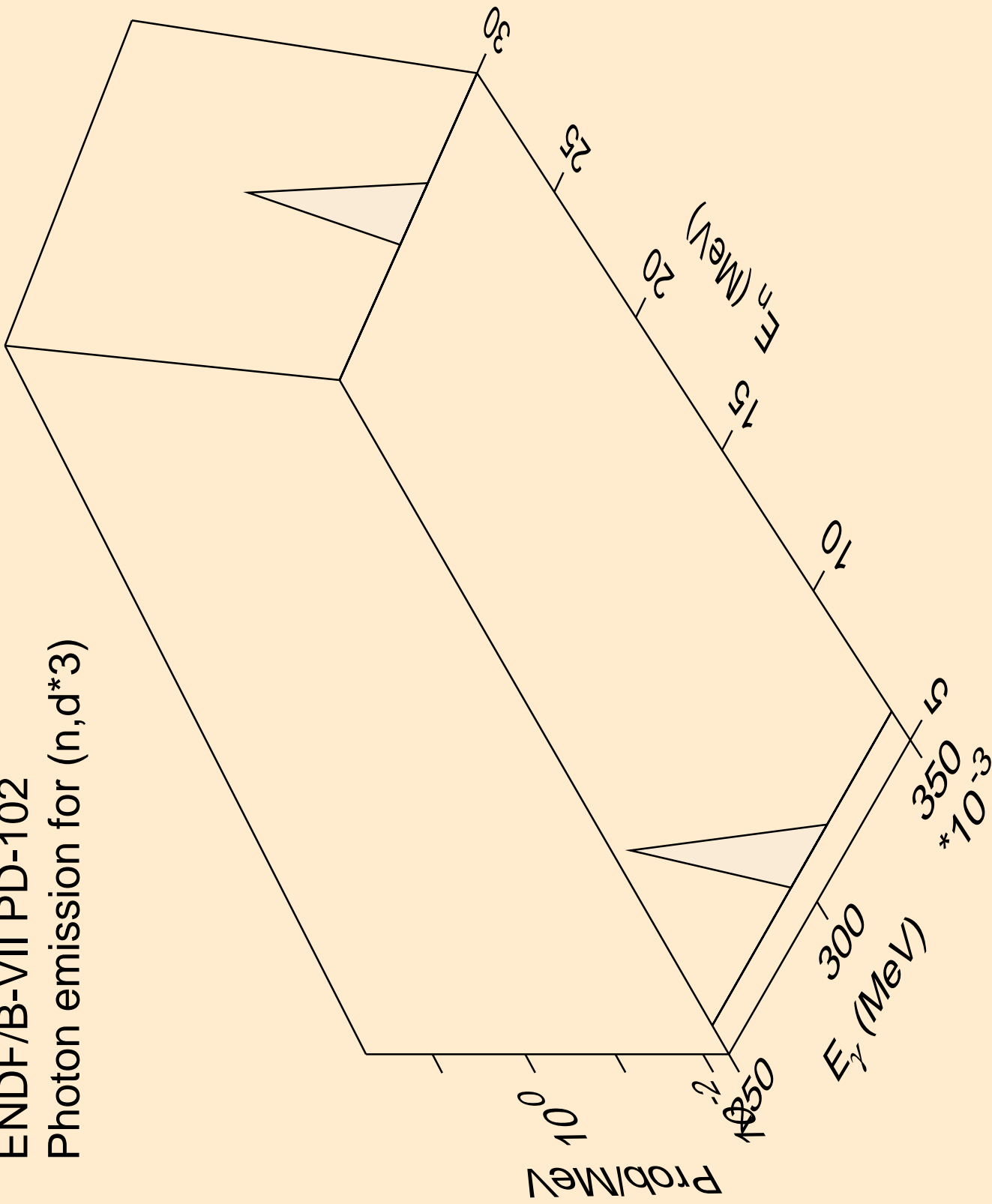

ENDF/B-VII PD-102
Photon emission for (n,d*4)

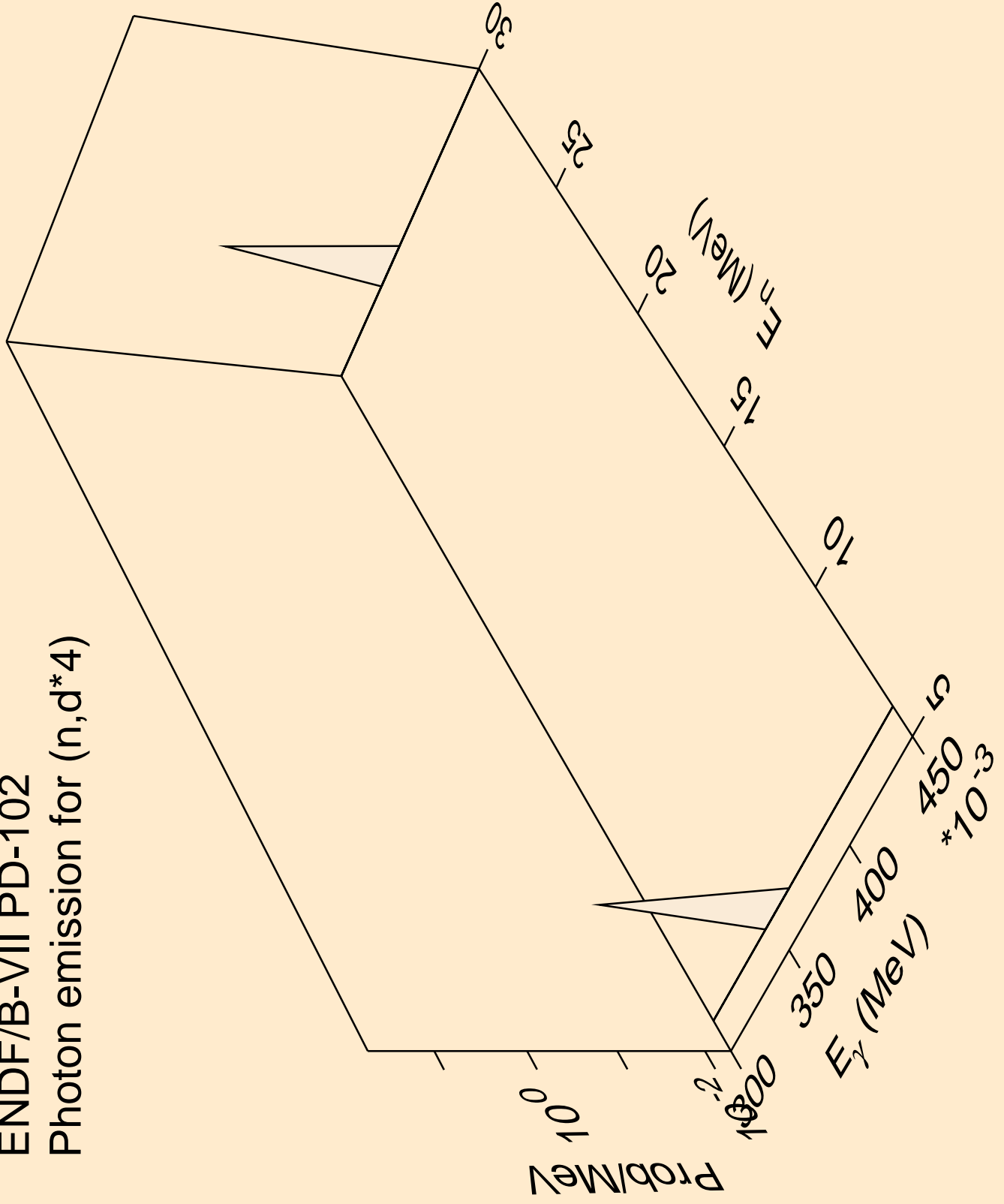

ENDF/B-VII PD-102
Photon emission for (n,d*5)

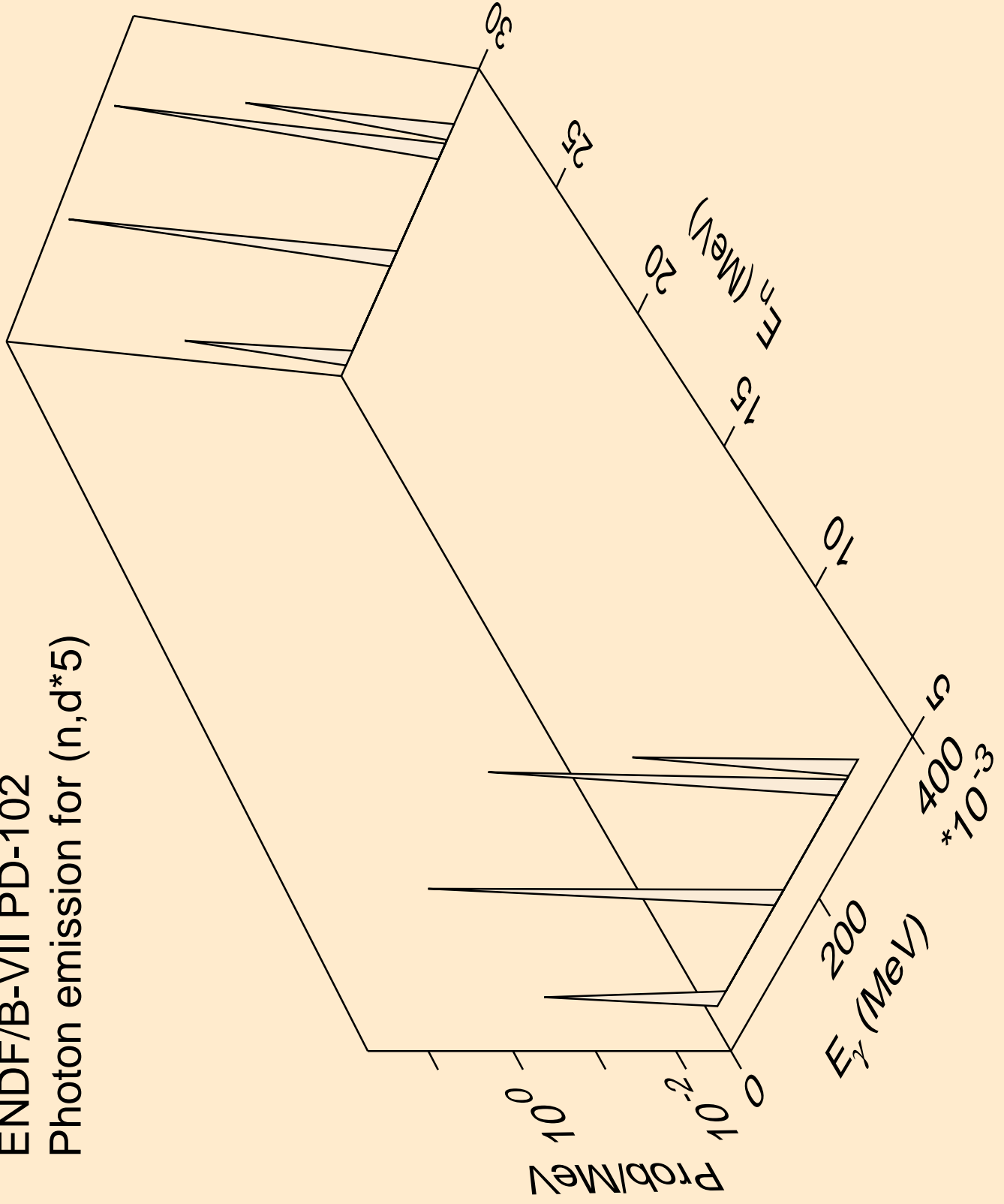

ENDF/B-VII PD-102
Photon emission for (n,d*6)

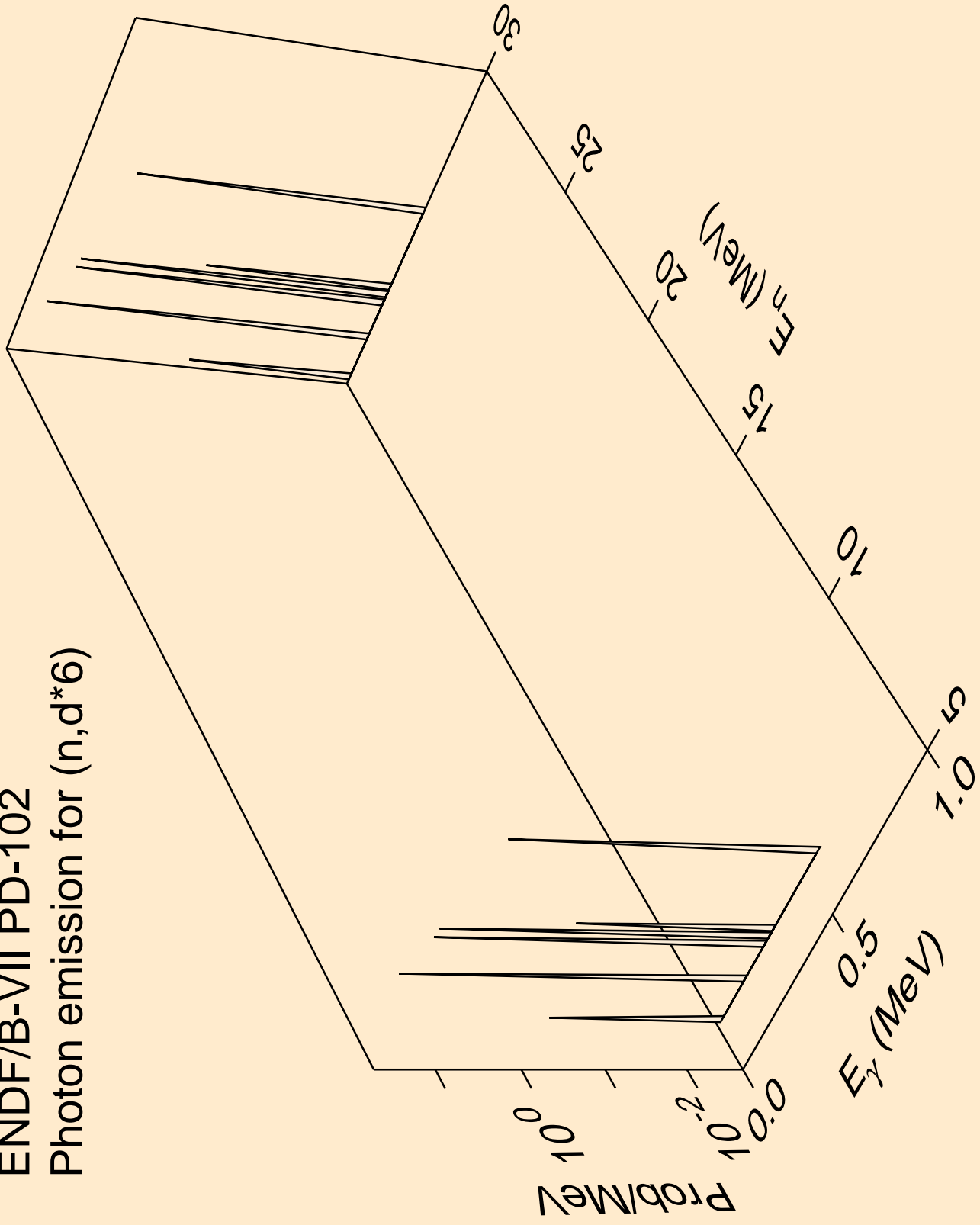

ENDF/B-VII PD-102
Photon emission for (n,d*7)

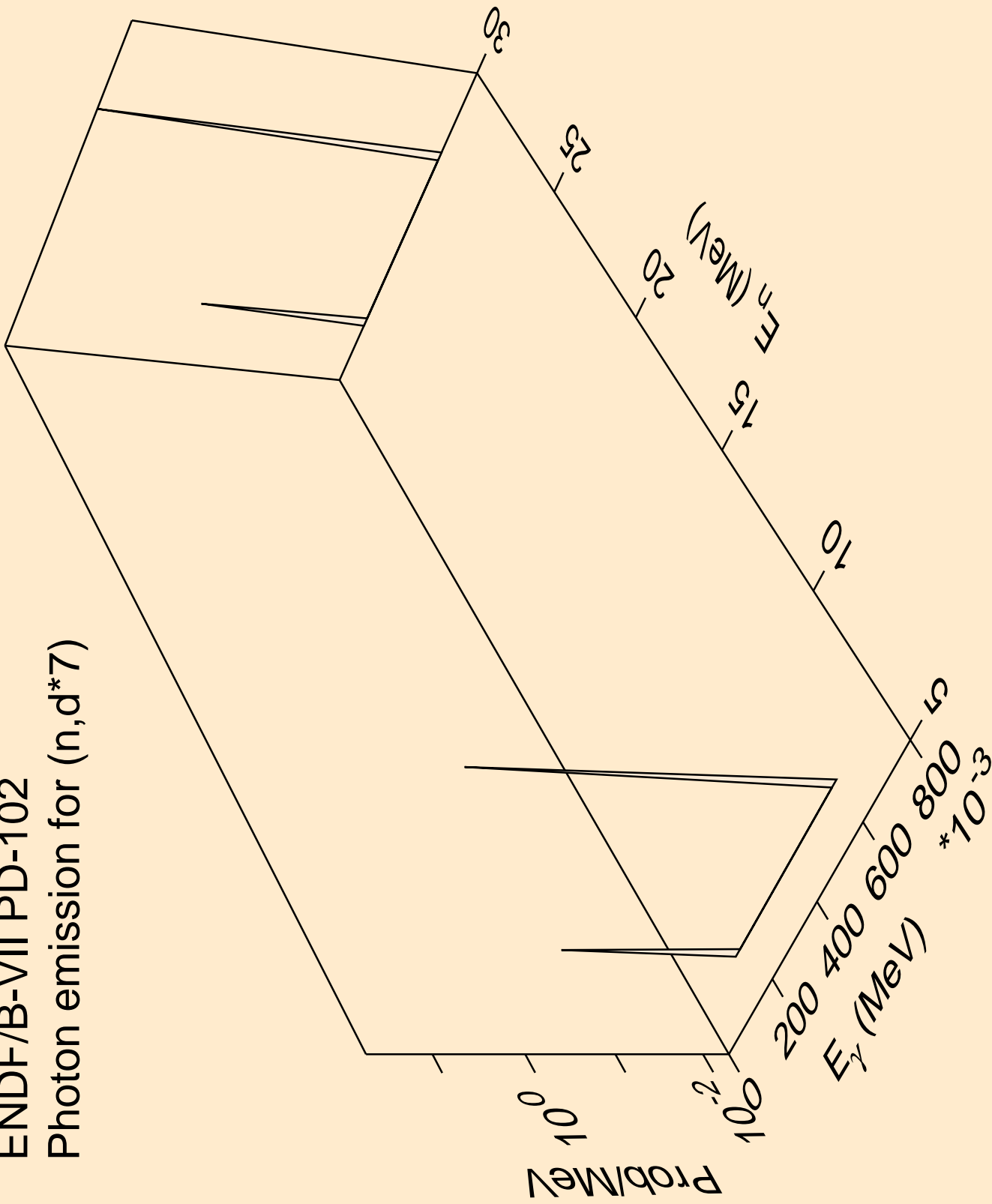

ENDF/B-VII PD-102
Photon emission for (n,d*8)

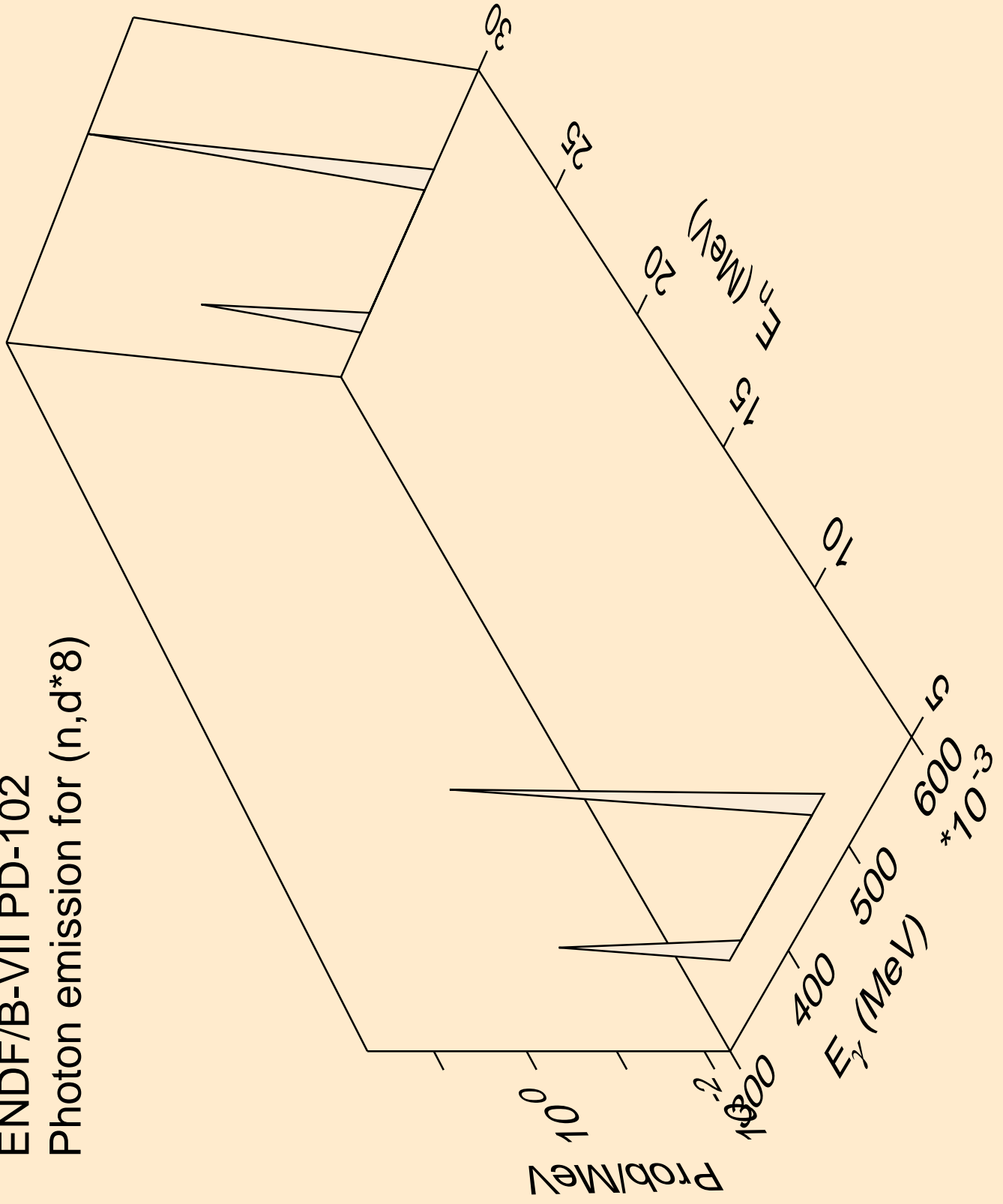

ENDF/B-VII PD-102
Photon emission for (n,d*9)

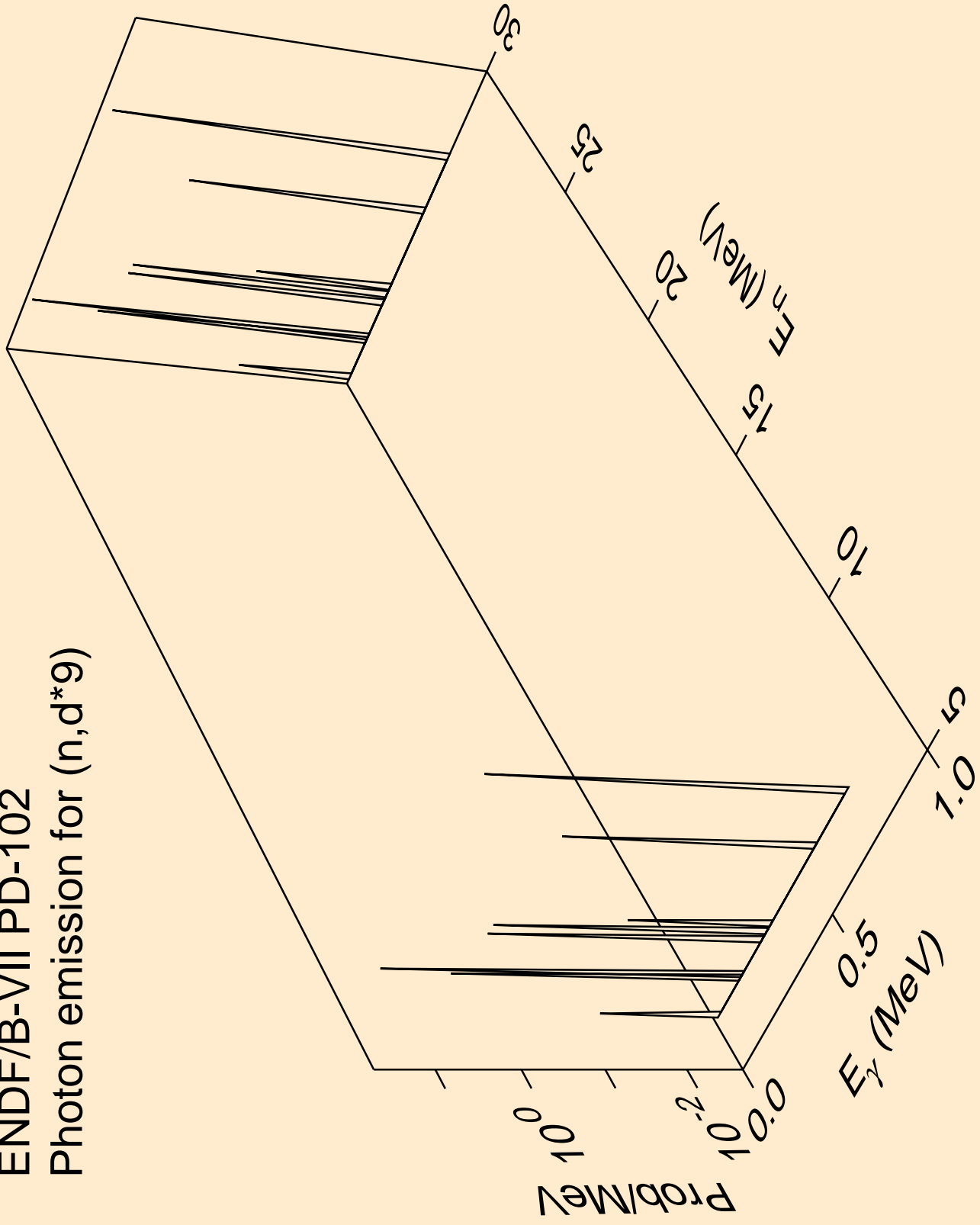

ENDF/B-VII PD-102
Photon emission for (n,d*10)

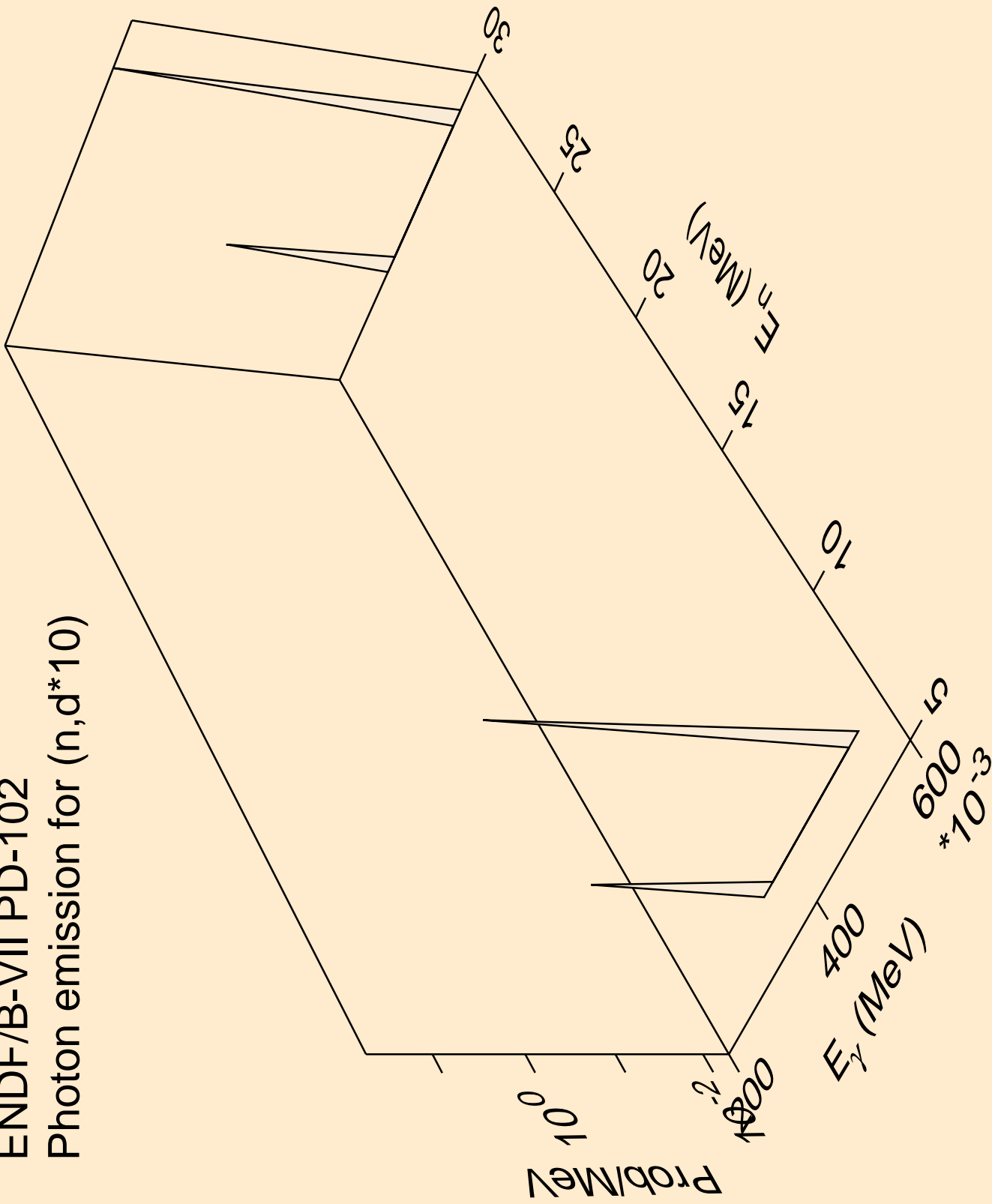

ENDF/B-VII PD-102
Photon emission for (n,d*11)

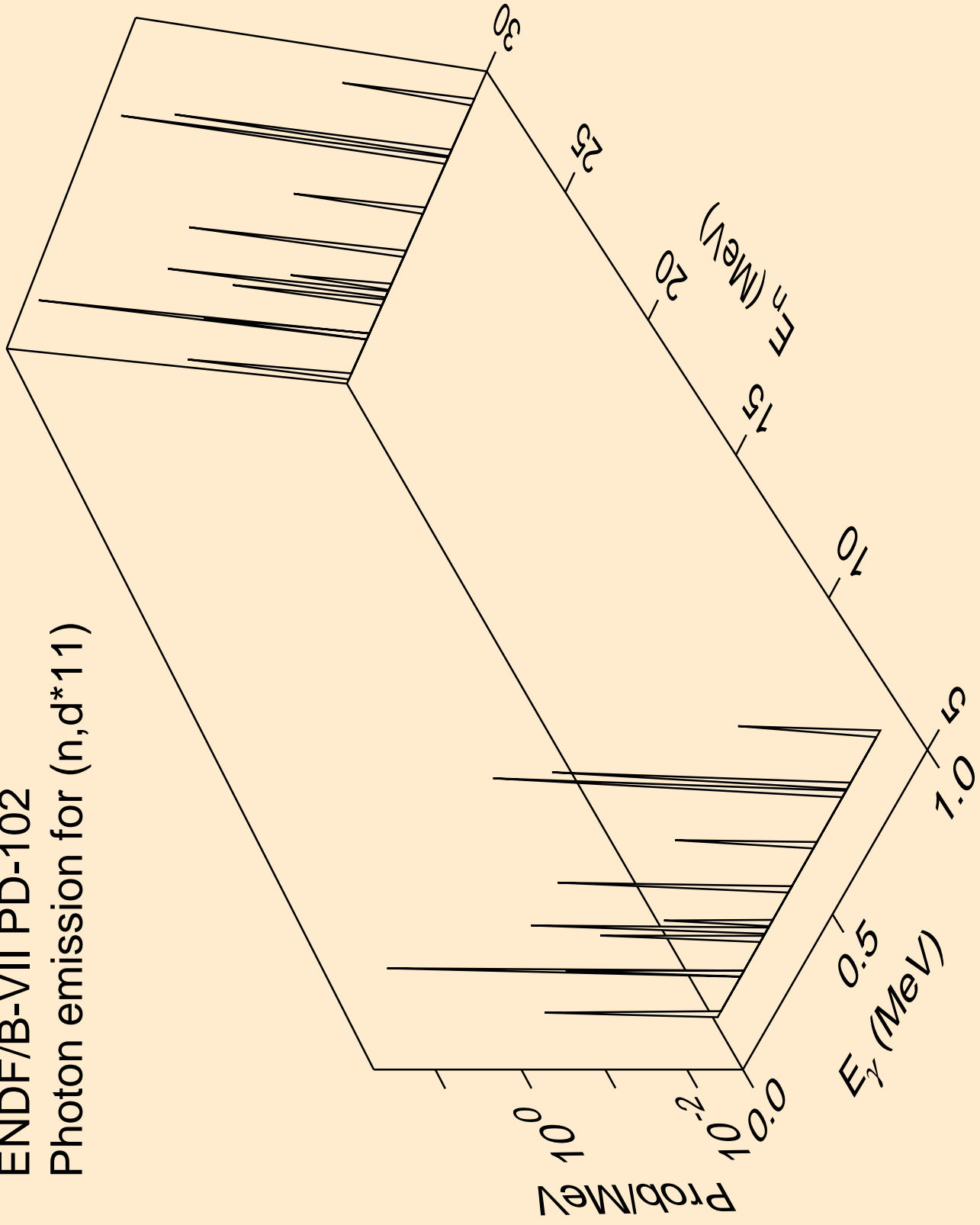

ENDF/B-VII PD-102
Photon emission for (n,d*12)

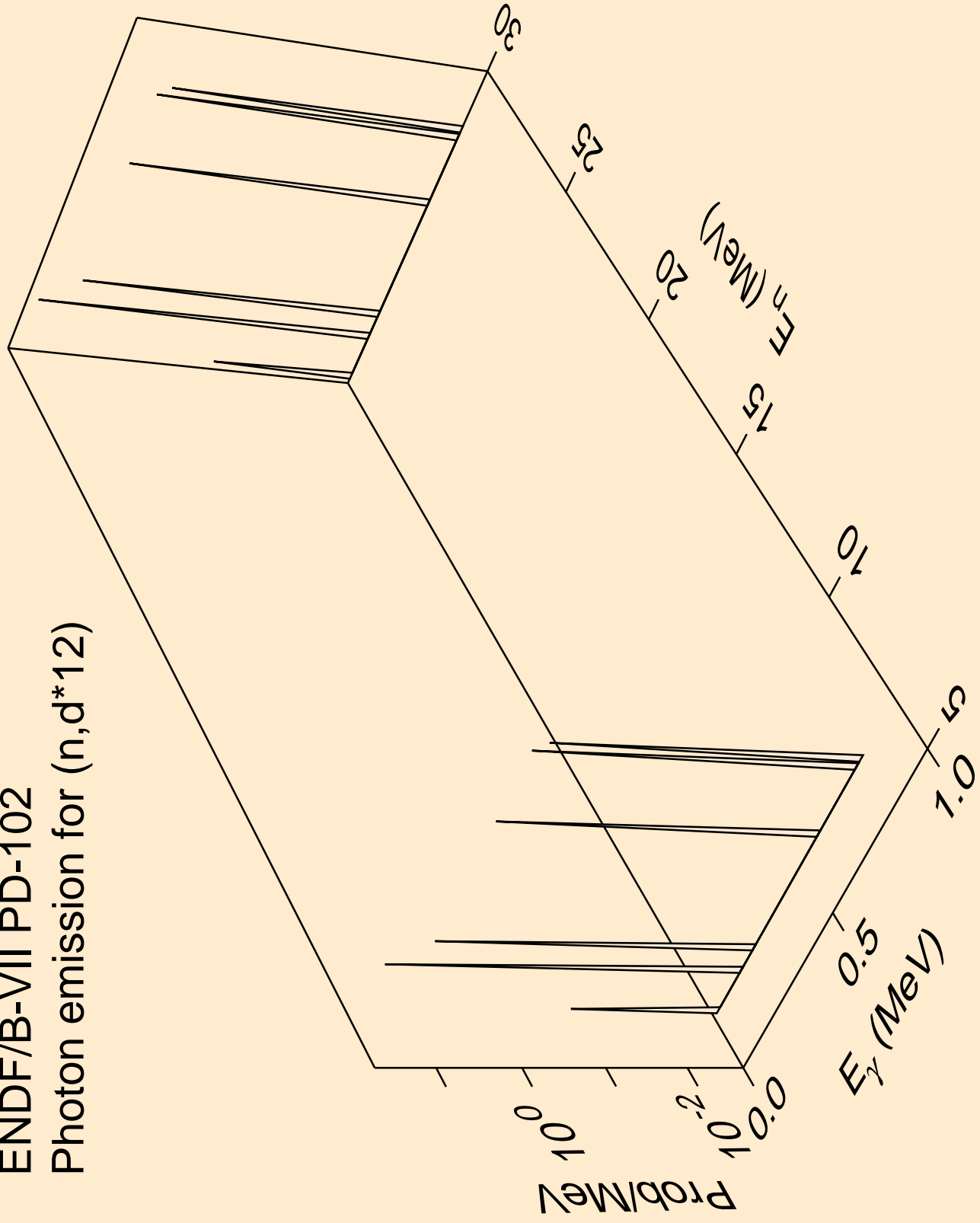

ENDF/B-VII PD-102
Photon emission for (n,d*13)

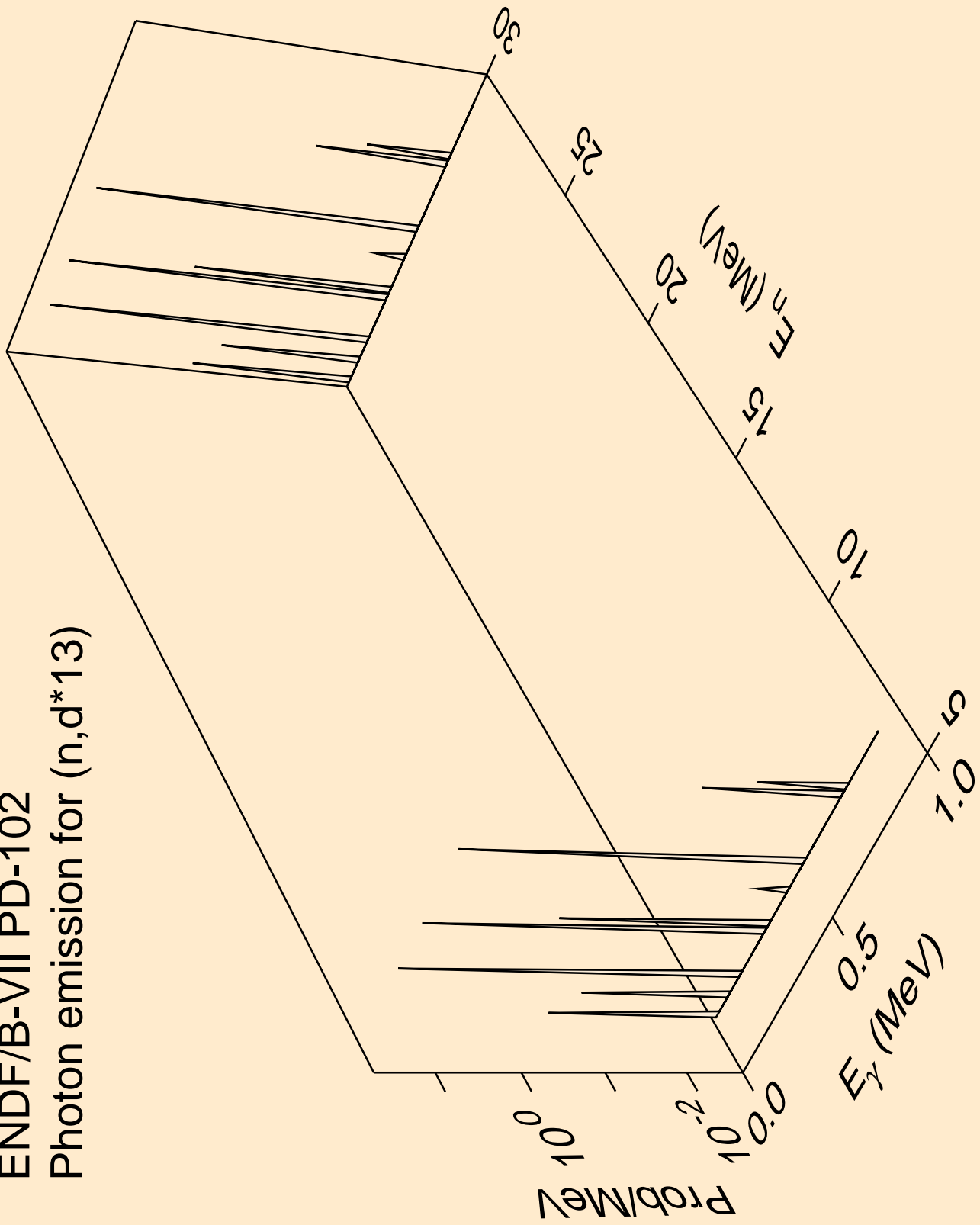

ENDF/B-VII PD-102
Photon emission for (n,d*14)

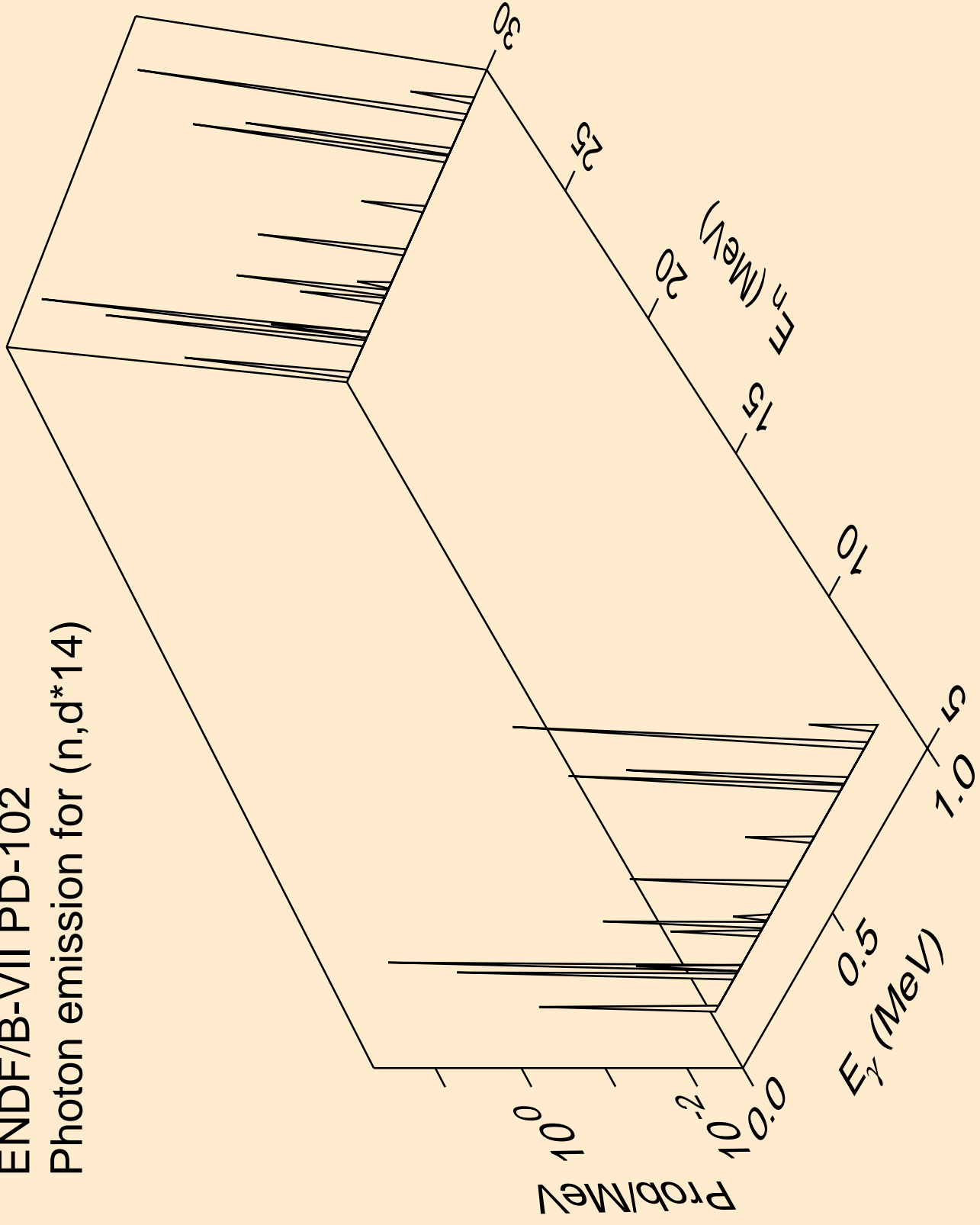

ENDF/B-VII PD-102
Photon emission for (n,d*15)

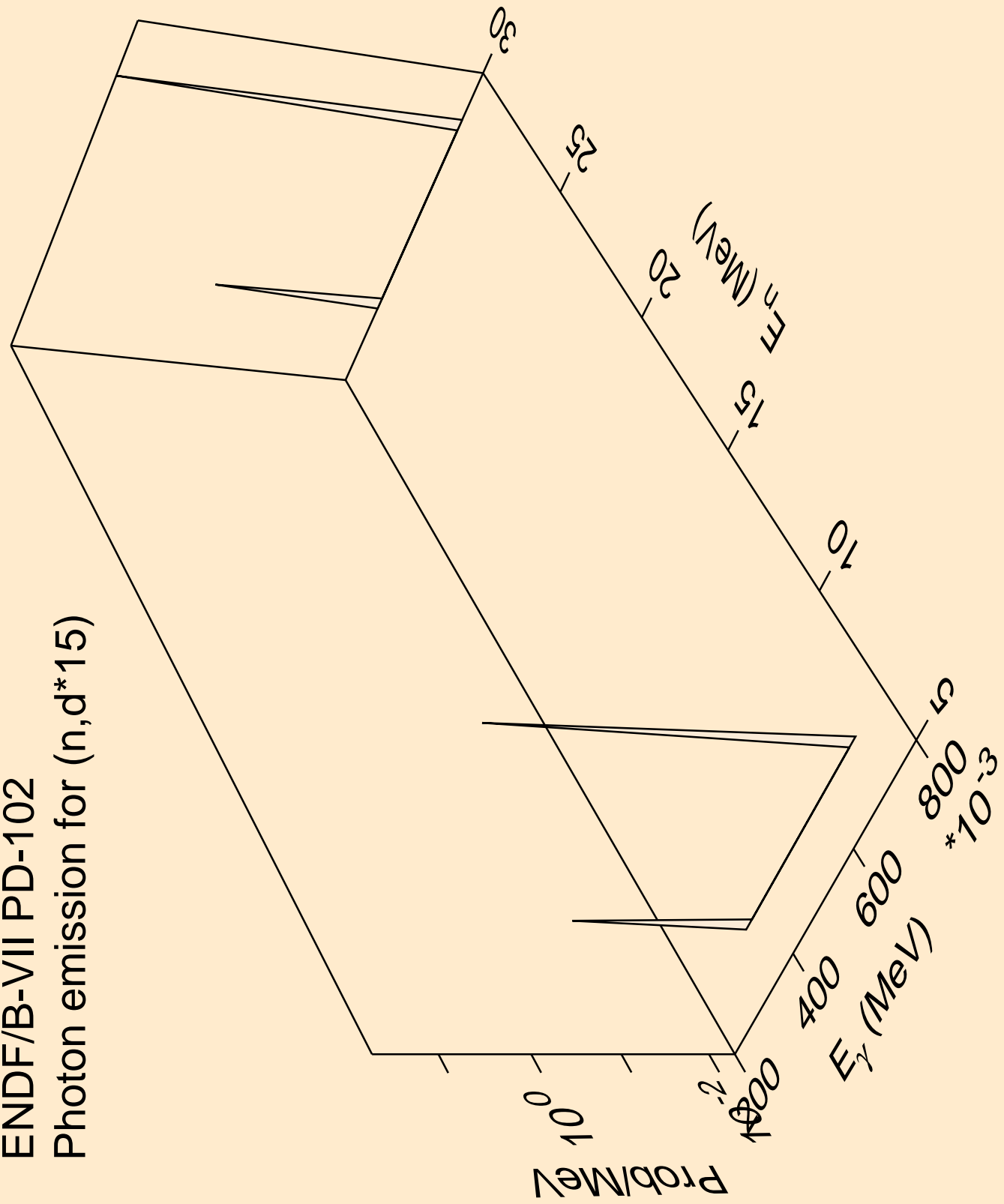

ENDF/B-VII PD-102
Photon emission for (n,d*16)

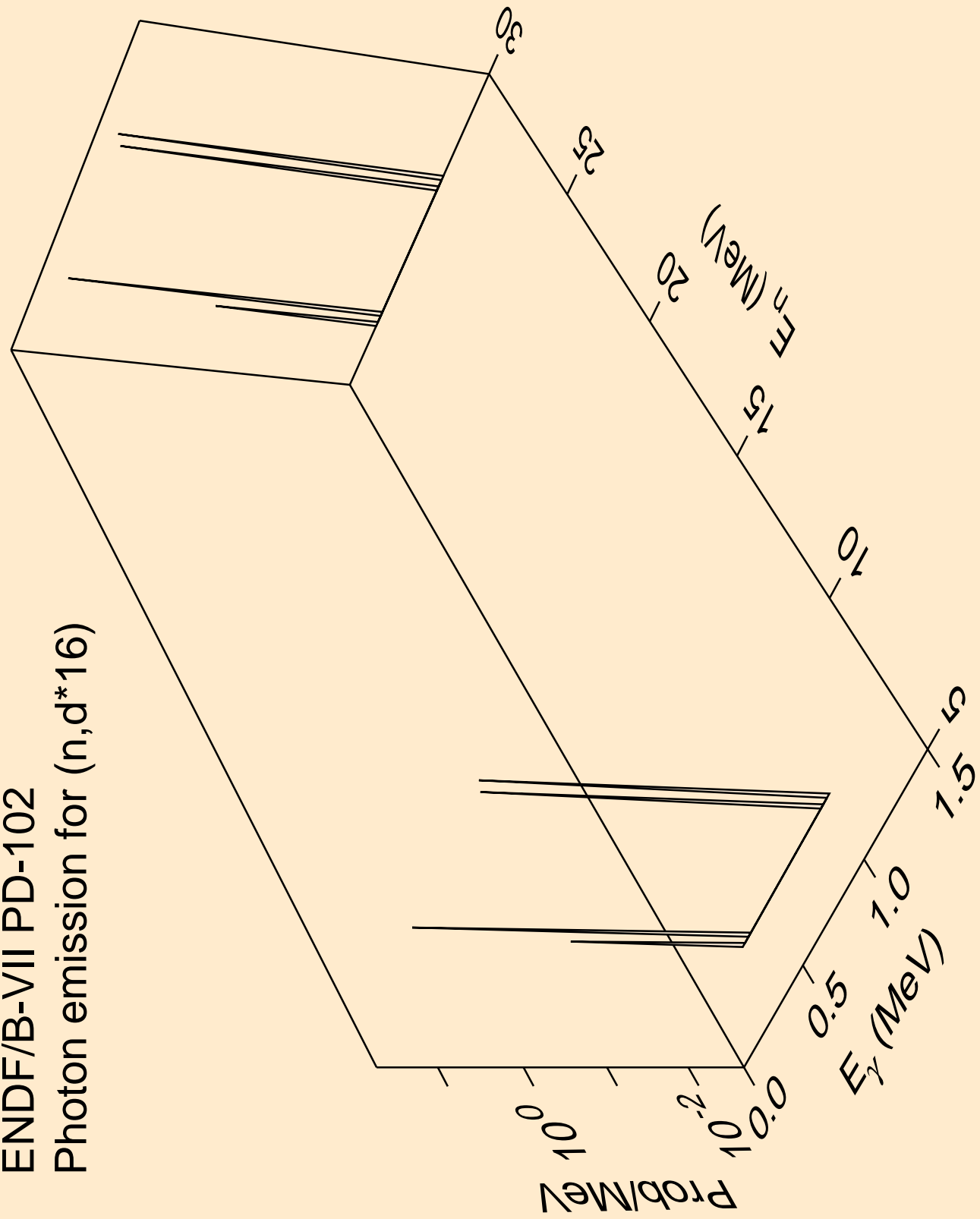

ENDF/B-VII PD-102
Photon emission for (n,d*17)

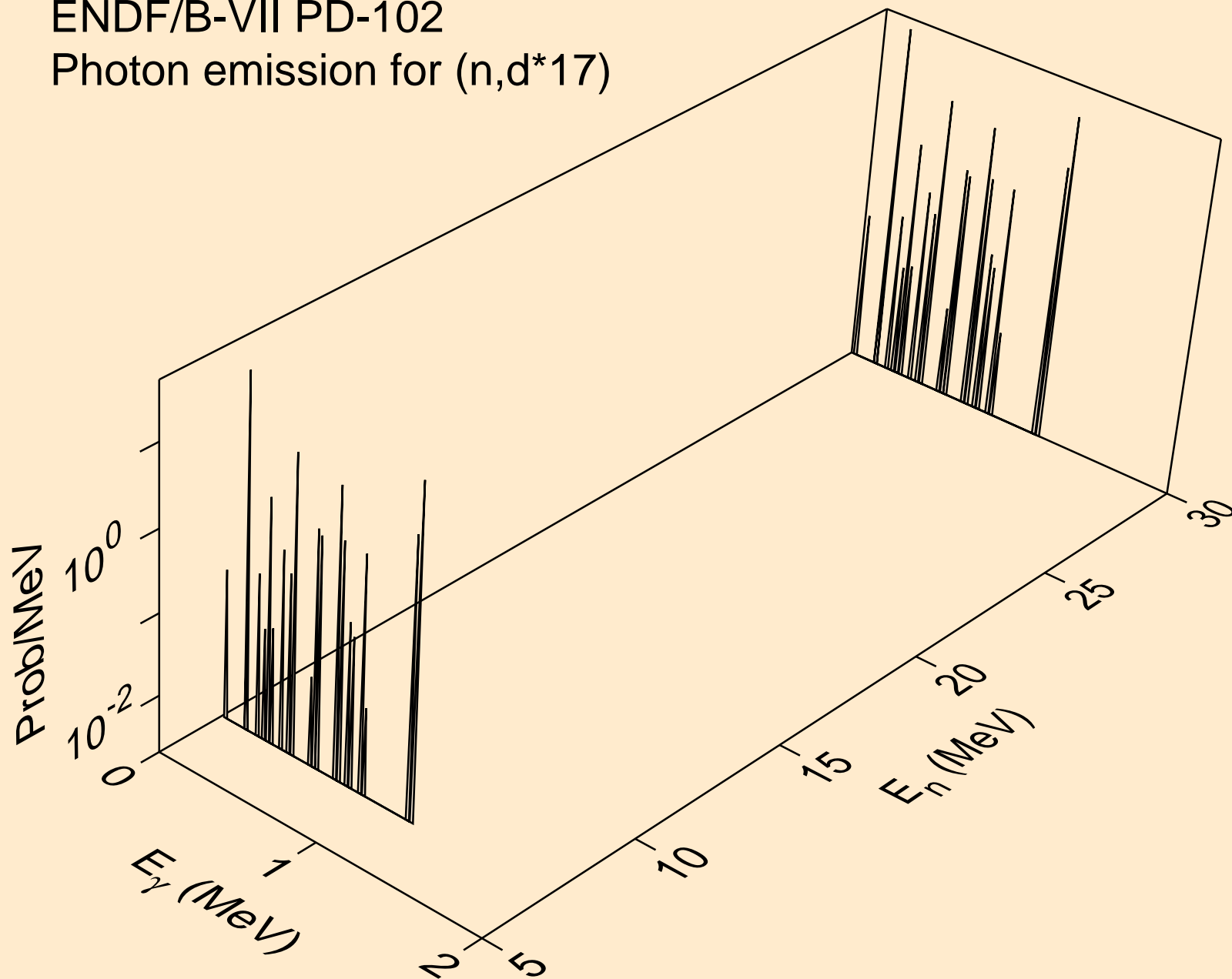

ENDF/B-VII PD-102
Photon emission for (n,d*18)

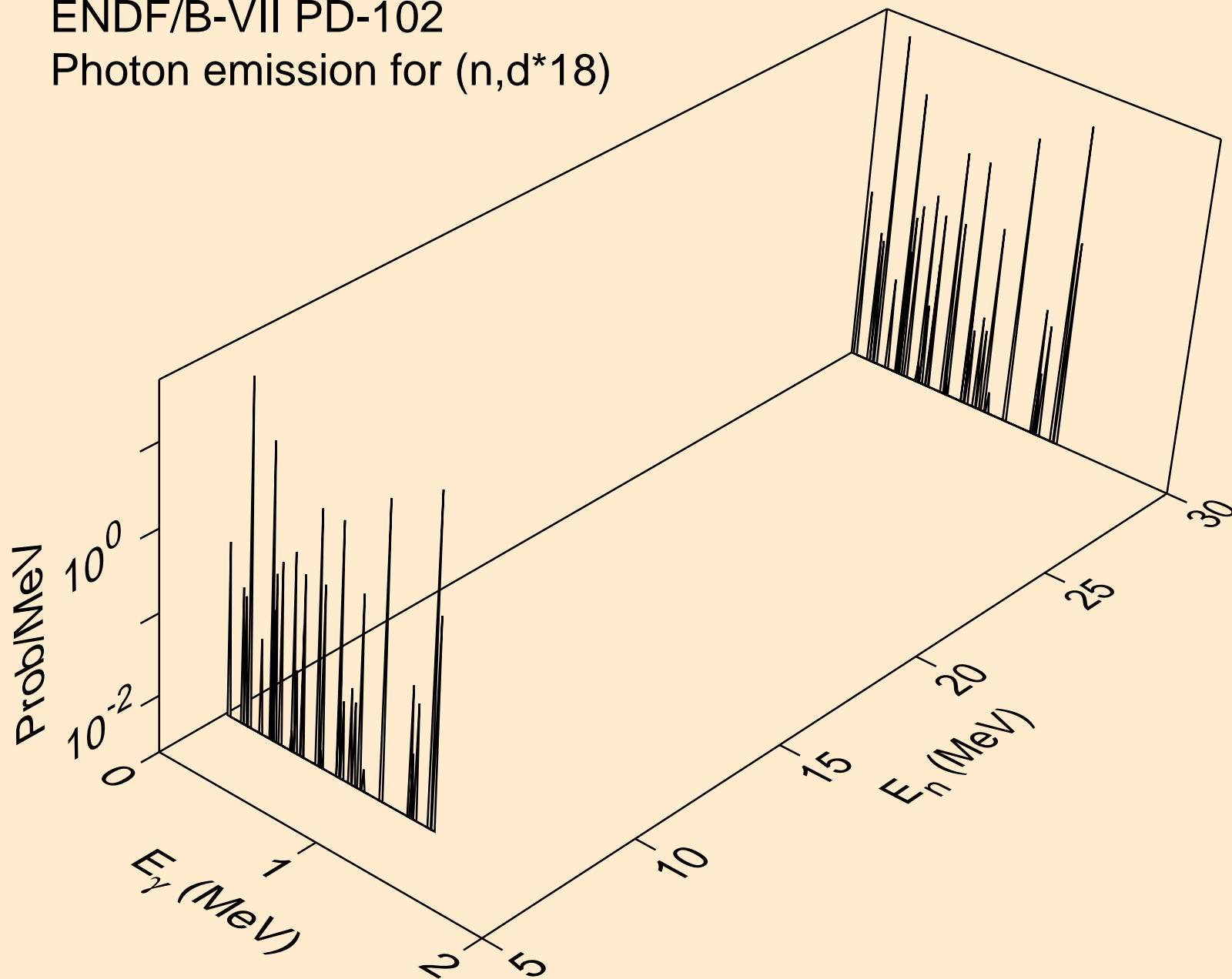

ENDF/B-VII PD-102
Photon emission for (n,d*19)

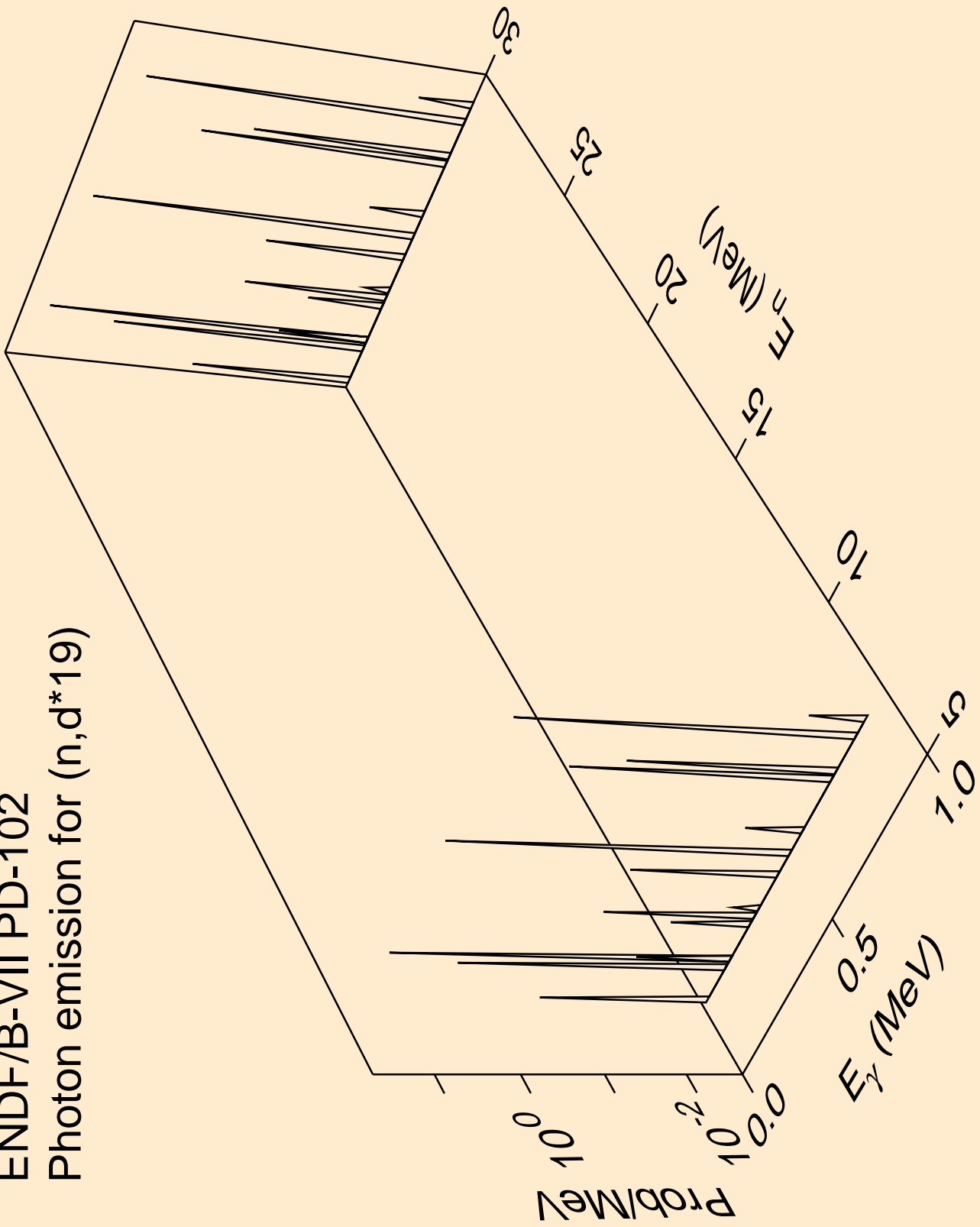

ENDF/B-VII PD-102
Photon emission for (n,d*c)

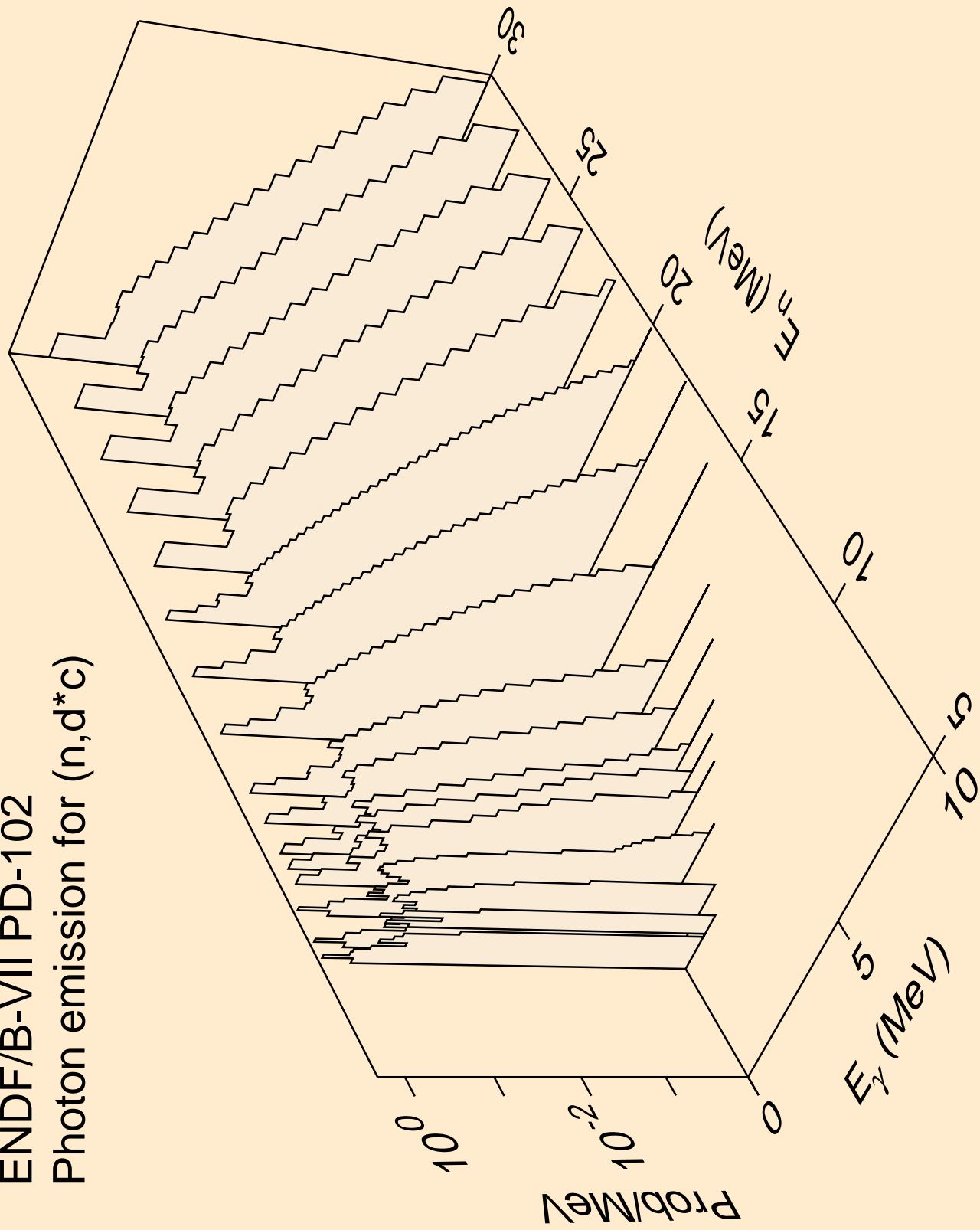

ENDF/B-VII PD-102
Photon emission for (n,a*1)

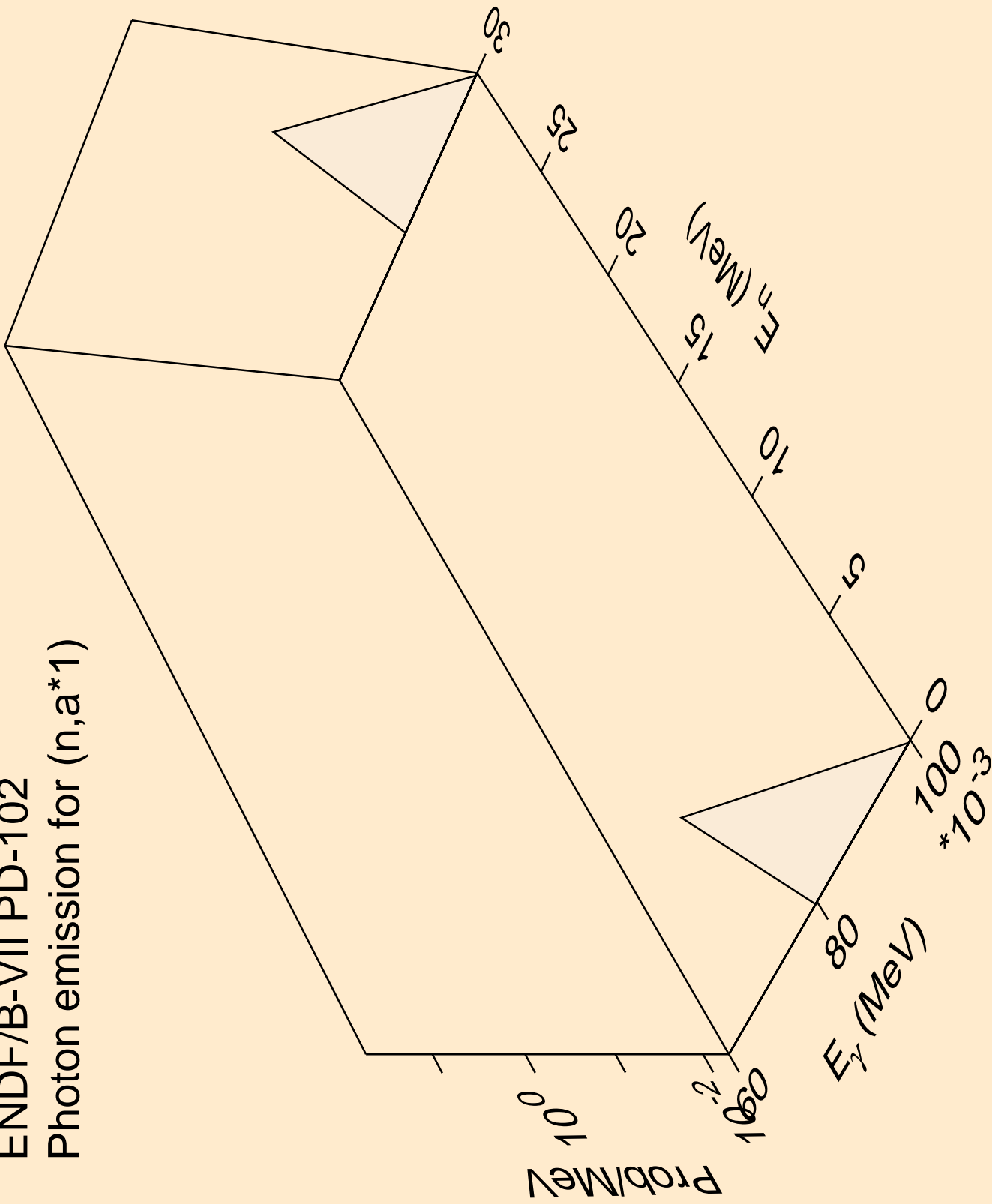

ENDF/B-VII PD-102
Photon emission for (n,a*2)

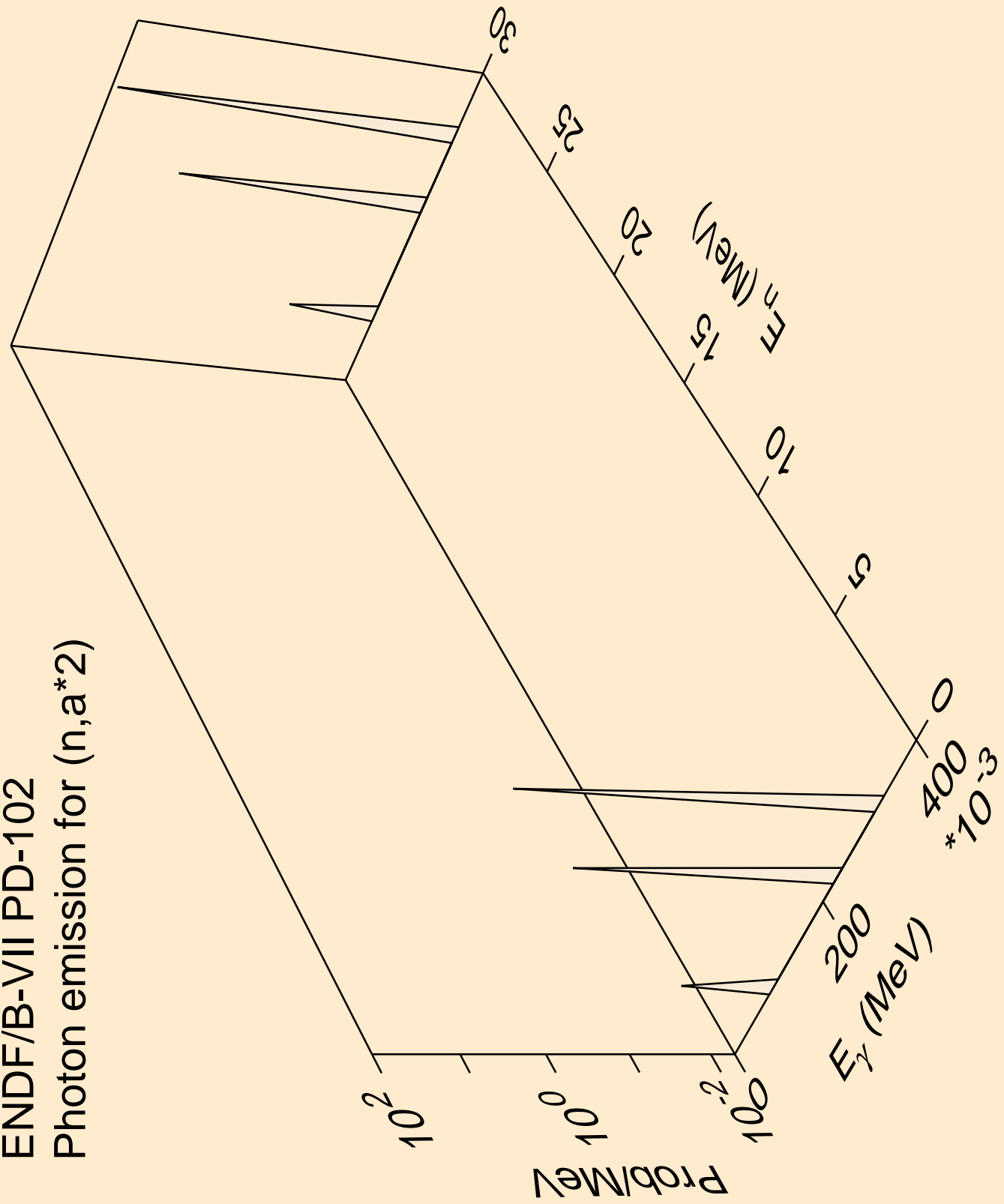

ENDF/B-VII PD-102
Photon emission for (n,a*3)

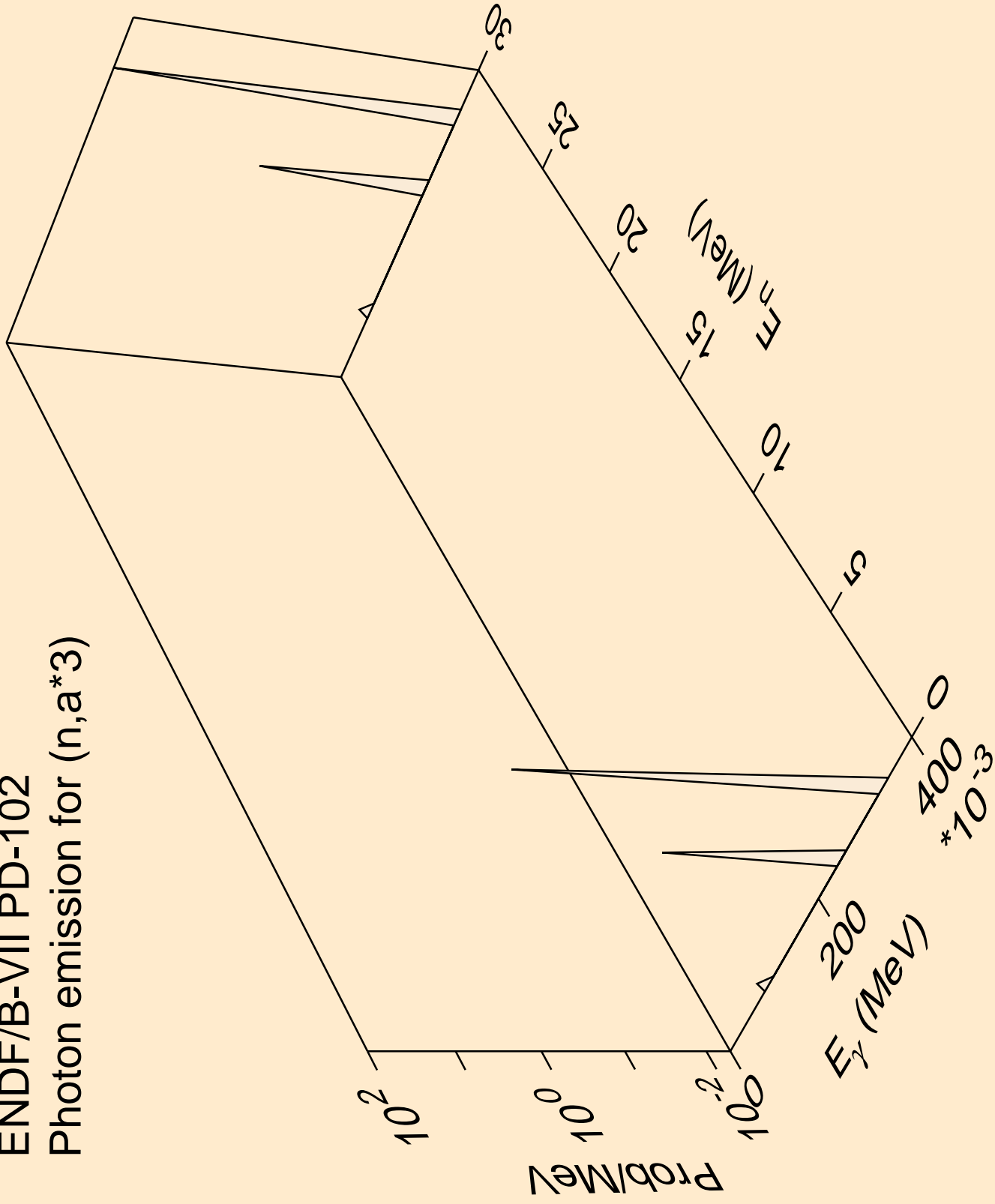

ENDF/B-VII PD-102
Photon emission for (n,a*4)

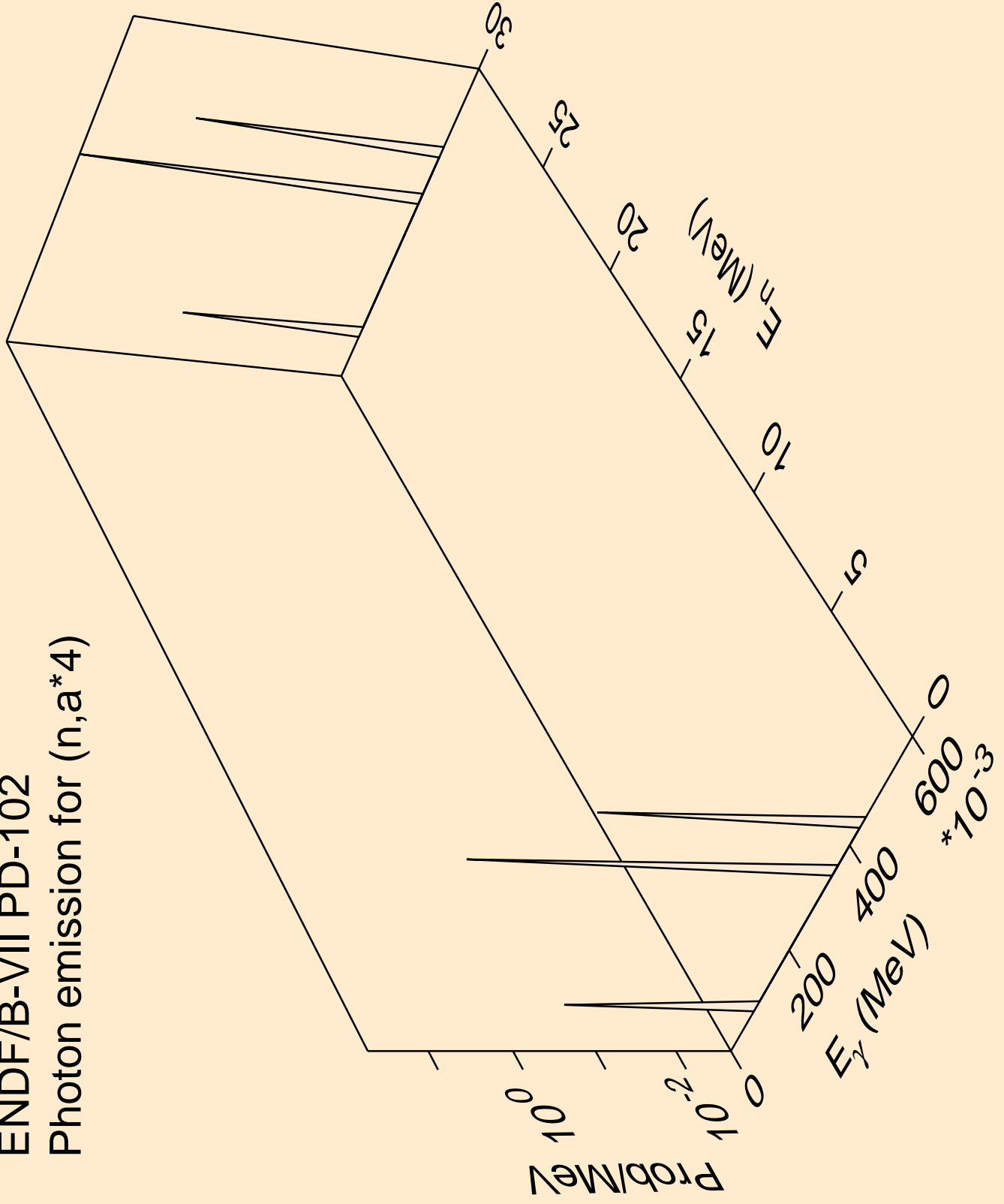

ENDF/B-VII PD-102
Photon emission for (n,a*5)

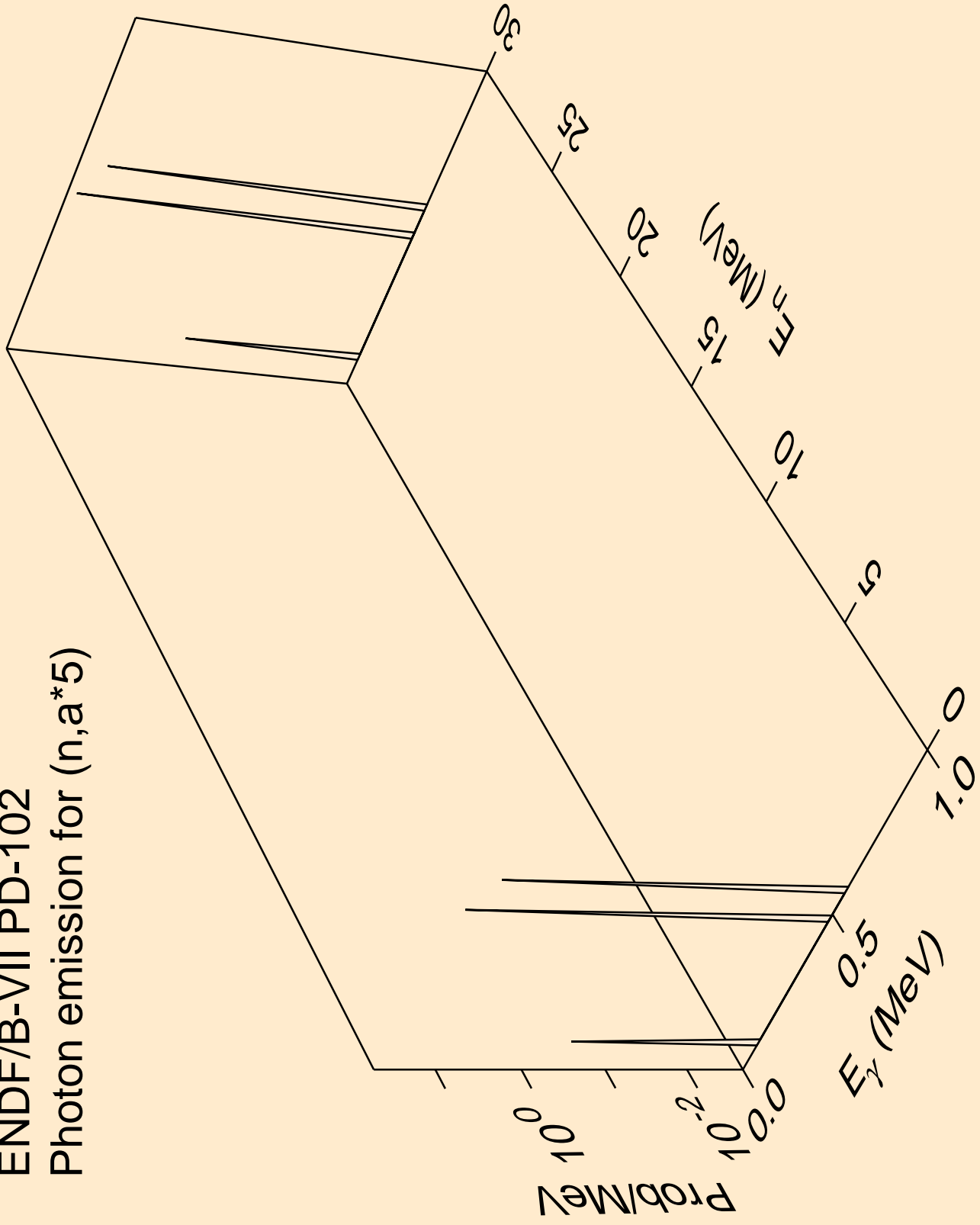

ENDF/B-VII PD-102
Photon emission for (n,a*6)

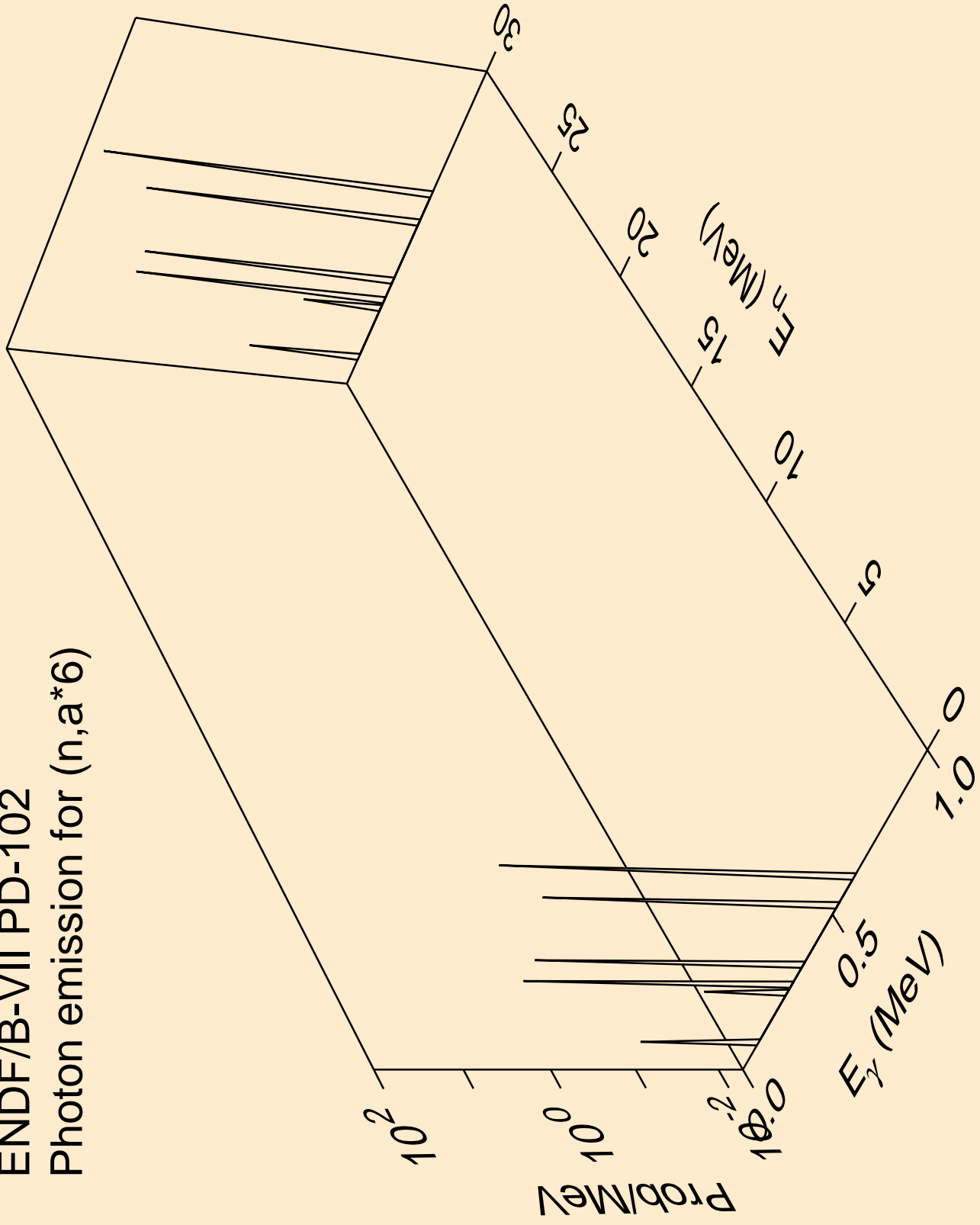

ENDF/B-VII PD-102
Photon emission for (n,a*7)

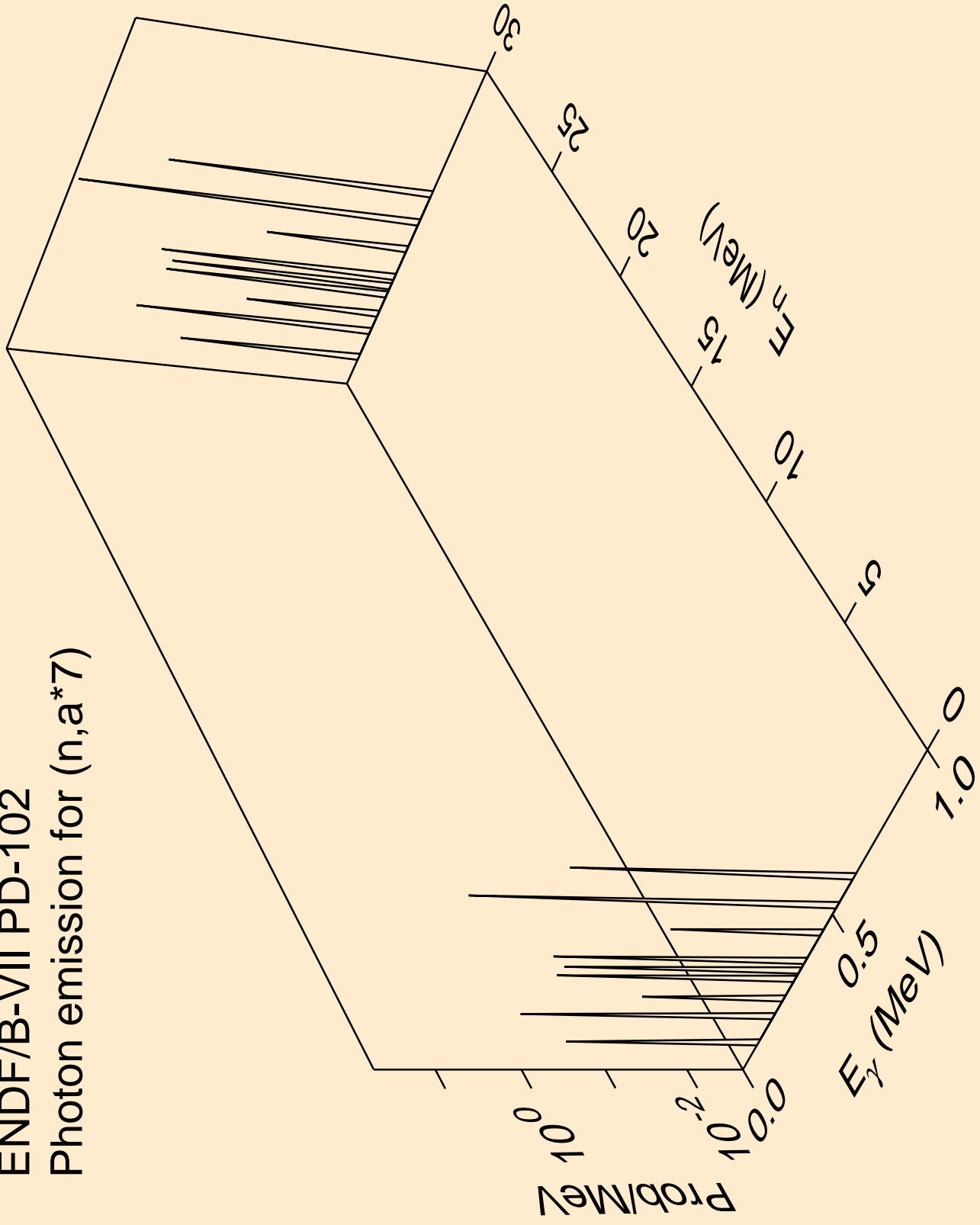

ENDF/B-VII PD-102
Photon emission for (n,a*8)

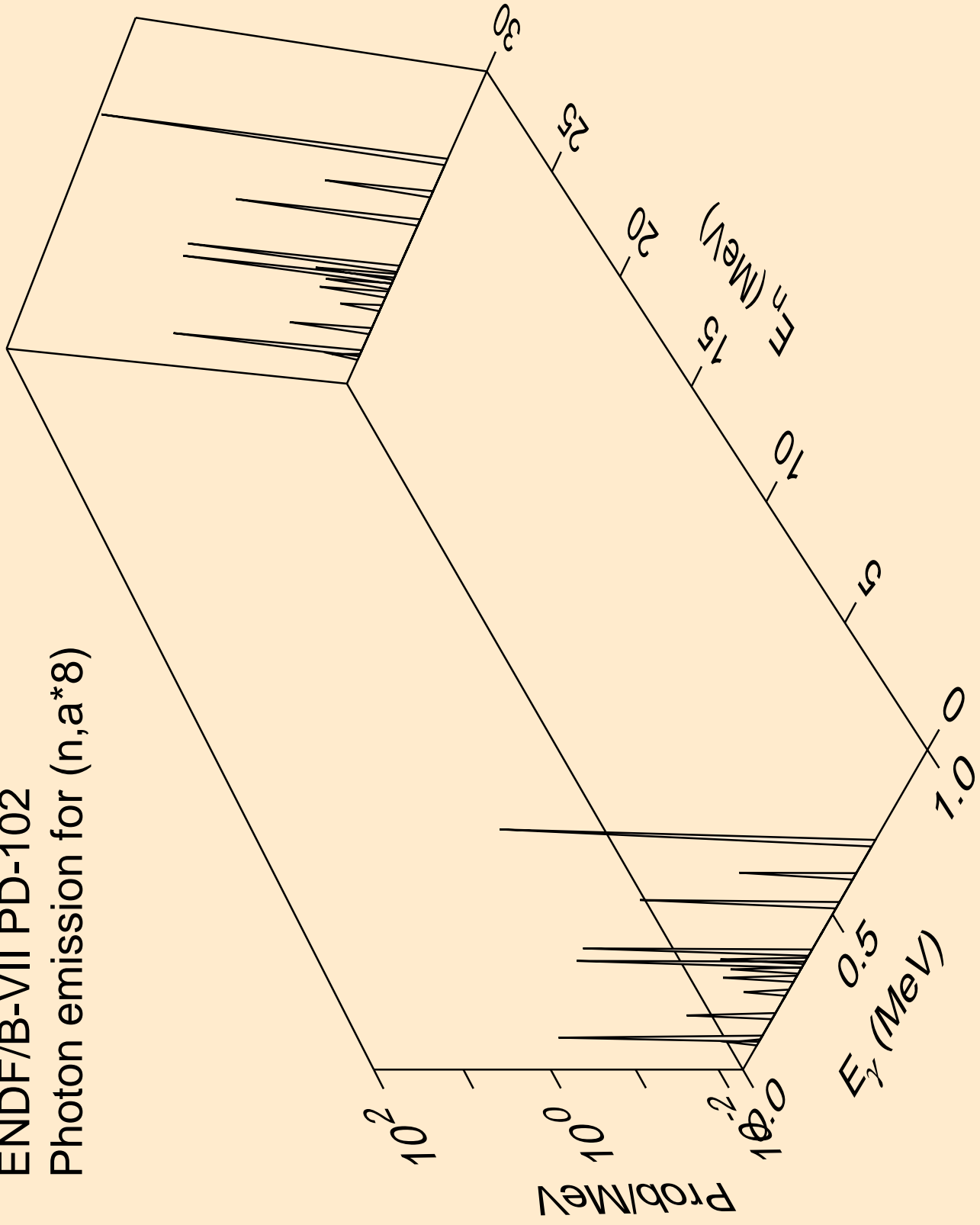

ENDF/B-VII PD-102
Photon emission for (n,a*9)

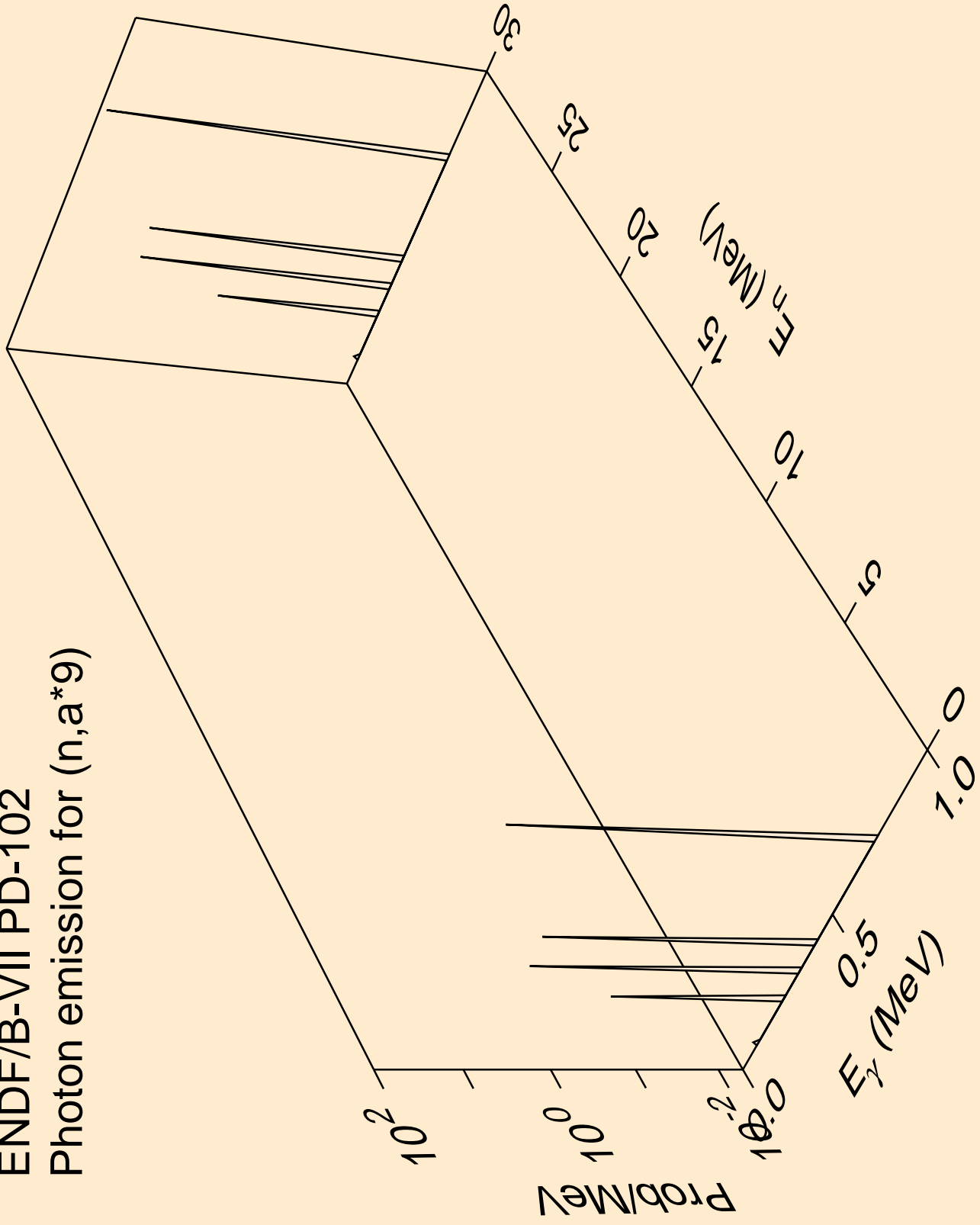

ENDF/B-VII PD-102
Photon emission for (n,a*10)

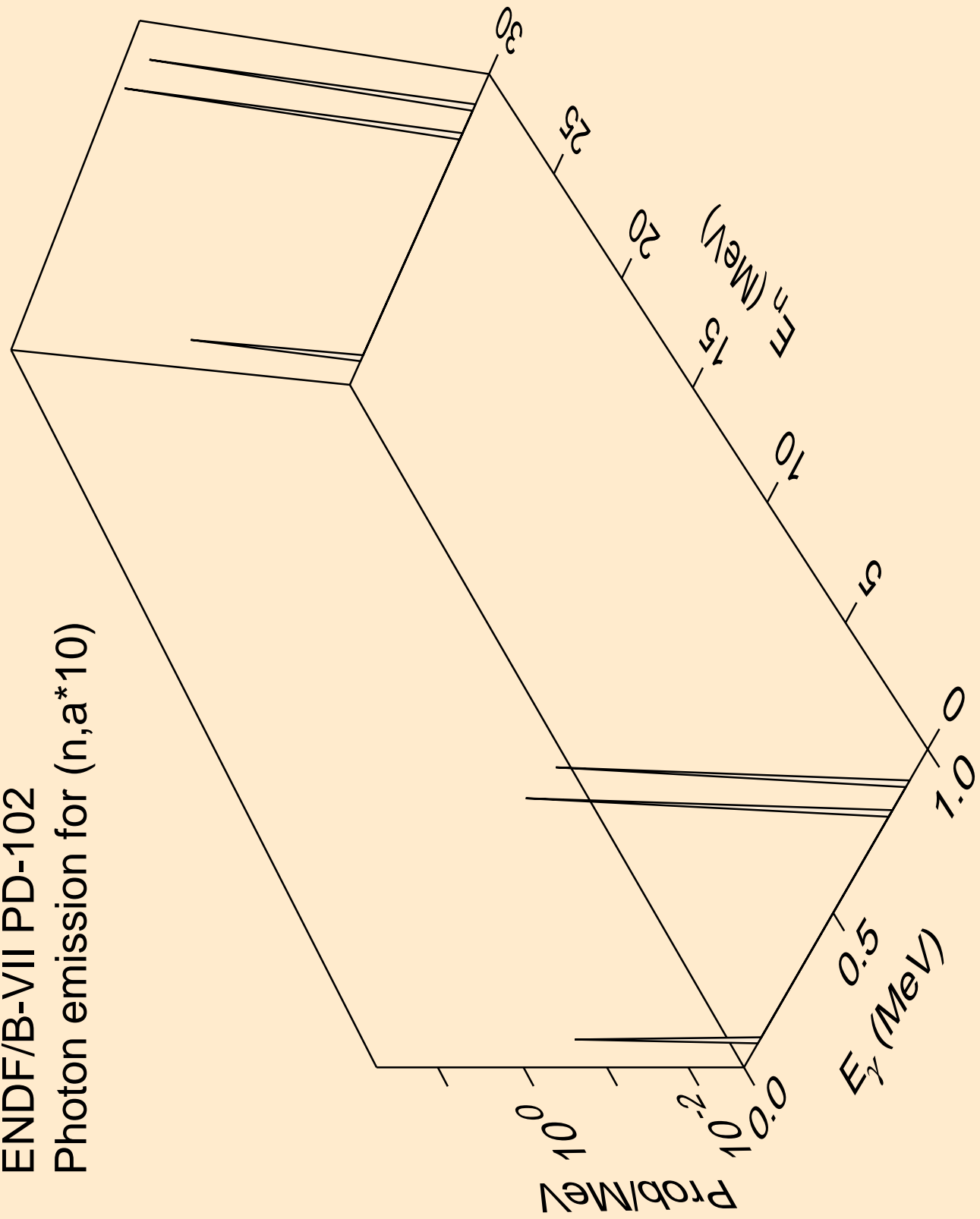

ENDF/B-VII PD-102
Photon emission for (n,a*11)

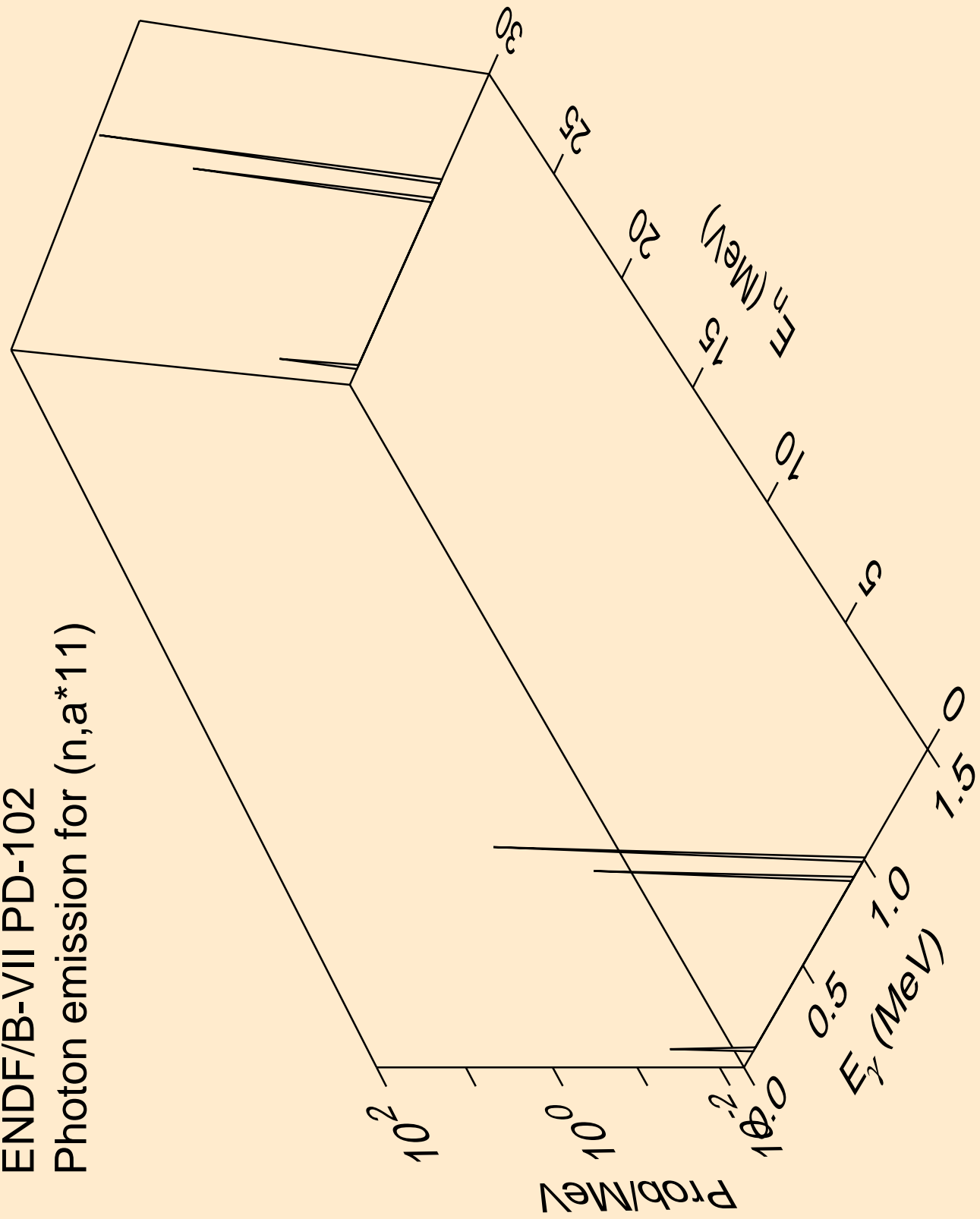

ENDF/B-VII PD-102
Photon emission for (n,a*12)

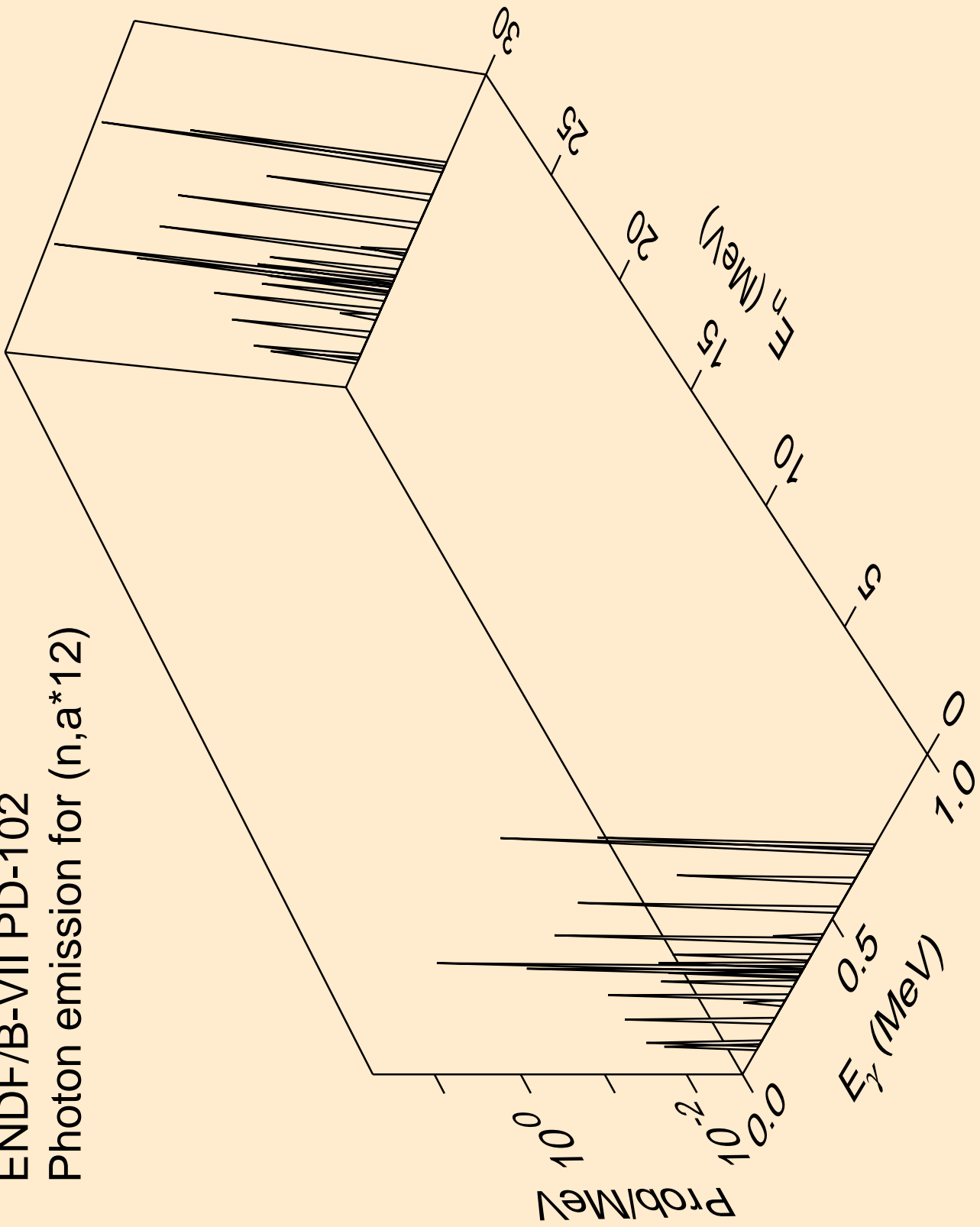

ENDF/B-VII PD-102
Photon emission for (n,a*13)

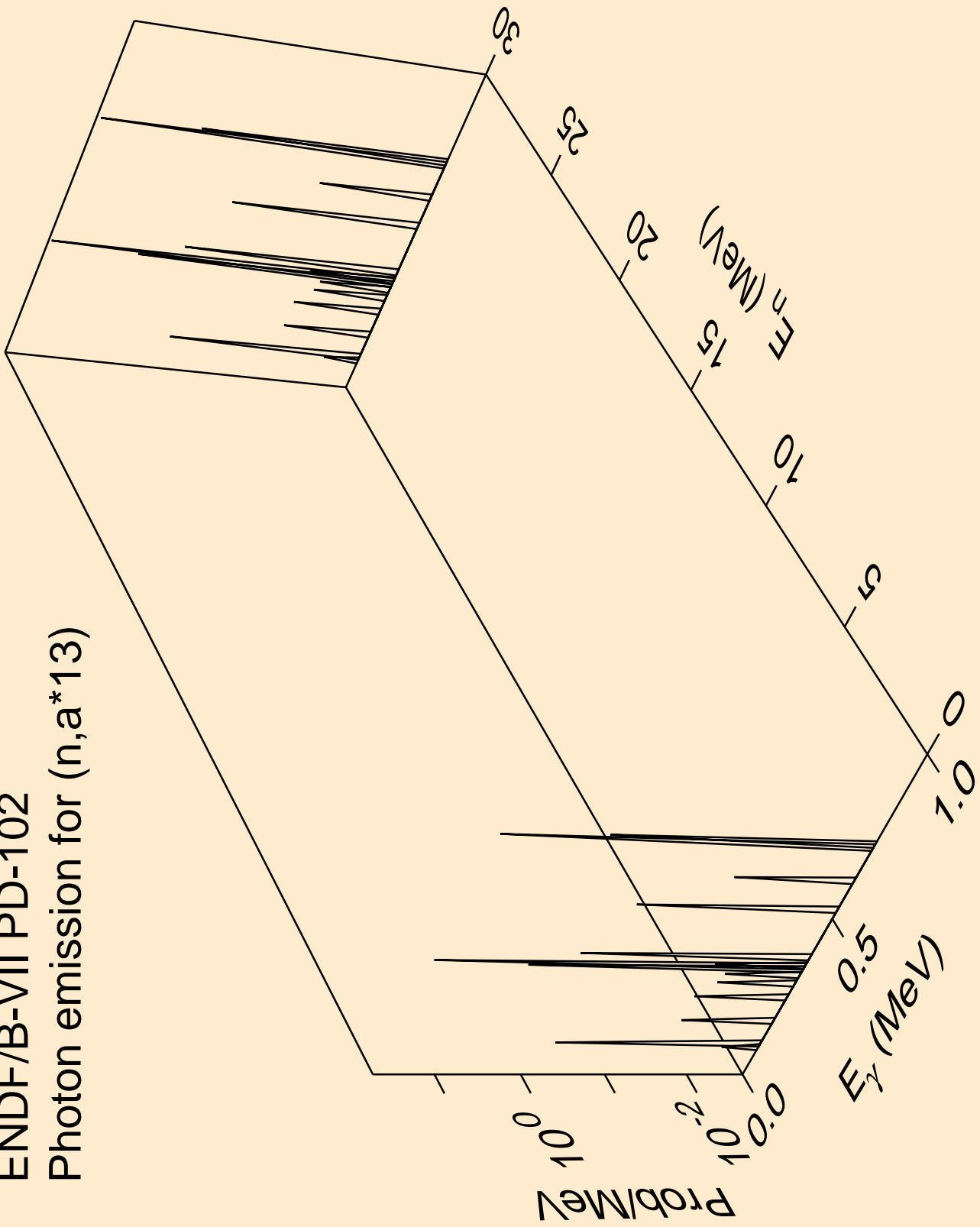

ENDF/B-VII PD-102
Photon emission for (n,a*14)

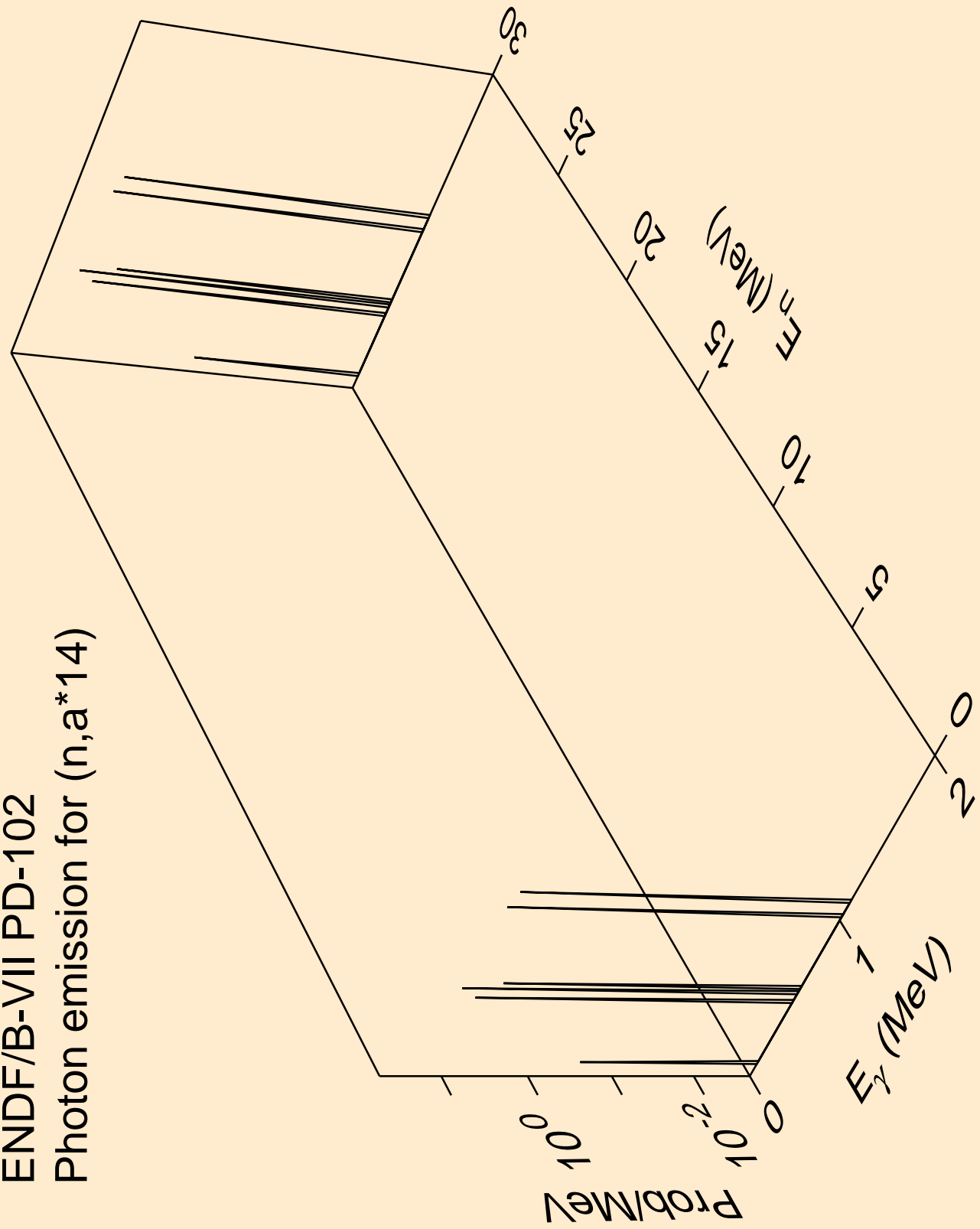

ENDF/B-VII PD-102
Photon emission for (n,a*15)

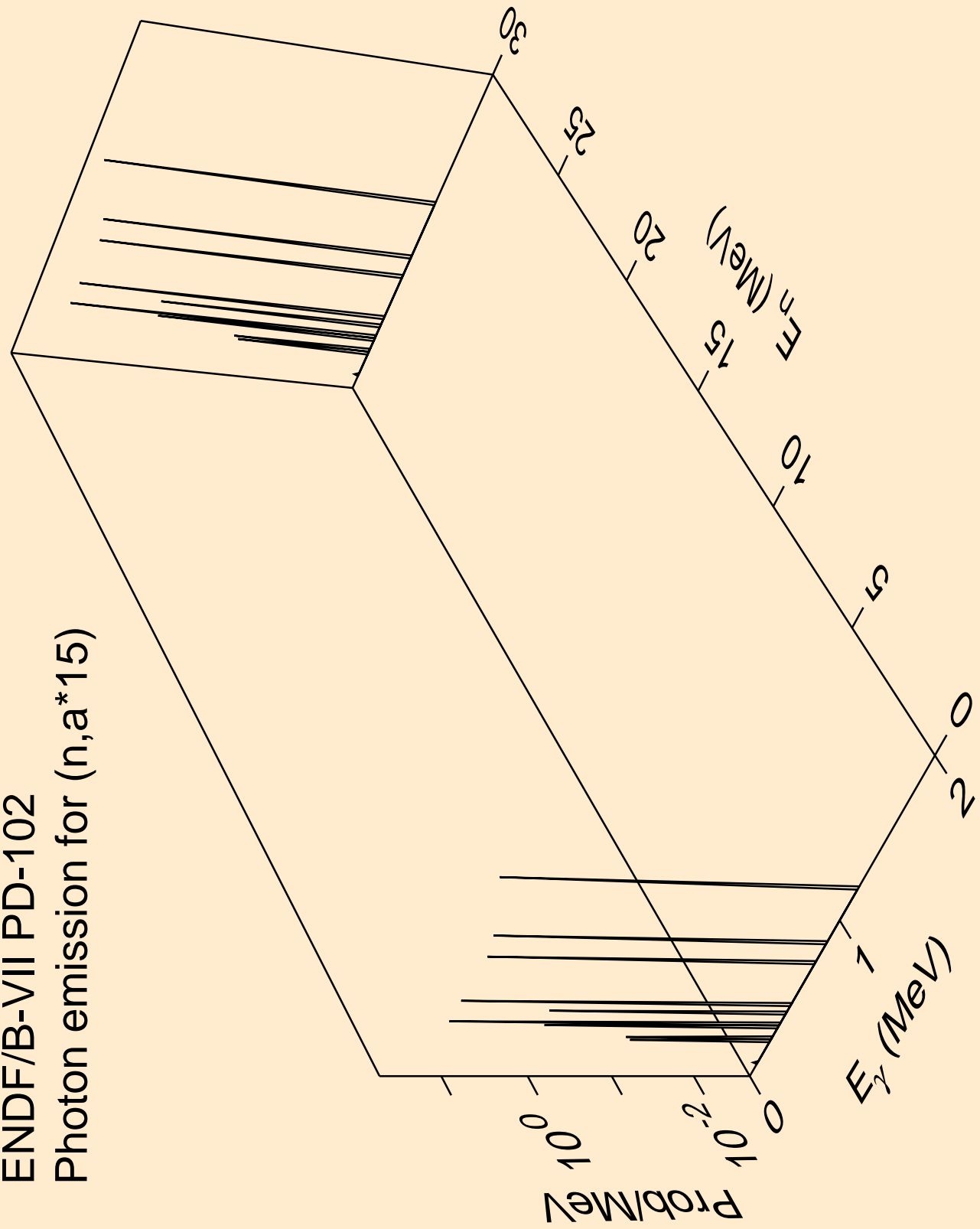

ENDF/B-VII PD-102
Photon emission for (n,a*16)

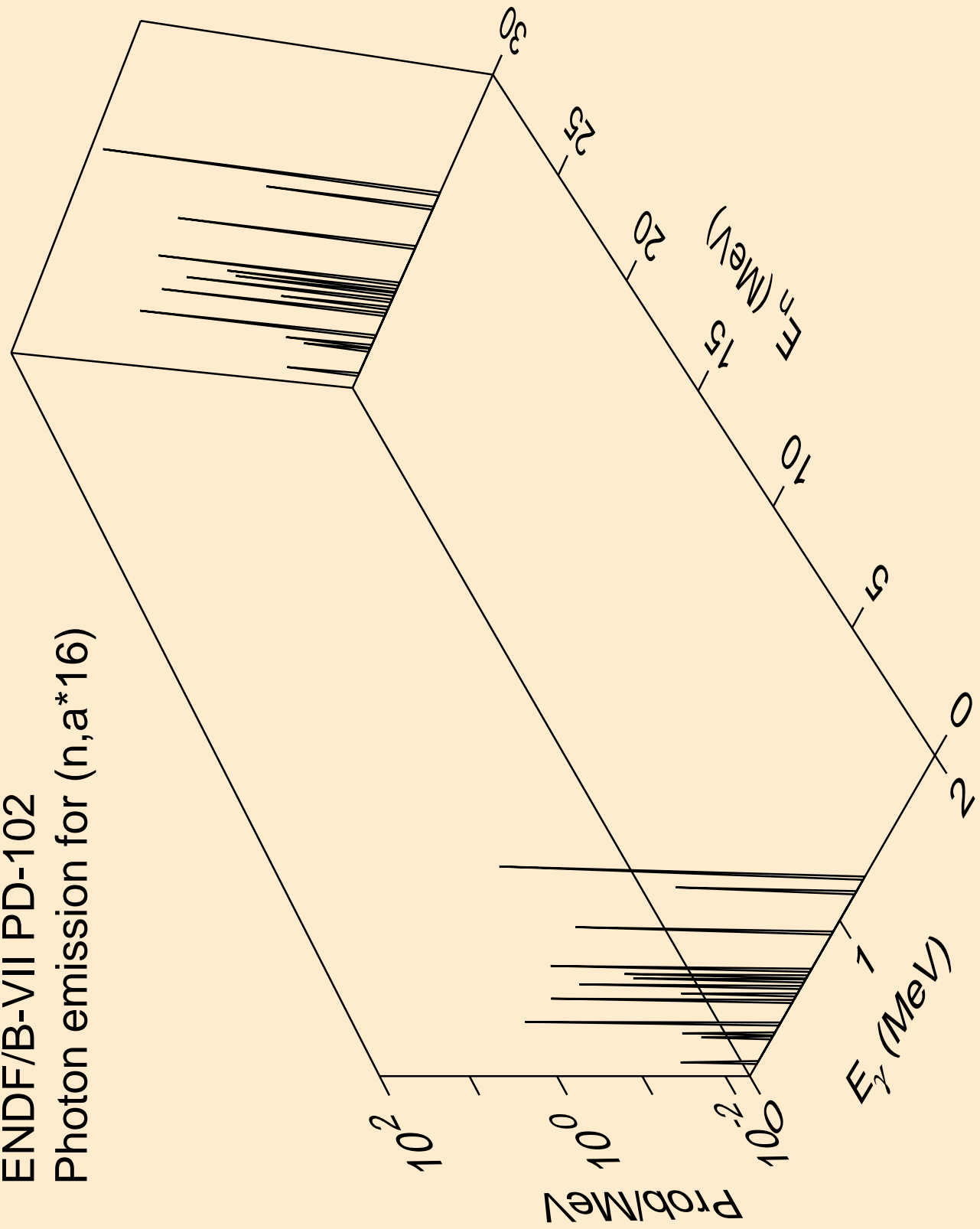

ENDF/B-VII PD-102
Photon emission for (n,a*17)

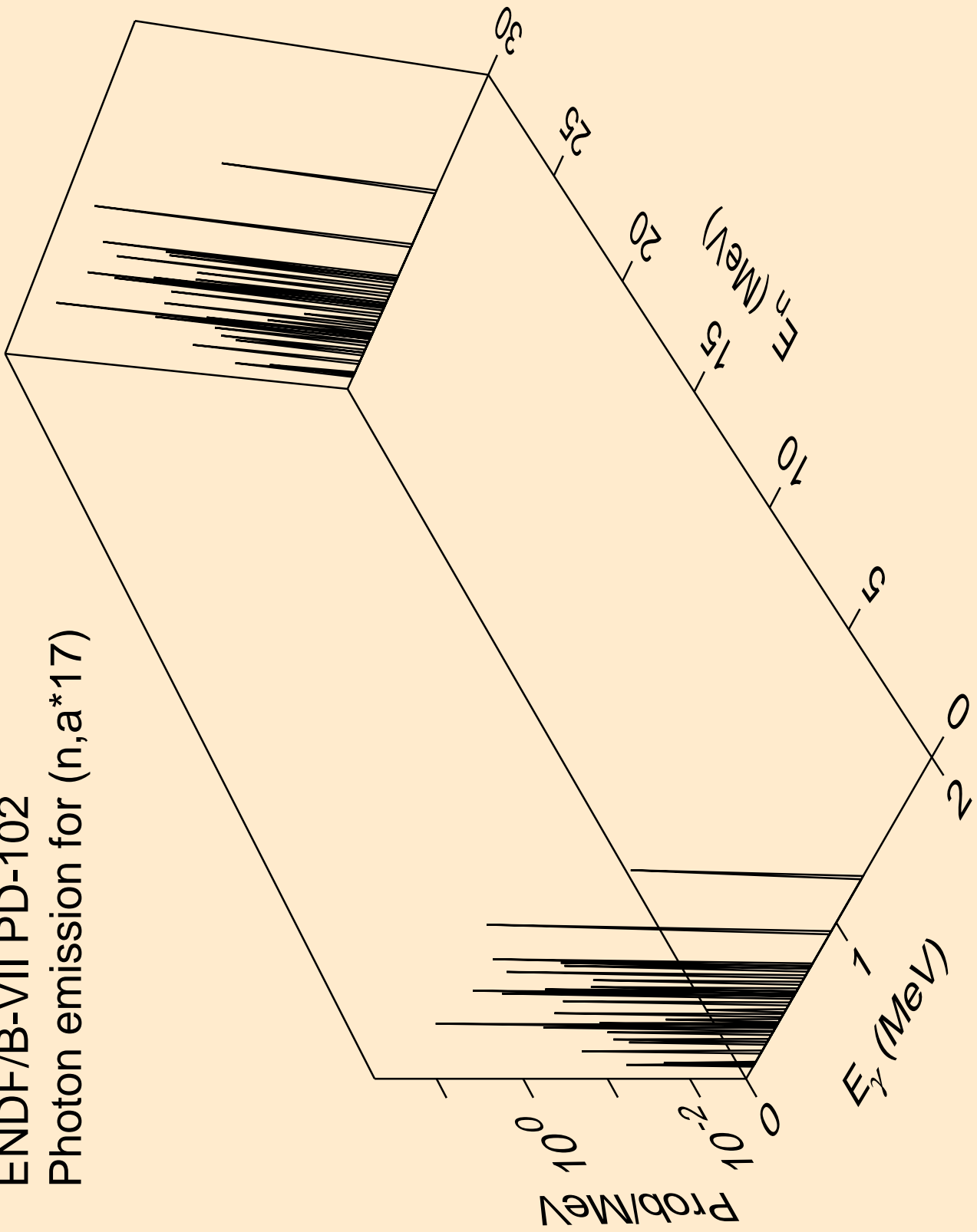

ENDF/B-VII PD-102
Photon emission for (n,a*18)

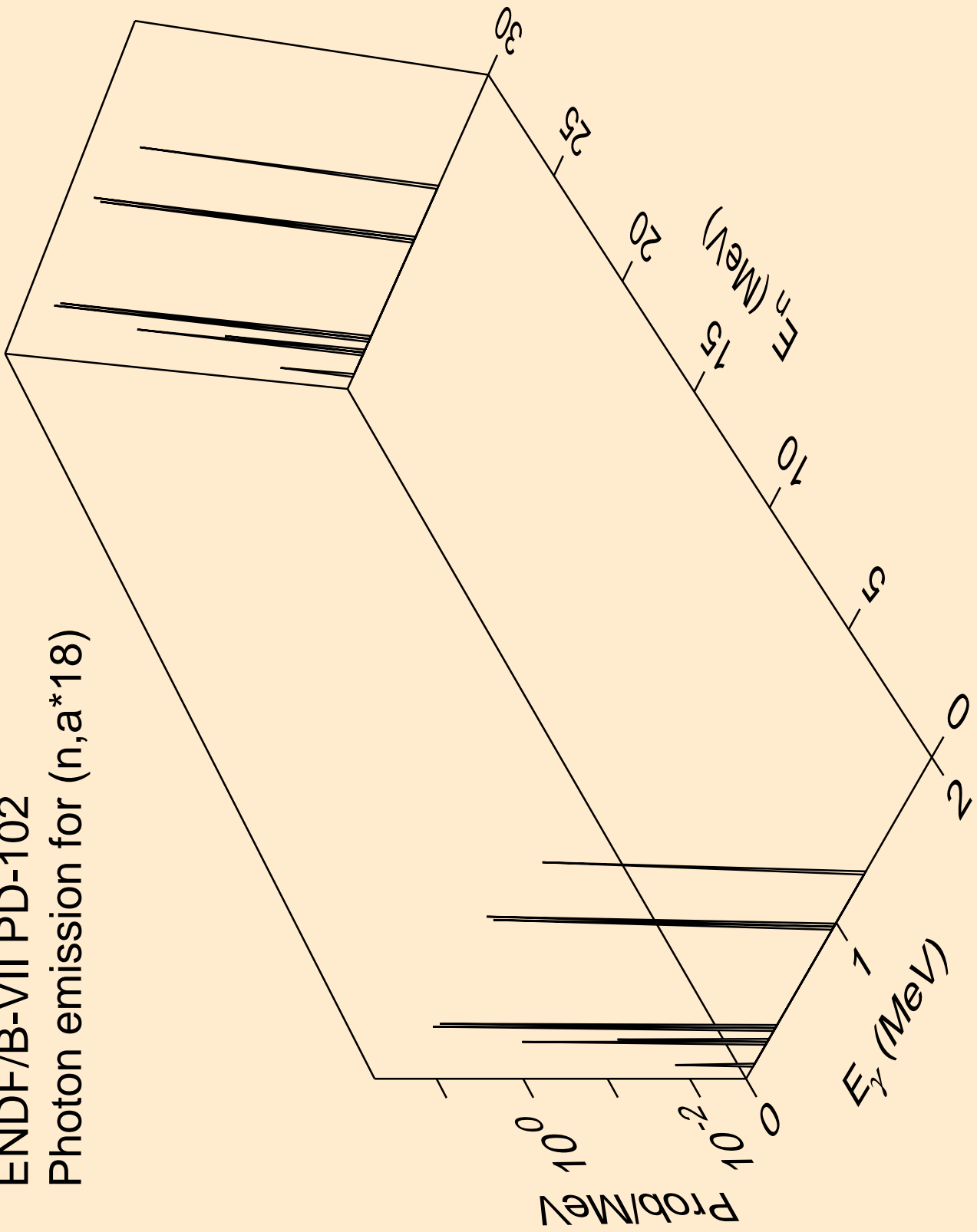

ENDF/B-VII PD-102
Photon emission for (n,a*19)

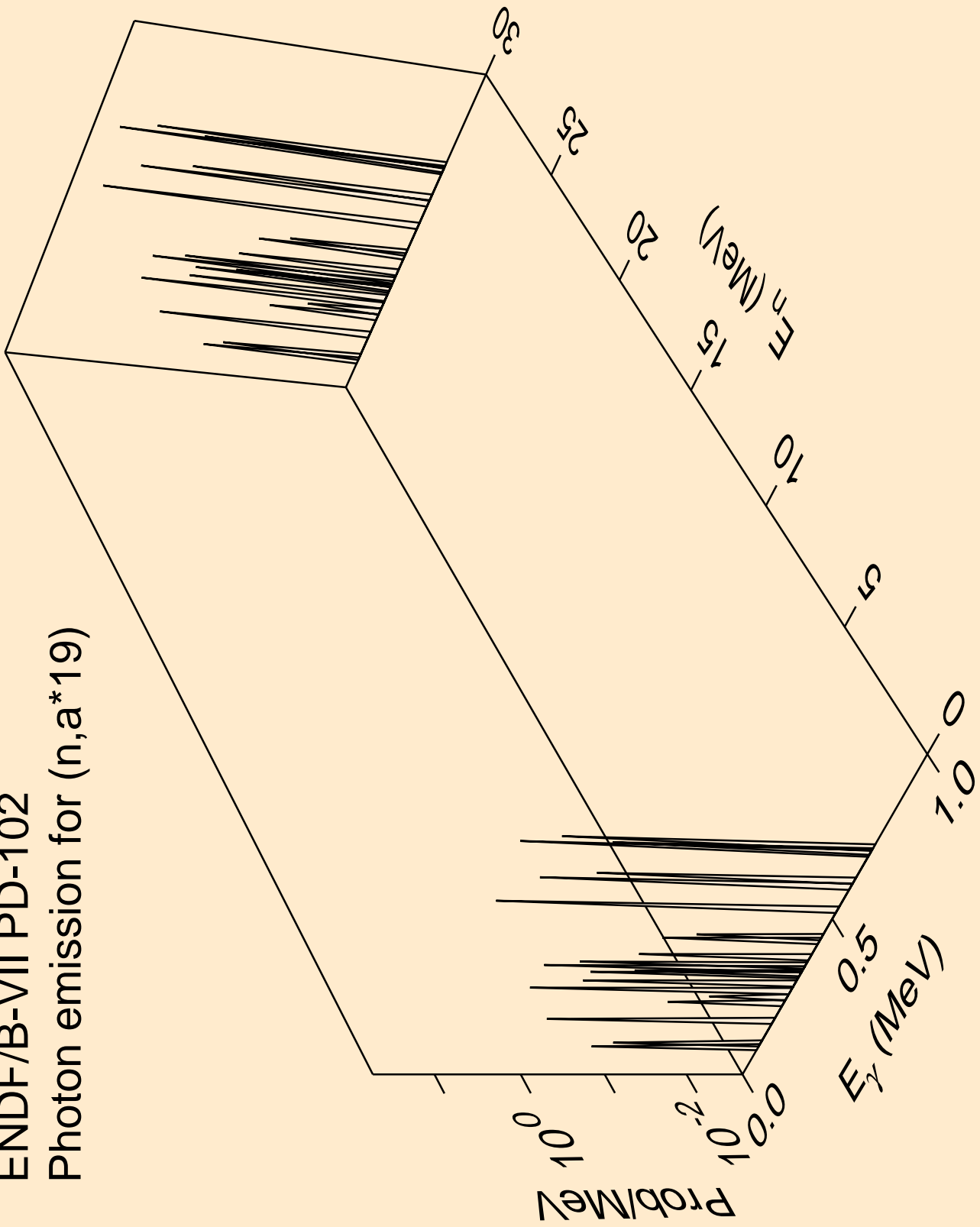

ENDF/B-VII PD-102
Photon emission for (n,a*20)

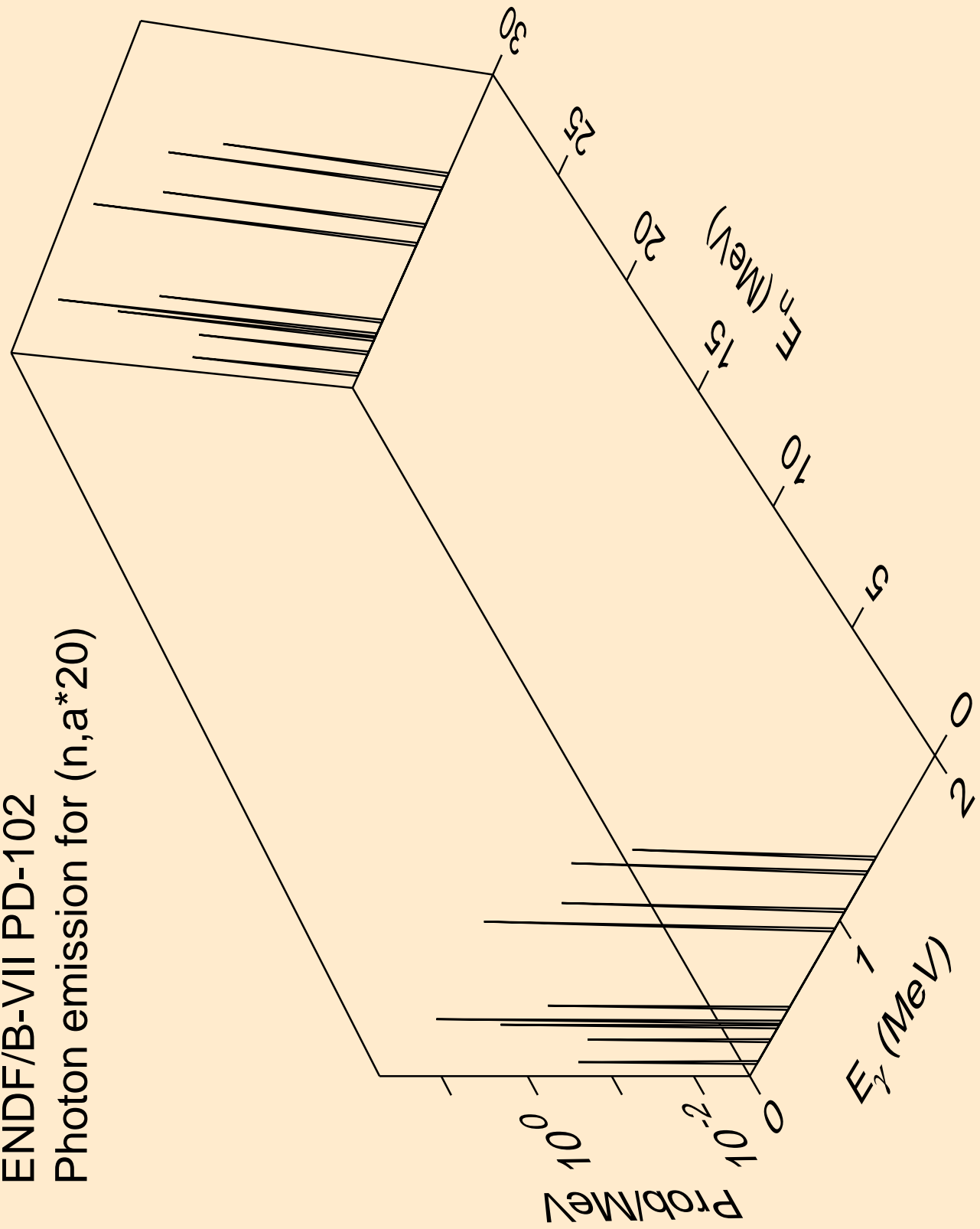

ENDF/B-VII PD-102
Photon emission for (n,a*21)

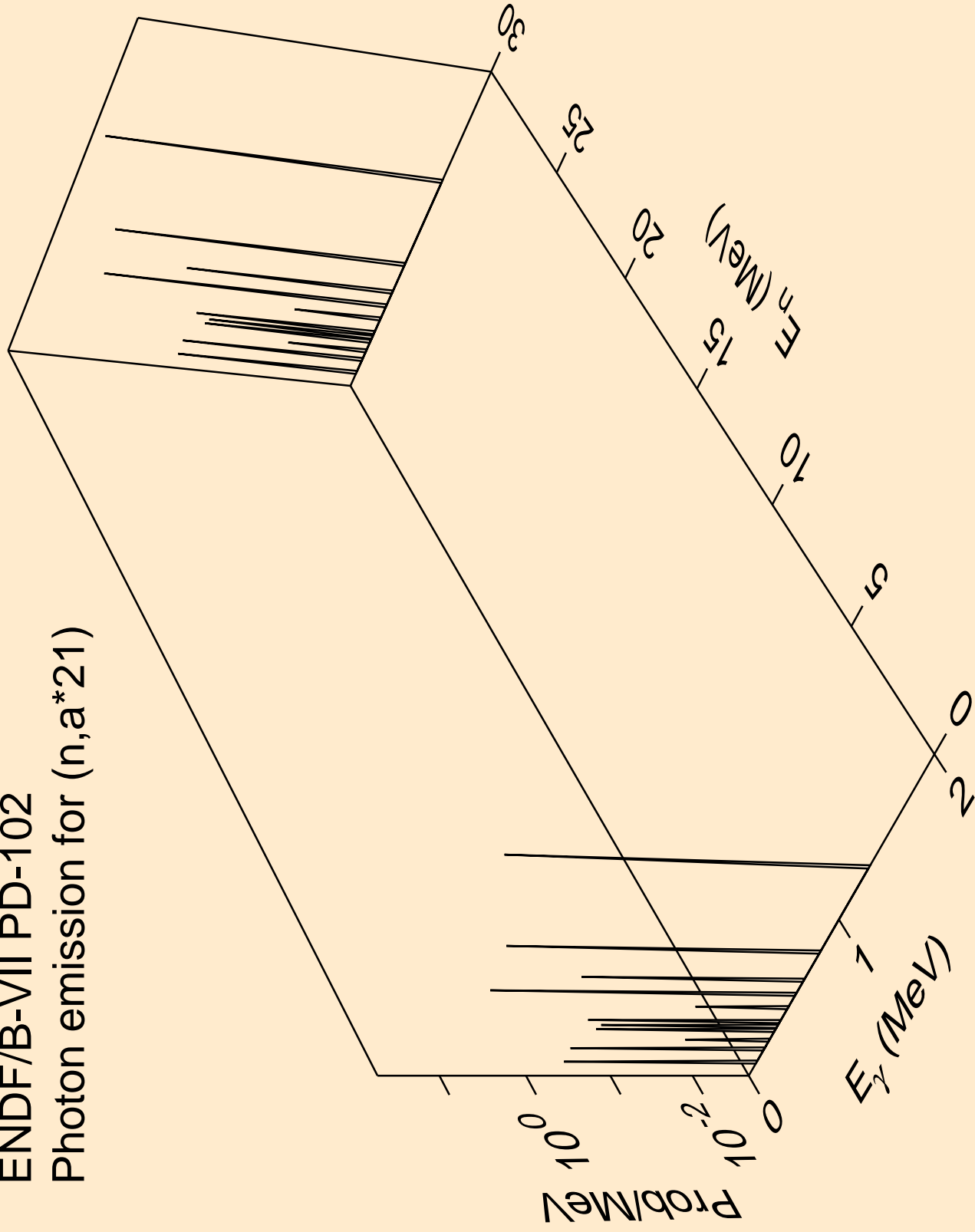

ENDF/B-VII PD-102
Photon emission for (n,a*22)

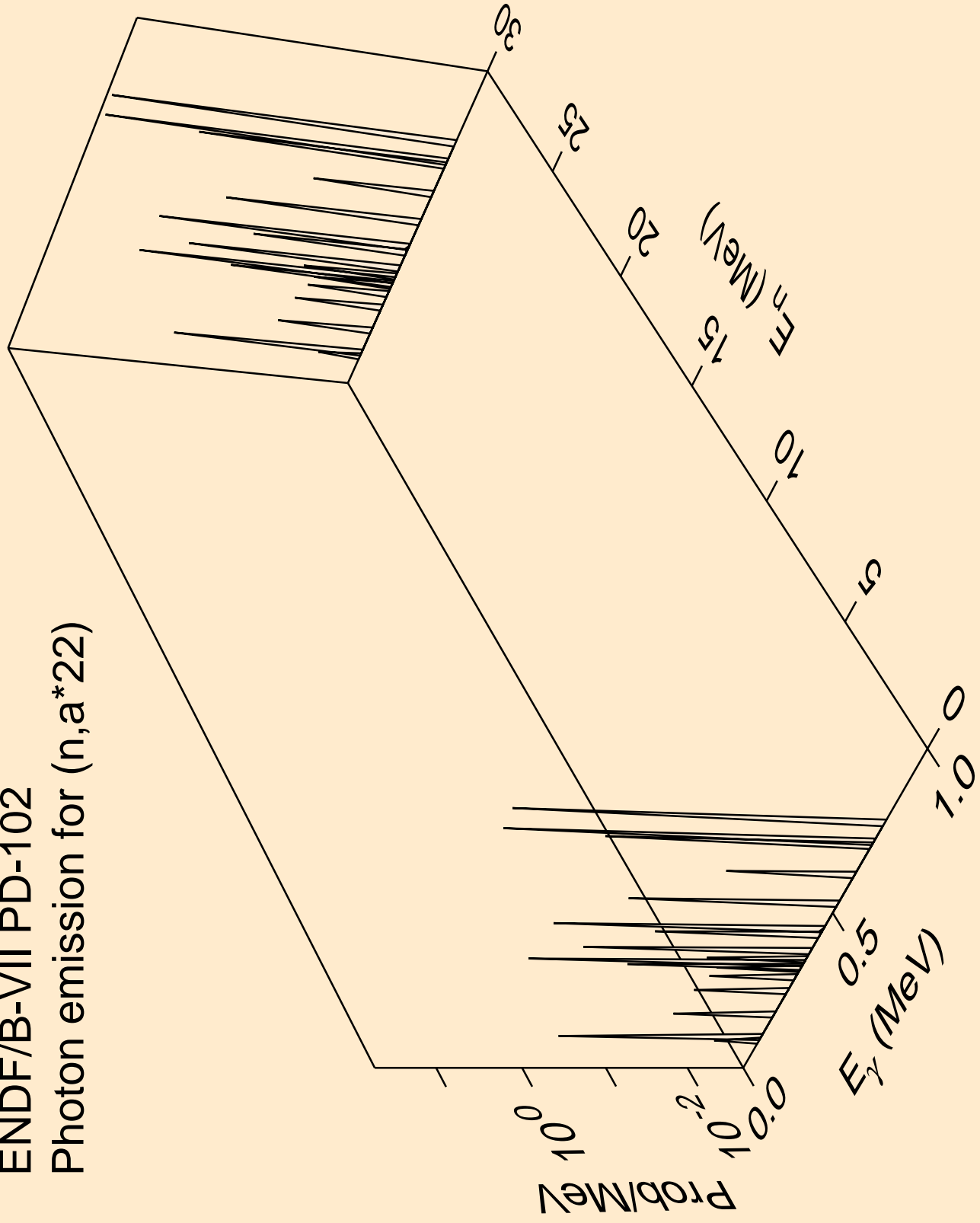

ENDF/B-VII PD-102
Photon emission for (n,a*23)

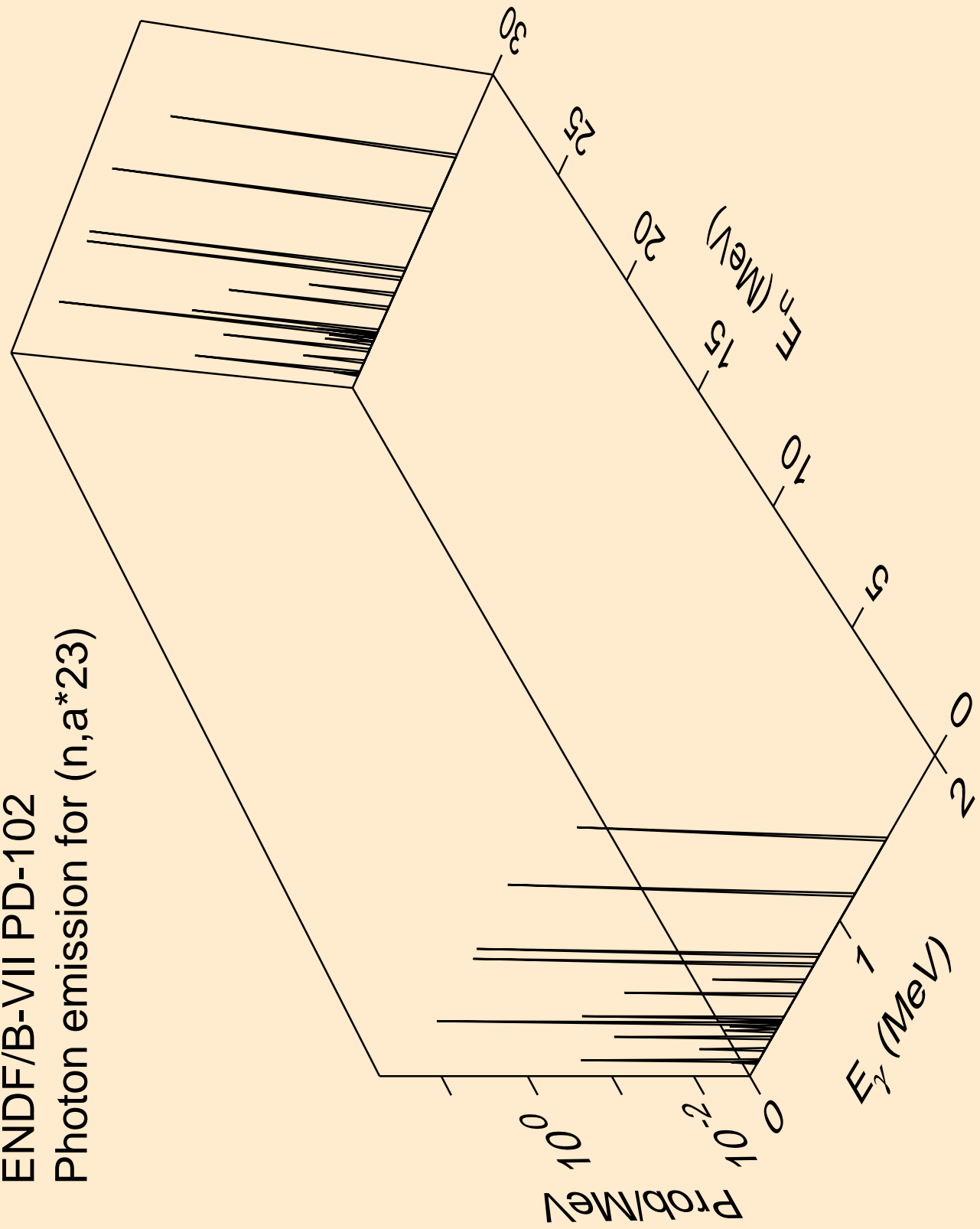

ENDF/B-VII PD-102
Photon emission for (n,a*24)

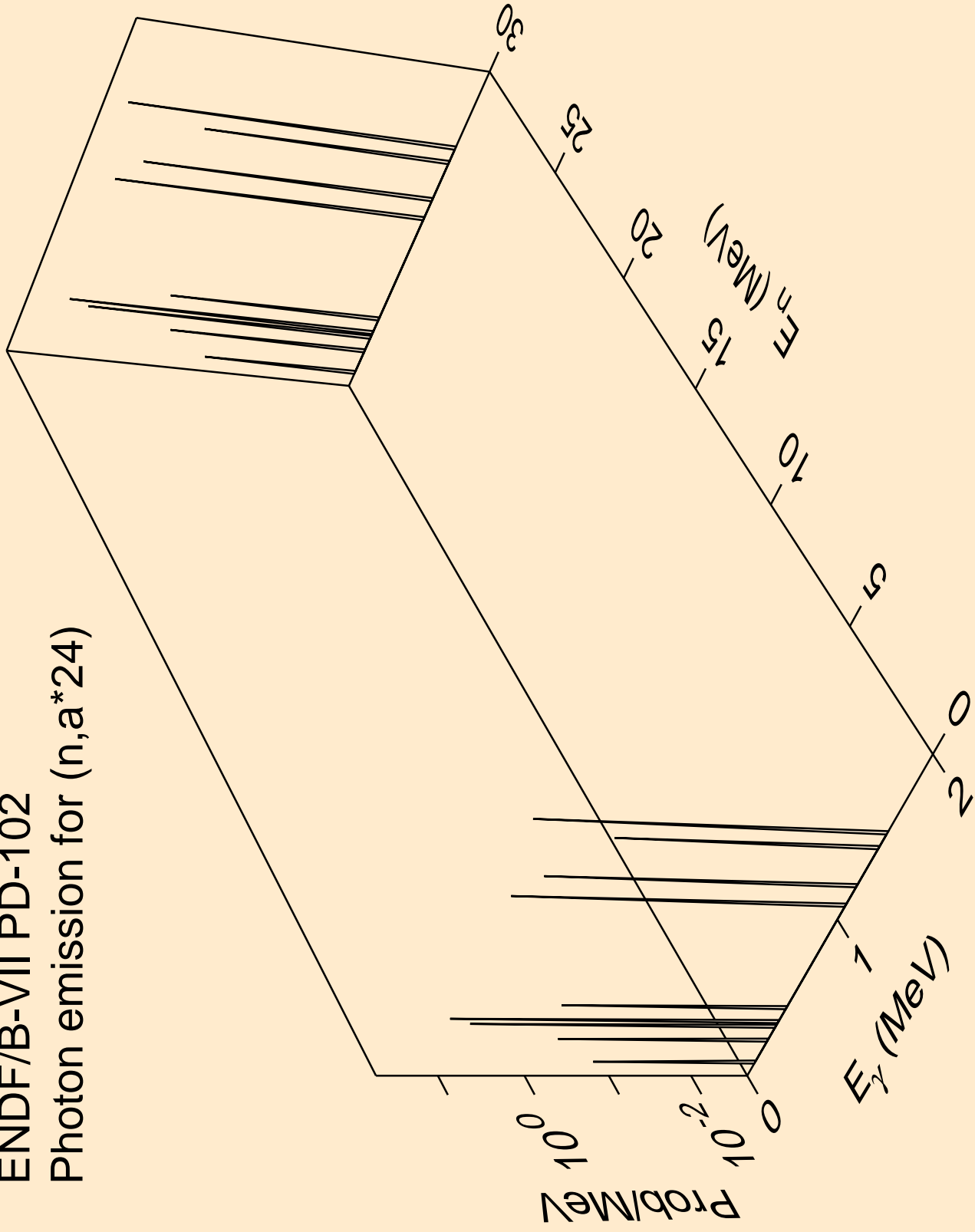

ENDF/B-VII PD-102
Photon emission for (n,a*c)

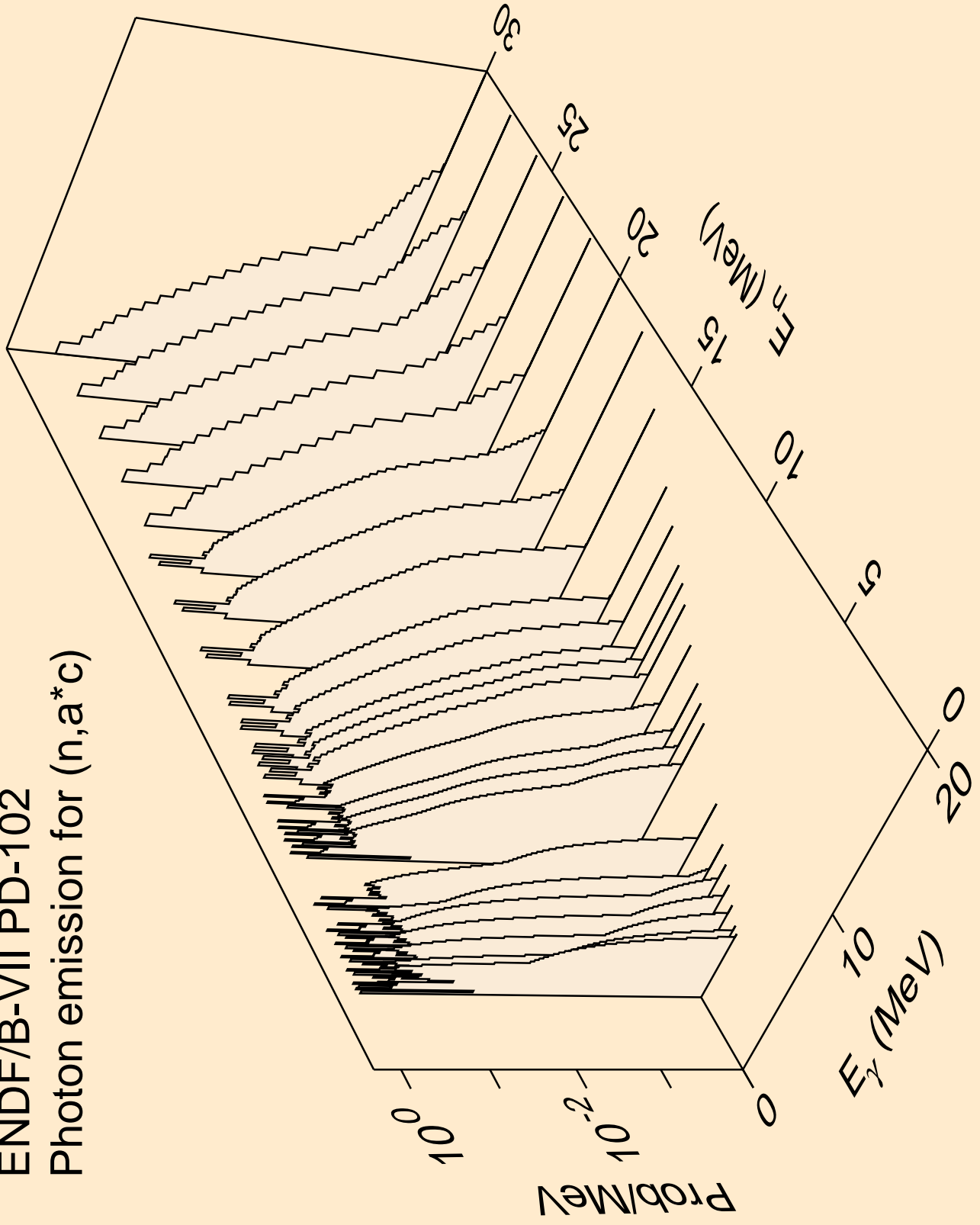

ENDF/B-VII PD-102
thermal capture photon spectrum

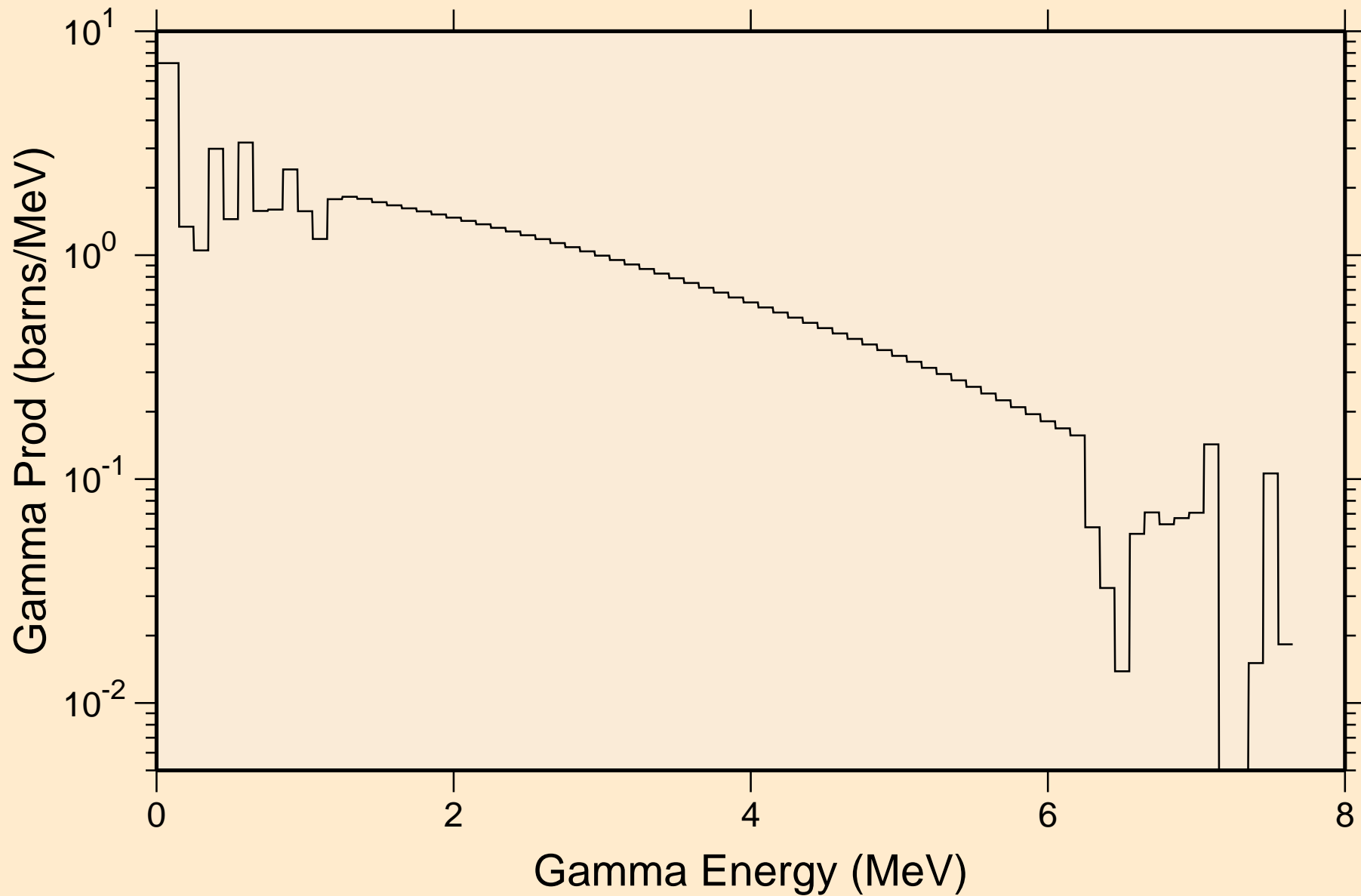

ENDF/B-VII PD-102
14 MeV photon spectrum

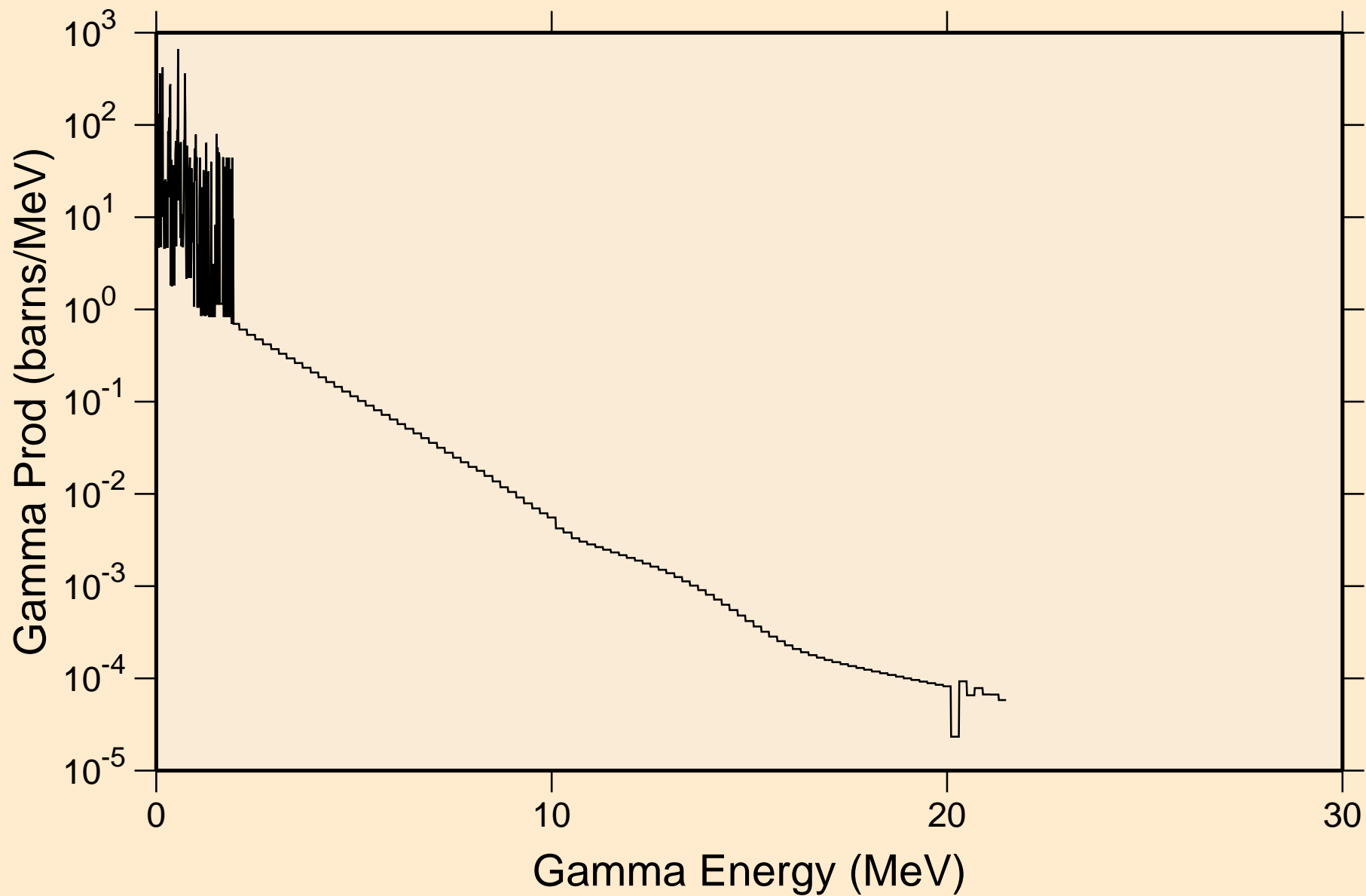

ENDF/B-VII PD-102

Particle heating contributions

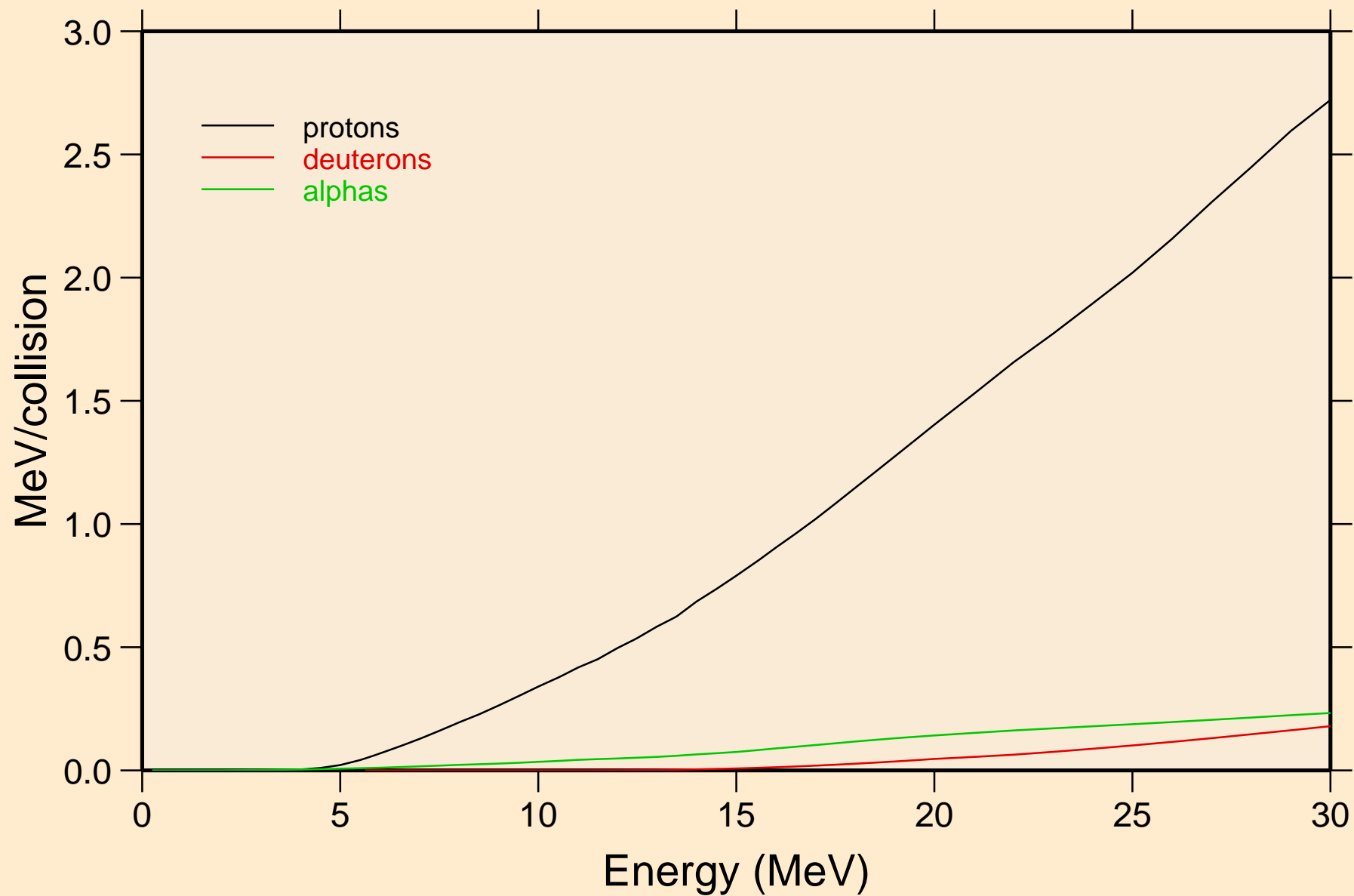

ENDF/B-VII PD-102 Recoil Heating

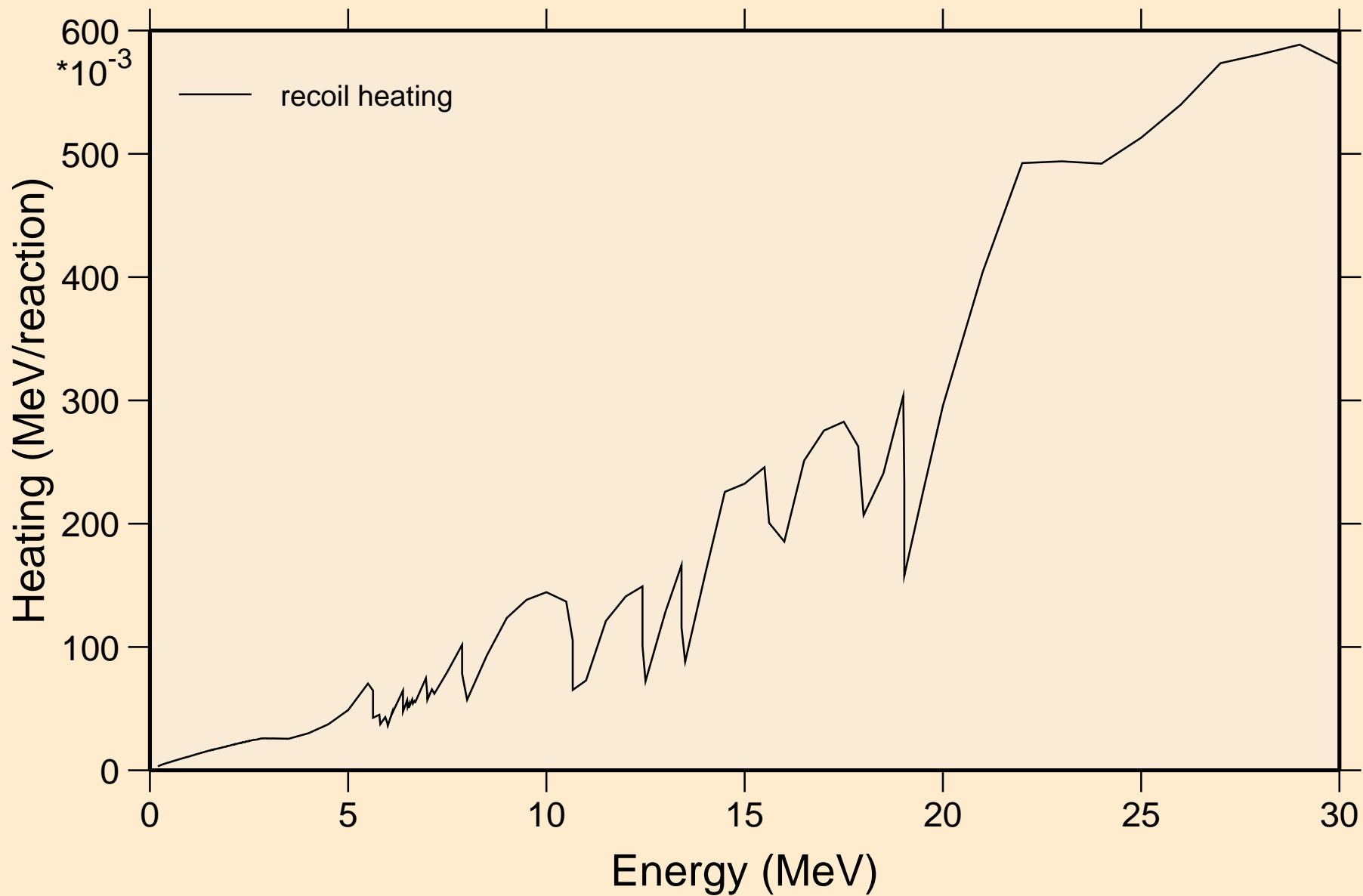

ENDF/B-VII PD-102

Particle production cross sections

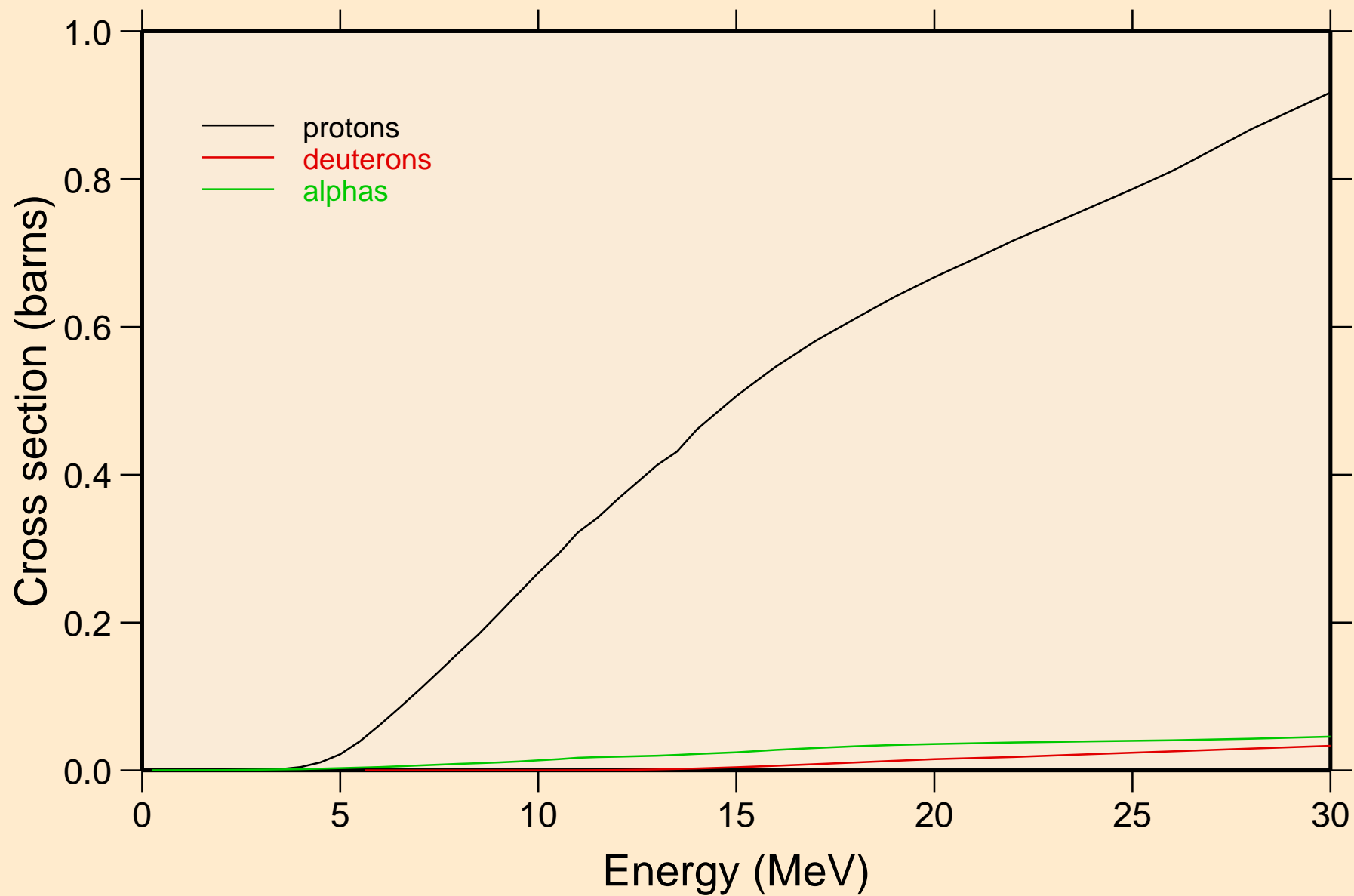

ENDF/B-VII PD-102
protons from (n,n*)p

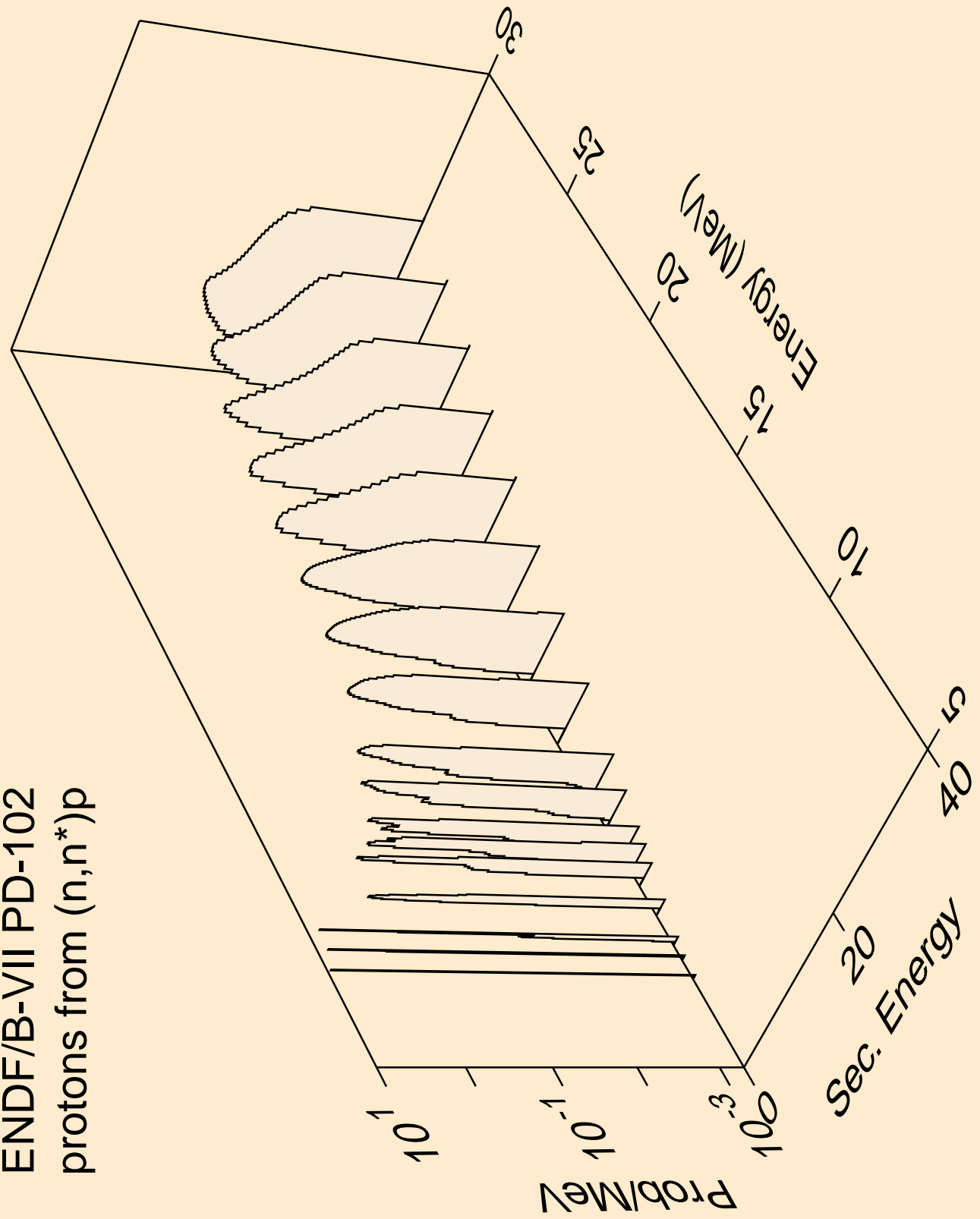

ENDF/B-VII PD-102
protons from (n,2np)

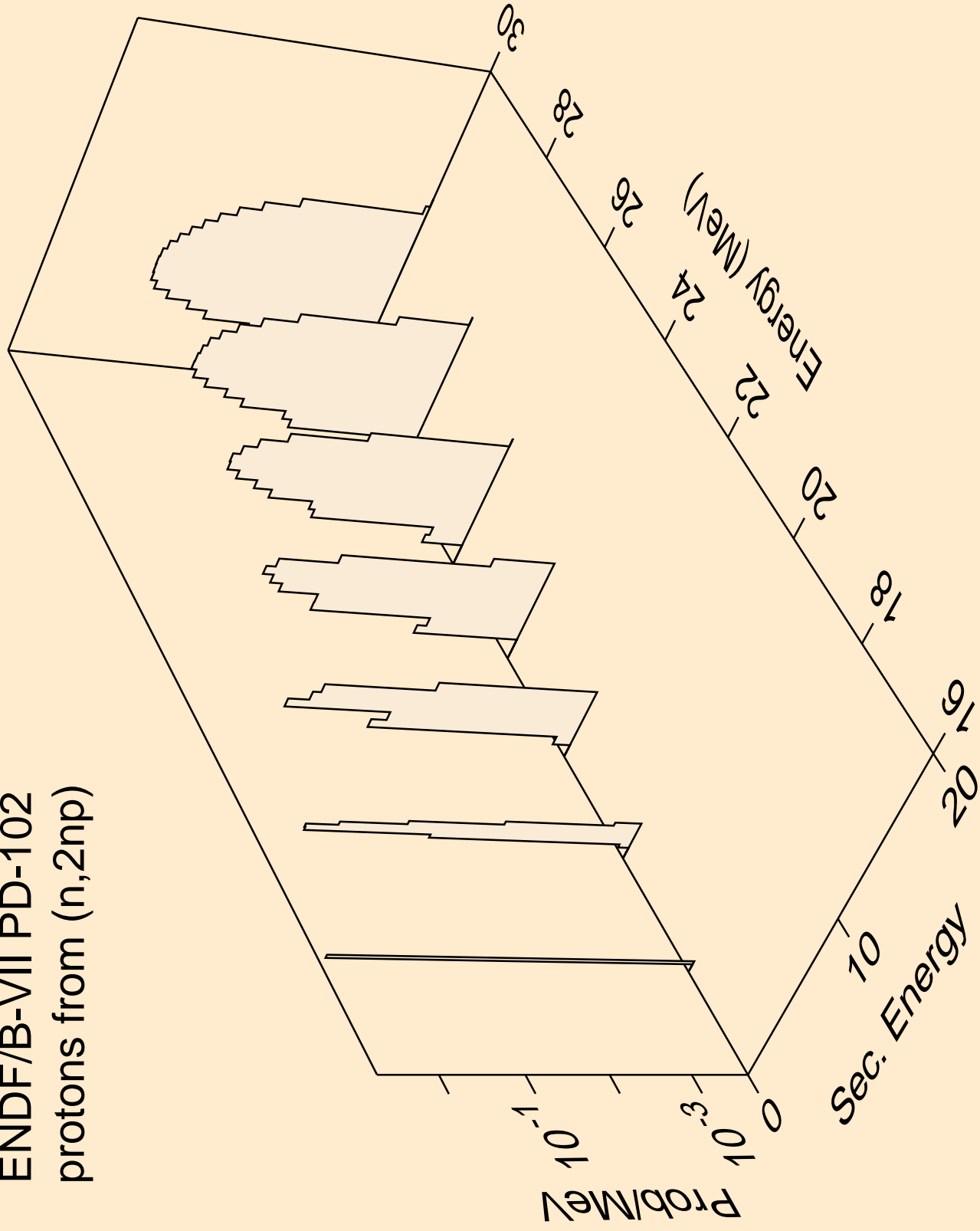

ENDF/B-VII PD-102
protons from (n,n2p)

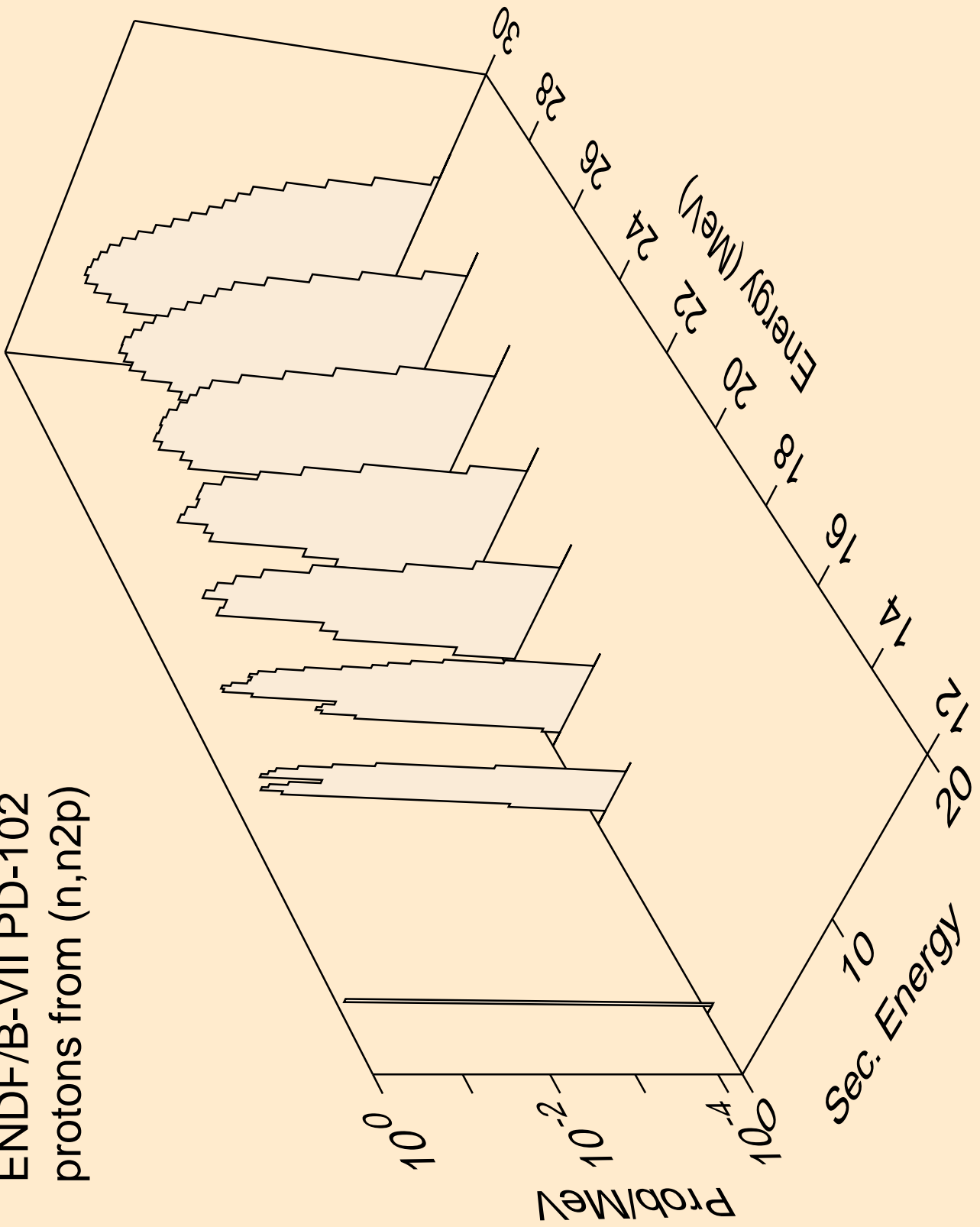

ENDF/B-VII PD-102
protons from (n,2p)

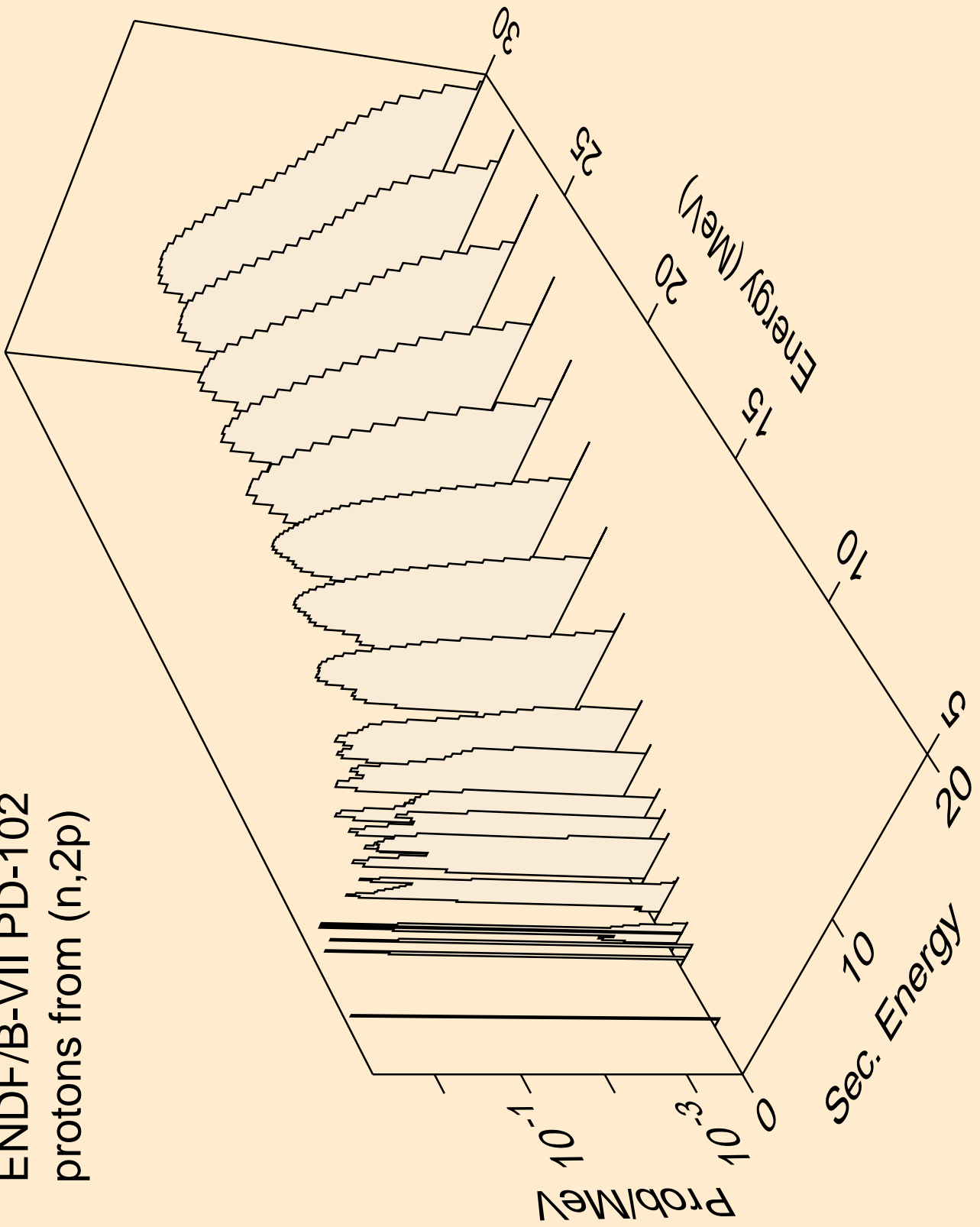

ENDF/B-VII PD-102
angular distribution for (n,p*0) proton

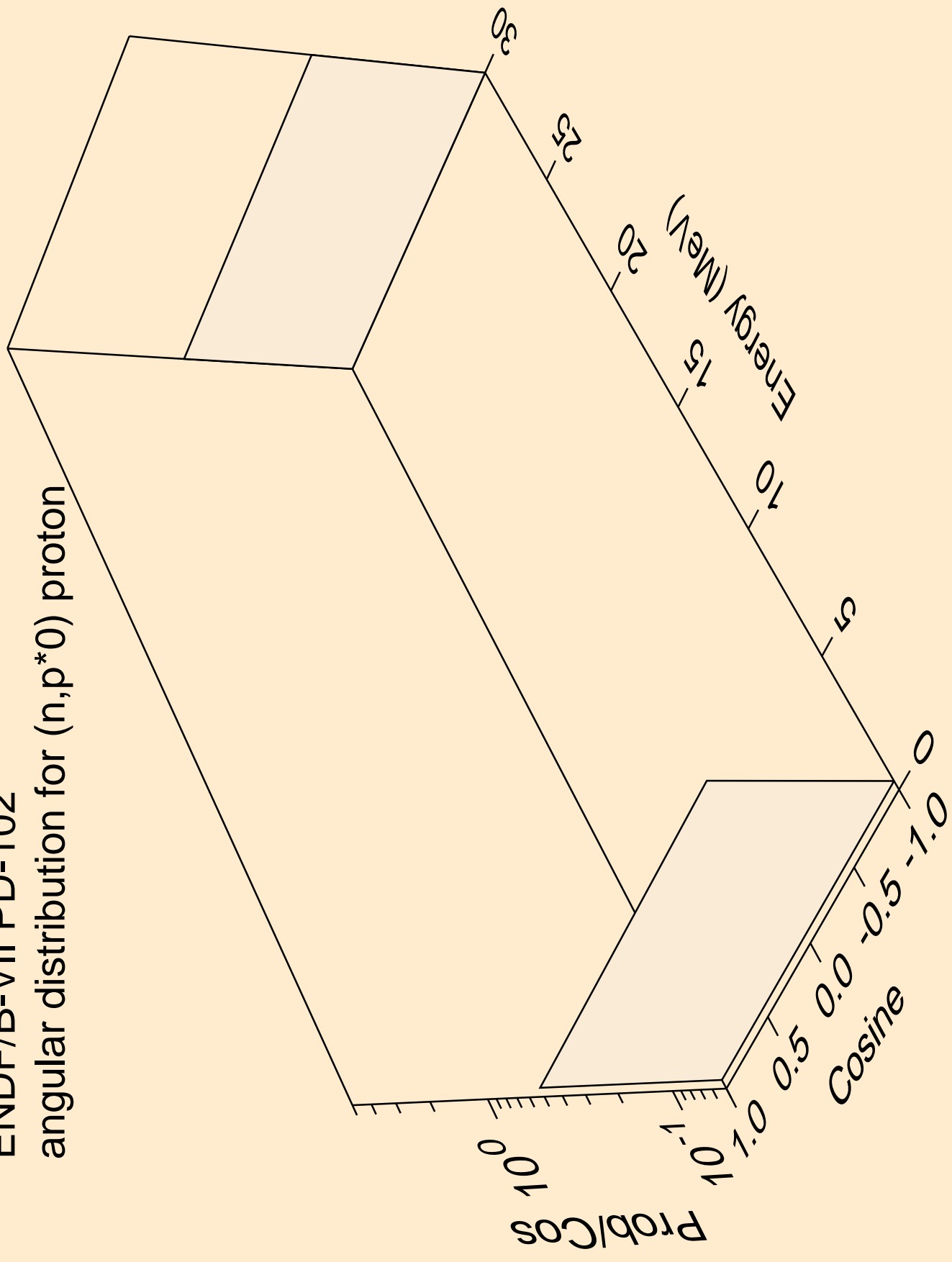

ENDF/B-VII PD-102
angular distribution for (n,p*1) proton

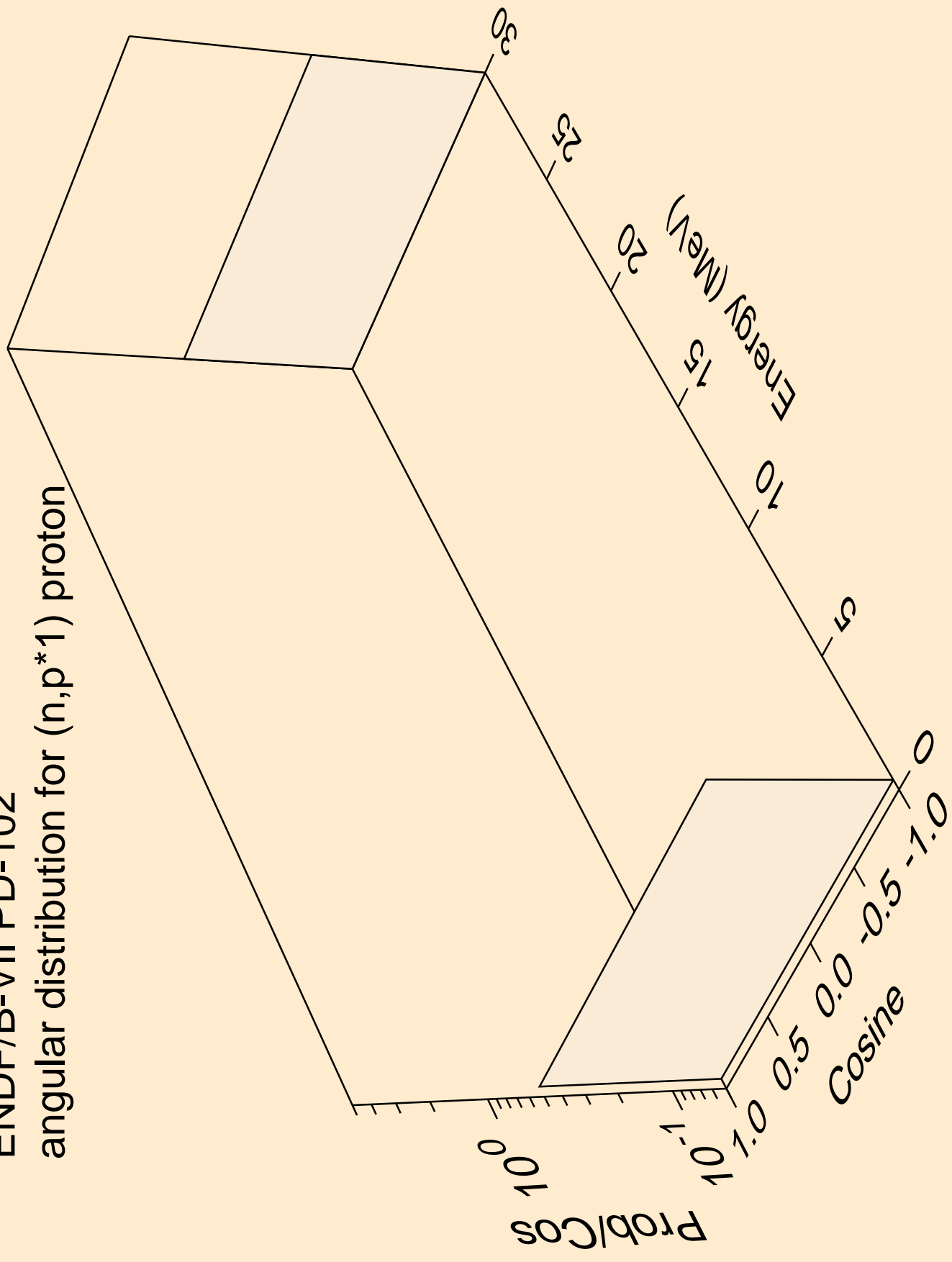

ENDF/B-VII PD-102
angular distribution for (n,p*2) proton

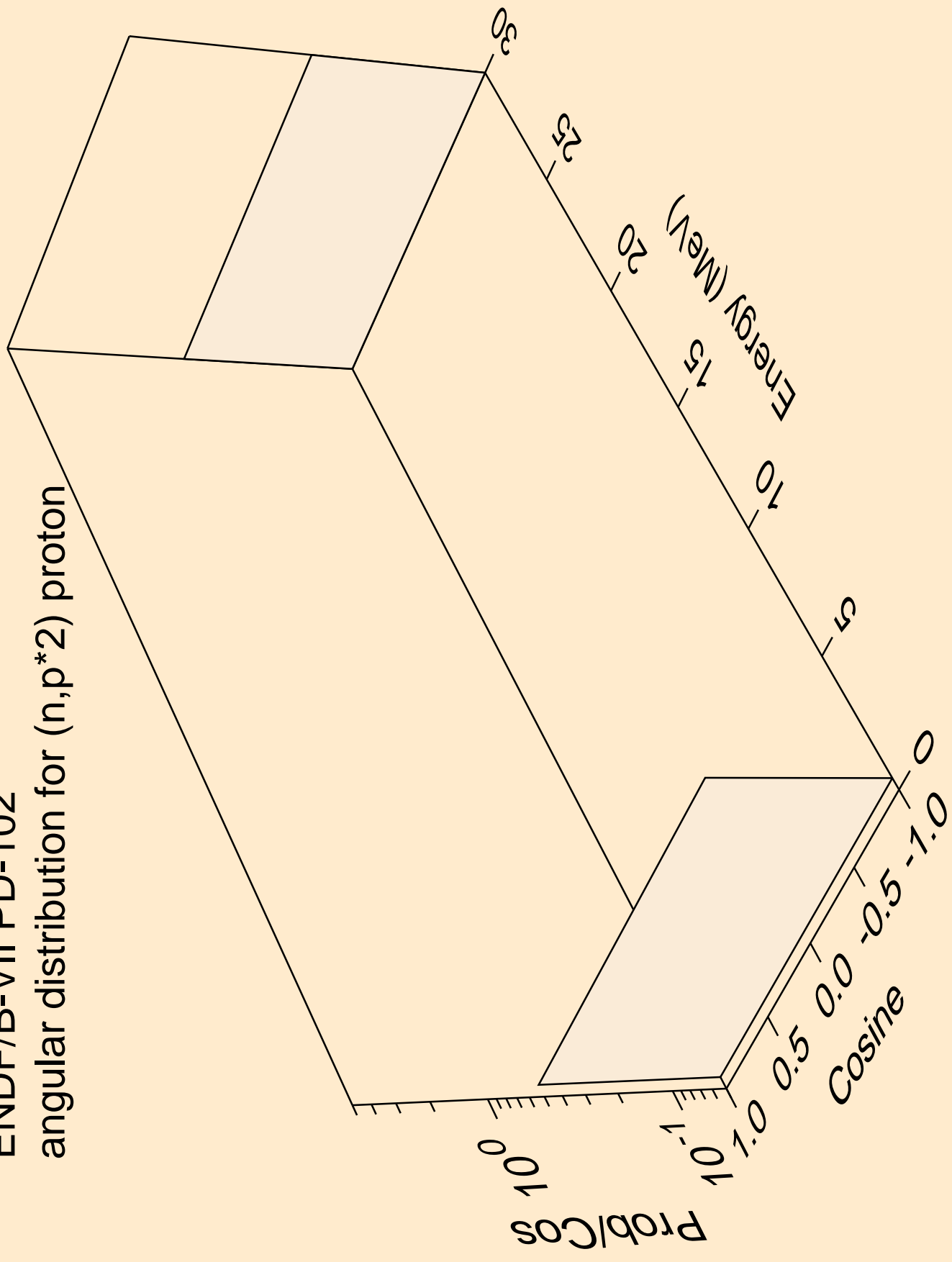

ENDF/B-VII PD-102
angular distribution for (n,p*3) proton

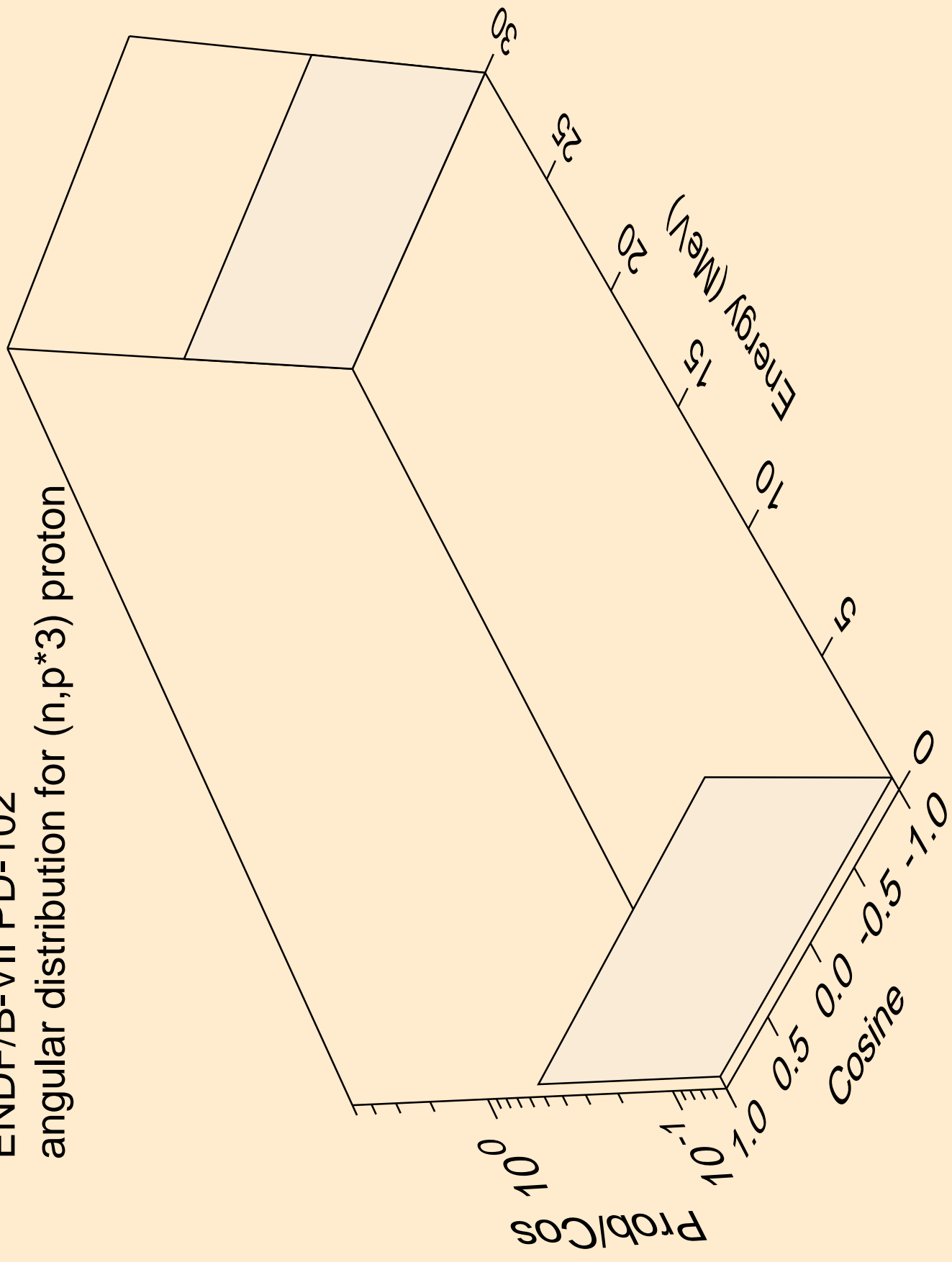

ENDF/B-VII PD-102
angular distribution for (n,p*4) proton

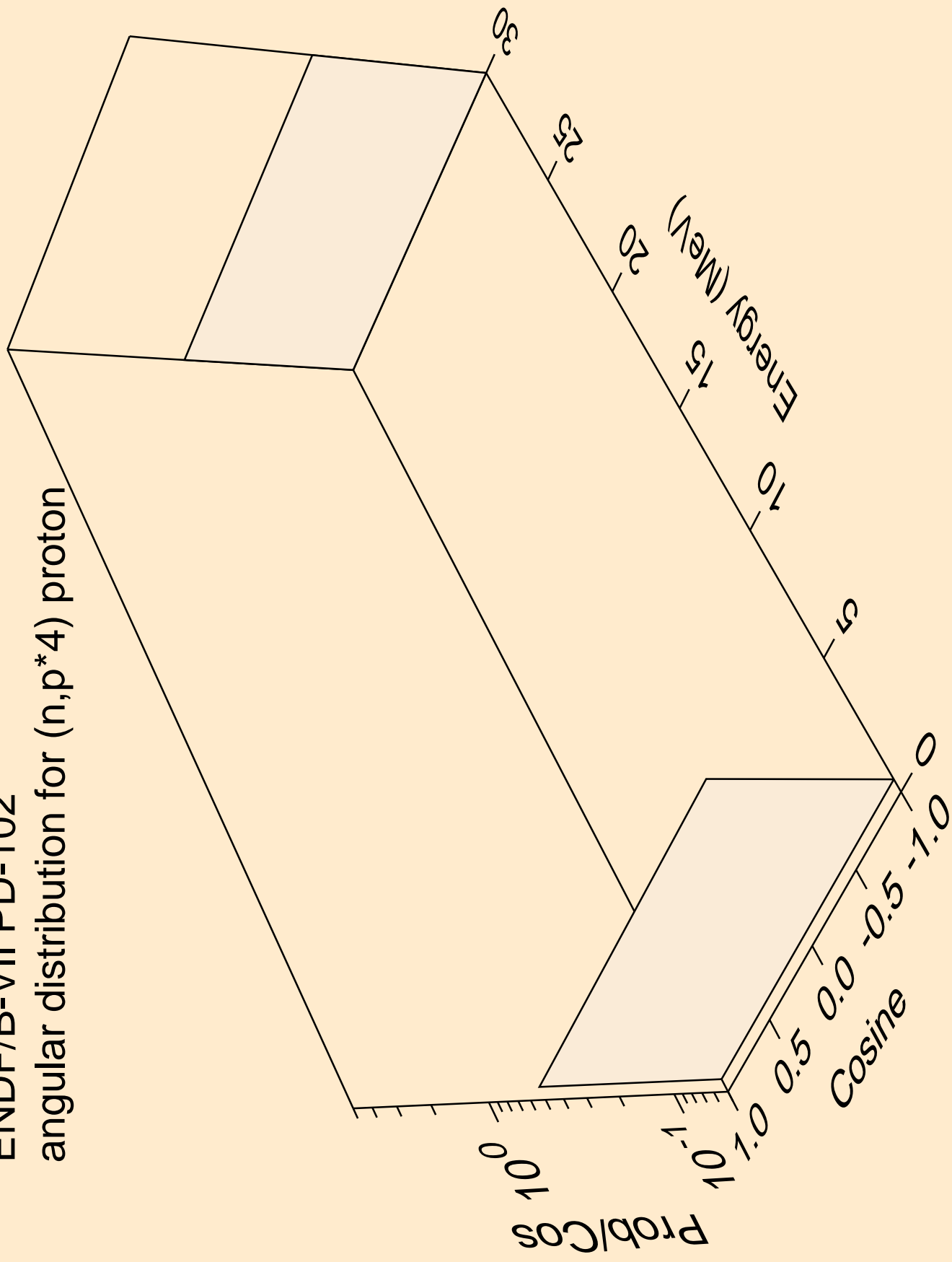

ENDF/B-VII PD-102
angular distribution for (n,p*5) proton

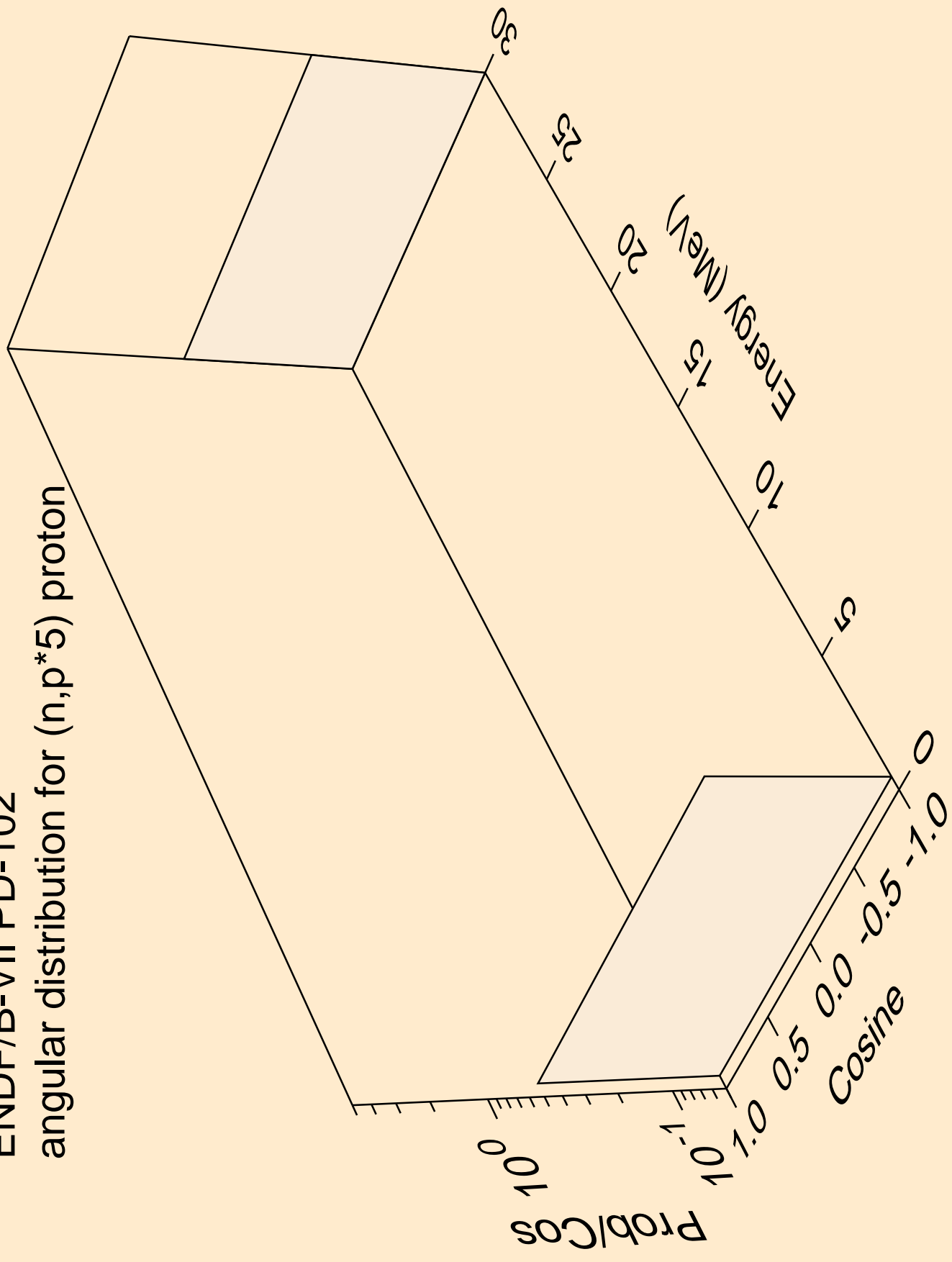

ENDF/B-VII PD-102
protons from (n,p*c)

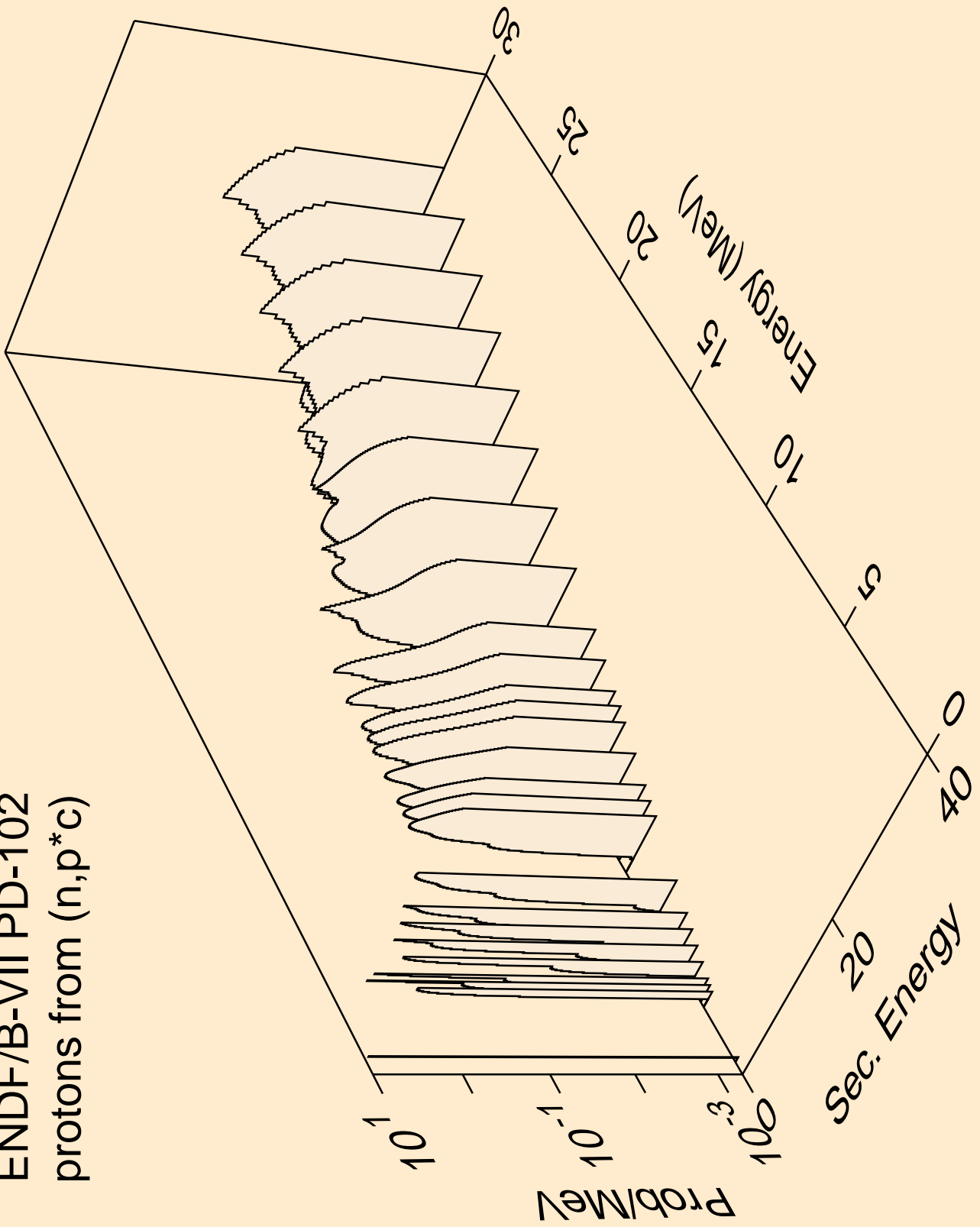

ENDF/B-VII PD-102
deuterons from $(n,n^*)d$

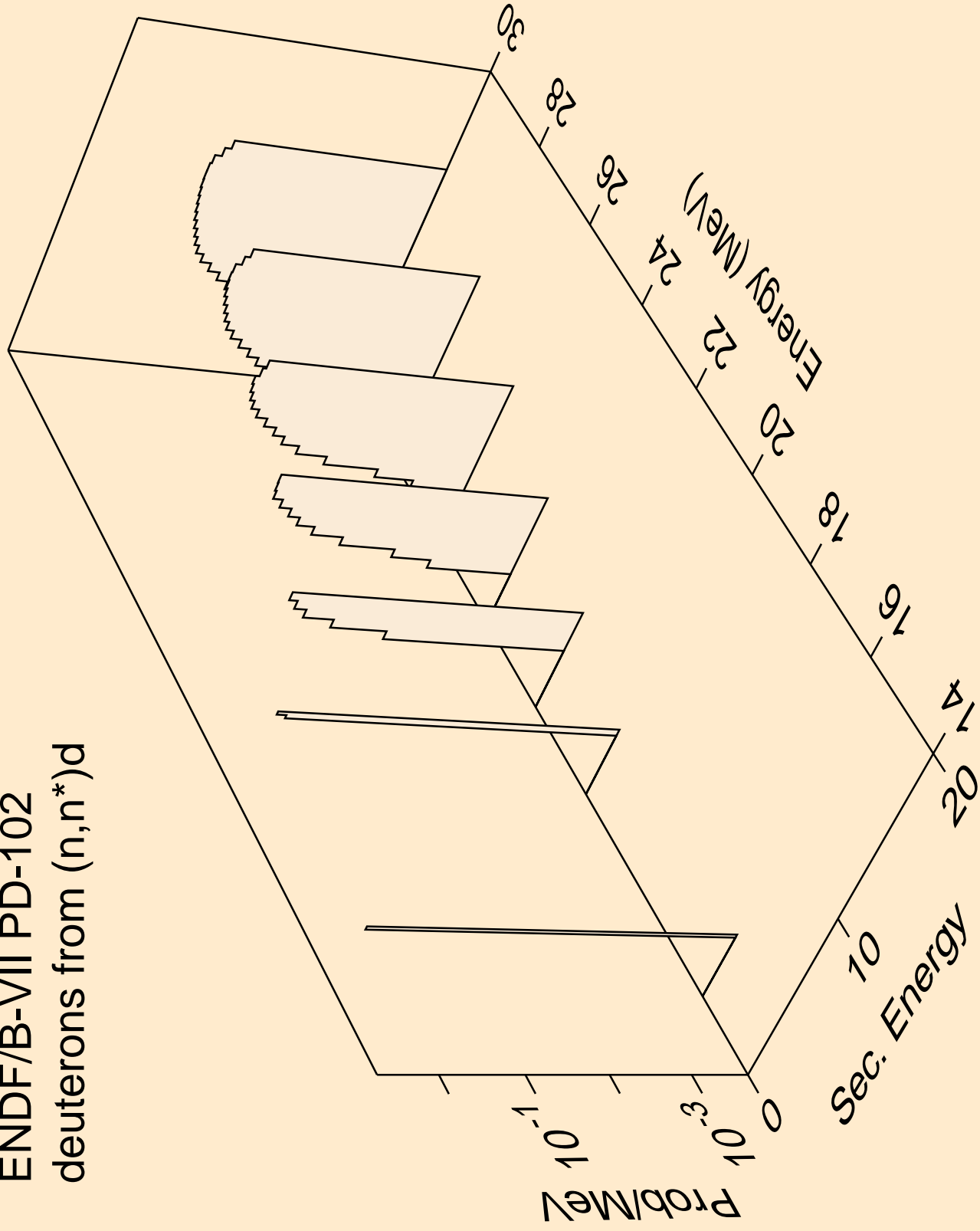

ENDF/B-VII PD-102
angular distribution for (n,d*0) deuteron

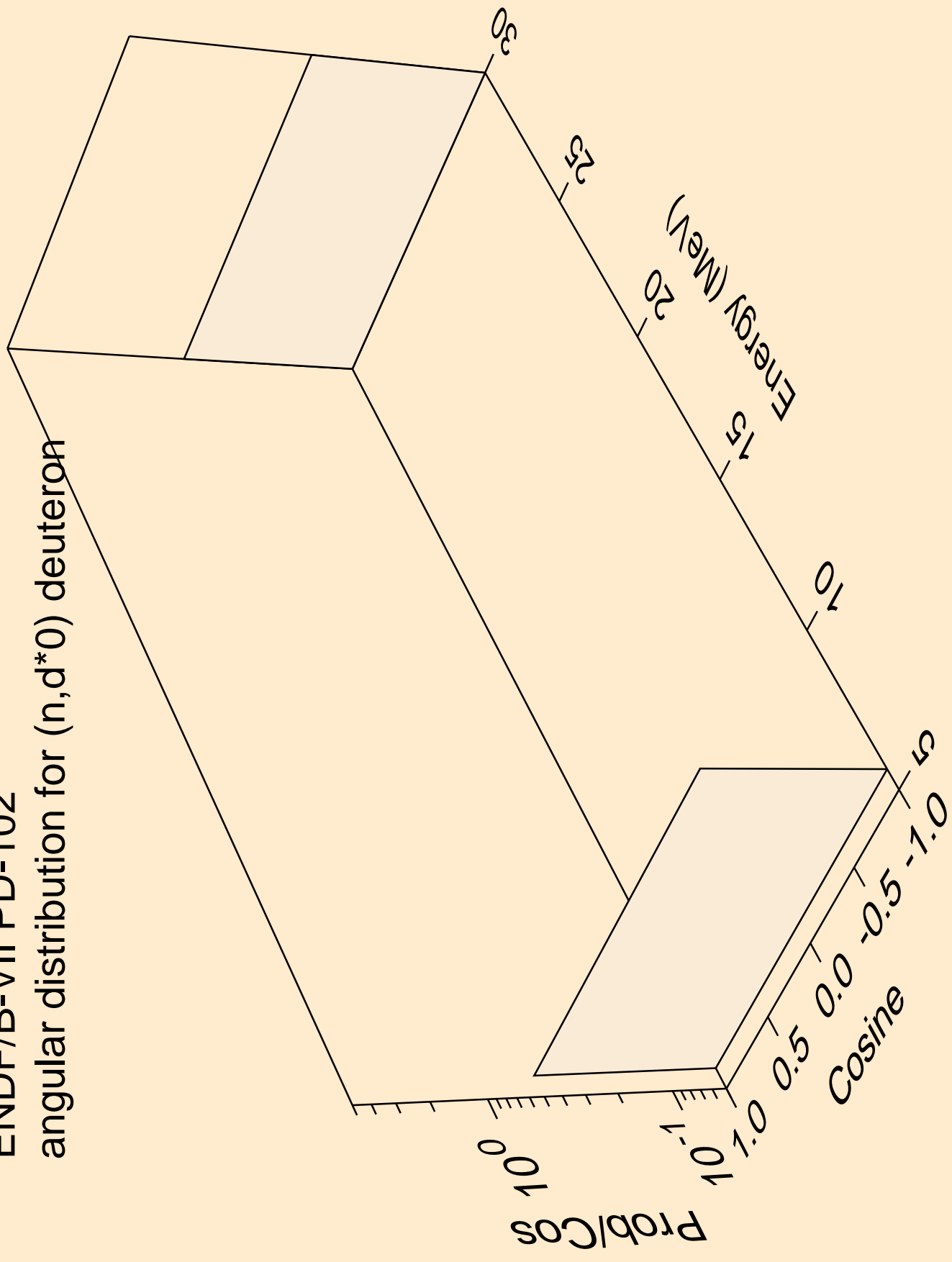

ENDF/B-VII PD-102
angular distribution for (n,d*1) deuteron

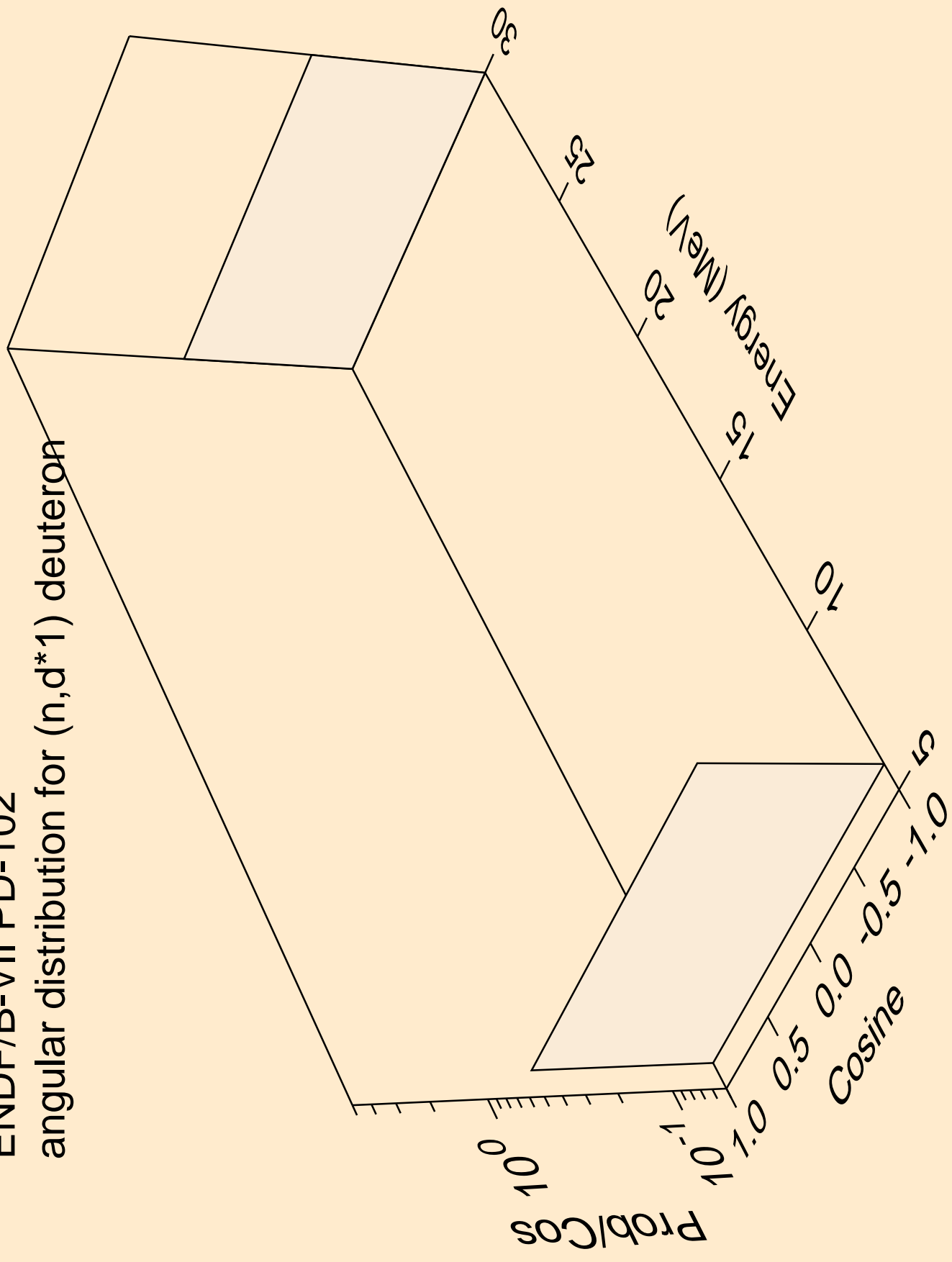

ENDF/B-VII PD-102
angular distribution for (n,d*2) deuteron

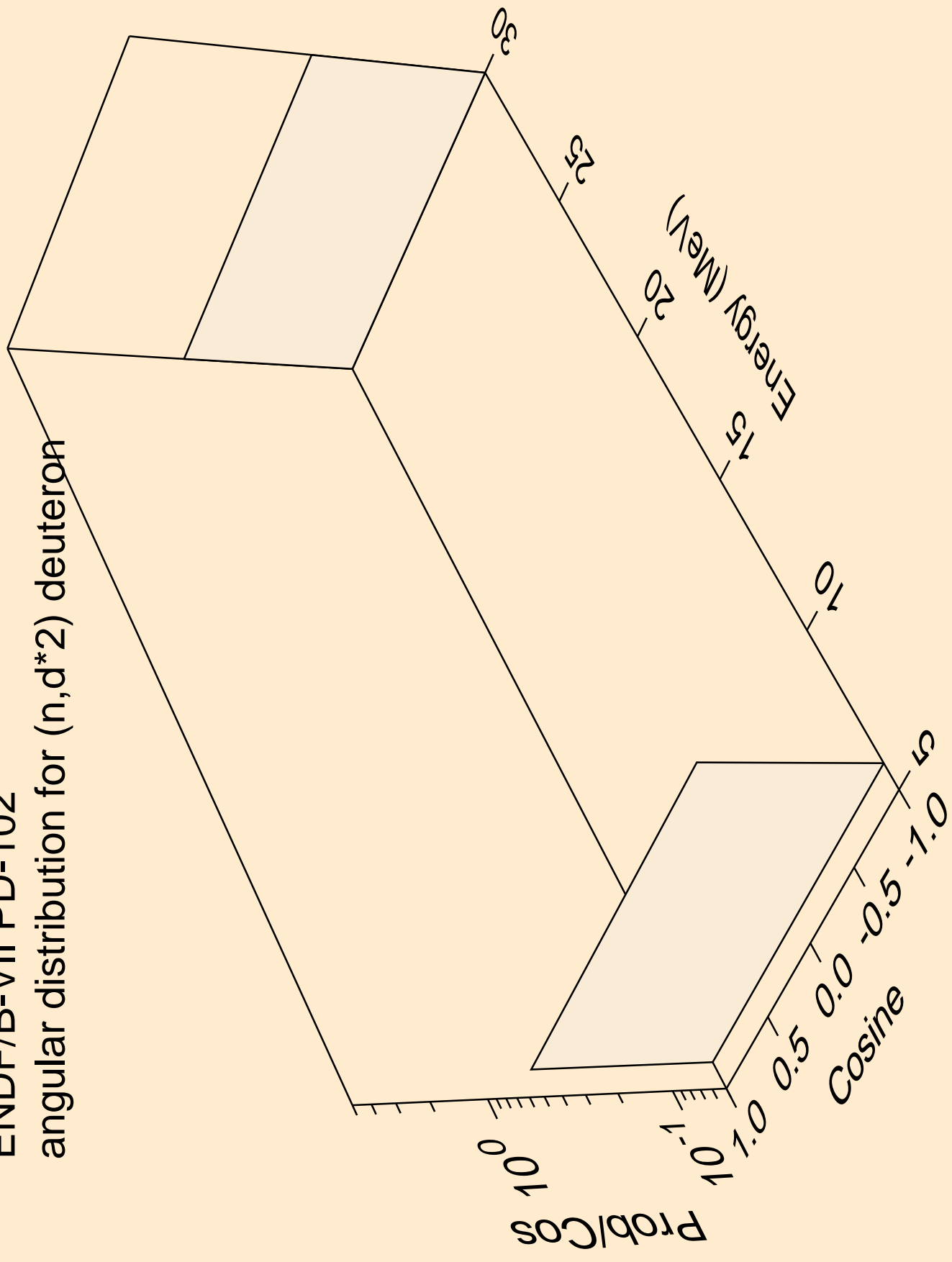

ENDF/B-VII PD-102
angular distribution for (n,d*3) deuteron

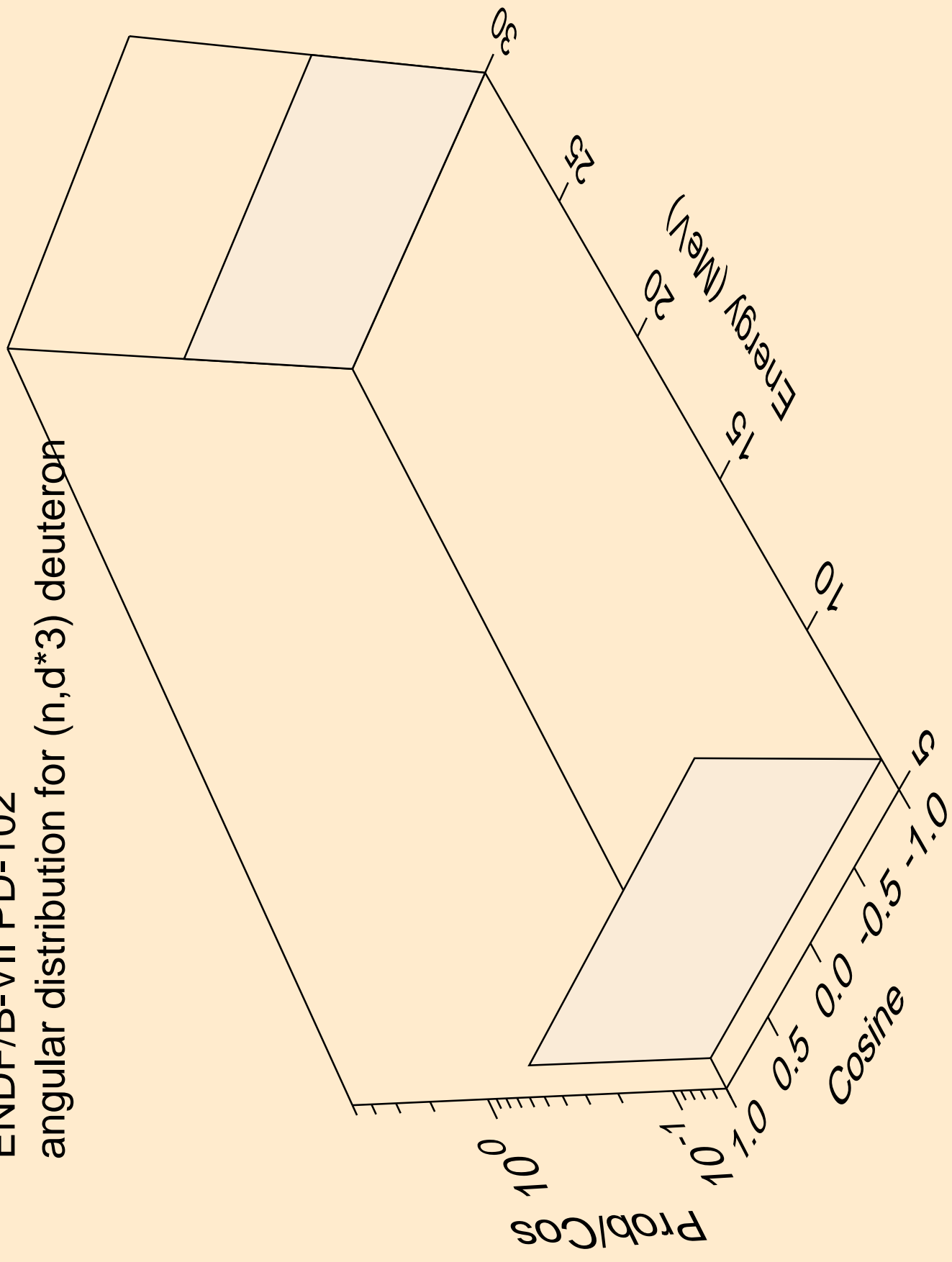

ENDF/B-VII PD-102
angular distribution for (n,d*4) deuteron

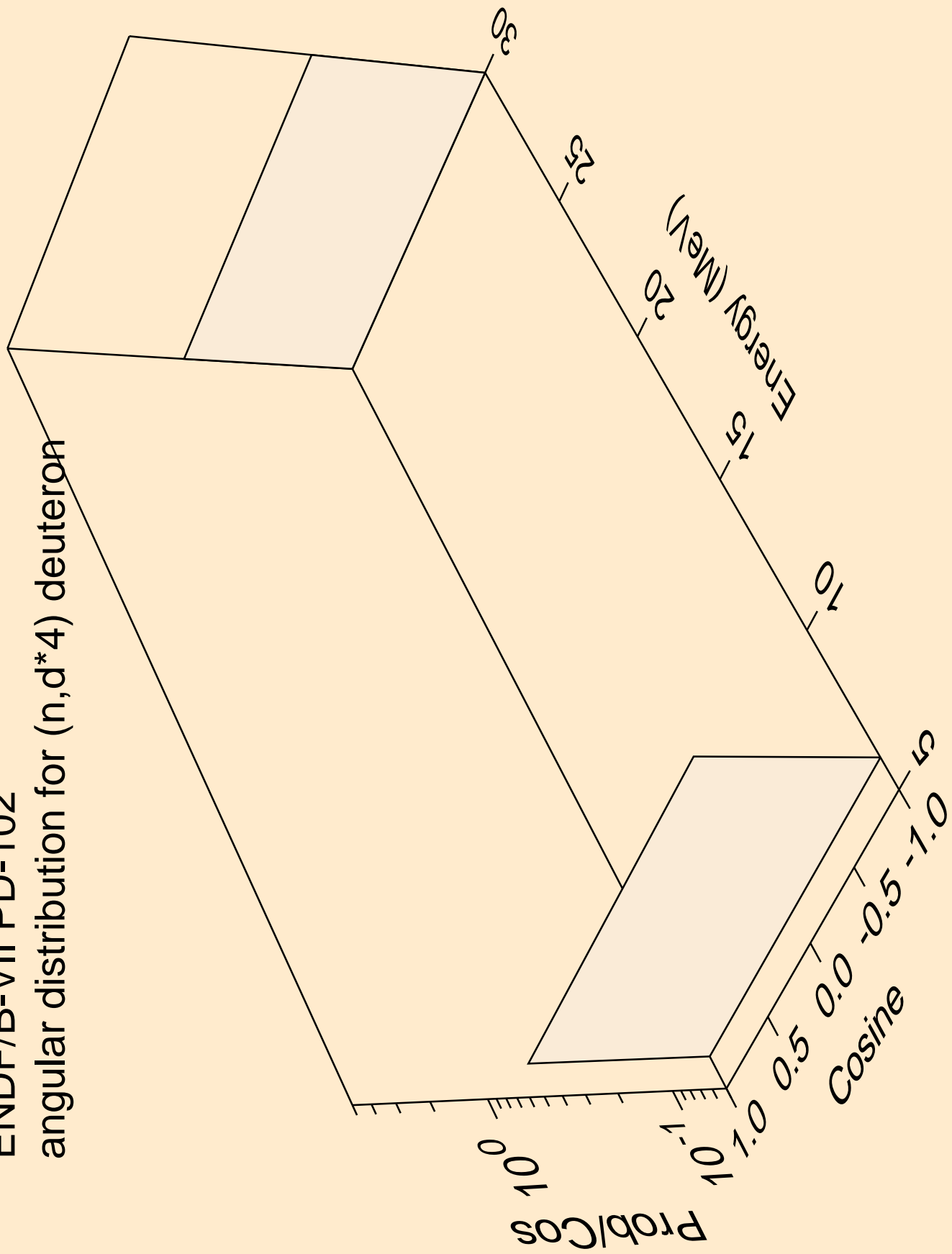

ENDF/B-VII PD-102
angular distribution for (n,d*5) deuteron

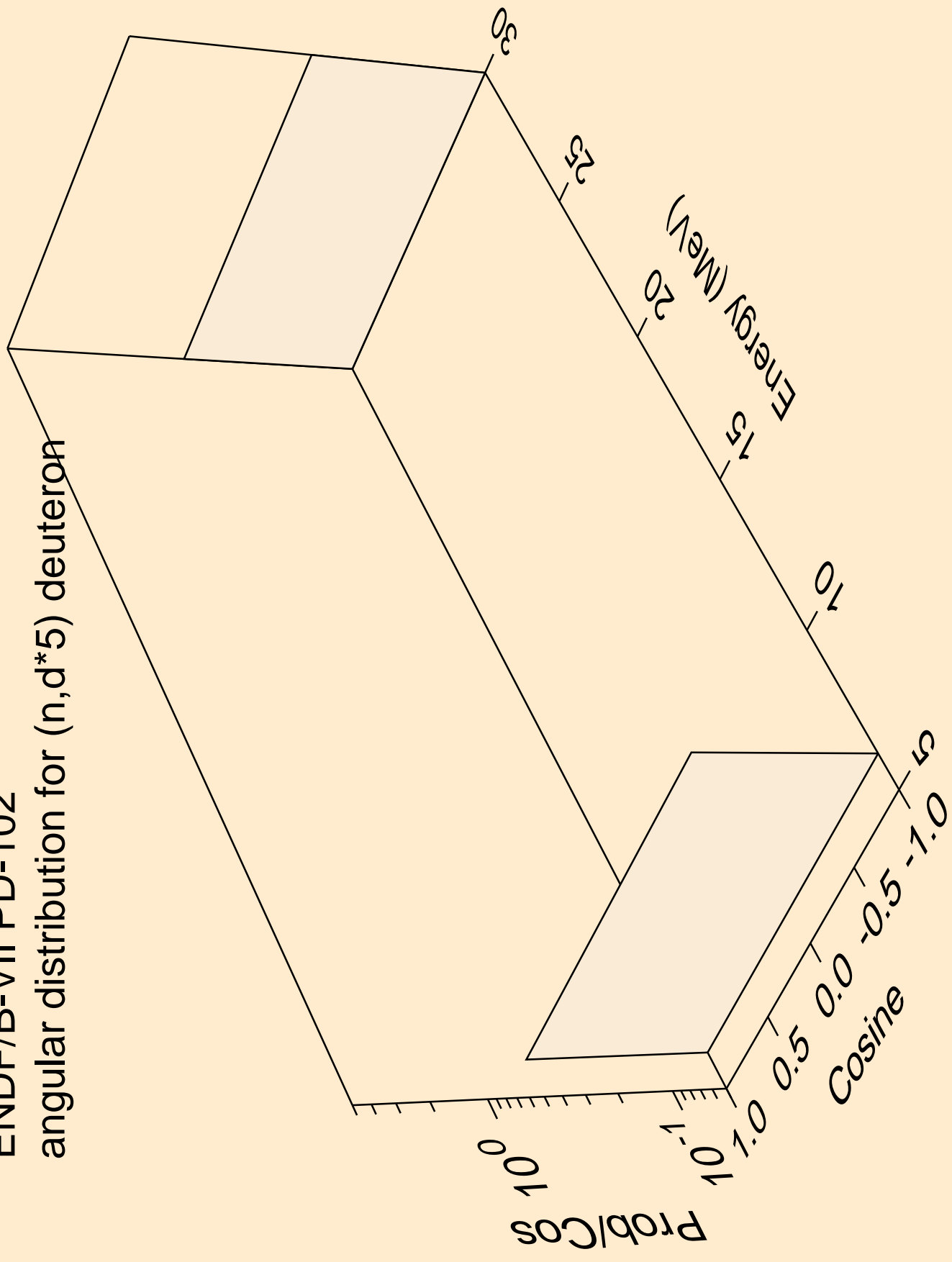

ENDF/B-VII PD-102
angular distribution for (n,d*6) deuteron

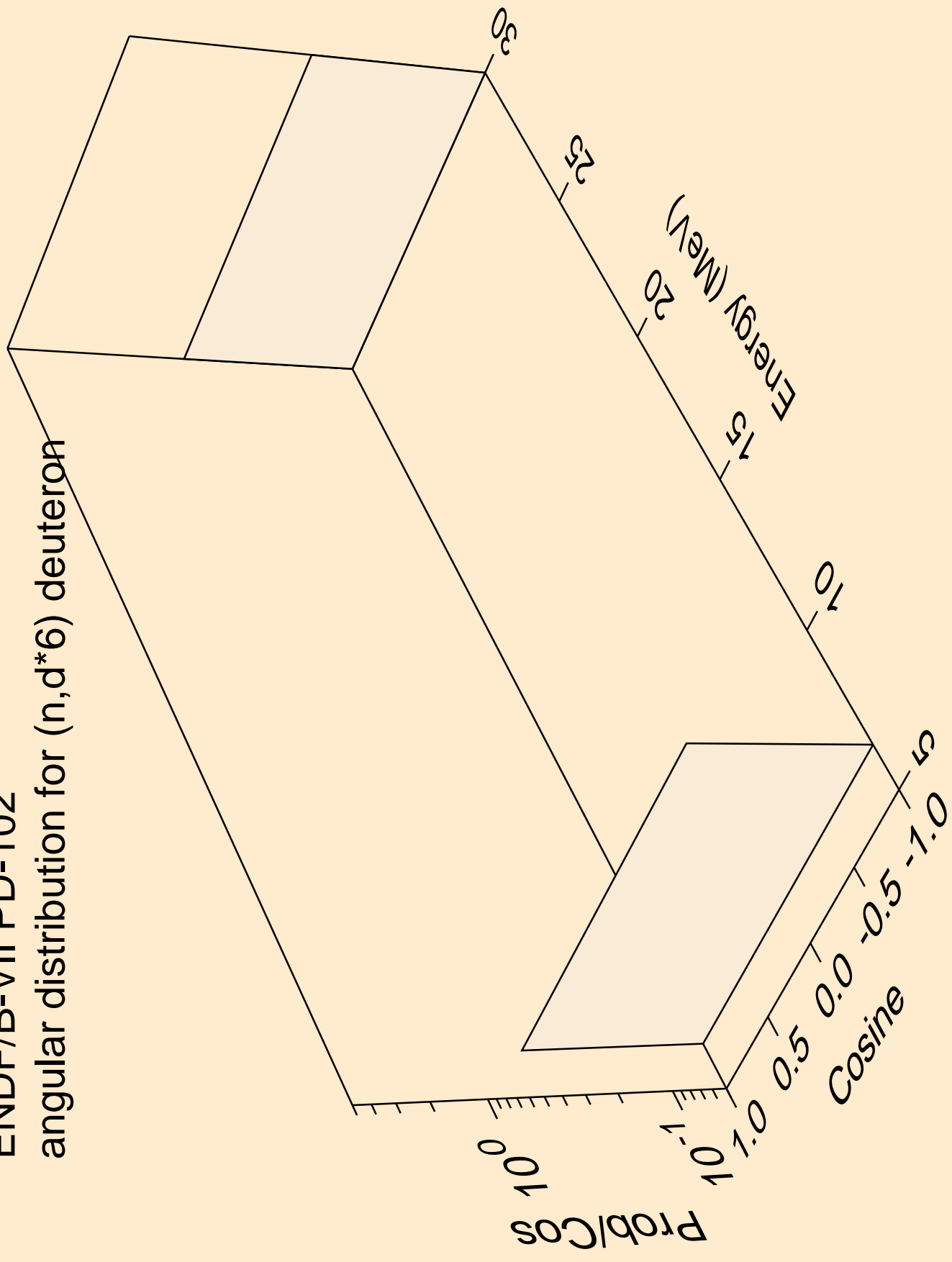

ENDF/B-VII PD-102
angular distribution for (n,d*7) deuteron

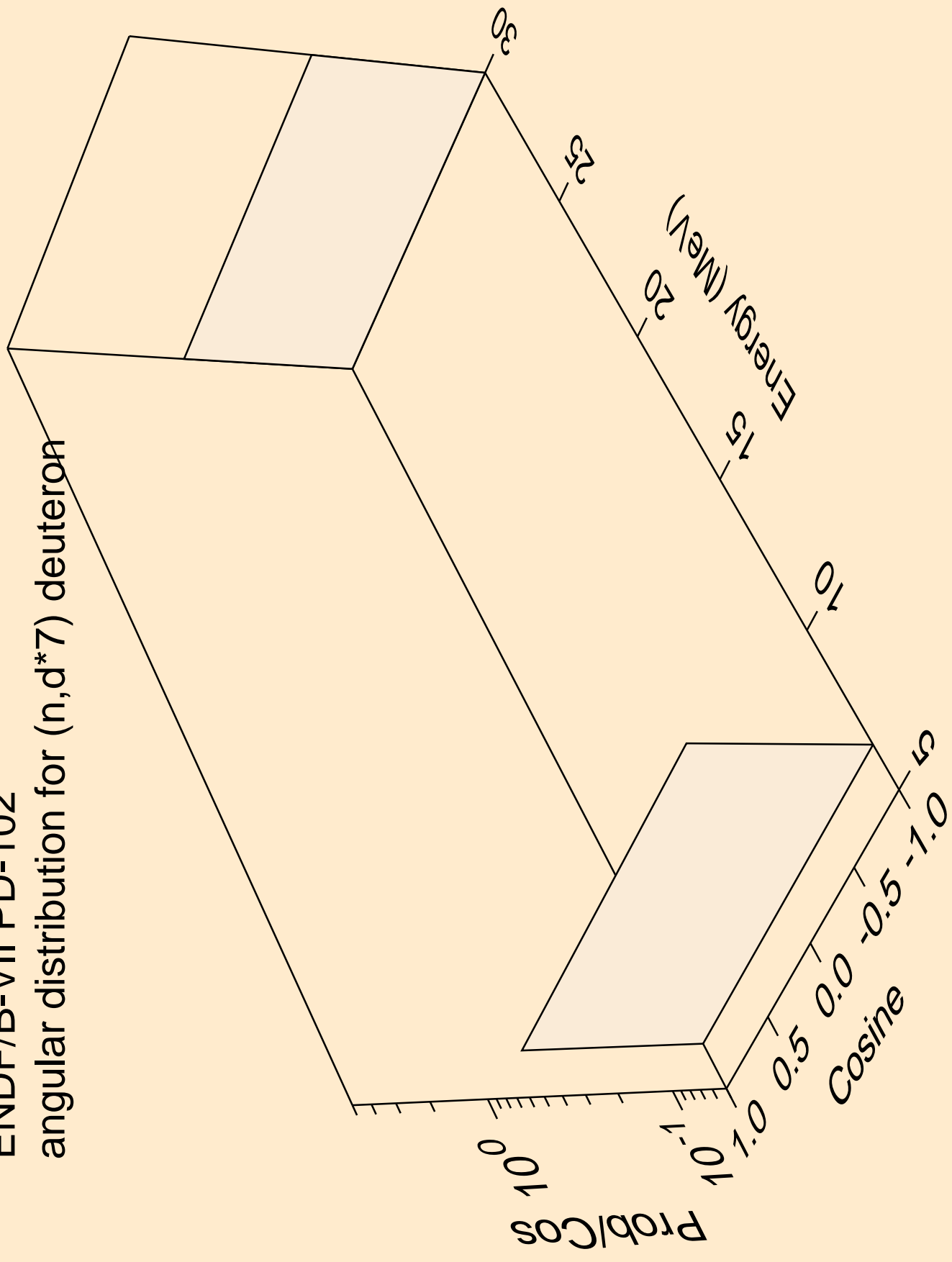

ENDF/B-VII PD-102
angular distribution for (n,d*8) deuteron

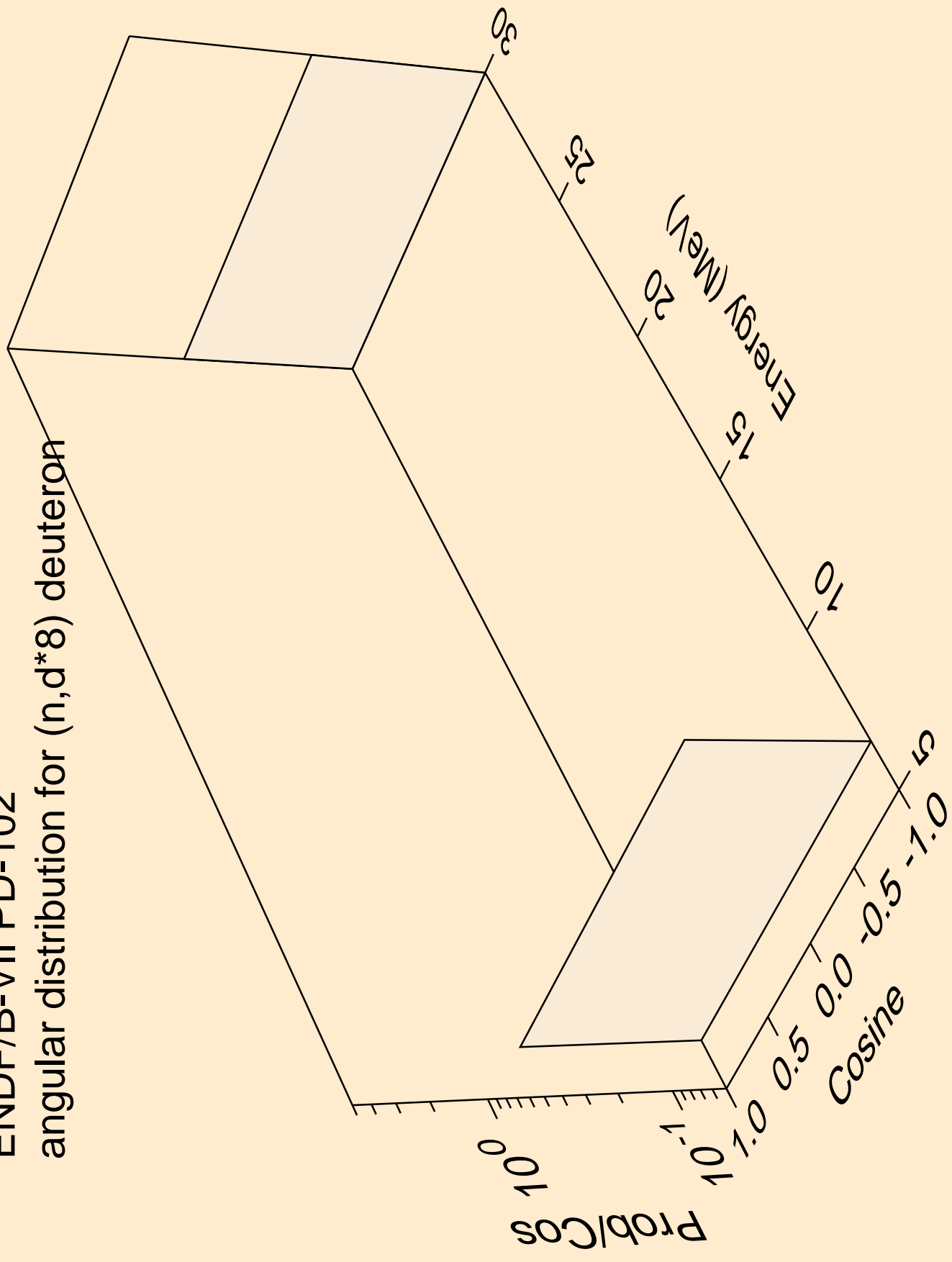

ENDF/B-VII PD-102
angular distribution for (n,d*9) deuteron

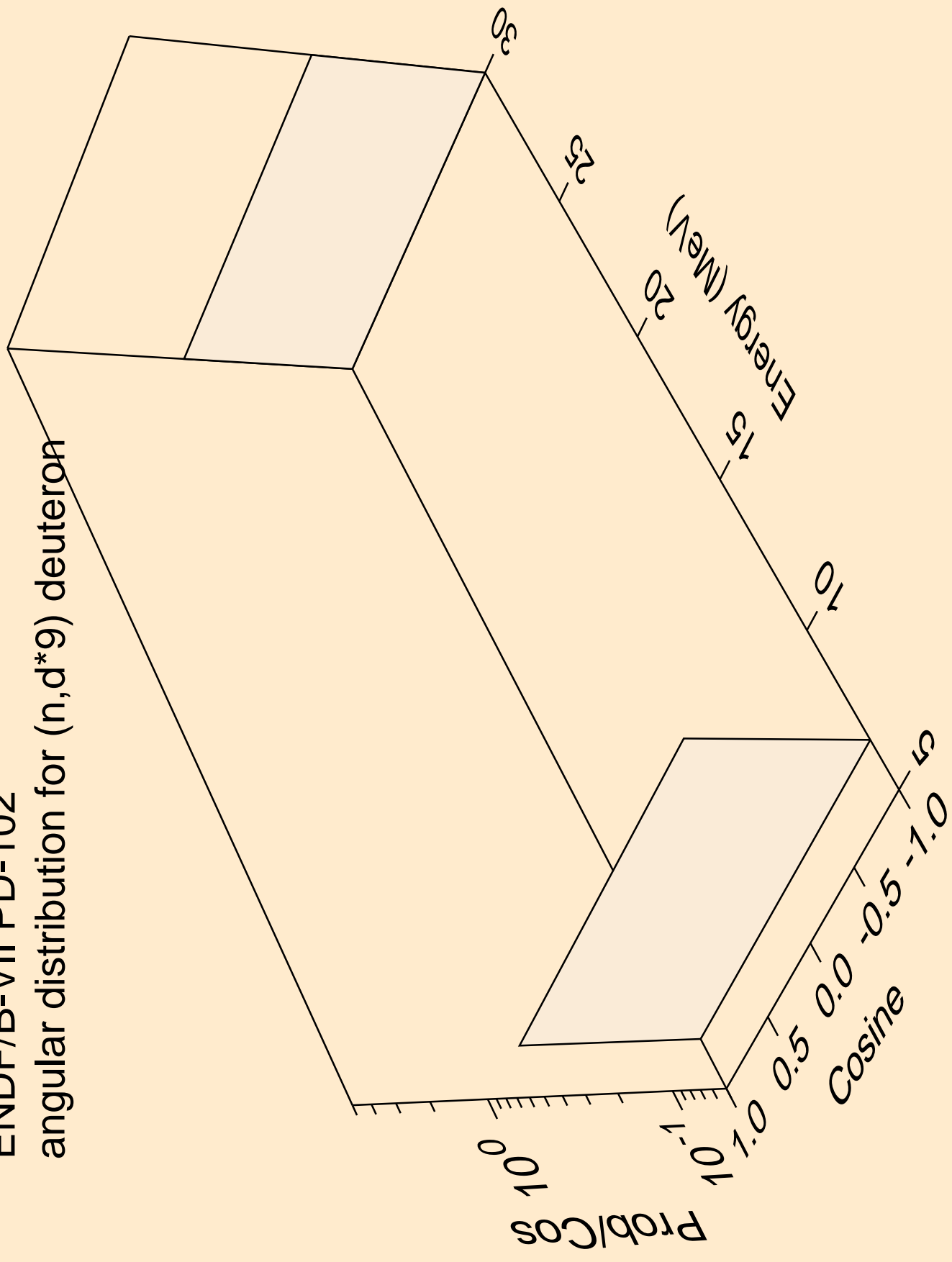

ENDF/B-VII PD-102
angular distribution for (n,d*10) deuteron

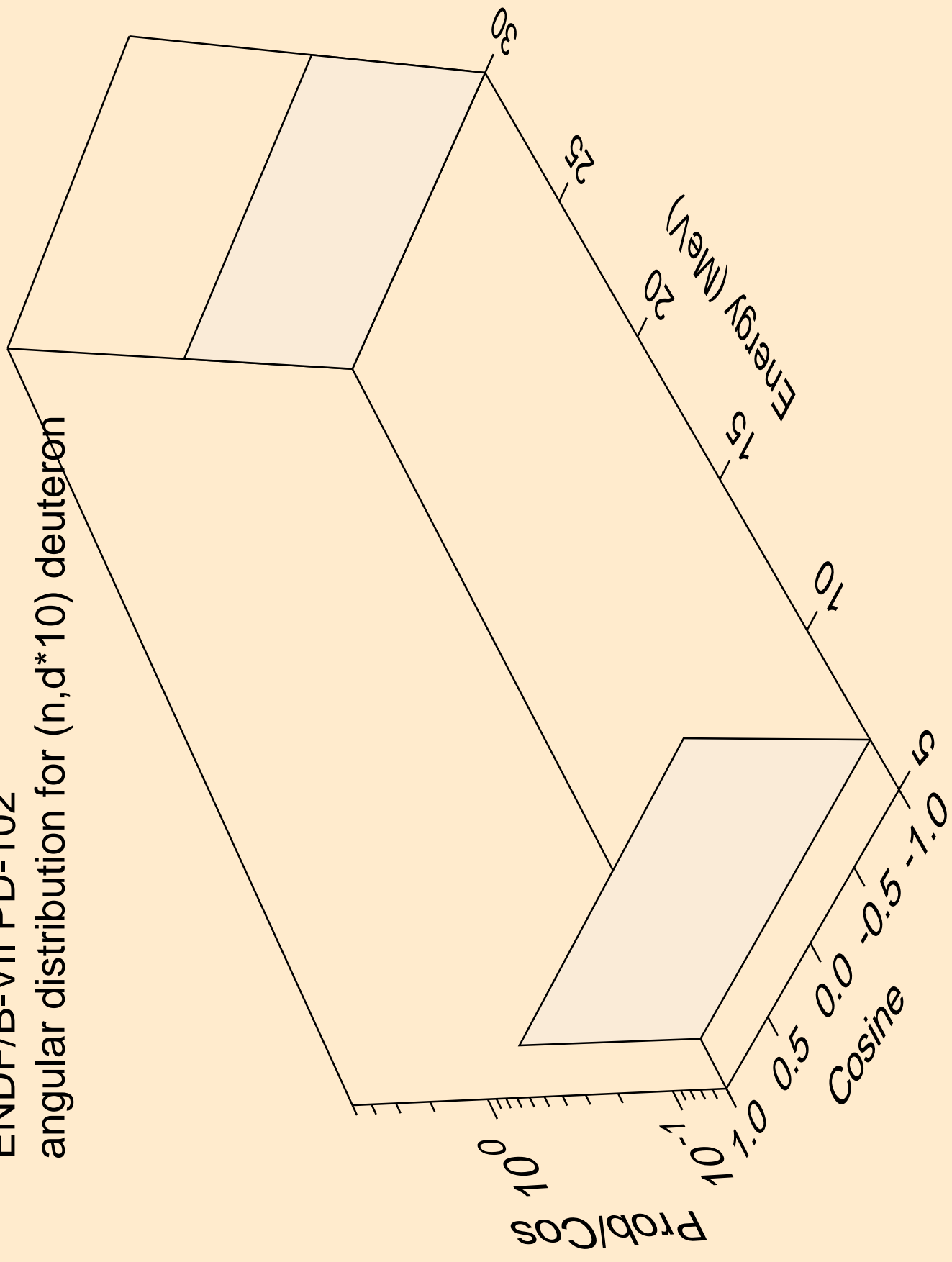

ENDF/B-VII PD-102
angular distribution for (n,d*11) deuteron

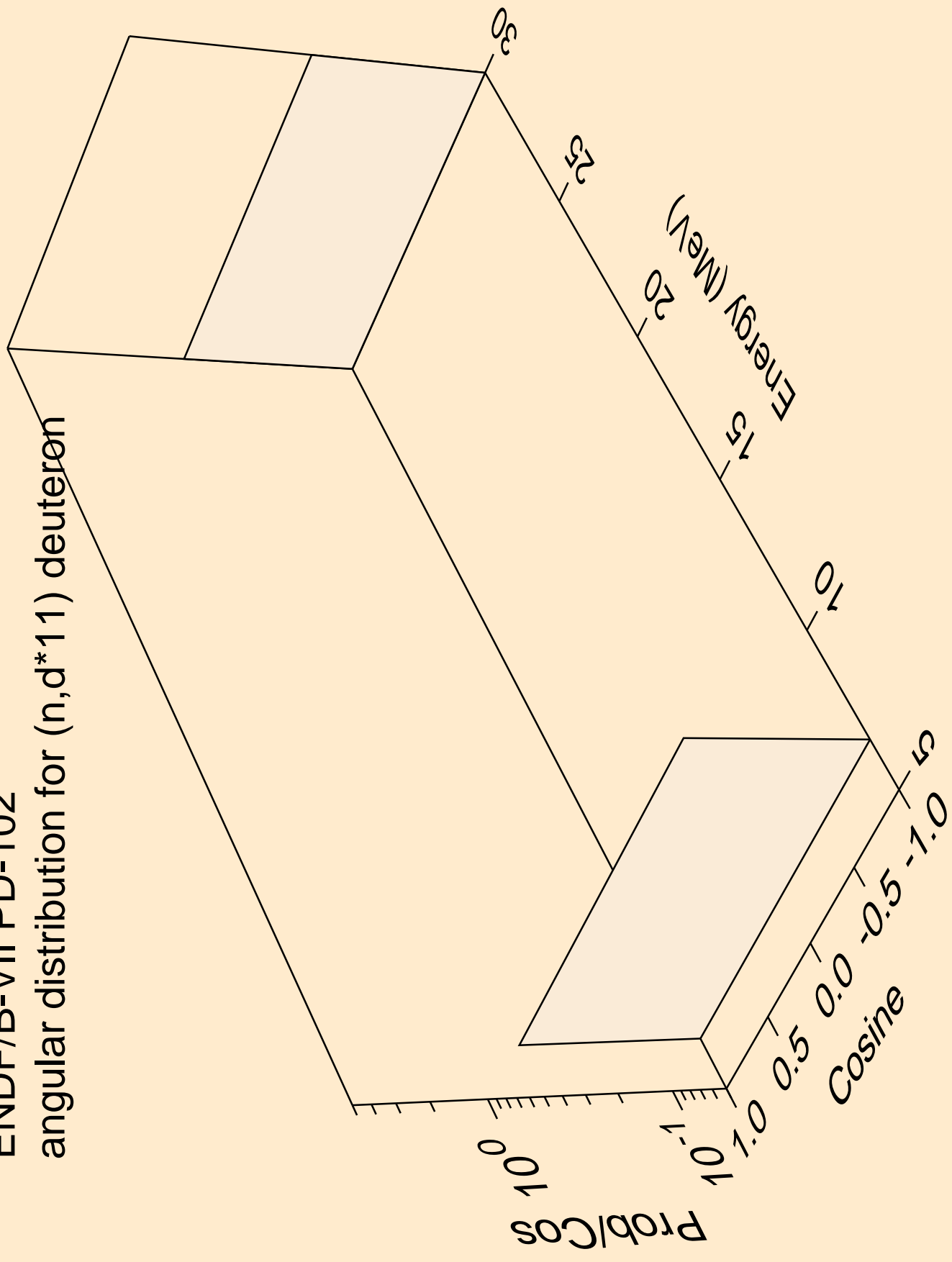

ENDF/B-VII PD-102
angular distribution for (n,d*12) deuteron

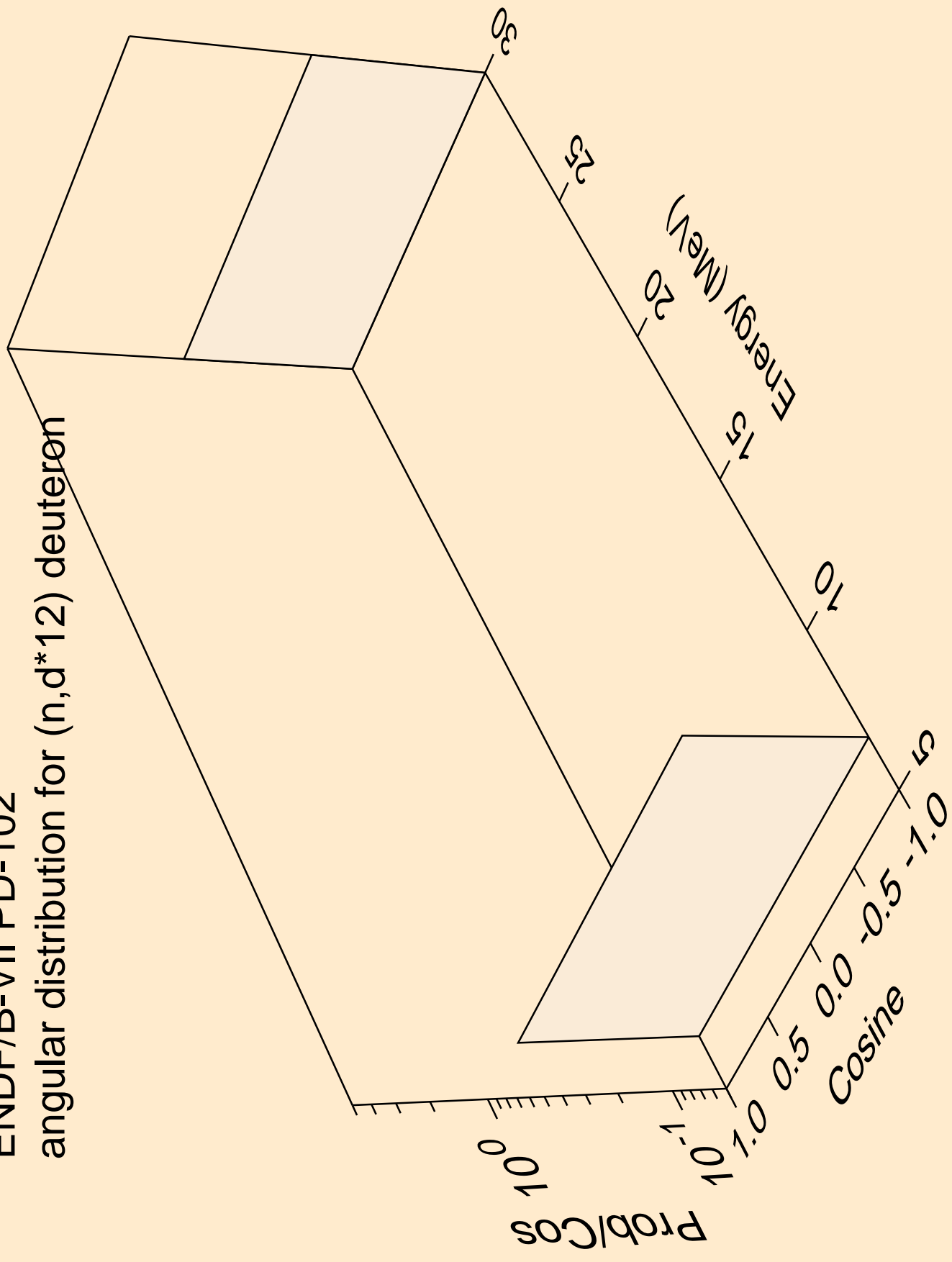

ENDF/B-VII PD-102
angular distribution for (n,d*13) deuteron

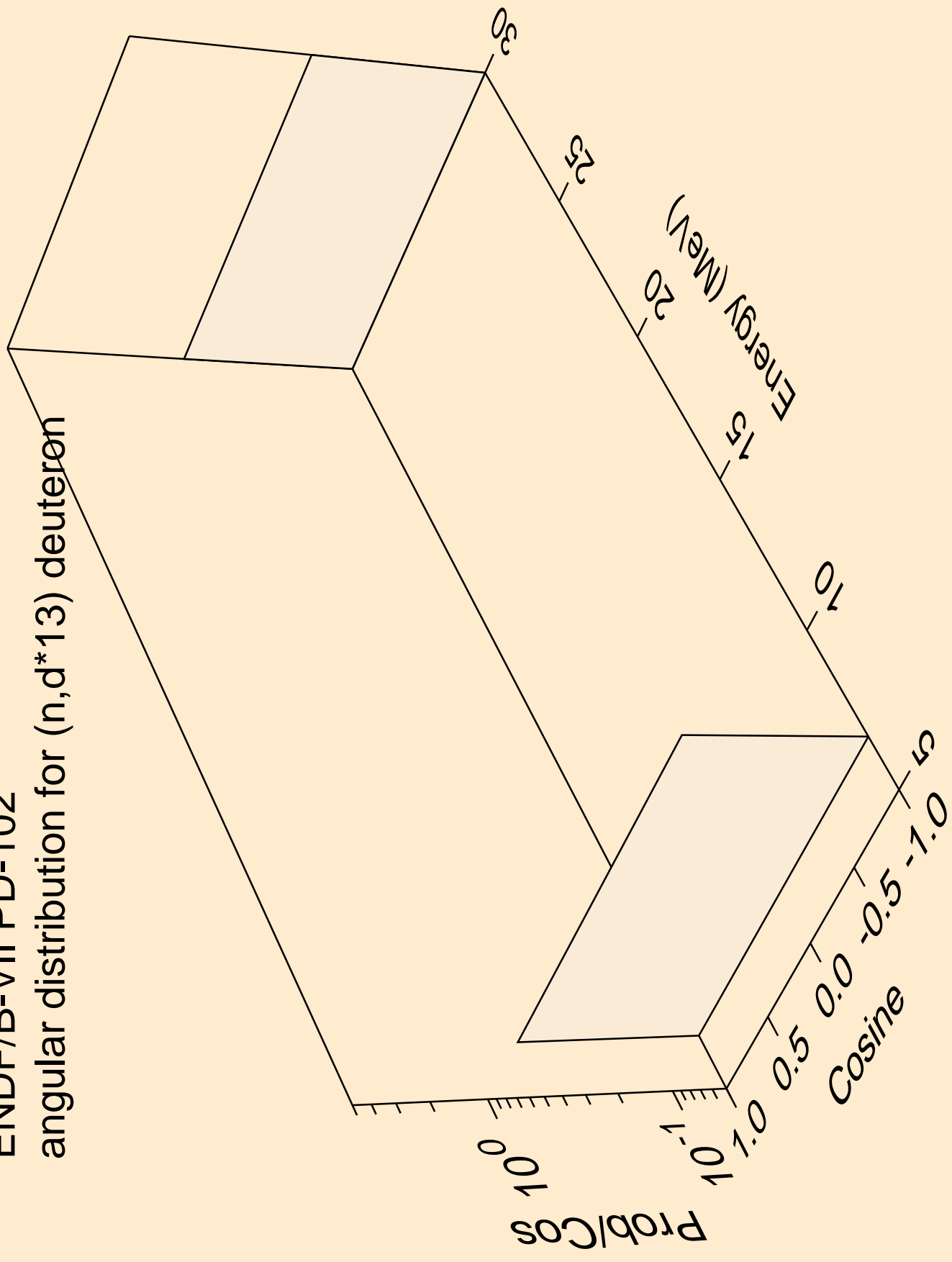

ENDF/B-VII PD-102
angular distribution for (n,d*14) deuteron

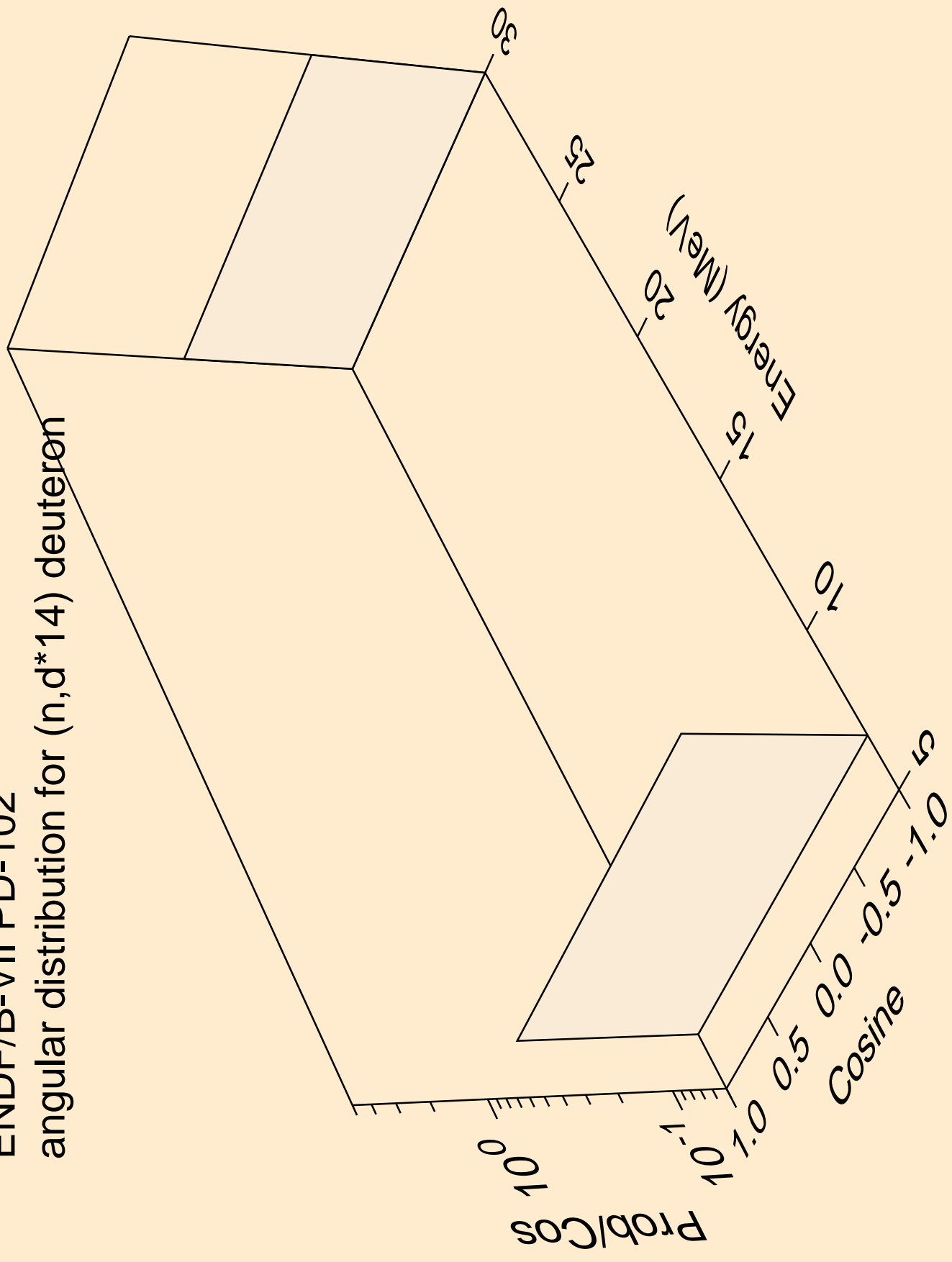

ENDF/B-VII PD-102
angular distribution for (n,d*15) deuteron

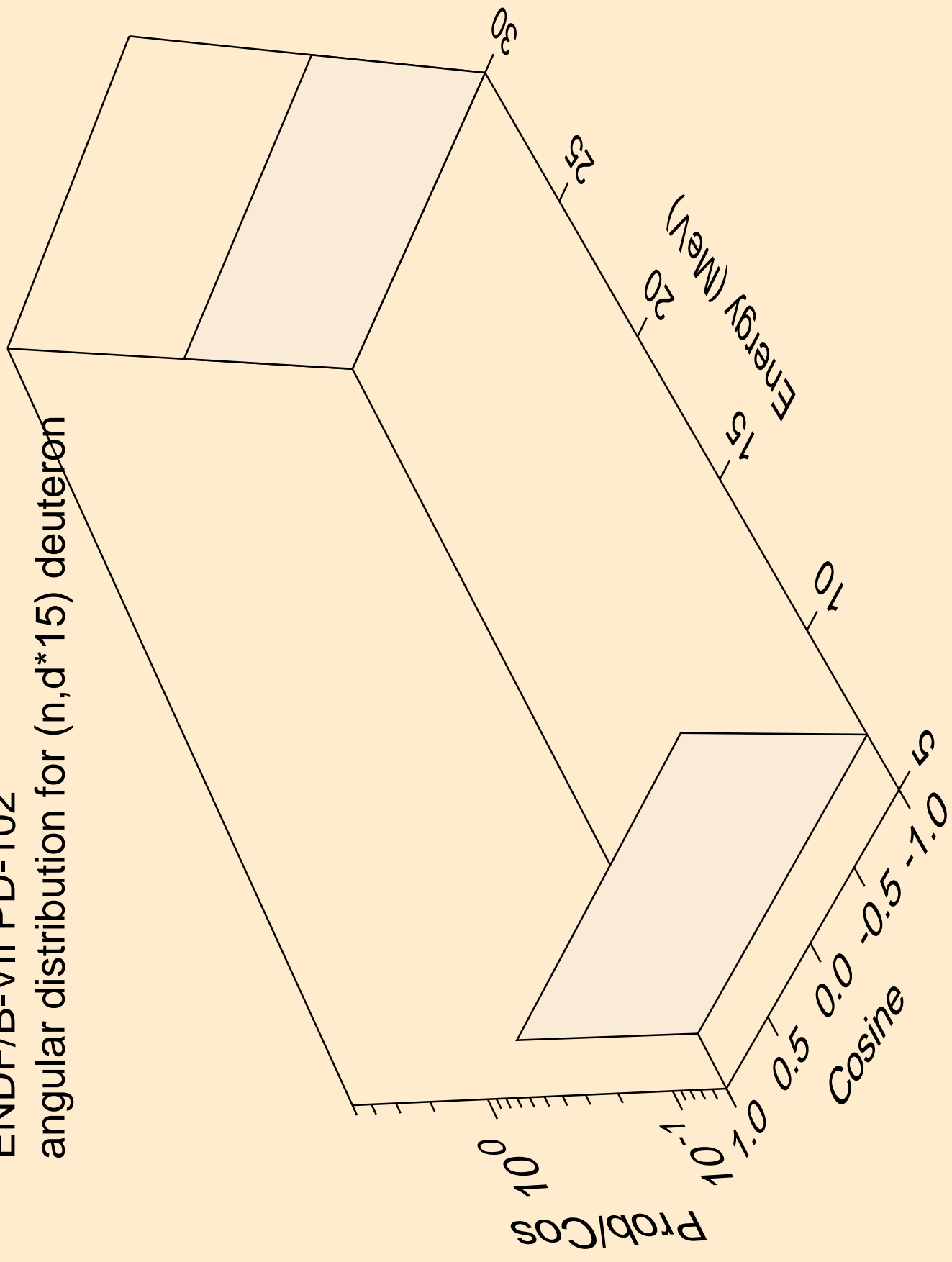

ENDF/B-VII PD-102
angular distribution for (n,d*16) deuteron

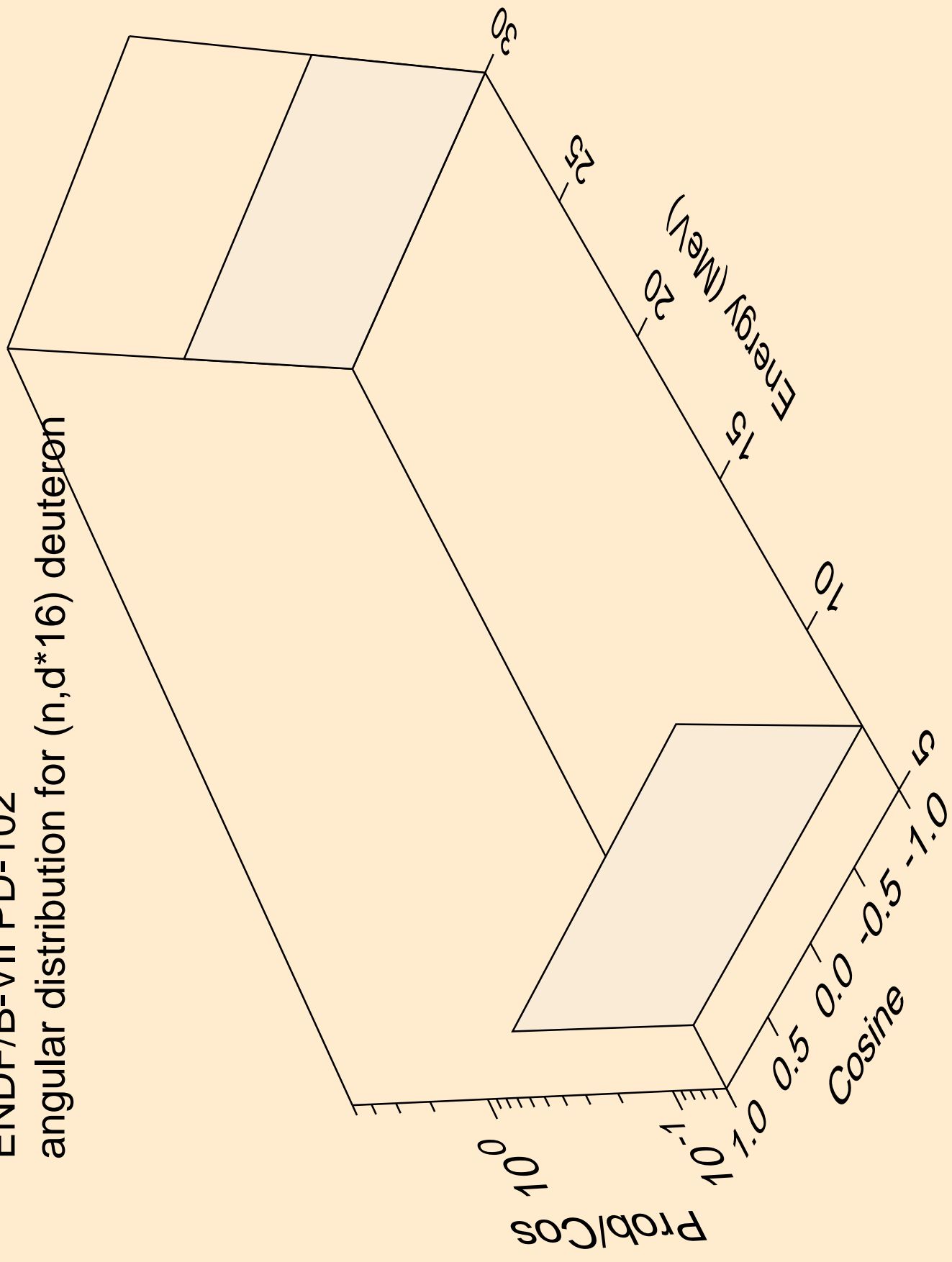

ENDF/B-VII PD-102
angular distribution for (n,d*17) deuteron

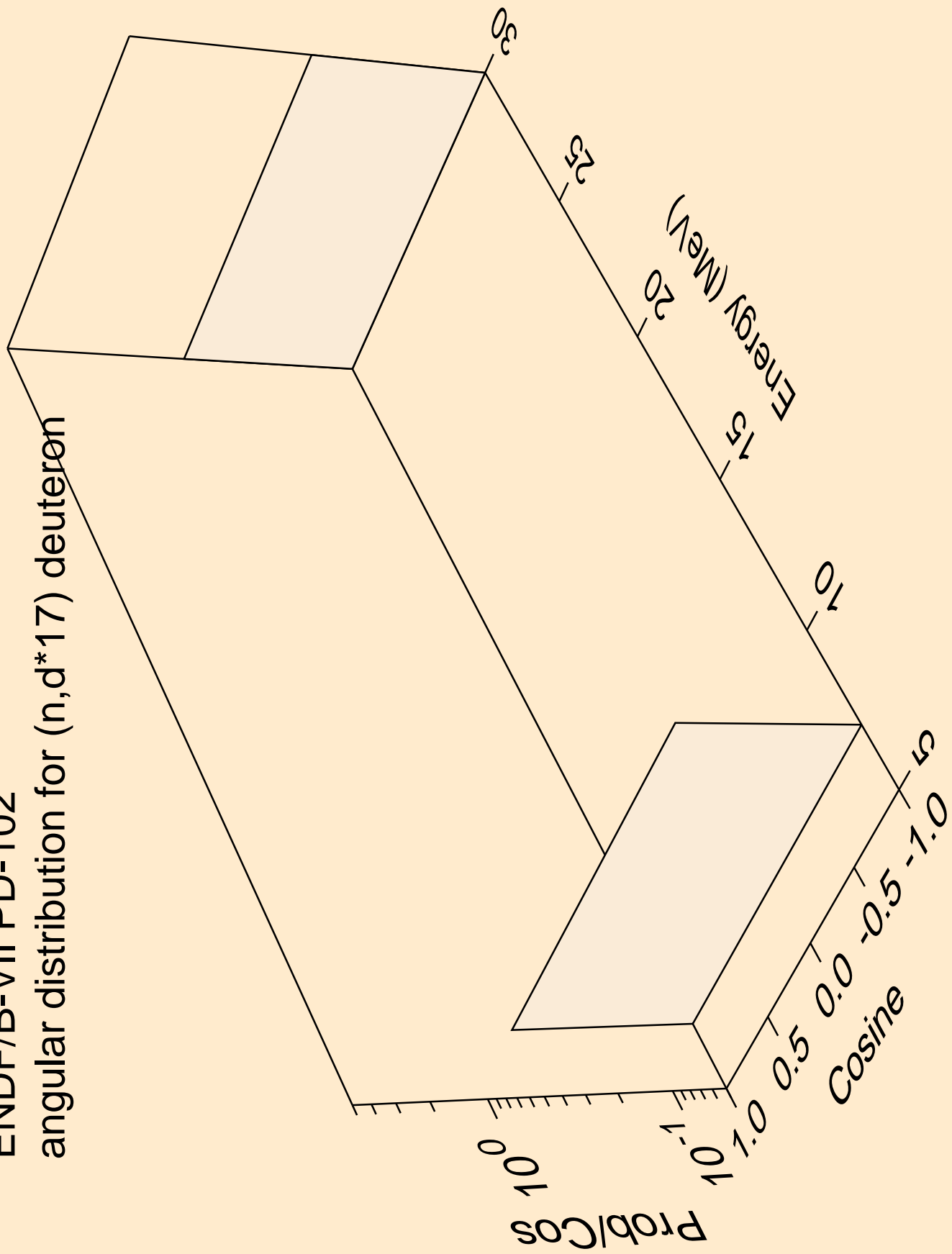

ENDF/B-VII PD-102
angular distribution for (n,d*18) deuteron

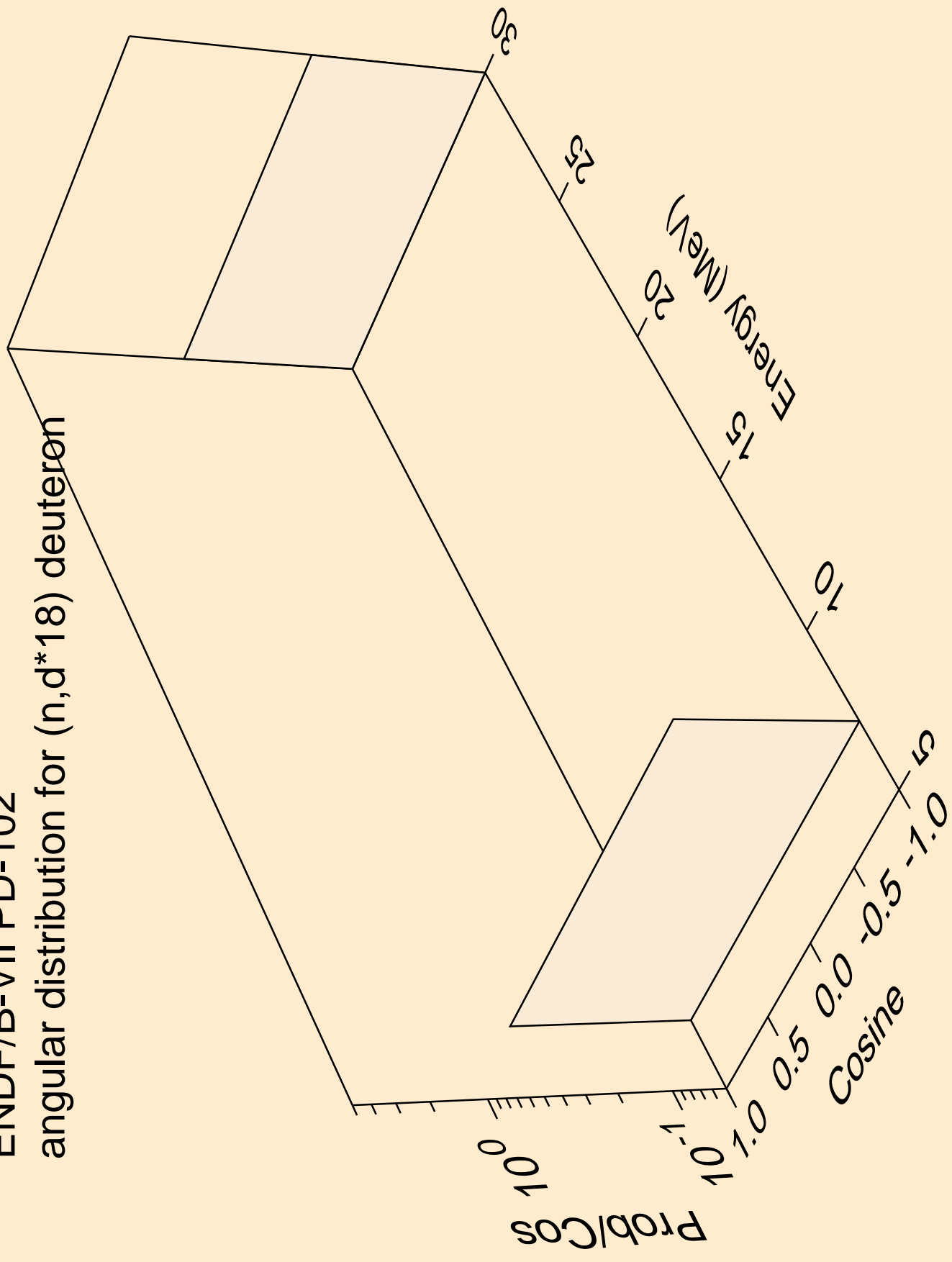

ENDF/B-VII PD-102
angular distribution for (n,d*19) deuteron

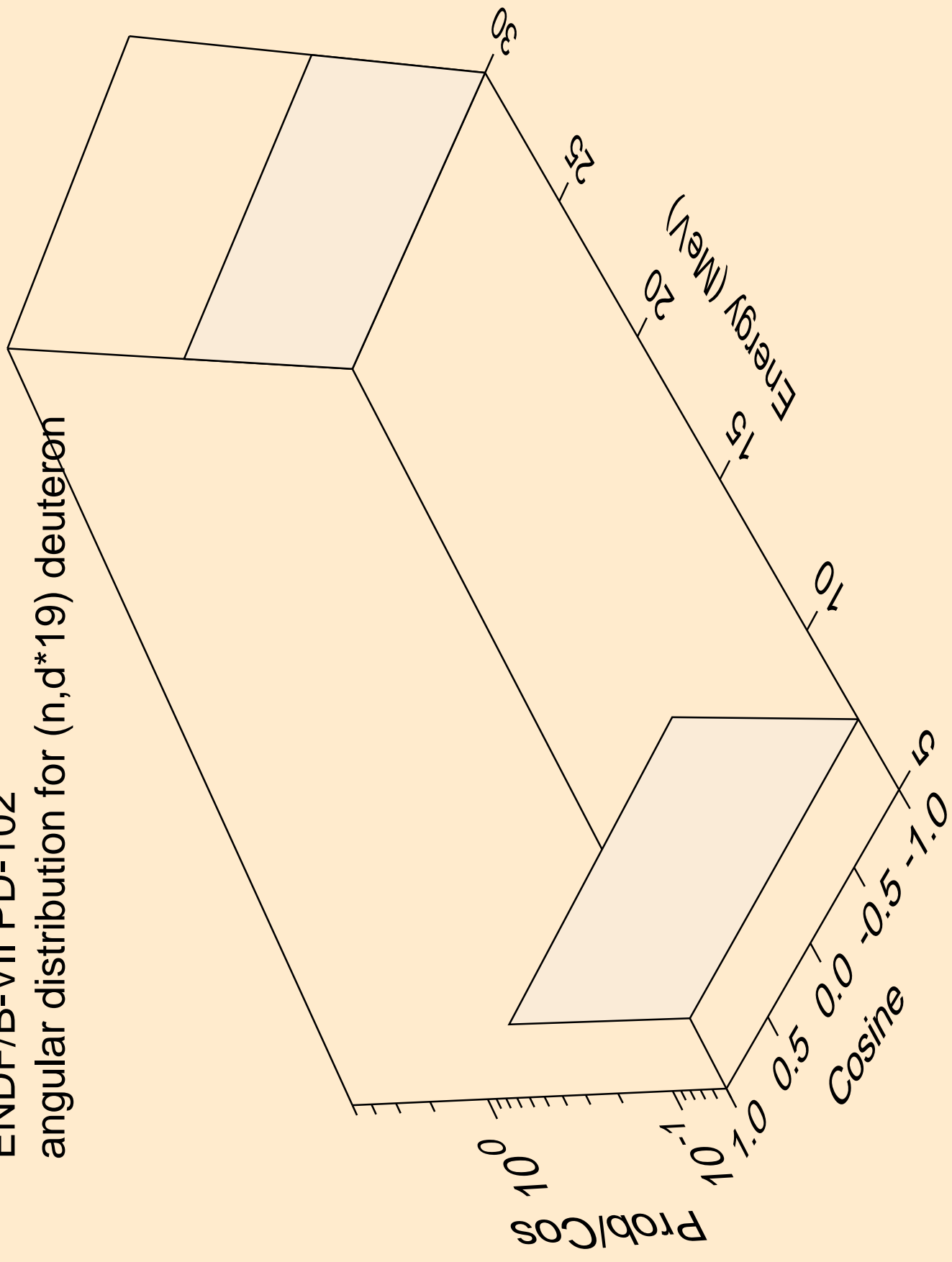

ENDF/B-VII PD-102
deuterons from (n,d*c)

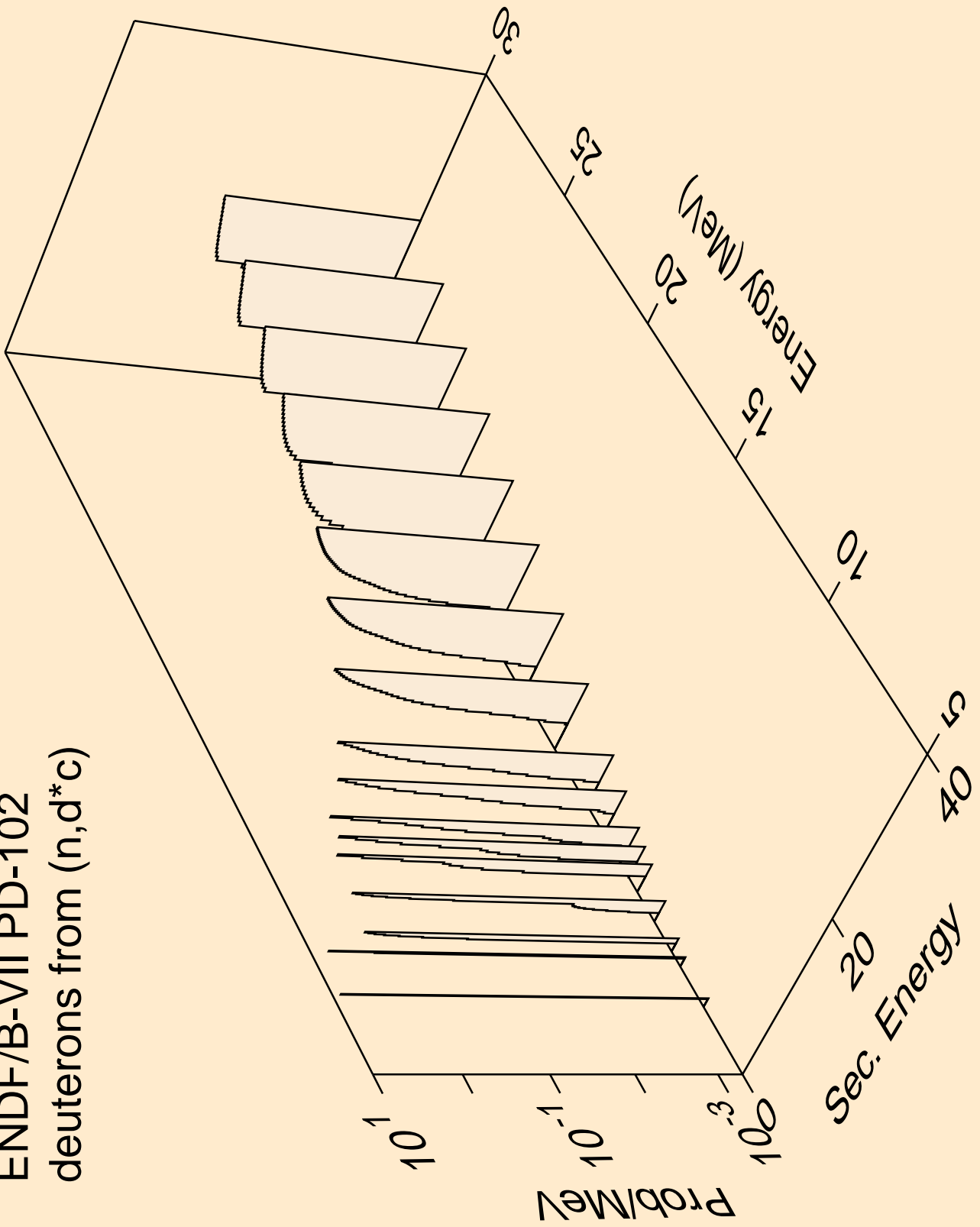

ENDF/B-VII PD-102
alphas from (n,n*)a

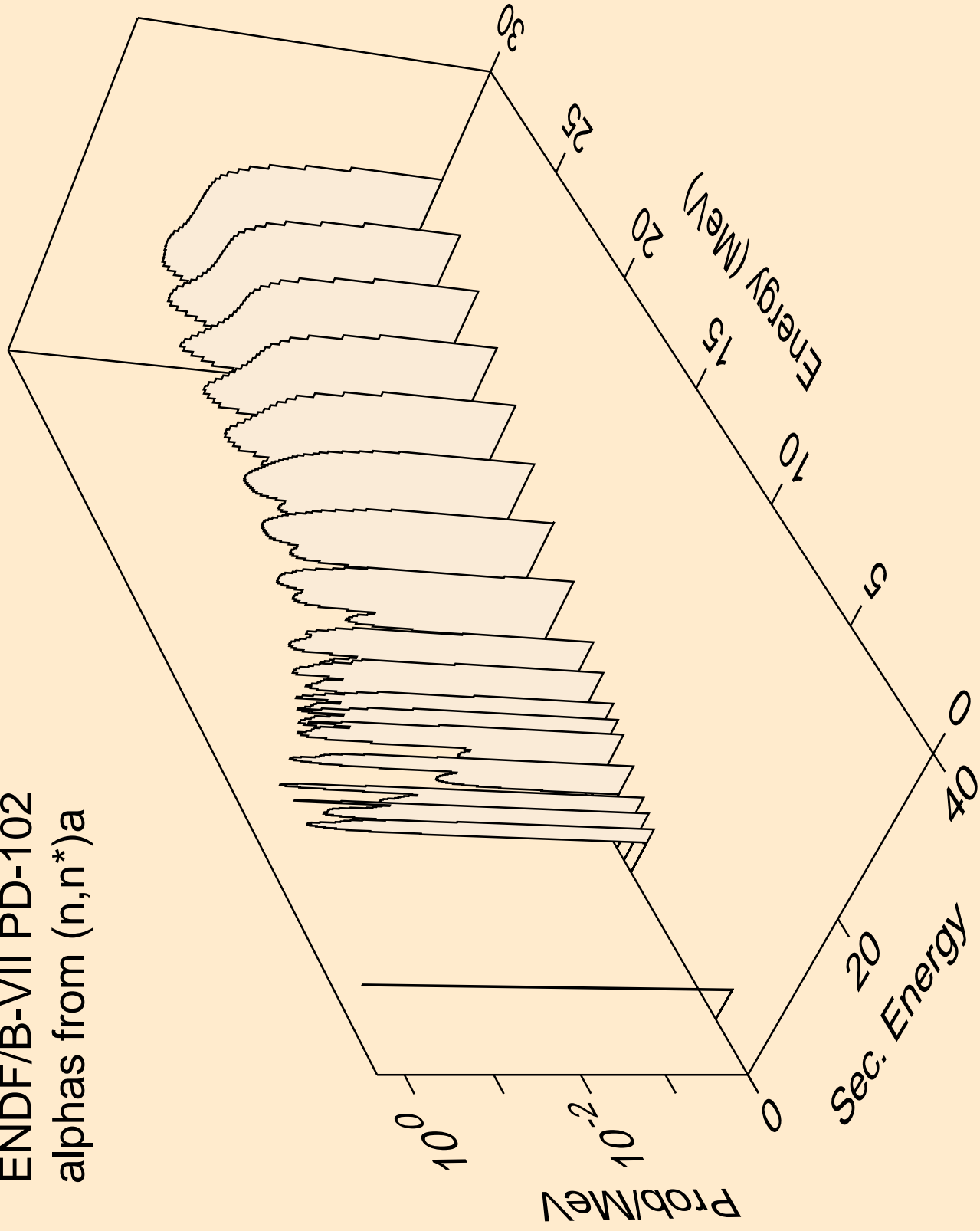

ENDF/B-VII PD-102
alphas from (n,2n)a

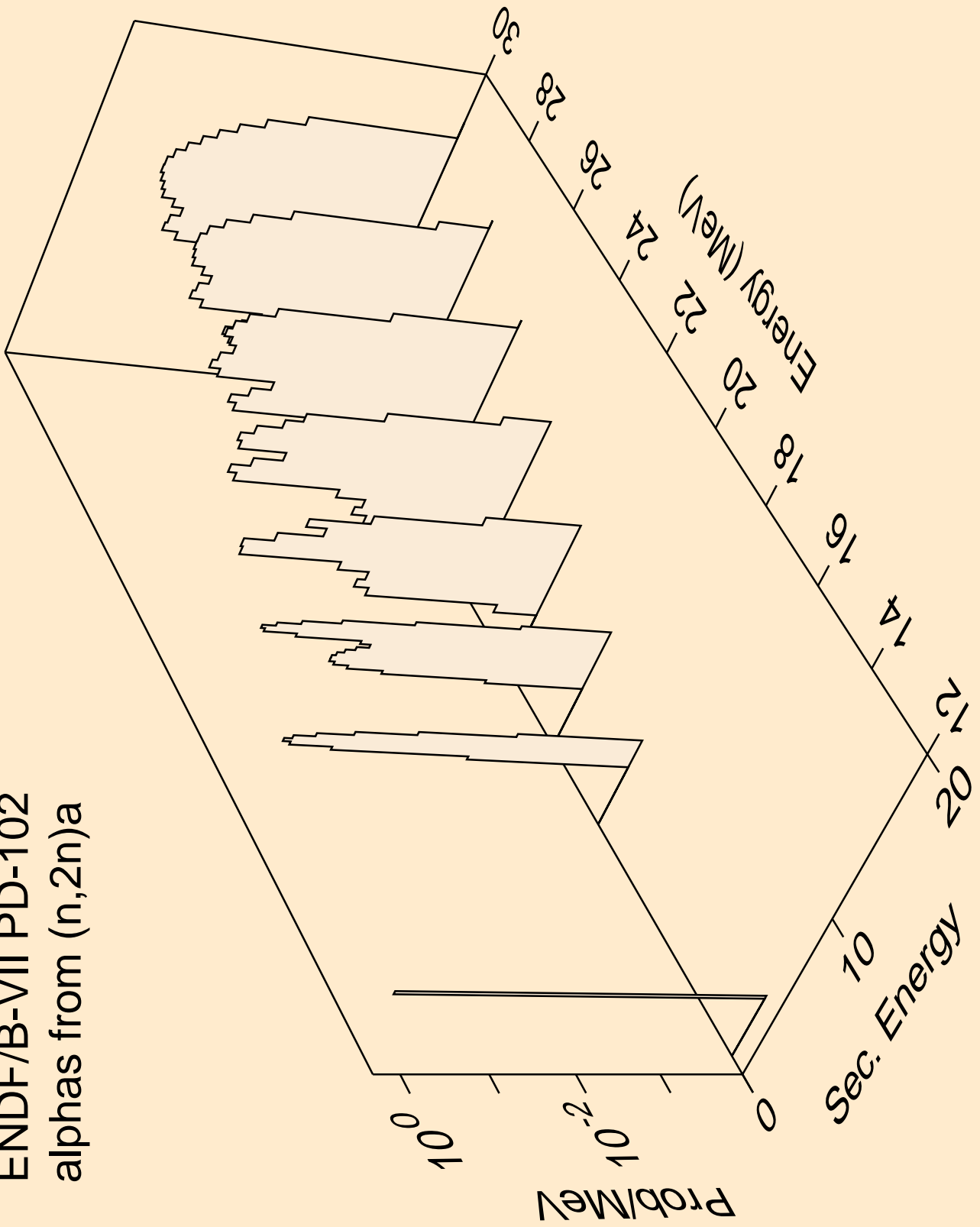

ENDF/B-VII PD-102
angular distribution for (n,a*0) alpha

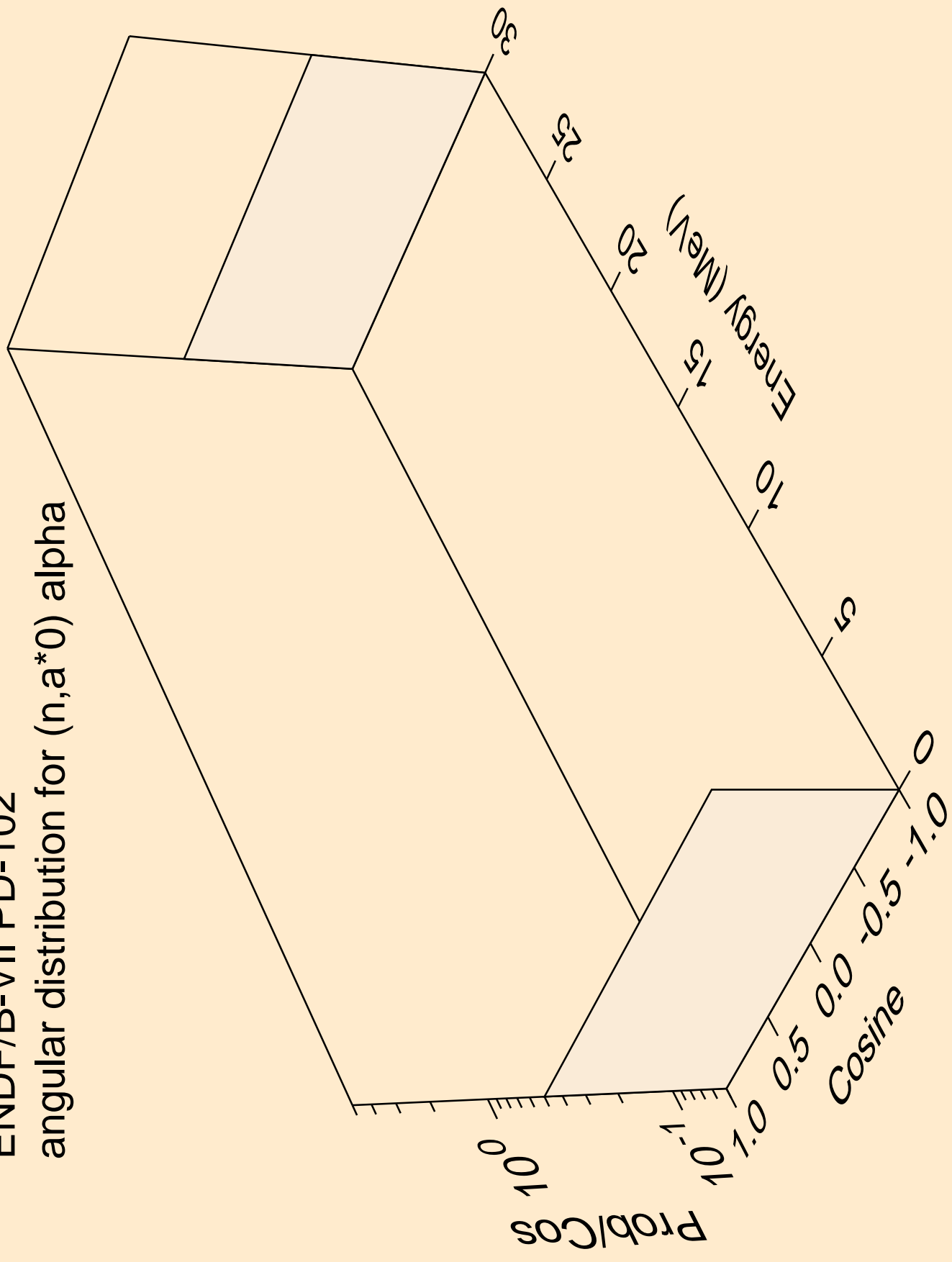

ENDF/B-VII PD-102
angular distribution for (n,a*1) alpha

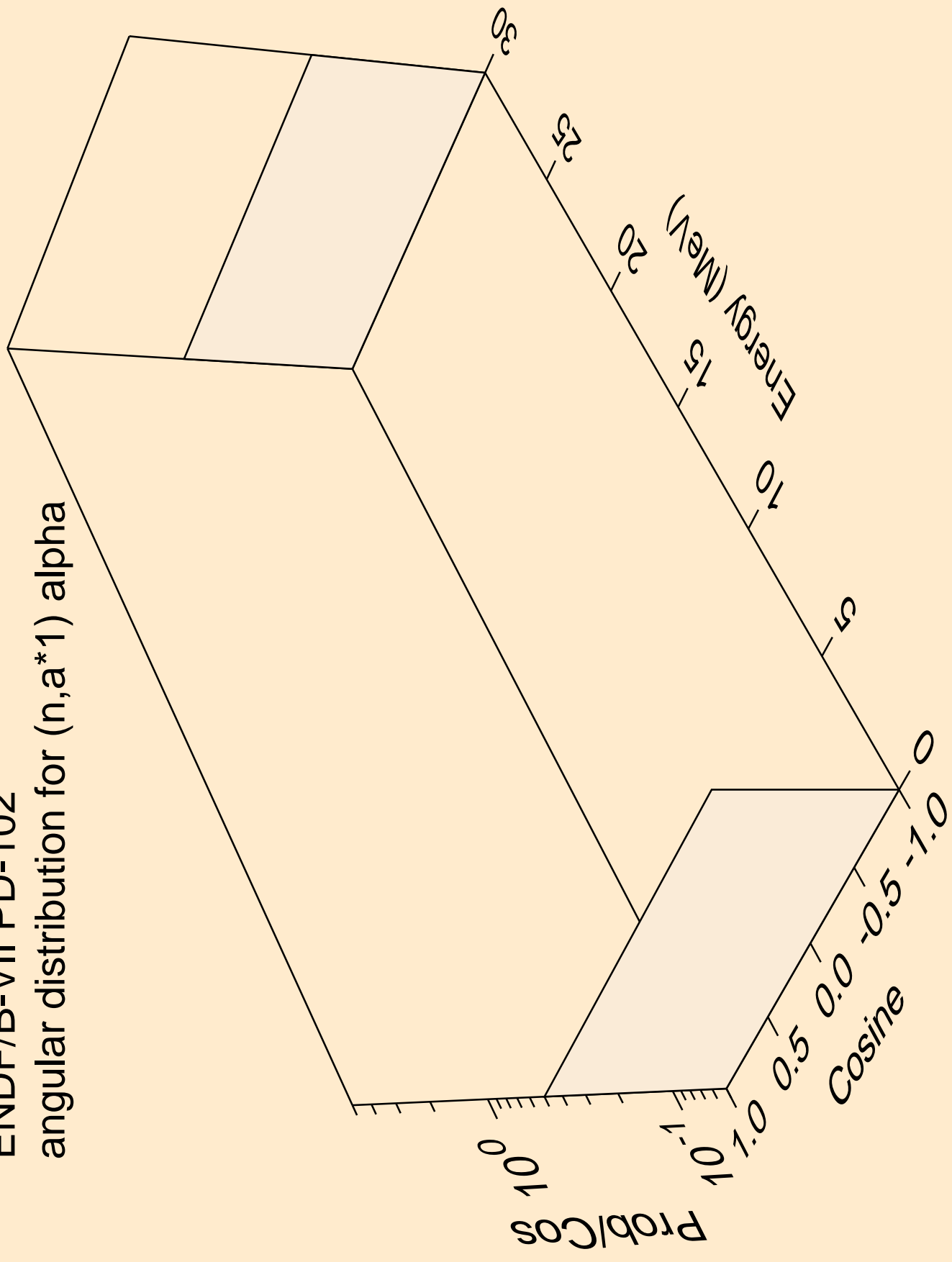

ENDF/B-VII PD-102
angular distribution for (n,a*2) alpha

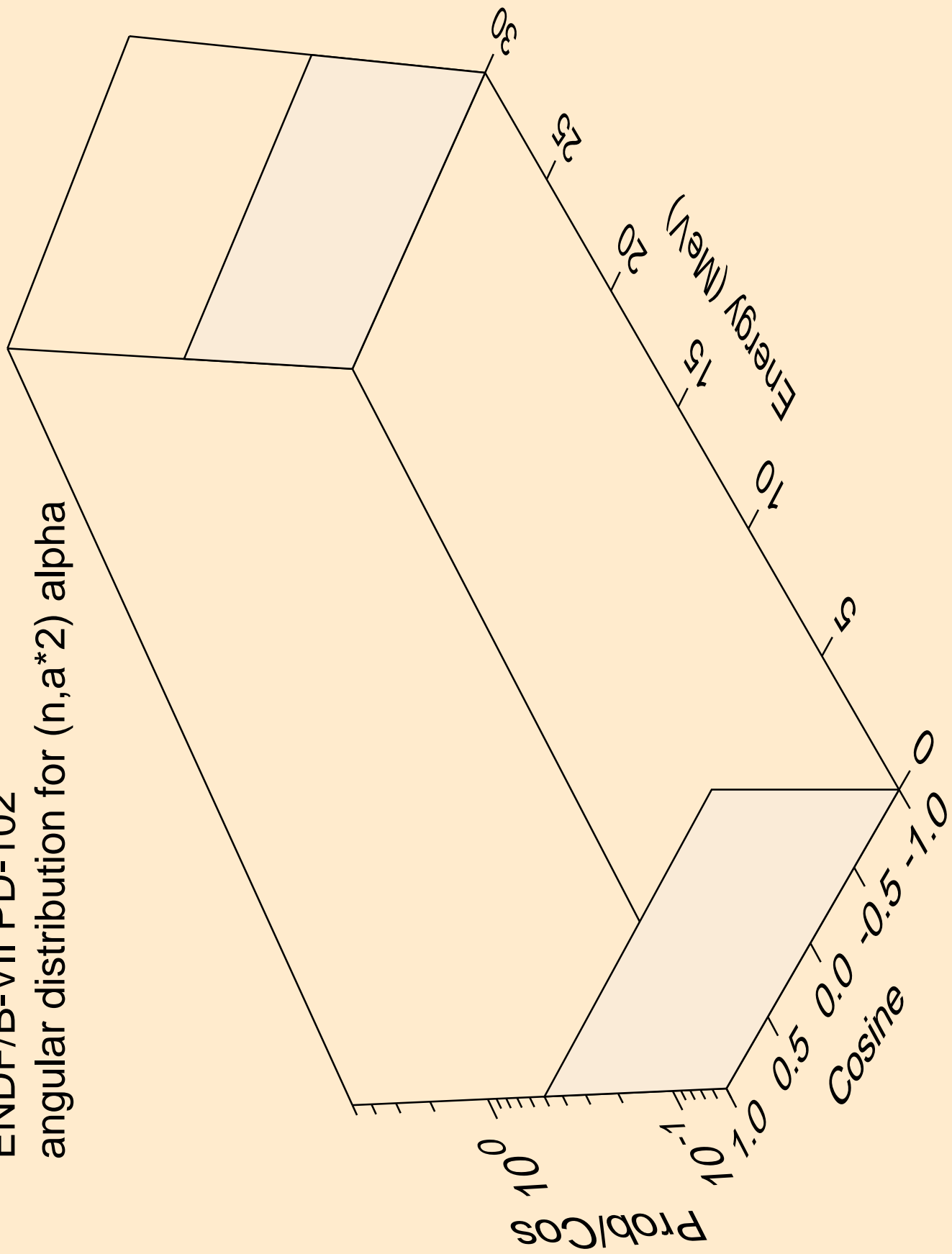

ENDF/B-VII PD-102
angular distribution for (n,a*3) alpha

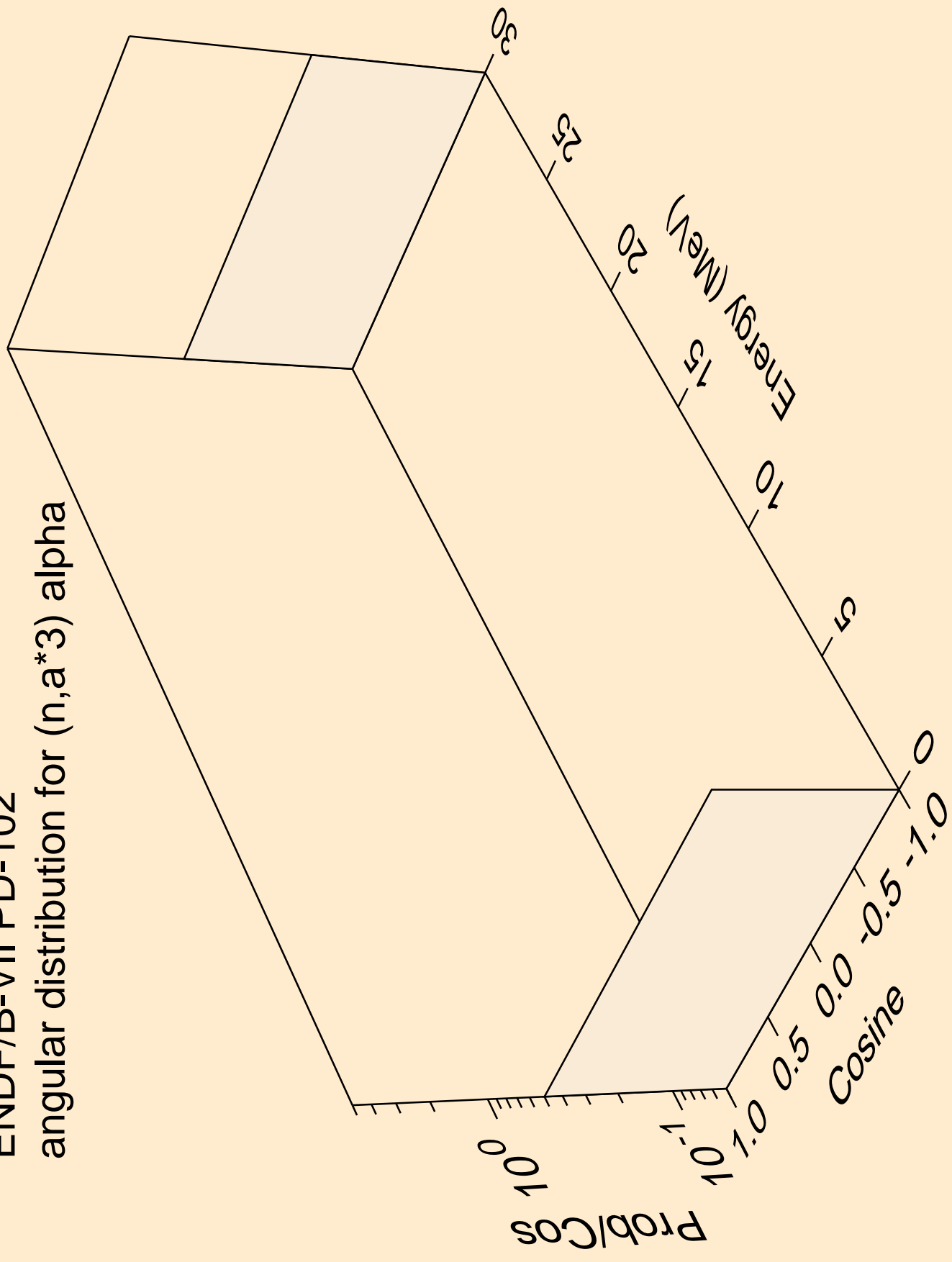

ENDF/B-VII PD-102
angular distribution for (n,a*4) alpha

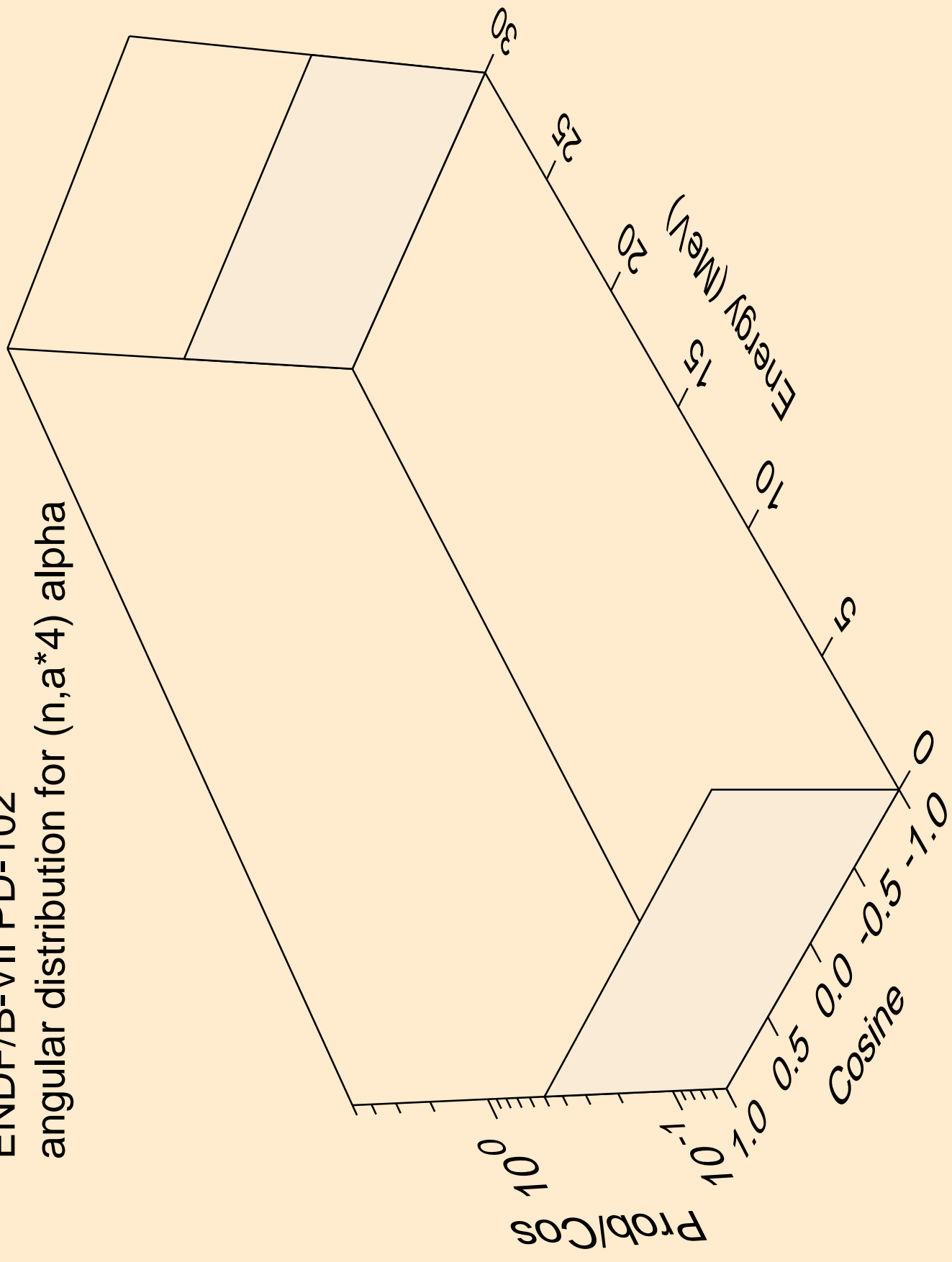

ENDF/B-VII PD-102
angular distribution for (n,a*5) alpha

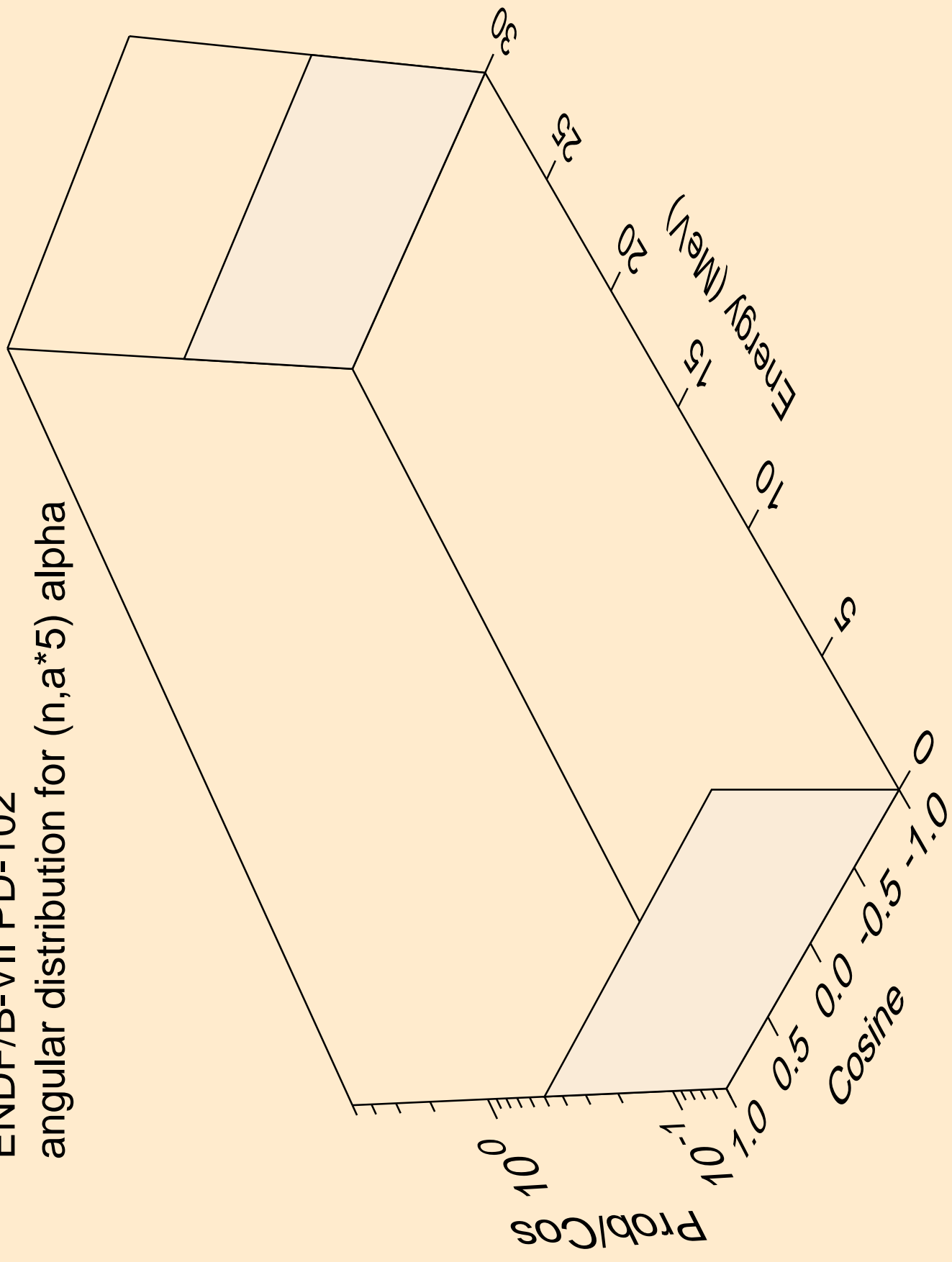

ENDF/B-VII PD-102
angular distribution for (n,a*6) alpha

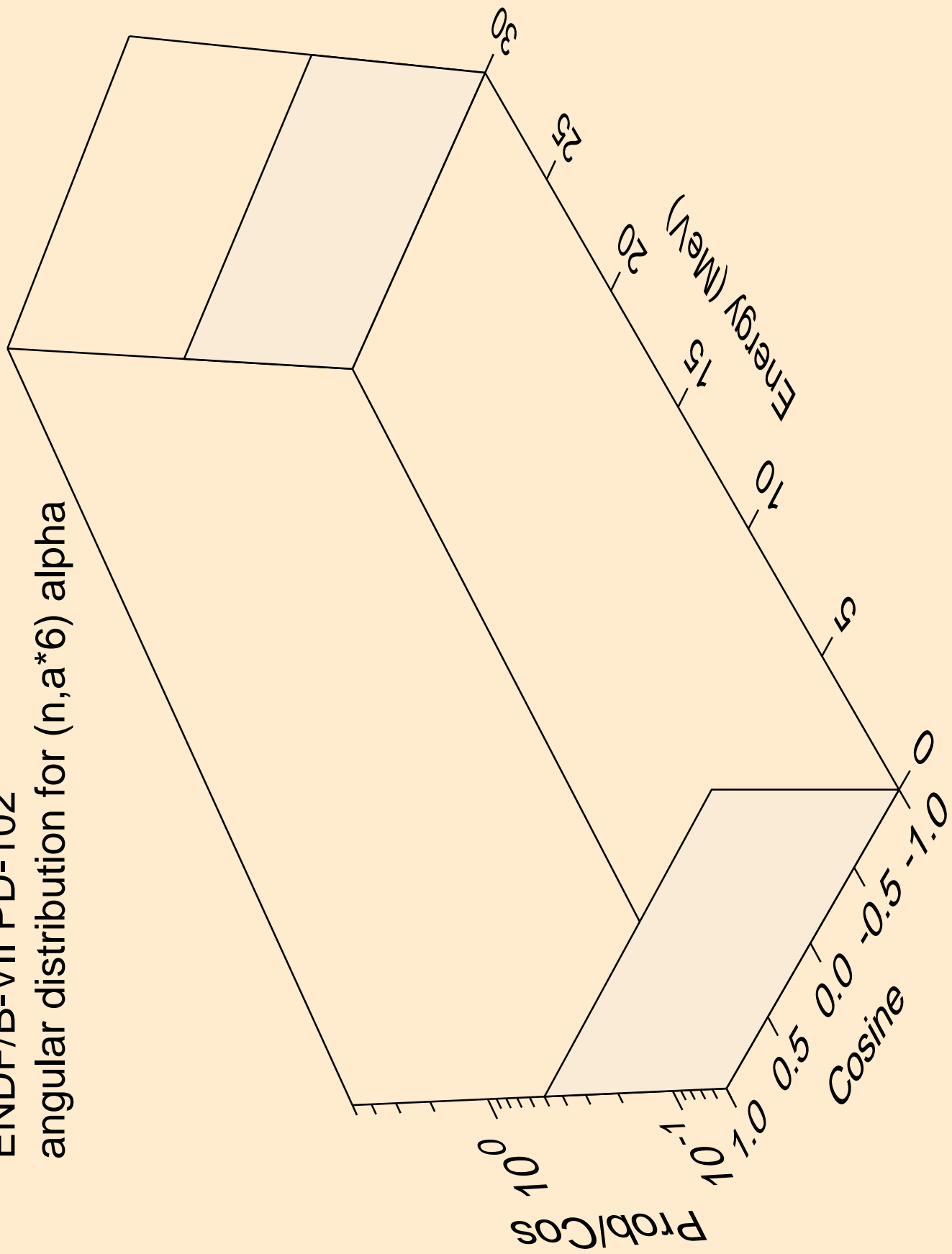

ENDF/B-VII PD-102
angular distribution for (n,a*7) alpha

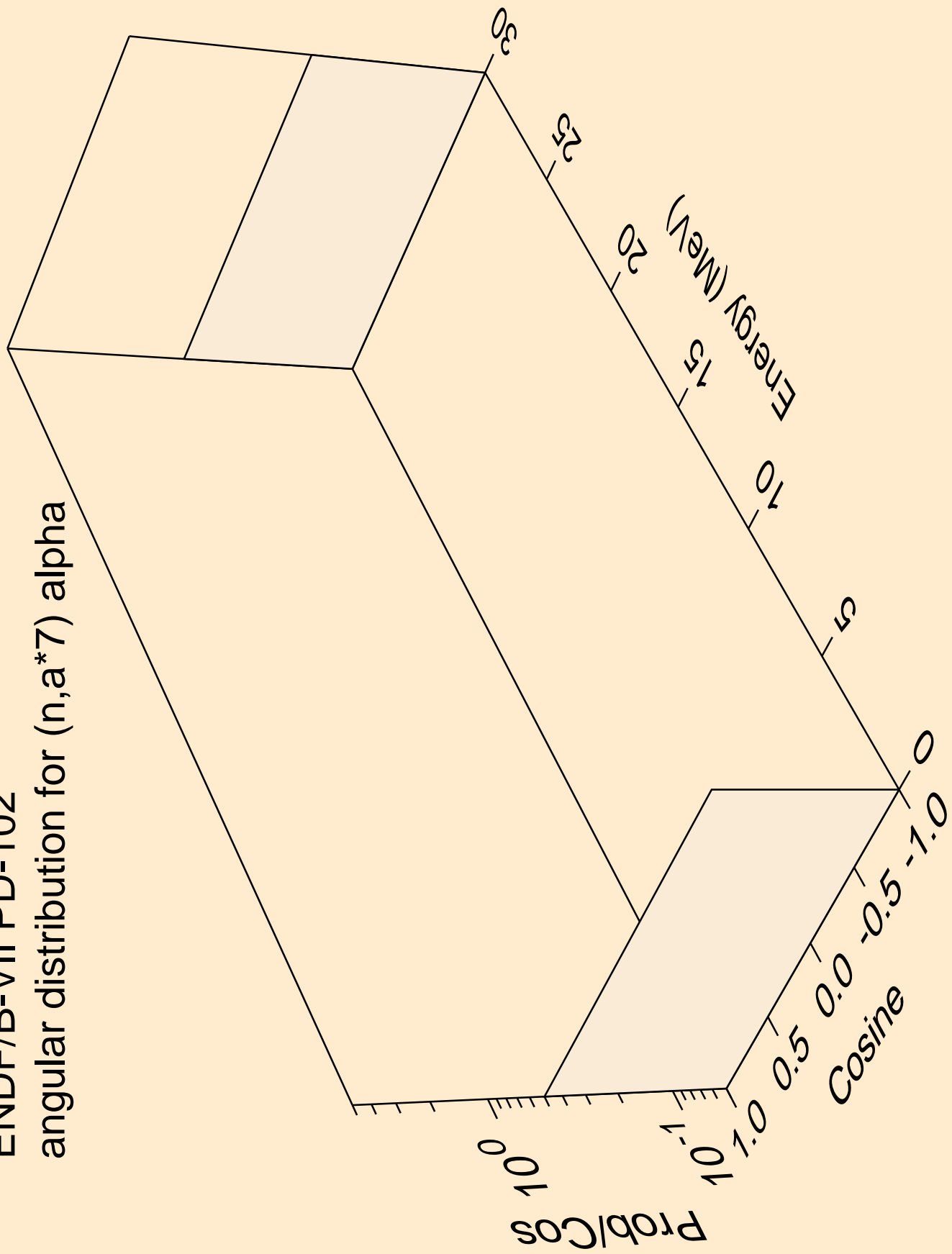

ENDF/B-VII PD-102
angular distribution for (n,a*8) alpha

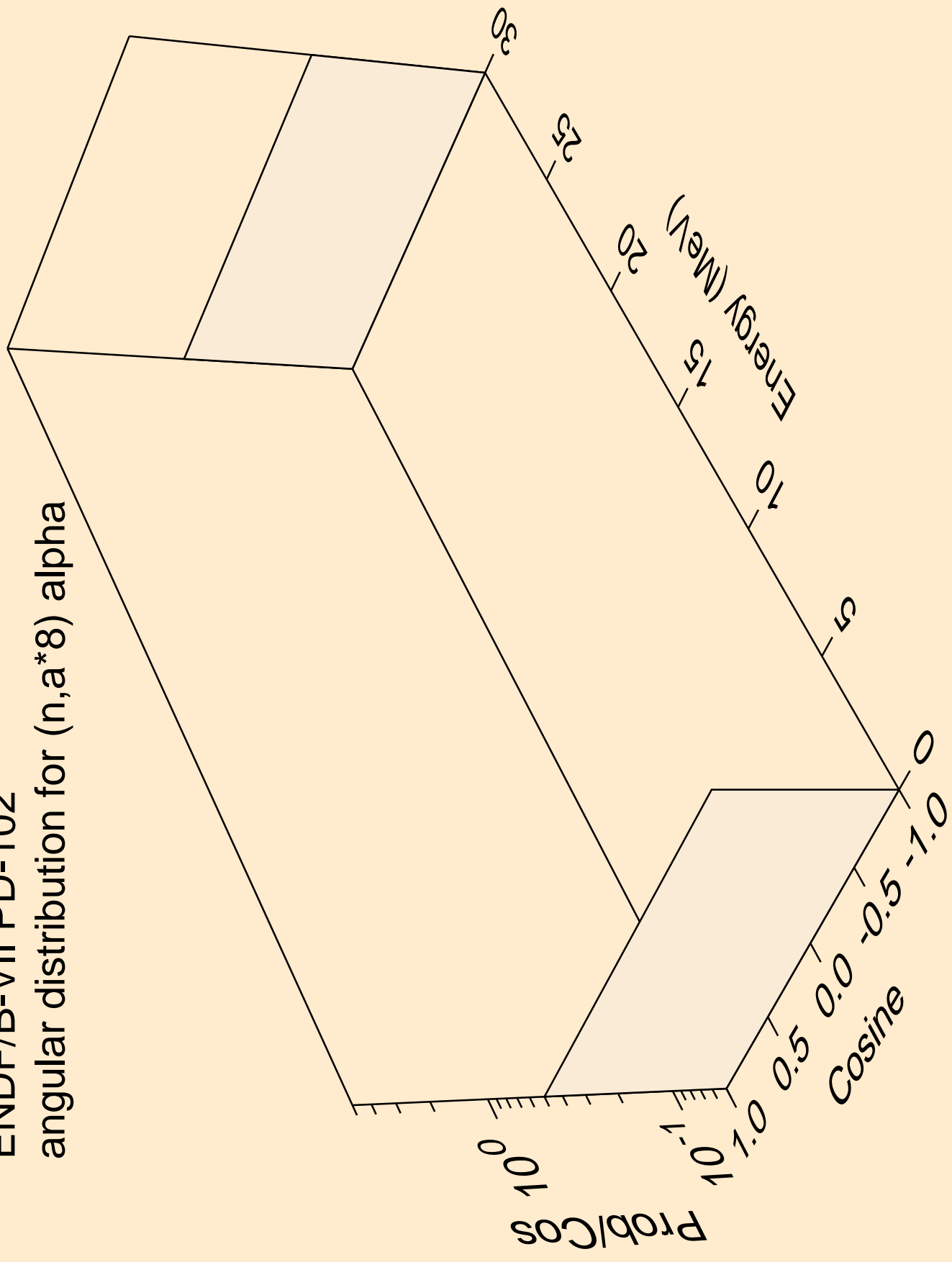

ENDF/B-VII PD-102
angular distribution for (n,a*9) alpha

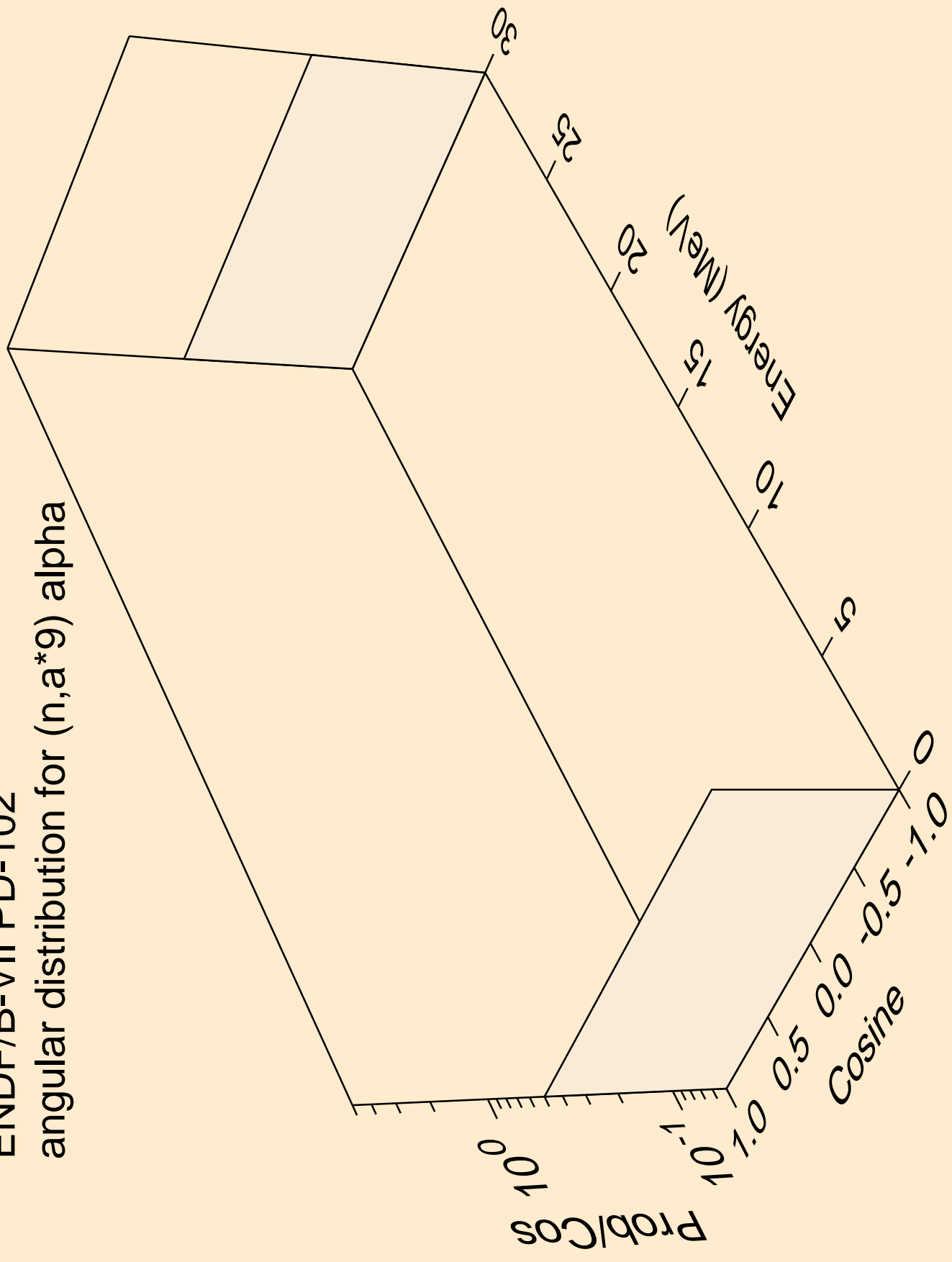

ENDF/B-VII PD-102
angular distribution for (n,a*10) alpha

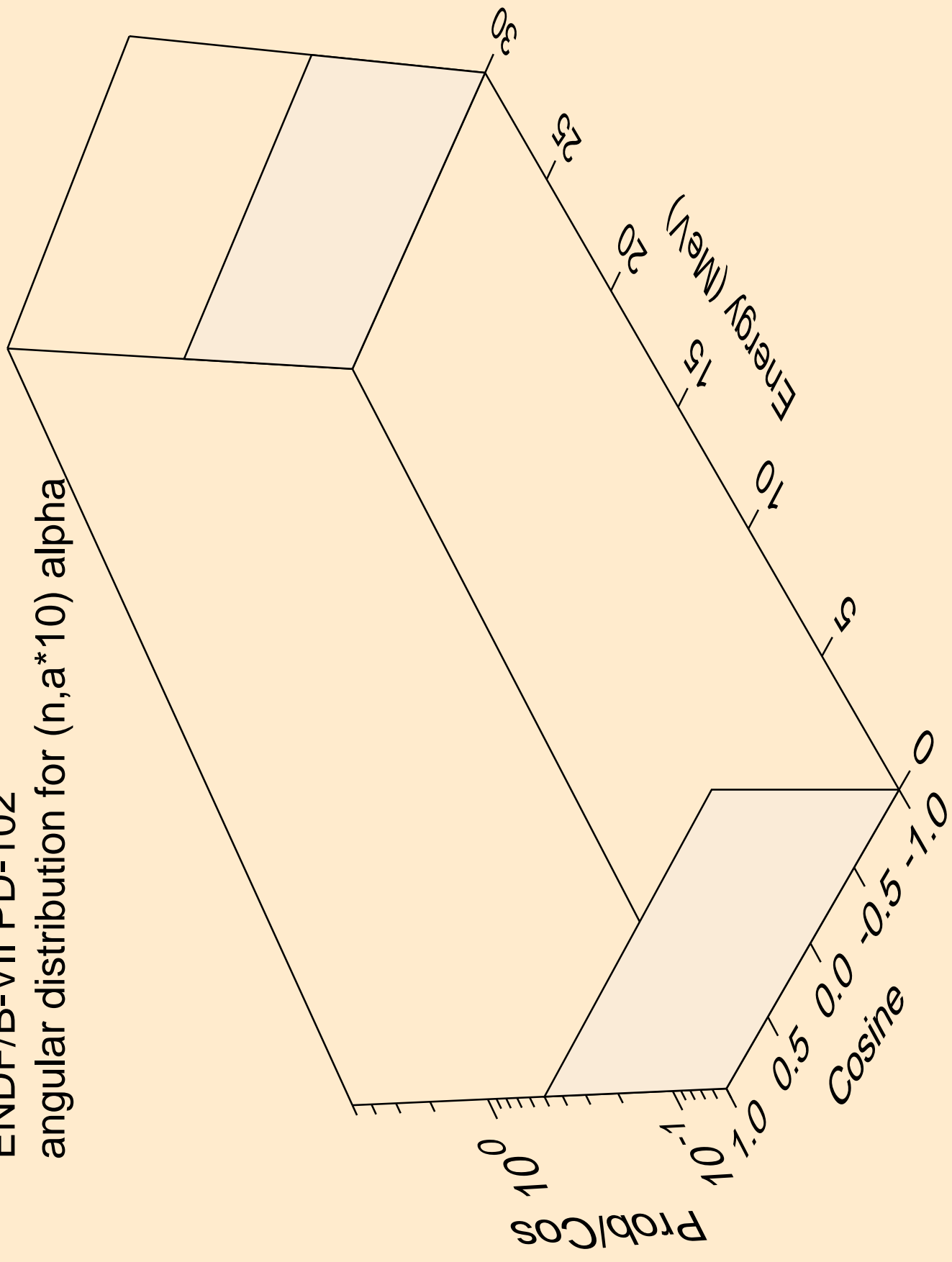

ENDF/B-VII PD-102
angular distribution for (n,a*11) alpha

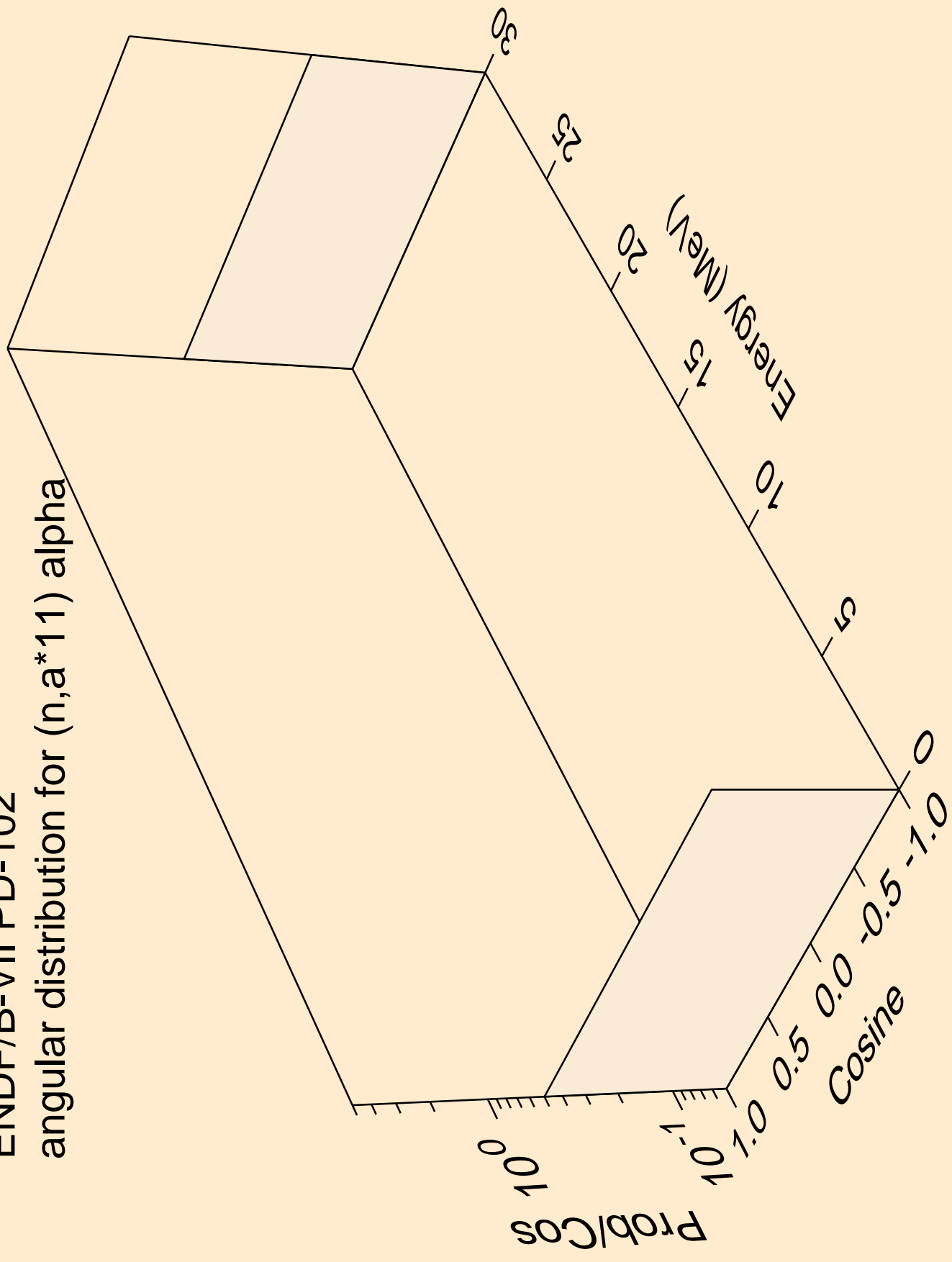

ENDF/B-VII PD-102
angular distribution for (n,a*12) alpha

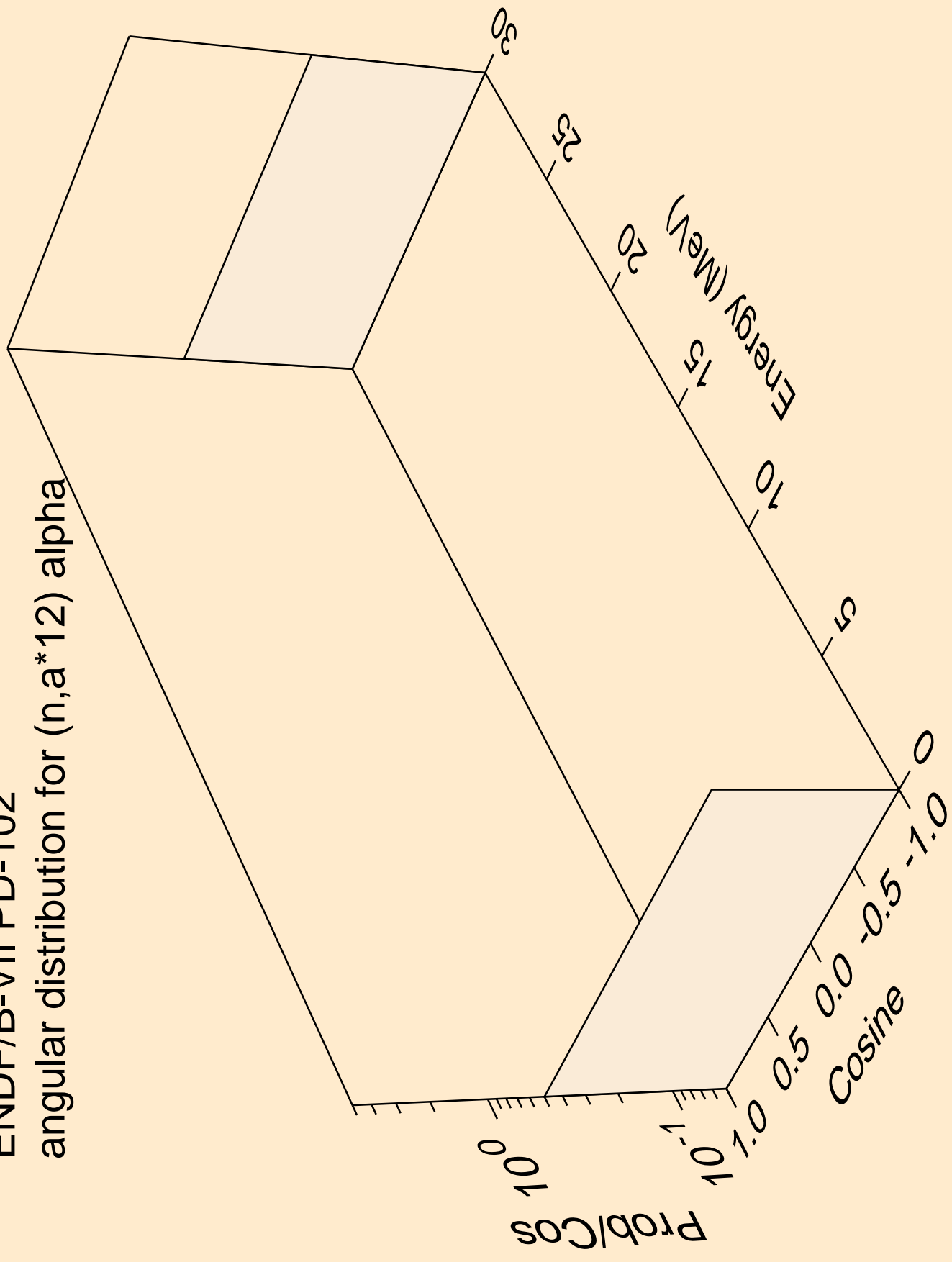

ENDF/B-VII PD-102
angular distribution for (n,a*13) alpha

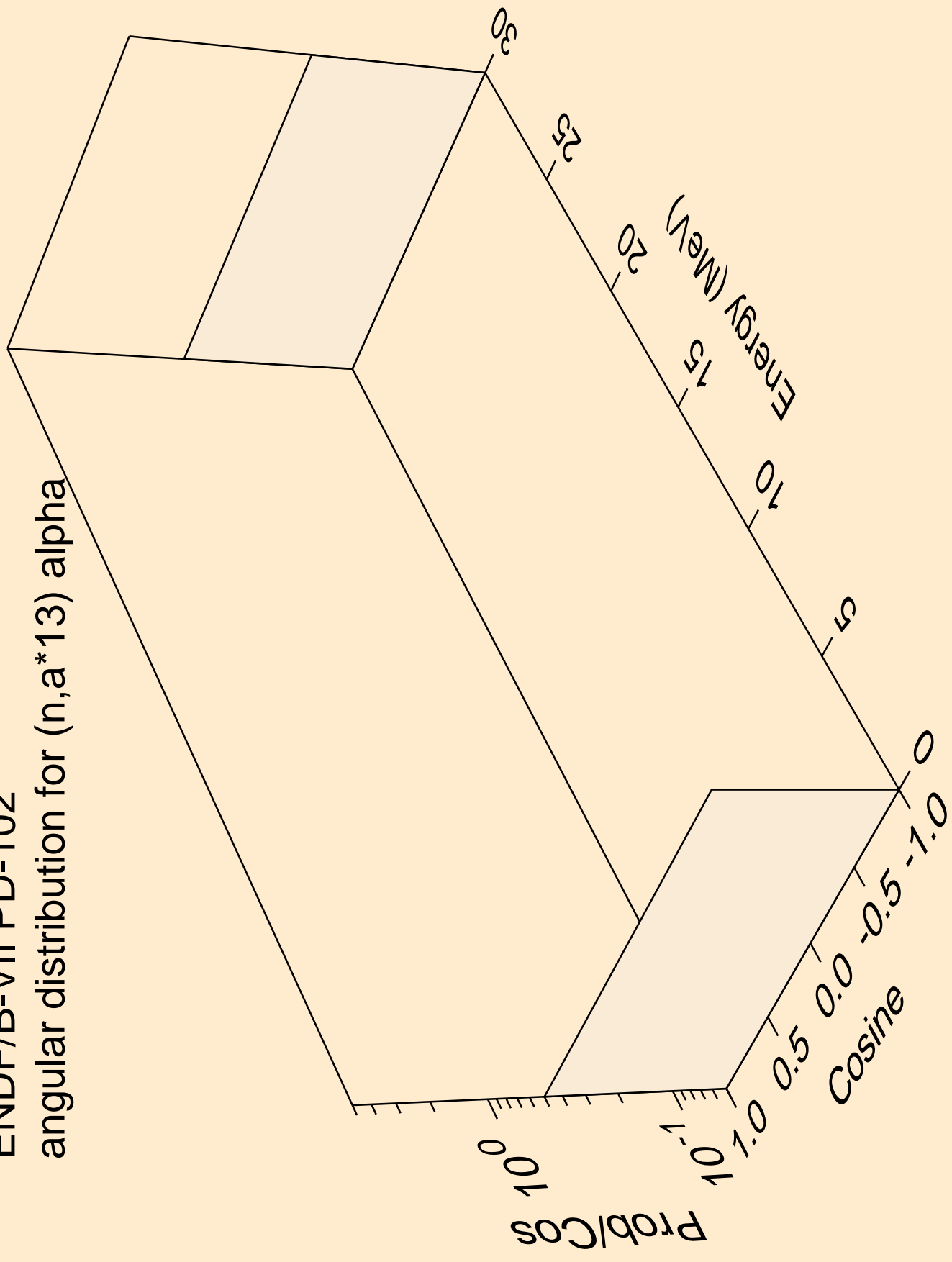

ENDF/B-VII PD-102
angular distribution for (n,a*14) alpha

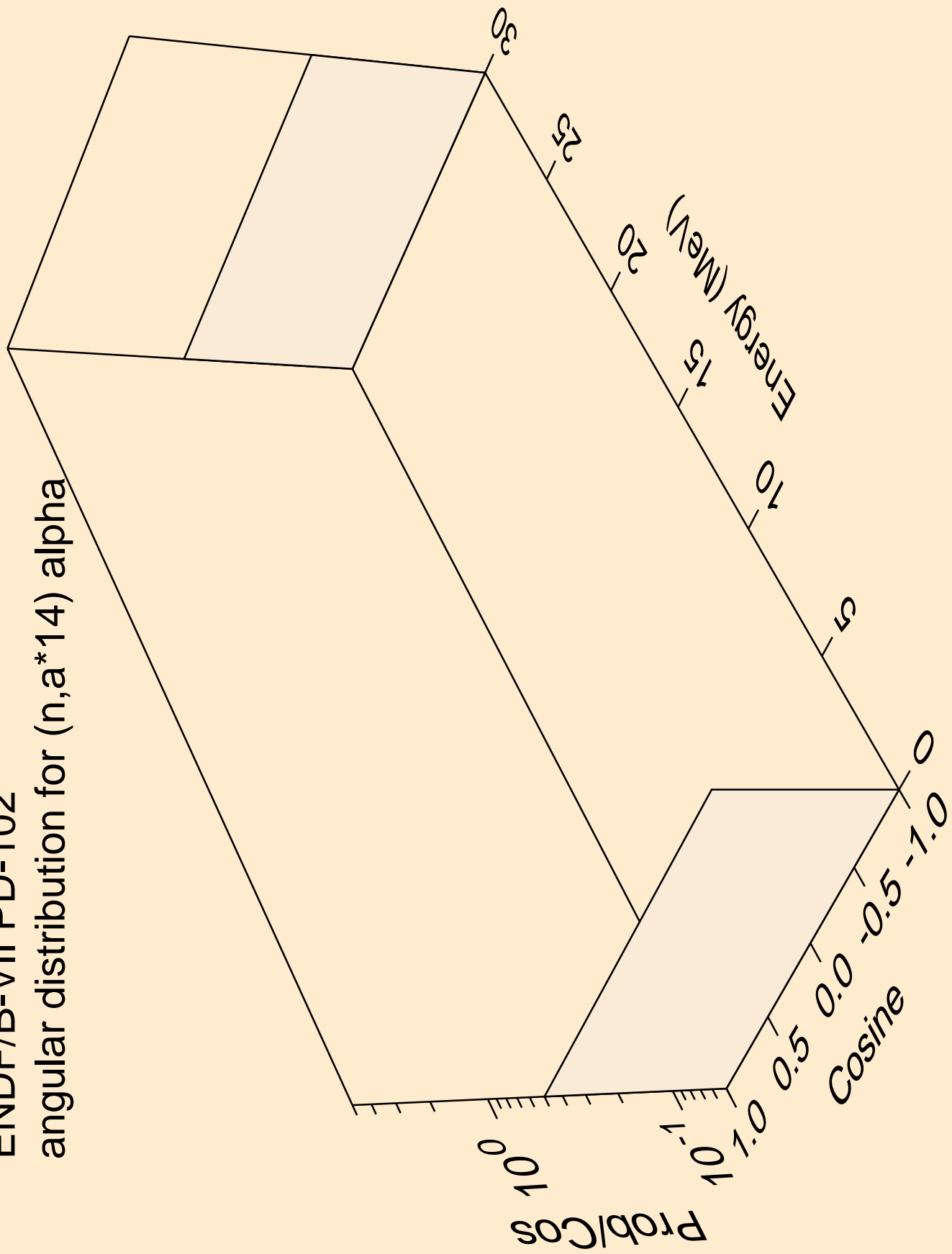

ENDF/B-VII PD-102
angular distribution for (n,a*15) alpha

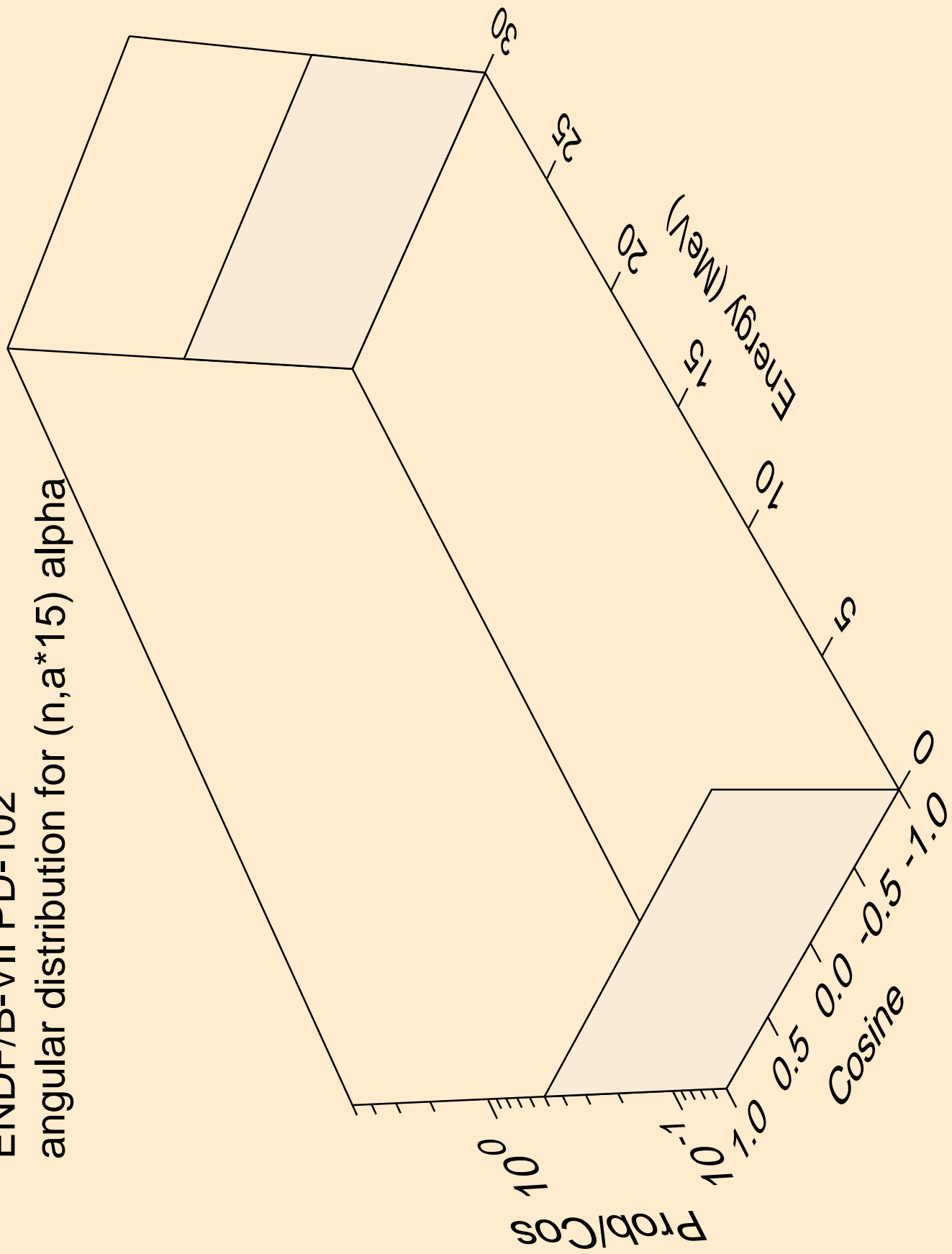

ENDF/B-VII PD-102
angular distribution for (n,a*16) alpha

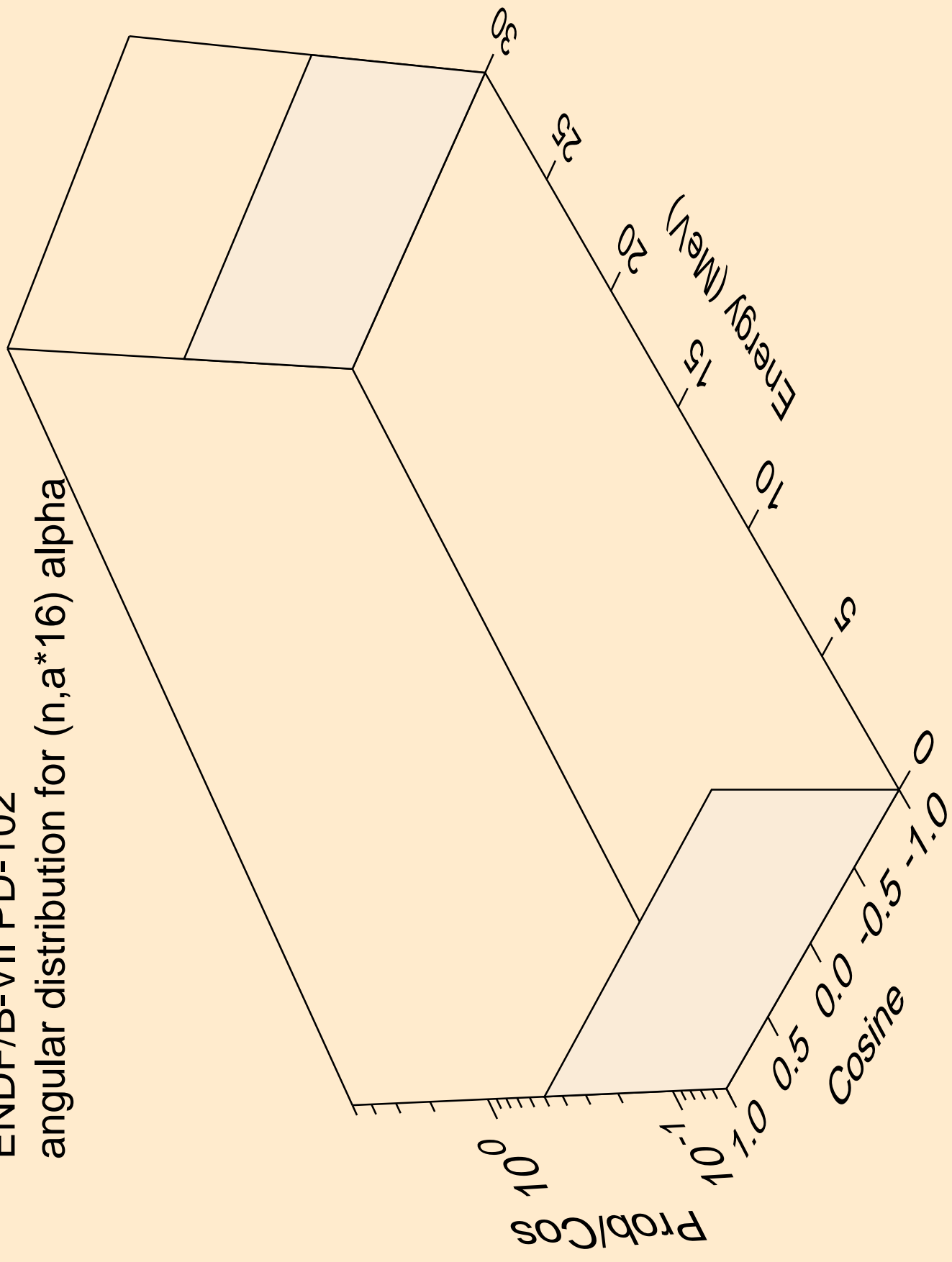

ENDF/B-VII PD-102
angular distribution for (n,a*17) alpha

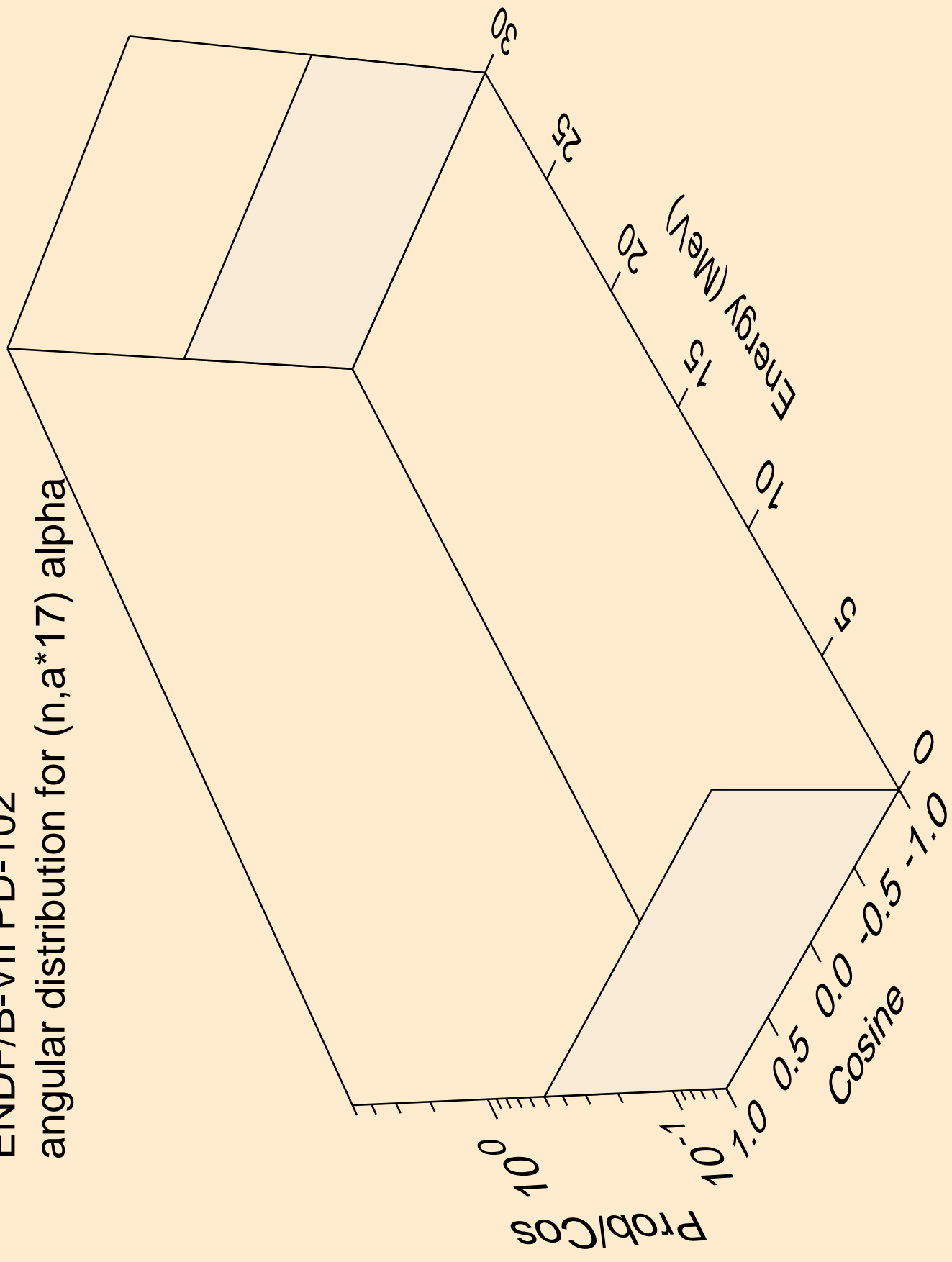

ENDF/B-VII PD-102
angular distribution for (n,a*18) alpha

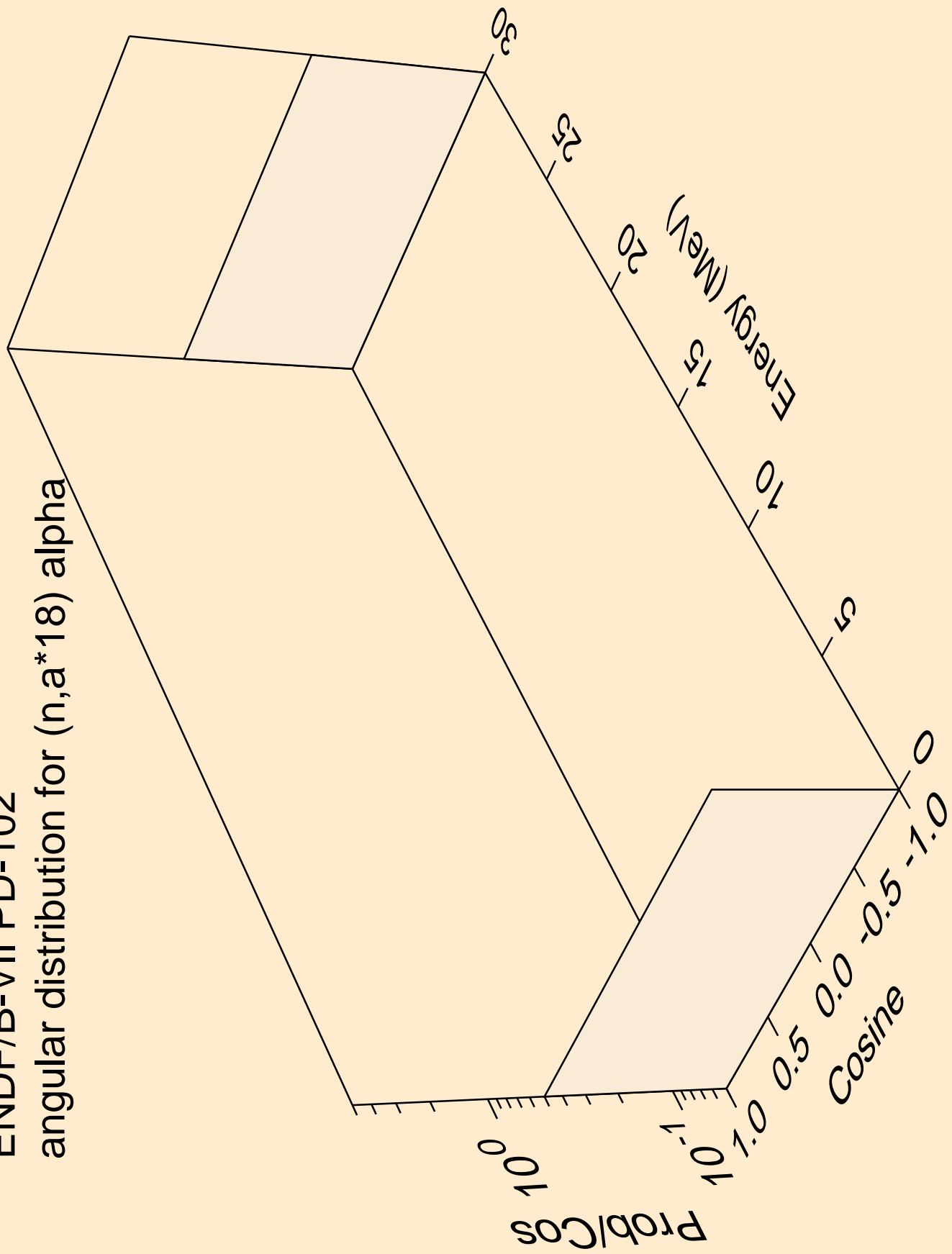

ENDF/B-VII PD-102
angular distribution for (n,a*19) alpha

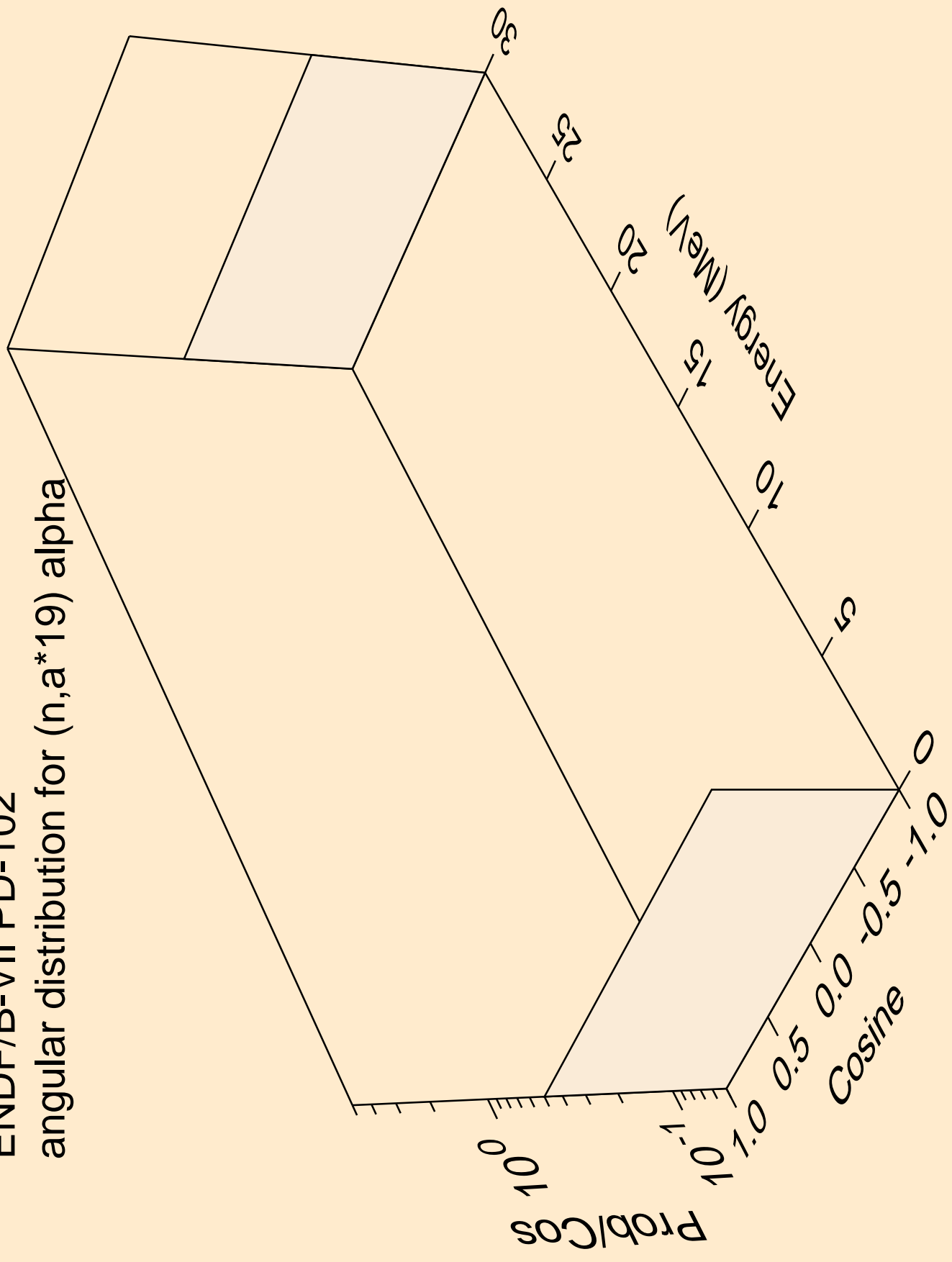

ENDF/B-VII PD-102
angular distribution for (n,a*20) alpha

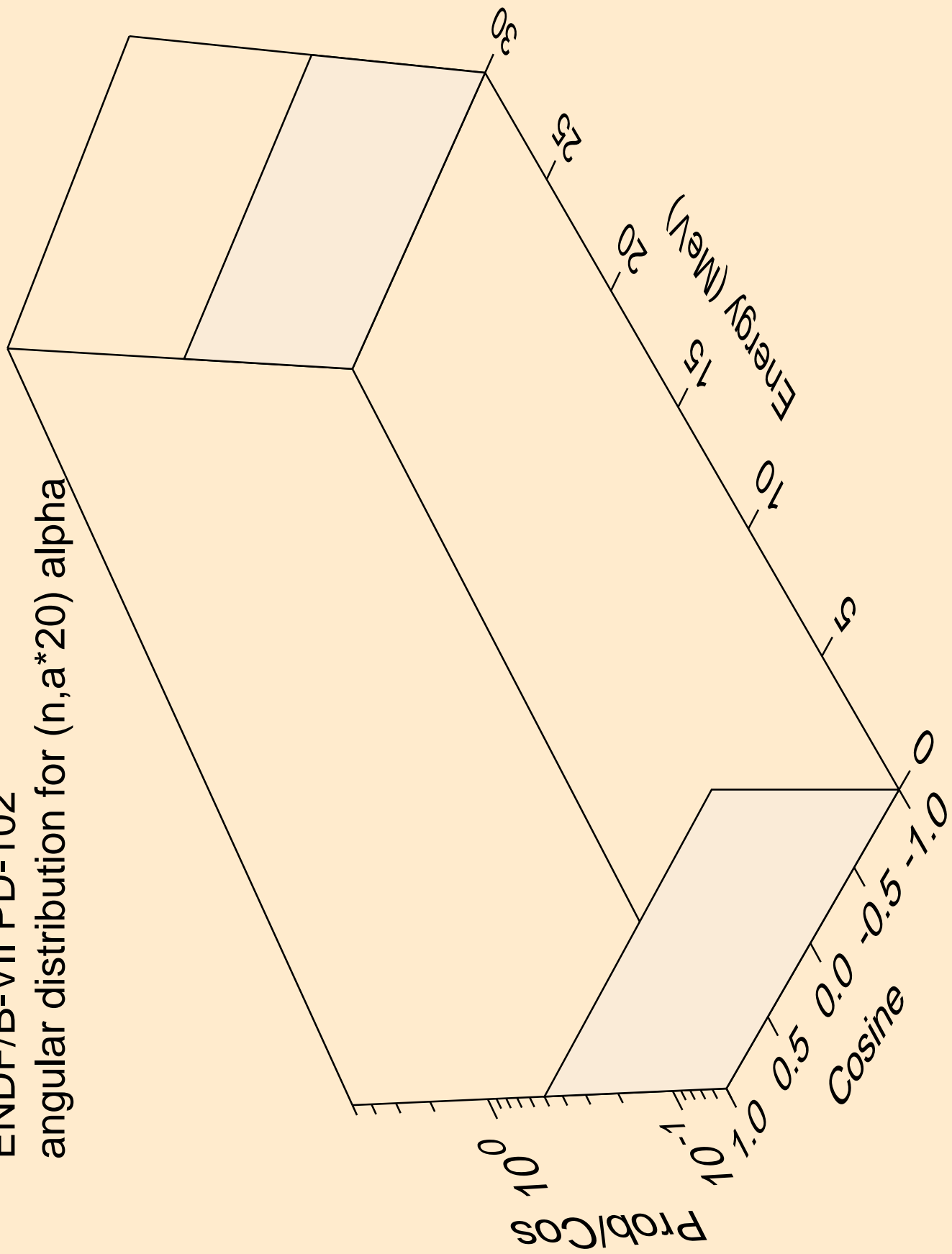

ENDF/B-VII PD-102
angular distribution for (n,a*21) alpha

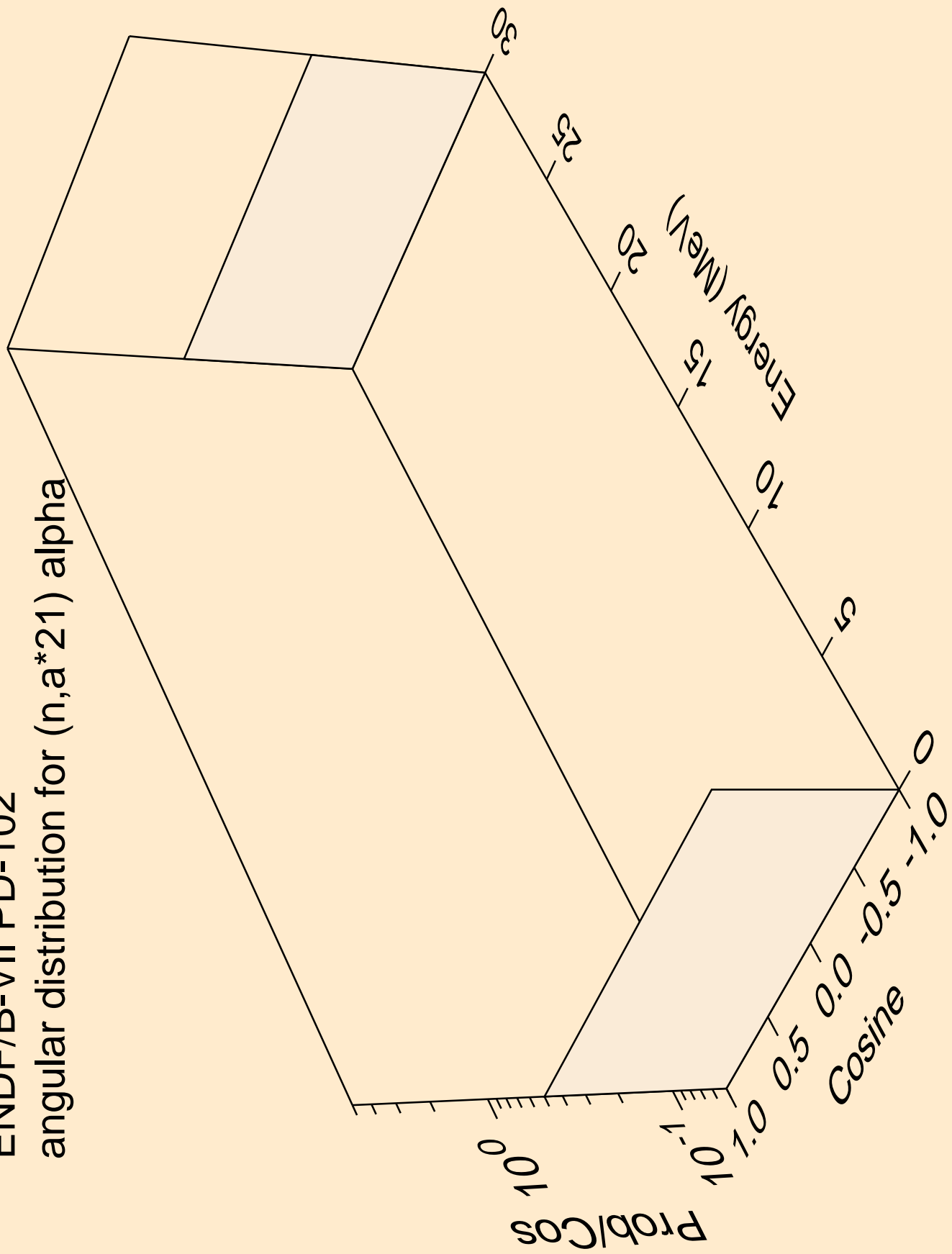

ENDF/B-VII PD-102
angular distribution for (n,a*22) alpha

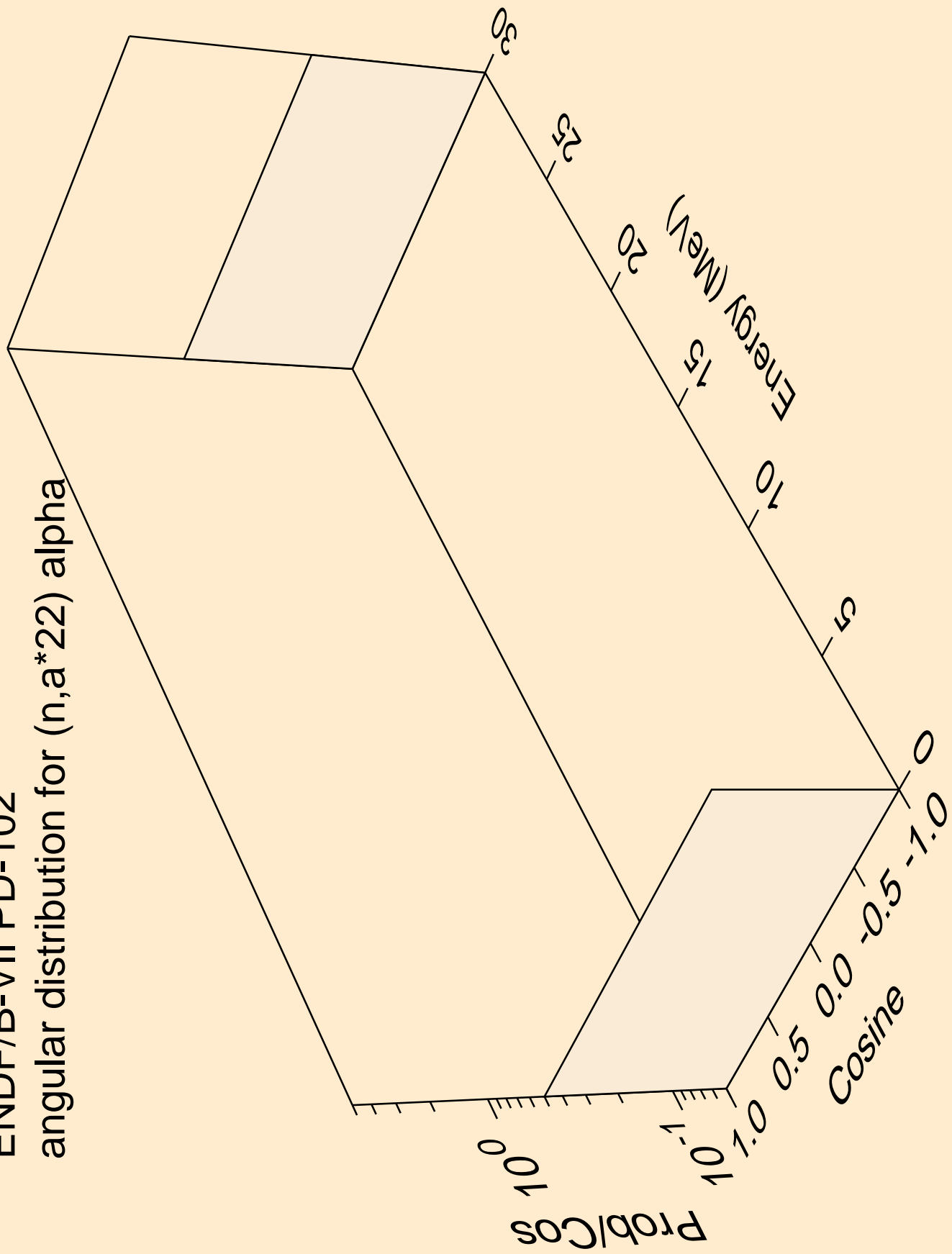

ENDF/B-VII PD-102
angular distribution for (n,a*23) alpha

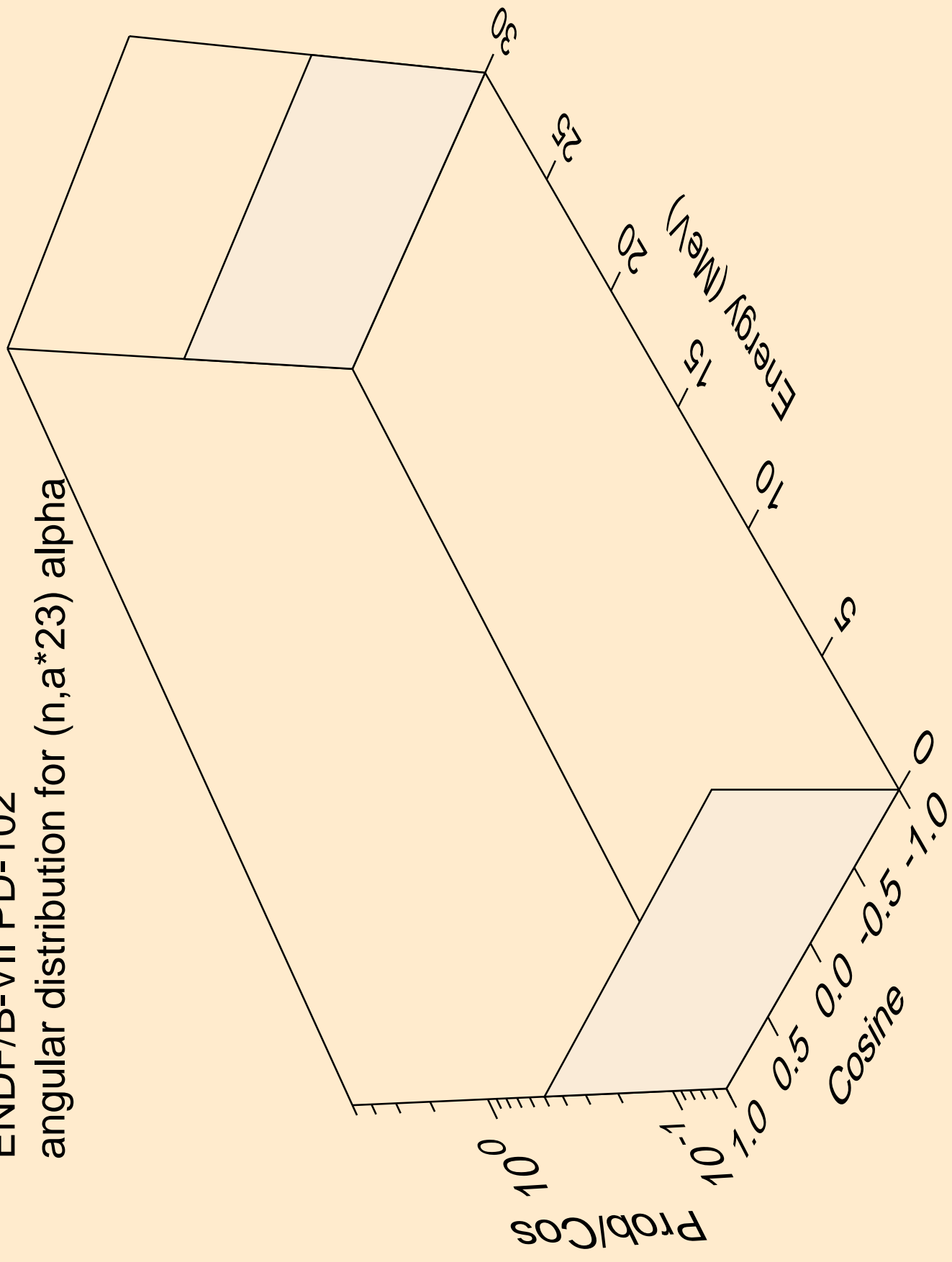

ENDF/B-VII PD-102
angular distribution for (n,a*24) alpha

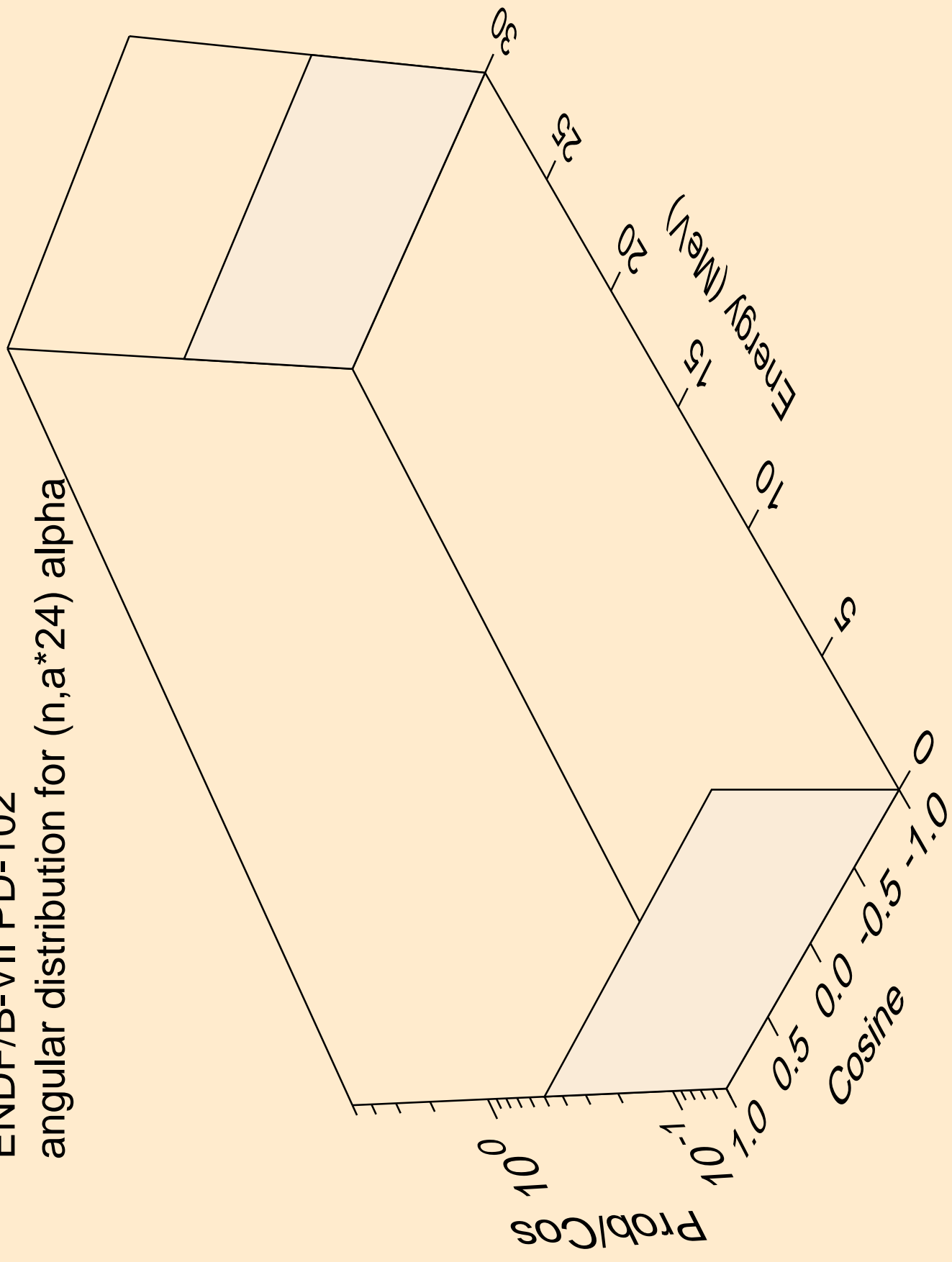

ENDF/B-VII PD-102
alphas from (n,a*c)

