

P + 26-FE-56 APT LA150 NJOY99 MCNPX

Principal cross sections

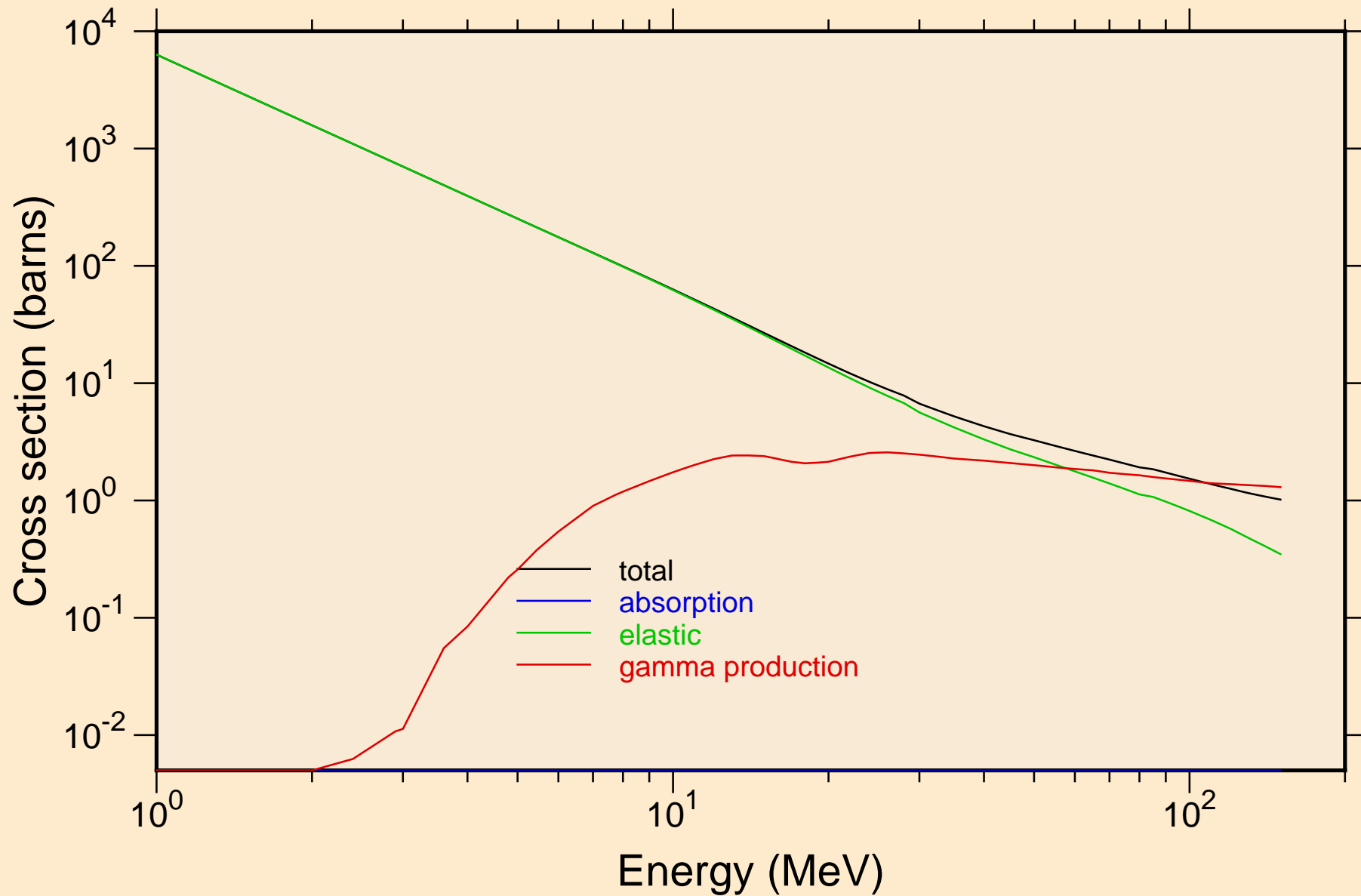

P + 26-FE-56 APT LA150 NJOY99 MCNPX
Heating

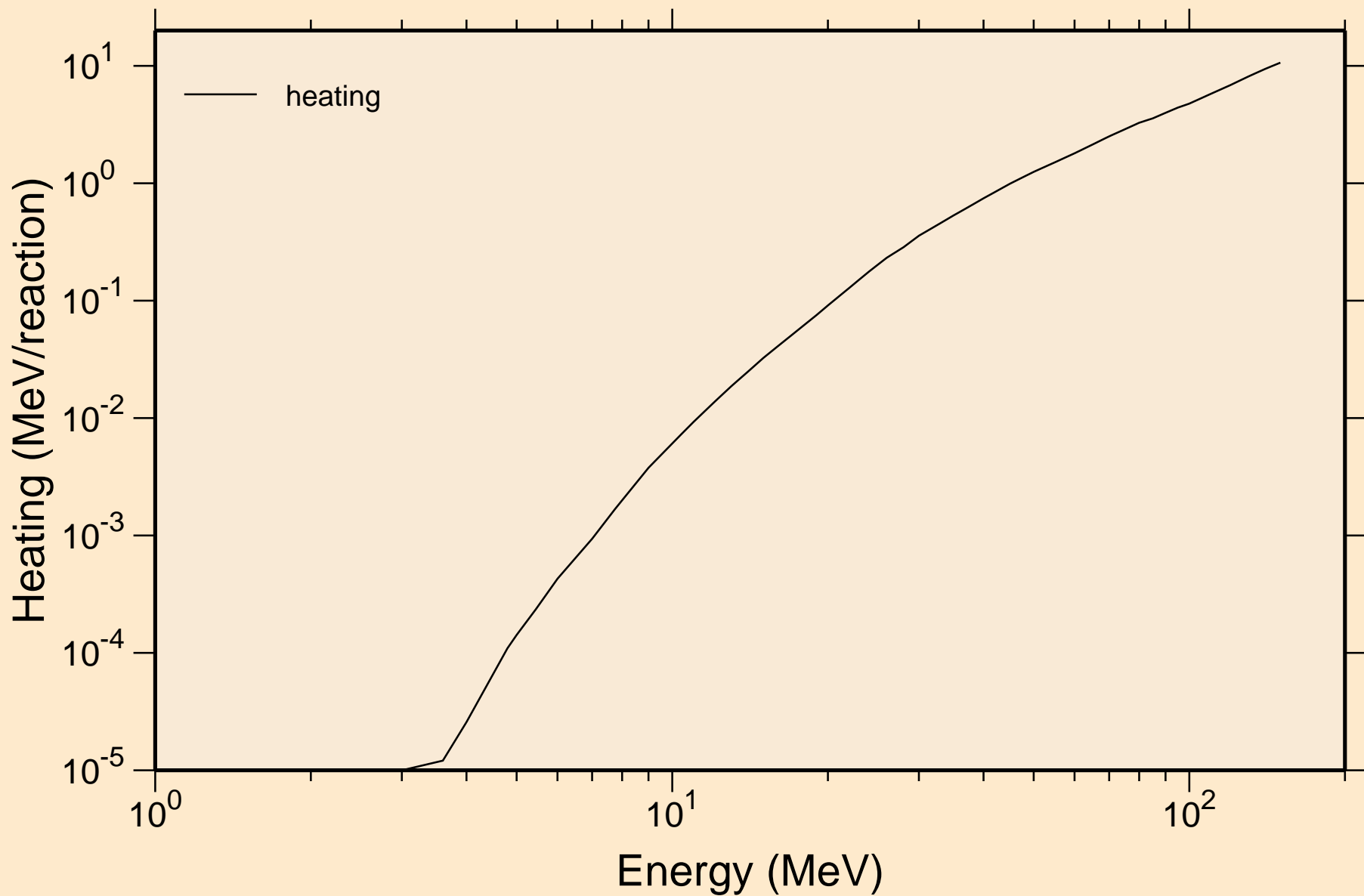

P + 26-FE-56 APT LA150 NJOY99 MCNPX

Principal cross sections

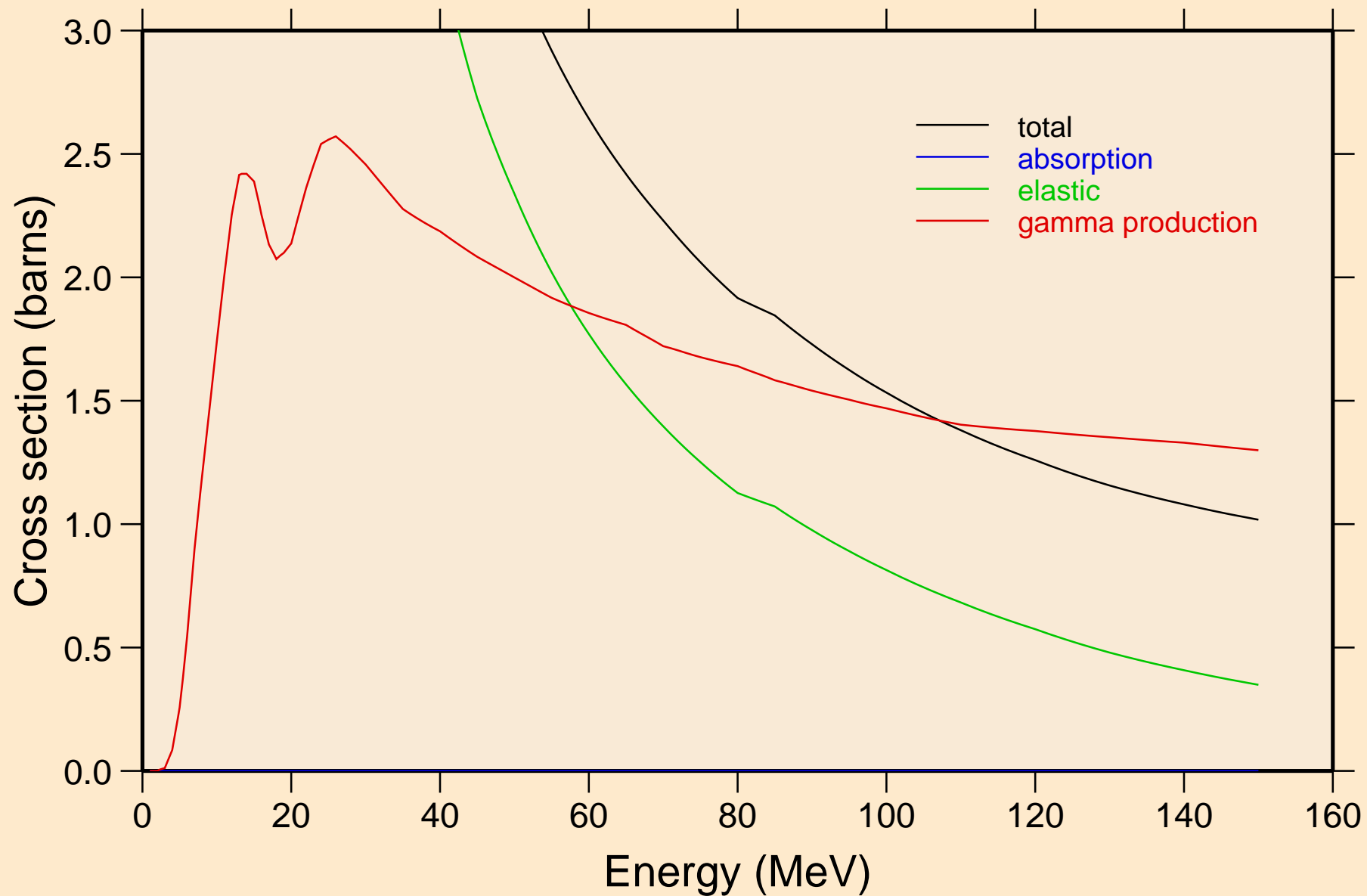

P + 26-FE-56 APT LA150 NJOY99 MCNPX

Heating

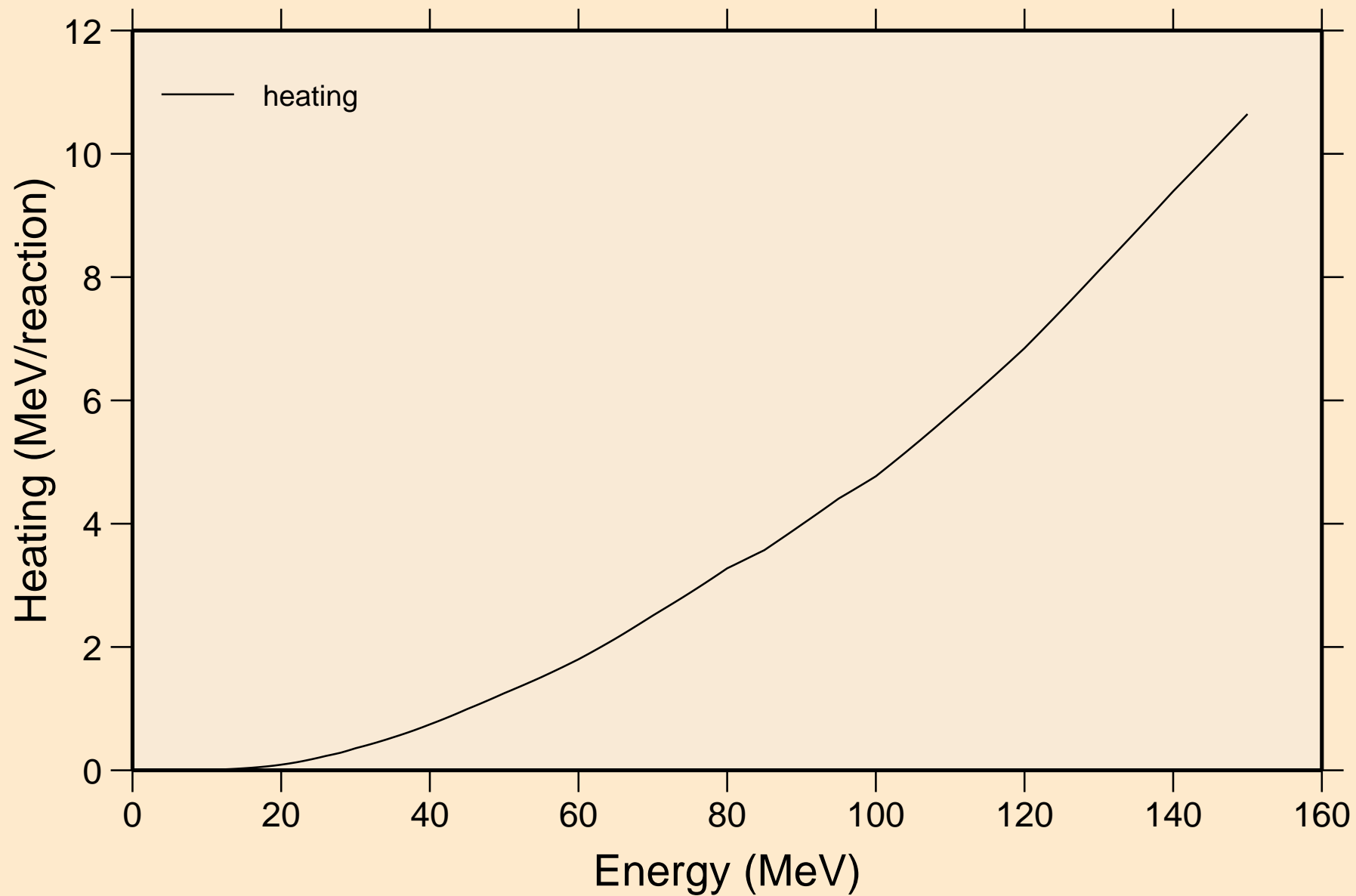

P + 26-FE-56 APT LA150 NJOY99 MCNPX

Threshold reactions

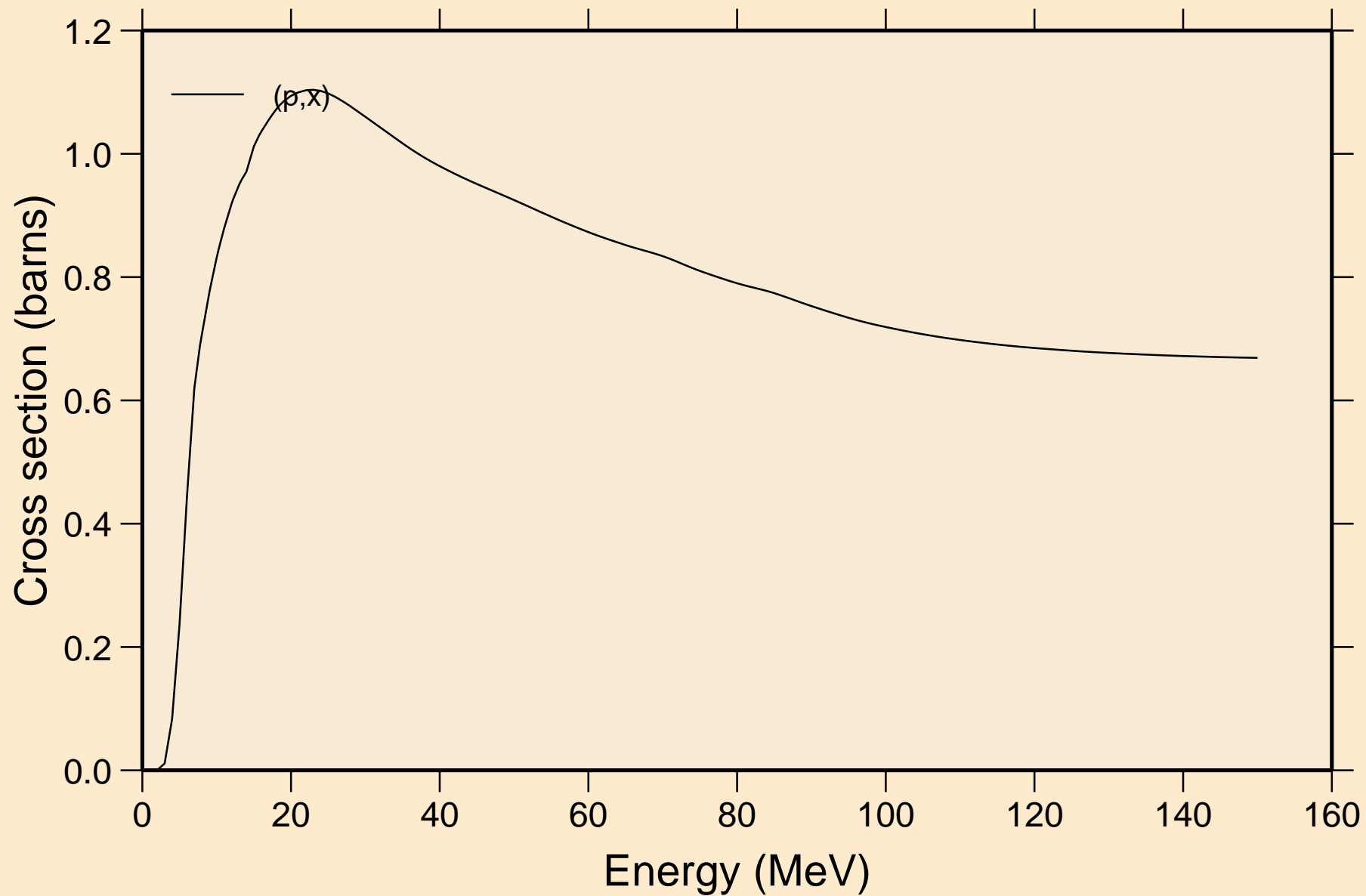

P + 26-FE-56 APT LA150 NJOY99 MCNPX
angular distribution for elastic

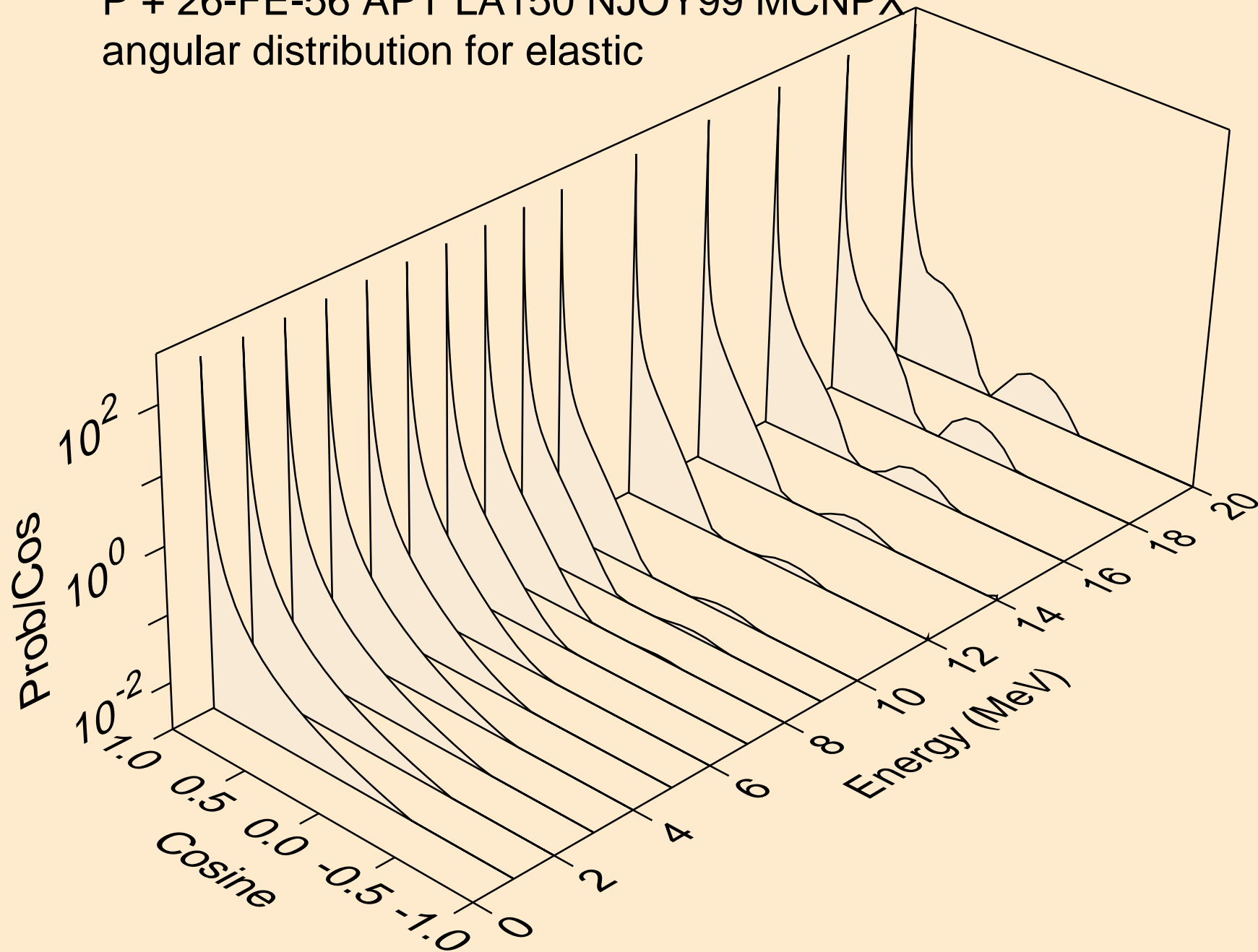

P + 26-FE-56 APT LA150 NJOY99 MCNPX
angular distribution for elastic

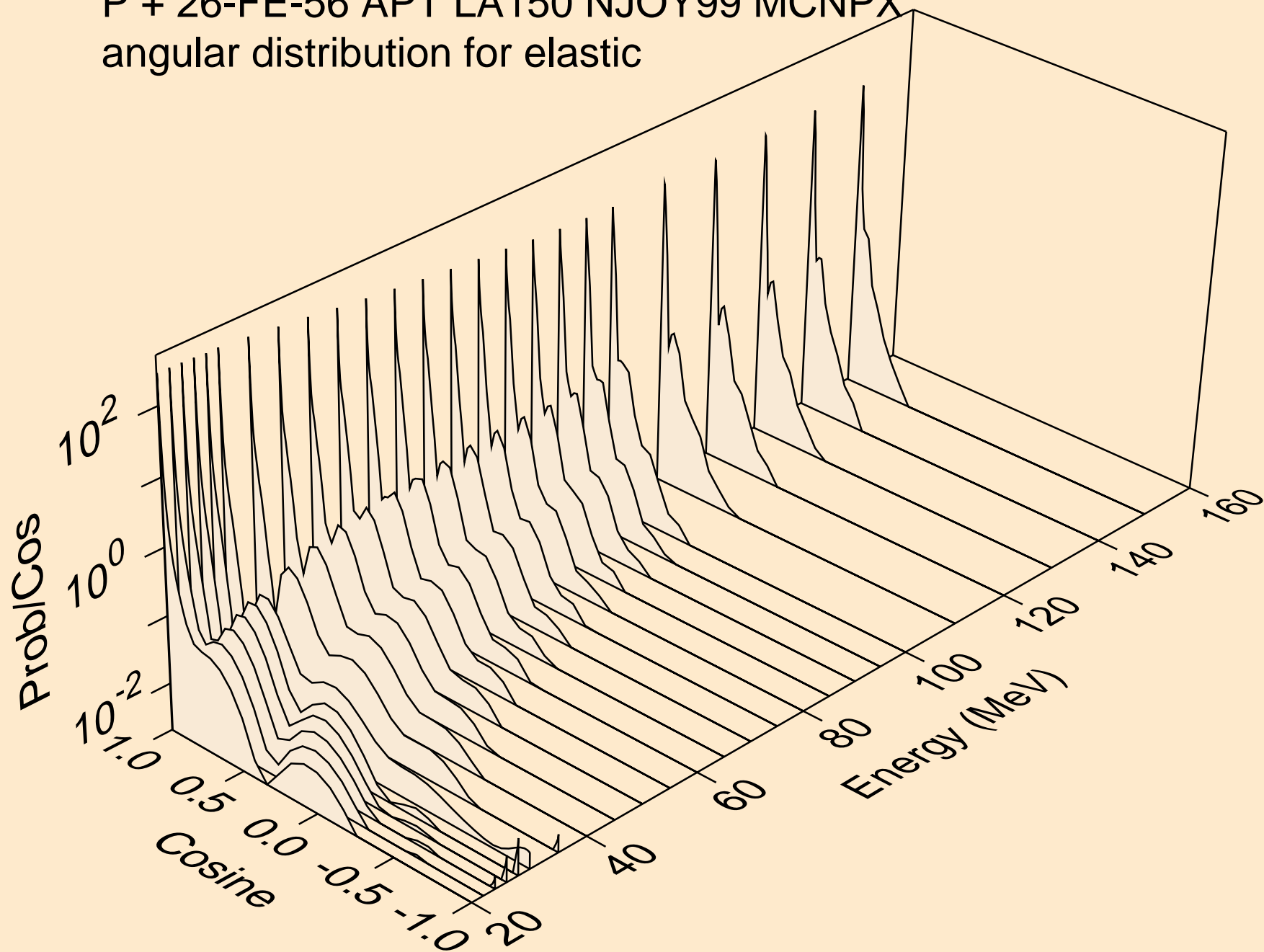

P + 26-FE-56 APT LA150 NJOY99 MCNPX
Proton emission for (p,x)

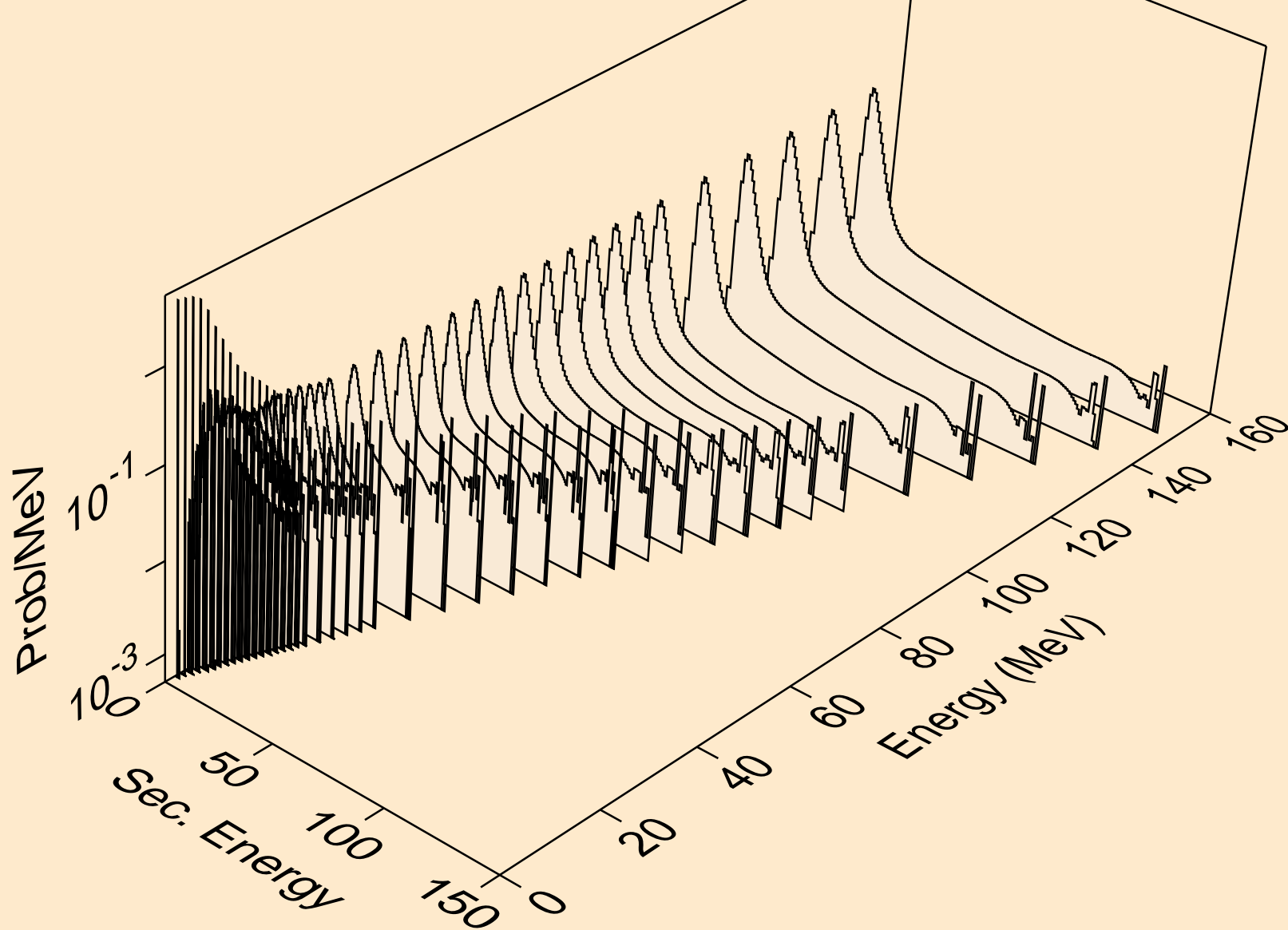

P + 26-FE-56 APT LA150 NJOY99 MCNPX
Photon emission for (n,x)

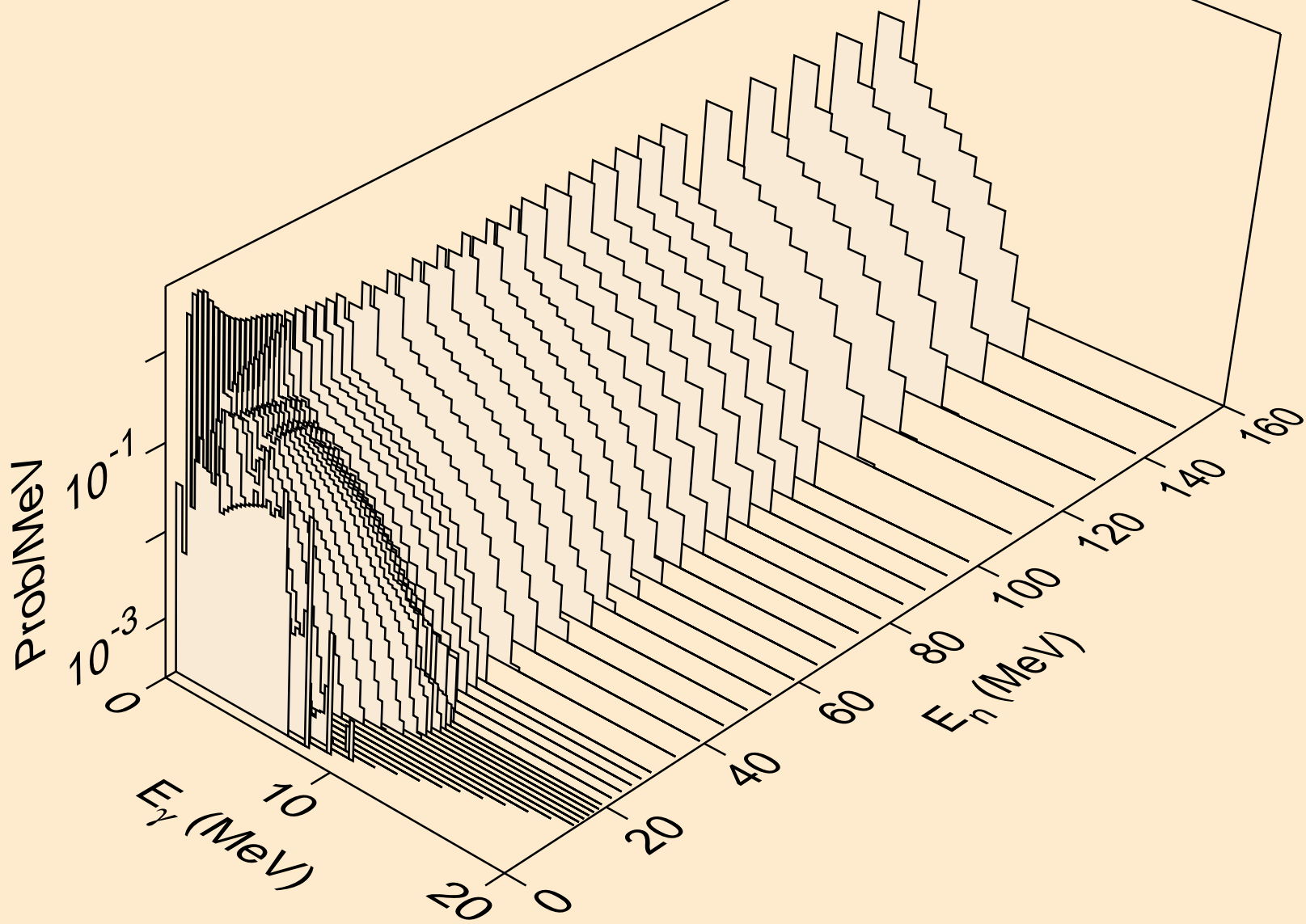

P + 26-FE-56 APT LA150 NJOY99 MCNPX

Particle heating contributions

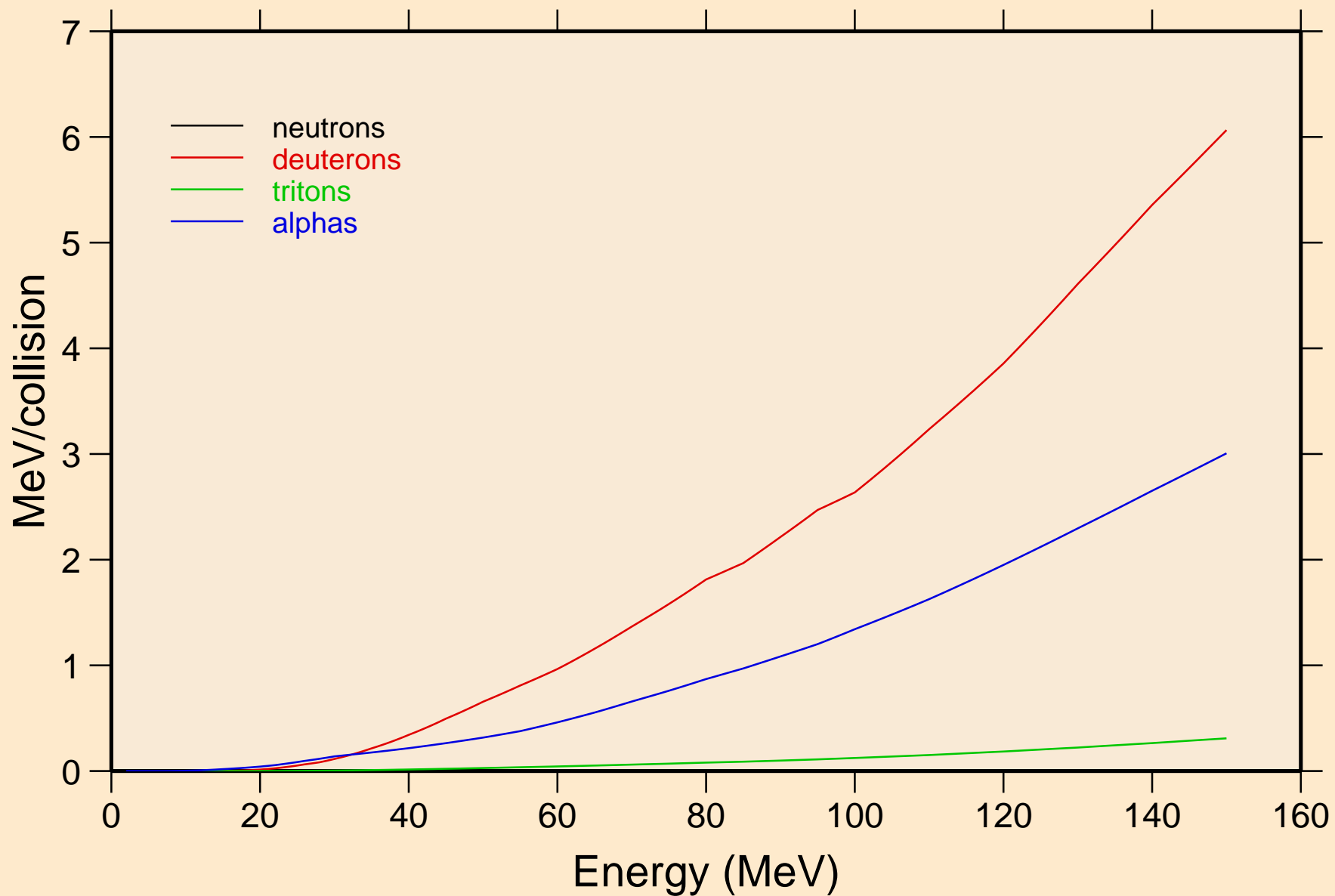

P + 26-FE-56 APT LA150 NJOY99 MCNPX

Particle production cross sections

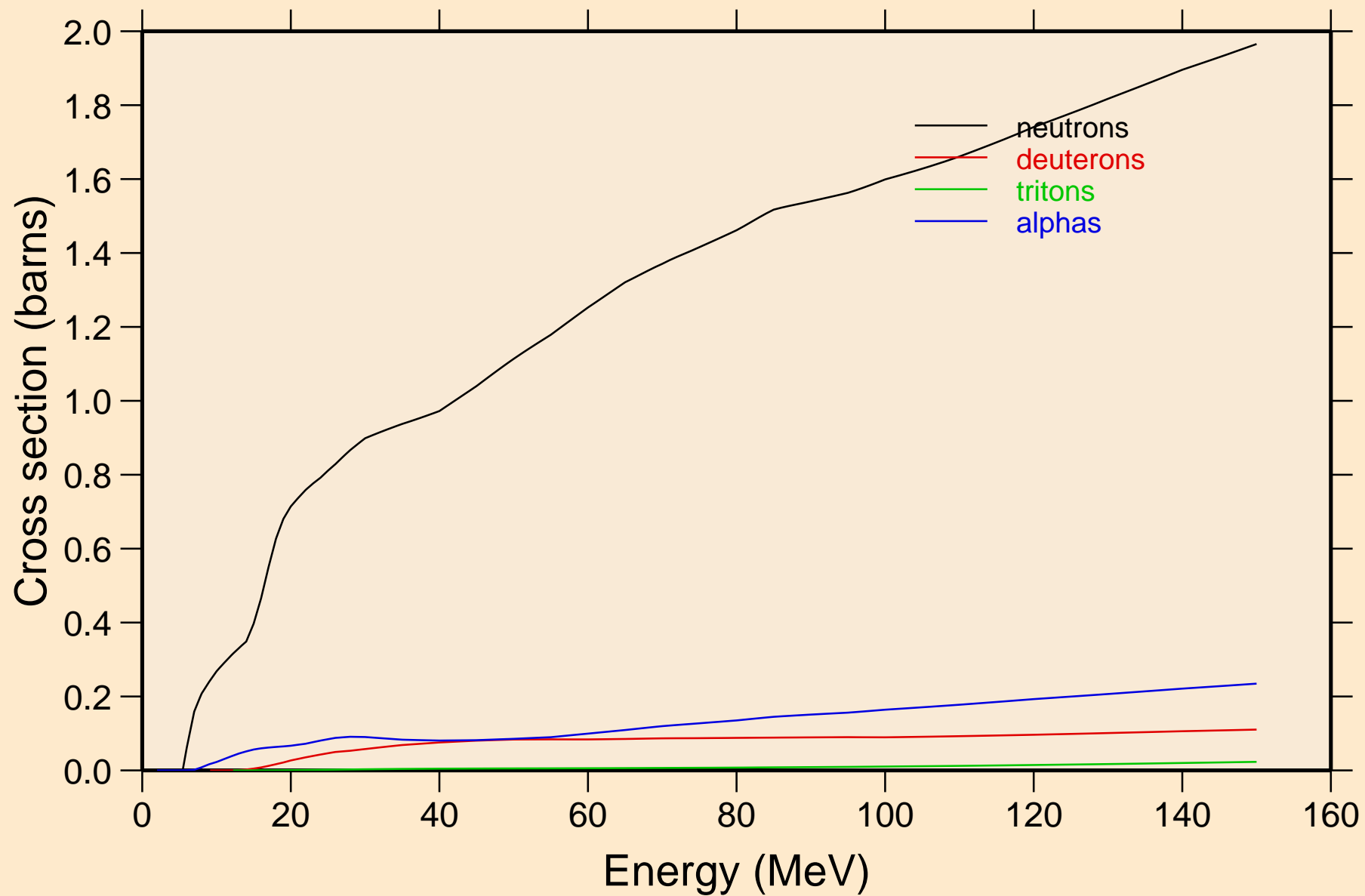

P + 26-FE-56 APT LA150 NJOY99 MCNPX
neutrons from (p,x)

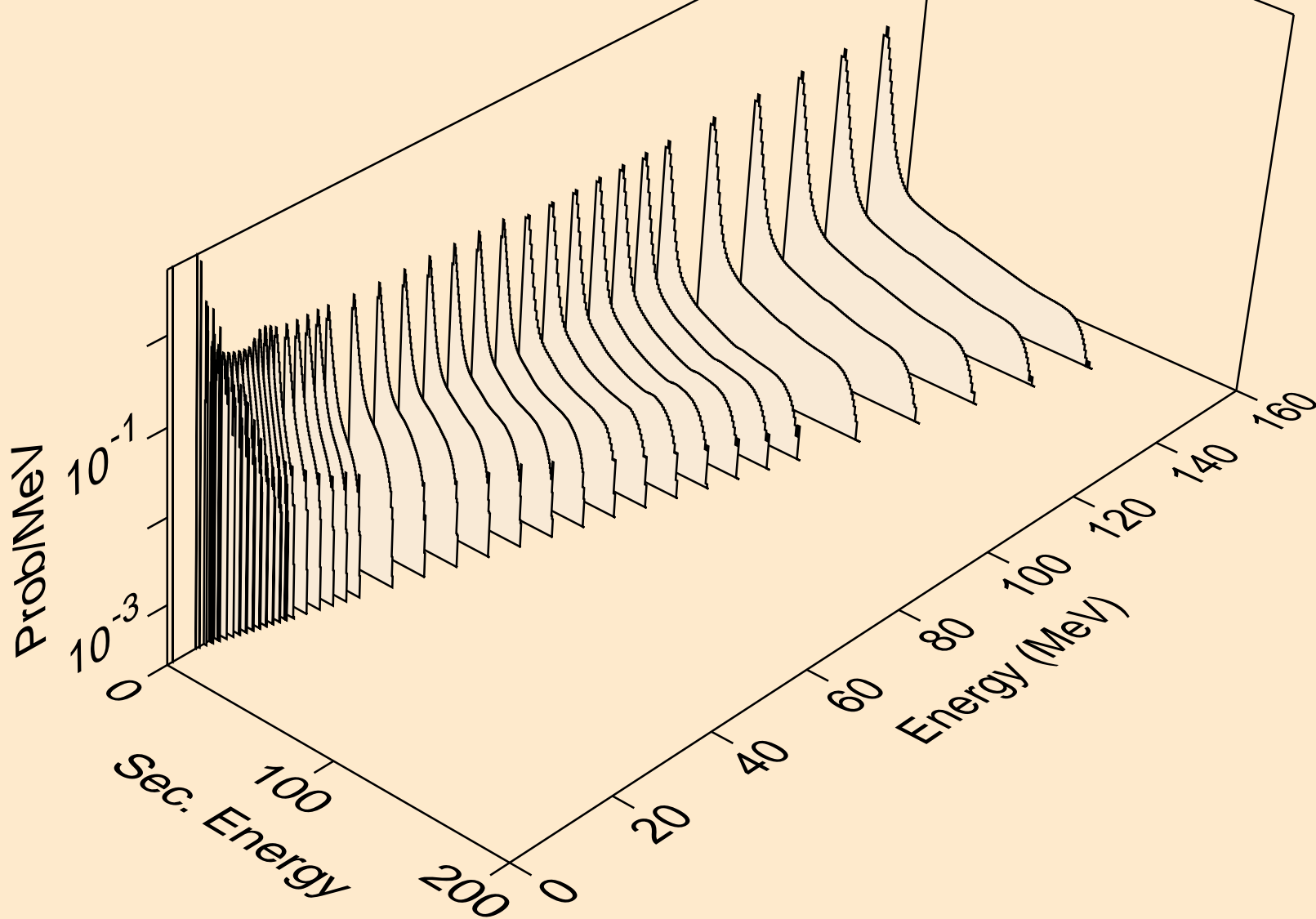

P + 26-FE-56 APT LA150 NJOY99 MCNPX
deuterons from (p,x)

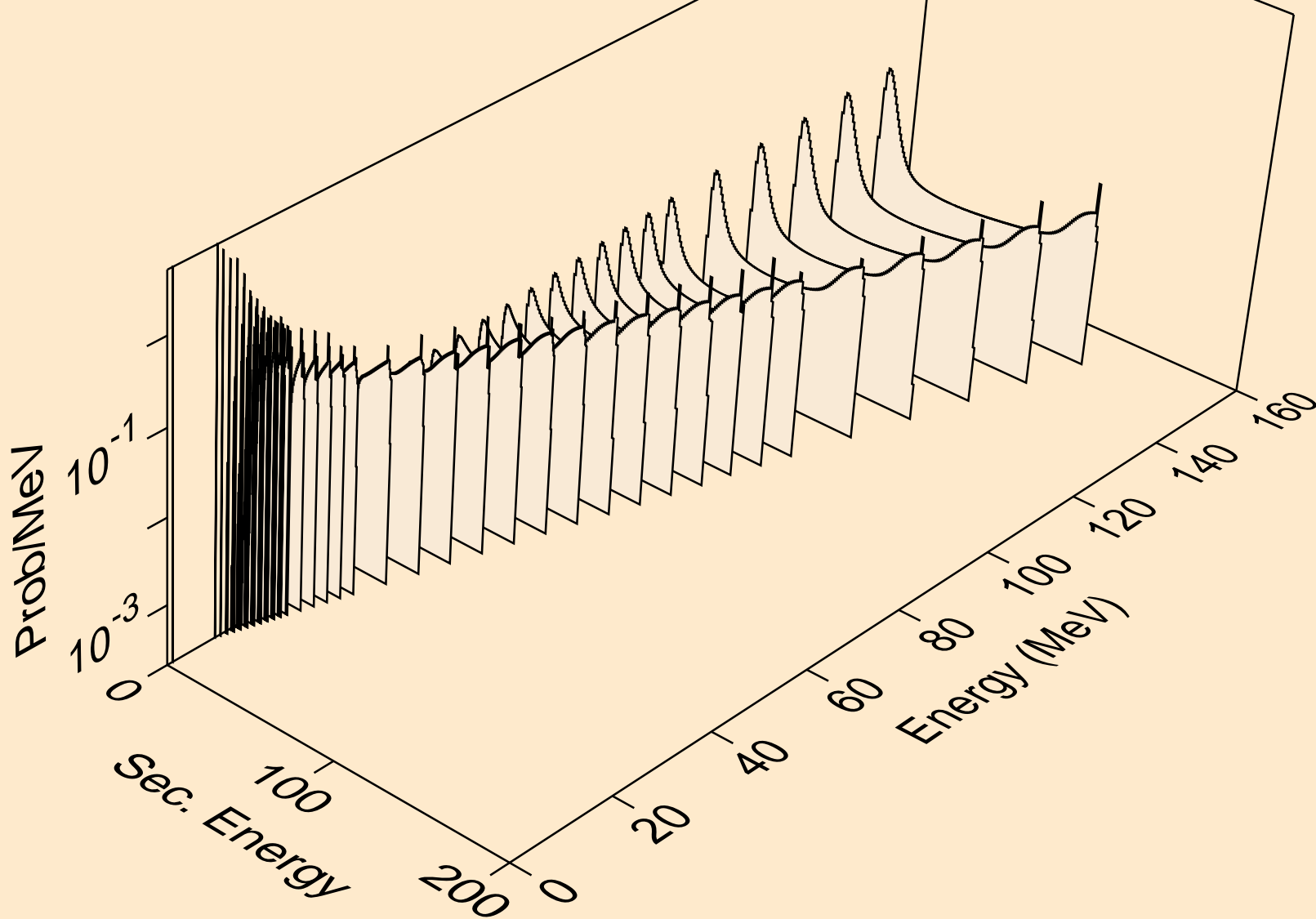

P + 26-FE-56 APT LA150 NJOY99 MCNPX
tritons from (p,x)

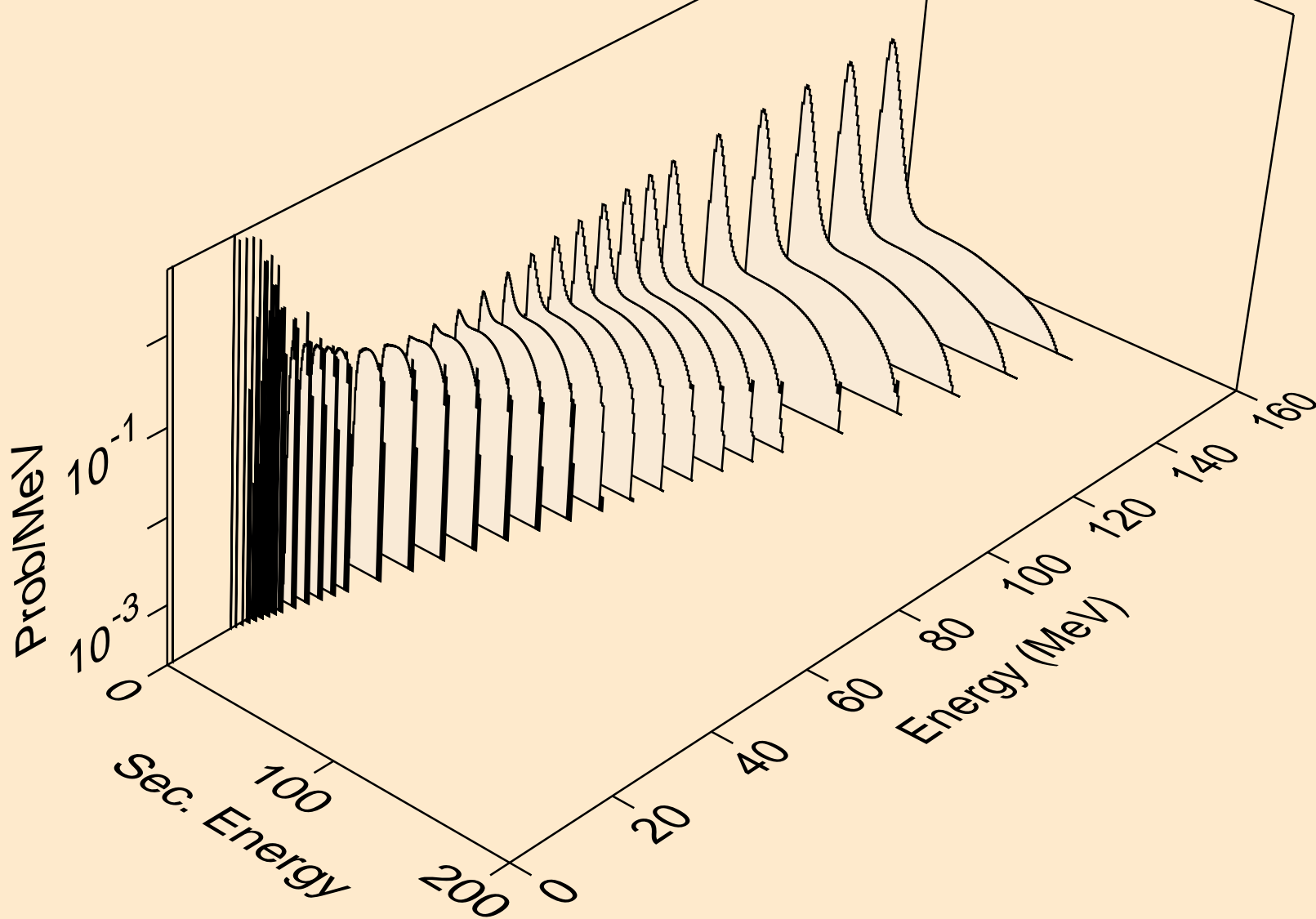

P + 26-FE-56 APT LA150 NJOY99 MCNPX
alphas from (p,x)

