

JEFF-3.1 ER-166

Principal cross sections

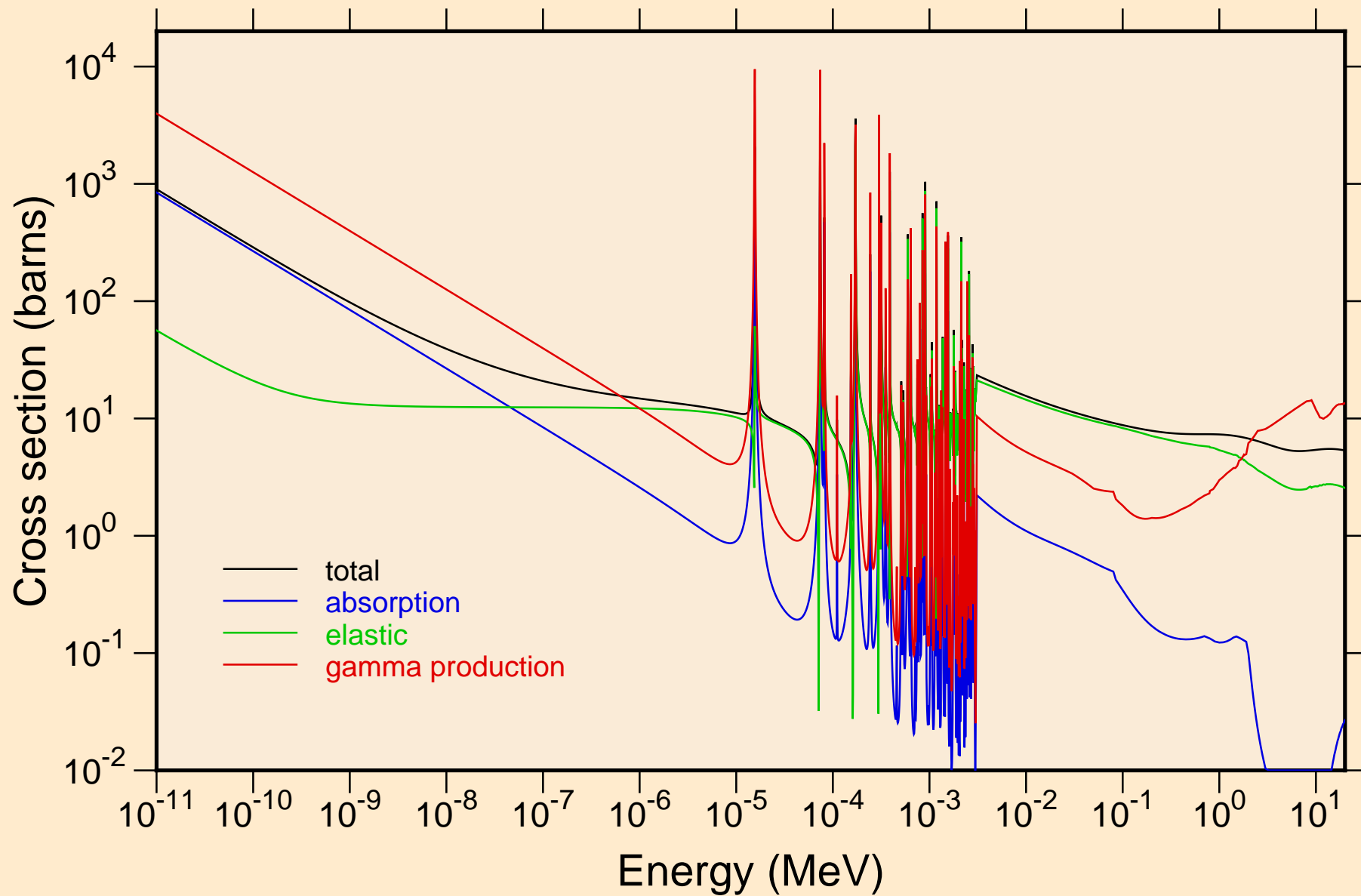

JEFF-3.1 ER-166
resonance total cross section

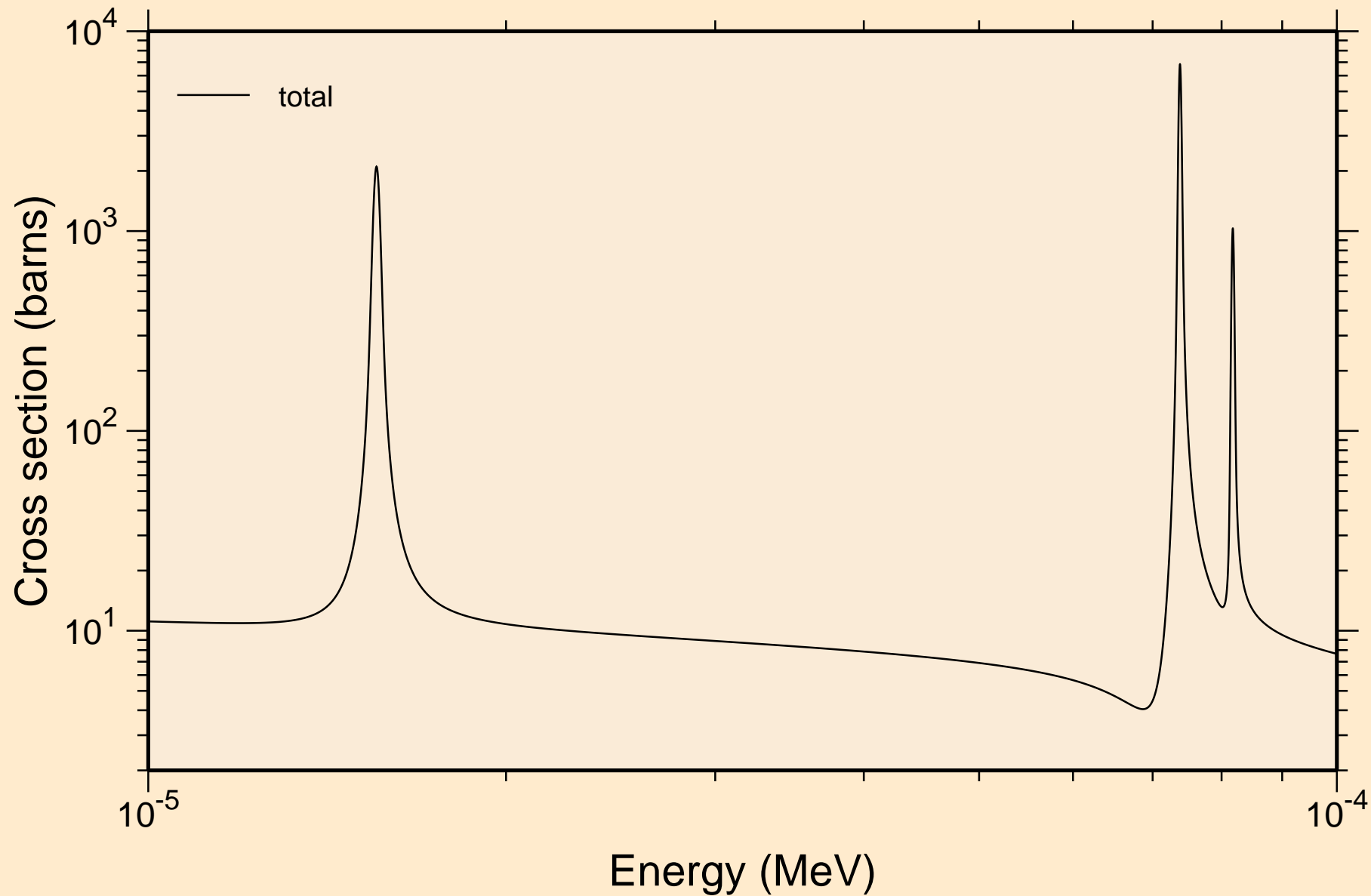

JEFF-3.1 ER-166
resonance total cross section

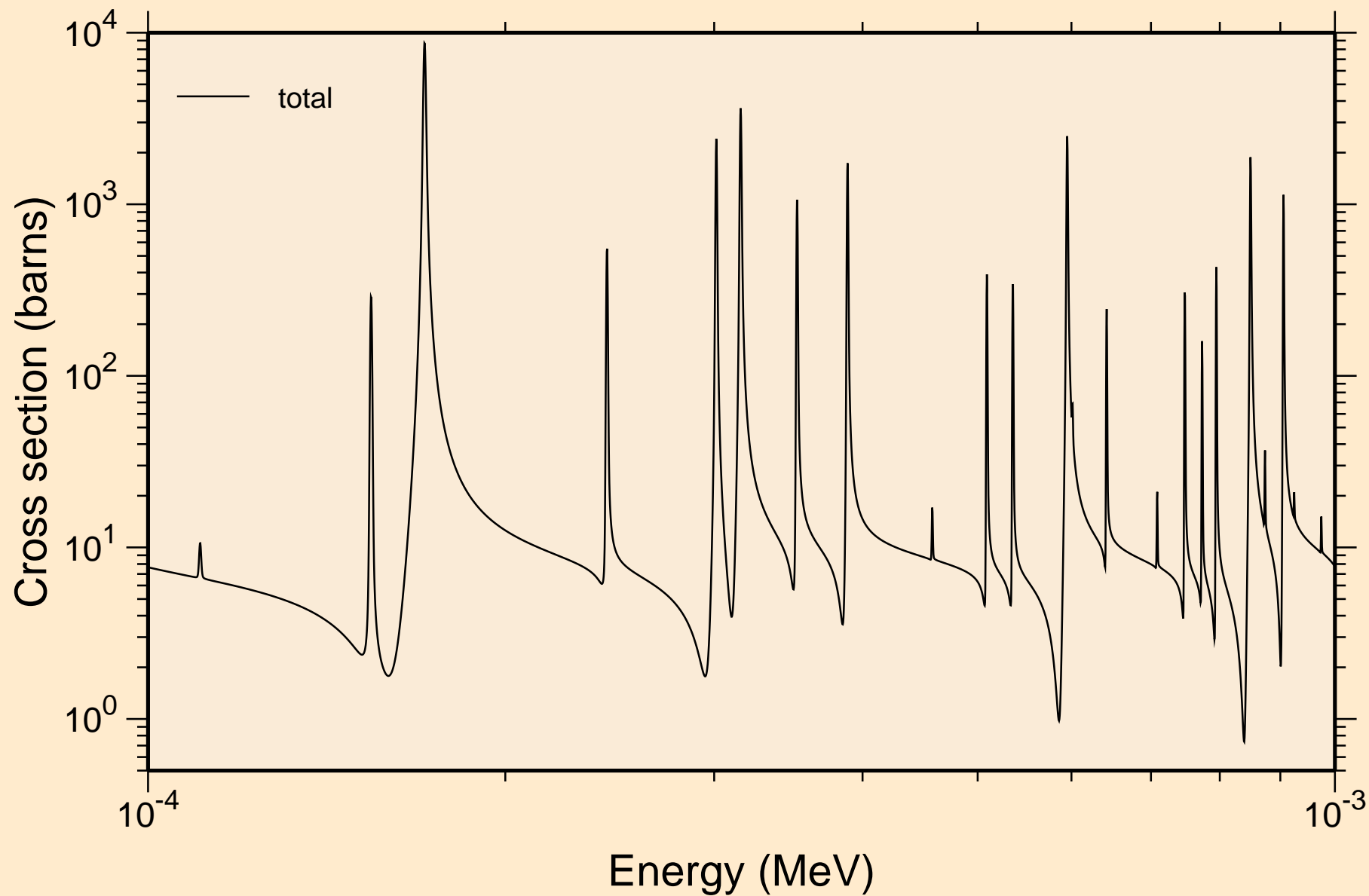

JEFF-3.1 ER-166
resonance total cross section

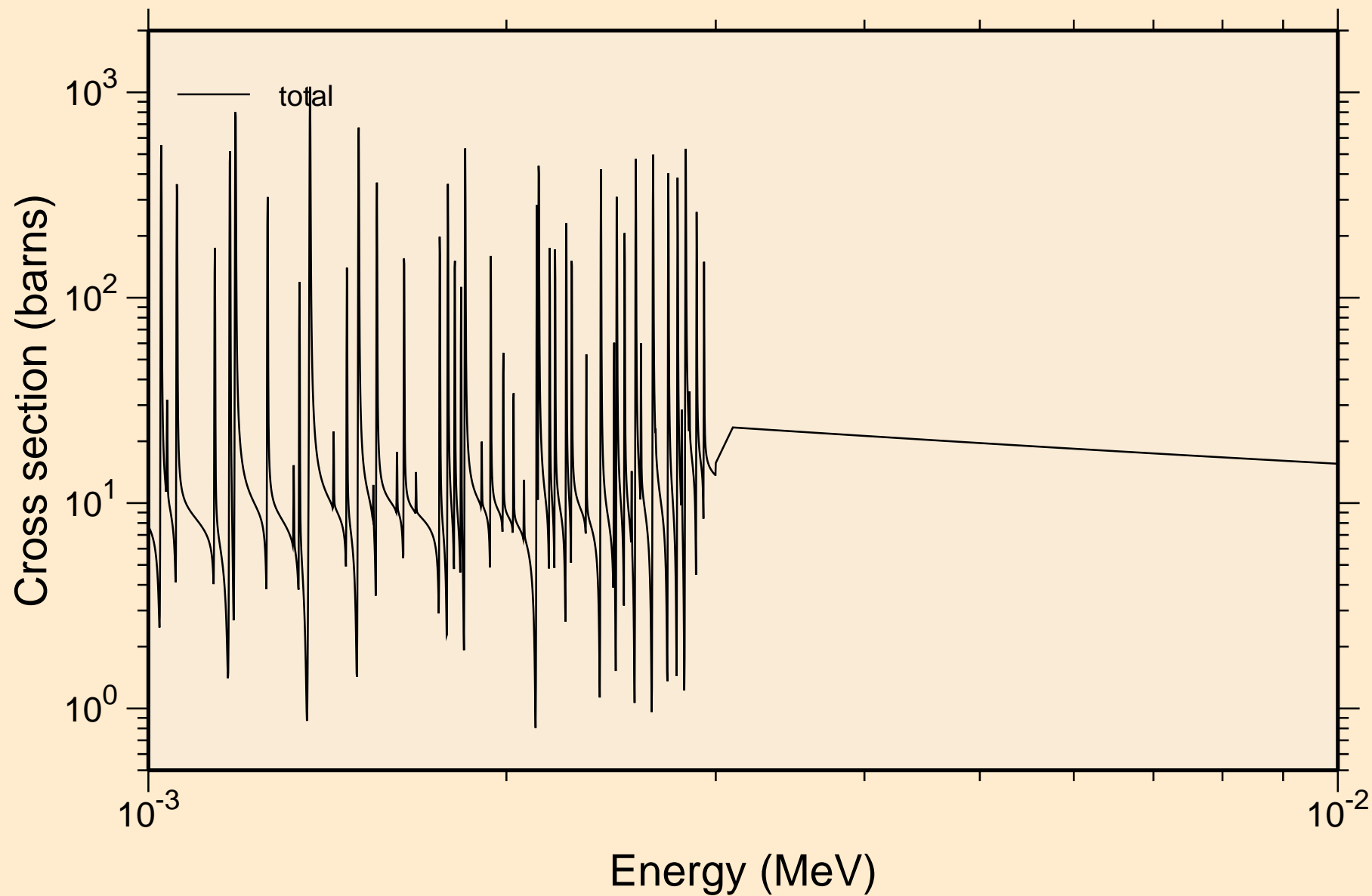

JEFF-3.1 ER-166

resonance absorption cross sections

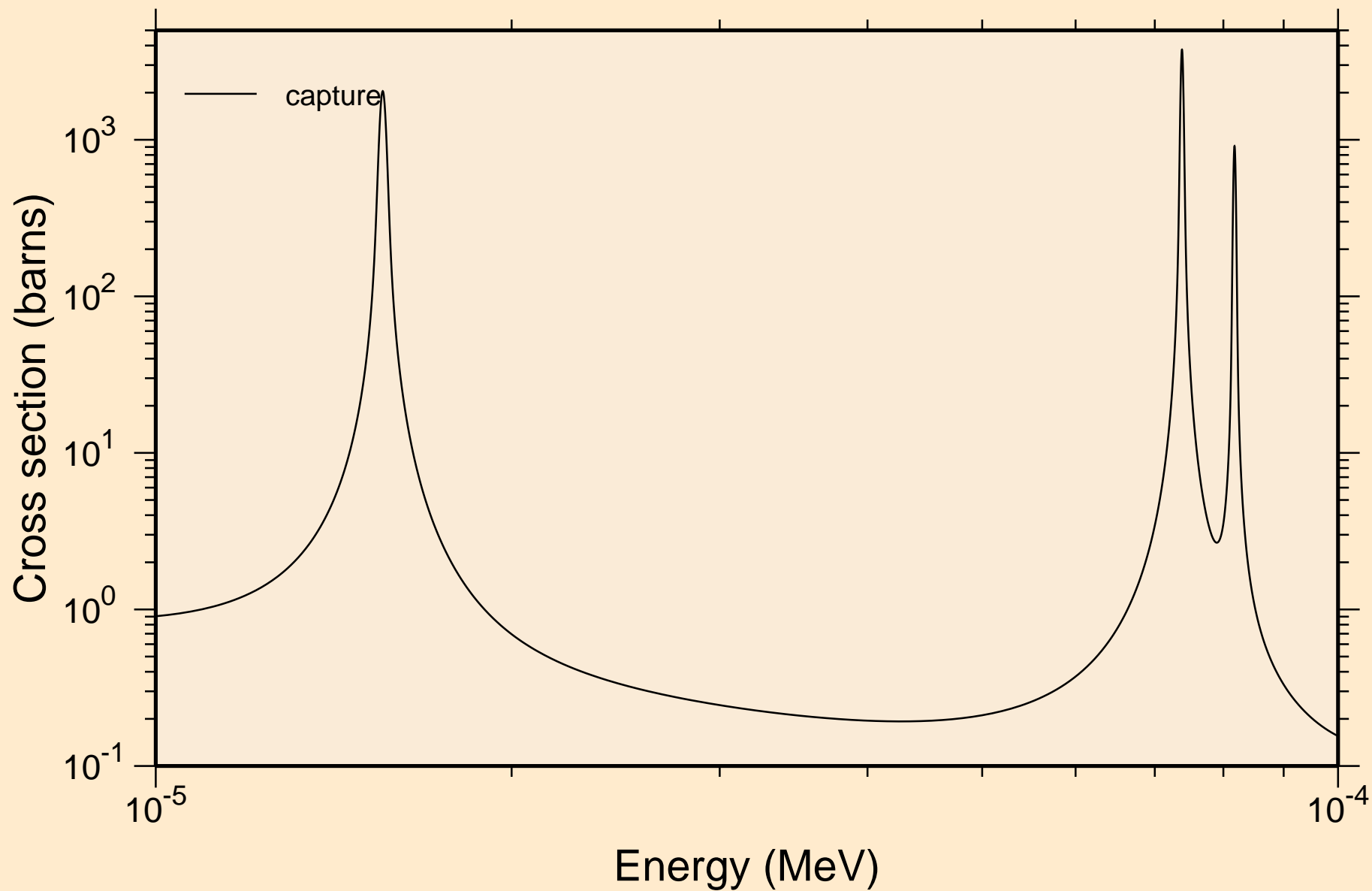

JEFF-3.1 ER-166

resonance absorption cross sections

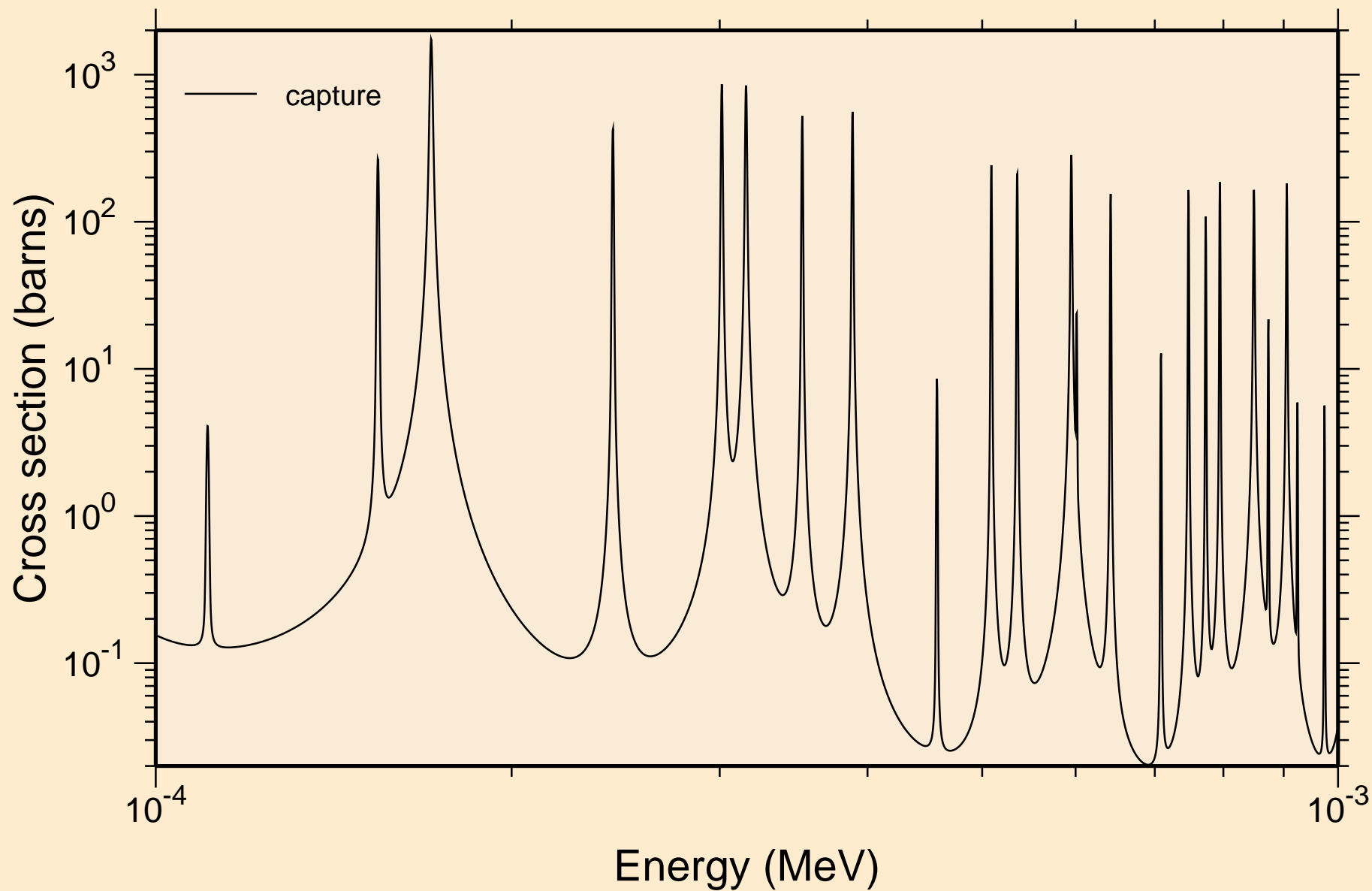

JEFF-3.1 ER-166

resonance absorption cross sections

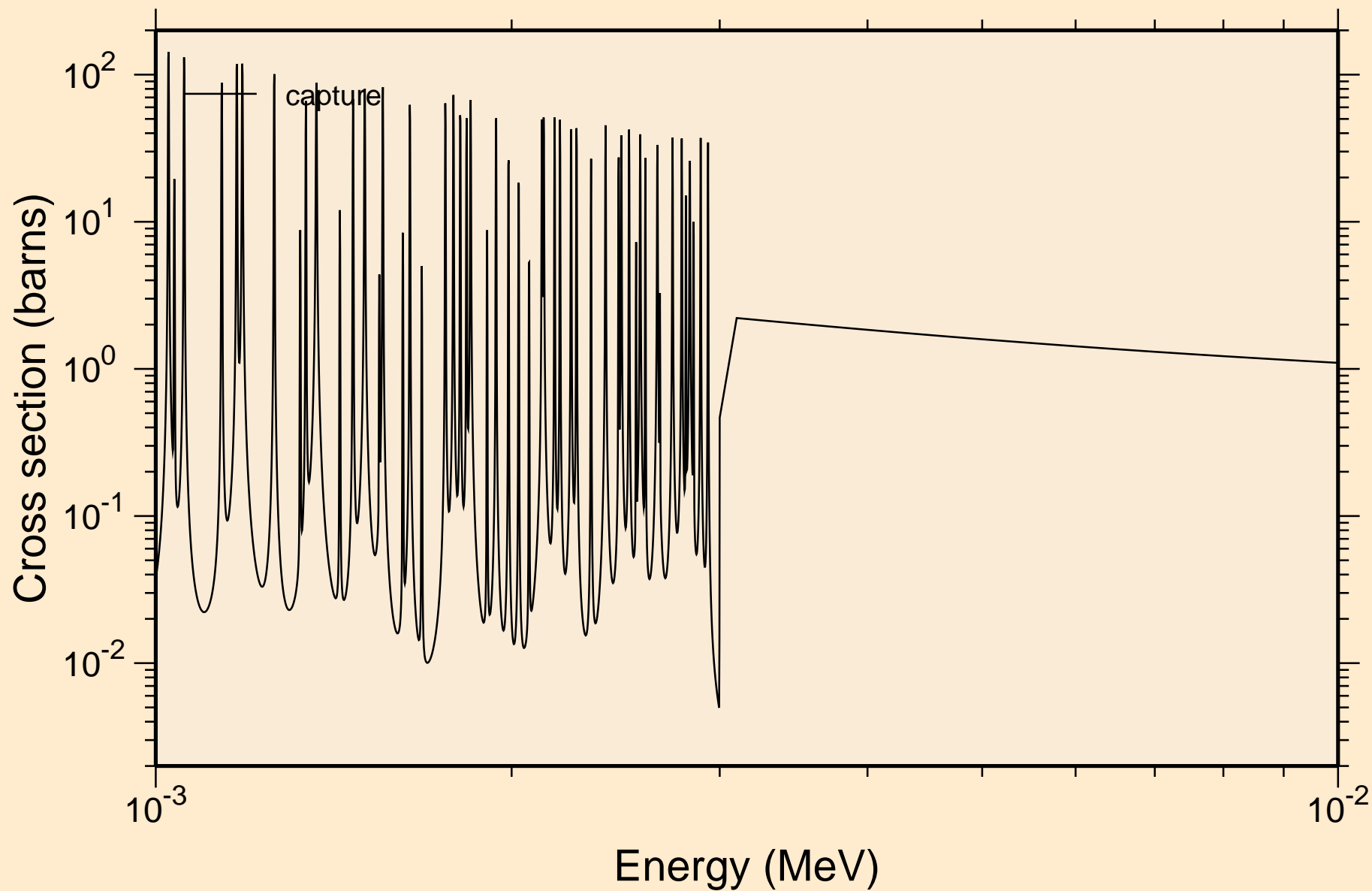

JEFF-3.1 ER-166

Heating

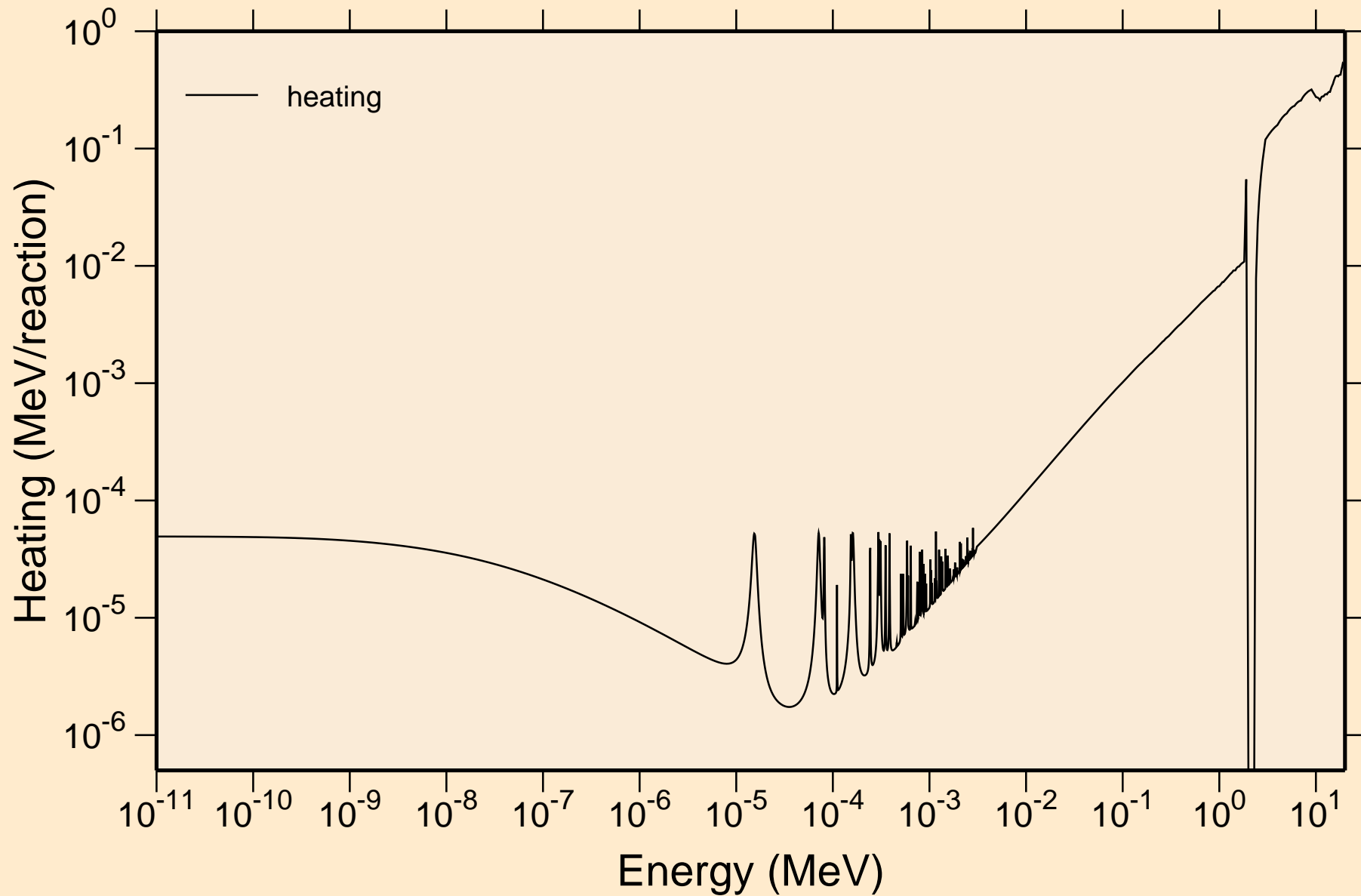

JEFF-3.1 ER-166 Damage

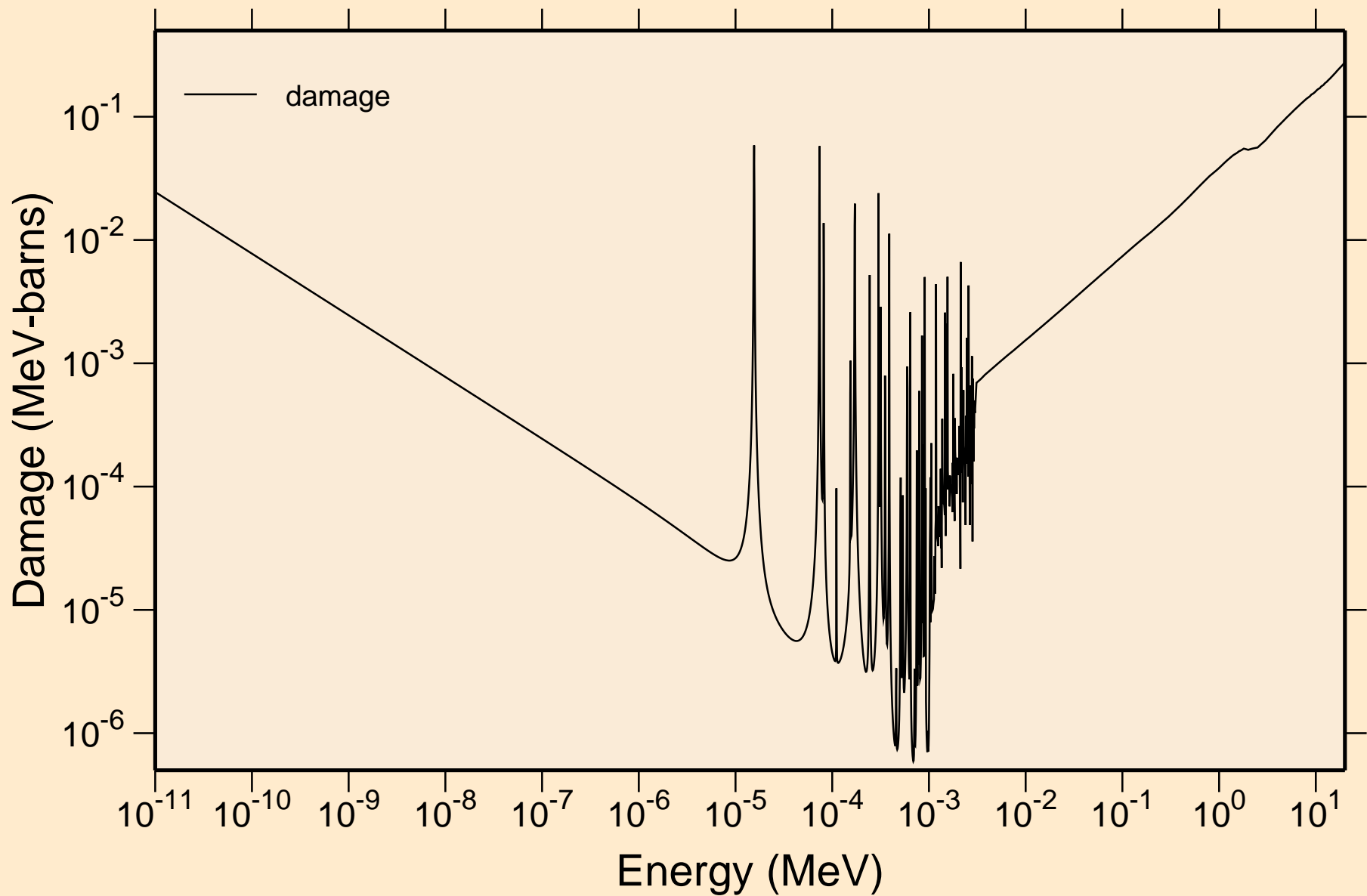

JEFF-3.1 ER-166
Non-threshold reactions

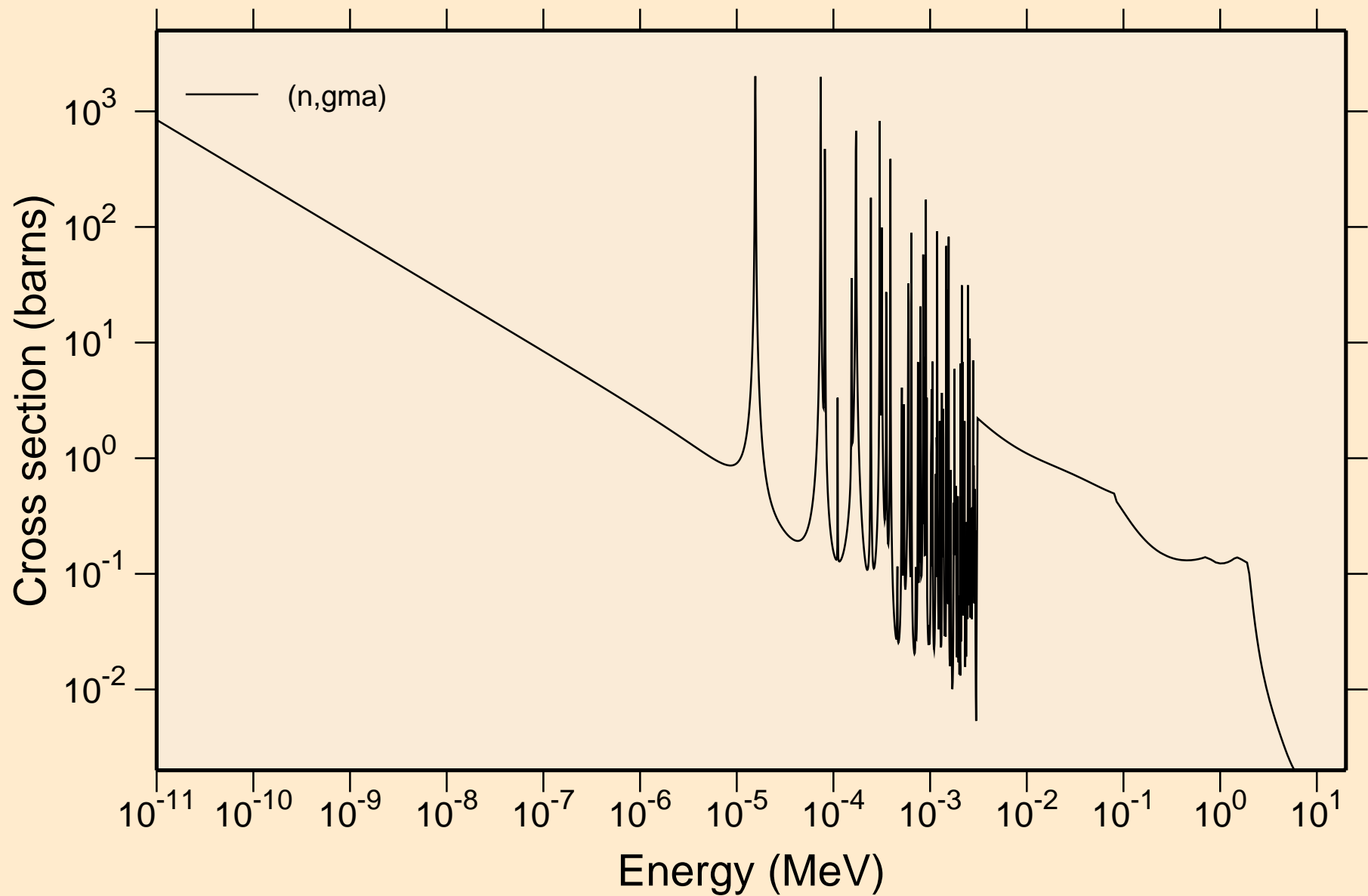

JEFF-3.1 ER-166

Principal cross sections

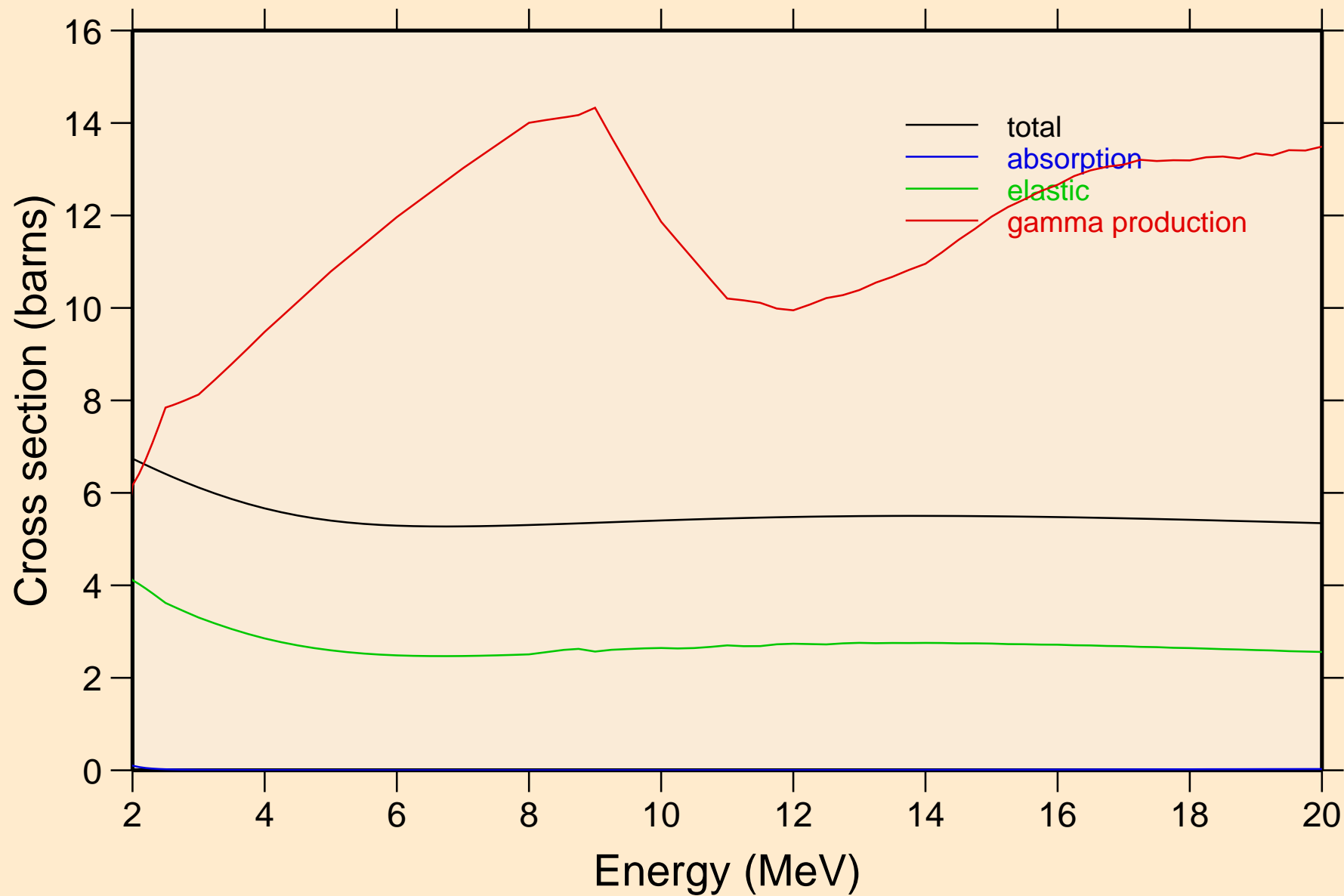

JEFF-3.1 ER-166

Heating

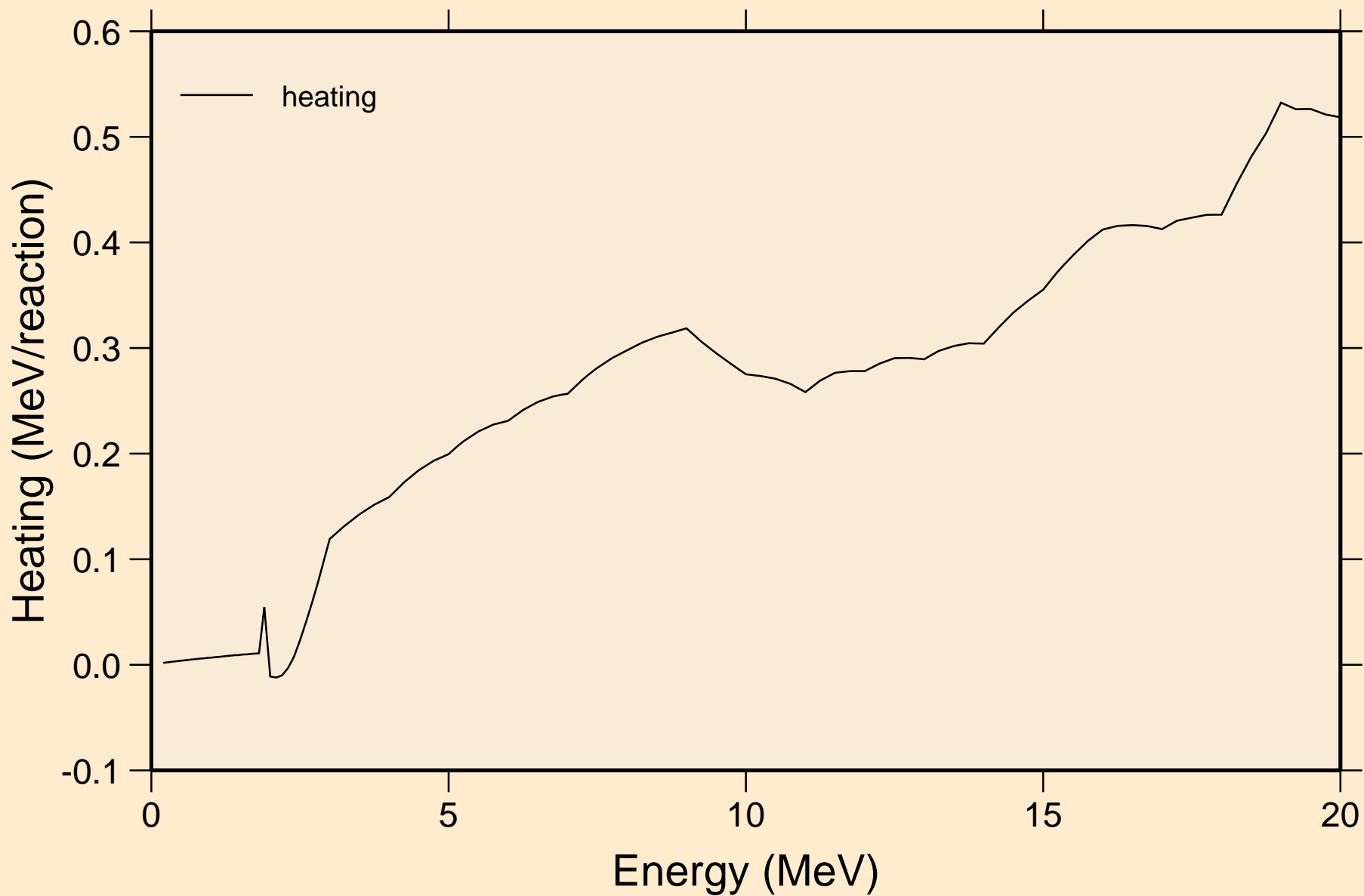

JEFF-3.1 ER-166

Damage

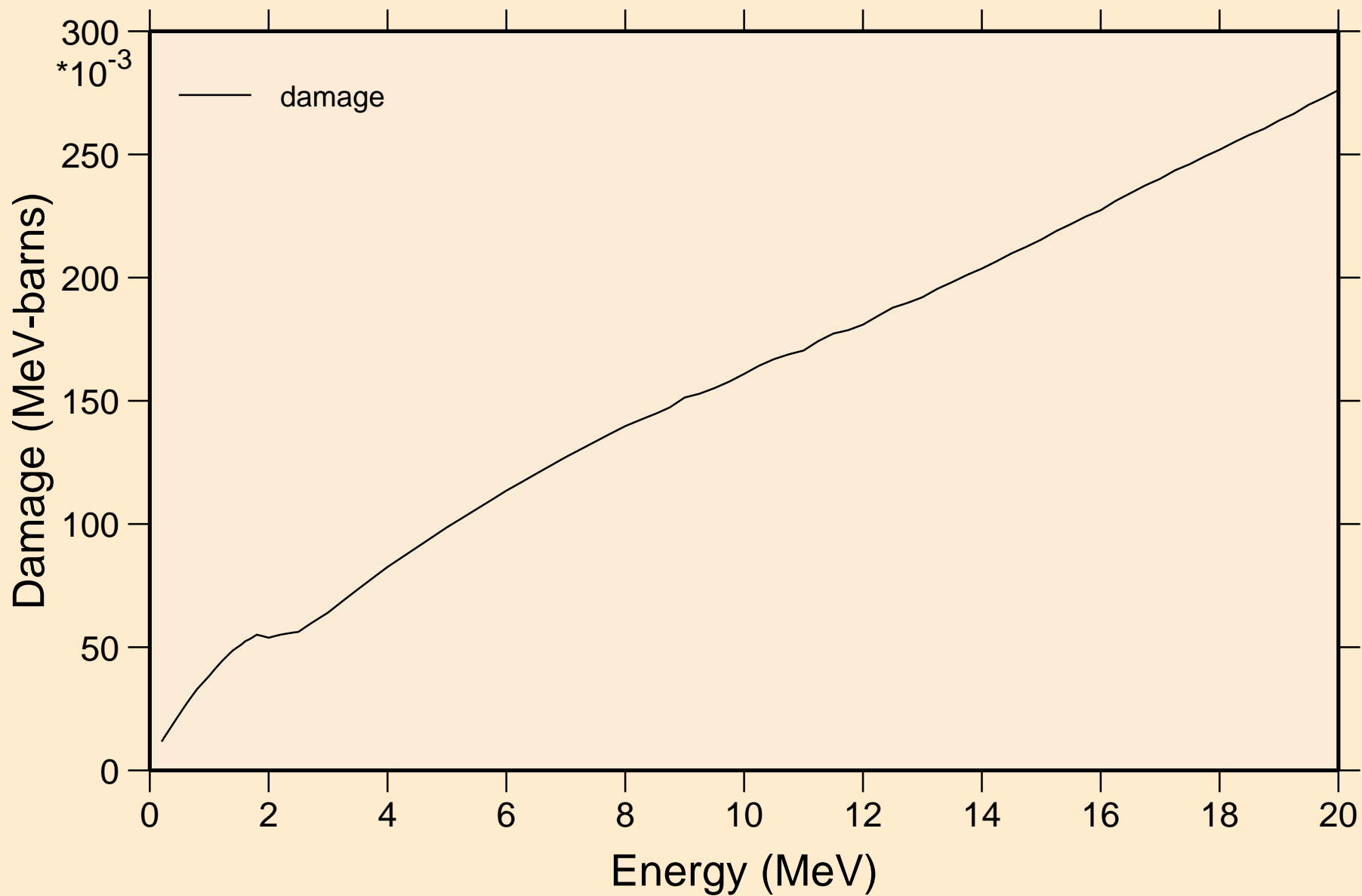

JEFF-3.1 ER-166
Non-threshold reactions

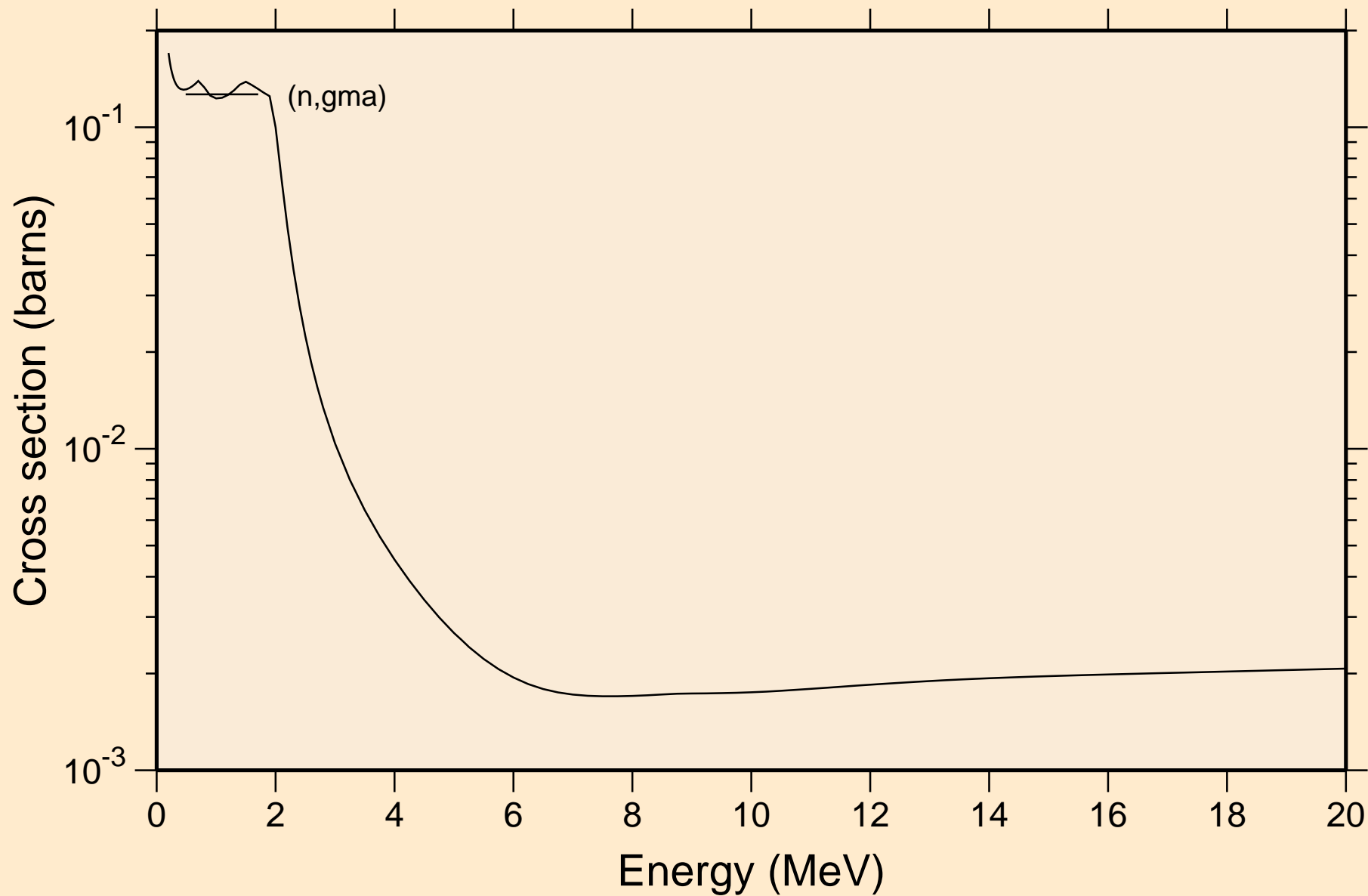

JEFF-3.1 ER-166

Inelastic levels

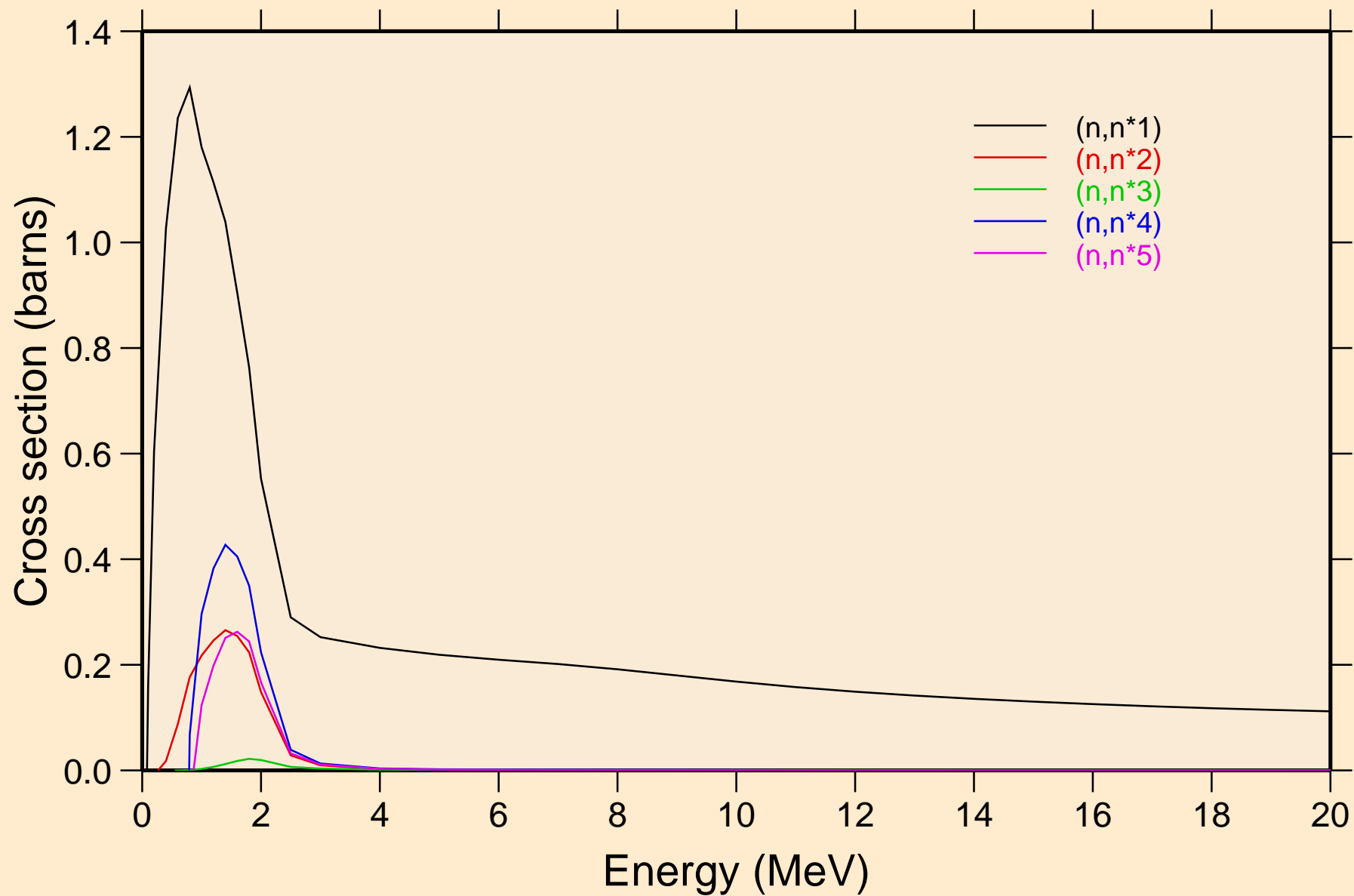

JEFF-3.1 ER-166

Inelastic levels

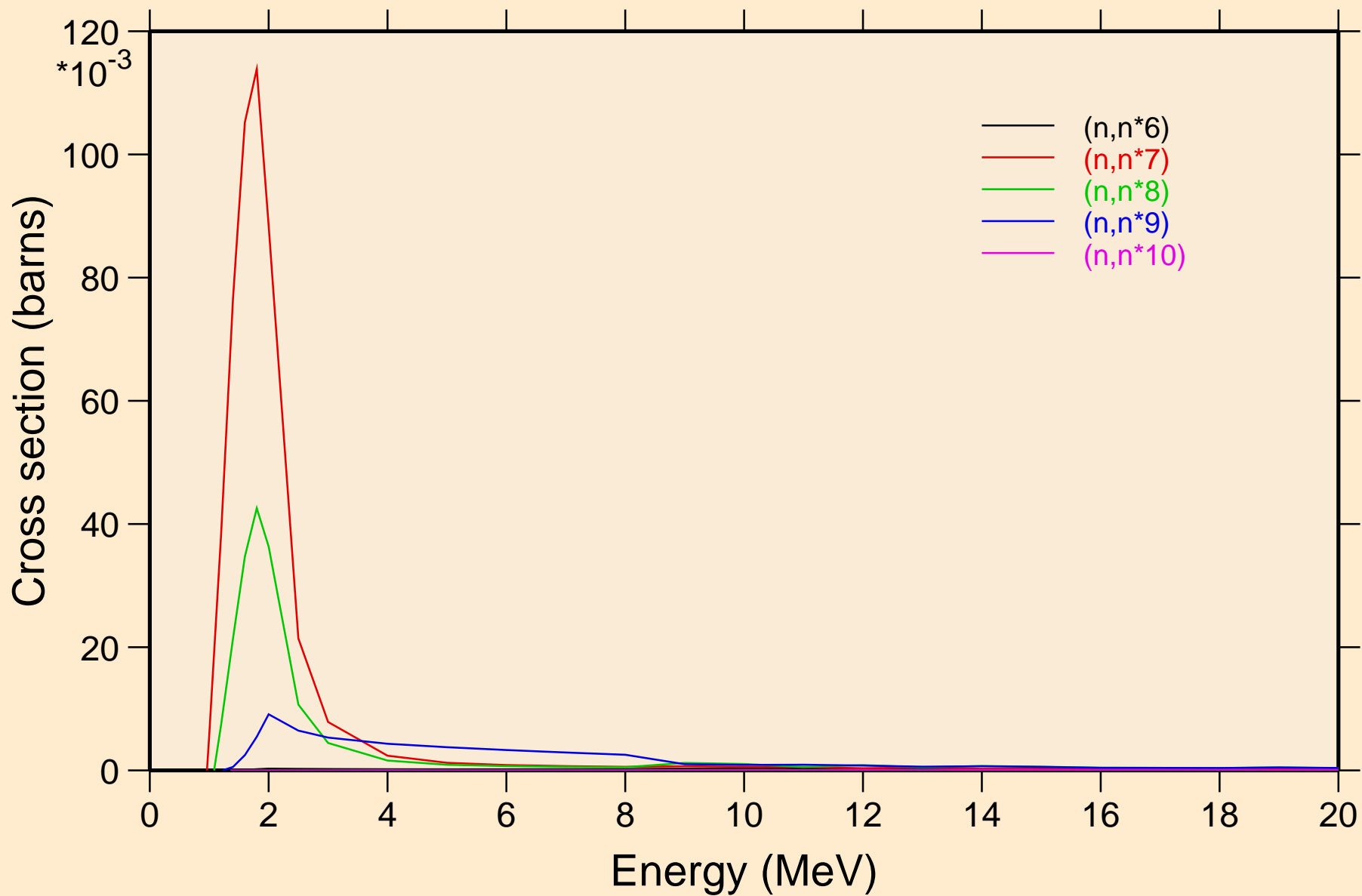

JEFF-3.1 ER-166

Inelastic levels

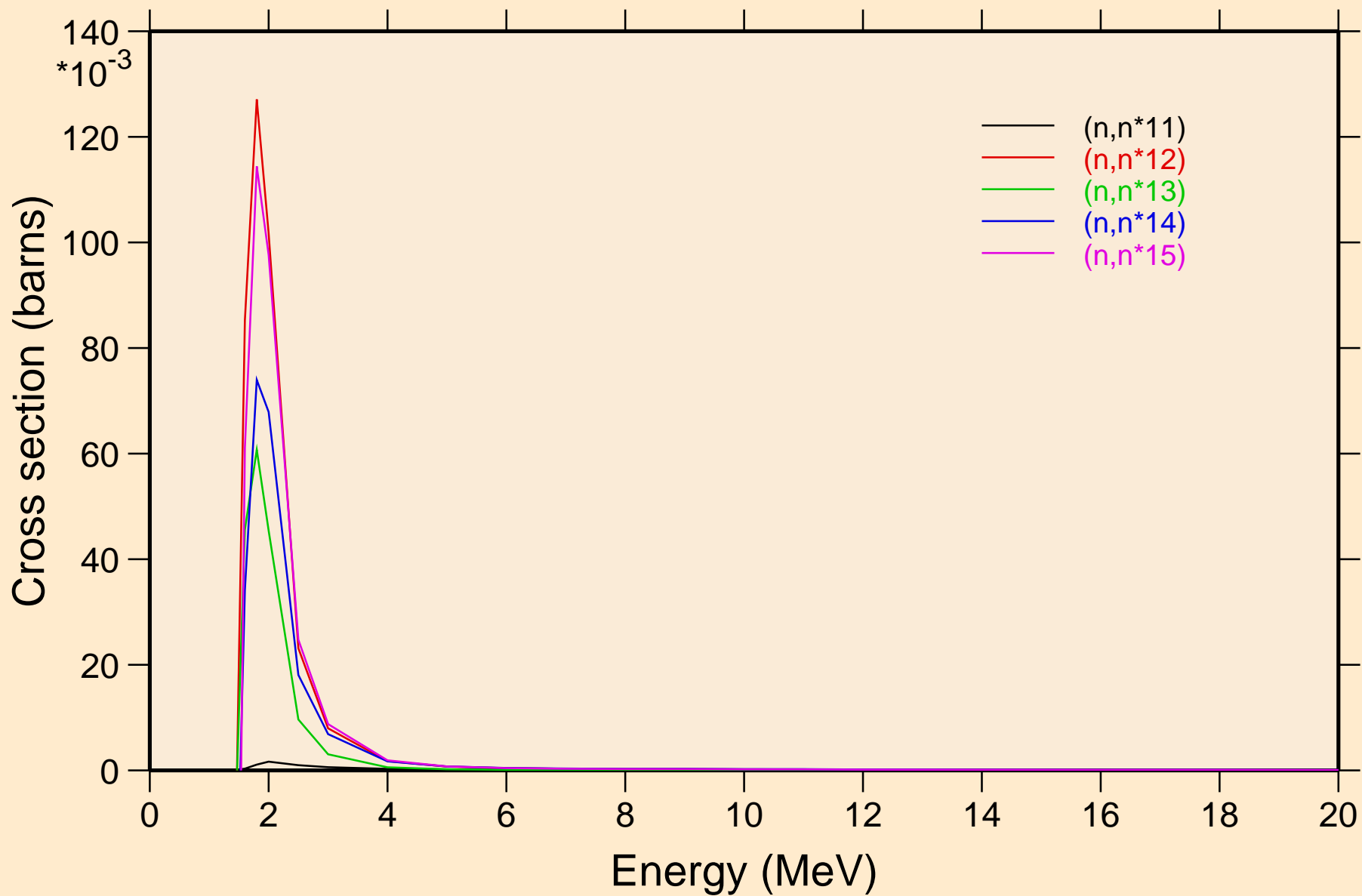

JEFF-3.1 ER-166

Inelastic levels

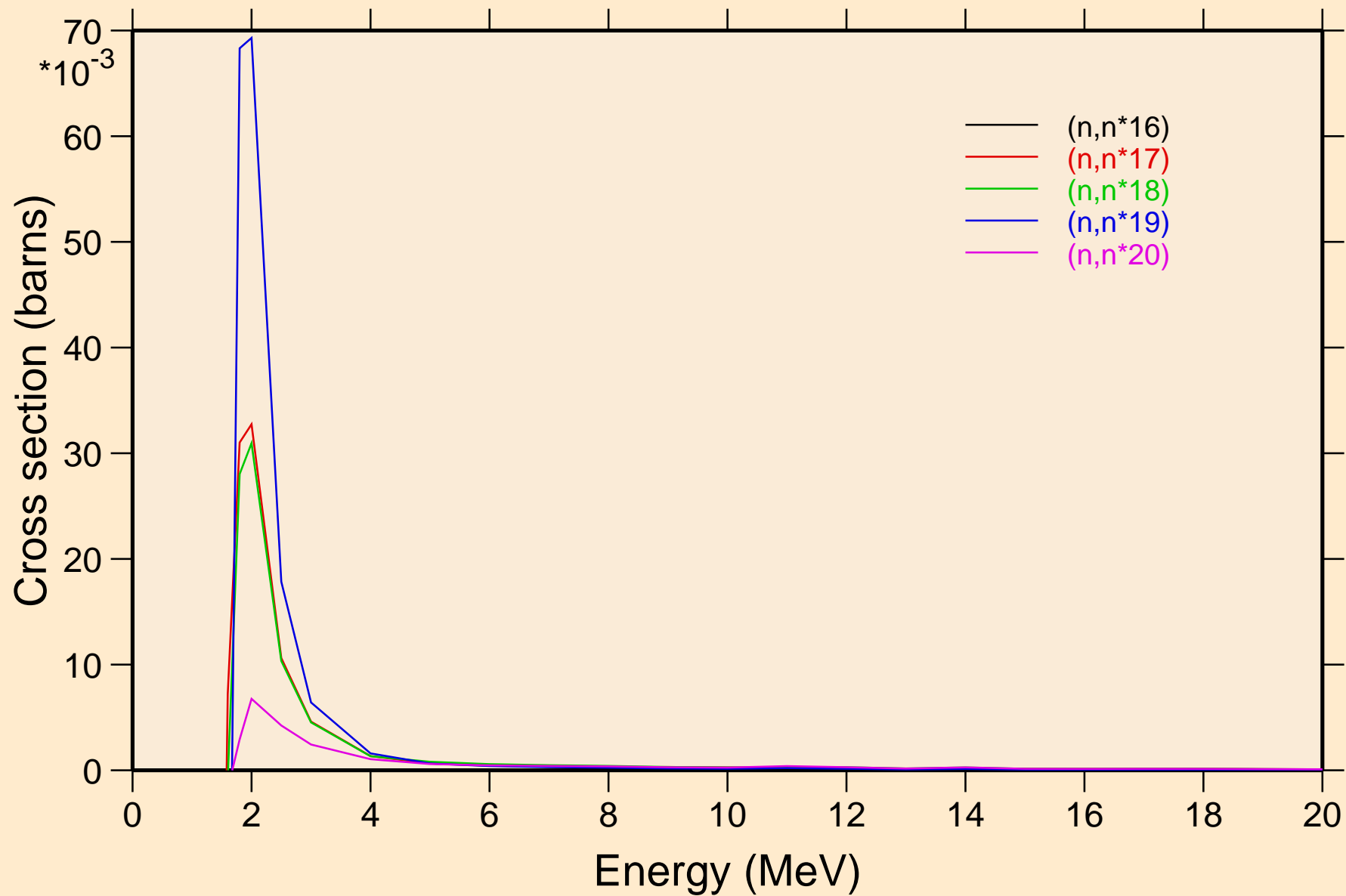

JEFF-3.1 ER-166

Inelastic levels

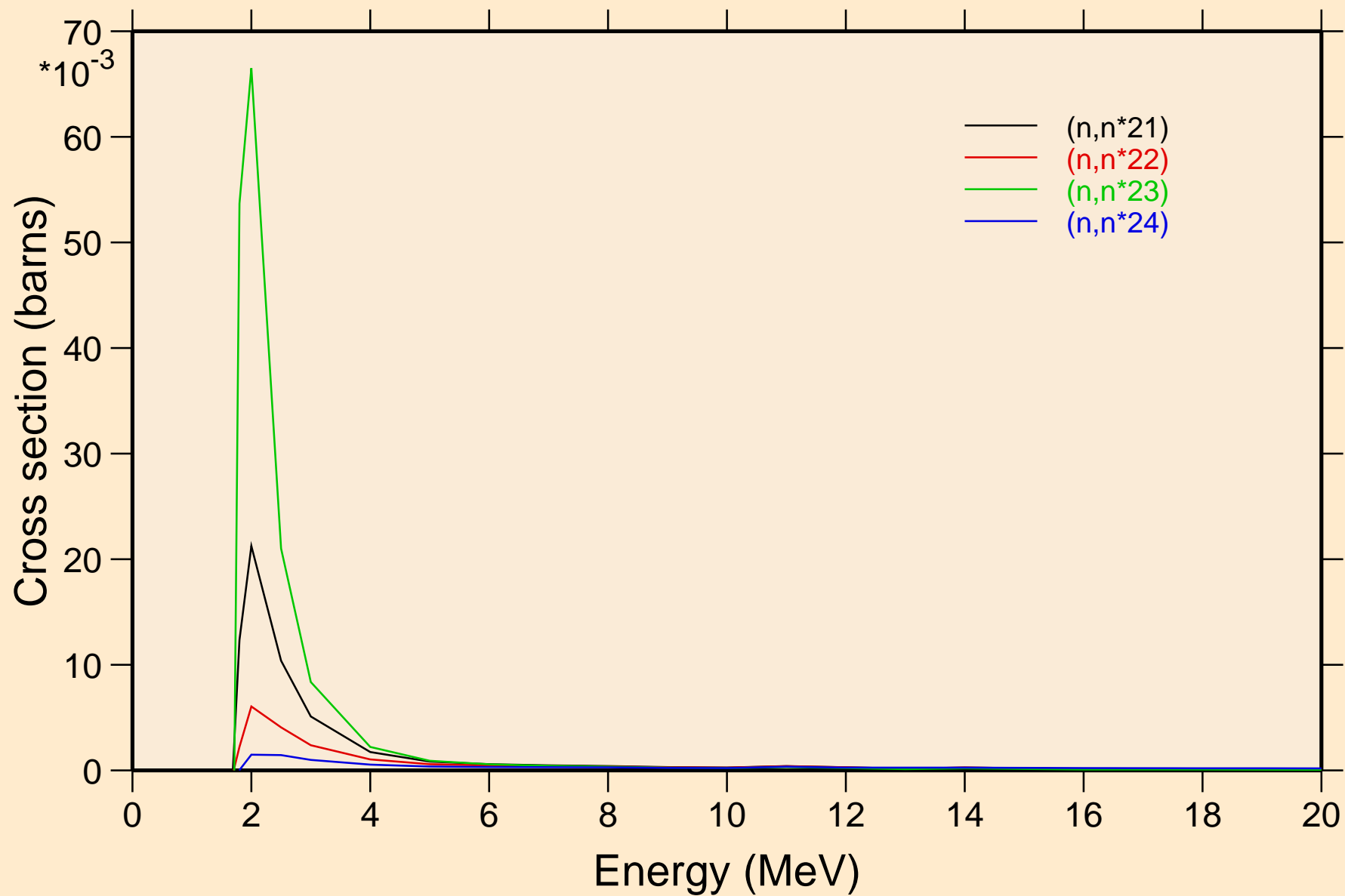

JEFF-3.1 ER-166

Threshold reactions

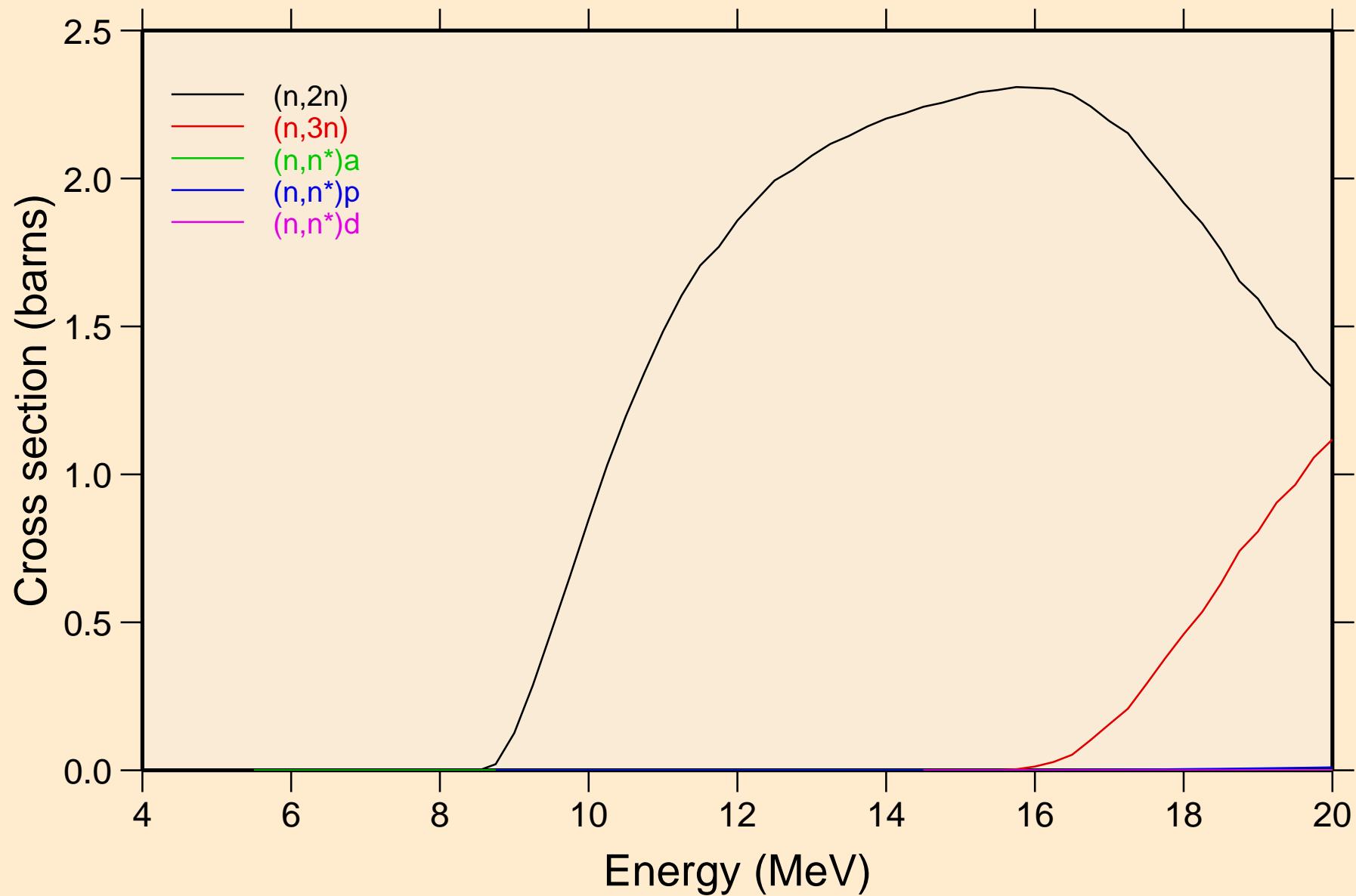

JEFF-3.1 ER-166

Threshold reactions

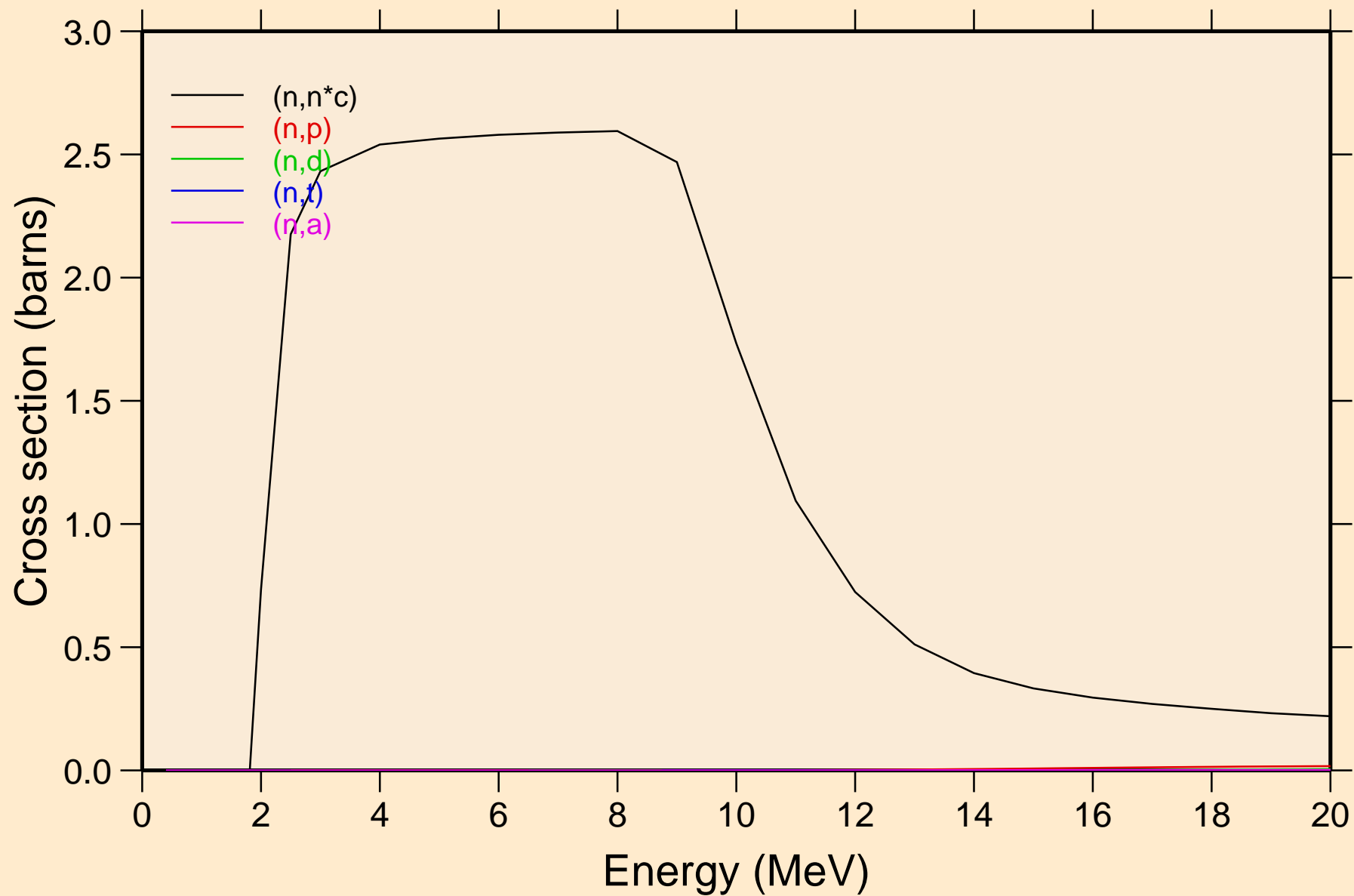

JEFF-3.1 ER-166

Threshold reactions

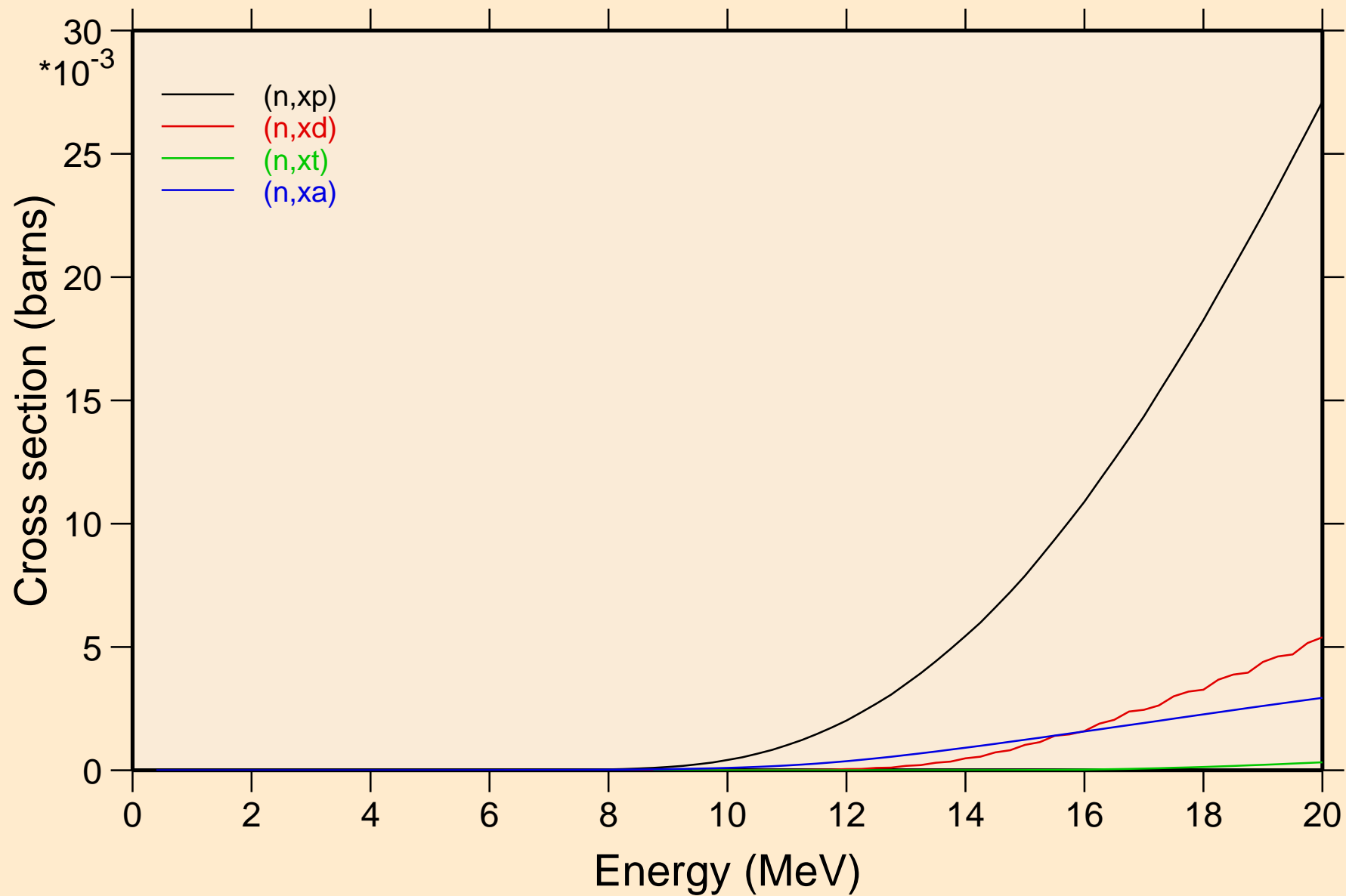

JEFF-3.1 ER-166
angular distribution for elastic

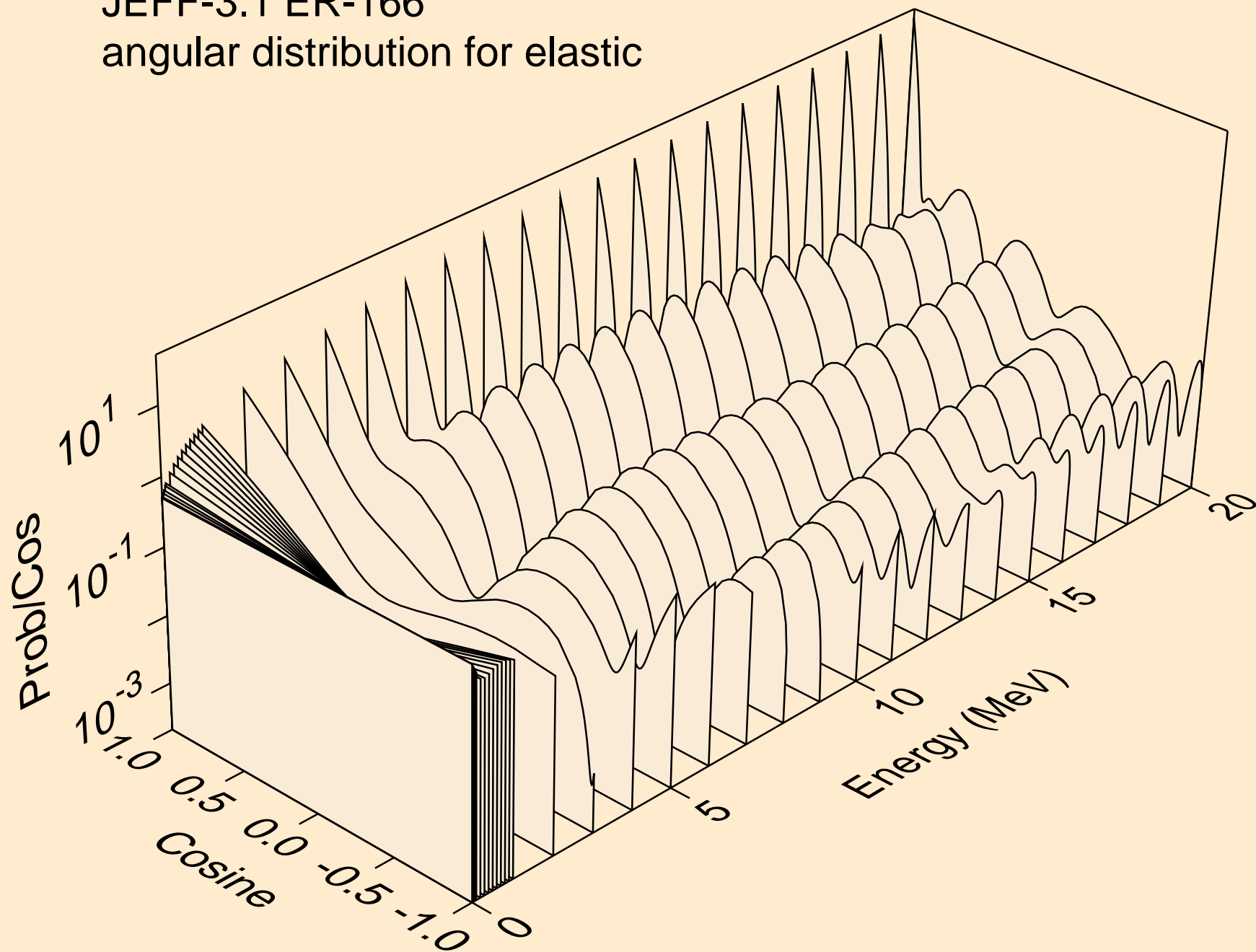

JEFF-3.1 ER-166
angular distribution for (n,n*1)

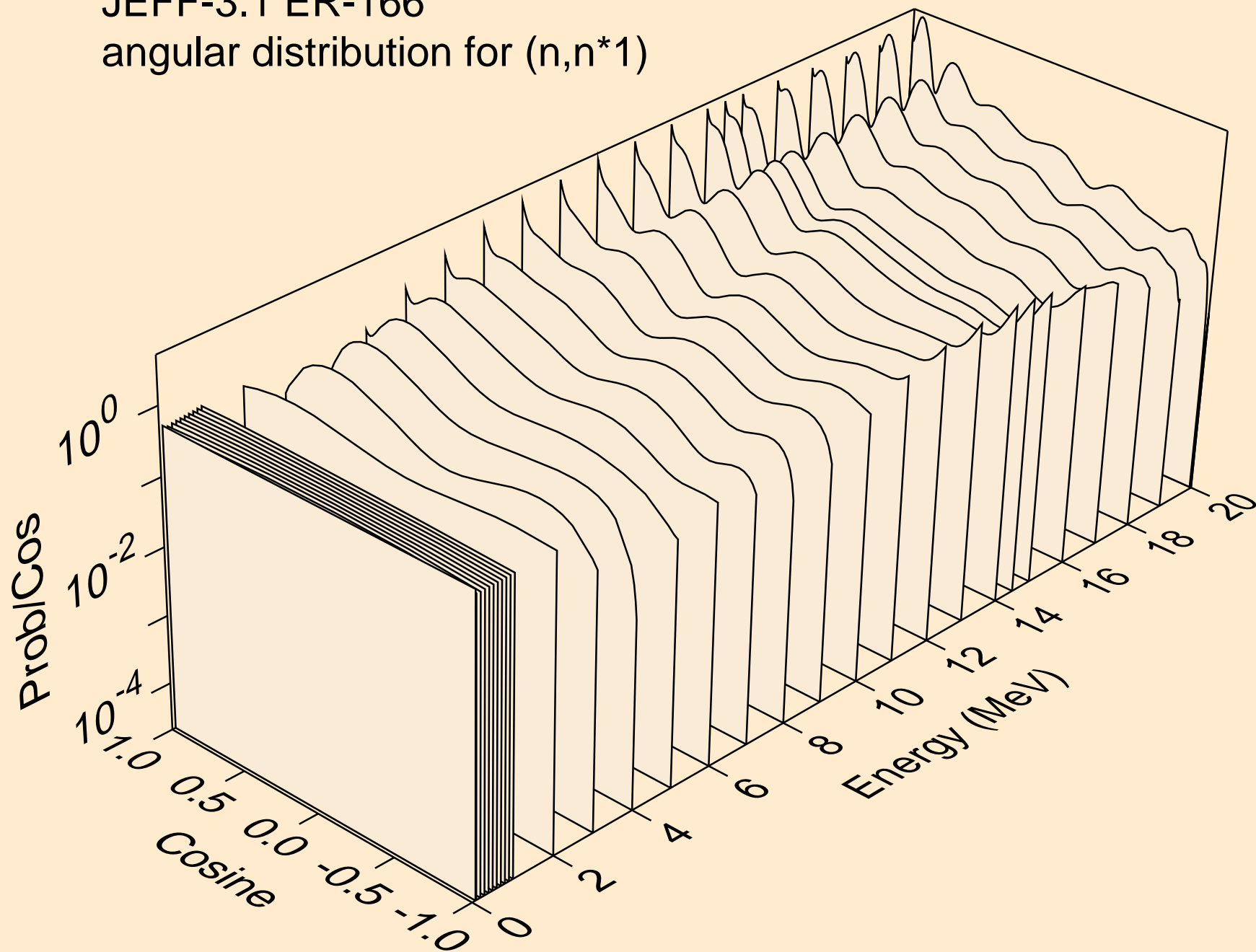

JEFF-3.1 ER-166
angular distribution for (n,n*2)

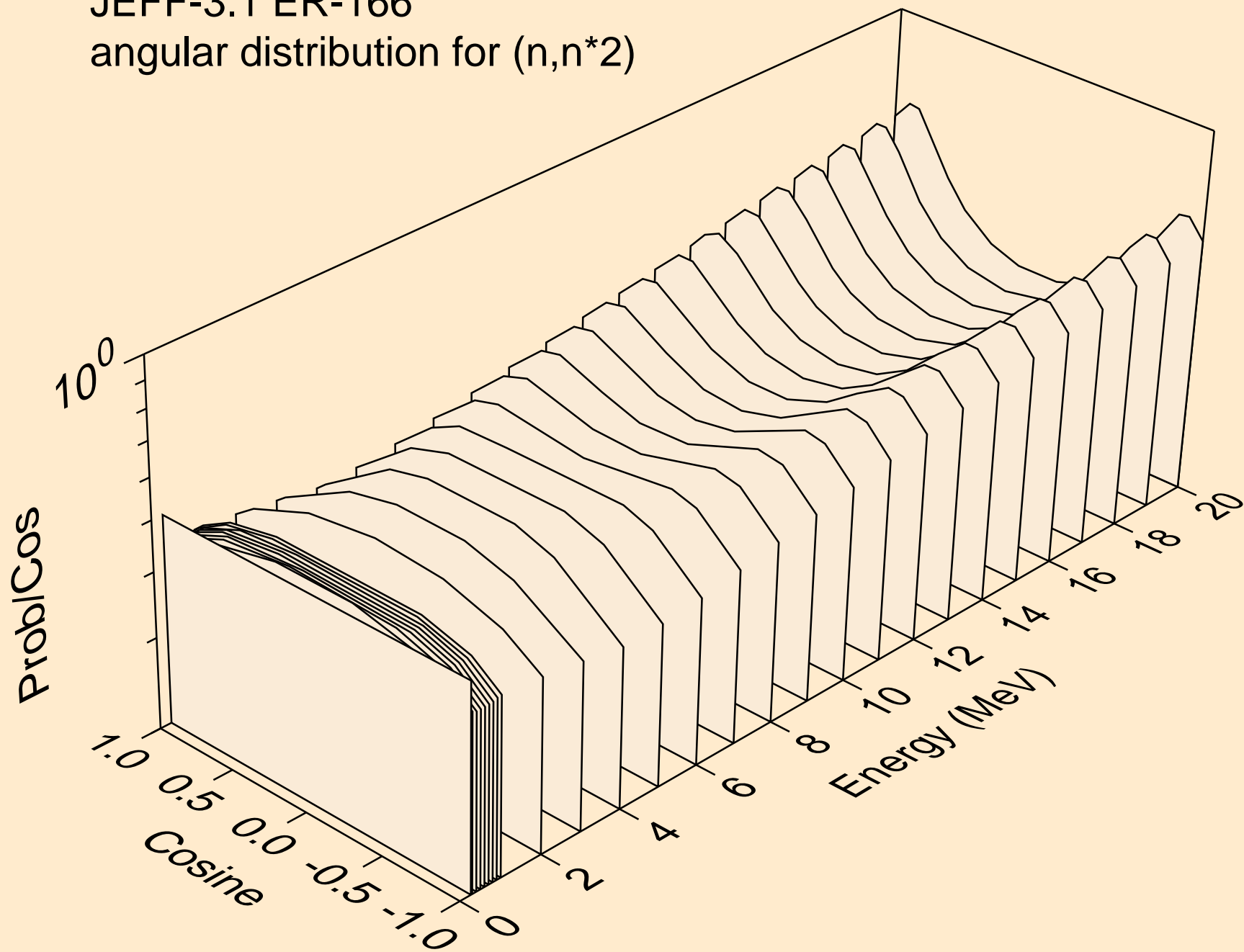

JEFF-3.1 ER-166
angular distribution for (n,n*3)

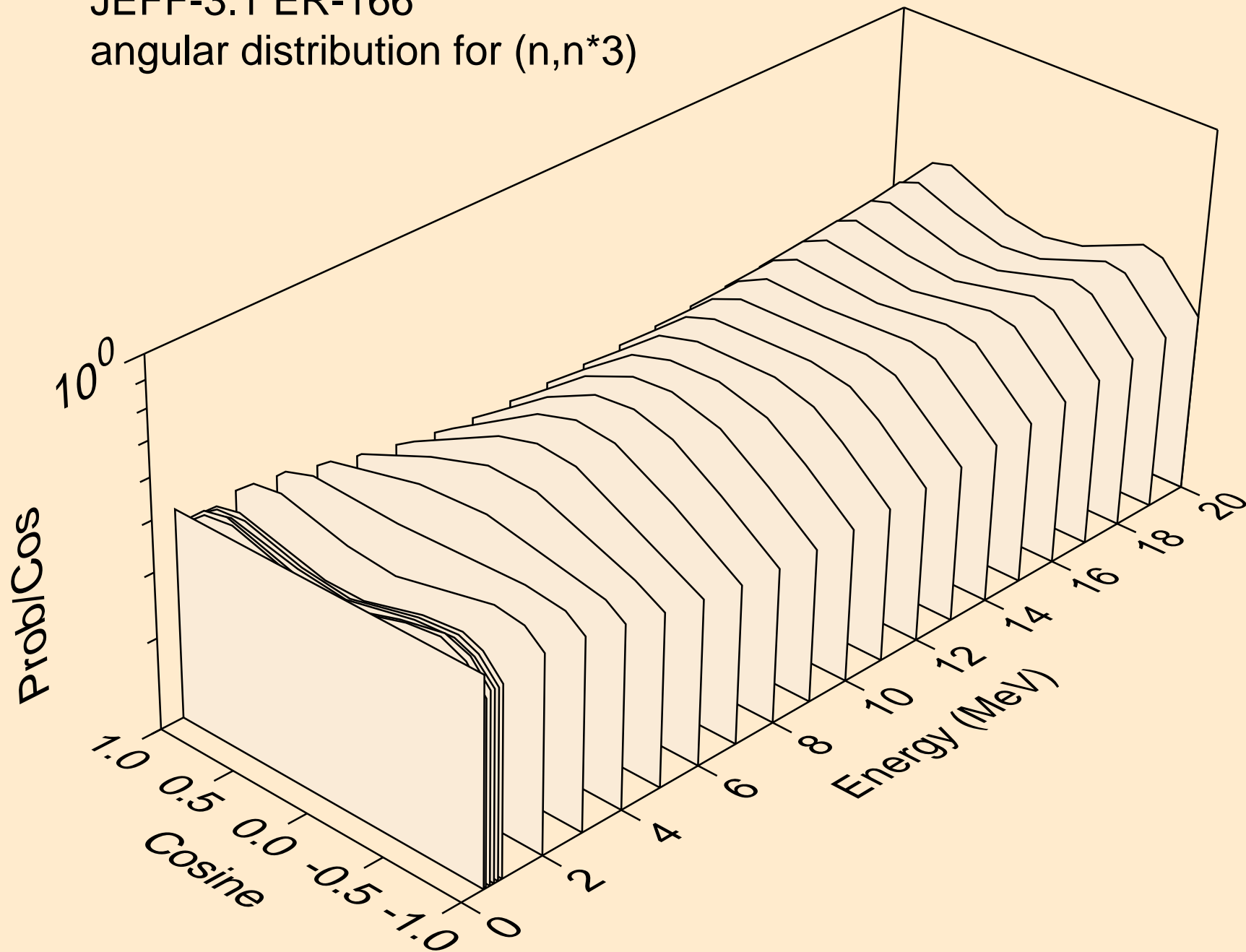

JEFF-3.1 ER-166
angular distribution for (n,n*4)

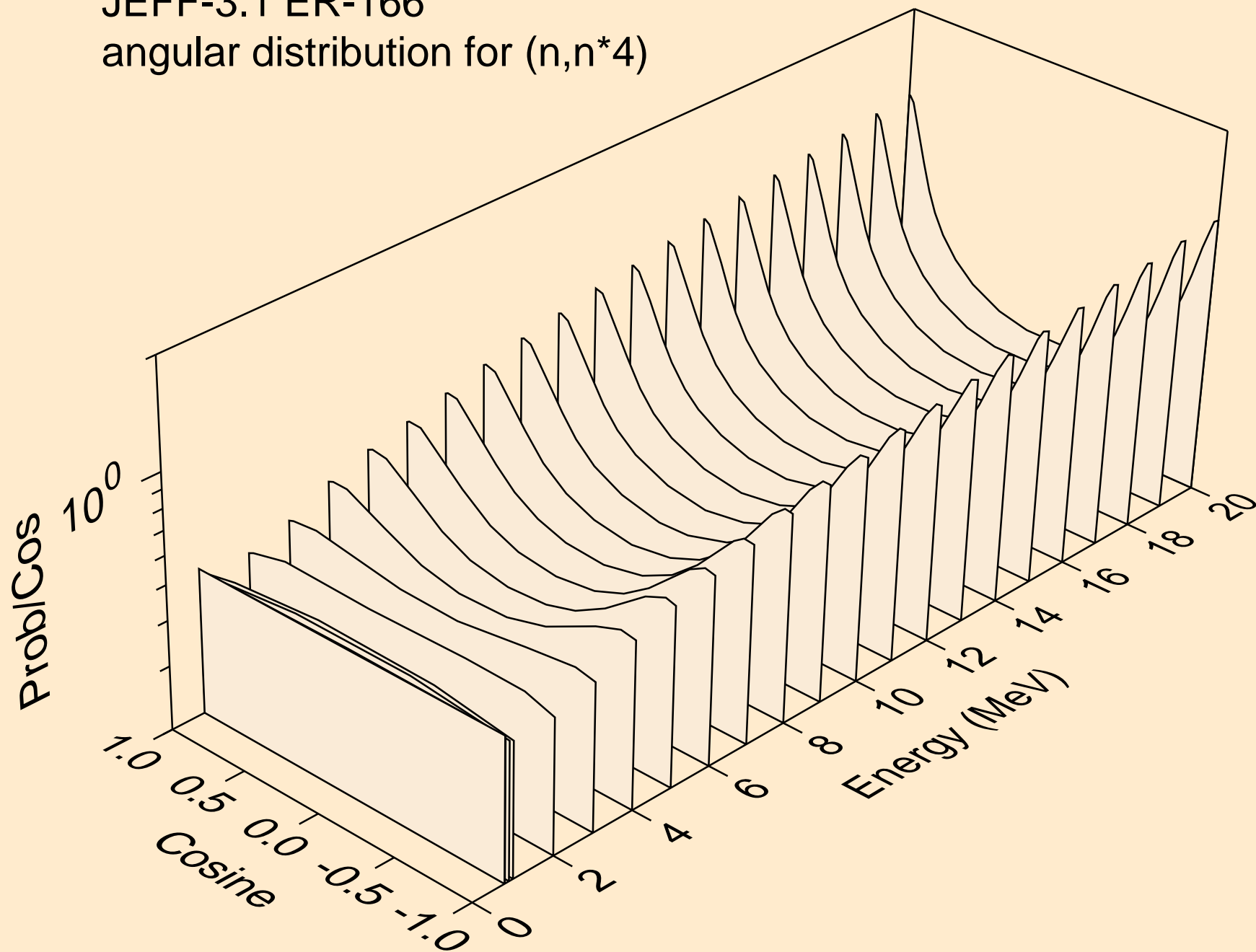

JEFF-3.1 ER-166
angular distribution for (n,n*5)

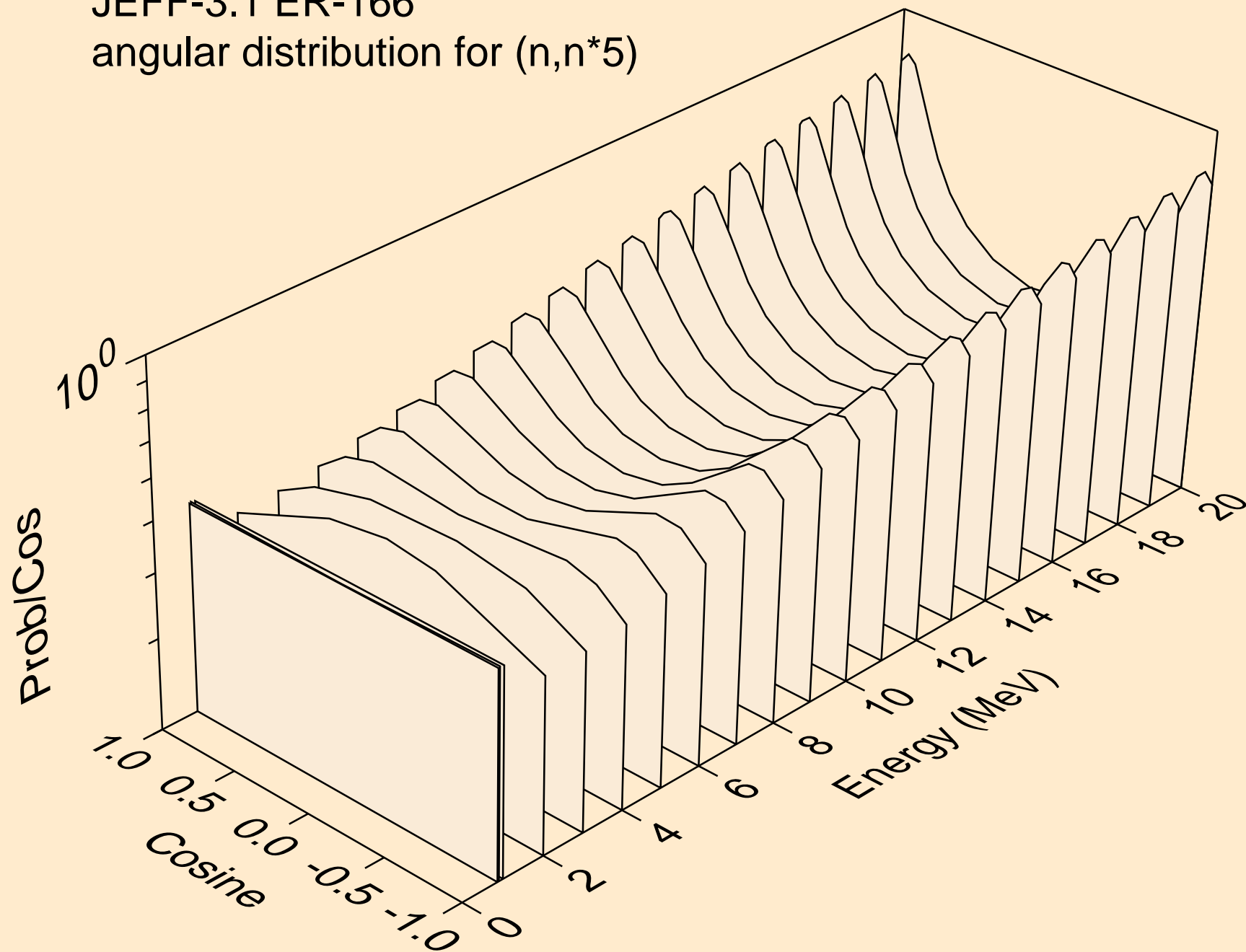

JEFF-3.1 ER-166
angular distribution for (n,n*6)

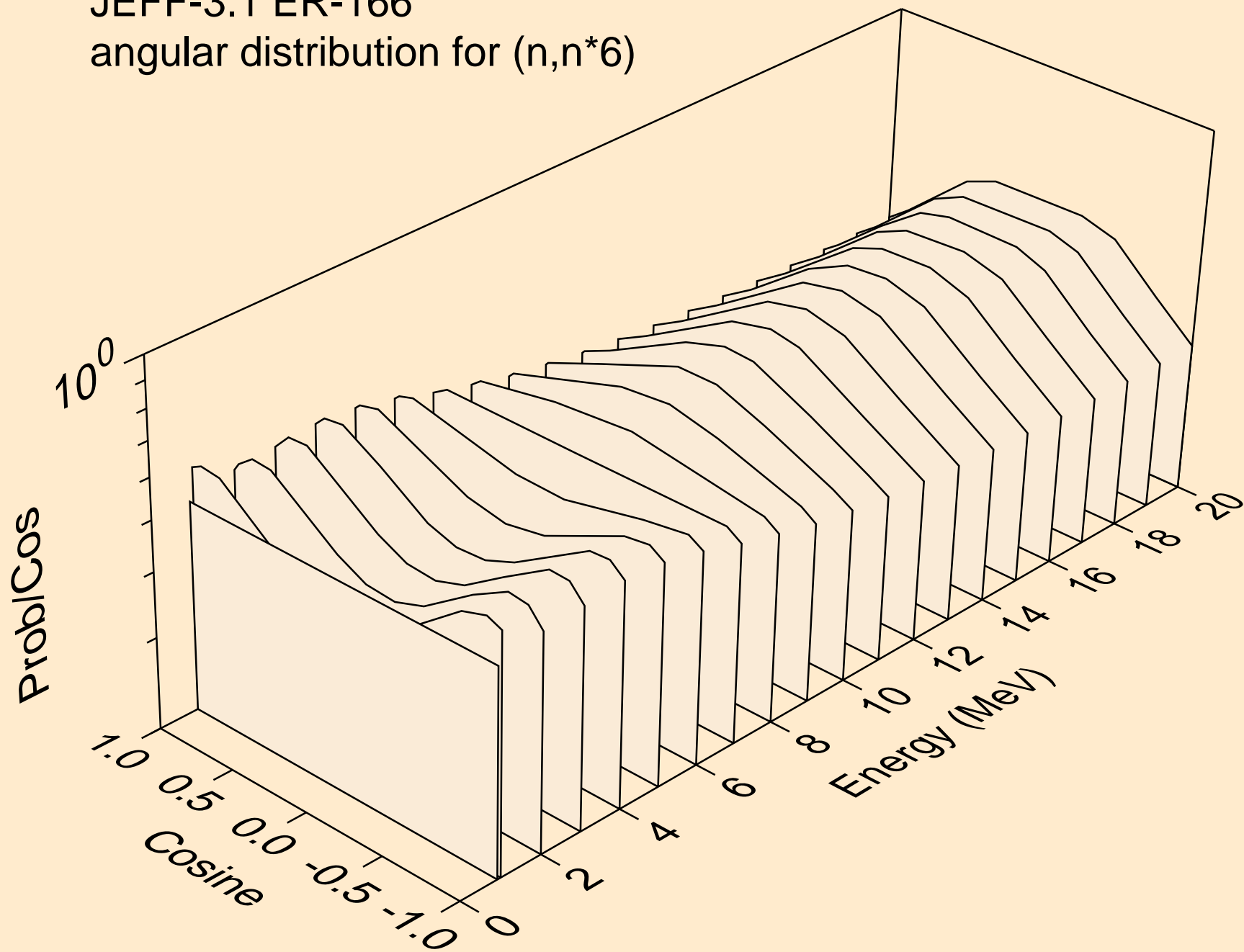

JEFF-3.1 ER-166
angular distribution for (n,n*7)

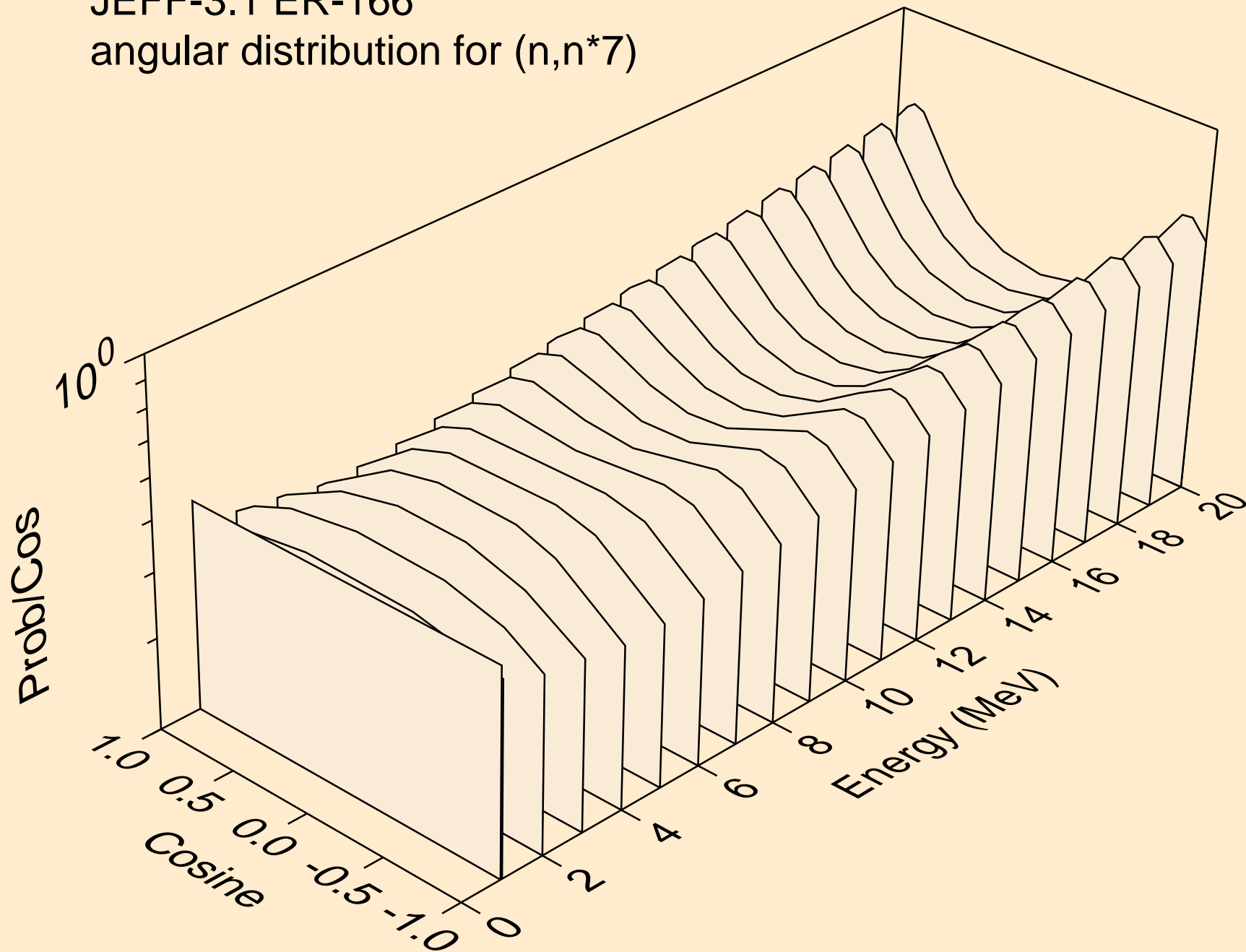

JEFF-3.1 ER-166
angular distribution for (n,n*8)

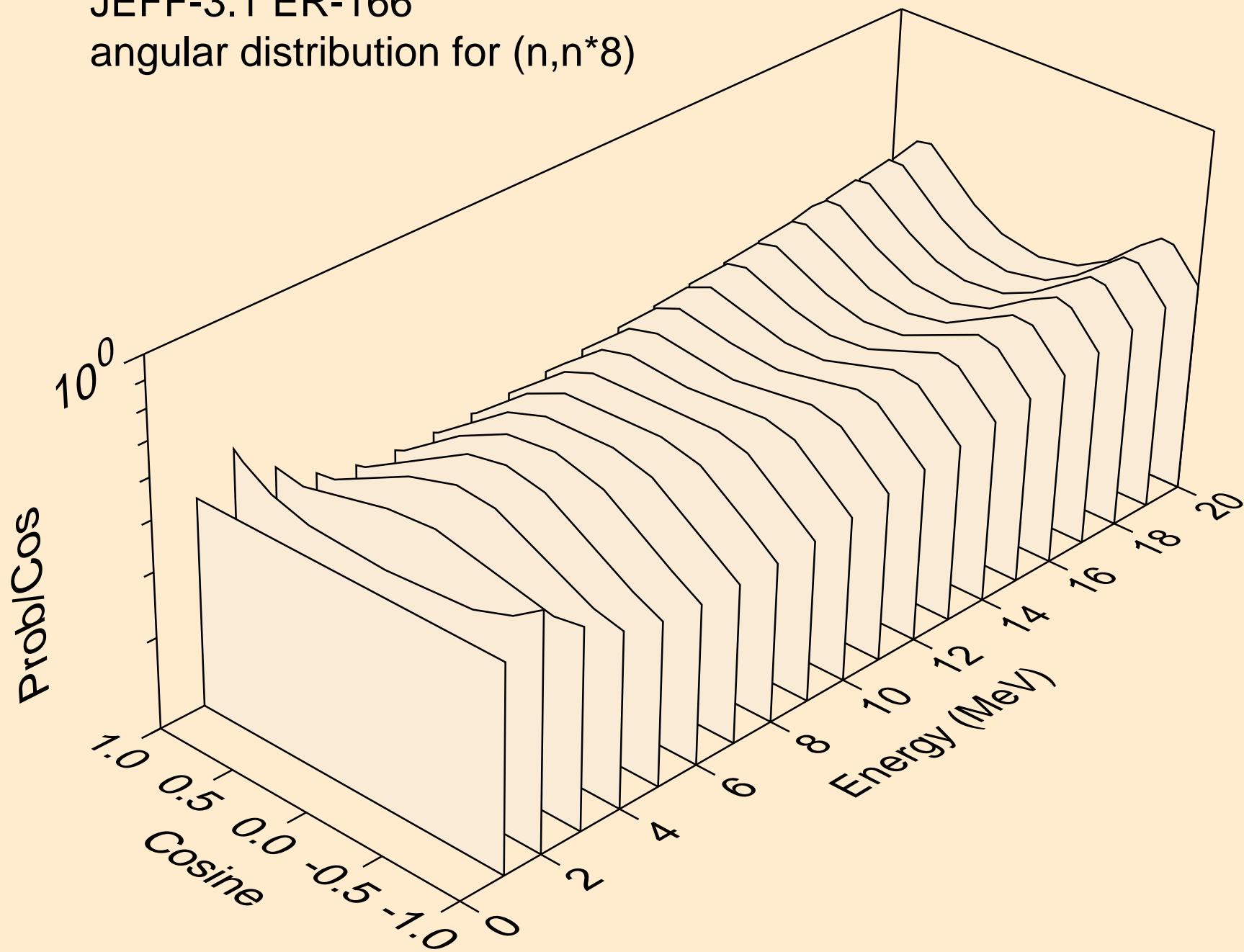

JEFF-3.1 ER-166
angular distribution for (n,n*9)

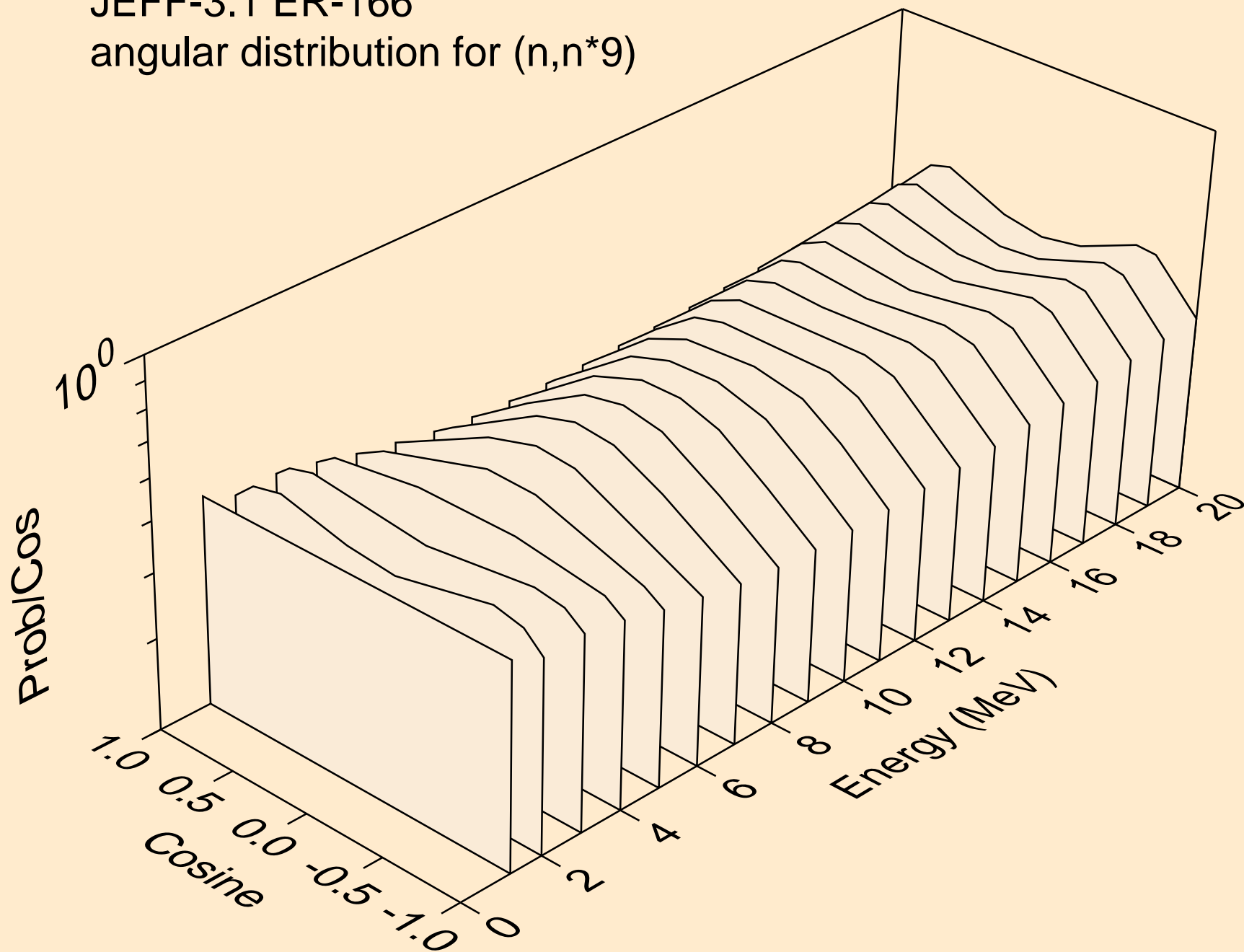

JEFF-3.1 ER-166
angular distribution for (n,n*10)

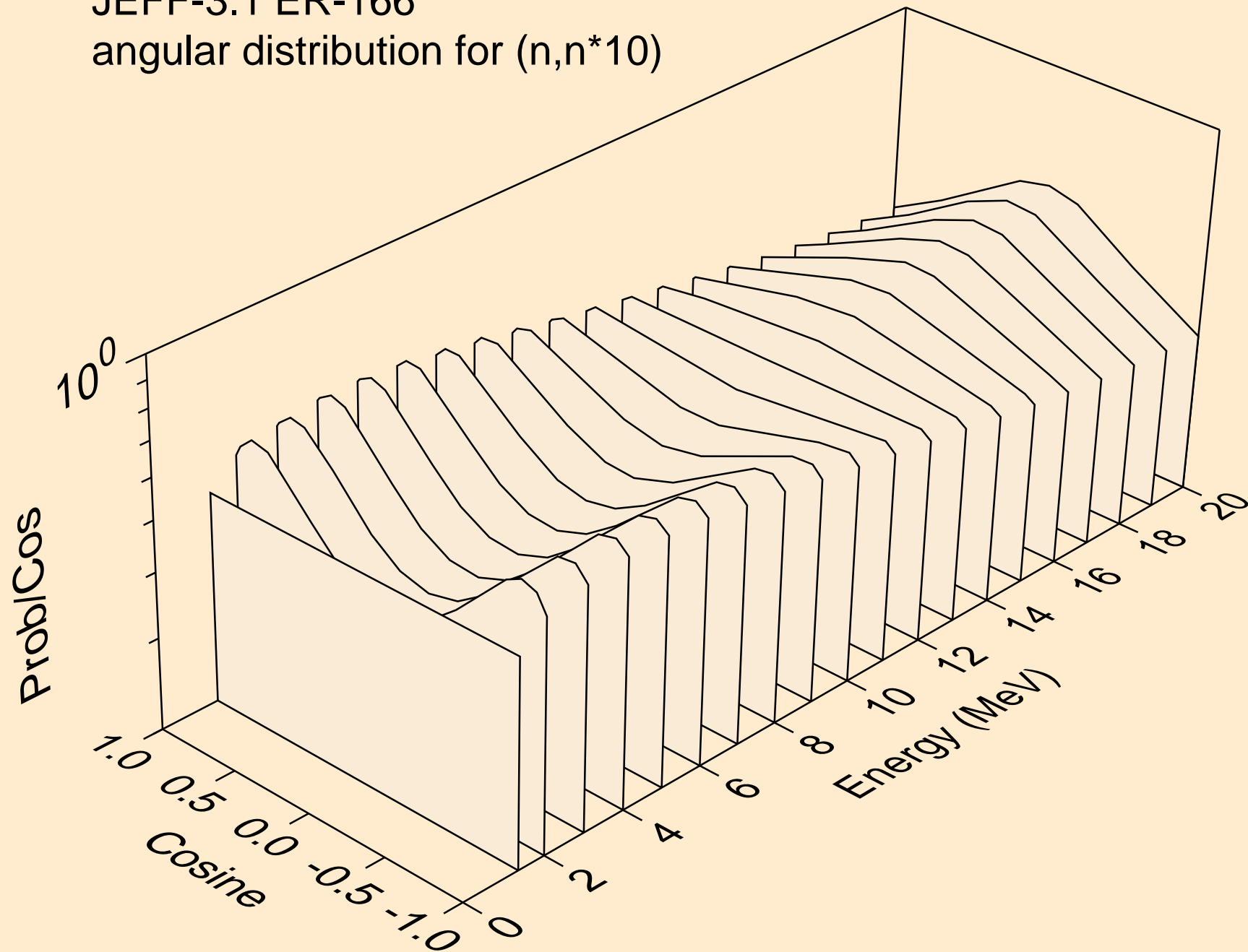

JEFF-3.1 ER-166
angular distribution for (n,n*11)

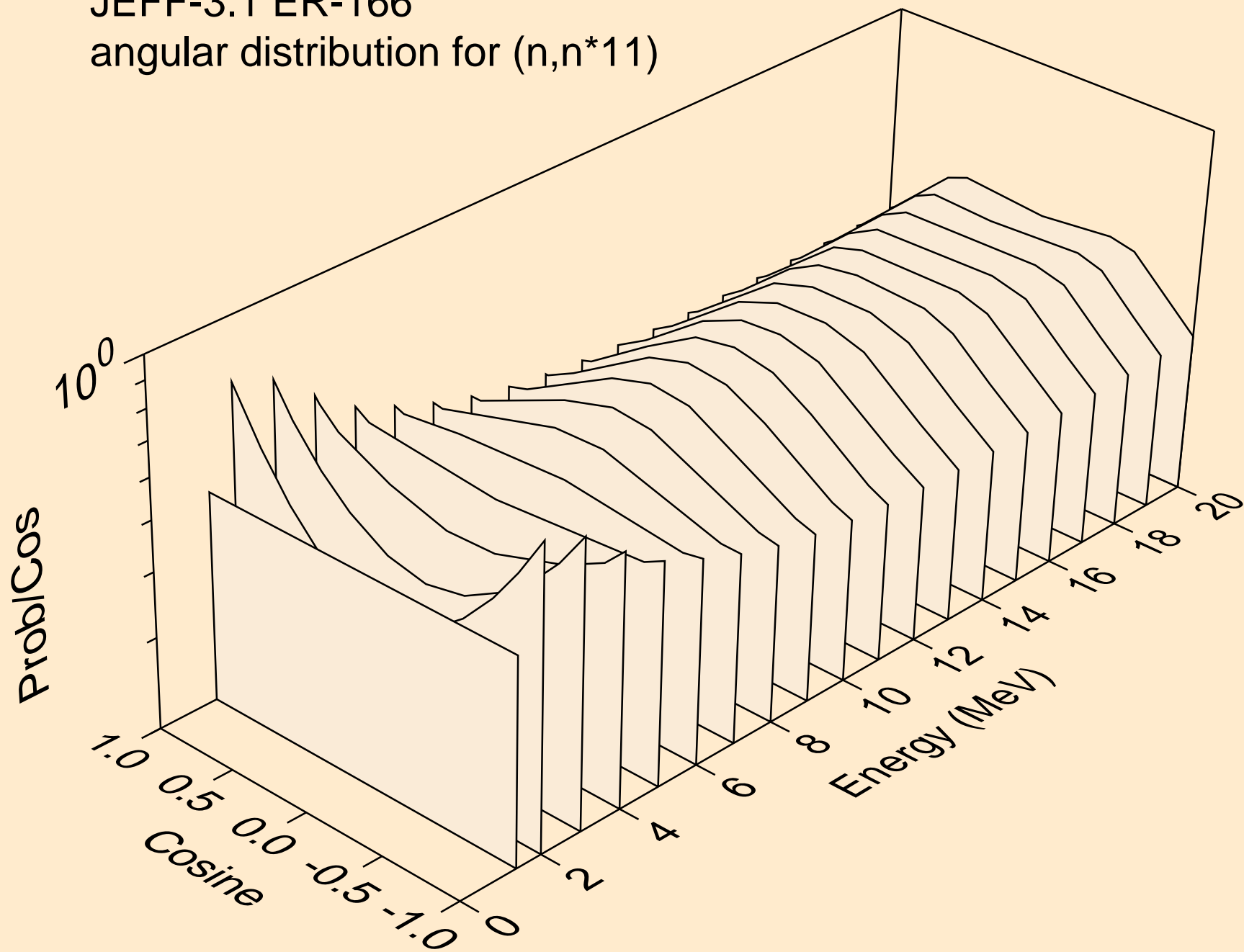

JEFF-3.1 ER-166
angular distribution for (n,n*12)

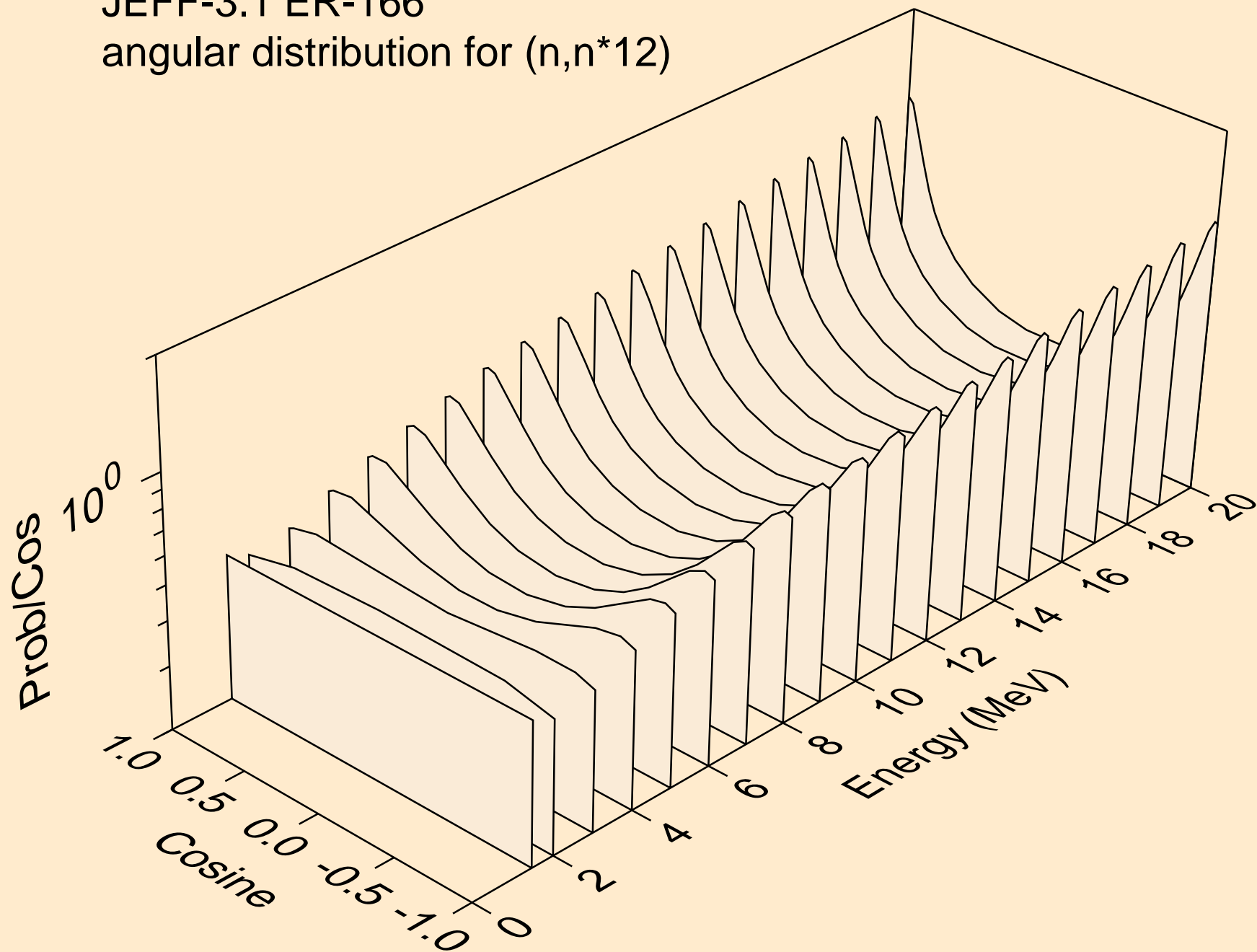

JEFF-3.1 ER-166
angular distribution for (n,n*13)

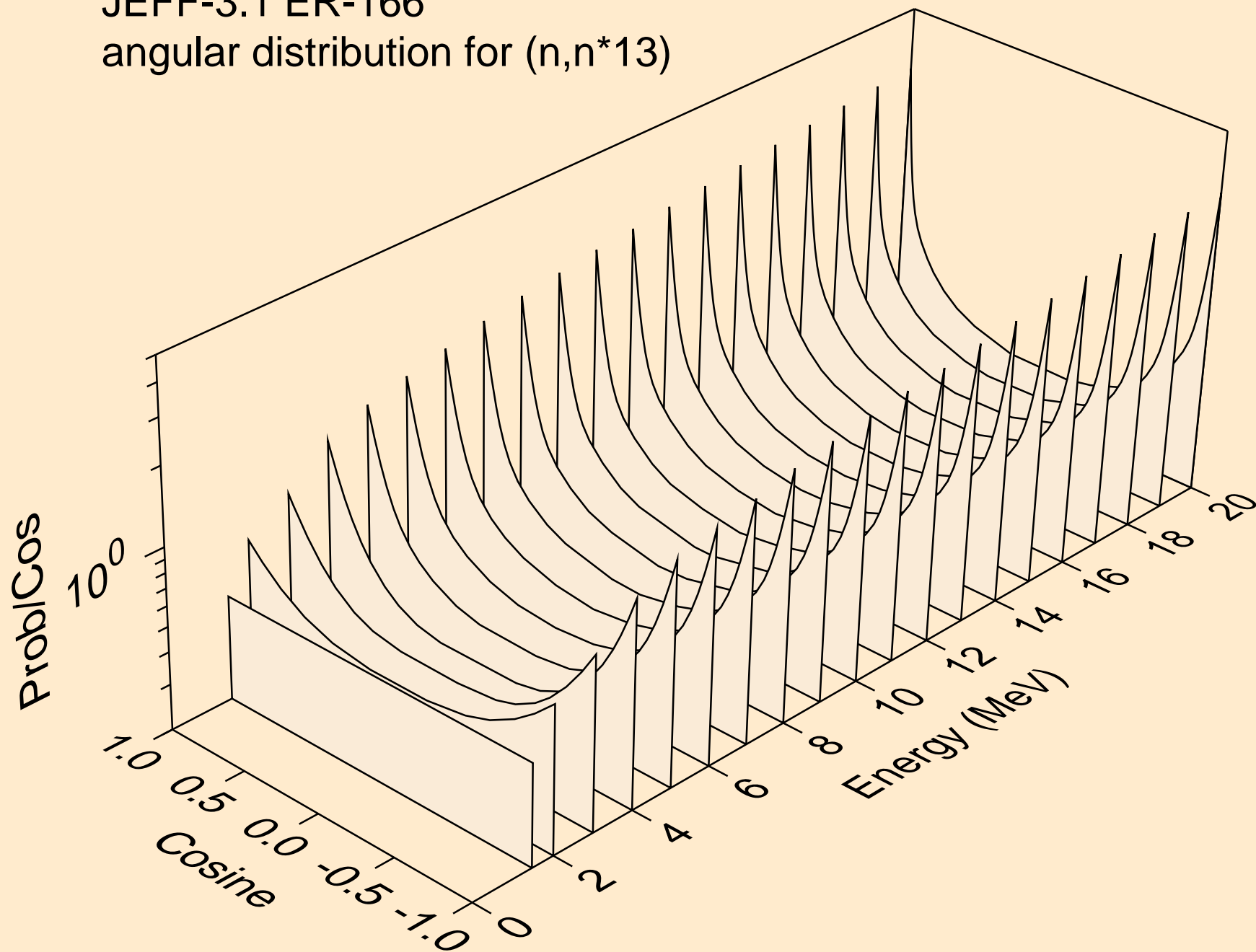

JEFF-3.1 ER-166
angular distribution for (n,n*14)

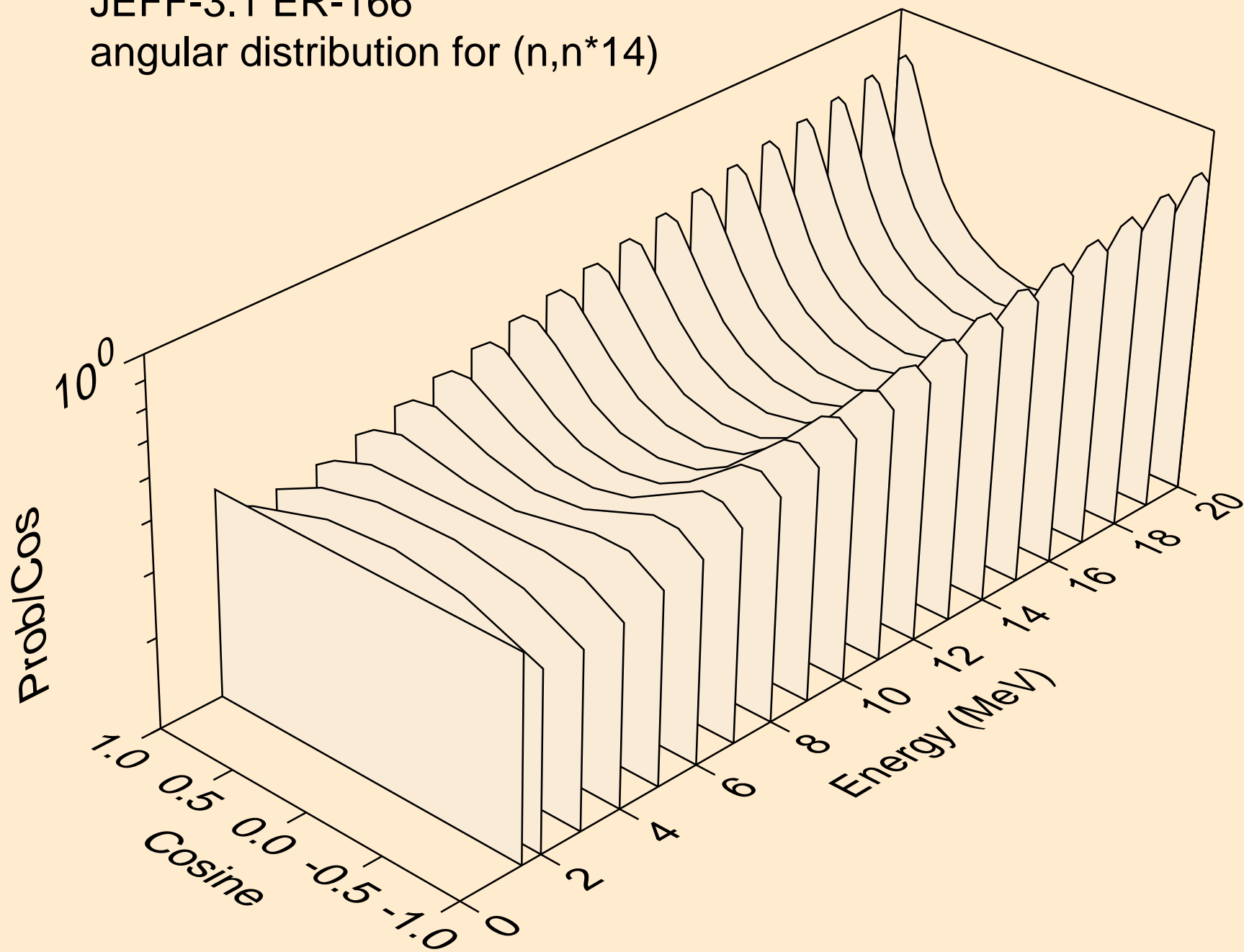

JEFF-3.1 ER-166
angular distribution for (n,n*15)

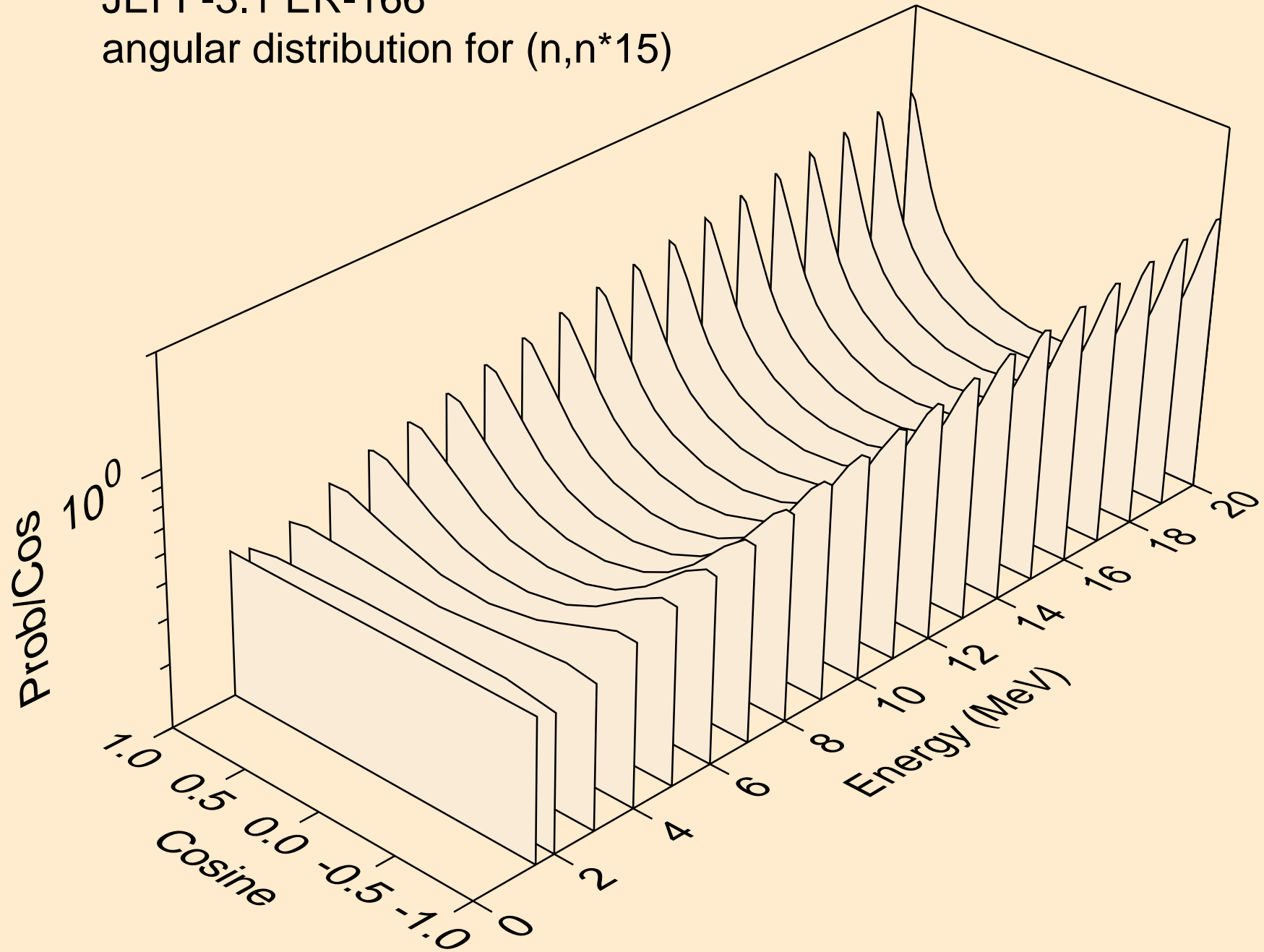

JEFF-3.1 ER-166
angular distribution for (n,n*16)

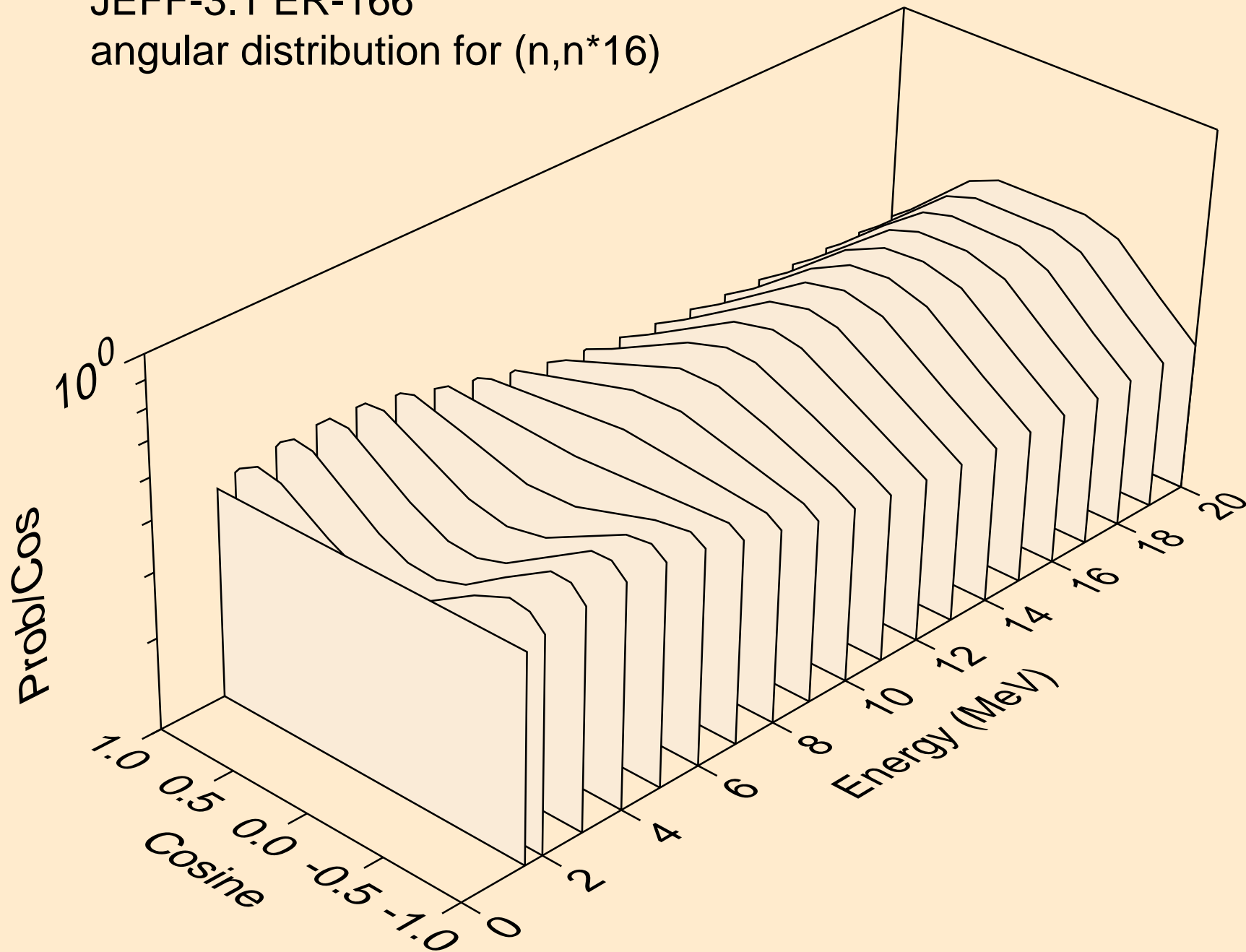

JEFF-3.1 ER-166
angular distribution for (n,n*17)

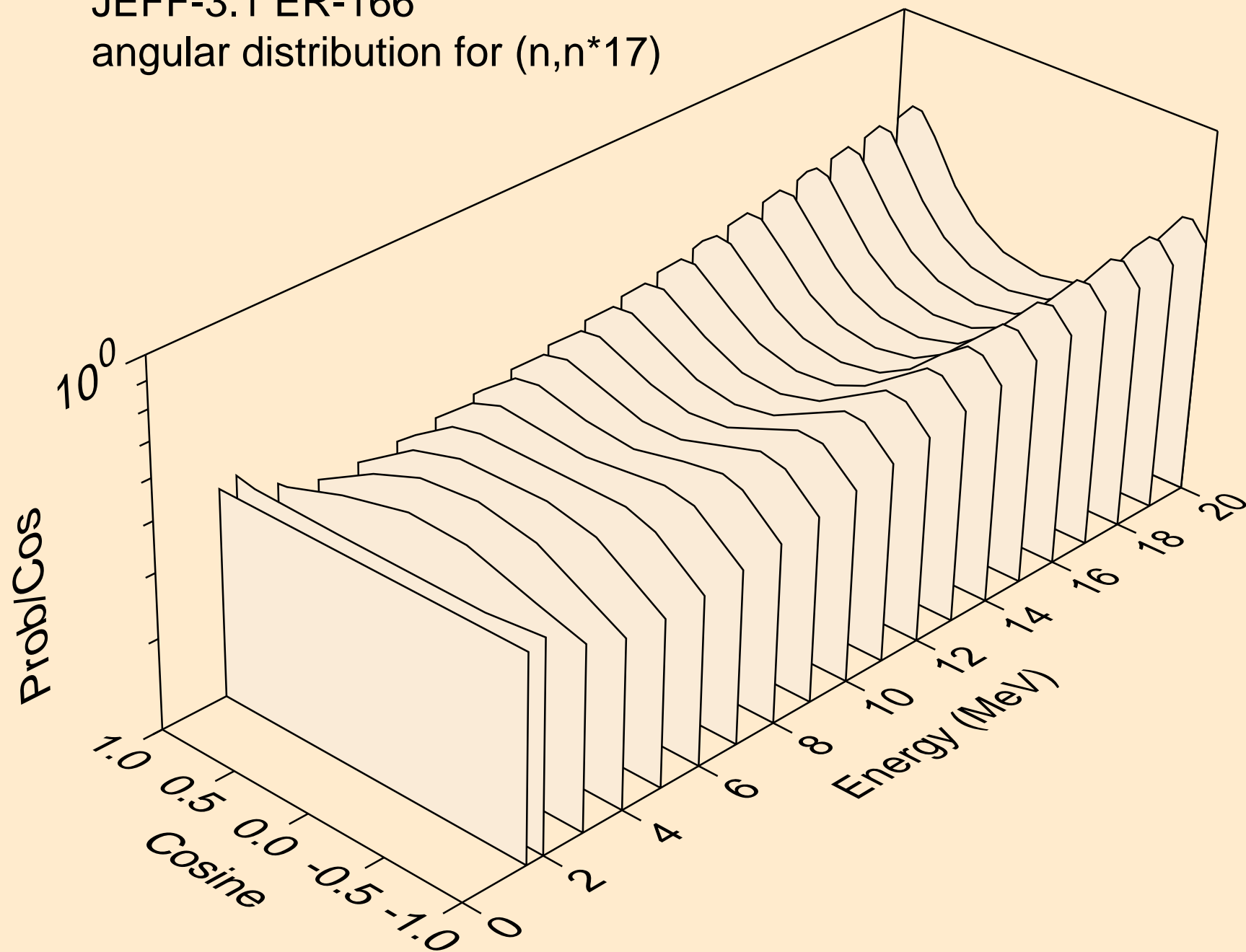

JEFF-3.1 ER-166
angular distribution for (n,n*18)

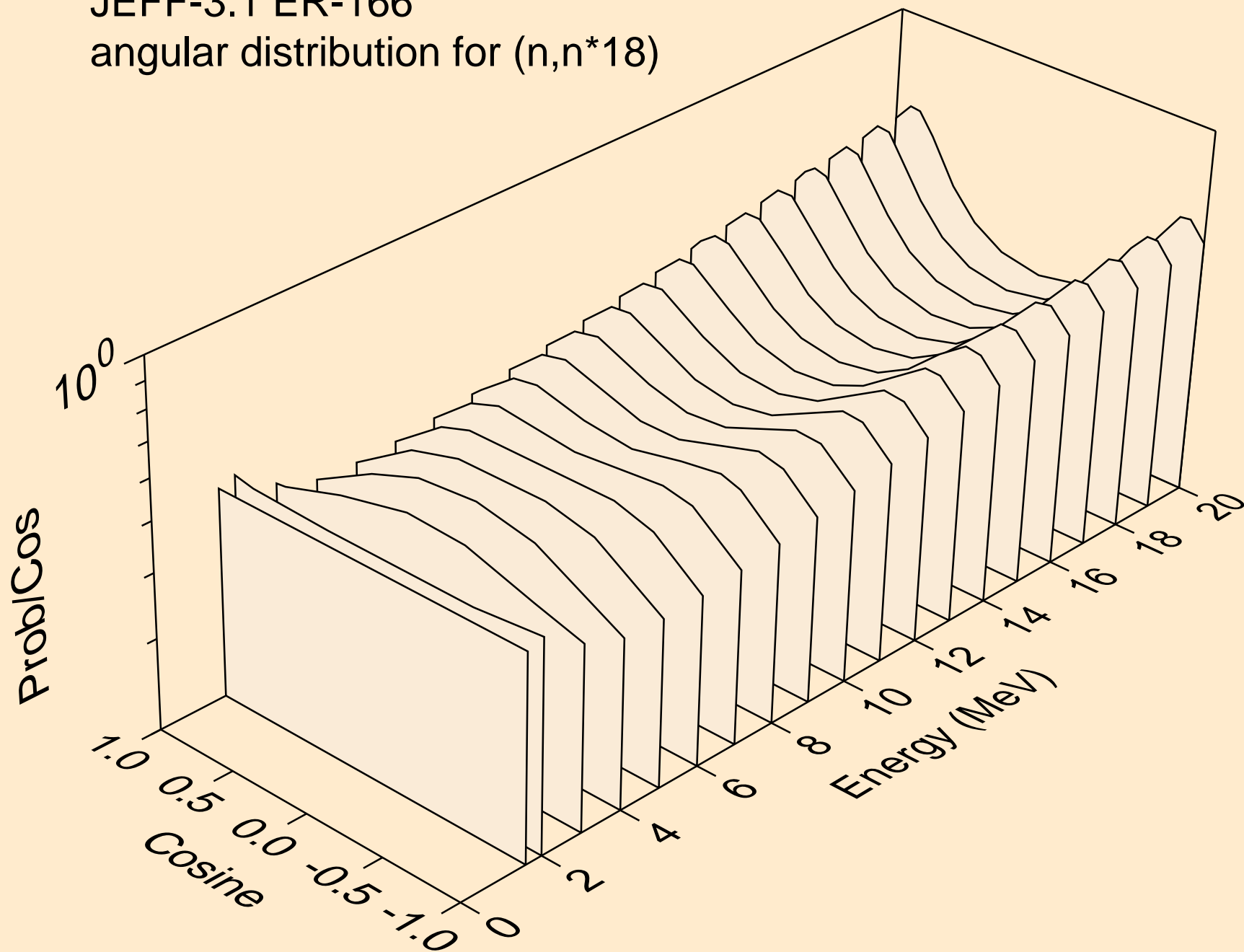

JEFF-3.1 ER-166
angular distribution for (n,n*19)

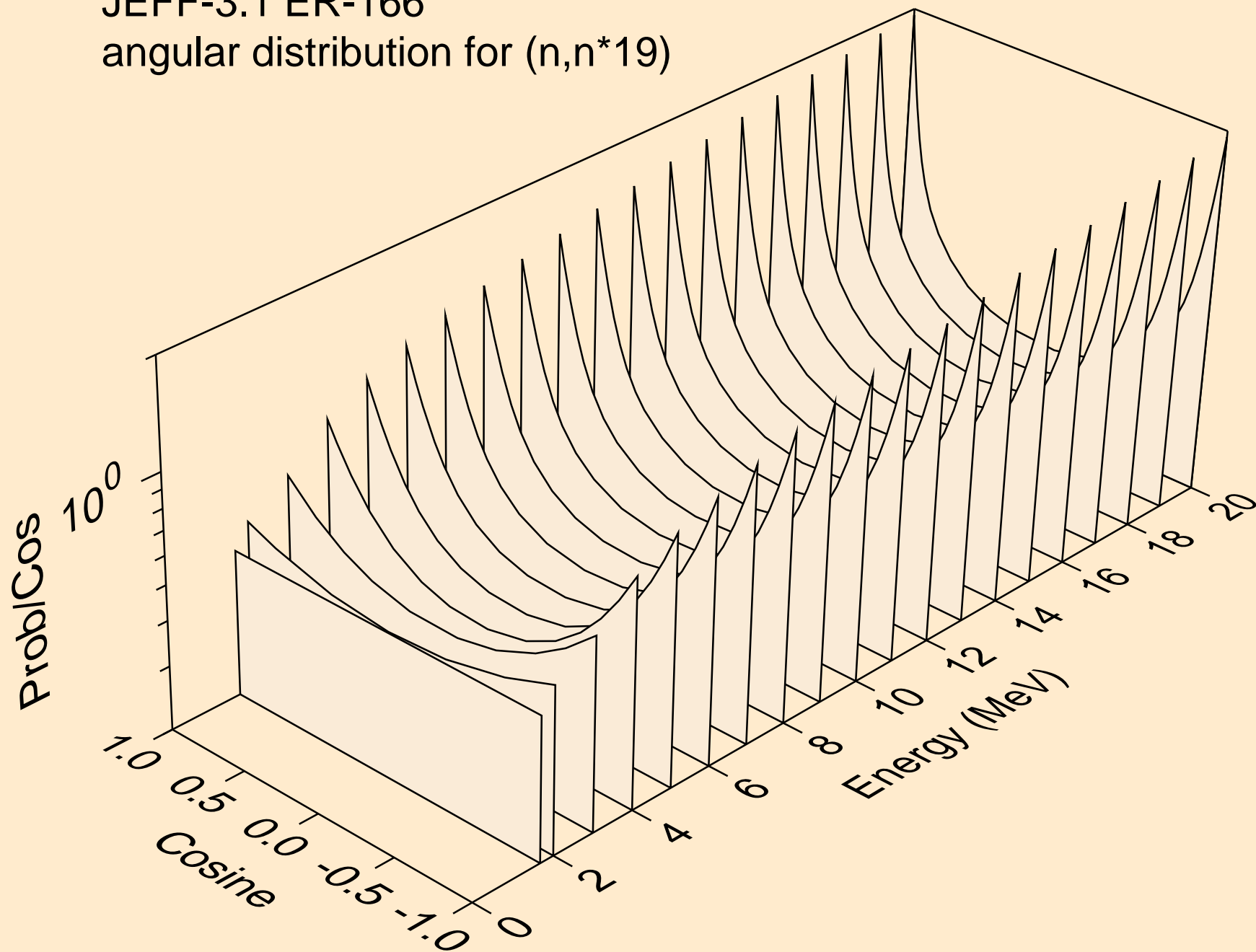

JEFF-3.1 ER-166
angular distribution for (n,n*20)

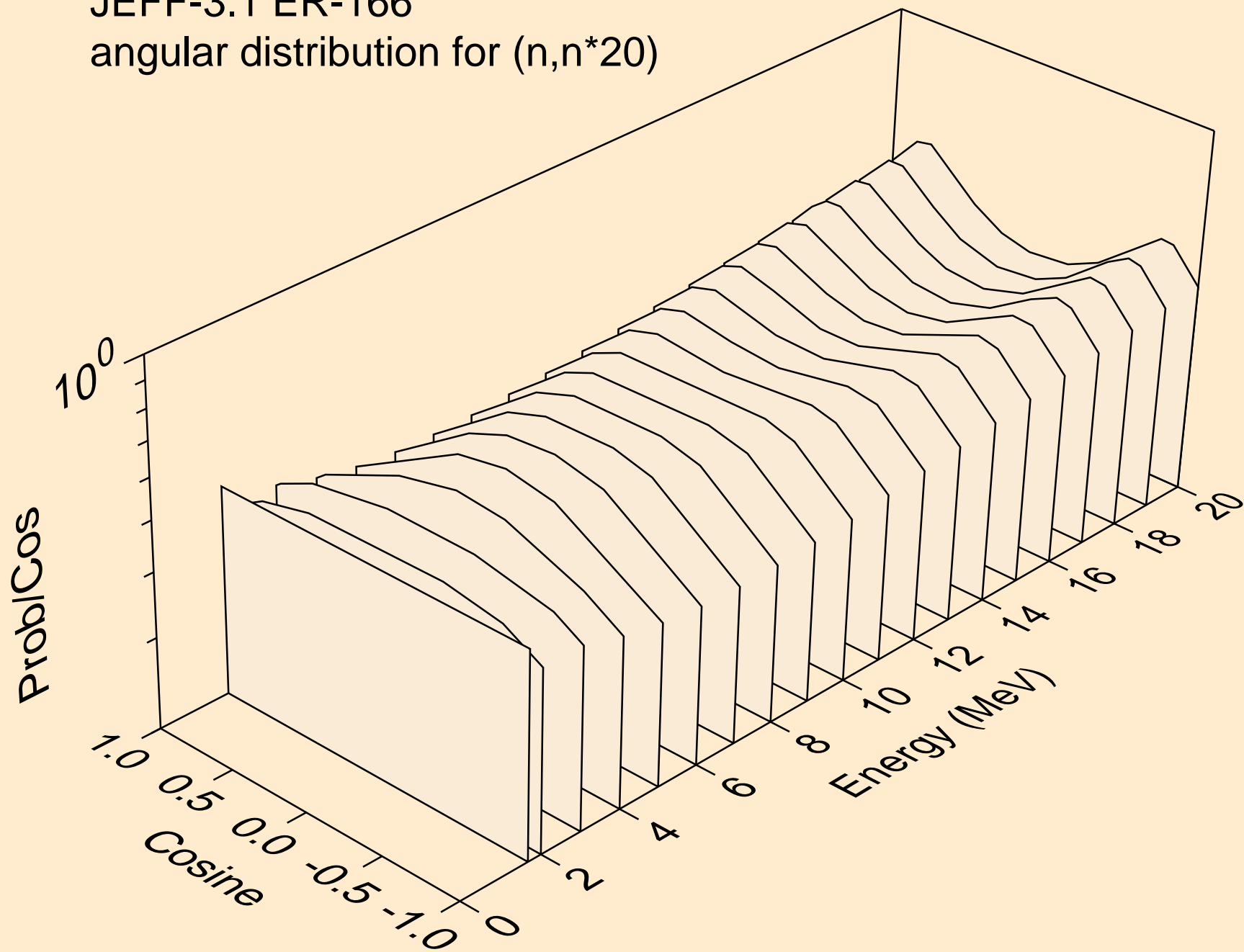

JEFF-3.1 ER-166
angular distribution for (n,n*21)

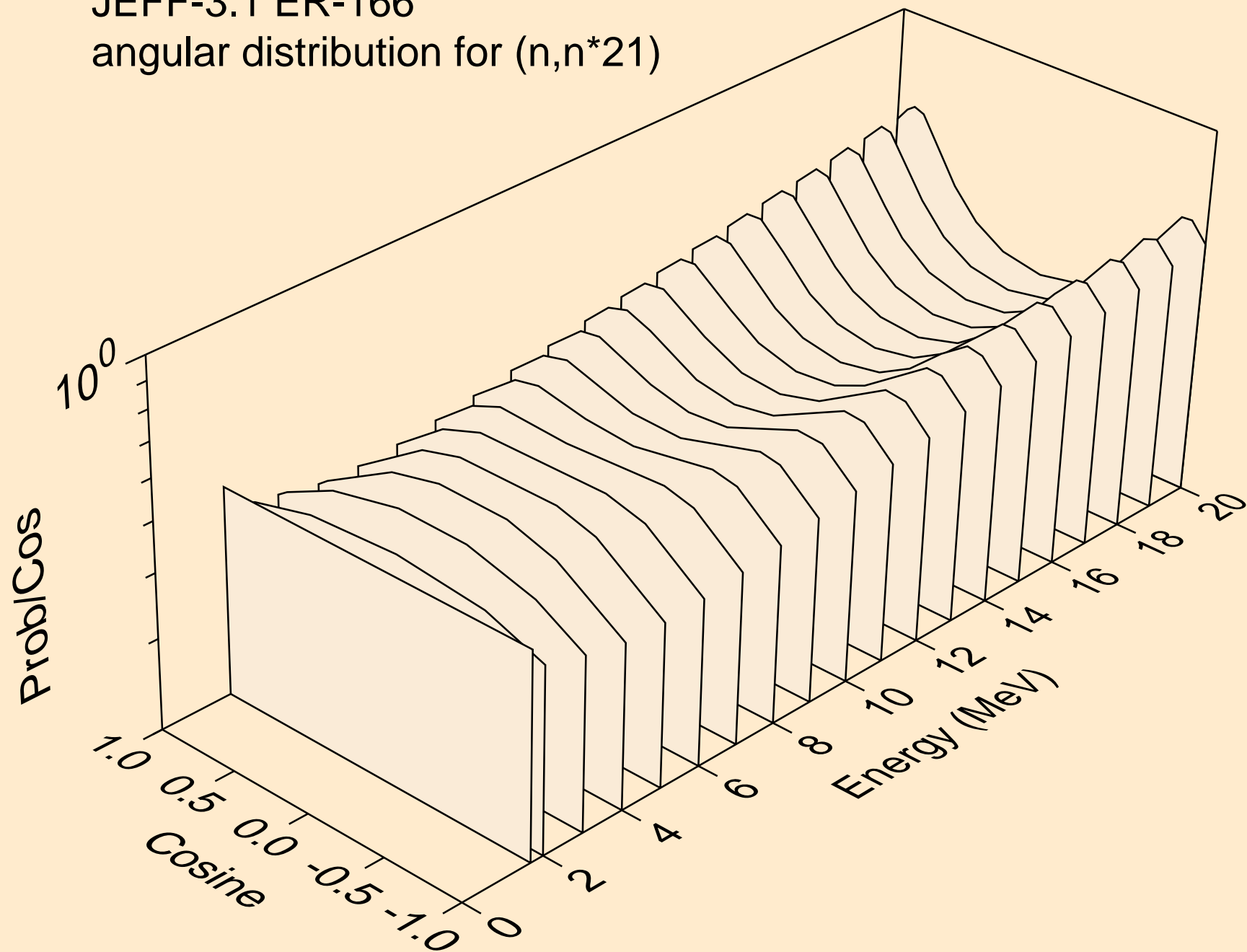

JEFF-3.1 ER-166
angular distribution for (n,n*22)

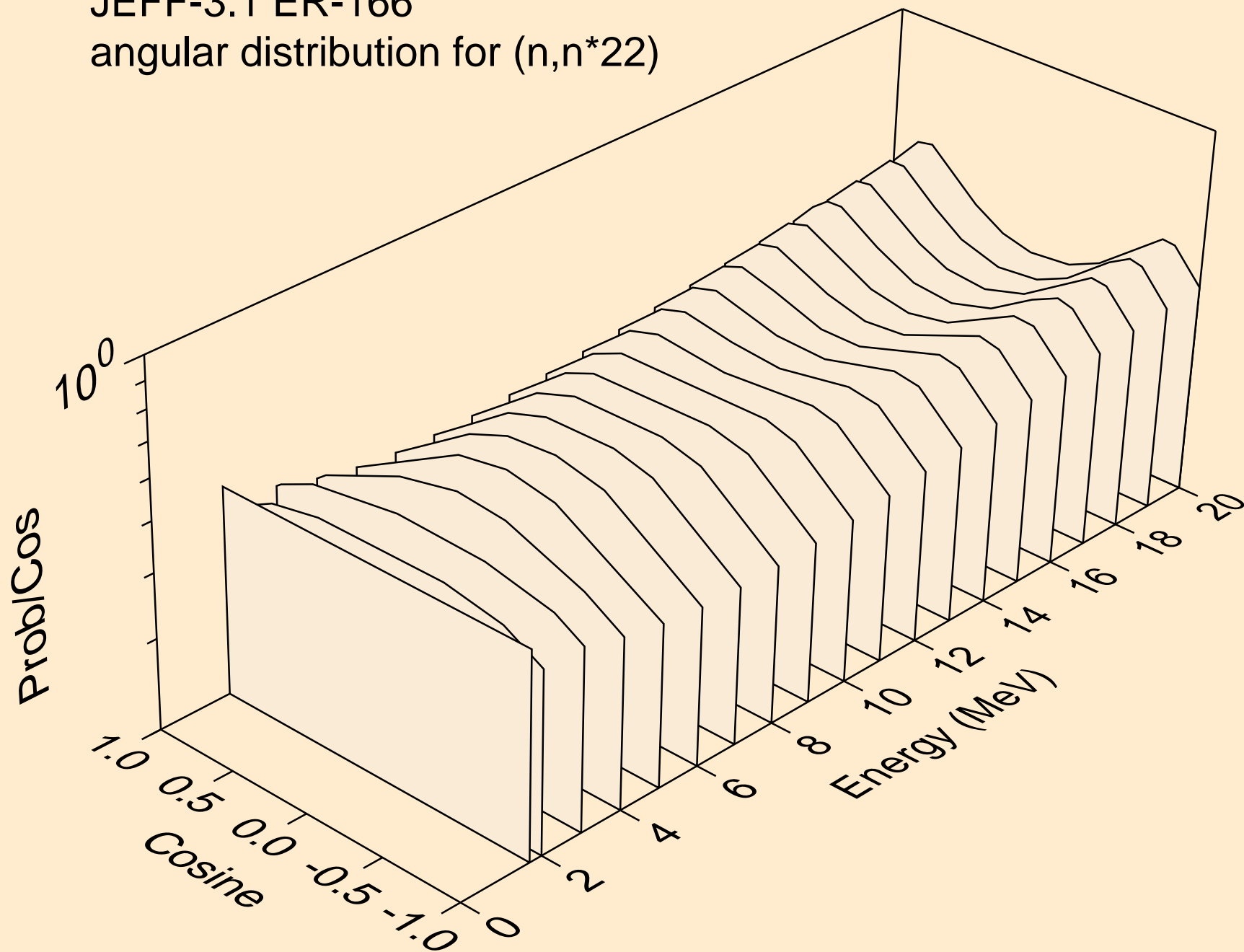

JEFF-3.1 ER-166
angular distribution for (n,n*23)

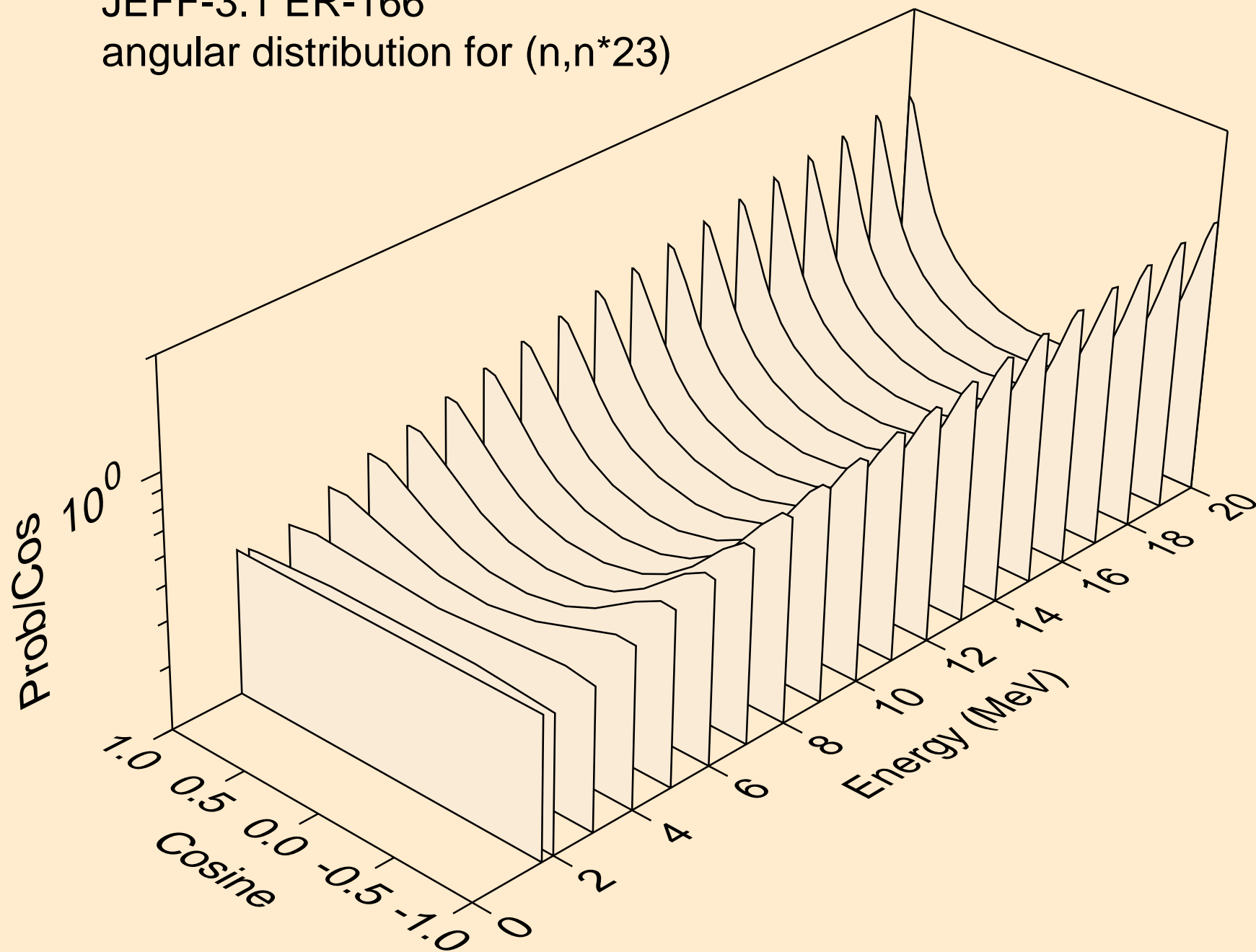

JEFF-3.1 ER-166
angular distribution for (n,n*24)

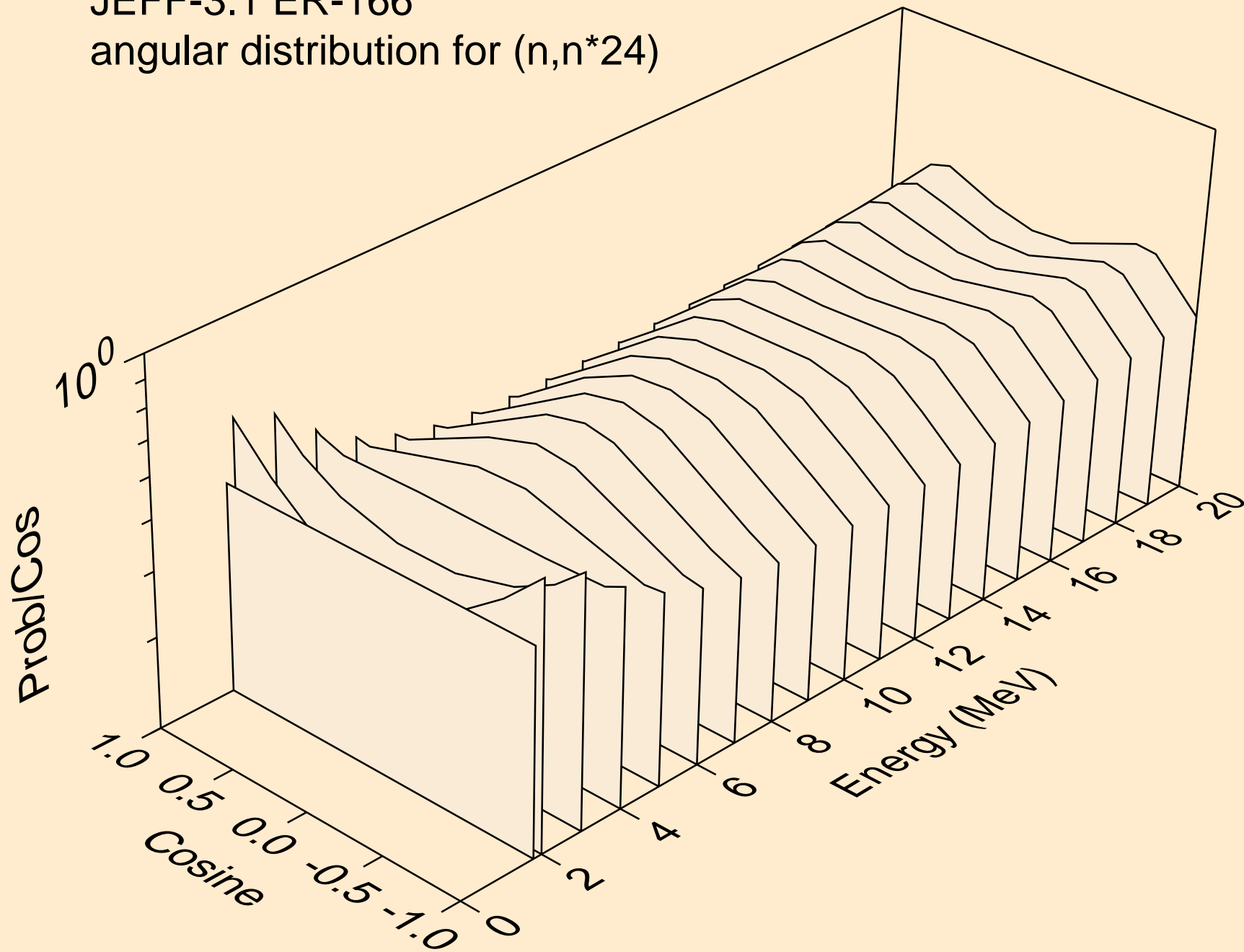

JEFF-3.1 ER-166
angular distribution for (n,n*c)

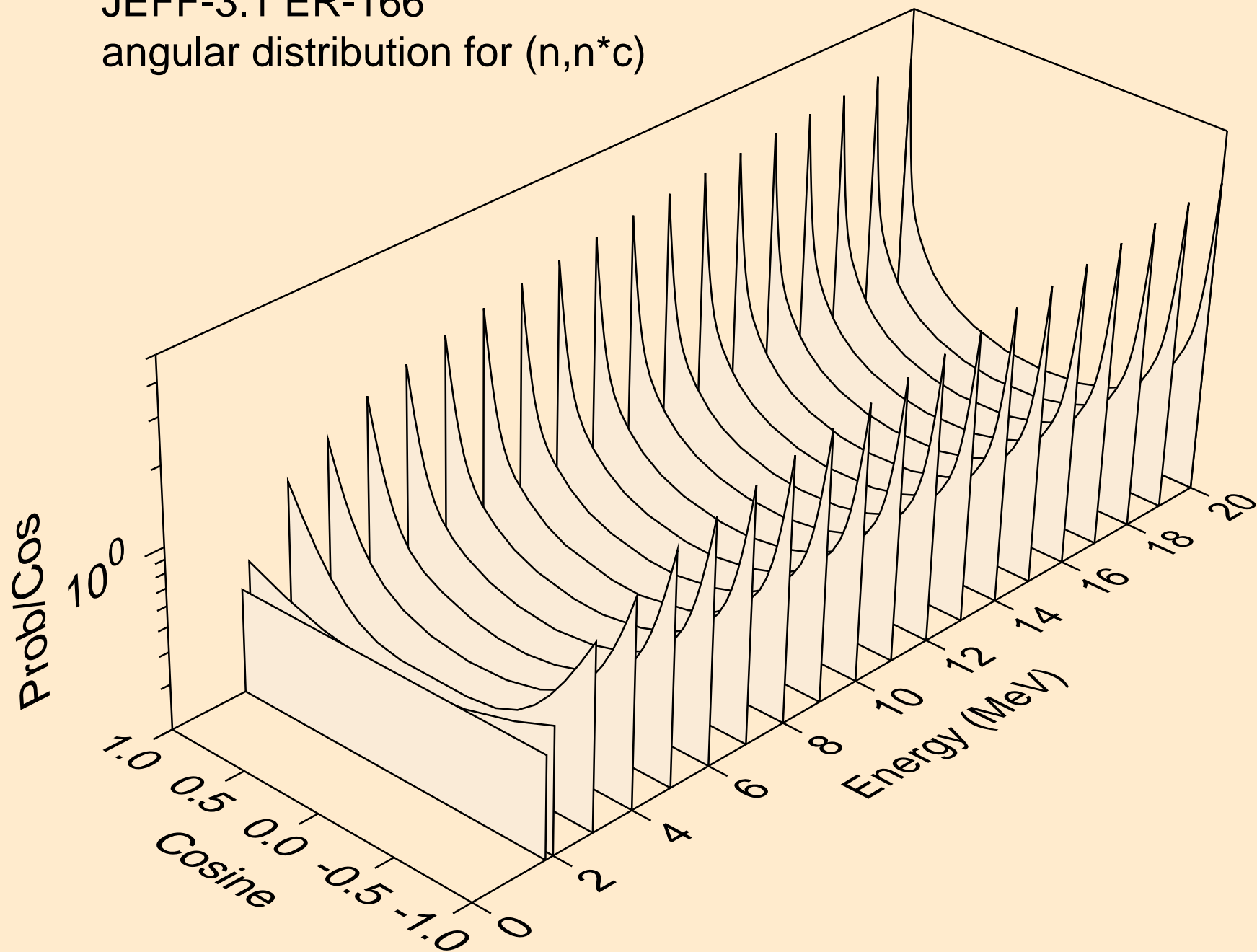

JEFF-3.1 ER-166
Neutron emission for (n,2n)

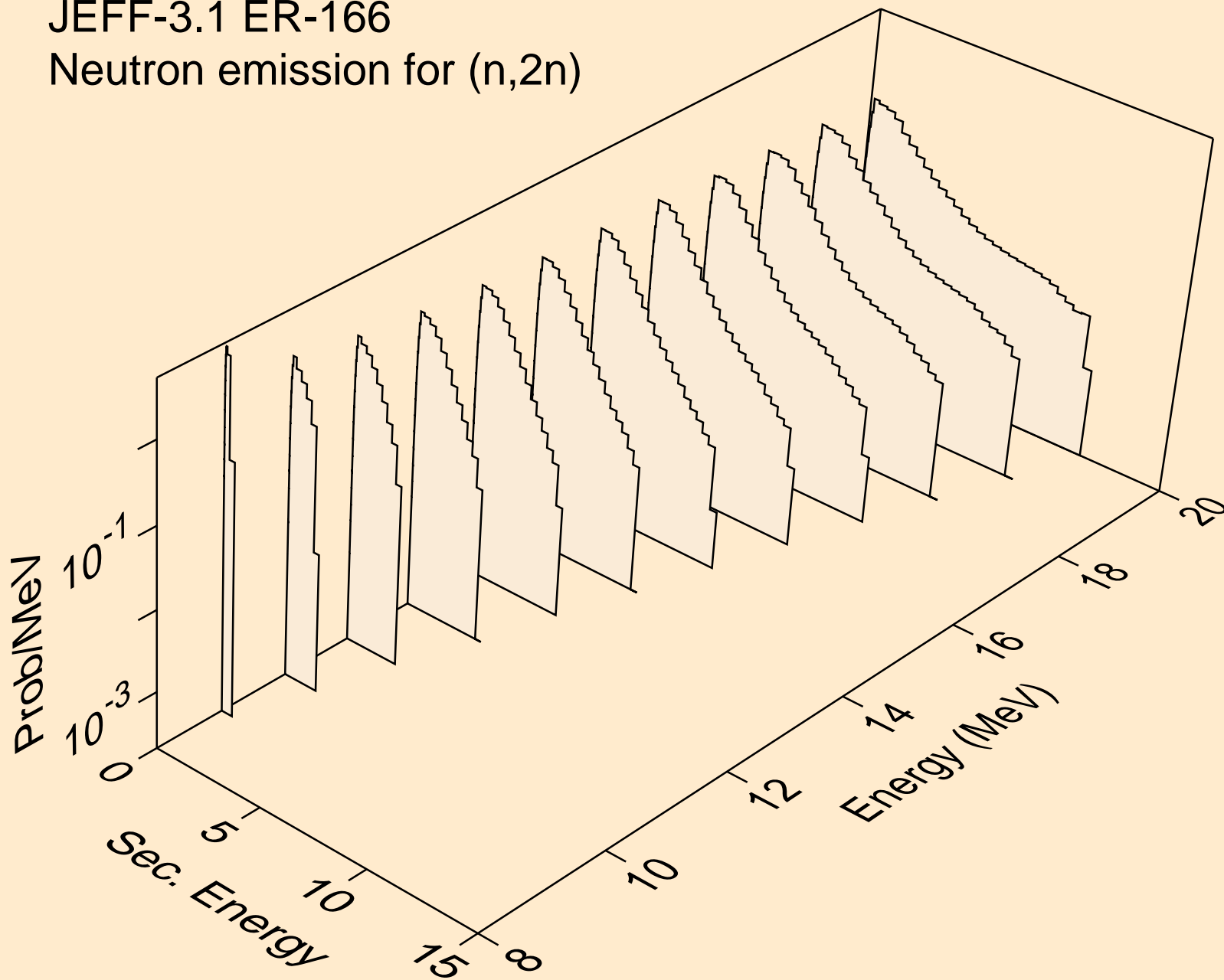

JEFF-3.1 ER-166
Neutron emission for (n,3n)

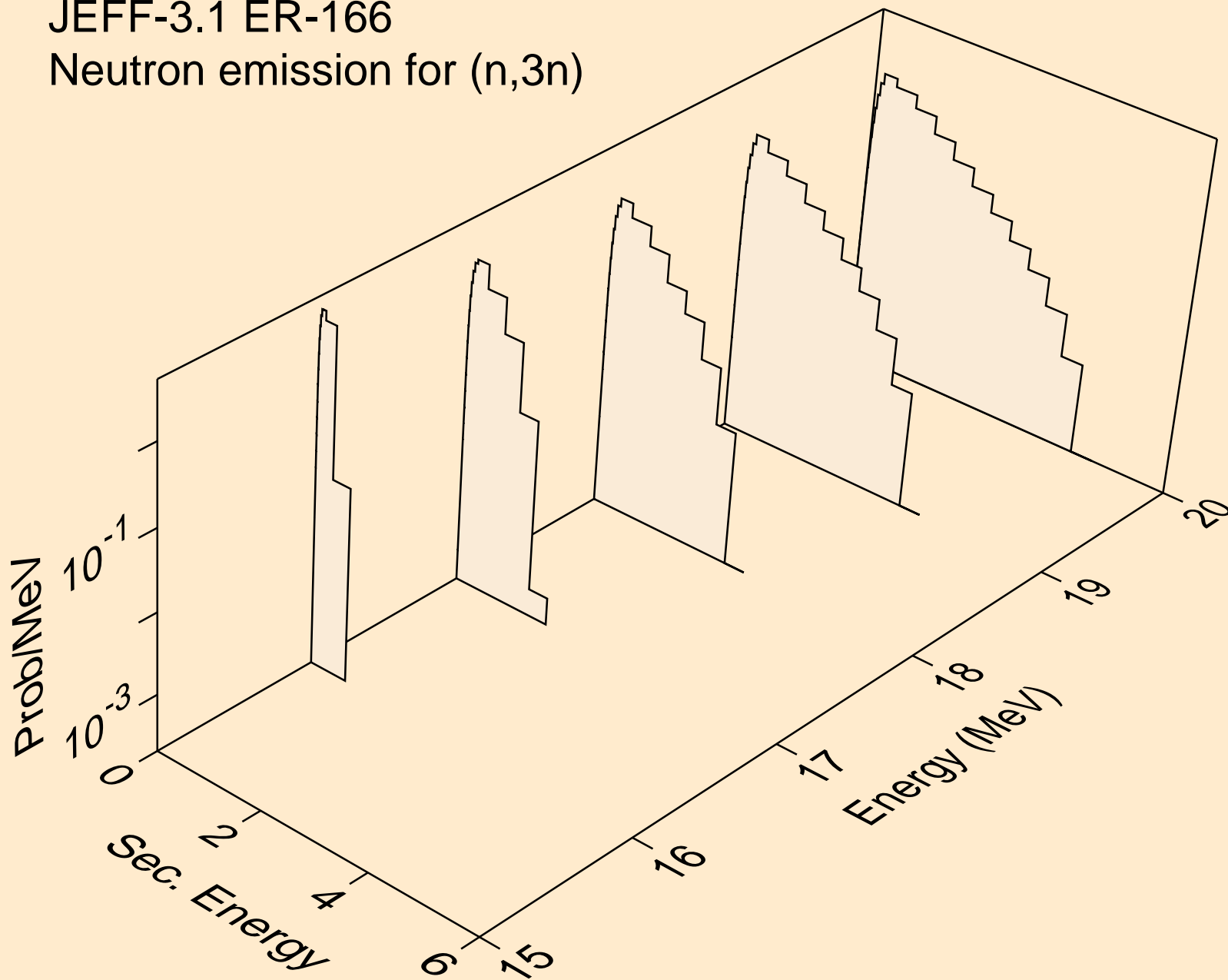

JEFF-3.1 ER-166
Neutron emission for (n,n*)a

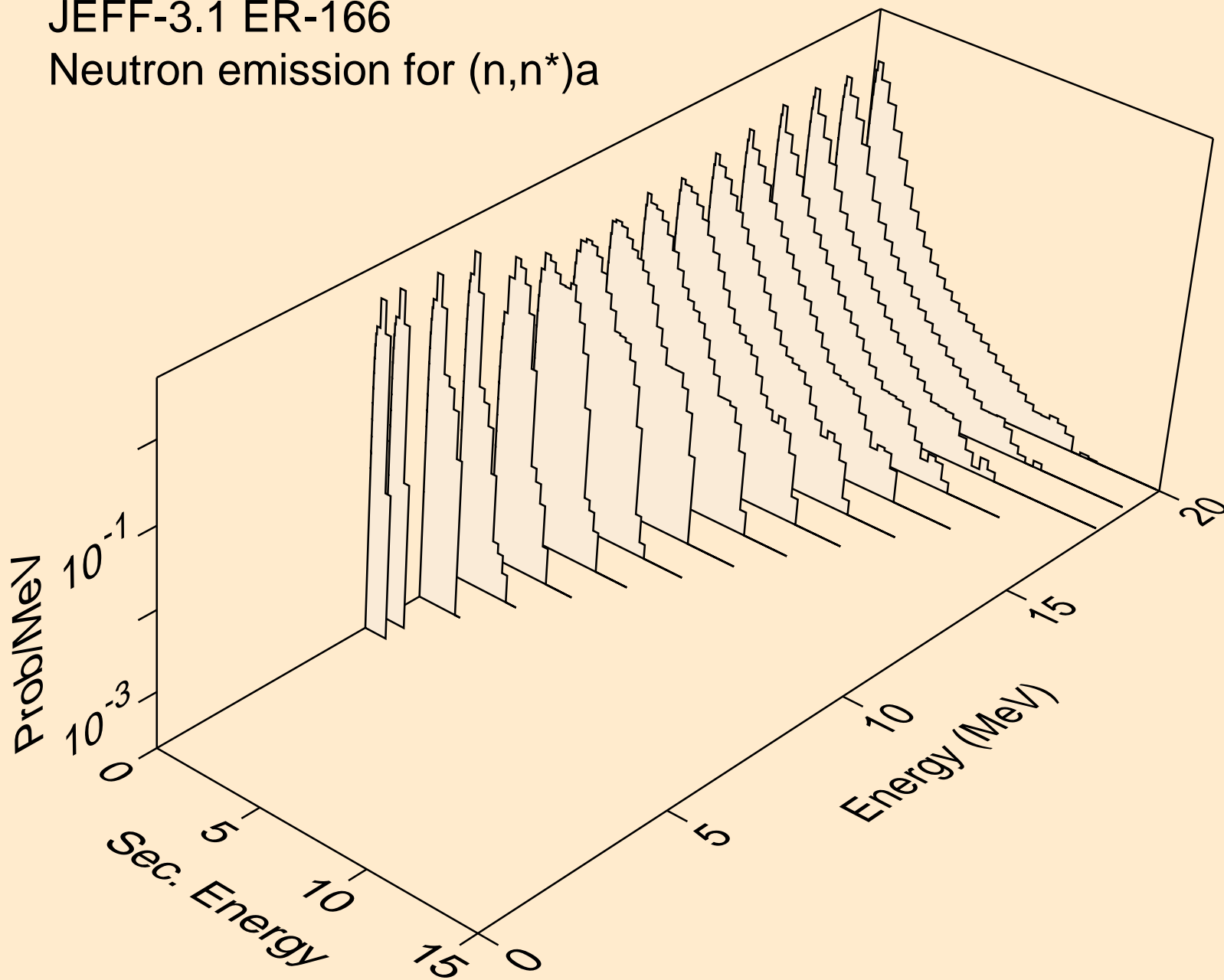

JEFF-3.1 ER-166

Neutron emission for (n,n*)p

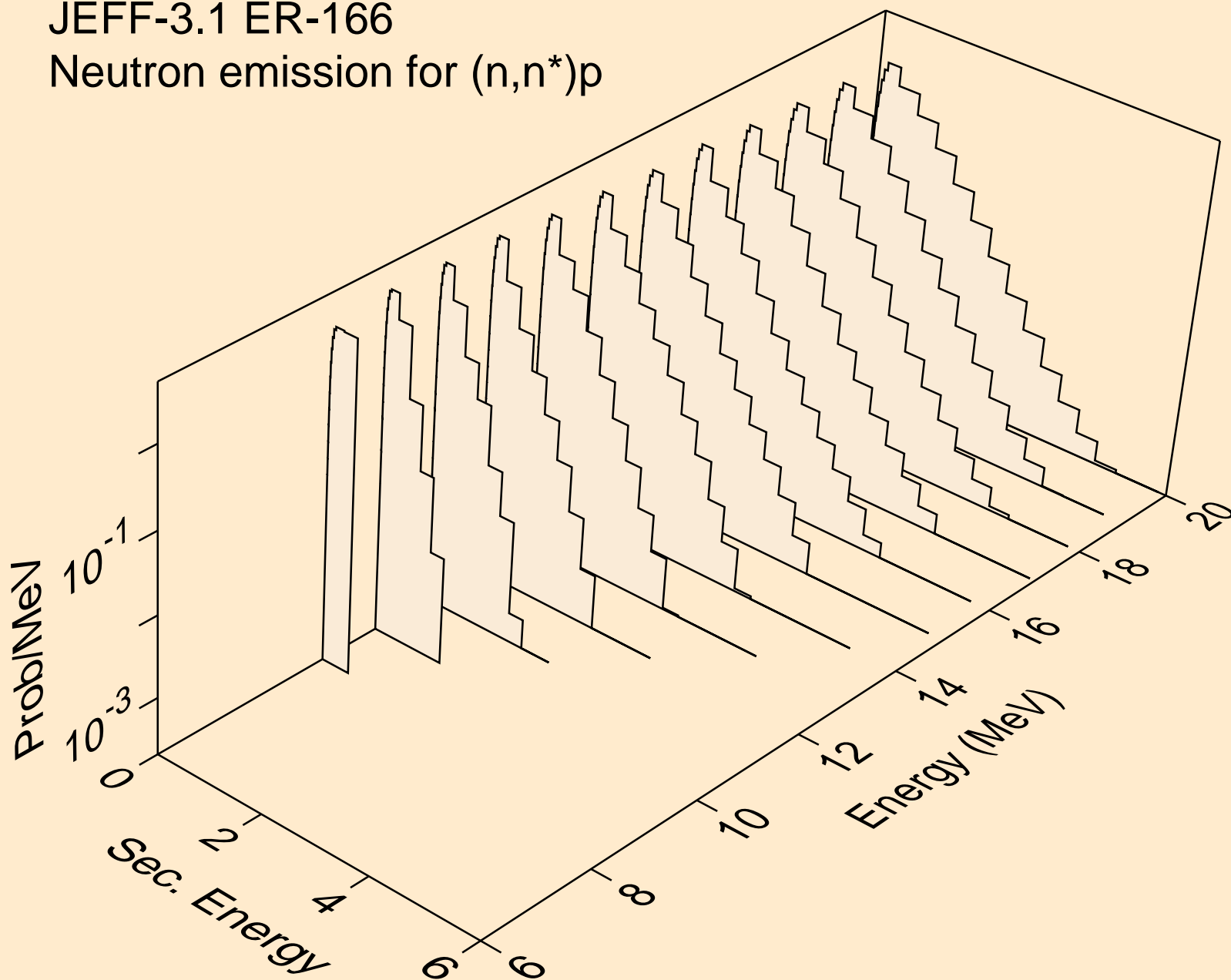

JEFF-3.1 ER-166
Neutron emission for (n,n*)d

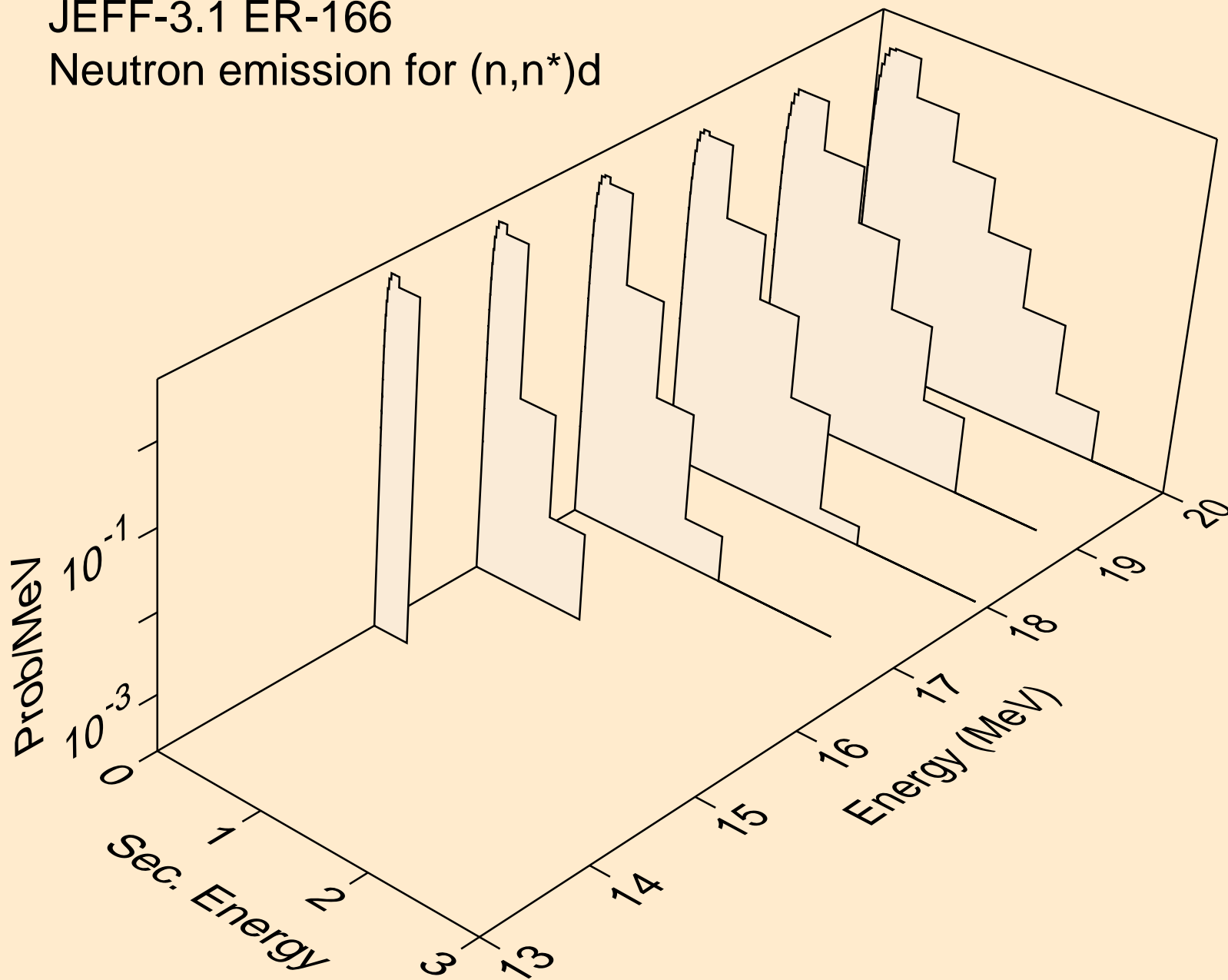

JEFF-3.1 ER-166
Neutron emission for (n,n*c)

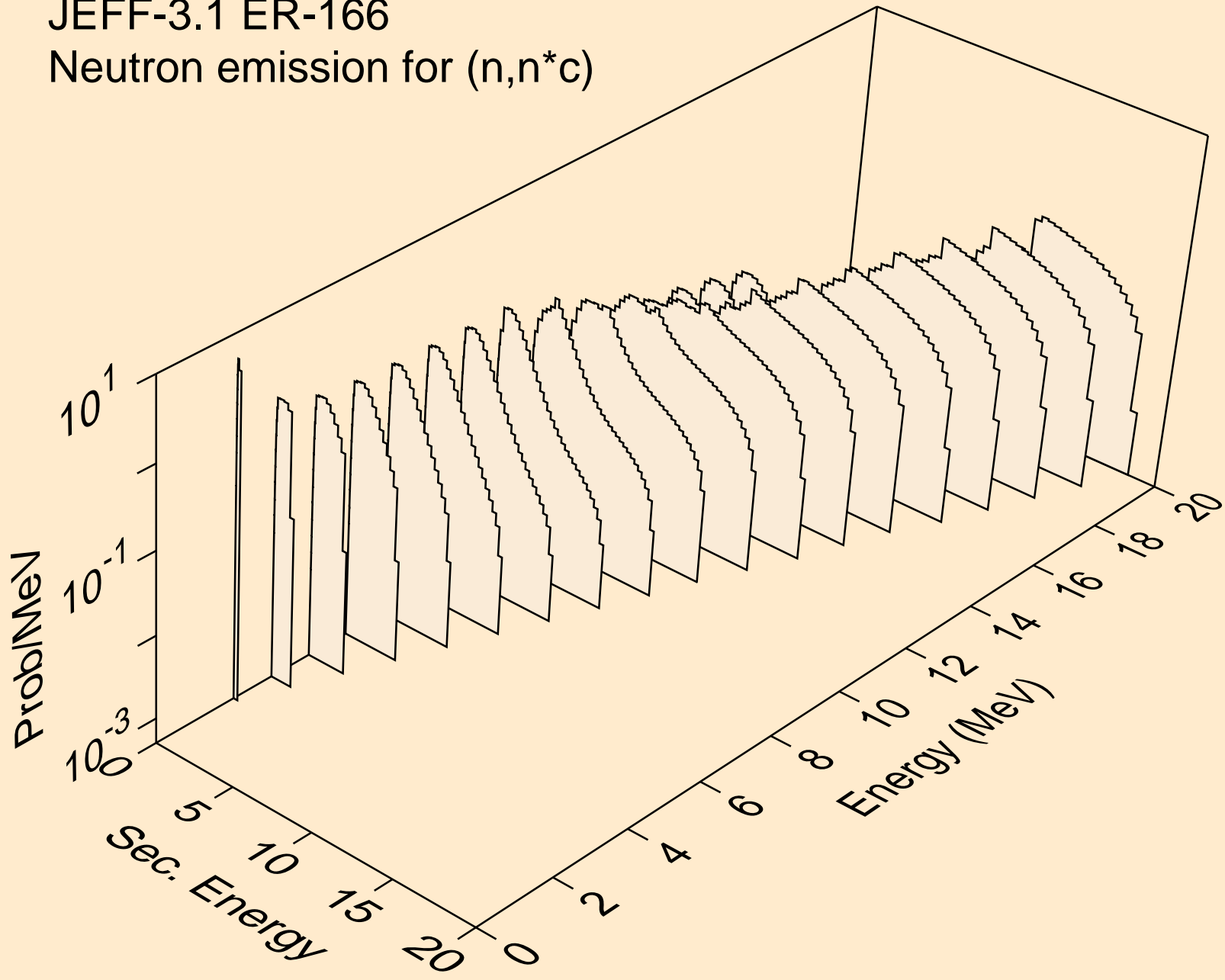

JEFF-3.1 ER-166

Photon emission for (n,2n)

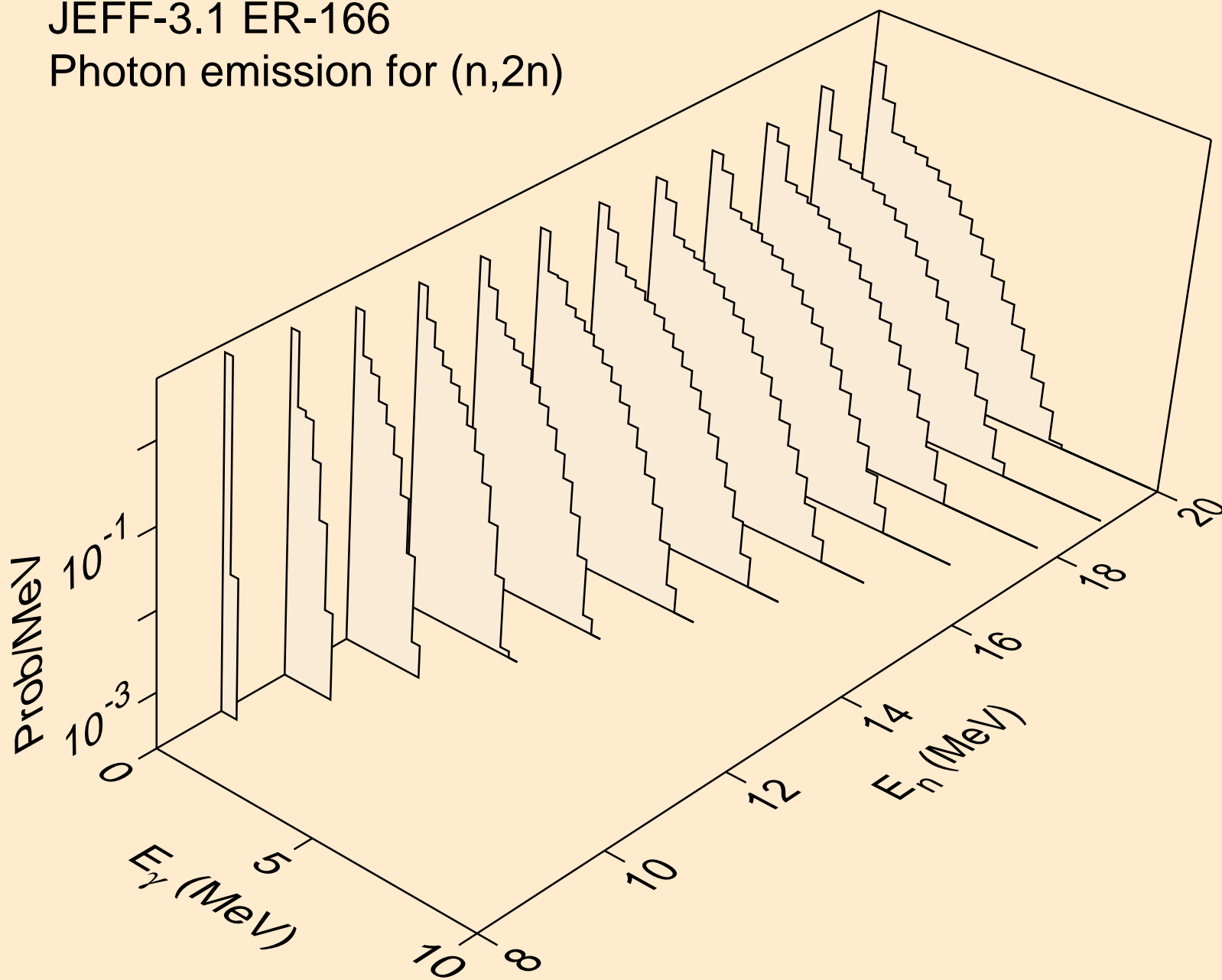

JEFF-3.1 ER-166

Photon emission for (n,3n)

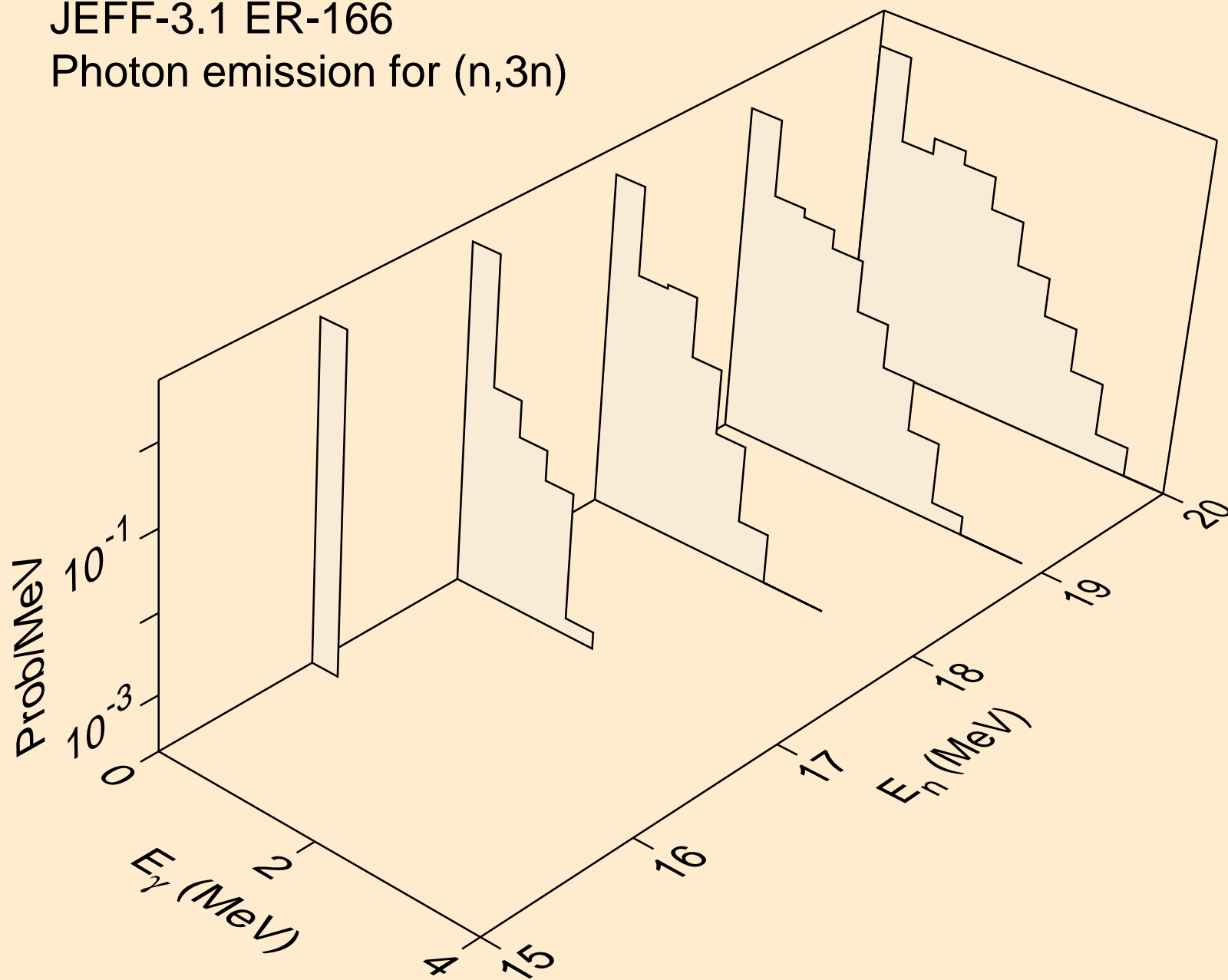

JEFF-3.1 ER-166

Photon emission for (n,n*)a

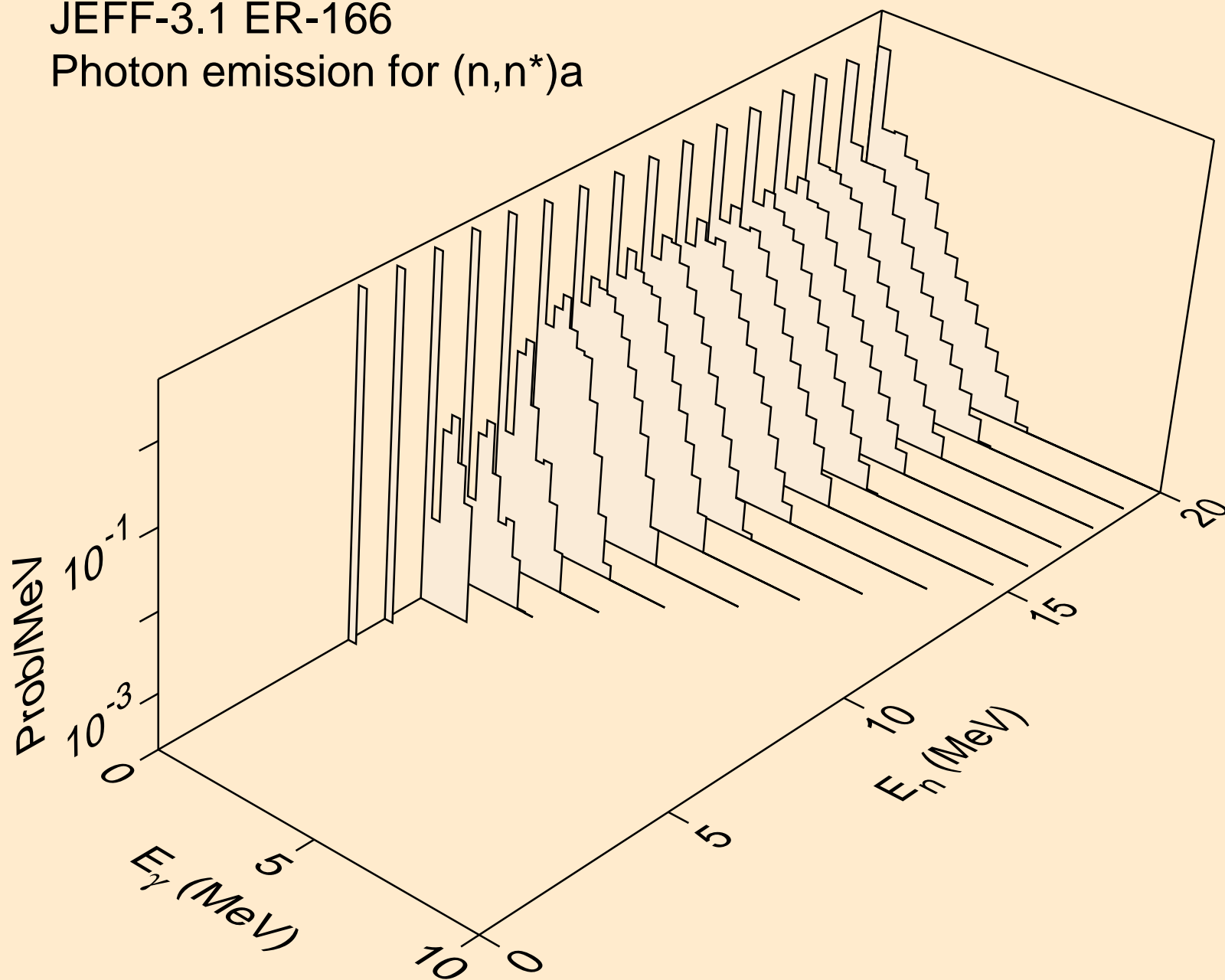

JEFF-3.1 ER-166

Photon emission for (n,n*)p

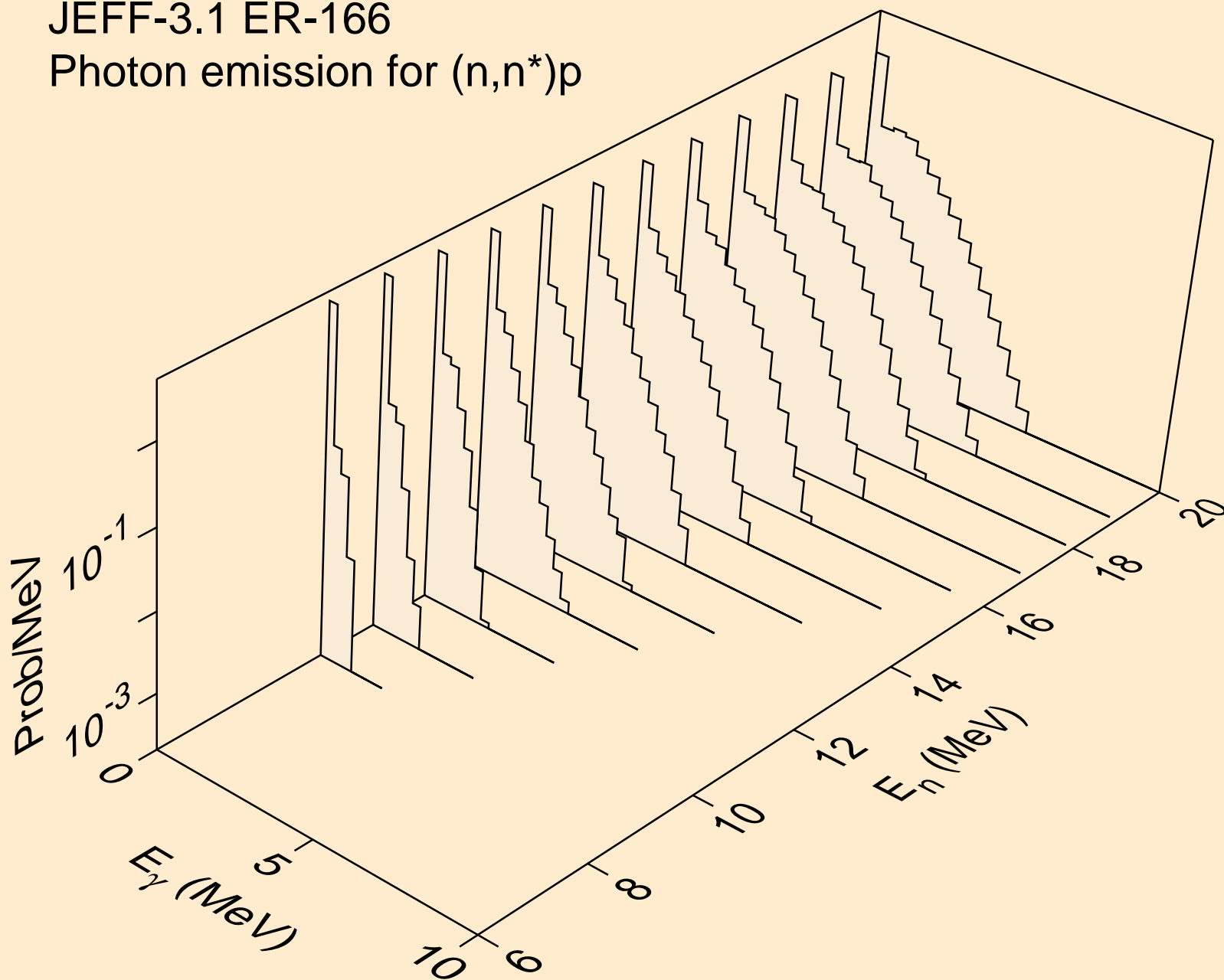

JEFF-3.1 ER-166
Photon emission for (n,n*c)

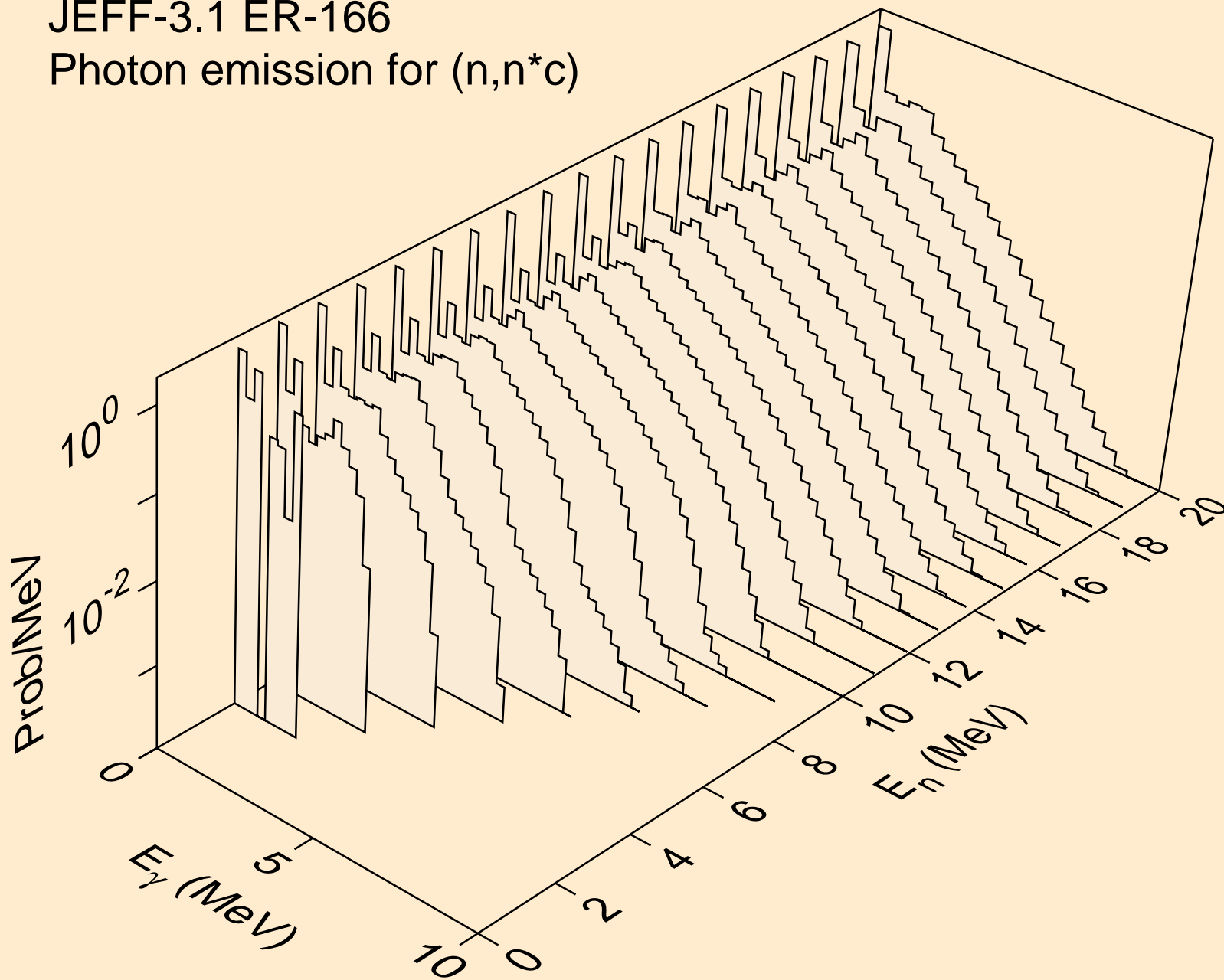

JEFF-3.1 ER-166
Photon emission for (n,gma)

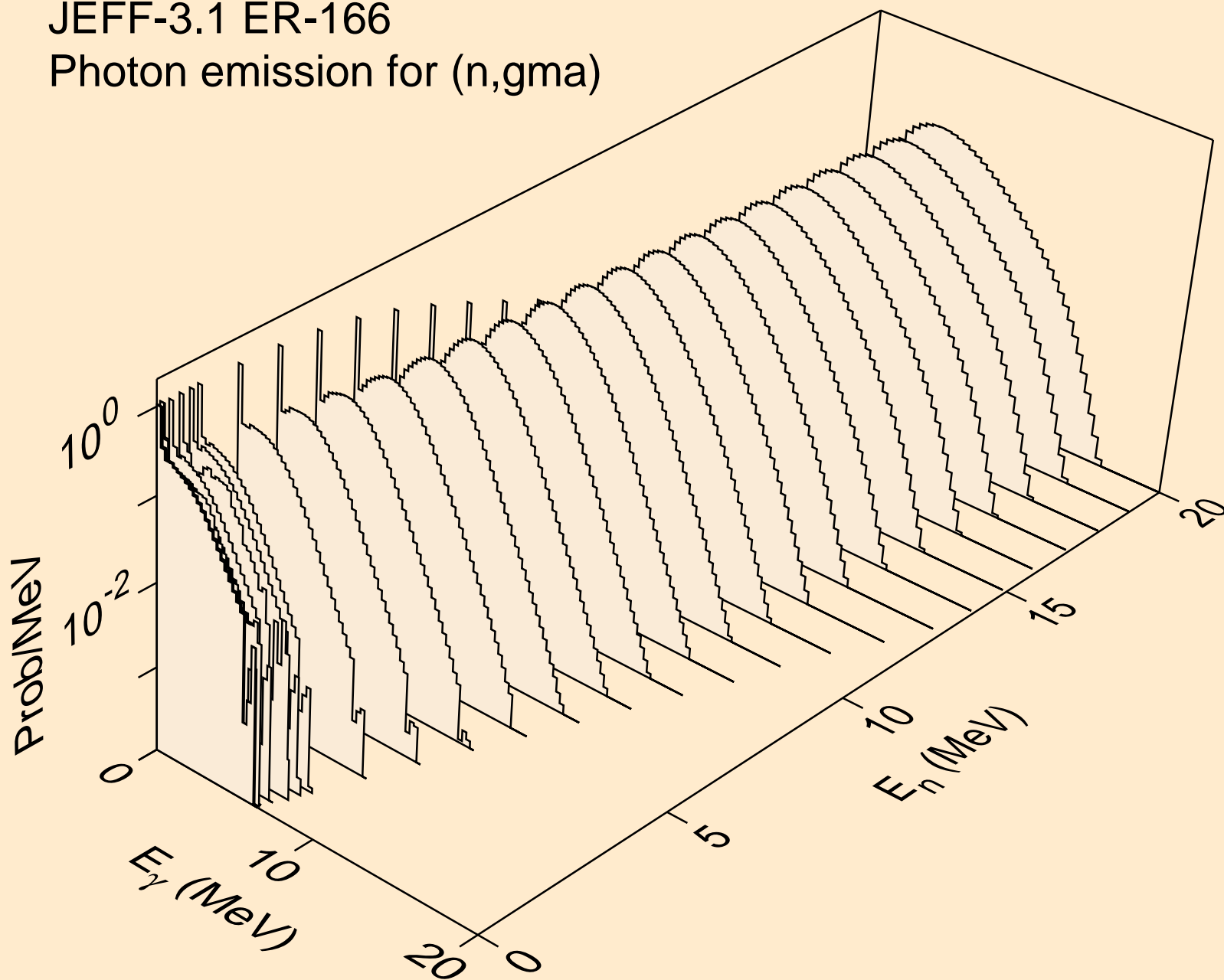

JEFF-3.1 ER-166
Photon emission for (n,p)

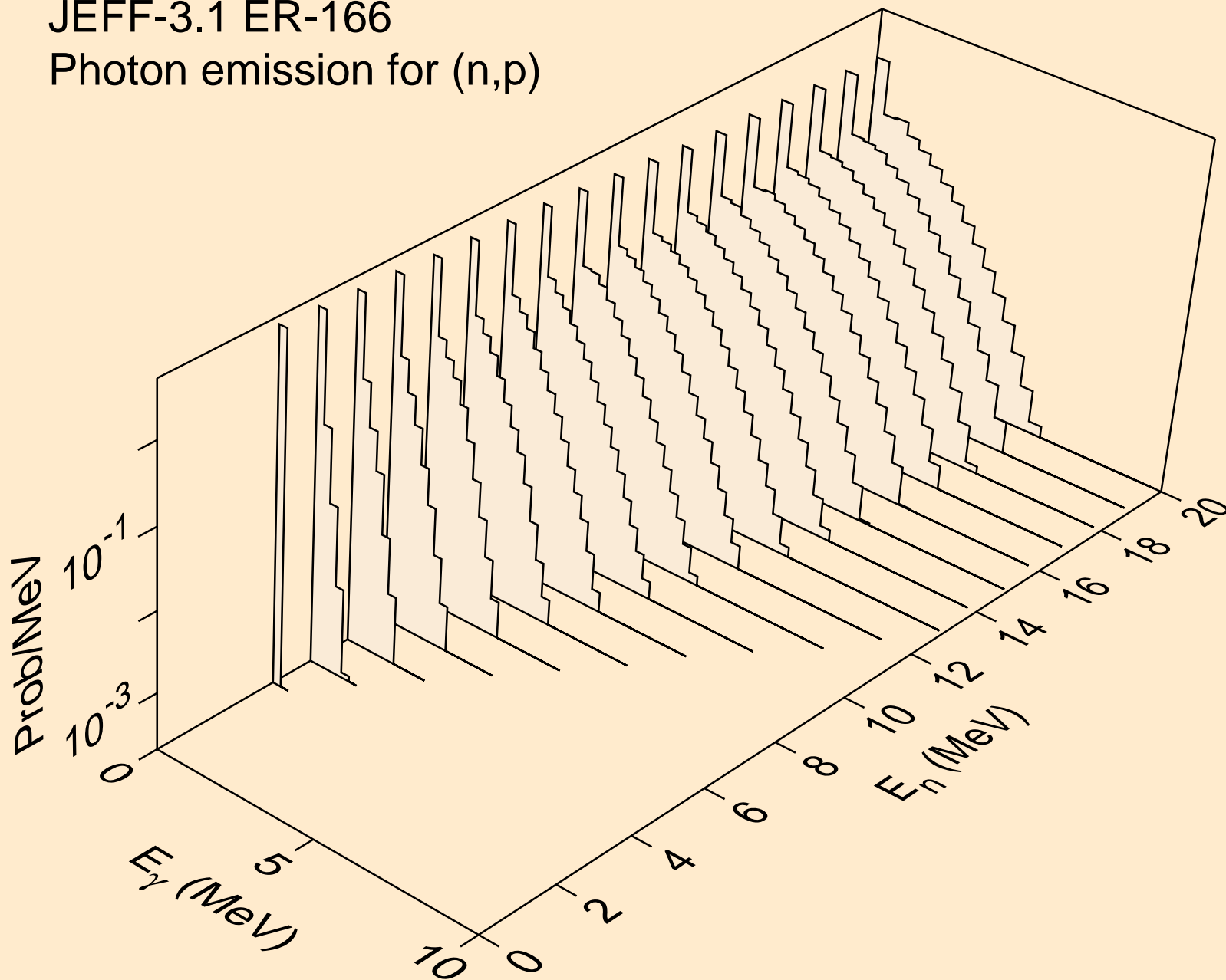

JEFF-3.1 ER-166

Photon emission for (n,d)

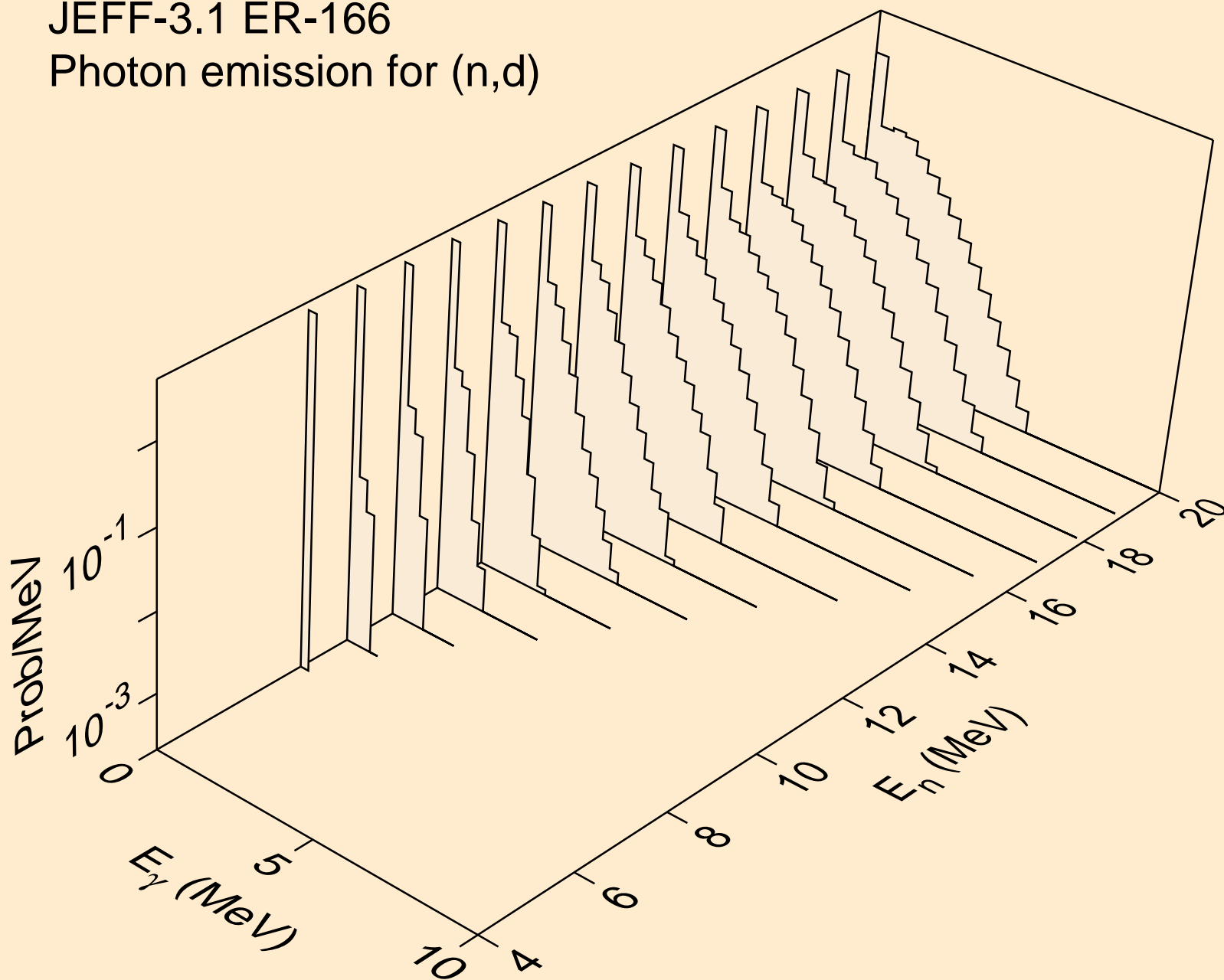

JEFF-3.1 ER-166

Photon emission for (n,a)

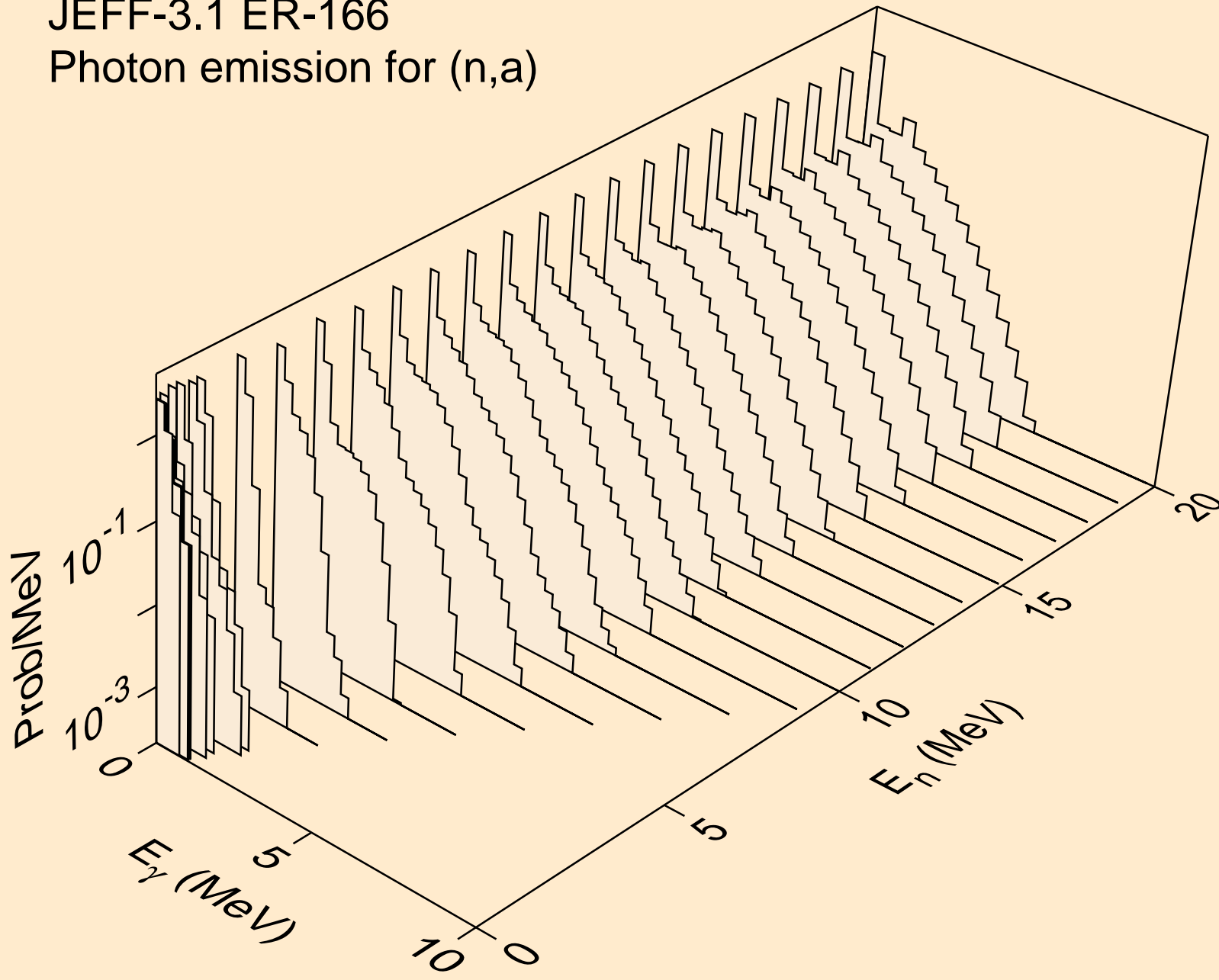

JEFF-3.1 ER-166
thermal capture photon spectrum

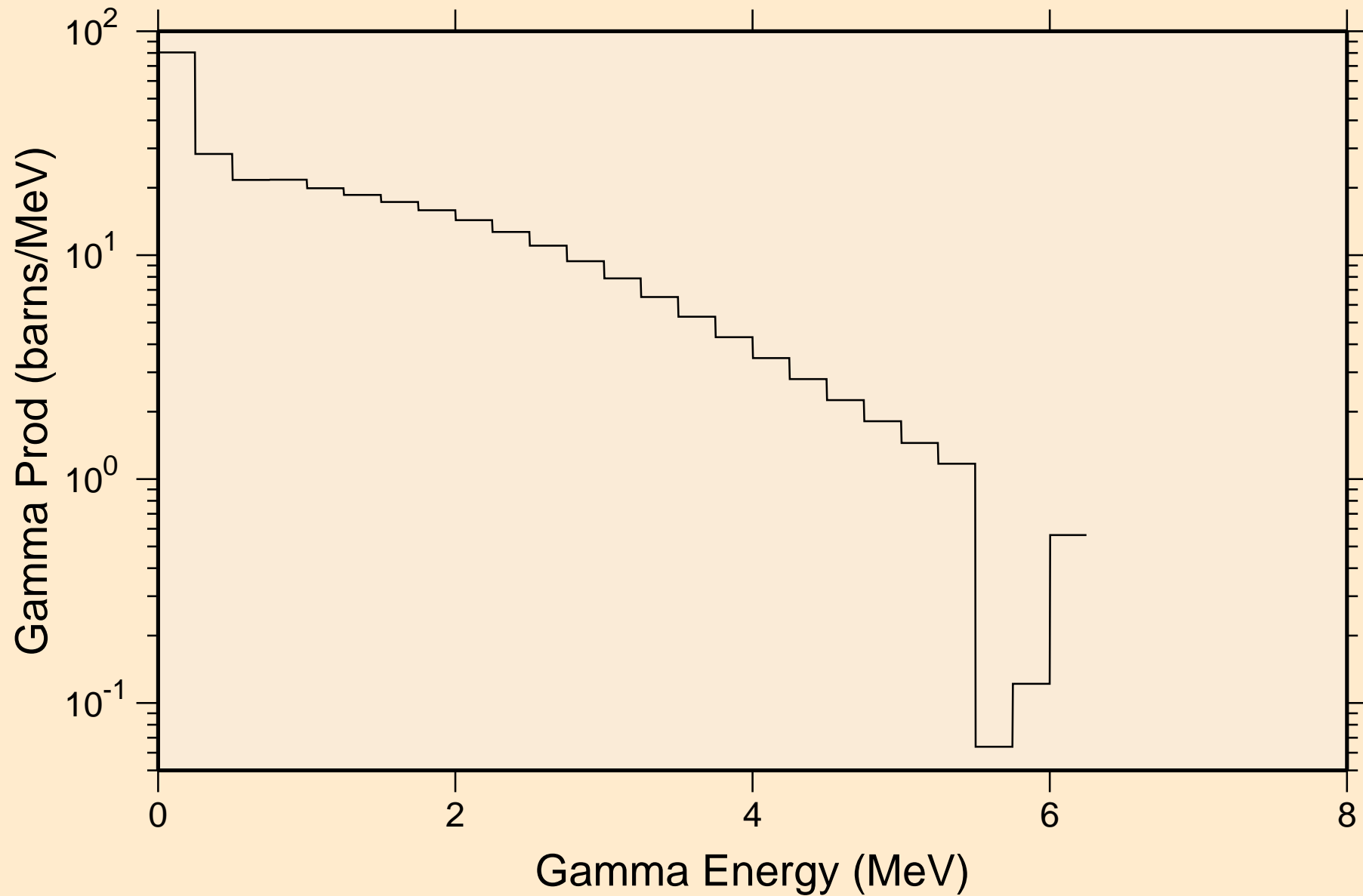

JEFF-3.1 ER-166
14 MeV photon spectrum

